



中国认可
国际互认
检测
TESTING
CNAS L6791

TEST REPORT

Applicant: Ugreen Group Limited
Address: UGREEN Building, Longcheng Industrial Park
Longguanxi Road, Longhua, ShenZhen, China
Equipment Type: Bluetooth Adapter
Model Name: CM749 (refer to section 2.3)
Brand Name: **UGREEN**
FCC ID: 2AQI5-CM749
Test Standard: 47 CFR Part 15 Subpart C
(refer to section 3.1)
Sample Arrival Date: Sep. 15, 2023
Test Date: Sep. 19, 2023 - Oct. 16, 2023
Date of Issue: Oct. 26, 2023

ISSUED BY:

Shenzhen BALUN Technology Co., Ltd.

Tested by: Julie Zhu

Checked by: Ye Hongji

Approved by: Hanson Lin

(Vice General Manager)

Julie Zhu

Ye Hongji

Hanson Lin

Revision History		
Version	Issue Date	Revisions
<u>Rev. 01</u>	<u>Oct. 26, 2023</u>	<u>Initial Issue</u>

TABLE OF CONTENTS

1	GENERAL INFORMATION	4
1.1	Test Laboratory	4
1.2	Test Location	4
2	PRODUCT INFORMATION	5
2.1	Applicant Information	5
2.2	Manufacturer Information	5
2.3	General Description for Equipment under Test (EUT)	5
2.4	Technical Information	6
3	SUMMARY OF TEST RESULTS	8
3.1	Test Standards	8
3.2	Test Verdict	8
4	GENERAL TEST CONFIGURATIONS	9
4.1	Test Environments	9
4.2	Test Equipment List	9
4.3	Test Software List	9
4.4	Measurement Uncertainty	10
4.5	Description of Test Setup	10
4.6	Measurement Results Explanation Example	13
5	TEST ITEMS	14
5.1	Antenna Requirements	14
5.2	Frequency Hopping Systems	15
5.3	Number of Hopping Frequencies	17
5.4	Peak Output Power	19
5.5	Occupied Bandwidth	22

5.6	Carrier Frequency Separation	27
5.7	Time of Occupancy (Dwell time)	29
5.8	Conducted Spurious Emission & Authorized-band band-edge	33
5.9	Conducted Emission	41
5.10	Radiated Spurious Emission	44
5.11	Band Edge (Restricted-band band-edge).....	60
ANNEX A	TEST SETUP PHOTOS	65
1	Radiated Test Photo.....	65
2	Conducted Test Photo.....	68
3	Conducted Emissions.....	68
ANNEX B	EUT EXTERNAL PHOTOS	70
ANNEX C	EUT INTERNAL PHOTOS	74

1 GENERAL INFORMATION

1.1 Test Laboratory

Name	Shenzhen BALUN Technology Co., Ltd.
Address	Block B, 1/F, Baisha Science and Technology Park, Shahe Xi Road, Nanshan District, Shenzhen, Guangdong Province, P. R. China
Phone Number	+86 755 6685 0100

1.2 Test Location

Name	Shenzhen BALUN Technology Co., Ltd.
Location	<input checked="" type="checkbox"/> Block B, 1/F, Baisha Science and Technology Park, Shahe Xi Road, Nanshan District, Shenzhen, Guangdong Province, P. R. China
	<input type="checkbox"/> 1/F, Building B, Ganghongji High-tech Intelligent Industrial Park, No. 1008, Songbai Road, Yangguang Community, Xili Sub-district, Nanshan District, Shenzhen, Guangdong Province, P. R. China
Accreditation Certificate	The laboratory is a testing organization accredited by FCC as a accredited testing laboratory. The designation number is CN1196.

2 PRODUCT INFORMATION

2.1 Applicant Information

Applicant	Ugreen Group Limited
Address	UGREEN Building, Longcheng Industrial Park Longguanxi Road, Longhua, ShenZhen, China

2.2 Manufacturer Information

Manufacturer	Ugreen Group Limited
Address	UGREEN Building, Longcheng Industrial Park Longguanxi Road, Longhua, ShenZhen, China

2.3 General Description for Equipment under Test (EUT)

EUT Name	Bluetooth Adapter
Model Name Under Test	CM749
Series Model Name	35059
Description of Model name differentiation	All models are same with electrical parameters and internal circuit structure, but only differ in model name. (this information provided by the applicant)
Hardware Version	V2
Software Version	V1.0
Dimensions (Approx.)	N/A
Weight (Approx.)	N/A

2.4 Technical Information

Network and Wireless connectivity	Bluetooth (BR+EDR+BLE)
-----------------------------------	------------------------

The requirement for the following technical information of the EUT was tested in this report:

Modulation Technology	FHSS
Modulation Type	GFSK, $\pi/4$ -DQPSK, 8-DPSK
Product Type	<input type="checkbox"/> Mobile <input checked="" type="checkbox"/> Portable <input type="checkbox"/> Fix Location
Transfer Rate	DH5: 1 Mbps 2DH5: 2 Mbps 3DH5: 3 Mbps
Frequency Range	The frequency range used is 2400 MHz to 2483.5 MHz.
Number of Channel	79 (at intervals of 1 MHz)
Tested Channel	0 (2402 MHz), 39 (2441 MHz), 78 (2480 MHz)
Antenna Type	Dipole Antenna
Antenna Gain	1.54 dBi
Antenna Impedance	50 Ω
Antenna System (MIMO Smart Antenna)	N/A

All channel was listed on the following table:

Channel number	Freq. (MHz)	Channel number	Freq. (MHz)	Channel number	Freq. (MHz)	Channel number	Freq. (MHz)
0	2402	21	2423	42	2444	63	2465
1	2403	22	2424	43	2445	64	2466
2	2404	23	2425	44	2446	65	2467
3	2405	24	2426	45	2447	66	2468
4	2406	25	2427	46	2448	67	2469
5	2407	26	2428	47	2449	68	2470
6	2408	27	2429	48	2450	69	2471
7	2409	28	2430	49	2451	70	2472
8	2410	29	2431	50	2452	71	2473
9	2411	30	2432	51	2453	72	2474
10	2412	31	2433	52	2454	73	2475
11	2413	32	2434	53	2455	74	2476
12	2414	33	2435	54	2456	75	2477
13	2415	34	2436	55	2457	76	2478
14	2416	35	2437	56	2458	77	2479
15	2417	36	2438	57	2459	78	2480
16	2418	37	2439	58	2460	-	-
17	2419	38	2440	59	2461	-	-
18	2420	39	2441	60	2462	-	-
19	2421	40	2442	61	2463	-	-
20	2422	41	2443	62	2464	-	-

3 SUMMARY OF TEST RESULTS

3.1 Test Standards

No.	Identity	Document Title
1	47 CFR Part 15, Subpart C	Intentional radiators of radio frequency equipment
2	ANSI C63.10-2013	American National Standard for Testing Unlicensed Wireless Devices
3 ☆	KDB 558074 D01 15.247 Meas Guidance v05r02	Guidance for compliance measurements on digital transmission system, frequency hopping spread spectrum system, and hybrid system devices operating under section 15.247 of the FCC rules

3.2 Test Verdict

No.	Description	FCC Part No.	Channel	Test Result	Verdict	Remark
1	Antenna Requirement	15.203	N/A	--	Pass	Note ¹
2	Number of Hopping Frequencies	15.247(a)	Hopping Mode	5.3.4	Pass	Note ²
3	Peak Output Power	15.247(b)	Low/Middle/High	5.4.4	Pass	--
4	Occupied Bandwidth	15.247(a)	Low/Middle/High	5.5.4	Pass	--
5	Carrier Frequency Separation	15.247(a)	Hopping Mode	5.6.4	Pass	Note ²
6	Time of Occupancy (Dwell time)	15.247(a)	Hopping Mode	5.7.4	Pass	Note ²
7	Conducted Spurious Emission & Authorized-band band-edge	15.247(d)	Hopping Mode; Low/Middle/High	5.8.4	Pass	Note ²
8	Conducted Emission	15.207	Low/Middle/High	5.9.4	Pass	Note ²
9	Radiated Spurious Emission	15.209 15.247(d)	Low/Middle/High	5.10.4	Pass	Note ²
10	Band Edge(Restricted-band band-edge)	15.209 15.247(d)	Low/High	5.11.4	Pass	Note ²

Note ¹: The EUT has a permanently and irreplaceable attached antenna, which complies with the requirement FCC 15.203.

Note ²: $\pi/4$ -DQPSK is the EDR 2M rate mode, 8-DPSK is the EDR 3M rate mode. The consistency of test results in $\pi/4$ -DQPSK and 8-DPSK is very high. So we chose 8-DPSK as a typical representative to appear on the report. Another we will show all the modes on the RF output power test item.

4 GENERAL TEST CONFIGURATIONS

4.1 Test Environments

During the measurement, the normal environmental conditions were within the listed ranges:

Relative Humidity	47% to 59%	
Atmospheric Pressure	100 kPa to 102 kPa	
Temperature	NT (Normal Temperature)	+ 22.6°C to +26.7°C
Working Voltage of the EUT	NV (Normal Voltage)	5.0 V

4.2 Test Equipment List

Description	Manufacturer	Model	Serial No.	Cal. Date	Cal. Due
Spectrum Analyzer	KEYSIGHT	N9020A	MY50330200	2023.05.16	2024.05.15
Spectrum Analyzer	ROHDE&SCHWARZ	FSV-40	101544	2022.12.28	2023.12.27
Spectrum Analyzer	KEYSIGHT	N9020A	MY52510065	2023.09.05	2024.09.04
Signaling Unit	ROHDE&SCHWARZ	CMW500	171150	2023.06.19	2024.06.18
Test Antenna-Horn	SCHWARZBECK	BBHA 9120D	01631	2022.02.03	2025.02.02
Test Antenna-Horn	A-INFO	LB-180400KF	J211060273	2021.07.02	2024.07.01
Anechoic Chamber	RAINFORD	9m*6m*6m	144	2022.02.19	2024.09.03
Amplifier	COM-MV	ZT30-1000M	07210897	2023.09.05	2024.09.04
Amplifier	COM-MV	LSCX_LNA1-12G-01	7210214	2023.09.05	2024.09.04
Amplifier	COM-MV	XKu_LNA7-18G-01	7210209	2023.09.05	2024.09.04
Amplifier	COM-MV	KA LNA18 40G-01	18050001	2022.12.07	2023.12.06
EMI Receiver	ROHDE&SCHWARZ	ESRP	101036	2023.09.05	2024.09.04
Test Antenna-Loop	SCHWARZBECK	FMZB 1519	1519-037	2021.04.16	2024.04.15
Anechoic Chamber	EMC Electronic Co., Ltd	20.10*11.60*7.35m	130	2021.08.15	2024.08.14
Test Antenna-Bi-Log	SCHWARZBECK	VULB 9163	9163-624	2021.08.20	2024.08.19
EMI Receiver	KEYSIGHT	N9038A	MY53220118	2023.09.05	2024.09.04
Anechoic Chamber	RAINFORD	9m*6m*6m	101	2023.03.26	2026.03.03
EMI Receiver	KEYSIGHT	N9010B	MY57110309	2023.09.05	2024.09.04
LISN	SCHWARZBECK	NSLK 8127	8127-687	2023.05.16	2024.05.15
Shielded Enclosure	YiHeng Electronic Co., Ltd	3.5m*3.1m*2.8m	112	2022.02.19	2025.02.18

4.3 Test Software List

Description	Manufacturer	Software Version	Serial No.	Applicable test Setup
BL410R	BALUN	V2.1.1.488	N/A	The section 4.5.1
BL410E	BALUN	V22.930	N/A	The section 4.5.2&4.5.3&4.5.4&4.5.5

4.4 Measurement Uncertainty

The following measurement uncertainty levels have been estimated for tests performed on the EUT as specified in CISPR 16-4-2.

This uncertainty represents an expanded uncertainty expressed at approximately the 95% confidence level using a coverage factor of k=2.

Parameters	Uncertainty
Occupied Channel Bandwidth	2.8%
RF output power, conducted	1.28 dB
Power Spectral Density, conducted	1.30 dB
Unwanted Emissions, conducted	1.84 dB
All emissions, radiated	5.36 dB
Temperature	0.8°C
Humidity	4%

4.5 Description of Test Setup

4.5.1 For Antenna Port Test

$$\text{Conducted value (dBm)} = \text{Measurement value (dBm)} + \text{cable loss (dB)}$$

For example: the measurement value is 10 dBm and the cable 0.5dBm used, then the final result of EUT:

$$\text{Conducted value (dBm)} = 10 \text{ dBm} + 0.5 \text{ dB} = 10.5 \text{ dBm}$$

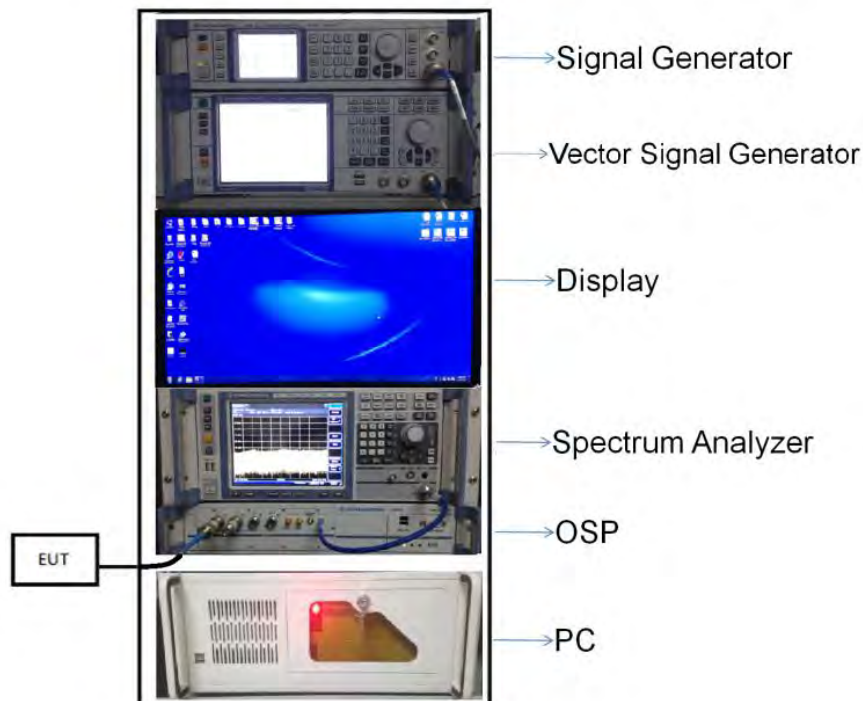

(Diagram 1)

4.5.2 For AC Power Supply Port Test



(Diagram 2)

4.5.3 For Radiated Test (Below 30 MHz)

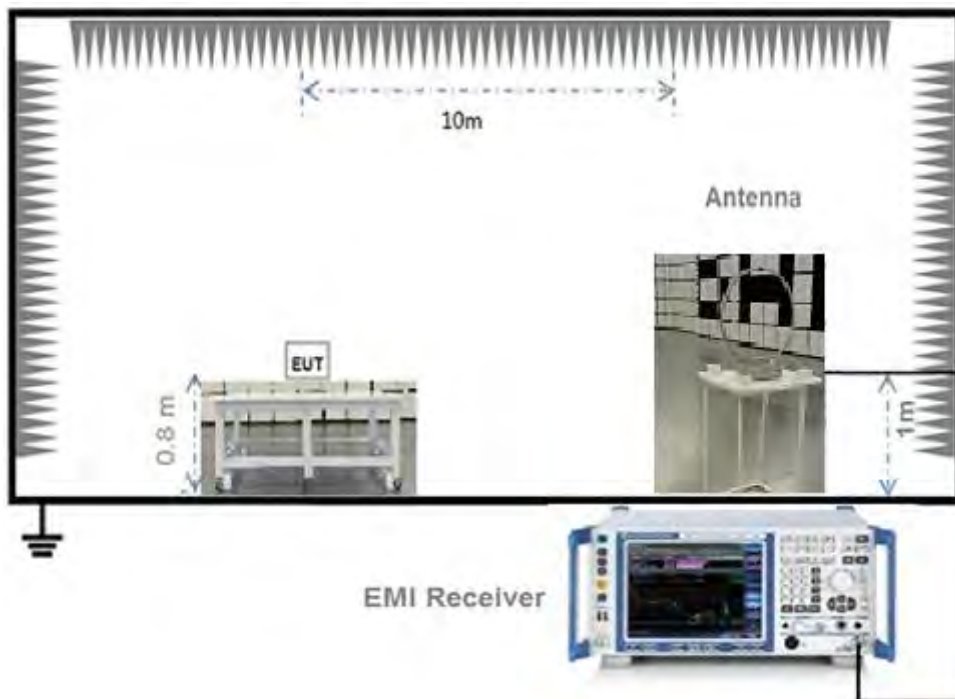

(Diagram 3)

4.5.4 For Radiated Test (30 MHz-1 GHz)

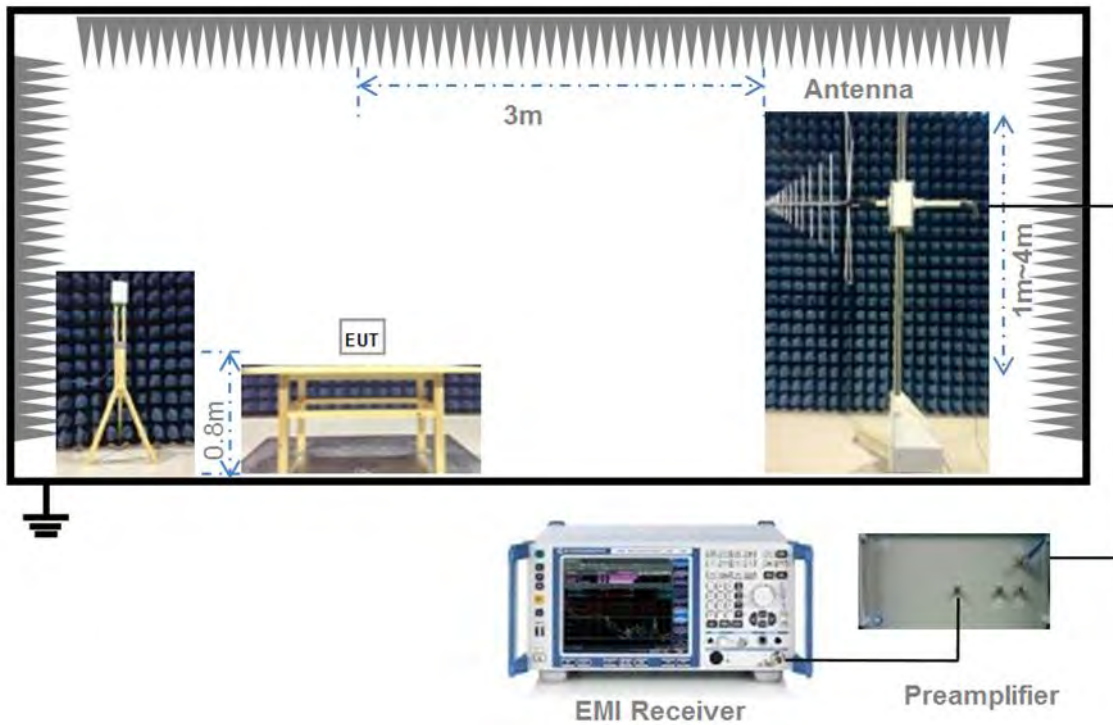

(Diagram 4)

4.5.5 For Radiated Test (Above 1 GHz)

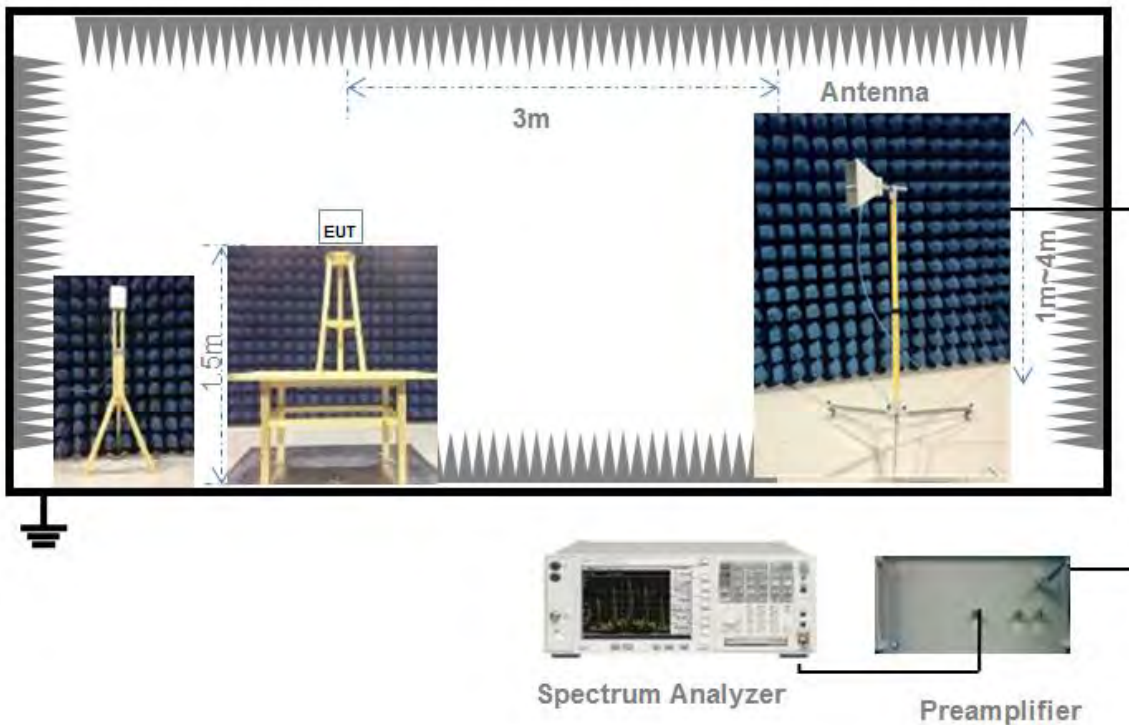

(Diagram 5)

4.6 Measurement Results Explanation Example

4.6.1 For conducted test items:

The offset level is set in the spectrum analyzer to compensate the RF cable loss and attenuator between EUT conducted output port and spectrum analyzer. With the offset compensation, the spectrum analyzer reading level is exactly the EUT RF output level.

The spectrum analyzer offset is derived from RF cable loss and attenuator factor.

Offset = RF cable loss + attenuator factor.

5 TEST ITEMS

5.1 Antenna Requirements

5.1.1 Relevant Standards

FCC §15.203 & 15.247(b)

An intentional radiator shall be designed to ensure that no antenna other than that furnished by the responsible party shall be used with the device. The use of a permanently attached antenna or of an antenna that uses a unique coupling to the intentional radiator shall be considered sufficient to comply with the provisions of this section. The manufacturer may design the unit so that a broken antenna can be replaced by the user, but the use of a standard antenna jack or electrical connector is prohibited. This requirement does not apply to carrier current devices or to devices operated under the provisions of § 15.211, § 15.213, § 15.217, § 15.219, or § 15.221. Further, this requirement does not apply to intentional radiators that must be professionally installed, such as perimeter protection systems and some field disturbance sensors, or to other intentional radiators which, in accordance with § 15.31(d), must be measured at the installation site. However, the installer shall be responsible for ensuring that the proper antenna is employed so that the limits in this part are not exceeded.

If directional gain of transmitting antennas is greater than 6 dBi, the power shall be reduced by the same level in dB comparing to gain minus 6 dBi. For the fixed point-to-point operation, the power shall be reduced by one dB for every 3 dB that the directional gain of the antenna exceeds 6 dBi. The use of a permanently attached antenna or of an antenna that uses a unique coupling to the intentional radiator shall be considered sufficient to comply with the FCC rule.

5.1.2 Antenna Anti-Replacement Construction

The Antenna Anti-Replacement as following method:

Protected Method	Description
The antenna is embedded in the product.	An embedded-in antenna design is used.

Reference Documents	Item
Photo	Please refer to the EUT Photo documents.

5.1.3 Antenna Gain

The antenna peak gain of EUT is less than 6 dBi. Therefore, it is not necessary to reduce maximum peak output power limit.

5.2 Frequency Hopping Systems

5.2.1 Relevant Standards

FCC §15.247(a) (1) (i) (ii) (iii) (iv); FCC §15.247(g); FCC §15.247(h)

Describe how the hopping sequence is generated. Provide an example of the hopping sequence channels, to demonstrate that the sequence meets the requirement specified in the definition of an FHSS system. Per the definition in Section 2.1(c), the hop set shall appear as random in the near term, shall appear as evenly distributed in the long term, and sequential hops shall be randomly distributed in both direction and magnitude of change.

Describe how each individual EUT meets the requirement that each of its hopping channels is used equally on average (e.g., that each new transmission event begins on the next channel in the hopping sequence after the final channel used in the previous transmission event).

Describe how the associated receiver(s) complies with the requirement that the input bandwidth (either RF or IF) matches the bandwidth of the transmitted signal.

Describe how the associated receiver(s) has the ability to shift frequencies in synchronization with the transmitted signals.

For short burst systems, describe how the EUT complies with the requirement that it be designed to be capable of operating as a true frequency hopping system. Specifically, the device shall comply with the equal frequency use and pseudorandom hopping sequence requirement when transmitting in short bursts, and shall be designed to comply when presented with continuous data (or information) stream.

Describe how the EUT complies with the requirement that it not have the ability to be coordinated with other FHSS systems in an effort to avoid the simultaneous occupancy of individual hopping frequencies by multiple transmitters.

5.2.2 Description of the systems

1. According to the preset procedure of the whole network, all the stations in the automatic control network synchronously change the frequency multiple times within one second, and temporarily stay on each frequency hopping channel. Periodic synchronization signaling is sent from the primary station, instructing all slaves to simultaneously change the operating frequency, then the hopping sequence is generated.
2. The hop set shall appear as random in the near term, shall appear as evenly distributed in the long term, and sequential hops shall be randomly distributed in both direction and magnitude of change.

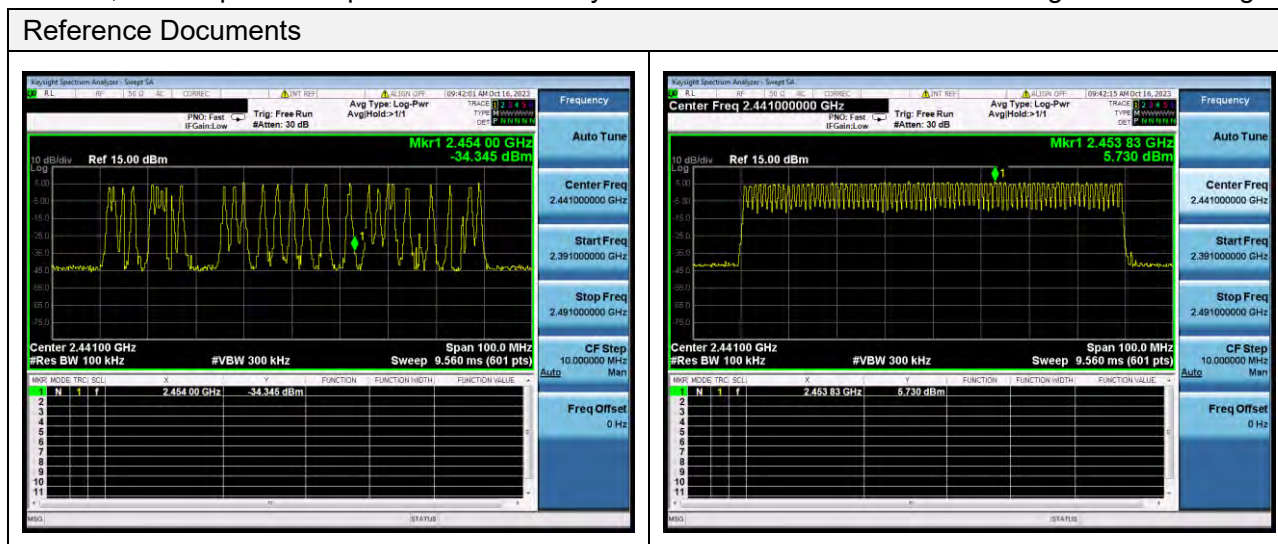

3. Channels are classified into two categories, used and unused, where used channels are part of the hopping sequence and unused channels are replaced in the hopping sequence by used channels in a pseudo-random way. Make each individual EUT meets the requirement that each of its hopping channels is used equally on average.
4. The input bandwidth and transmitted bandwidth are both 1MHz, the associated receiver(s) complies with the requirement that the input bandwidth matches the bandwidth of the transmitted signal.
5. Connected devices communicate on the same physical channel by synchronizing with a common clock and hopping sequence.
6. EUT isn't short burst systems.
7. EUT can't have the ability to be coordinated with other FHSS systems in an effort.

5.3 Number of Hopping Frequencies

5.3.1 Limit

FCC §15.247(a) (1) (iii)

Frequency hopping systems operating in the 2400 MHz to 2483.5 MHz bands shall use at least 15 hopping frequencies.

5.3.2 Test Setup

See section 4.5.1 for test setup description for the antenna port. The photo of test setup please refer to ANNEX A.

5.3.3 Test Procedure

The EUT must have its hopping function enabled. Use the following spectrum analyzer settings:

Span = The frequency band of operation

RBW = To identify clearly the individual channels, set the RBW to less than 30% of the channel spacing or the 20 dB bandwidth, whichever is smaller.

VBW \geq RBW

Sweep = auto

Detector function = peak

Trace = max hold

Allow the trace to stabilize

5.3.4 Test Result

Test Data

Test Mode	Frequency Block (MHz)	Measured Channel Numbers	Min. Limit	Verdict
GFSK	2400 - 2483.5	79	15	Pass
8-DPSK	2400 - 2483.5	79	15	Pass

Test Plots

GFSK 2.4 GHz ~ 2.4415 GHz

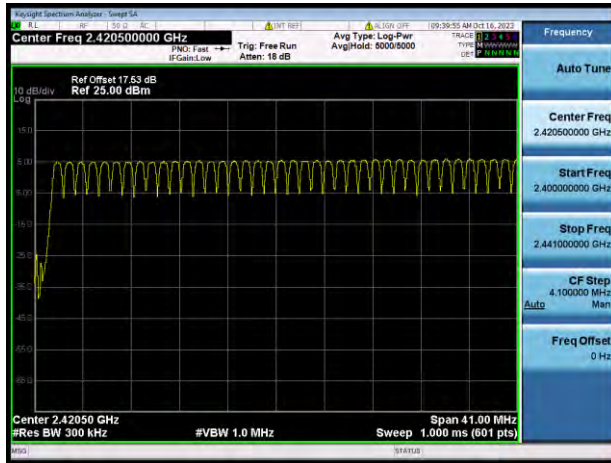

GFSK 2.4415 GHz ~ 2.4835 GHz

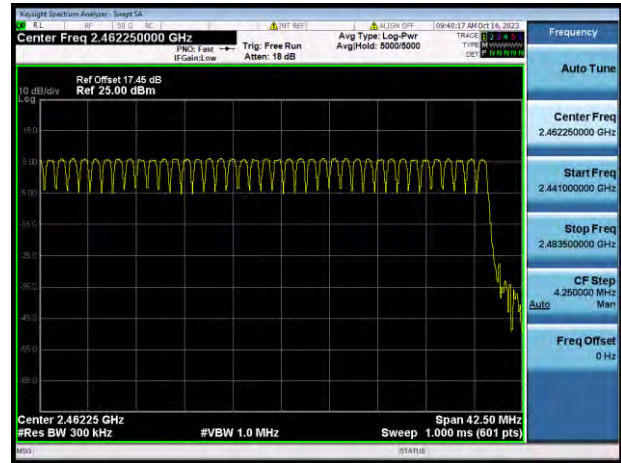

8-DPSK 2.4 GHz ~ 2.4415 GHz

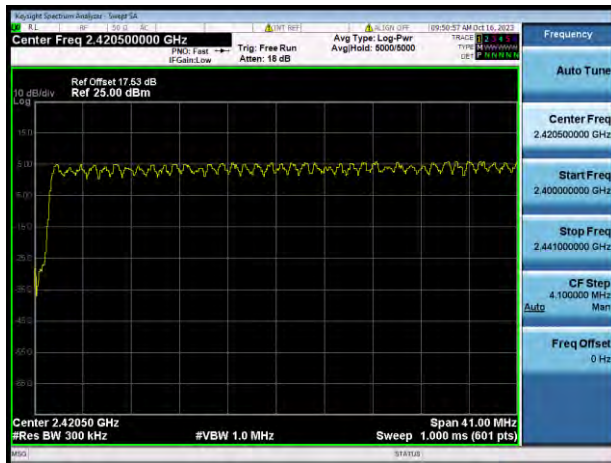

8-DPSK 2.4415 GHz ~ 2.4835 GHz

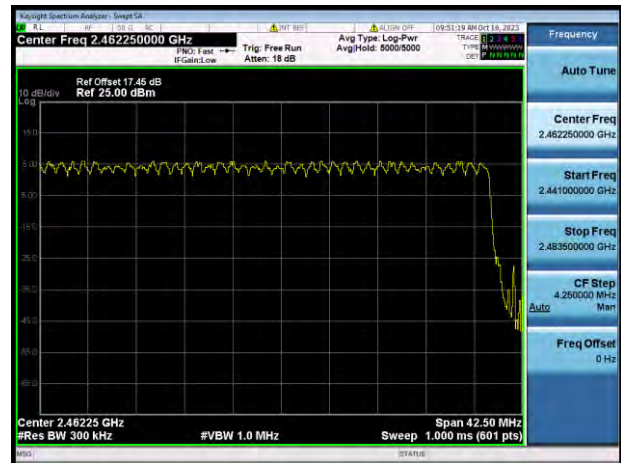

5.4 Peak Output Power

5.4.1 Test Limit

FCC § 15.247(b)

For frequency hopping systems operating in the 2400-2483.5 MHz band employing at least 75 non-overlapping hopping channels band: 1 watt. For all other frequency hopping systems in the 2400-2483.5 MHz band: 0.125 watts.

5.4.2 Test Setup

See section 4.5.1 for test setup description for the antenna port. The photo of test setup please refer to ANNEX A.

5.4.3 Test Procedure

The Module operates at hopping-off test mode. The lowest, middle and highest channels are selected to perform testing to verify the conducted RF output peak power of the Module.

Use the following spectrum analyzer settings:

Span = approximately 5 times the 20 dB bandwidth, centered on a hopping channel

RBW > the 20 dB bandwidth of the emission being measured

VBW ≥ RBW

Sweep = auto

Detector function = peak

Trace = max hold

Allow the trace to stabilize.

5.4.4 Test Result

Peak Power Test Data

Channel	Measured Output Peak Power						Limit		Verdict
	GFSK		π/4-DQPSK		8-DPSK		dBm	mW	
	dBm	mW	dBm	mW	dBm	mW			
Low	5.49	3.54	5.55	3.59	6.31	4.28	21	125	Pass
Middle	6.64	4.61	6.71	4.69	7.37	5.46			Pass
High	6.55	4.52	6.54	4.51	7.24	5.30			Pass

Test Plots

GFSK LOW CHANNEL

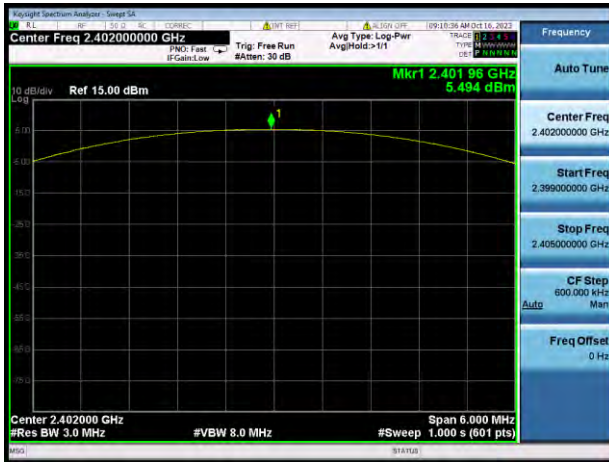

GFSK MIDDLE CHANNEL

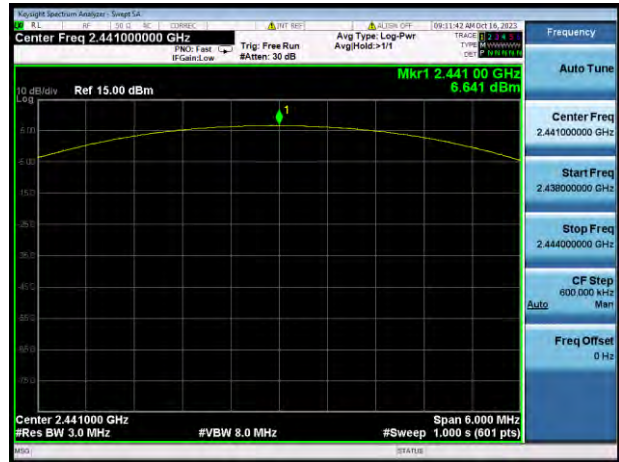

GFSK HIGH CHANNEL



$\pi/4$ -DQPSK LOW CHANNEL



$\pi/4$ -DQPSK MIDDLE CHANNEL



$\pi/4$ -DQPSK HIGH CHANNEL



8-DPSK LOW CHANNEL



8-DPSK MIDDLE CHANNEL



8-DPSK HIGH CHANNEL

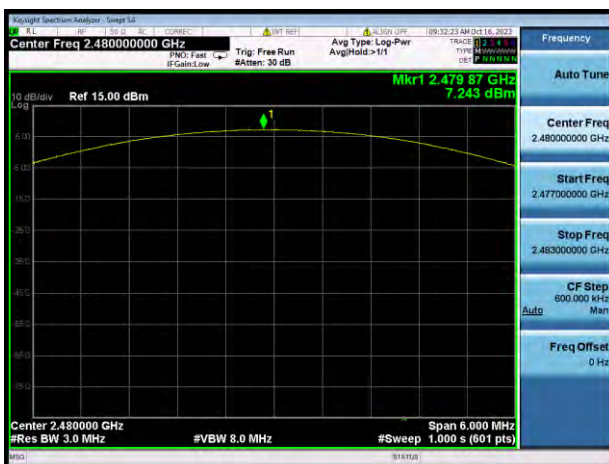

5.5 Occupied Bandwidth

5.5.1 Limit

FCC §15.247(a)

Measurement of the 20dB bandwidth of the modulated signal.

5.5.2 Test Setup

See section 4.5.1 for test setup description for the antenna port. The photo of test setup please refer to ANNEX A.

5.5.3 Test Procedure

Use the following spectrum analyzer settings:

Span = approximately 2 to 5 times the 20 dB bandwidth, centered on a hopping channel

RBW = in the range of 1% to 5% of the OBW

VBW \geq RBW

Sweep = auto

Detector function = peak

Trace = max hold

The EUT should be transmitting at its maximum data rate, Allow the trace to stabilize.

5.5.4 Test Result

Test Data

GFSK		
Channel	20 dB Bandwidth (MHz)	99% Bandwidth (MHz)
Low	1.060000	0.967140
Middle	1.065000	0.966080
High	1.065000	0.968130
$\pi/4$ -DQPSK		
Channel	20 dB Bandwidth (MHz)	99% Bandwidth (MHz)
Low	1.390000	1.236900
Middle	1.395000	1.236700
High	1.395000	1.236600
8-DPSK		
Channel	20 dB Bandwidth (MHz)	99% Bandwidth (MHz)
Low	1.375000	1.234500
Middle	1.375000	1.234300
High	1.370000	1.234200

Test Plots

20 dB Bandwidth

GFSK LOW CHANNEL



GFSK MIDDLE CHANNEL



GFSK HIGH CHANNEL



π/4-DQPSK LOW CHANNEL



π/4-DQPSK MIDDLE CHANNEL



$\pi/4$ -DQPSK HIGH CHANNEL



8-DPSK LOW CHANNEL



8-DPSK MIDDLE CHANNEL



8-DPSK HIGH CHANNEL



99% Bandwidth

GFSK LOW CHANNEL



GFSK MIDDLE CHANNEL

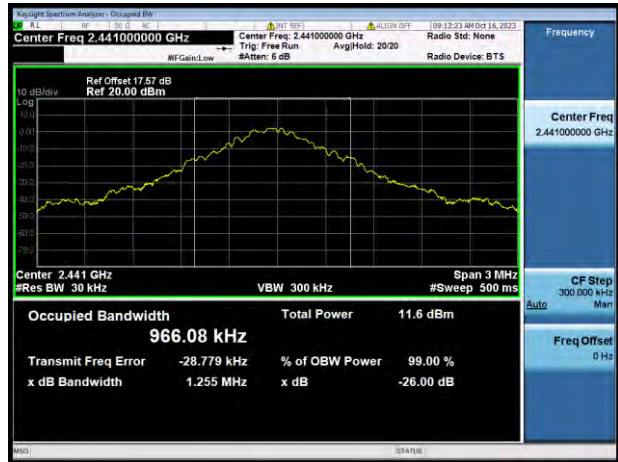

GFSK HIGH CHANNEL

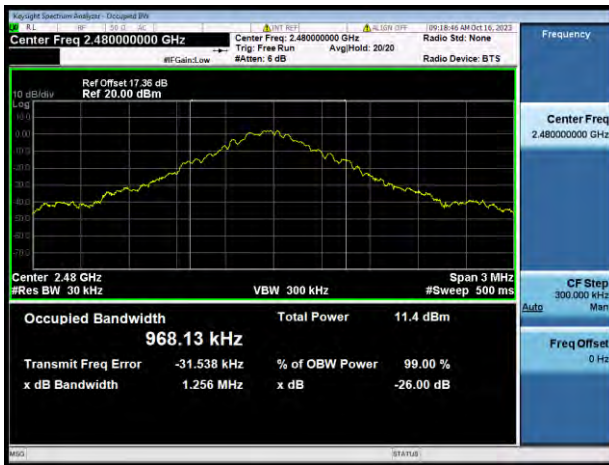

$\pi/4$ -DQPSK LOW CHANNEL

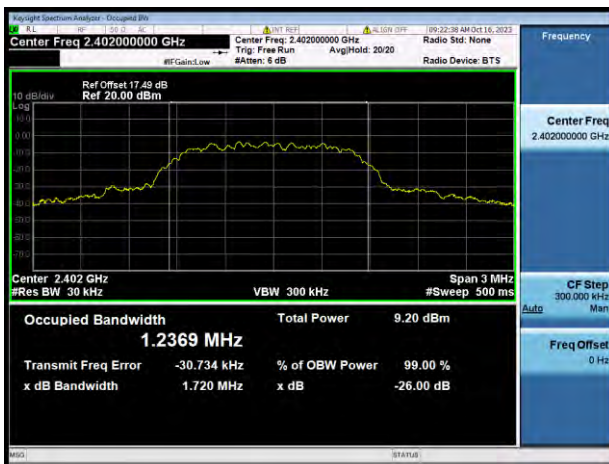

$\pi/4$ -DQPSK MIDDLE CHANNEL

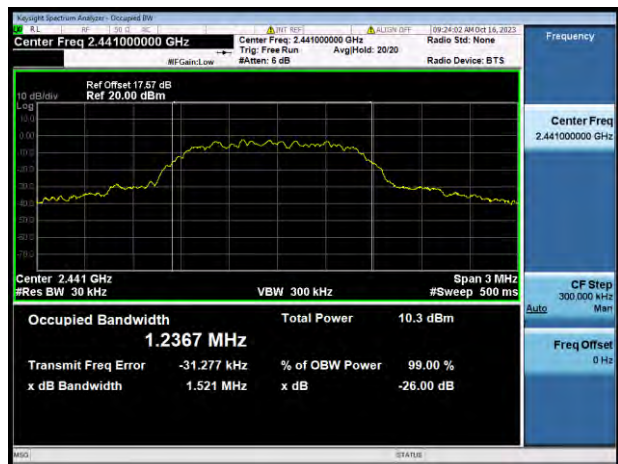

$\pi/4$ -DQPSK HIGH CHANNEL



8-DPSK LOW CHANNEL

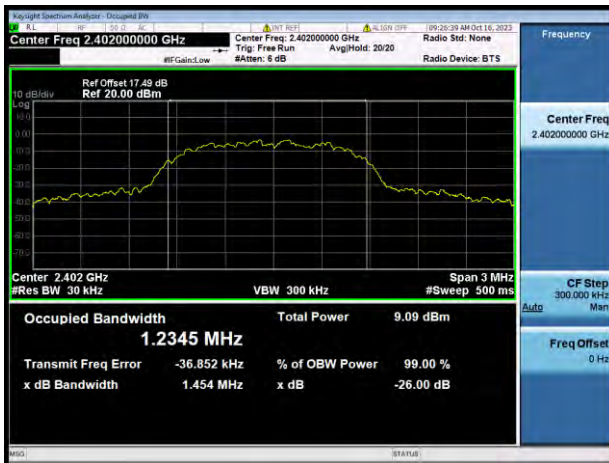

8-DPSK MIDDLE CHANNEL



8-DPSK HIGH CHANNEL

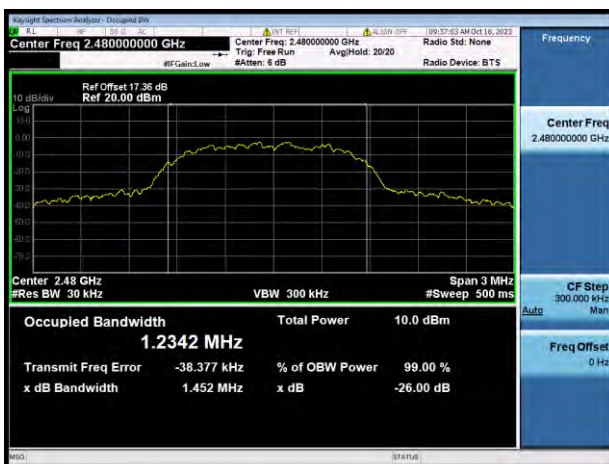

5.6 Carrier Frequency Separation

5.6.1 Limit

FCC §15.247(a)

Frequency hopping systems shall have hopping channel carrier frequencies separated by a minimum of 25 kHz or the 2/3 of the 20 dB bandwidth of the hopping channel, whichever is greater.

5.6.2 Test Setup

See section 4.5.1 for test setup description for the antenna port. The photo of test setup please refer to ANNEX A.

5.6.3 Test Procedure

The EUT must have its hopping function enabled. Use the following spectrum analyzer settings:

Span = wide enough to capture the peaks of two adjacent channels

Resolution (or IF) Bandwidth (RBW) \geq 1% of the span

Video (or Average) Bandwidth (VBW) \geq RBW

Sweep = auto

Detector function = peak

Trace = max hold

Allow the trace to stabilize. Use the marker-delta function to determine the separation between the peaks of the adjacent channels.

5.6.4 Test Result

Test Data

Mode	Frequency separation (MHz)	2/3 of the 20 dB Bandwidth (MHz)	Verdict
GFSK	1.000	0.710	Pass
8-DPSK	1.000	0.917	Pass

Test Plots

GFSK

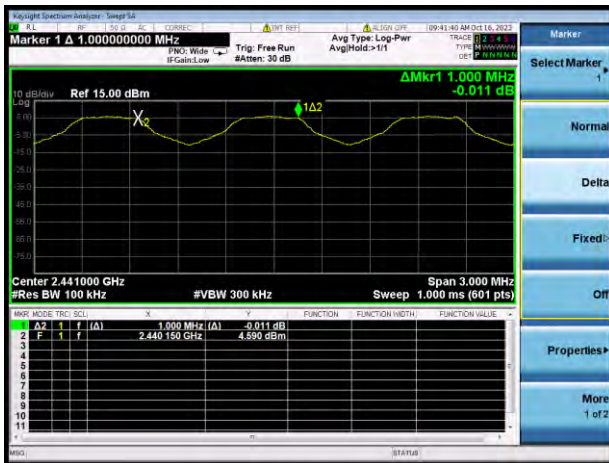

8-DPSK

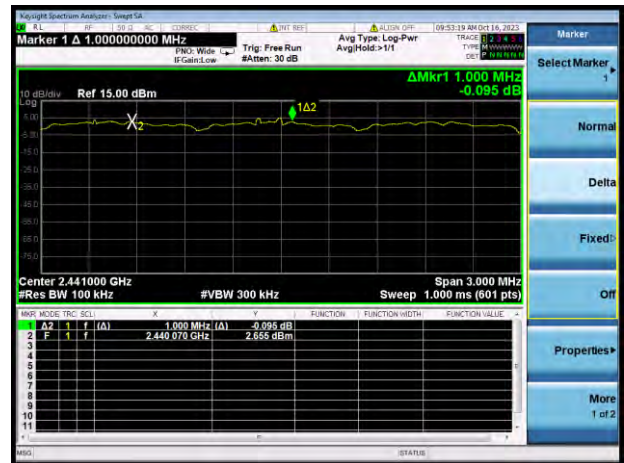

5.7 Time of Occupancy (Dwell time)

5.7.1 Limit

FCC §15.247(a)

Frequency hopping systems in the 2400 MHz - 2483.5 MHz band shall use at least 15 non-overlapping channels. The average time of occupancy on any channel shall not be greater than 0.4 seconds within a period of 0.4 seconds multiplied by the number of hopping channels employed. Frequency hopping systems may avoid or suppress transmissions on a particular hopping frequency provided that a minimum of 15 channels are used.

5.7.2 Test Setup

See section 4.5.1 for test setup description for the antenna port. The photo of test setup please refer to ANNEX A.

5.7.3 Test Procedure

The EUT shall have its hopping function enabled. Use the following spectrum analyzer settings:

Span: Zero span, centered on a hopping channel

RBW shall be \leq channel spacing and where possible RBW should be set $\gg 1/T$, where T is the expected dwell time per channel

Sweep: As necessary to capture the entire dwell time per hopping channel; where possible use a video trigger and trigger delay so that the transmitted signal starts a little to the right of the start of the plot. The trigger level might need slight adjustment to prevent triggering when the system hops on an adjacent channel; a second plot might be needed with a longer sweep time to show two successive hops on a channel

Detector function: Peak

Trace: Max hold

Use the marker-delta function to determine the transmit time per hop. If this value varies with different modes of operation (data rate, modulation format, number of hopping channels, etc.), then repeat this test for each variation in transmit time.

The average time of occupancy on any channel within the Period can be calculated with formulas:

For GFSK and $\pi/4$ -DQPSK:

For DH1 package type

$$\{\text{Total of Dwell}\} = \{\text{Pulse Time}\} * (1600 / 2) / \{\text{Number of Hopping Frequency}\} * \{\text{Period}\}$$

$$\{\text{Period}\} = 0.4 \text{ s} * \{\text{Number of Hopping Frequency}\}$$

For DH3 package type

$$\{\text{Total of Dwell}\} = \{\text{Pulse Time}\} * (1600 / 4) / \{\text{Number of Hopping Frequency}\} * \{\text{Period}\}$$

$$\{\text{Period}\} = 0.4 \text{ s} * \{\text{Number of Hopping Frequency}\}$$

For DH5 package type

$$\{\text{Total of Dwell}\} = \{\text{Pulse Time}\} * (1600 / 6) / \{\text{Number of Hopping Frequency}\} * \{\text{Period}\}$$

$$\{\text{Period}\} = 0.4 \text{ s} * \{\text{Number of Hopping Frequency}\}$$

For AFH Mode:

For DH1 package type

$$\{\text{Total of Dwell}\} = \{\text{Pulse Time}\} * (800 / 2) / \{\text{Number of Hopping Frequency}\} * \{\text{Period}\}$$

$$\{\text{Period}\} = 0.4 \text{ s} * \{\text{Number of Hopping Frequency}\}$$

For DH3 package type

$$\{\text{Total of Dwell}\} = \{\text{Pulse Time}\} * (800 / 4) / \{\text{Number of Hopping Frequency}\} * \{\text{Period}\}$$

$$\{\text{Period}\} = 0.4 \text{ s} * \{\text{Number of Hopping Frequency}\}$$

For DH5 package type

$$\{\text{Total of Dwell}\} = \{\text{Pulse Time}\} * (800 / 6) / \{\text{Number of Hopping Frequency}\} * \{\text{Period}\}$$

$$\{\text{Period}\} = 0.4 \text{ s} * \{\text{Number of Hopping Frequency}\}$$

The lowest, middle and highest channels are selected to perform testing to record the dwell time of each occupation measured in this channel, which is called Pulse Time here.

5.7.4 Test Result

Test Data

GFSK				
DH Packet	Pulse Width (ms)	Total of Dwell (ms)	Limit (sec)	Verdict
DH 1	0.38400	122.880	0.4	Pass
DH 3	1.64100	262.560	0.4	Pass
DH 5	2.88800	308.053	0.4	Pass
8-DPSK				
DH Packet	Pulse Width (ms)	Total of Dwell (ms)	Limit (sec)	Verdict
DH 1	0.39360	125.952	0.4	Pass
DH 3	1.64100	262.560	0.4	Pass
DH 5	2.90000	309.333	0.4	Pass
AFH Mode				
DH Packet	Pulse Width (ms)	Total of Dwell (ms)	Limit (sec)	Verdict
DH 1	0.38400	61.440	0.4	Pass
DH 3	1.63400	130.720	0.4	Pass
DH 5	2.88800	154.027	0.4	Pass

Test Plots

GFSK DH1

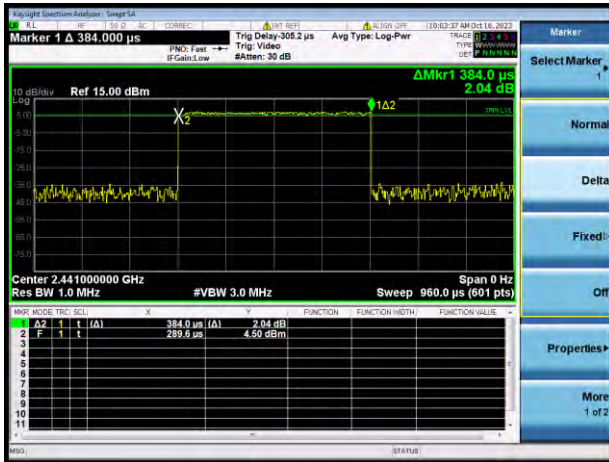

GFSK DH3

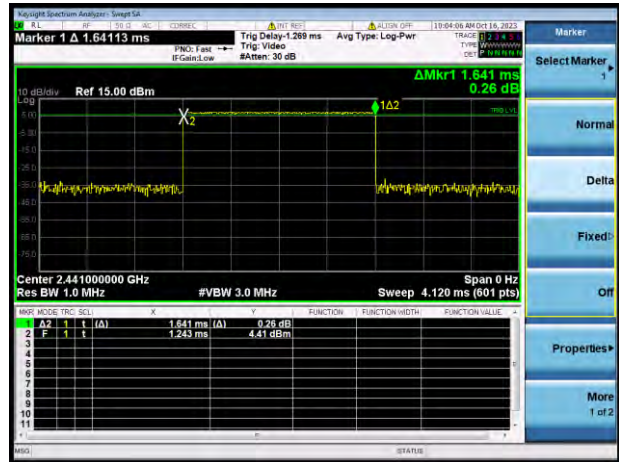

GFSK DH5

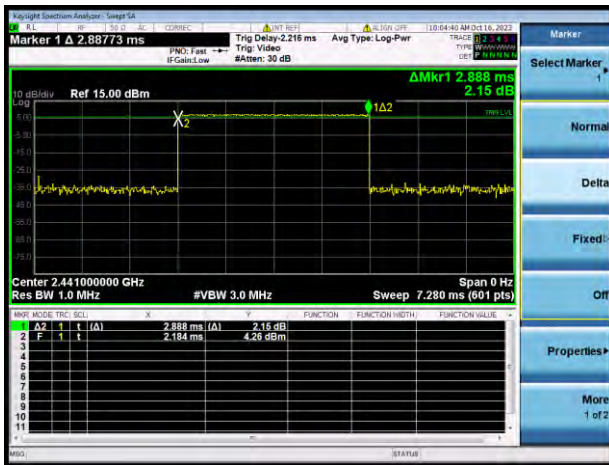

8-DPSK DH1

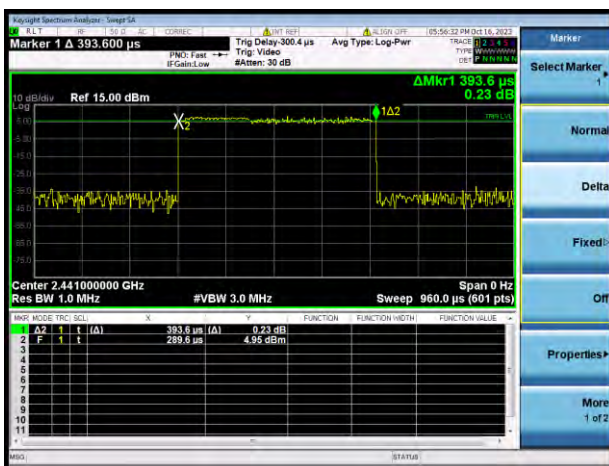

8-DPSK DH3

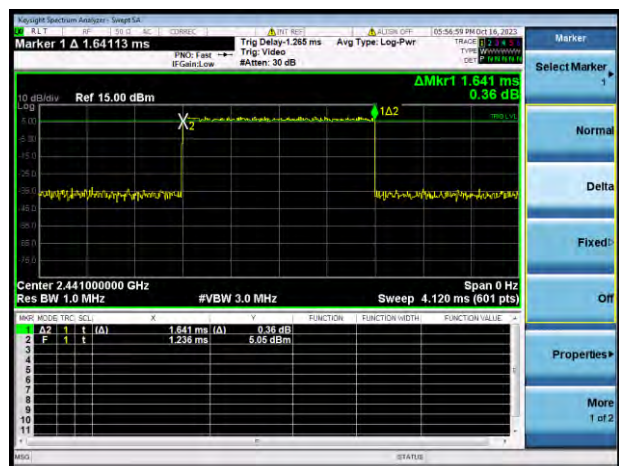

8-DPSK DH5

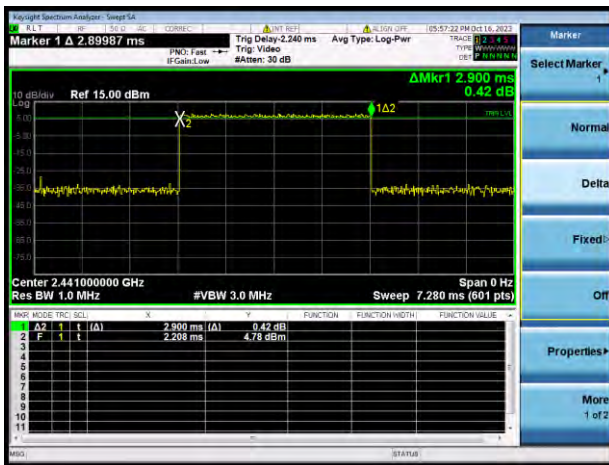

AFH Mode DH1

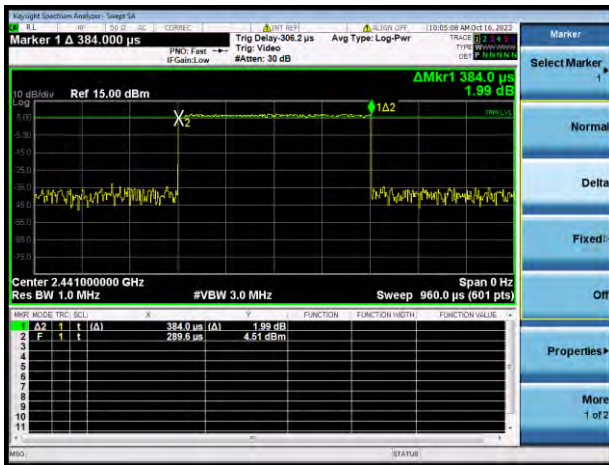

AFH Mode DH3

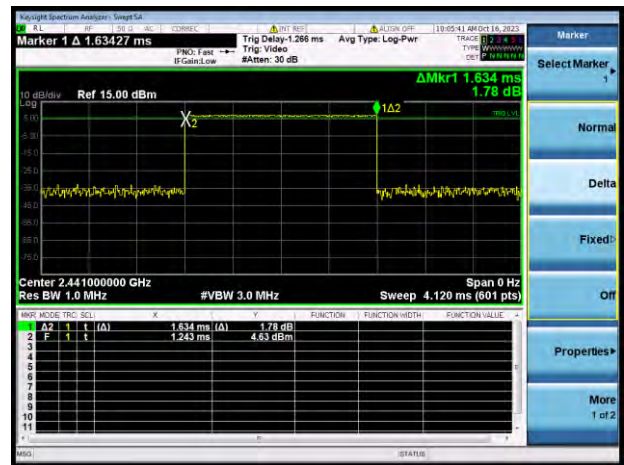

AFH Mode DH5

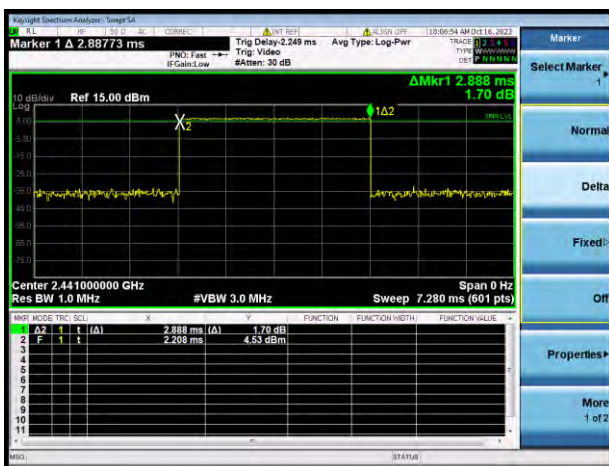

5.8 Conducted Spurious Emission & Authorized-band band-edge

5.8.1 Limit

FCC §15.247(d)

In any 100 kHz bandwidth outside the frequency band in which the spread spectrum or digitally modulated intentional radiator is operating, the radio frequency power that is produced by the intentional radiator shall be at least 20 dB below that in the 100 kHz bandwidth within the band that contains the highest level of the desired power, based on either an RF conducted or a radiated measurement.

5.8.2 Test Setup

See section 4.5.1 for test setup description for the antenna port. The photo of test setup please refer to ANNEX A.

5.8.3 Test Procedure

Use the following spectrum analyzer settings:

Span = wide enough to capture the peak level of the in-band emission and all spurious emissions (e.g., harmonics) from the lowest frequency generated in the EUT up through the 10th harmonic. Typically, several plots are required to cover this entire span.

RBW = 100 kHz

VBW = 300 kHz

Sweep = auto

Detector function = peak

Trace = max hold

Allow the trace to stabilize

5.8.4 Test Result

Test Data

GFSK				
Channel	Measured Max. Out of Band Emission (dBm)	Limit (dBm)		Verdict
		Carrier Level	Calculated 20 dBc Limit	
Low	-23.95	4.28	-15.72	Pass
Middle	-24.39	5.28	-14.72	Pass
High	-23.45	5.12	-14.88	Pass
8-DPSK				
Channel	Measured Max. Out of Band Emission (dBm)	Limit (dBm)		Verdict
		Carrier Level	Calculated 20 dBc Limit	
Low	-24.78	1.11	-18.89	Pass
Middle	-24.88	2.20	-17.80	Pass
High	-23.87	2.03	-17.97	Pass
Hopping Mode				
Mode	Measured Max. Out of Band Emission (dBm)	Limit (dBm)		Verdict
		Carrier Level	Calculated 20 dBc Limit	
GFSK	-25.38	5.73	-14.27	Pass
8-DPSK	-23.15	5.87	-14.14	Pass

Test Plots

GFSK LOW CHANNEL, CARRIER LEVEL

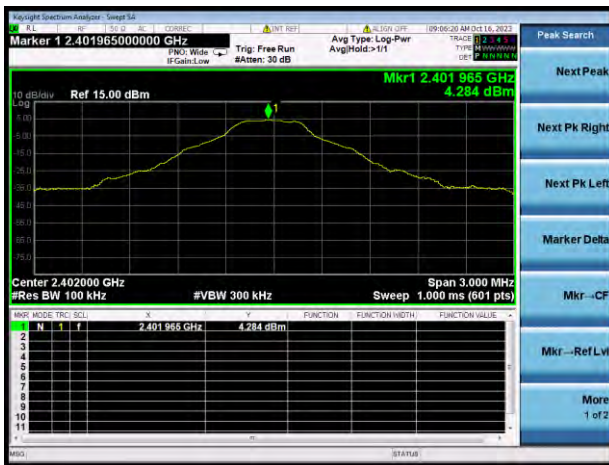

GFSK LOW CHANNEL, BAND EDGE



GFSK LOW CHANNEL, SPURIOUS

30 MHz ~ 3 GHz

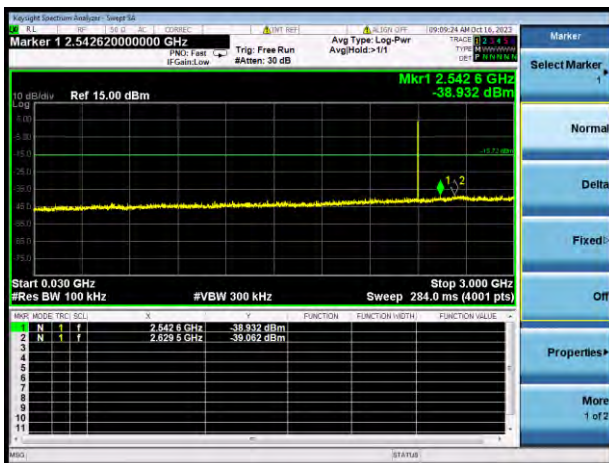

GFSK LOW CHANNEL, SPURIOUS

3 GHz ~ 25 GHz

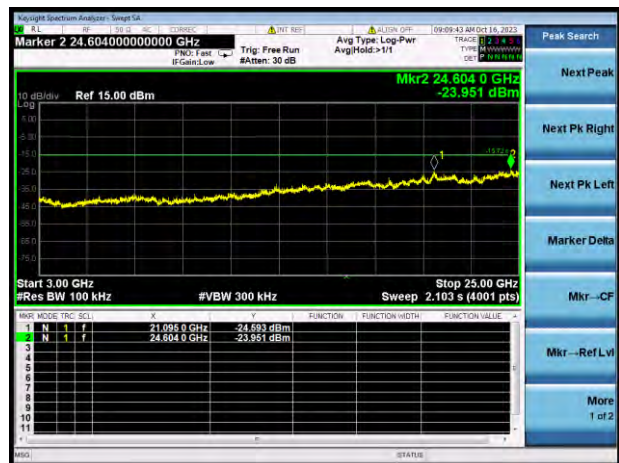

GFSK MIDDLE CHANNEL, CARRIER LEVEL



GFSK MIDDLE CHANNEL, SPURIOUS
30 MHz ~ 3 GHz

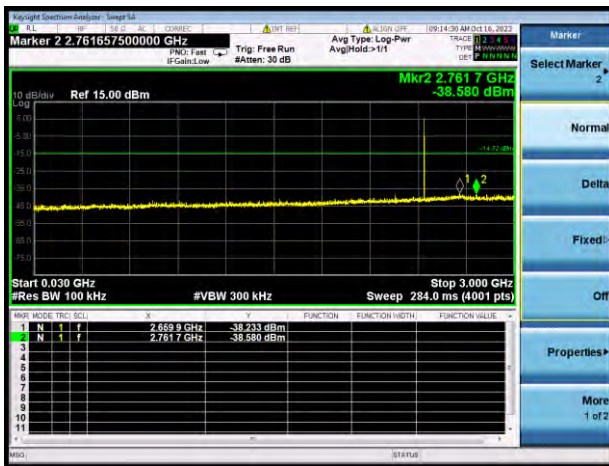

GFSK MIDDLE CHANNEL, SPURIOUS
3 GHz ~ 25 GHz

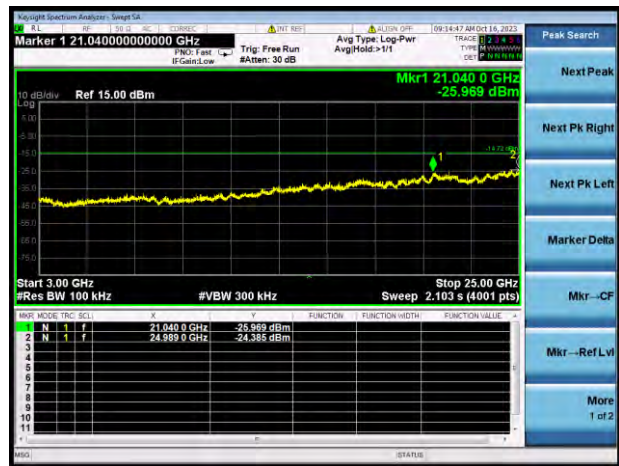

GFSK HIGH CHANNEL, CARRIER LEVEL

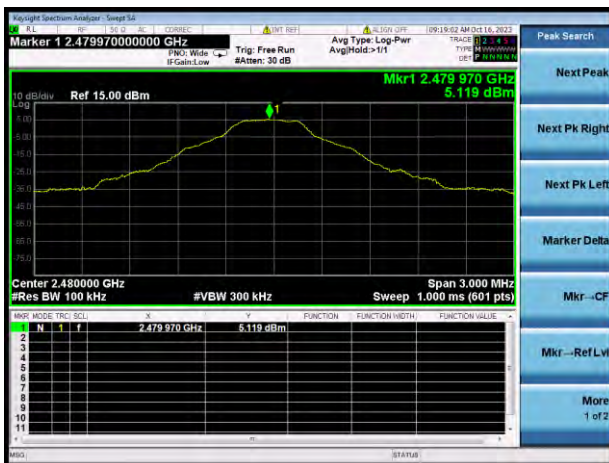

GFSK HIGH CHANNEL, BAND EDGE



GFSK HIGH CHANNEL, SPURIOUS
30 MHz ~ 3 GHz

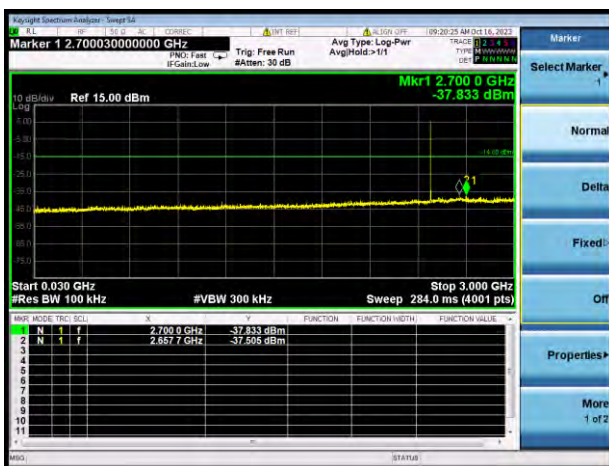

GFSK HIGH CHANNEL, SPURIOUS
3 GHz ~ 25 GHz

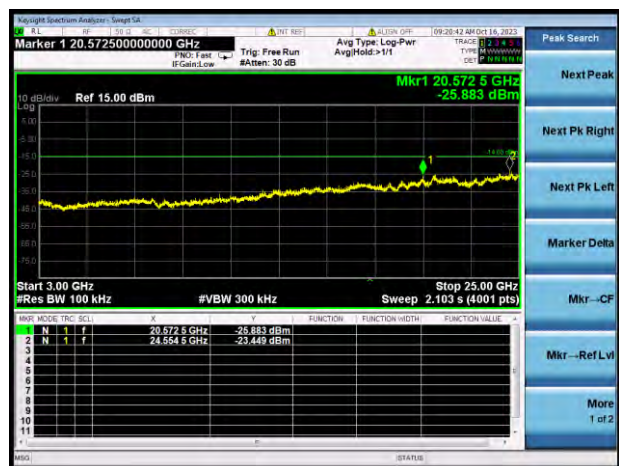

8-DPSK LOW CHANNEL, CARRIER LEVEL

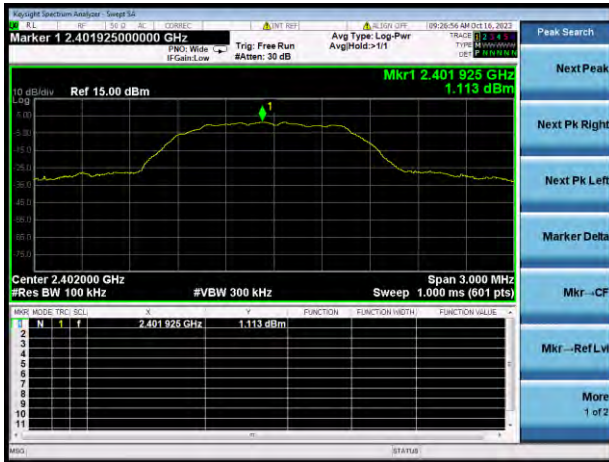

8-DPSK LOW CHANNEL, BAND EDGE



8-DPSK LOW CHANNEL, SPURIOUS

30 MHz ~ 3 GHz



8-DPSK LOW CHANNEL, SPURIOUS

3 GHz ~ 25 GHz

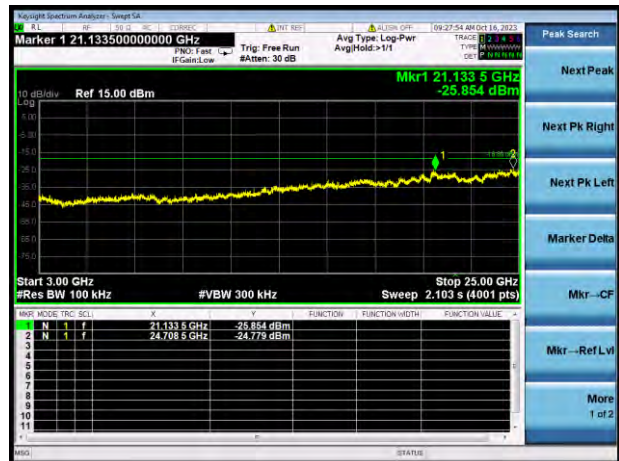

8-DPSK MIDDLE CHANNEL, CARRIER LEVEL

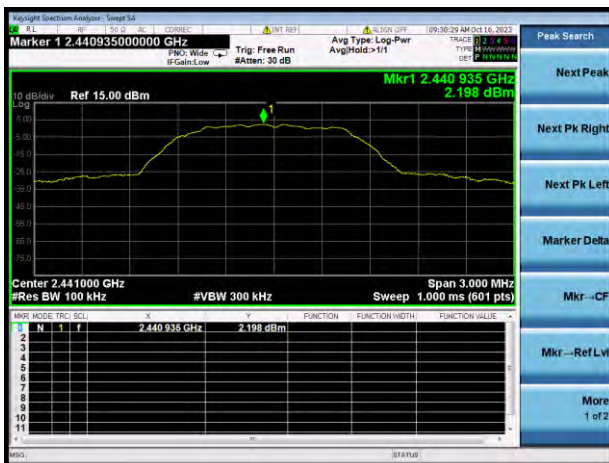

8-DPSK MIDDLE CHANNEL, SPURIOUS
30 MHz ~ 3 GHz

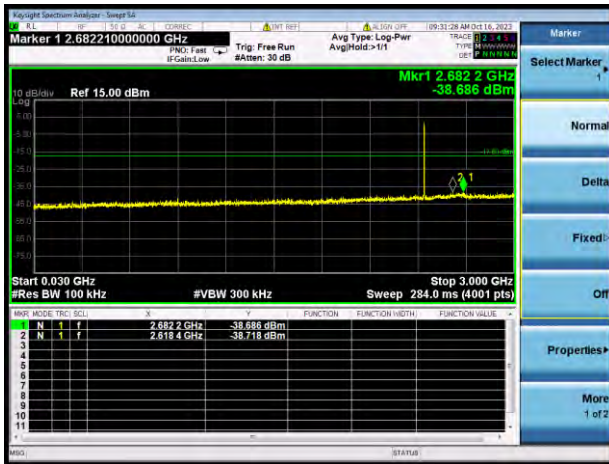

8-DPSK MIDDLE CHANNEL, SPURIOUS
3 GHz ~ 25 GHz



8-DPSK HIGH CHANNEL, CARRIER LEVEL

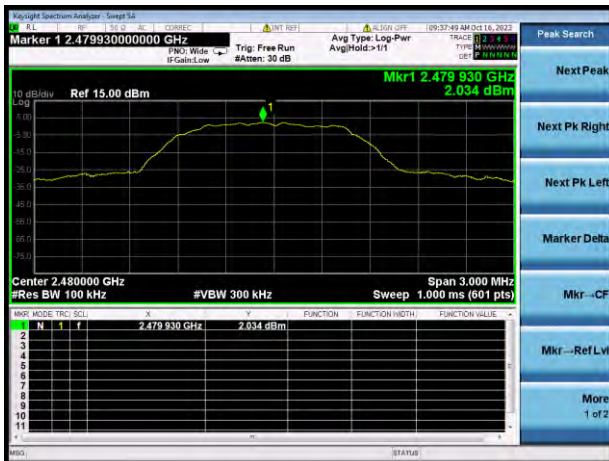

8-DPSK HIGH CHANNEL, BAND EDGE



8-DPSK HIGH CHANNEL, SPURIOUS
30 MHz ~ 3 GHz

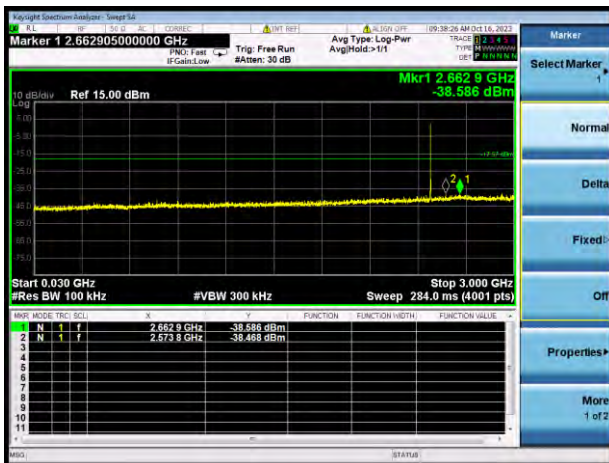

8-DPSK HIGH CHANNEL, SPURIOUS
3 GHz ~ 25 GHz

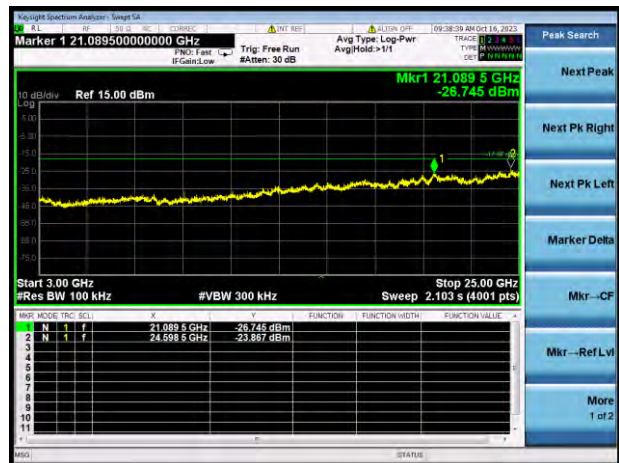

GFSK HOPPING, CARRIER LEVEL

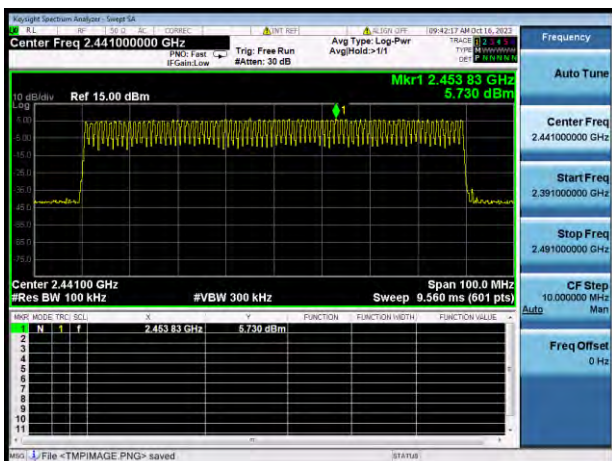

GFSK HOPPING BAND EDGE (LOW)



GFSK HOPPING BAND EDGE (HIGH)



GFSK Hopping Mode, SPURIOUS 30 MHz ~ 3 GHz

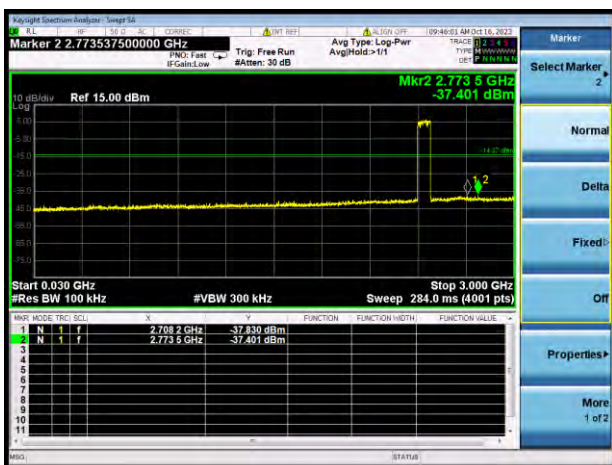

GFSK Hopping Mode, SPURIOUS 3GHz ~ 25 GHz

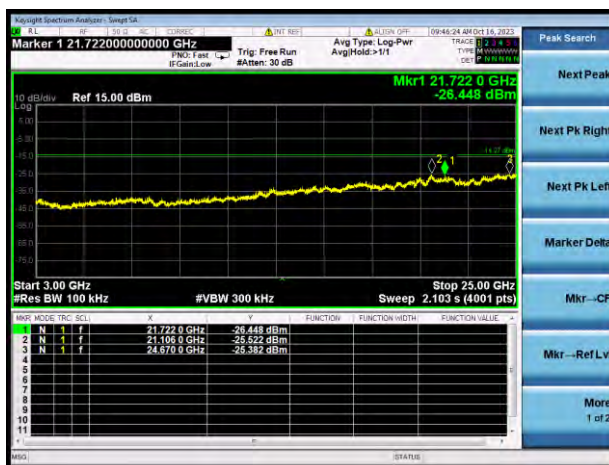

8-DPSK HOPPING, CARRIER LEVEL

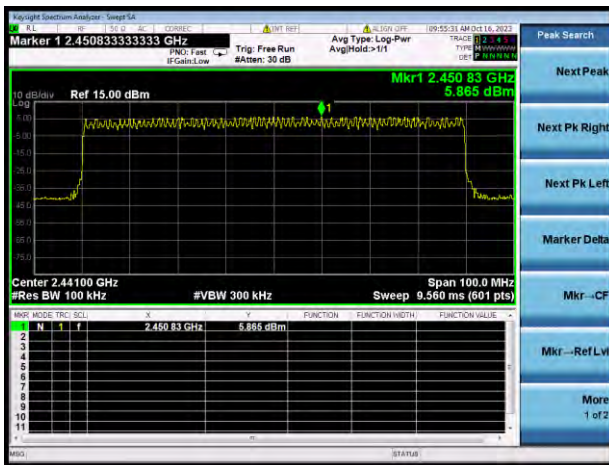

8-DPSK Hopping BAND EDGE (LOW)



8-DPSK Hopping BAND EDGE (HIGH)



8-DPSK Hopping Mode, SPURIOUS
30 MHz ~ 3 GHz

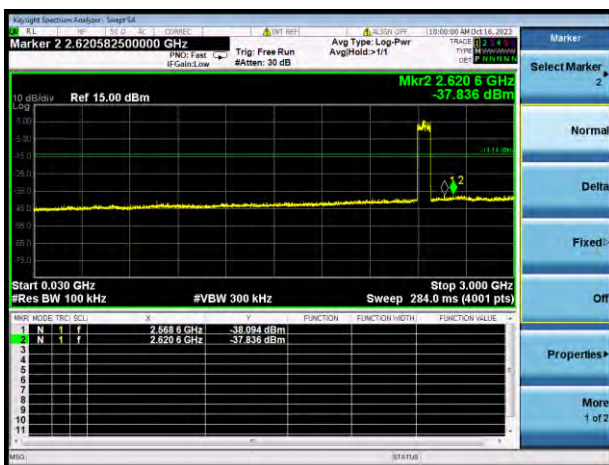

8-DPSK Hopping Mode, SPURIOUS
3GHz ~ 25 GHz



5.9 Conducted Emission

5.9.1 Limit

FCC §15.207

For an intentional radiator that is designed to be connected to the public utility (AC) power line, the radio frequency voltage that is conducted back onto the AC power line on any frequency within the band 150 kHz to 30 MHz shall not exceed the limits in the following table, as measured using a 50 μ H/50 Ω line impedance stabilization network (LISN).

Frequency range (MHz)	Conducted Limit (dB μ V)	
	Quai-peak	Average
0.15 - 0.50	66 to 56	56 to 46
0.50 - 5	56	46
0.50 - 30	60	50

5.9.2 Test Setup

See section 4.5.2 for test setup description for the AC power supply port. The photo of test setup please refer to ANNEX A.

5.9.3 Test Procedure

The maximum conducted interference is searched using Peak (PK), if the emission levels more than the AV and QP limits, and that have narrow margins from the AV and QP limits will be re-measured with AV and QP detectors. Tests for both L phase and N phase lines of the power mains connected to the EUT are performed. Refer to recorded points and plots below.

Devices subject to Part 15 must be tested for all available U.S. voltages and frequencies (such as a nominal 120 VAC, 50/60 Hz and 240 VAC, 50/60 Hz) for which the device is capable of operation. A device rated for 50/60 Hz operation need not be tested at both frequencies provided the radiated and line conducted emissions are the same at both frequencies.

5.9.4 Test Result

Note ¹: The EUT was tested in connected the host and Bluetooth headset play 1kHz mode.

Note ²: Devices subject to Part 15 must be tested for all available U.S. voltages and frequencies (such as a nominal 120 VAC, 60 Hz and 240 VAC, 50 Hz) for which the device is capable of operation. So, The configuration 120 VAC, 60 Hz and 240 VAC, 50 Hz were tested respectively, but only the worst configuration (120 VAC, 60 Hz) shown here.

Note ³: Results (dBuV) = Original reading level of Spectrum Analyzer (dBuV) + Factor (dB)

Test Data and Plots

PHASE L

CE Test case_FCC_CE_FCC PART 15C

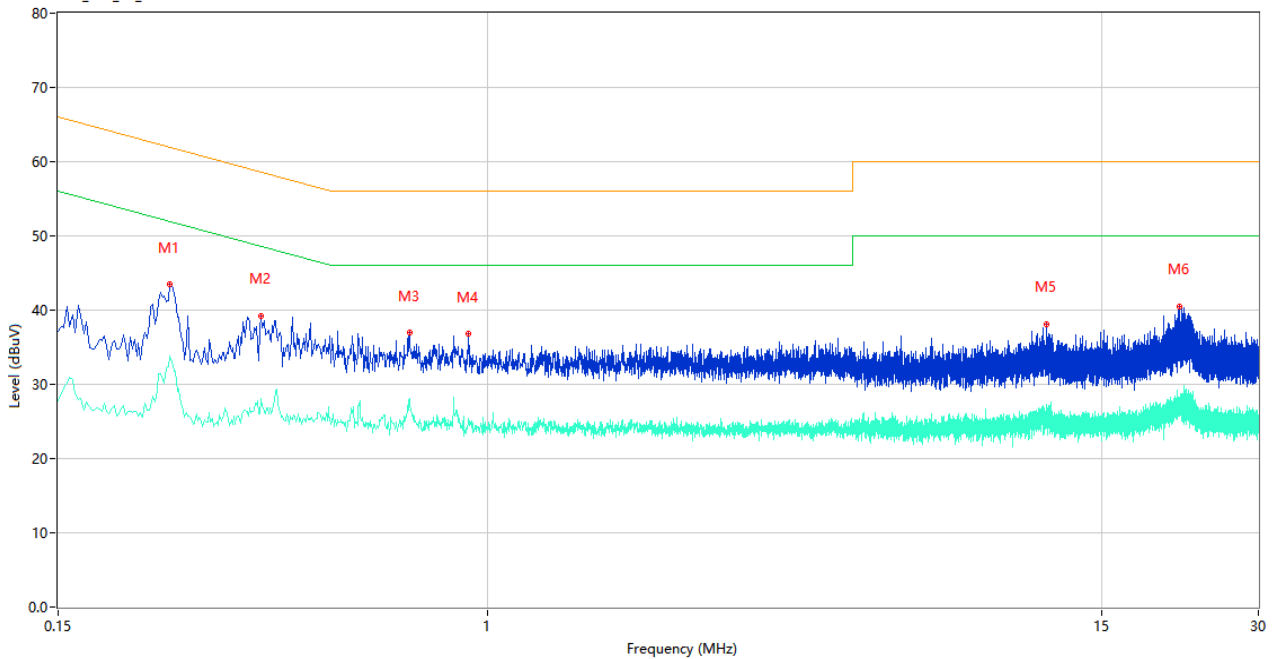

No.	Frequency (MHz)	Results (dBuV)	Factor (dB)	Limit (dBuV)	Margin (dB)	Detector	Line	Verdict
1	0.246	43.48	9.77	61.89	18.41	Peak	L	Pass
1**	0.246	33.85	9.77	51.89	18.04	AV	L	Pass
2	0.368	39.24	10.69	58.55	19.31	Peak	L	Pass
2**	0.368	28.04	10.69	48.55	20.51	AV	L	Pass
3	0.708	36.95	10.57	56.00	19.05	Peak	L	Pass
3**	0.708	28.17	10.57	46.00	17.83	AV	L	Pass
4	0.918	36.76	10.13	56.00	19.24	Peak	L	Pass
4**	0.918	25.33	10.13	46.00	20.67	AV	L	Pass
5	11.792	38.04	10.42	60.00	21.96	Peak	L	Pass
5**	11.792	24.53	10.42	50.00	25.47	AV	L	Pass
6	21.230	40.53	10.98	60.00	19.47	Peak	L	Pass
6**	21.230	28.30	10.98	50.00	21.70	AV	L	Pass

PHASE N

CE Test case_FCC_CE_FCC PART 15B_Class B

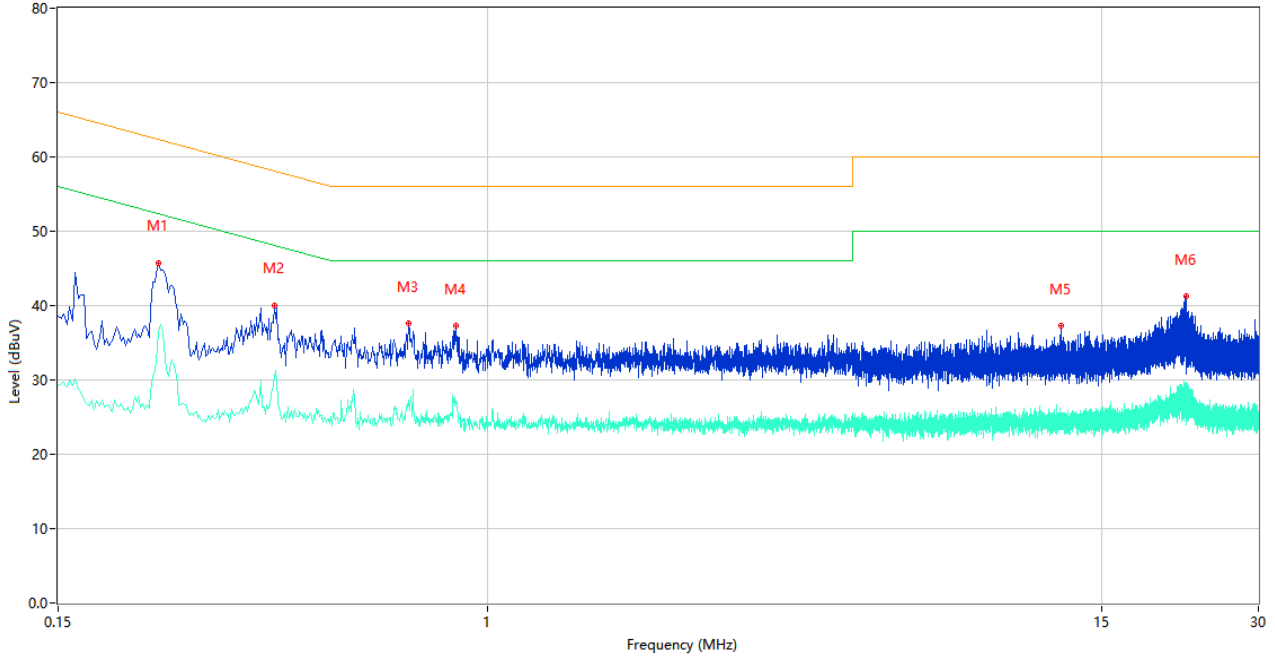

No.	Frequency (MHz)	Results (dBuV)	Factor (dB)	Limit (dBuV)	Margin (dB)	Detector	Line	Verdict
1	0.234	45.70	9.77	62.31	16.61	Peak	N	Pass
1**	0.234	36.55	9.77	52.31	15.76	AV	N	Pass
2	0.390	40.01	10.60	58.06	18.05	Peak	N	Pass
2**	0.390	30.43	10.60	48.06	17.63	AV	N	Pass
3	0.704	37.55	10.61	56.00	18.45	Peak	N	Pass
3**	0.704	27.25	10.61	46.00	18.75	AV	N	Pass
4	0.868	37.26	10.45	56.00	18.74	Peak	N	Pass
4**	0.868	26.85	10.45	46.00	19.15	AV	N	Pass
5	12.558	37.24	10.68	60.00	22.76	Peak	N	Pass
5**	12.558	24.60	10.68	50.00	25.40	AV	N	Pass
6	21.852	41.26	10.81	60.00	18.74	Peak	N	Pass
6**	21.852	27.49	10.81	50.00	22.51	AV	N	Pass

5.10 Radiated Spurious Emission

5.10.1 Limit

FCC §15.209&15.247(d)

Radiated emission outside the frequency band attenuation below the general limits specified in FCC section 15.209(a) is not required. In addition, radiated emissions which fall in the restricted bands, as defined in FCC section 15.205(a), must also comply with the radiated emission limits specified in FCC section 15.209(a).

According to FCC section 15.209 (a), except as provided elsewhere in this subpart, the emissions from an intentional radiator shall not exceed the field strength levels specified in the following table:

Frequency (MHz)	Field Strength ($\mu\text{V}/\text{m}$)	Measurement Distance (m)
0.009 - 0.490	2400/F(kHz)	300
0.490 - 1.705	24000/F(kHz)	30
1.705 - 30.0	30	30
30 - 88	100	3
88 - 216	150	3
216 - 960	200	3
Above 960	500	3

Note:

1. Field Strength (dB $\mu\text{V}/\text{m}$) = 20*log[Field Strength ($\mu\text{V}/\text{m}$)].
2. In the emission tables above, the tighter limit applies at the band edges.
3. For Above 1000 MHz, the emission limit in this paragraph is based on measurement instrumentation employing an average detector, measurement using instrumentation with a peak detector function, corresponding to 20dB above the maximum permitted average limit.
4. For above 1000 MHz, limit field strength of harmonics: 54dBuV/m@3m (AV) and 74dBuV/m@3m (PK).

5.10.2 Test Setup

See section 4.5.3 to 4.5.5 for test setup description for the antenna port. The photo of test setup please refer to ANNEX A.

5.10.3 Test Procedure

The measurement frequency range is from 9 kHz to the 10th harmonic of the fundamental frequency. The Turn Table is actuated to turn from 0° to 360°, and both horizontal and vertical polarizations of the Test Antenna are used to find the maximum radiated power. Mid channels on all channel bandwidth verified. Only the worst RB size/offset presented.

The power of the EUT transmitting frequency should be ignored.

All Spurious Emission tests were performed in X, Y, Z axis direction. And only the worst axis test condition was recorded in this test report.

Use the following spectrum analyzer settings:

Span = wide enough to fully capture the emission being measured

RBW = 1 MHz for $f \geq 1$ GHz, 100 kHz for $f < 1$ GHz

VBW \geq RBW

Sweep = auto

Detector function = peak

Trace = max hold

For measurement below 1GHz, If the emission level of the EUT measured by the peak detector is 3 dB lower than the applicable limit, the peak emission level will be reported, Otherwise, the emission measurement will be repeated using the quasi-peak detector and reported.

5.10.4 Test Result

Note ¹: The symbol of "--" in the table which means not application.

Note ²: For the test data above 1 GHz, according the ANSI C63.10-2013, where limits are specified for both average and peak (or quasi-peak) detector functions, if the peak (or quasi-peak) measured value complies with the average limit, it is unnecessary to perform an average measurement.

Note ³: The EUT was tested in connected the host and Bluetooth headset play 1kHz mode.

Note ⁴: Results (dBuV/m) = Original reading level of Spectrum Analyzer (dBuV/m) + Factor (dB)

The low frequency, which started from 9 kHz to 30 MHz, was pre-scanned and the result which was 20 dB lower than the limit line per 15.31(o) was not reported.

Test Data and Plots

30 MHz to 1 GHz, ANT H

RE Test case_FCC Part 15C_FCC 15C 30MHz-1GHz

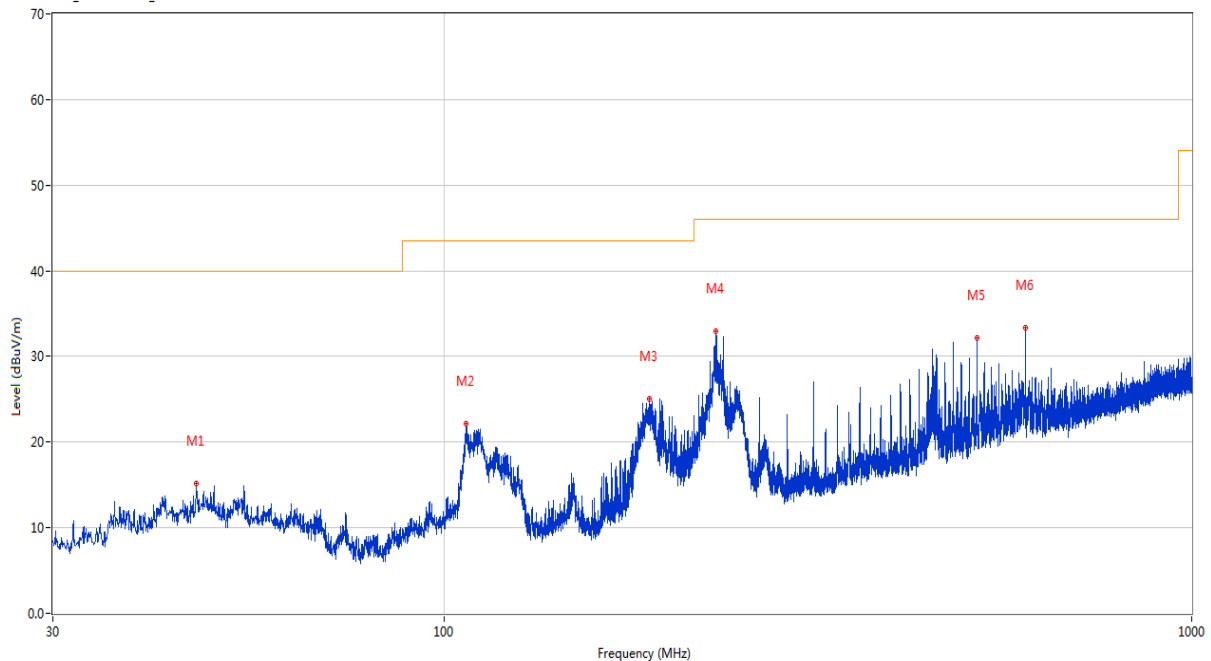

No.	Frequency (MHz)	Results (dBuV/m)	Factor (dB)	Limit (dBuV/m)	Margin (dB)	Detector	Table (Degree)	Height (cm)	Antenna	Verdict
1	46.684	15.19	-22.93	40.0	24.81	Peak	325.50	100	Horizontal	Pass
2	107.115	22.10	-24.20	43.5	21.40	Peak	231.80	100	Horizontal	Pass
3	188.304	25.09	-25.37	43.5	18.41	Peak	68.00	100	Horizontal	Pass
4	230.887	32.97	-23.37	46.0	13.03	Peak	54.00	100	Horizontal	Pass
5	515.922	32.18	-16.43	46.0	13.82	Peak	39.60	100	Horizontal	Pass
6	600.020	33.30	-14.57	46.0	12.70	Peak	200.40	100	Horizontal	Pass

30 MHz to 1 GHz, ANT V

RE Test case_FCC Part 15C_FCC 15C 30MHz-1GHz

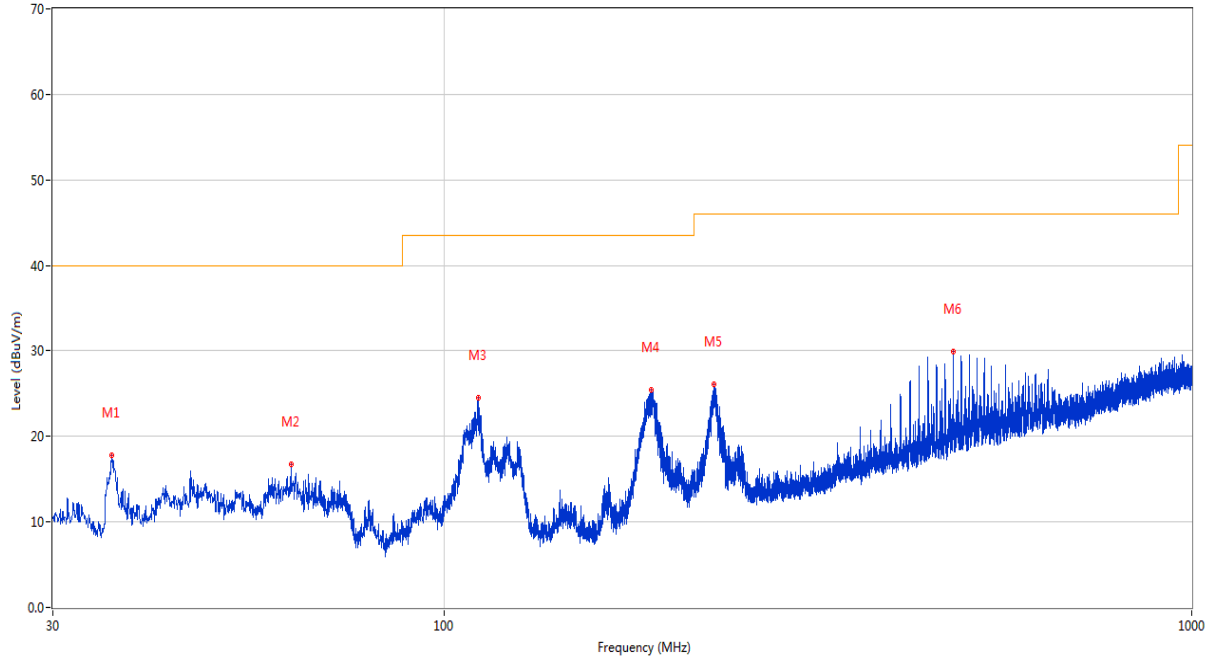

No.	Frequency (MHz)	Results (dBuV/m)	Factor (dB)	Limit (dBuV/m)	Margin (dB)	Detector	Table (Degree)	Height (cm)	Antenna	Verdict
1	35.965	17.82	-25.01	40.0	22.18	Peak	21.20	100	Vertical	Pass
2	62.544	16.80	-24.70	40.0	23.20	Peak	349.80	100	Vertical	Pass
3	111.092	24.56	-24.50	43.5	18.94	Peak	5.00	200	Vertical	Pass
4	189.516	25.47	-25.27	43.5	18.03	Peak	271.70	100	Vertical	Pass
5	229.529	26.11	-23.45	46.0	19.89	Peak	104.50	100	Vertical	Pass
6	479.886	29.96	-17.00	46.0	16.04	Peak	148.70	200	Vertical	Pass

Note 1: The marked spikes near 2400 MHz with circle should be ignored because they are Fundamental signal.

Note 2: The spurious from 18GHz-25GHz is noise only, do not show on the report.

GFSK LOW CHANNEL 1 GHz to 18 GHz, ANT H

RE Test case_FCC Part 15C_FCC 15.247(2.4G)_1GHz-18GHz

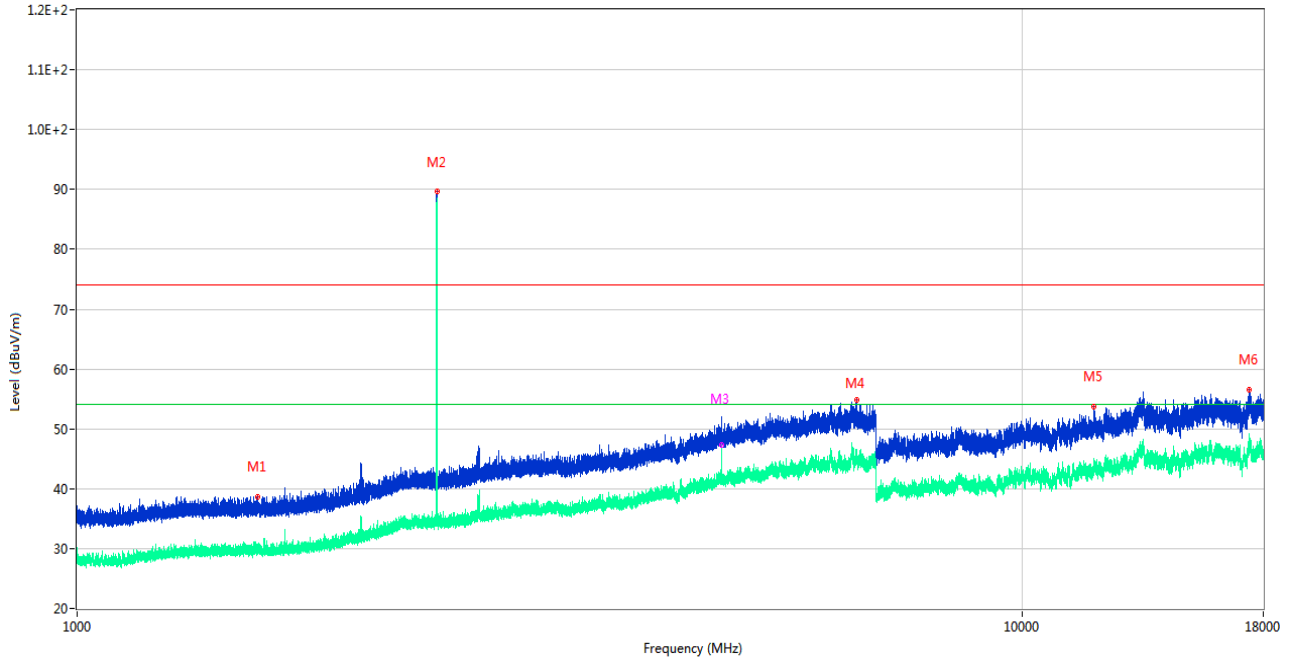

No.	Frequency (MHz)	Results (dBuV/m)	Factor (dB)	Limit (dBuV/m)	Margin (dB)	Detector	Table (Degree)	Height (cm)	Antenna	Verdict
1	1552.800	38.74	-17.36	74.0	35.26	Peak	285.00	300	Horizontal	Pass
1**	1552.800	30.37	-17.36	54.0	23.63	AV	285.00	300	Horizontal	Pass
2	2402.100	89.62	-12.44	74.0	-15.62	Peak	105.00	200	Horizontal	N/A
2**	2402.100	88.57	-12.44	54.0	-34.57	AV	105.00	200	Horizontal	N/A
3	4804.200	51.19	-3.16	74.0	22.81	Peak	63.00	150	Horizontal	Pass
3**	4804.200	47.35	-3.16	54.0	6.65	AV	63.00	150	Horizontal	Pass
4	6683.400	54.78	0.11	74.0	19.22	Peak	238.00	300	Horizontal	Pass
4**	6683.400	45.46	0.11	54.0	8.54	AV	238.00	300	Horizontal	Pass
5	11910.787	53.79	1.52	74.0	20.21	Peak	242.00	400	Horizontal	Pass
5**	11910.787	43.55	1.52	54.0	10.45	AV	242.00	400	Horizontal	Pass
6	17399.663	56.54	3.17	74.0	17.46	Peak	360.00	100	Horizontal	Pass
6**	17399.663	47.12	3.17	54.0	6.88	AV	360.00	100	Horizontal	Pass

GFSK LOW CHANNEL 1 GHz to 18 GHz, ANT V

RE Test case_FCC Part 15C_FCC 15.247(2.4G)_1GHz-18GHz

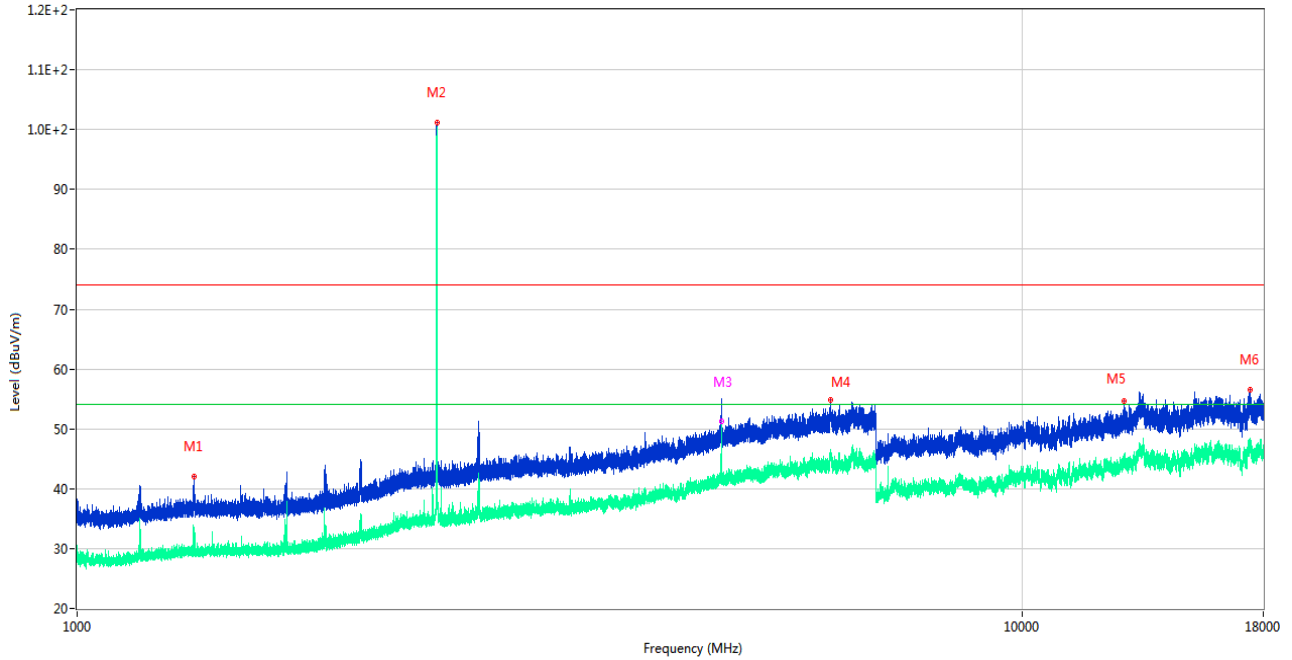

No.	Frequency (MHz)	Results (dBuV/m)	Factor (dB)	Limit (dBuV/m)	Margin (dB)	Detector	Table (Degree)	Height (cm)	Antenna	Verdict
1	1330.400	42.08	-17.48	74.0	31.92	Peak	107.00	200	Vertical	Pass
1**	1330.400	33.13	-17.48	54.0	20.87	AV	107.00	200	Vertical	Pass
2	2402.000	101.24	-12.46	74.0	-27.24	Peak	132.00	200	Vertical	N/A
2**	2402.000	99.94	-12.46	54.0	-45.94	AV	132.00	200	Vertical	N/A
3	4804.200	53.77	-3.16	74.0	20.23	Peak	134.00	150	Vertical	Pass
3**	4804.200	50.88	-3.16	54.0	3.12	AV	134.00	150	Vertical	Pass
4	6271.200	54.89	0.53	74.0	19.11	Peak	90.00	400	Vertical	Pass
4**	6271.200	45.61	0.53	54.0	8.39	AV	90.00	400	Vertical	Pass
5	12815.625	54.73	0.85	74.0	19.27	Peak	345.00	200	Vertical	Pass
5**	12815.625	44.43	0.85	54.0	9.57	AV	345.00	200	Vertical	Pass
6	17450.850	56.62	2.83	74.0	17.38	Peak	345.00	400	Vertical	Pass
6**	17450.850	46.31	2.83	54.0	7.69	AV	345.00	400	Vertical	Pass

GFSK MIDDLE CHANNEL 1 GHz to 18 GHz, ANT H

RE Test case_FCC Part 15C_FCC 15.247(2.4G)_1GHz-18GHz

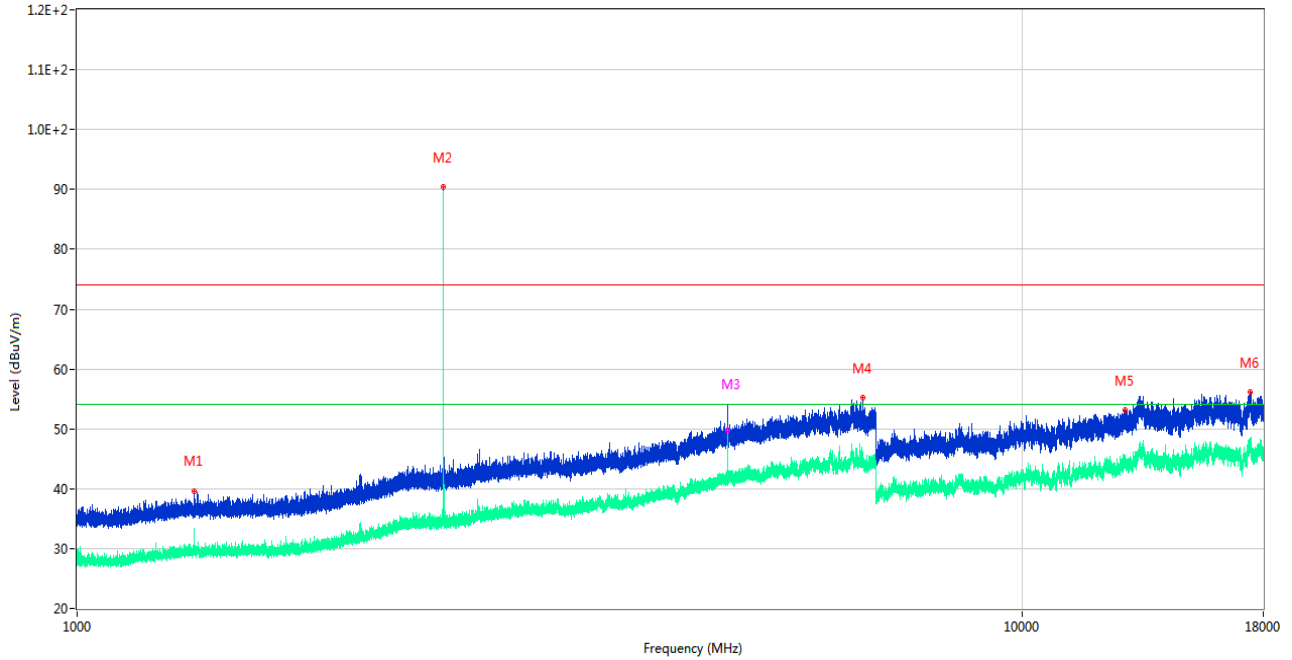

No.	Frequency (MHz)	Results (dBuV/m)	Factor (dB)	Limit (dBuV/m)	Margin (dB)	Detector	Table (Degree)	Height (cm)	Antenna	Verdict
1	1329.500	39.58	-17.58	74.0	34.42	Peak	28.00	400	Horizontal	Pass
1**	1329.500	30.13	-17.58	54.0	23.87	AV	28.00	400	Horizontal	Pass
2	2440.900	90.35	-12.43	74.0	-16.35	Peak	108.00	200	Horizontal	N/A
2**	2440.900	88.93	-12.43	54.0	-34.93	AV	108.00	200	Horizontal	N/A
3	4881.800	52.74	-3.39	74.0	21.26	Peak	44.00	150	Horizontal	Pass
3**	4881.800	49.83	-3.39	54.0	4.17	AV	44.00	150	Horizontal	Pass
4	6778.000	55.13	0.22	74.0	18.87	Peak	83.00	200	Horizontal	Pass
4**	6778.000	45.00	0.22	54.0	9.00	AV	83.00	200	Horizontal	Pass
5	12858.150	53.10	1.44	74.0	20.90	Peak	323.00	400	Horizontal	Pass
5**	12858.150	44.13	1.44	54.0	9.87	AV	323.00	400	Horizontal	Pass
6	17452.950	56.08	2.83	74.0	17.92	Peak	7.00	100	Horizontal	Pass
6**	17452.950	46.16	2.83	54.0	7.84	AV	7.00	100	Horizontal	Pass

GFSK MIDDLE CHANNEL 1 GHz to 18 GHz, ANT V

RE Test case_FCC Part 15C_FCC 15.247(2.4G)_1GHz-18GHz

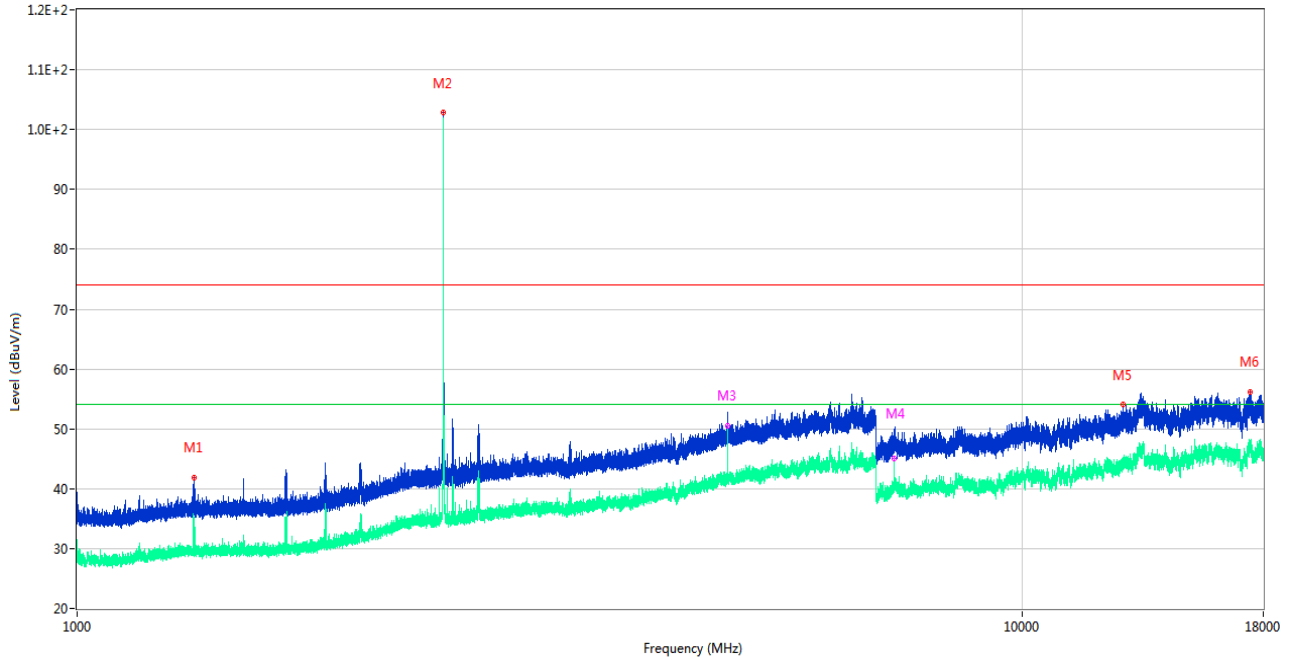

No.	Frequency (MHz)	Results (dBuV/m)	Factor (dB)	Limit (dBuV/m)	Margin (dB)	Detector	Table (Degree)	Height (cm)	Antenna	Verdict
1	1328.600	41.89	-17.68	74.0	32.11	Peak	20.00	100	Vertical	Pass
1**	1328.600	35.05	-17.68	54.0	18.95	AV	20.00	100	Vertical	Pass
2	2441.000	102.78	-12.44	74.0	-28.78	Peak	136.00	200	Vertical	N/A
2**	2441.000	101.93	-12.44	54.0	-47.93	AV	136.00	200	Vertical	N/A
3	4882.000	54.74	-3.40	74.0	19.26	Peak	265.00	150	Vertical	Pass
3**	4882.000	50.54	-3.40	54.0	3.46	AV	265.00	150	Vertical	Pass
4	7322.862	49.51	-3.61	74.0	24.49	Peak	187.00	150	Vertical	Pass
4**	7322.862	45.07	-3.61	54.0	8.93	AV	187.00	150	Vertical	Pass
5	12792.001	54.04	1.17	74.0	19.96	Peak	218.00	400	Vertical	Pass
5**	12792.001	44.02	1.17	54.0	9.98	AV	218.00	400	Vertical	Pass
6	17435.888	56.25	3.22	74.0	17.75	Peak	339.00	200	Vertical	Pass
6**	17435.888	46.69	3.22	54.0	7.31	AV	339.00	200	Vertical	Pass

GFSK HIGH CHANNEL 1 GHz to 18 GHz, ANT H

RE Test case_FCC Part 15C_FCC 15.247(2.4G)_1GHz-18GHz

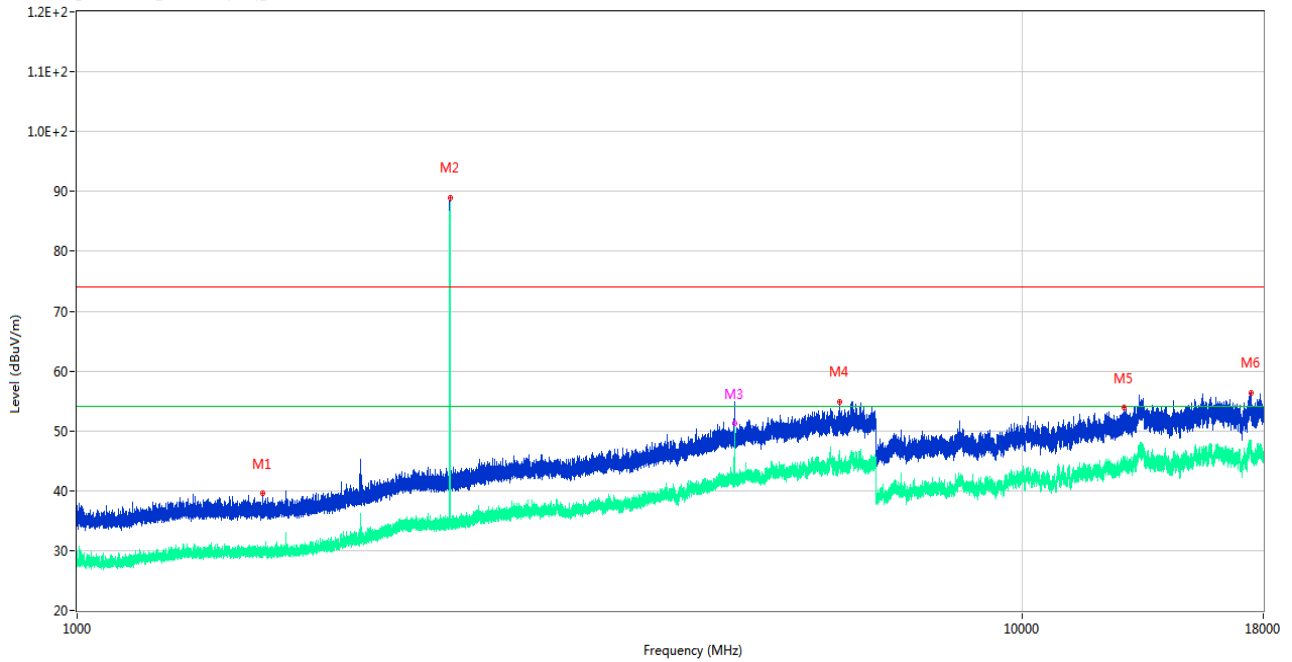

No.	Frequency (MHz)	Results (dBuV/m)	Factor (dB)	Limit (dBuV/m)	Margin (dB)	Detector	Table (Degree)	Height (cm)	Antenna	Verdict
1	1573.500	39.55	-17.59	74.0	34.45	Peak	284.00	400	Horizontal	Pass
1**	1573.500	29.73	-17.59	54.0	24.27	AV	284.00	400	Horizontal	Pass
2	2480.000	88.97	-12.02	74.0	-14.97	Peak	111.00	100	Horizontal	N/A
2**	2480.000	87.75	-12.02	54.0	-33.75	AV	111.00	100	Horizontal	N/A
3	4960.600	52.75	-2.95	74.0	21.25	Peak	62.00	150	Horizontal	Pass
3**	4960.600	50.80	-2.95	54.0	3.20	AV	62.00	150	Horizontal	Pass
4	6406.200	54.90	0.30	74.0	19.10	Peak	28.00	100	Horizontal	Pass
4**	6406.200	45.17	0.30	54.0	8.83	AV	28.00	100	Horizontal	Pass
5	12833.475	53.84	1.22	74.0	20.16	Peak	120.00	200	Horizontal	Pass
5**	12833.475	44.47	1.22	54.0	9.53	AV	120.00	200	Horizontal	Pass
6	17465.287	56.40	2.89	74.0	17.60	Peak	281.00	400	Horizontal	Pass
6**	17465.287	46.63	2.89	54.0	7.37	AV	281.00	400	Horizontal	Pass

GFSK HIGH CHANNEL 1 GHz to 18 GHz, ANT V

RE Test case_FCC Part 15C_FCC 15.247(2.4G)_1GHz-18GHz

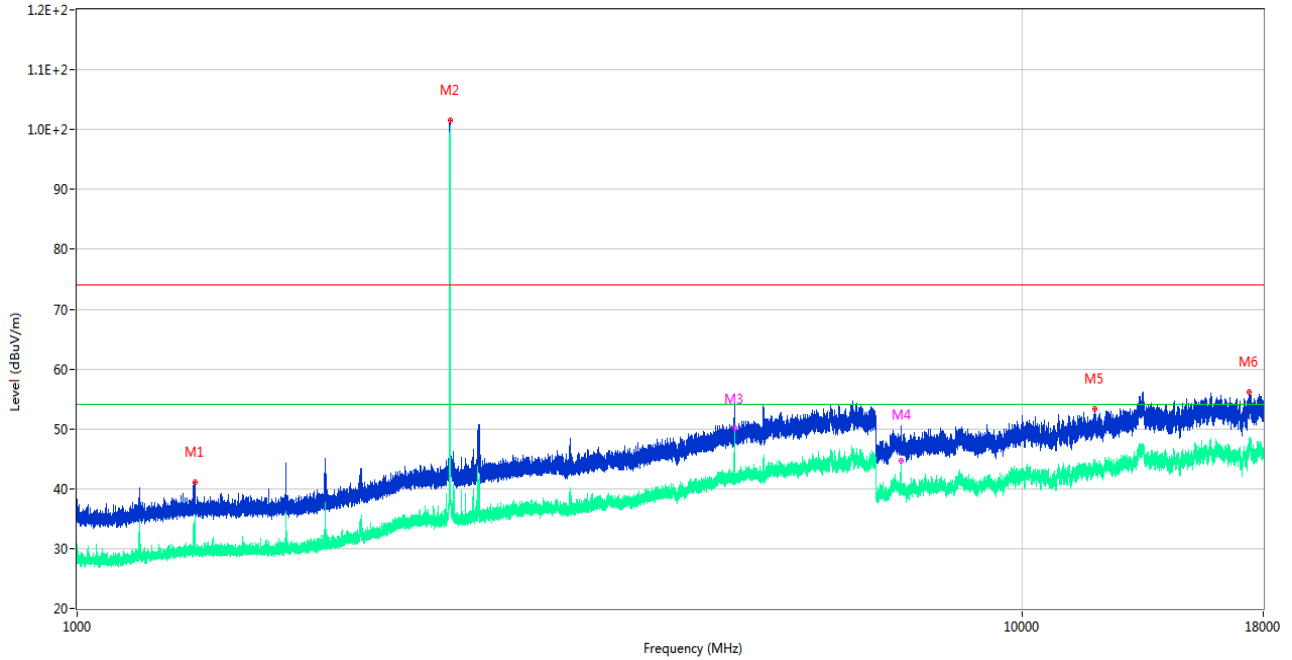

No.	Frequency (MHz)	Results (dBuV/m)	Factor (dB)	Limit (dBuV/m)	Margin (dB)	Detector	Table (Degree)	Height (cm)	Antenna	Verdict
1	1331.900	41.13	-17.51	74.0	32.87	Peak	106.00	200	Vertical	Pass
1**	1331.900	33.26	-17.51	54.0	20.74	AV	106.00	200	Vertical	Pass
2	2480.100	101.55	-12.02	74.0	-27.55	Peak	142.00	100	Vertical	N/A
2**	2480.100	100.29	-12.02	54.0	-46.29	AV	142.00	100	Vertical	N/A
3	4960.000	54.73	-3.00	74.0	19.27	Peak	140.00	150	Vertical	Pass
3**	4960.000	50.17	-3.00	54.0	3.83	AV	140.00	150	Vertical	Pass
4	7439.875	50.44	-3.90	74.0	23.56	Peak	131.00	150	Vertical	Pass
4**	7439.875	44.63	-3.90	54.0	9.37	AV	131.00	150	Vertical	Pass
5	11940.975	53.39	1.66	74.0	20.61	Peak	12.00	200	Vertical	Pass
5**	11940.975	43.30	1.66	54.0	10.70	AV	12.00	200	Vertical	Pass
6	17396.251	56.20	3.05	74.0	17.80	Peak	77.00	400	Vertical	Pass
6**	17396.251	46.47	3.05	54.0	7.53	AV	77.00	400	Vertical	Pass

8-DPSK LOW CHANNEL 1 GHz to 18 GHz, ANT H

RE Test case_FCC Part 15C_FCC 15.247(2.4G)_1GHz-18GHz

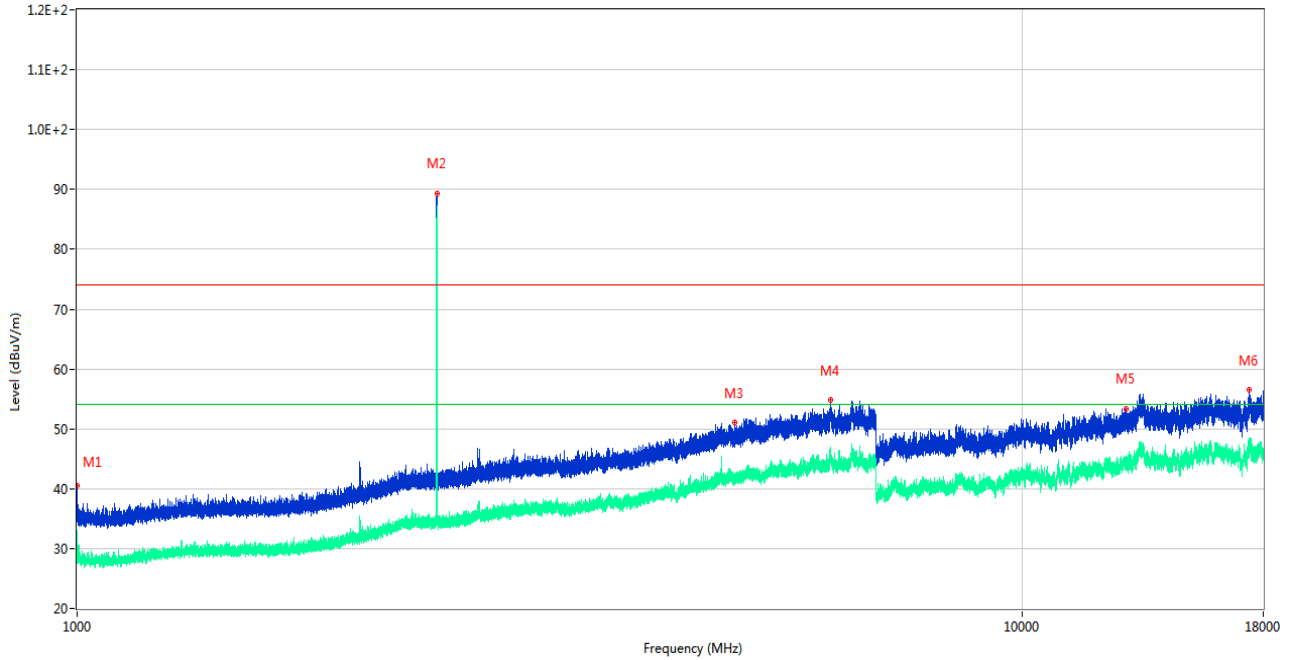

No.	Frequency (MHz)	Results (dBuV/m)	Factor (dB)	Limit (dBuV/m)	Margin (dB)	Detector	Table (Degree)	Height (cm)	Antenna	Verdict
1	1000.400	40.60	-18.20	74.0	33.40	Peak	129.00	300	Horizontal	Pass
1**	1000.400	30.12	-18.20	54.0	23.88	AV	129.00	300	Horizontal	Pass
2	2402.000	89.30	-12.46	74.0	-15.30	Peak	111.00	200	Horizontal	N/A
2**	2402.000	86.20	-12.46	54.0	-32.20	AV	111.00	200	Horizontal	N/A
3	4964.600	51.05	-3.07	74.0	22.95	Peak	0.00	100	Horizontal	Pass
3**	4964.600	41.58	-3.07	54.0	12.42	AV	0.00	100	Horizontal	Pass
4	6272.800	54.78	0.57	74.0	19.22	Peak	272.00	200	Horizontal	Pass
4**	6272.800	46.24	0.57	54.0	7.76	AV	272.00	200	Horizontal	Pass
5	12887.812	53.39	1.57	74.0	20.61	Peak	16.00	300	Horizontal	Pass
5**	12887.812	45.21	1.57	54.0	8.79	AV	16.00	300	Horizontal	Pass
6	17407.801	56.45	3.39	74.0	17.55	Peak	0.00	300	Horizontal	Pass
6**	17407.801	47.04	3.39	54.0	6.96	AV	0.00	300	Horizontal	Pass

8-DPSK LOW CHANNEL 1 GHz to 18 GHz, ANT V

RE Test case_FCC Part 15C_FCC 15.247(2.4G)_1GHz-18GHz

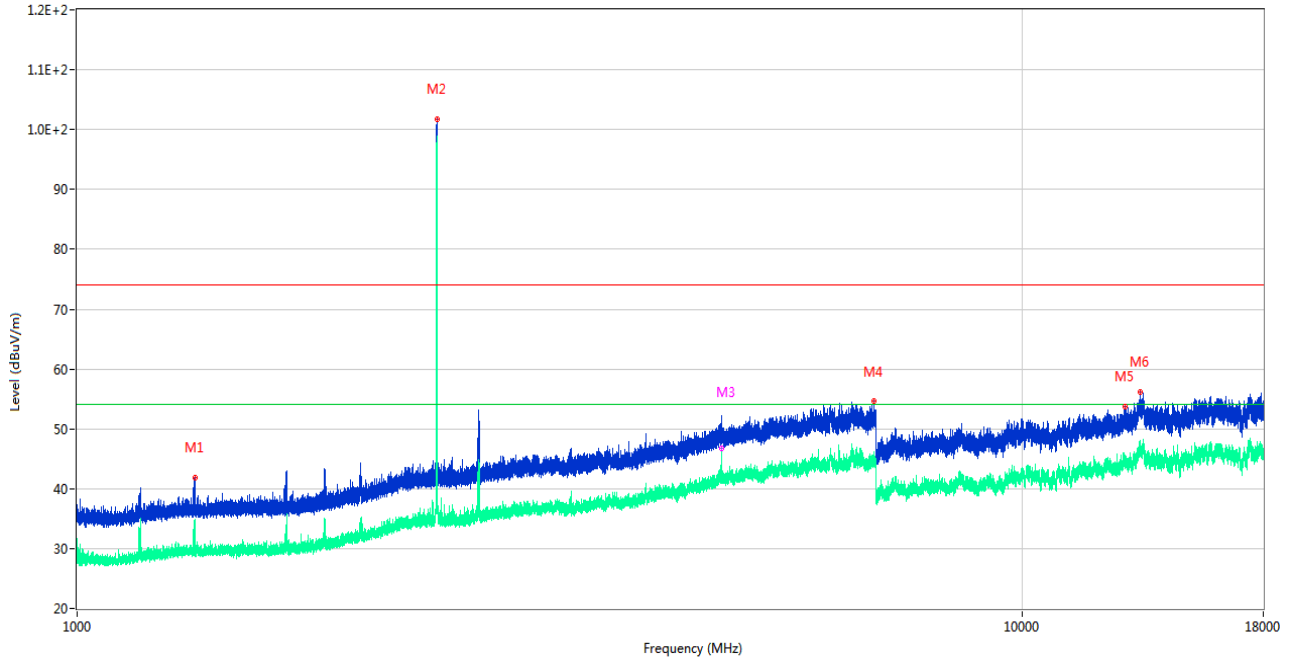

No.	Frequency (MHz)	Results (dBuV/m)	Factor (dB)	Limit (dBuV/m)	Margin (dB)	Detector	Table (Degree)	Height (cm)	Antenna	Verdict
1	1332.600	41.86	-17.52	74.0	32.14	Peak	120.00	300	Vertical	Pass
1**	1332.600	34.83	-17.52	54.0	19.17	AV	120.00	300	Vertical	Pass
2	2401.900	101.76	-12.47	74.0	-27.76	Peak	138.00	200	Vertical	N/A
2**	2401.900	98.80	-12.47	54.0	-44.80	AV	138.00	200	Vertical	N/A
3	4804.200	50.62	-3.16	74.0	23.38	Peak	128.00	150	Vertical	Pass
3**	4804.200	46.73	-3.16	54.0	7.27	AV	128.00	150	Vertical	Pass
4	6967.800	54.62	1.73	74.0	19.38	Peak	259.00	400	Vertical	Pass
4**	6967.800	44.86	1.73	54.0	9.14	AV	259.00	400	Vertical	Pass
5	12861.300	53.76	1.45	74.0	20.24	Peak	182.00	400	Vertical	Pass
5**	12861.300	44.25	1.45	54.0	9.75	AV	182.00	400	Vertical	Pass
6	13329.075	56.18	0.93	74.0	17.82	Peak	360.00	400	Vertical	Pass
6**	13329.075	47.25	0.93	54.0	6.75	AV	360.00	400	Vertical	Pass

8-DPSK MIDDLE CHANNEL 1 GHz to 18 GHz, ANT H

RE Test case_FCC Part 15C_FCC 15.247(2.4G)_1GHz-18GHz

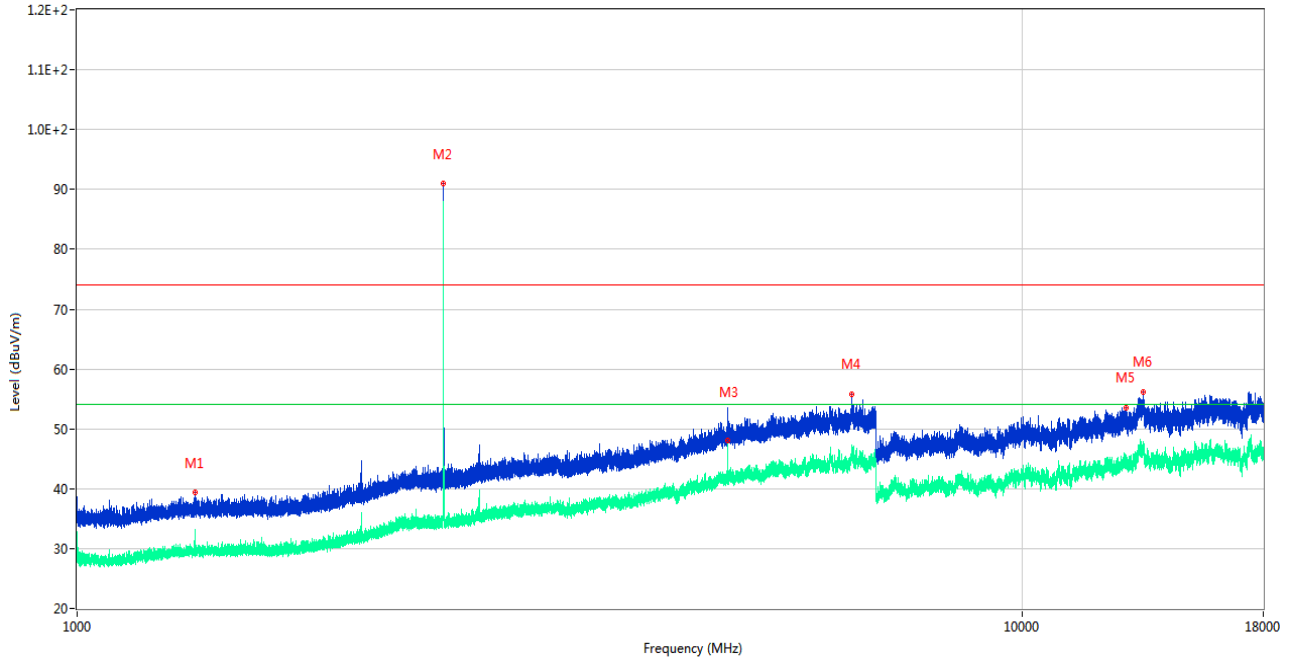

No.	Frequency (MHz)	Results (dBuV/m)	Factor (dB)	Limit (dBuV/m)	Margin (dB)	Detector	Table (Degree)	Height (cm)	Antenna	Verdict
1	1333.100	39.36	-17.51	74.0	34.64	Peak	20.00	400	Horizontal	Pass
1**	1333.100	29.02	-17.51	54.0	24.98	AV	20.00	400	Horizontal	Pass
2	2440.900	90.91	-12.43	74.0	-16.91	Peak	110.00	100	Horizontal	N/A
2**	2440.900	87.77	-12.43	54.0	-33.77	AV	110.00	100	Horizontal	N/A
3	4875.200	48.01	-3.29	74.0	25.99	Peak	271.00	150	Horizontal	Pass
3**	4875.200	42.23	-3.29	54.0	11.77	AV	271.00	150	Horizontal	Pass
4	6609.200	55.80	1.58	74.0	18.20	Peak	225.00	200	Horizontal	Pass
4**	6609.200	46.39	1.58	54.0	7.61	AV	225.00	200	Horizontal	Pass
5	12898.838	53.52	1.50	74.0	20.48	Peak	52.00	400	Horizontal	Pass
5**	12898.838	44.71	1.50	54.0	9.29	AV	52.00	400	Horizontal	Pass
6	13439.062	56.16	0.46	74.0	17.84	Peak	314.00	400	Horizontal	Pass
6**	13439.062	46.16	0.46	54.0	7.84	AV	314.00	400	Horizontal	Pass

8-DPSK MIDDLE CHANNEL 1 GHz to 18 GHz, ANT V

RE Test case_FCC Part 15C_FCC 15.247(2.4G)_1GHz-18GHz

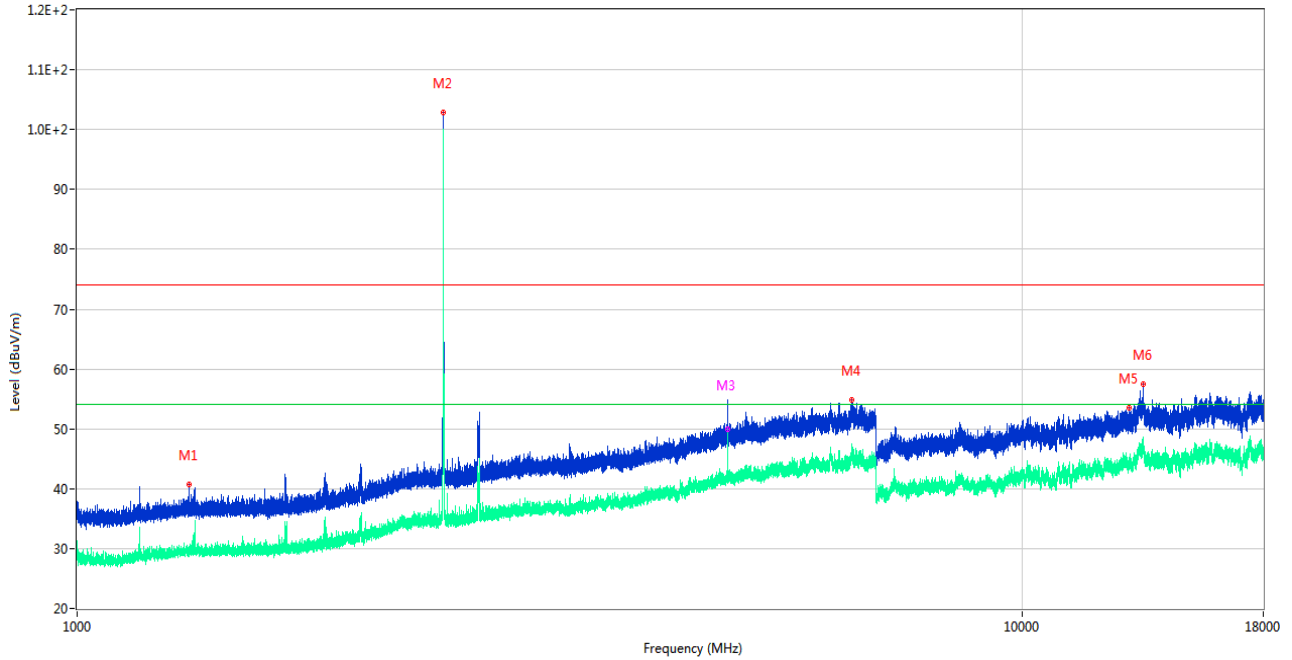

No.	Frequency (MHz)	Results (dBuV/m)	Factor (dB)	Limit (dBuV/m)	Margin (dB)	Detector	Table (Degree)	Height (cm)	Antenna	Verdict
1	1313.000	40.69	-17.41	74.0	33.31	Peak	113.00	100	Vertical	Pass
1**	1313.000	30.15	-17.41	54.0	23.85	AV	113.00	100	Vertical	Pass
2	2441.100	102.83	-12.44	74.0	-28.83	Peak	138.00	100	Vertical	N/A
2**	2441.100	99.98	-12.44	54.0	-45.98	AV	138.00	100	Vertical	N/A
3	4882.000	54.77	-3.40	74.0	19.23	Peak	276.00	150	Vertical	Pass
3**	4882.000	49.95	-3.40	54.0	4.05	AV	276.00	150	Vertical	Pass
4	6607.400	54.76	1.51	74.0	19.24	Peak	145.00	300	Vertical	Pass
4**	6607.400	45.90	1.51	54.0	8.10	AV	145.00	300	Vertical	Pass
5	12996.750	53.44	1.28	74.0	20.56	Peak	34.00	100	Vertical	Pass
5**	12996.750	44.31	1.28	54.0	9.69	AV	34.00	100	Vertical	Pass
6	13444.838	57.46	0.56	74.0	16.54	Peak	305.00	100	Vertical	Pass
6**	13444.838	46.03	0.56	54.0	7.97	AV	305.00	100	Vertical	Pass

8-DPSK HIGH CHANNEL 1 GHz to 18 GHz, ANT H

RE Test case_FCC Part 15C_FCC 15.247(2.4G)_1GHz-18GHz

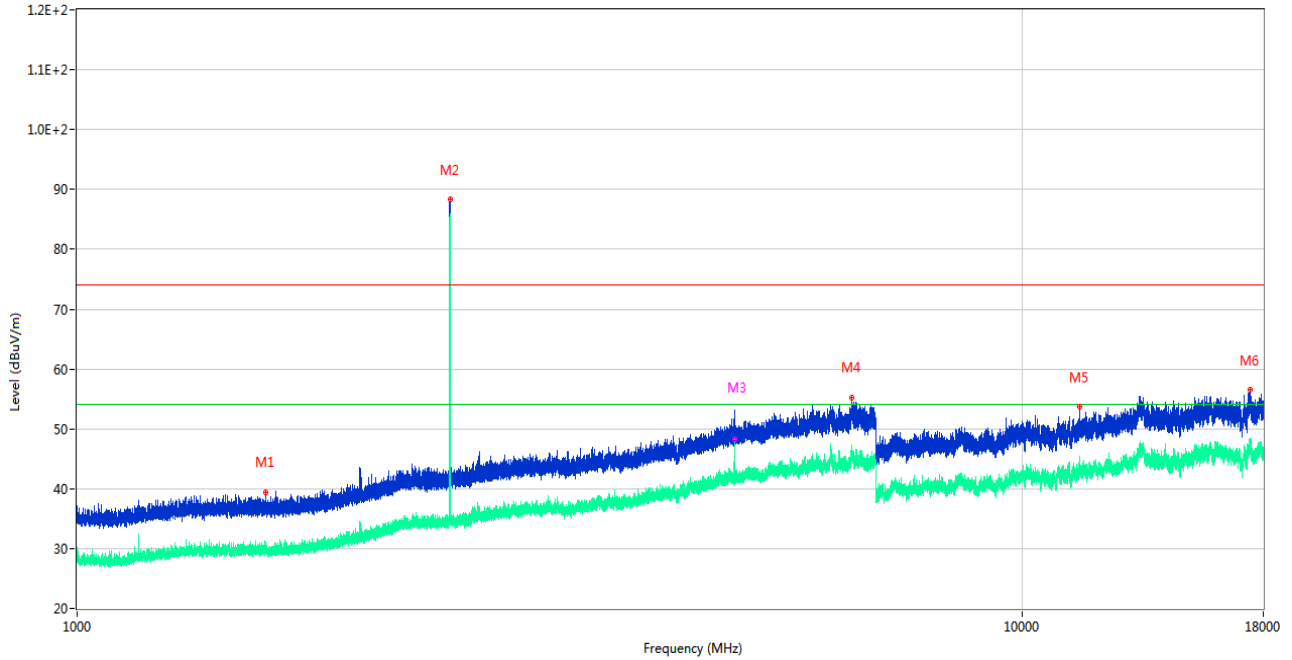

No.	Frequency (MHz)	Results (dBuV/m)	Factor (dB)	Limit (dBuV/m)	Margin (dB)	Detector	Table (Degree)	Height (cm)	Antenna	Verdict
1	1583.000	39.41	-17.42	74.0	34.59	Peak	295.00	400	Horizontal	Pass
1**	1583.000	29.43	-17.42	54.0	24.57	AV	295.00	400	Horizontal	Pass
2	2480.200	88.30	-12.01	74.0	-14.30	Peak	108.00	200	Horizontal	N/A
2**	2480.200	85.33	-12.01	54.0	-31.33	AV	108.00	200	Horizontal	N/A
3	4960.600	51.94	-2.95	74.0	22.06	Peak	63.00	150	Horizontal	Pass
3**	4960.600	48.32	-2.95	54.0	5.68	AV	63.00	150	Horizontal	Pass
4	6602.200	55.25	0.70	74.0	18.75	Peak	309.00	400	Horizontal	Pass
4**	6602.200	45.90	0.70	54.0	8.10	AV	309.00	400	Horizontal	Pass
5	11503.112	53.64	-0.03	74.0	20.36	Peak	81.00	400	Horizontal	Pass
5**	11503.112	43.22	-0.03	54.0	10.78	AV	81.00	400	Horizontal	Pass
6	17418.301	56.49	3.72	74.0	17.51	Peak	142.00	100	Horizontal	Pass
6**	17418.301	47.82	3.72	54.0	6.18	AV	142.00	100	Horizontal	Pass

8-DPSK HIGH CHANNEL 1 GHz to 18 GHz, ANT V

RE Test case_FCC Part 15C_FCC 15.247(2.4G)_1GHz-18GHz

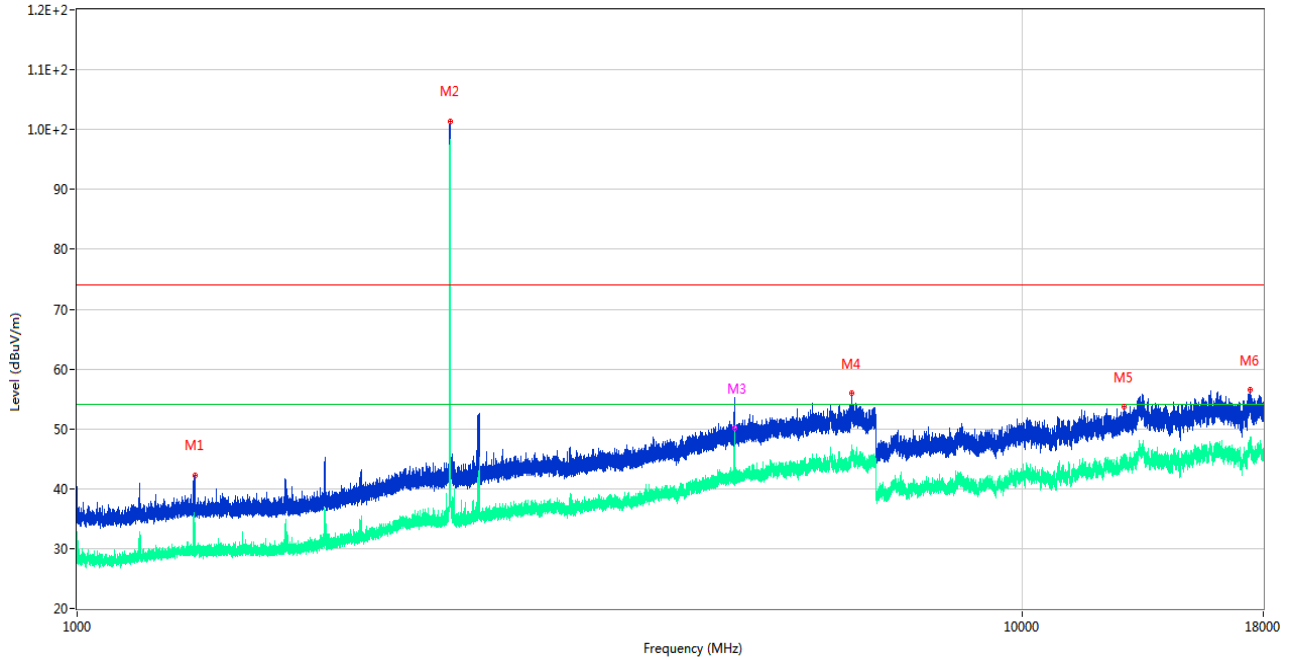

No.	Frequency (MHz)	Results (dBuV/m)	Factor (dB)	Limit (dBuV/m)	Margin (dB)	Detector	Table (Degree)	Height (cm)	Antenna	Verdict
1	1331.800	42.22	-17.50	74.0	31.78	Peak	14.00	100	Vertical	Pass
1**	1331.800	34.35	-17.50	54.0	19.65	AV	14.00	100	Vertical	Pass
2	2479.900	101.41	-12.03	74.0	-27.41	Peak	145.00	100	Vertical	N/A
2**	2479.900	98.05	-12.03	54.0	-44.05	AV	145.00	100	Vertical	N/A
3	4960.400	53.66	-2.97	74.0	20.34	Peak	360.00	150	Vertical	Pass
3**	4960.400	50.11	-2.97	54.0	3.89	AV	360.00	150	Vertical	Pass
4	6607.800	55.89	1.53	74.0	18.11	Peak	177.00	300	Vertical	Pass
4**	6607.800	47.21	1.53	54.0	6.79	AV	177.00	300	Vertical	Pass
5	12808.013	53.62	0.88	74.0	20.38	Peak	343.00	400	Vertical	Pass
5**	12808.013	45.13	0.88	54.0	8.87	AV	343.00	400	Vertical	Pass
6	17438.775	56.45	3.08	74.0	17.55	Peak	48.00	100	Vertical	Pass
6**	17438.775	48.62	3.08	54.0	5.38	AV	48.00	100	Vertical	Pass

5.11 Band Edge (Restricted-band band-edge)

5.11.1 Limit

FCC §15.209&15.247(d)

Radiated emission outside the frequency band attenuation below the general limits specified in FCC section 15.209(a) is not required. In addition, radiated emissions which fall in the restricted bands, as defined in FCC section 15.205(a), must also comply with the radiated emission limits specified in FCC section 15.209(a).

5.11.2 Test Setup

See section 4.5.3 to 4.5.5 for test setup description for the antenna port. The photo of test setup please refer to ANNEX A.

5.11.3 Test Procedure

The measurement frequency range is from 9 kHz to the 10th harmonic of the fundamental frequency. The Turn Table is actuated to turn from 0° to 360°, and both horizontal and vertical polarizations of the Test Antenna are used to find the maximum radiated power. Mid channels on all channel bandwidth verified. Only the worst RB size/offset presented.

The power of the EUT transmitting frequency should be ignored.

All Spurious Emission tests were performed in X, Y, Z axis direction. And only the worst axis test condition was recorded in this test report.

Use the following spectrum analyzer settings:

Span = wide enough to fully capture the emission being measured

RBW = 1 MHz for $f \geq 1$ GHz, 100 kHz for $f < 1$ GHz

VBW \geq RBW

Sweep = auto

Detector function = peak

Trace = max hold

For measurement below 1GHz, If the emission level of the EUT measured by the peak detector is 3 dB lower than the applicable limit, the peak emission level will be reported, Otherwise, the emission measurement will be repeated using the quasi-peak detector and reported.

5.11.4 Test Result

Note ¹: The lowest and highest channels are tested to verify the band edge emissions. Please refer to the following the plots for emissions values.

Note ²: The test data all are tested in the vertical and horizontal antenna which the trace is max hold. So these plots have shown the worst case.

Note ³: According the ANSI C63.10-2013, where limits are specified for both average and peak (or quasi-peak) detector functions, if the peak (or quasi-peak) measured value complies with the average limit, it is unnecessary to perform an average measurement.

Note ⁴: The Level (dBuV/m) has been corrected by factor.

Test Data and Plots

GFSK LOW CHANNEL

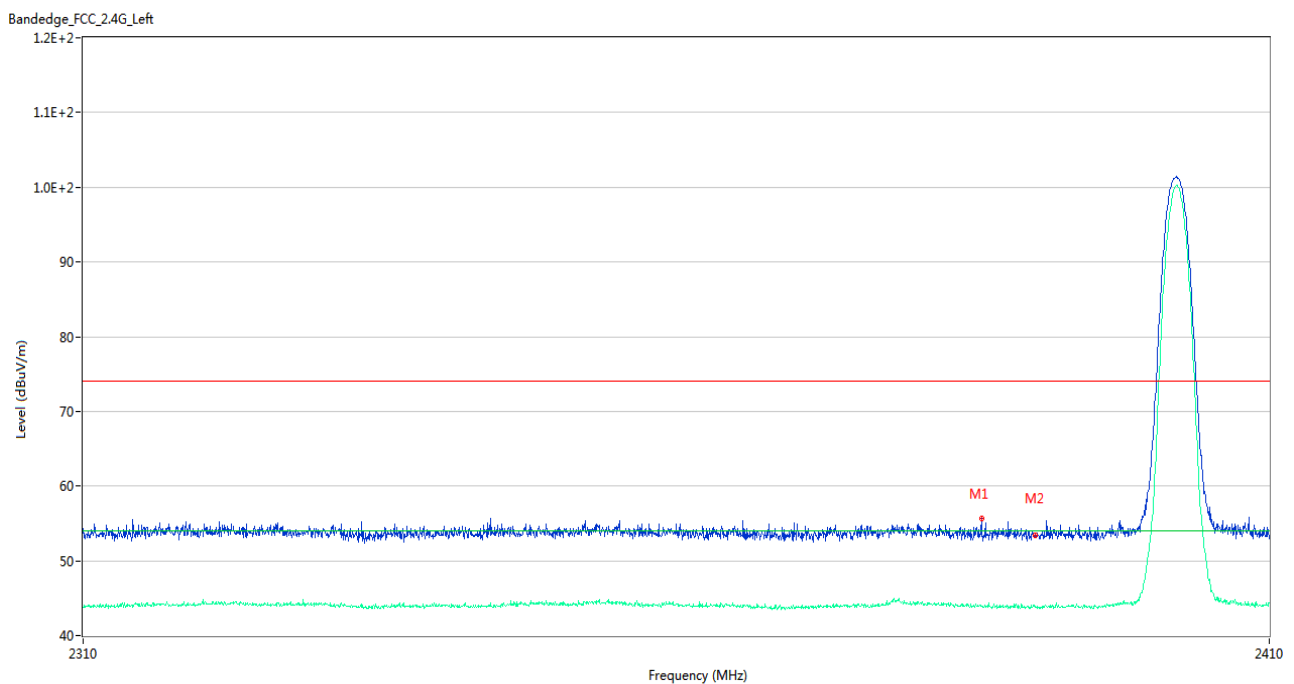

No.	Frequency (MHz)	Results (dBuV/m)	Factor (dB)	Limit (dBuV/m)	Margin (dB)	Detector	Table (Degree)	Height (cm)	Antenna	Verdict
1	2385.350	55.71	-0.73	74.0	18.29	Peak	180.00	150	Vertical	Pass
1**	2385.350	43.89	-0.73	54.0	10.11	AV	180.00	150	Vertical	Pass
2	2389.950	53.40	-0.59	74.0	20.60	Peak	336.00	200	Vertical	Pass
2**	2389.950	43.88	-0.59	54.0	10.12	AV	336.00	200	Vertical	Pass

GFSK HIGH CHANNEL

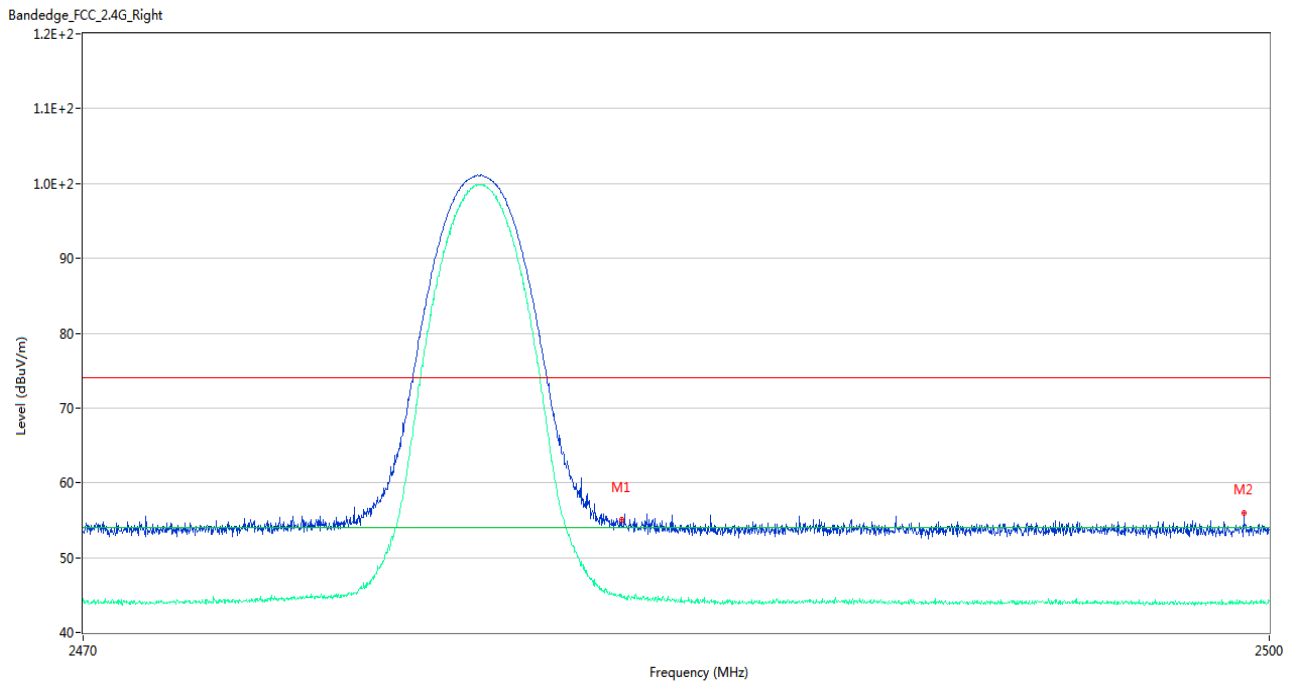

No.	Frequency (MHz)	Results (dBuV/m)	Factor (dB)	Limit (dBuV/m)	Margin (dB)	Detector	Table (Degree)	Height (cm)	Antenna	Verdict
1	2483.575	55.07	-0.06	74.0	18.93	Peak	84.00	200	Vertical	Pass
1**	2483.575	44.74	-0.06	54.0	9.26	AV	84.00	200	Vertical	Pass
2	2499.355	55.99	-0.15	74.0	18.01	Peak	57.00	100	Vertical	Pass
2**	2499.355	43.76	-0.15	54.0	10.24	AV	57.00	100	Vertical	Pass

8-DPSK LOW CHANNEL

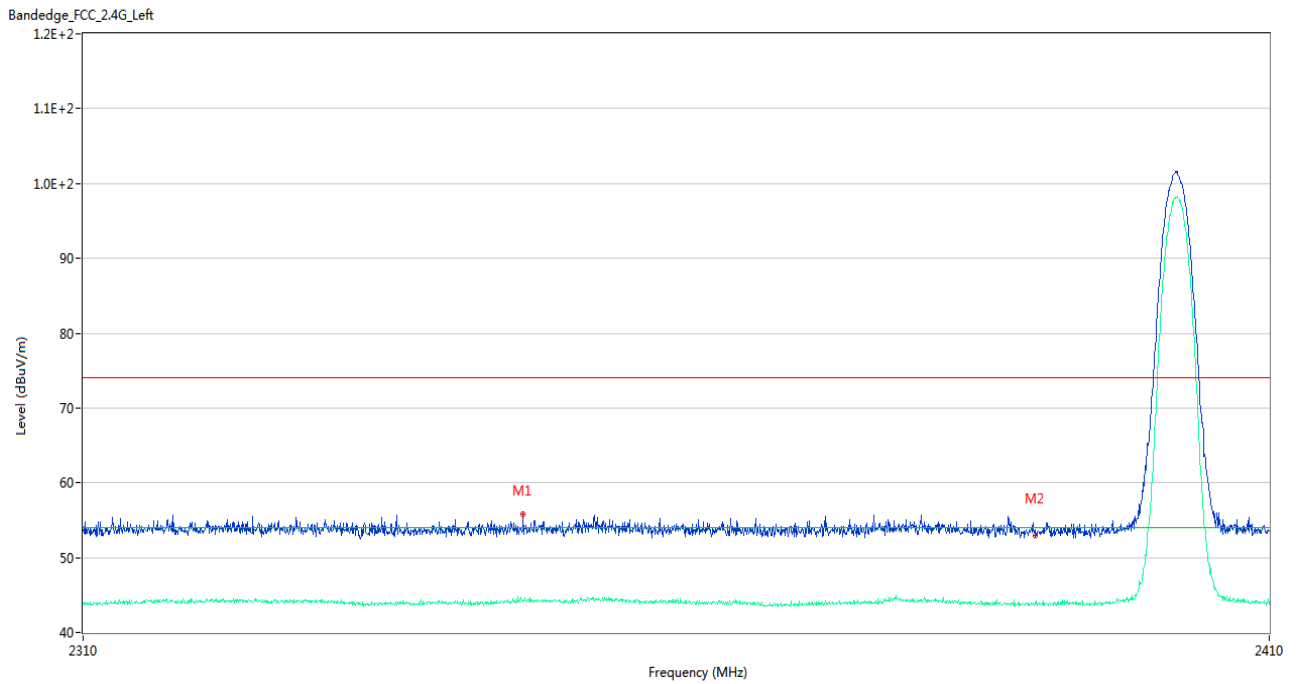

No.	Frequency (MHz)	Results (dBuV/m)	Factor (dB)	Limit (dBuV/m)	Margin (dB)	Detector	Table (Degree)	Height (cm)	Antenna	Verdict
1	2346.600	55.82	-0.44	74.0	18.18	Peak	40.00	150	Vertical	Pass
1**	2346.600	44.19	-0.44	54.0	9.81	AV	40.00	150	Vertical	Pass
2	2389.950	52.95	-0.59	74.0	21.05	Peak	99.00	200	Vertical	Pass
2**	2389.950	43.89	-0.59	54.0	10.11	AV	99.00	200	Vertical	Pass

8-DPSK HIGH CHANNEL

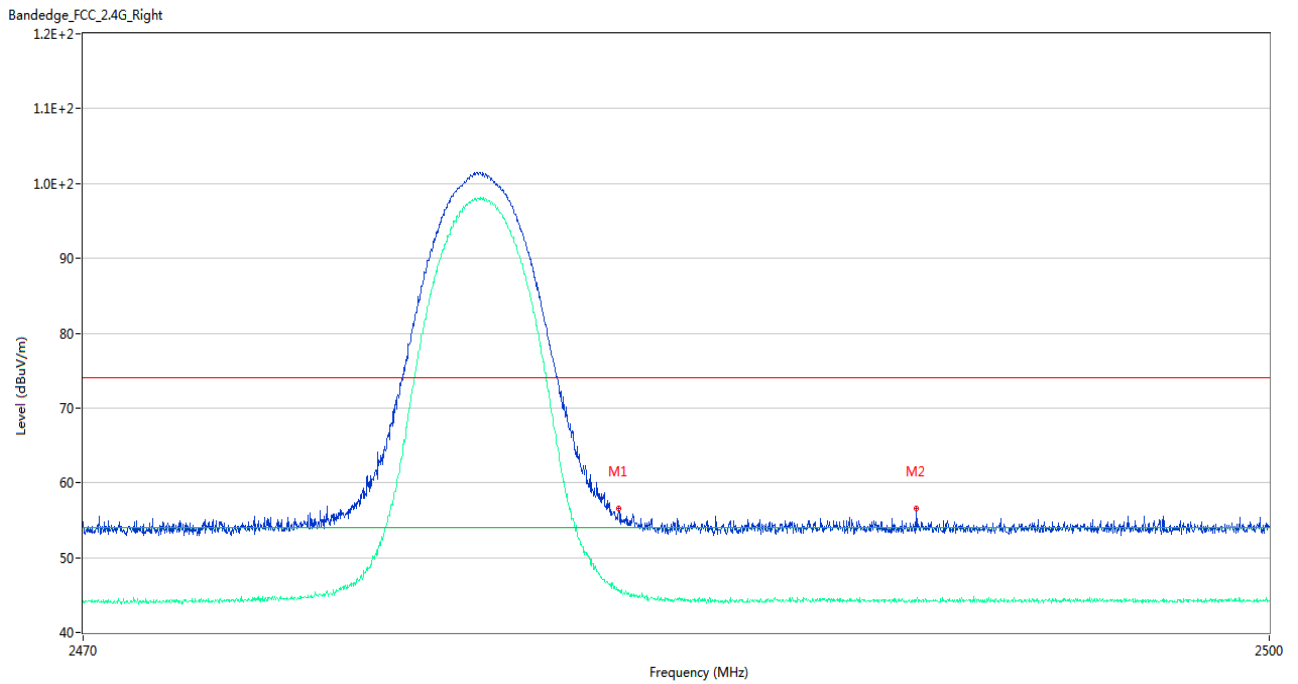

No.	Frequency (MHz)	Results (dBuV/m)	Factor (dB)	Limit (dBuV/m)	Margin (dB)	Detector	Table (Degree)	Height (cm)	Antenna	Verdict
1	2483.500	56.60	-0.05	74.0	17.40	Peak	331.00	100	Vertical	Pass
1**	2483.500	45.66	-0.05	54.0	8.34	AV	331.00	100	Vertical	Pass
2	2491.045	56.50	-0.21	74.0	17.50	Peak	7.00	200	Vertical	Pass
2**	2491.045	44.24	-0.21	54.0	9.76	AV	7.00	200	Vertical	Pass

ANNEX A TEST SETUP PHOTOS

1 Radiated Test Photo

Below 30MHz

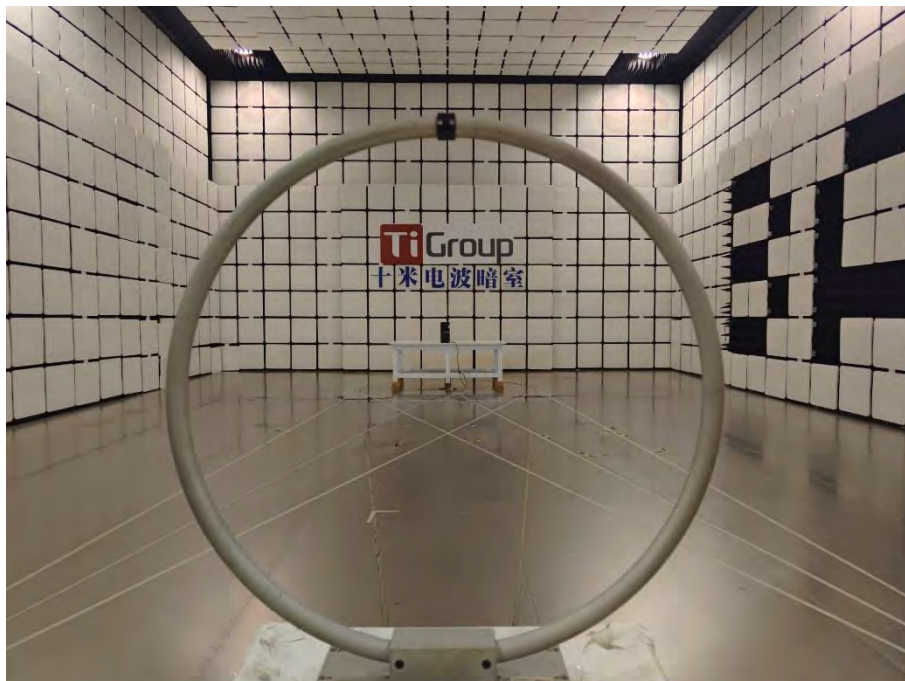

Close-up



30MHz-1GHz



Close-up



Above 1GHz

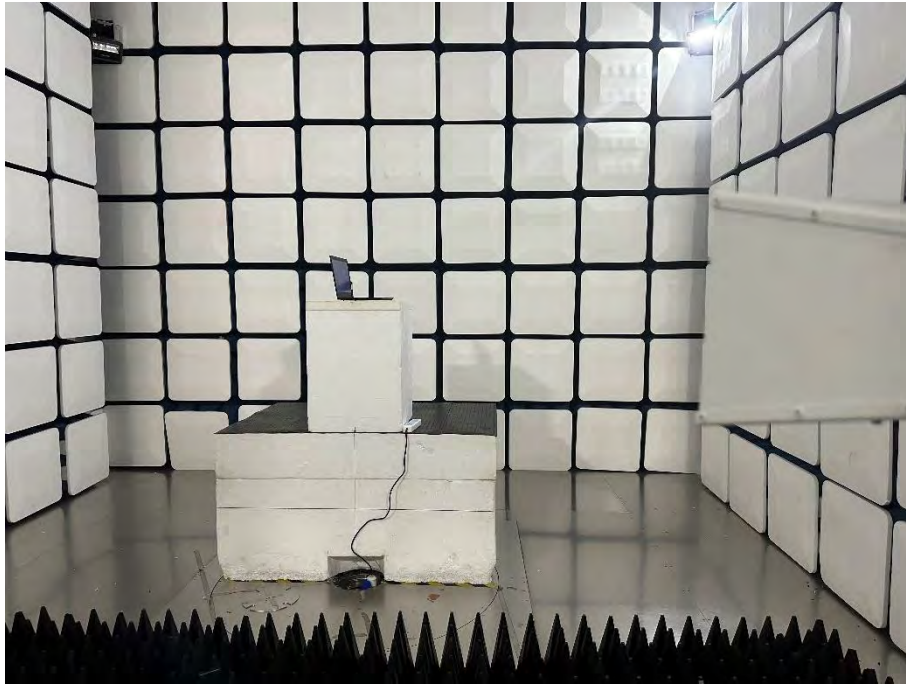

Close-up

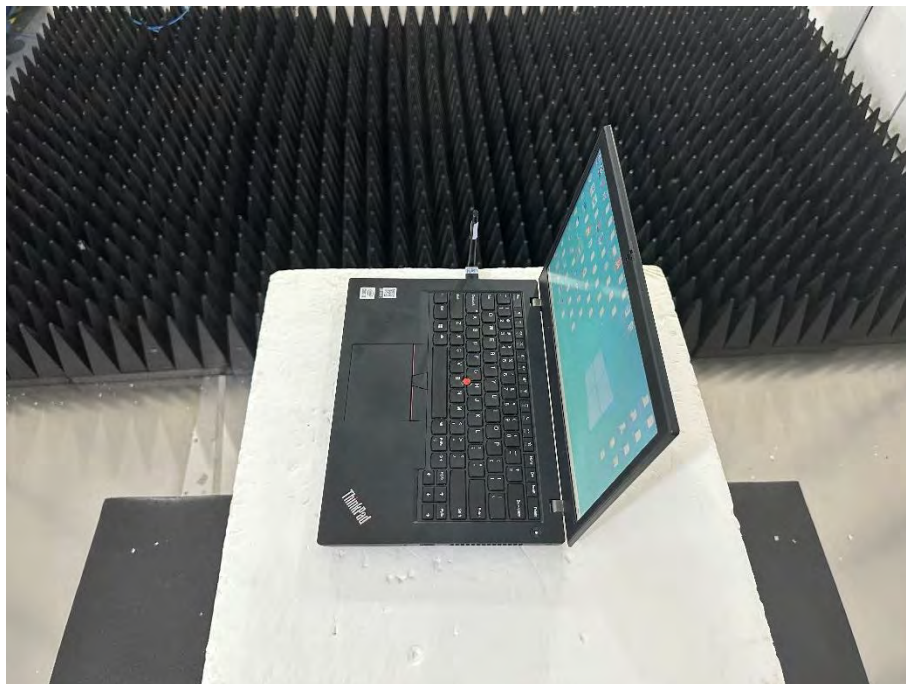

2 Conducted Test Photo

Conducted Test

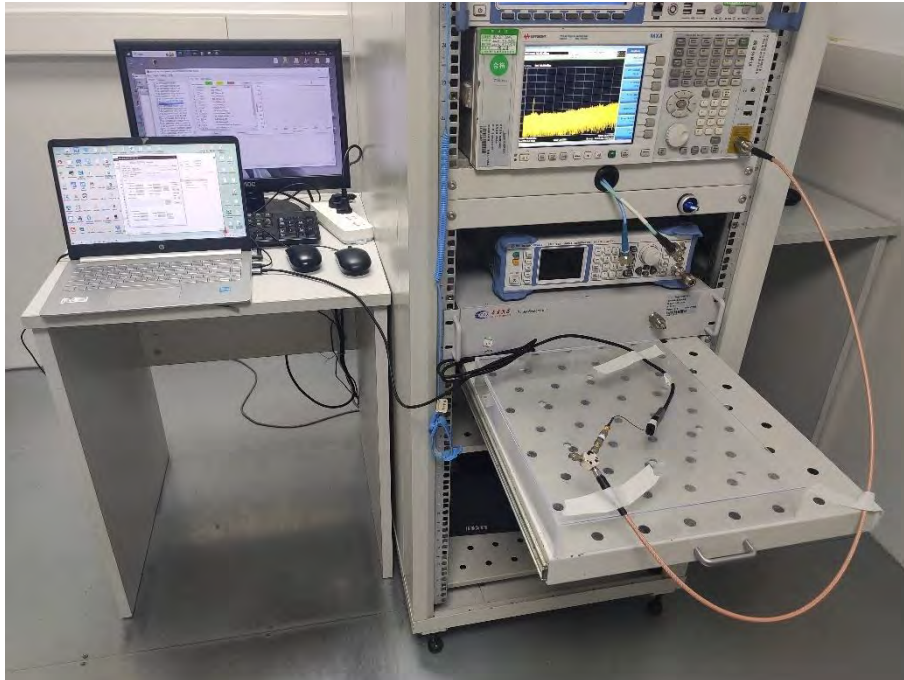

3 Conducted Emissions

Test Photo 1

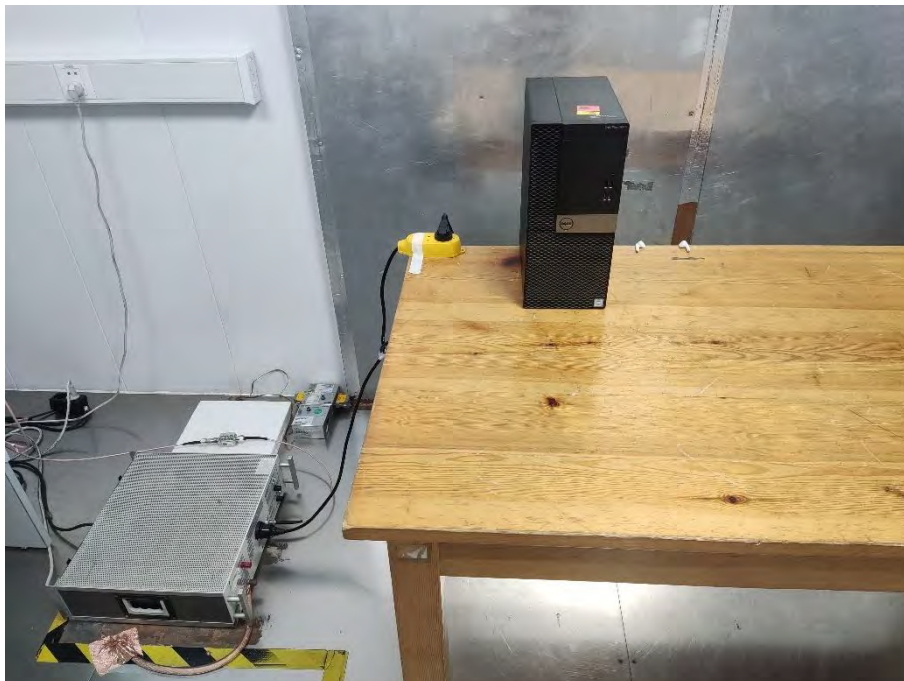

Test Photo 2



ANNEX B EUT EXTERNAL PHOTOS

FRONT VIEW OF EUT



REAR VIEW OF EUT



LEFT VIEW OF EUT

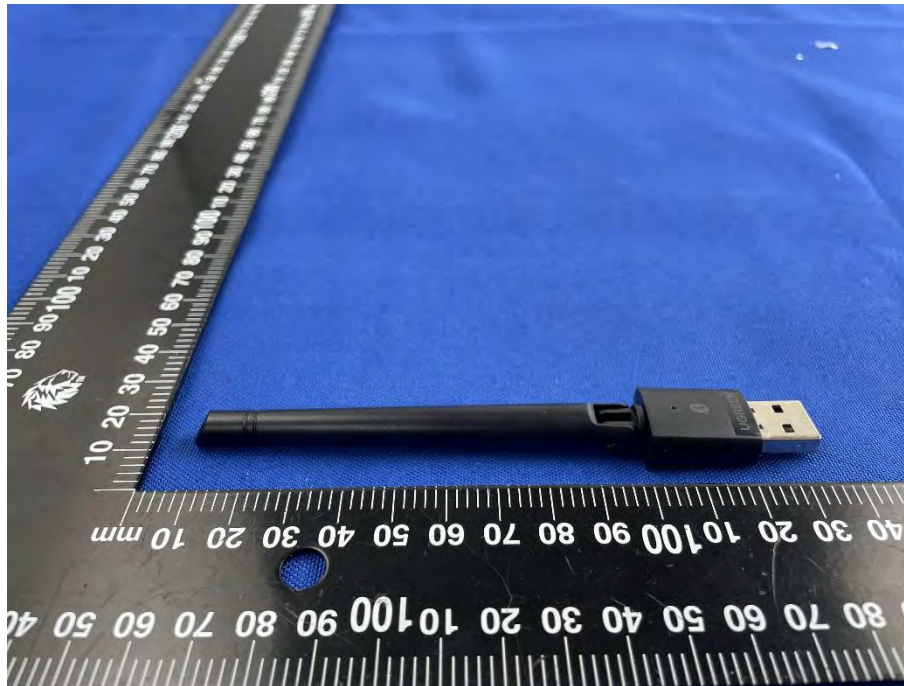

RIGHT VIEW OF EUT

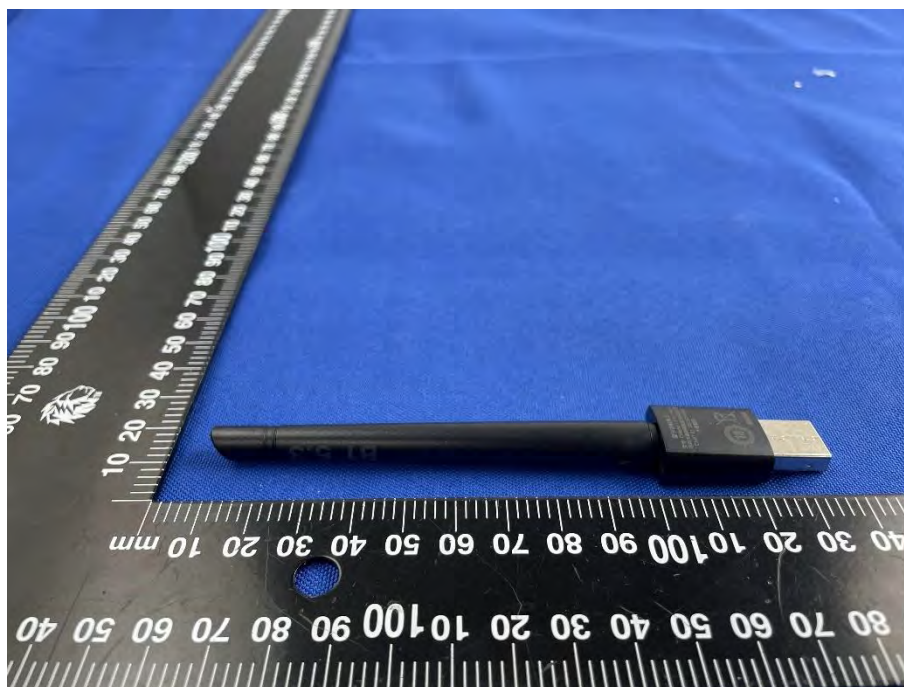

TOP VIEW OF EUT

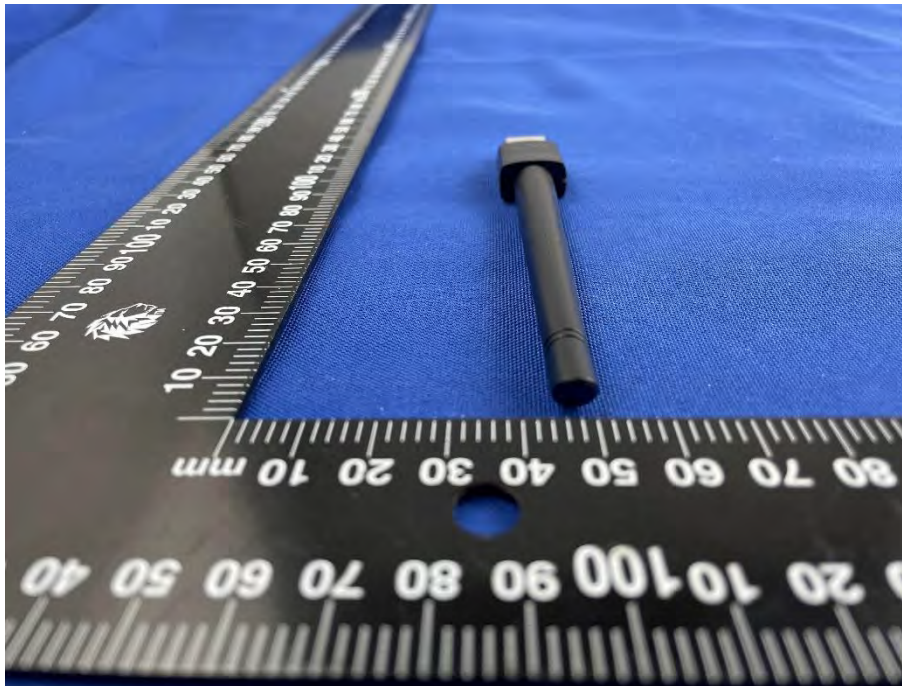

BOTTOM VIEW OF EUT

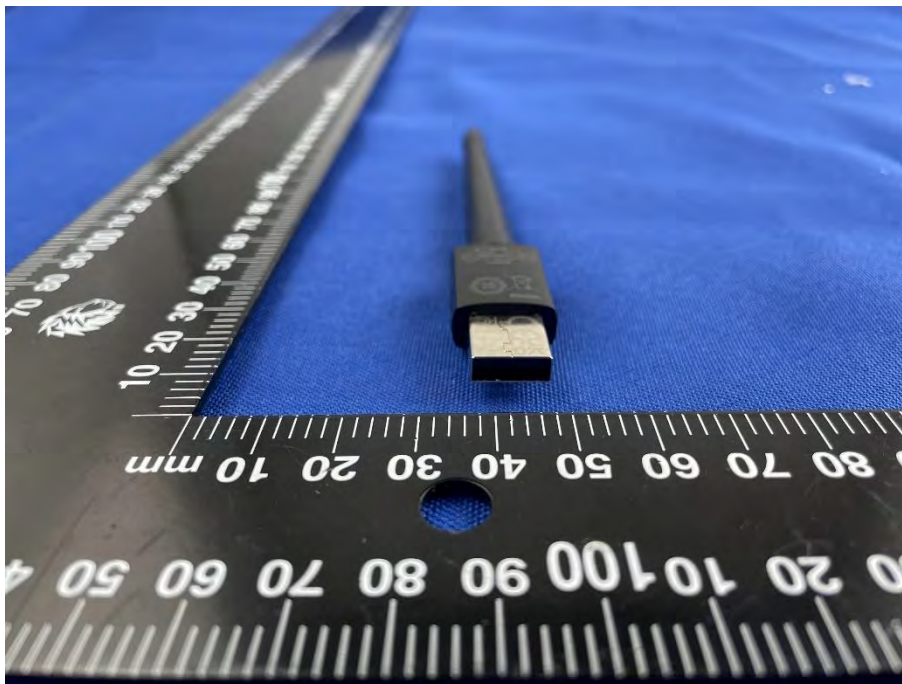

CLOSE-UP



ANNEX C EUT INTERNAL PHOTOS

EUT UNCOVER VIEW 1

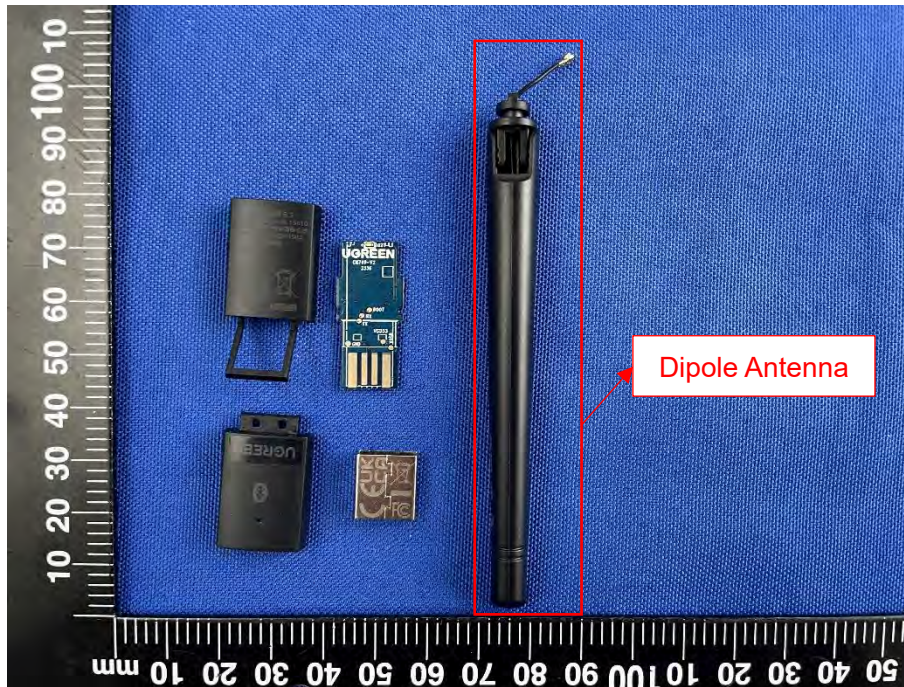

MAIN BOARD TOP VIEW

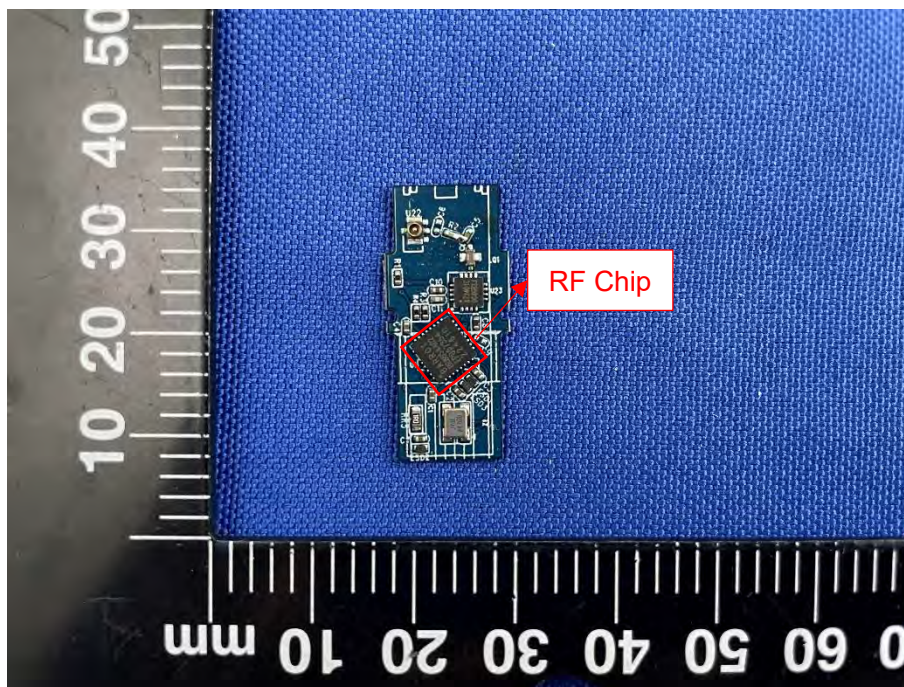

MAIN BOARD REAR VIEW

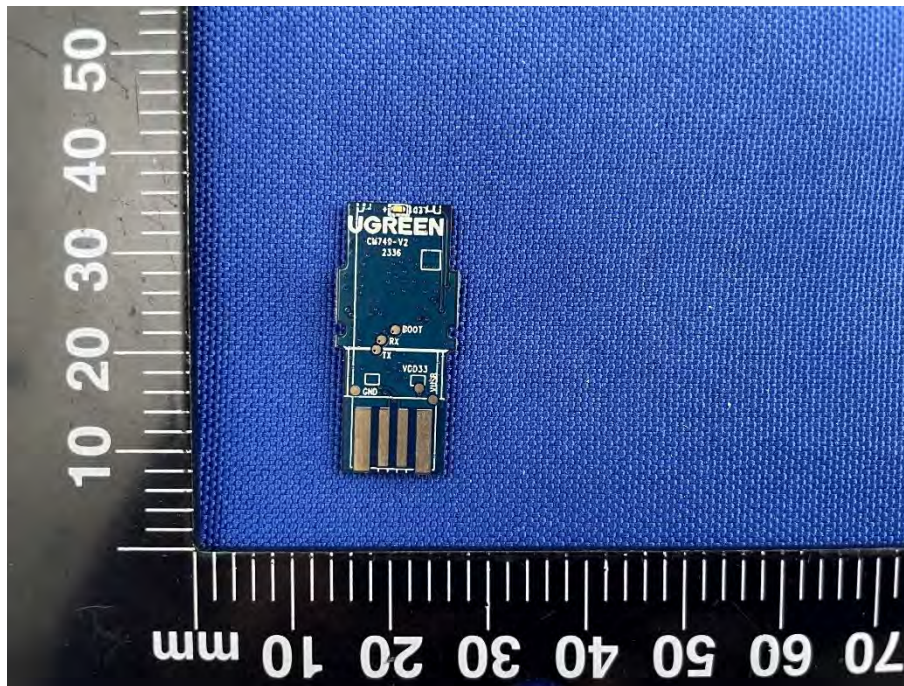

Statement

1. The laboratory guarantees the scientificity, accuracy and impartiality of the test, and is responsible for all the information in the report, except the information provided by the customer. The customer is responsible for the impact of the information provided on the validity of the results.
2. The report without China inspection body and laboratory Mandatory Approval (CMA) mark has no effect of proving to the society.
3. For the report with CNAS mark or A2LA mark, the items marked with "☆" are not within the accredited scope.
4. This report is invalid if it is altered, without the signature of the testing and approval personnel, or without the "inspection and testing dedicated stamp" or test report stamp.
5. The test data and results are only valid for the tested samples provided by the customer.
6. This report shall not be partially reproduced without the written permission of the laboratory.
7. Any objection shall be raised to the laboratory within 30 days after receiving the report.

--END OF REPORT--