

FCC Test Report

Client Name : Ugreen Group Limited

Client Address : Ugreen Building, Longcheng Industrial Park,
Longguanxi Road, Longhua, ShenZhen, China

Product Name : 15W Wireless Charging Pad

Report Date : Jan. 09, 2023

Shenzhen Anbotek Compliance Laboratory Limited



Contents

1. General Information.....	5
1.1. Client Information.....	5
1.2. Description of Device (EUT).....	5
1.3. Auxiliary Equipment Used During Test.....	6
1.4. Description of Test Modes.....	6
1.5. Description Of Test Setup.....	7
1.6. Test Equipment List.....	8
1.7. Measurement Uncertainty.....	9
1.8. Description of Test Facility.....	9
2. Summary of Test Results.....	10
3. Conducted Emission Test.....	11
3.1. Test Standard and Limit.....	11
3.2. Test Setup.....	11
3.3. Test Procedure.....	11
3.4. Test Data.....	11
4. Radiation Spurious Emission.....	14
4.1. Test Standard and Limit.....	14
4.2. Test Setup.....	14
4.3. Test Procedure.....	15
4.4. Test Data.....	15
5. Antenna Requirement.....	20
5.1. Test Standard and Requirement.....	20
5.2. Antenna Connected Construction.....	20
APPENDIX I -- TEST SETUP PHOTOGRAPH.....	21
APPENDIX II -- EXTERNAL PHOTOGRAPH.....	21
APPENDIX III -- INTERNAL PHOTOGRAPH.....	21



TEST REPORT

Applicant : Ugreen Group Limited
Manufacturer : Ugreen Group Limited
Product Name : 15W Wireless Charging Pad
Model No. : CD186, 15111, 15112, 15111P, 15111X, 15111A, 15111B, 15111U, 15111JP, 15112P, 15112X, 15112A, 15112B, 15112U, 15112JP
Trade Mark : **UGREEN**
Rating(s) : Input: 5.0V== 3A, 9.0V== 2.2A
Output: 5W, 7.5W, 10W, 15W
Test Standard(s) : **FCC Part15 Subpart C, Paragraph 15.209**
Test Method(s) : **ANSI C63.10: 2020**

The device described above is tested by Shenzhen Anbotek Compliance Laboratory Limited to determine the maximum emission levels emanating from the device and the severe levels of the device can endure and its performance criterion. The measurement results are contained in this test report and Shenzhen Anbotek Compliance Laboratory Limited is assumed full of responsibility for the accuracy and completeness of these measurements. Also, this report shows that the EUT (Equipment Under Test) is technically compliant with the FCC Part 15 Subpart C requirements.

This report applies to above tested sample only and shall not be reproduced in part without written approval of Shenzhen Anbotek Compliance Laboratory Limited.

Date of Receipt

Nov. 21, 2022

Date of Test

Nov. 21~29, 2022

Prepared By

Ella Liang

(Ella Liang)

Approved & Authorized Signer

Kingkong Jin

(Kingkong Jin)



Revision History

Report Version	Description	Issued Date
R00	Original Issue.	Jan. 09, 2023



1. General Information

1.1. Client Information

Applicant	:	Ugreen Group Limited
Address	:	Ugreen Building,Longcheng Industrial Park, Longguanxi Road,Longhua, ShenZhen, China
Manufacturer	:	Ugreen Group Limited
Address	:	Ugreen Building,Longcheng Industrial Park, Longguanxi Road,Longhua, ShenZhen, China
Factory	:	SHENZHEN ZHIZE TECHNOLOGY CO.,LTD
Address	:	1-4/F, No.13, Langkou Industrial Park, Langkou Community, Dalang Street, Longhua District, Shenzhen, China

1.2. Description of Device (EUT)

Product Name	:	15W Wireless Charging Pad
Model No.	:	CD186, 15111, 15112, 15111P, 15111X, 15111A, 15111B,15111U, 15111JP, 15112P, 15112X,15112A, 15112B, 15112U,15112JP (Note: All samples are the same except the model number, so we prepare "CD186" for test only.)
Trade Mark	:	UGREEN
Test Power Supply	:	AC 120V, 60Hz for adapter
Test Sample No.	:	1-2-1(Normal Sample), 1-2-2(Engineering Sample)
Adapter	:	N/A
RF Specification		
Operation Frequency	:	111-205 kHz
Modulation Type	:	FSK
Antenna Type	:	Inductive loop coil Antenna
Antenna Gain(Peak)	:	0 dBi (Provided by customer)
Remark: 1) For a more detailed features description, please refer to the manufacturer's specifications or the User's Manual.		



1.3. Auxiliary Equipment Used During Test

Description	Rating(s)
Adapter	Model: AD651P Output: 5V= 3A, 9V= 3A, 10V= 5A, 12V= 3A, 15V= 3A, 20V= 3.25A Input: 100-240V~1.5A, 50-60Hz
Wireless Load	Manufacturer: Shenzhen Ouju Technology Co., Ltd. M/N: CD2577 Power: 5W/7.5W/10W/15W

1.4. Description of Test Modes

To investigate the maximum EMI emission characteristics generates from EUT, the test system was pre-scanning tested base on the consideration of following EUT operation mode or test configuration mode which possible have effect on EMI emission level. Each of these EUT operation mode(s) or test configuration mode(s) mentioned above was evaluated respectively.

Pretest Mode	Description
Mode 1	WPT Mode

For Conducted Emission	
Final Test Mode	Description
Mode 1	WPT Mode

For Radiated Emission	
Final Test Mode	Description
Mode 1	WPT Mode

Note:

- (1) Test channel is 0.1189MHz.
- (2) All the situation(full load, half load and empty load) has been tested,only the worst situation (full load 15W) was recorded in the report.



1.5. Description Of Test Setup

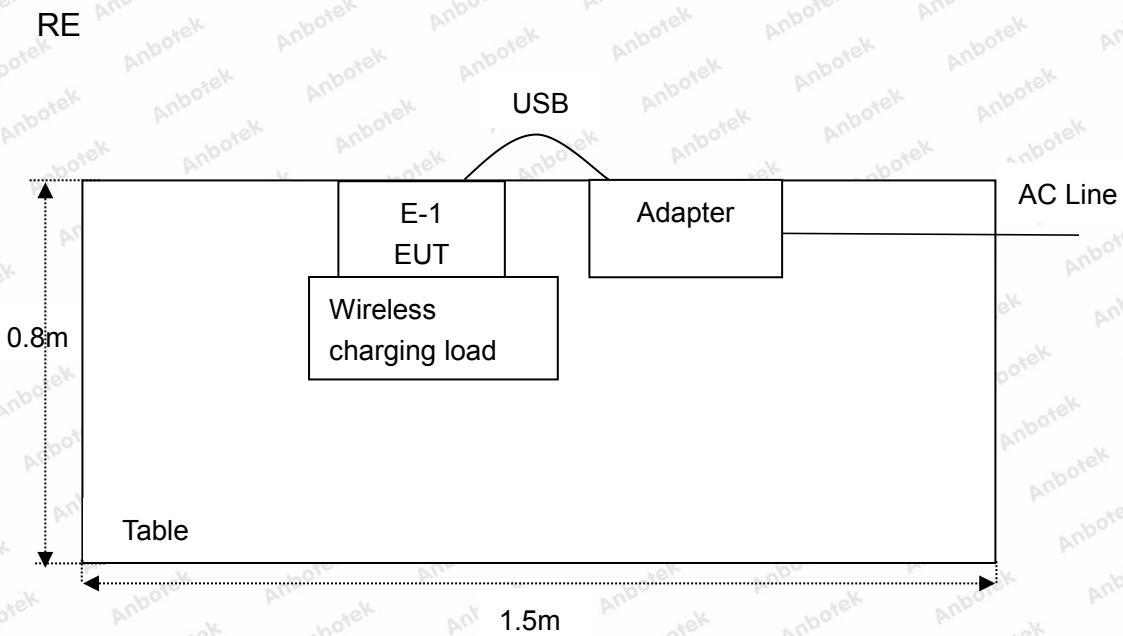
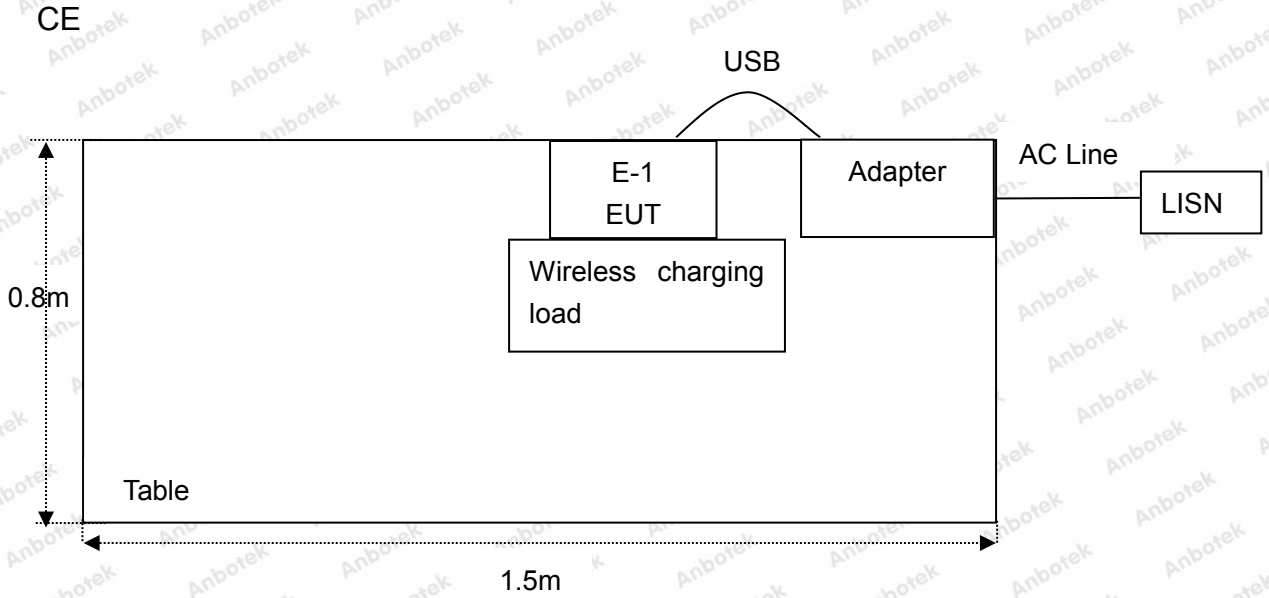

1.6. Test Equipment List

Item	Equipment	Manufacturer	Model No.	Serial No.	Last Cal.	Cal. Interval
1.	L.I.S.N. Artificial Mains Network	Rohde & Schwarz	ENV216	100055	Oct. 23, 2022	1 Year
2.	Three Phase V-type Artificial Power Network	CYBERTEK	EM5040DT	E215040DT001	Jul. 05, 2022	1 Year
3.	EMI Test Receiver	Rohde & Schwarz	ESCI	100627	Oct. 13, 2022	1 Year
4.	EMI Test Receiver	Rohde & Schwarz	ESR26	101481	Oct. 23, 2022	1 Year
5.	RF Switching Unit	Compliance Direction	RSU-M2	38303	Oct. 22, 2022	1 Year
6.	MXA Spectrum Analysis	Agilent	N9020A	MY51170037	Oct. 13, 2022	1 Year
7.	EMI Preamplifier	SKET Electronic	LNPA-0118G -45	SKET-PA-002	Oct. 13, 2022	1 Year
8.	Double Ridged Horn Antenna	SCHWARZBECK	BBHA 9120D	02555	Oct. 16, 2022	3 Year
9.	Bilog Broadband Antenna	Schwarzbeck	VULB9163	VULB 9163-289	Oct. 23, 2022	1 Year
10.	Loop Antenna	Schwarzbeck	FMZB1519B	00053	Oct. 23, 2022	1 Year
11.	Horn Antenna	A-INFO	LB-180400-K F	J211060628	Oct. 23, 2022	1 Year
12.	Pre-amplifier	SONOMA	310N	186860	Oct. 23, 2022	1 Year
13.	EMI Test Software EZ-EMC	SHURPLE	N/A	N/A	N/A	N/A
14.	MXA Spectrum Analysis	KEYSIGHT	N9020A	MY53280032	Oct. 13, 2022	1 Year
15.	MXG RF Vector Signal Generator	Agilent	N5182A	MY48180656	Oct. 13, 2022	1 Year
16.	Signal Generator	Agilent	E4421B	MY41000743	Oct. 13, 2022	1 Year
17.	DC Power Supply	IVYTECH	IV3605	1804D360510	Oct. 22, 2022	1 Year
18.	Constant Temperature Humidity Chamber	ZHONGJIAN	ZJ-KHWS80 B	N/A	Oct. 19, 2022	1 Year



1.7. Measurement Uncertainty

Radiation Uncertainty	:	Ur = 3.9 dB (Horizontal)
		Ur = 3.8 dB (Vertical)
Conduction Uncertainty	:	Uc = 3.4 dB

1.8. Description of Test Facility

The test facility is recognized, certified, or accredited by the following organizations:

FCC-Registration No.: 184111

Shenzhen Anbotek Compliance Laboratory Limited, EMC Laboratory has been registered and fully described in a report filed with the (FCC) Federal Communications Commission. The acceptance letter from the FCC is maintained in our files. Registration No. 184111.

ISED-Registration No.: 8058A

Shenzhen Anbotek Compliance Laboratory Limited, EMC Laboratory has been registered and fully described in a report filed with the (ISED) Innovation, Science and Economic Development Canada. The acceptance letter from the ISED is maintained in our files. Registration 8058A.

Test Location

Shenzhen Anbotek Compliance Laboratory Limited.

1/F, Building D, Sogood Science and Technology Park, Sanwei community, Hangcheng Street, Bao'an District, Shenzhen, Guangdong, China.518102



2. Summary of Test Results

Standard Section	Test Item	Result
15.203	Antenna Requirement	PASS
15.207	Conducted Emission Test	PASS
15.205/15.209	Spurious Emission	PASS



3. Conducted Emission Test

3.1. Test Standard and Limit

Test Standard	FCC Part15 Section 15.207		
	Frequency	Maximum RF Line Voltage (dBuV)	
		Quasi-peak Level	Average Level
Test Limit	150kHz~500kHz	66 ~ 56 *	56 ~ 46 *
	500kHz~5MHz	56	46
	5MHz~30MHz	60	50

Remark: (1) *Decreasing linearly with logarithm of the frequency.
 (2) The lower limit shall apply at the transition frequency.

3.2. Test Setup

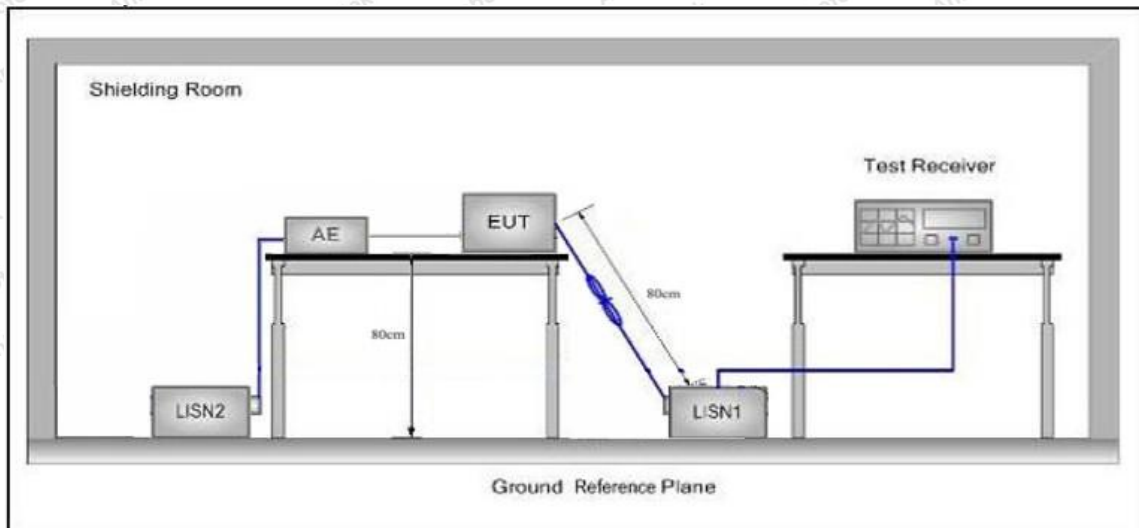

3.3. Test Procedure

The EUT system is connected to the power mains through a line impedance stabilization network (L.I.S.N.). This provides a 50ohm coupling impedance for the EUT system. Please refer the block diagram of the test setup and photographs. Both sides of AC line are checked to find out the maximum conducted emission. In order to find the maximum emission levels, the relative positions of equipment and all of the interface cables shall be changed according to FCC ANSI C63.10: 2020 on Conducted Emission Measurement.

The bandwidth of test receiver (ESCI) set at 9kHz.

The frequency range from 150kHz to 30MHz is checked.

3.4. Test Data

AC conducted emission pre-test at both at AC 120V/60Hz and AC 240V/60Hz modes, recorded worst case AC 120V/60Hz.

Please to see the following pages.



Conducted Emission Test Data

Test Site: 1# Shielded Room
 Operating Condition: Mode 1
 Test Specification: AC 120V, 60Hz for adapter
 Comment: Live Line
 Temp.(°C)/Hum.(%RH): 23.9°C/45%RH

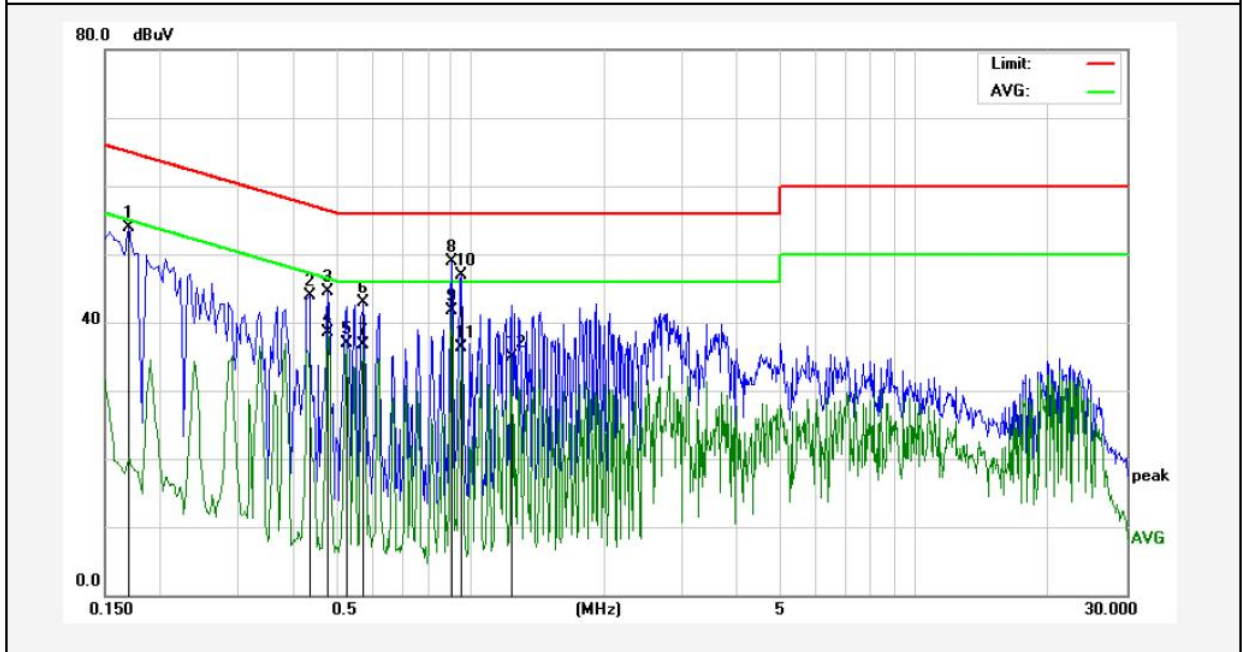

No.	Freq. (MHz)	Reading (dBuV)	Factor (dB)	Result (dBuV)	Limit (dBuV)	Over Limit (dB)	Detector	Remark
1	0.1700	44.02	9.83	53.85	64.96	-11.11	QP	
2	0.4340	34.09	9.82	43.91	57.18	-13.27	QP	
3	0.4780	34.60	9.85	44.45	56.37	-11.92	QP	
4	0.4780	28.70	9.85	38.55	46.37	-7.82	AVG	
5	0.5260	26.98	9.86	36.84	46.00	-9.16	AVG	
6	0.5740	32.95	9.86	42.81	56.00	-13.19	QP	
7	0.5740	26.75	9.86	36.61	46.00	-9.39	AVG	
8	0.9060	39.02	9.86	48.88	56.00	-7.12	QP	
9	0.9060	31.89	9.86	41.75	46.00	-4.25	AVG	
10	0.9500	37.02	9.86	46.88	56.00	-9.12	QP	
11	0.9580	26.37	9.86	36.23	46.00	-9.77	AVG	
12	1.2380	25.10	9.85	34.95	46.00	-11.05	AVG	



Conducted Emission Test Data

Test Site: 1# Shielded Room
 Operating Condition: Mode 1
 Test Specification: AC 120V, 60Hz for adapter
 Comment: Neutral Line
 Temp.(°C)/Hum.(%RH): 23.9°C/45%RH

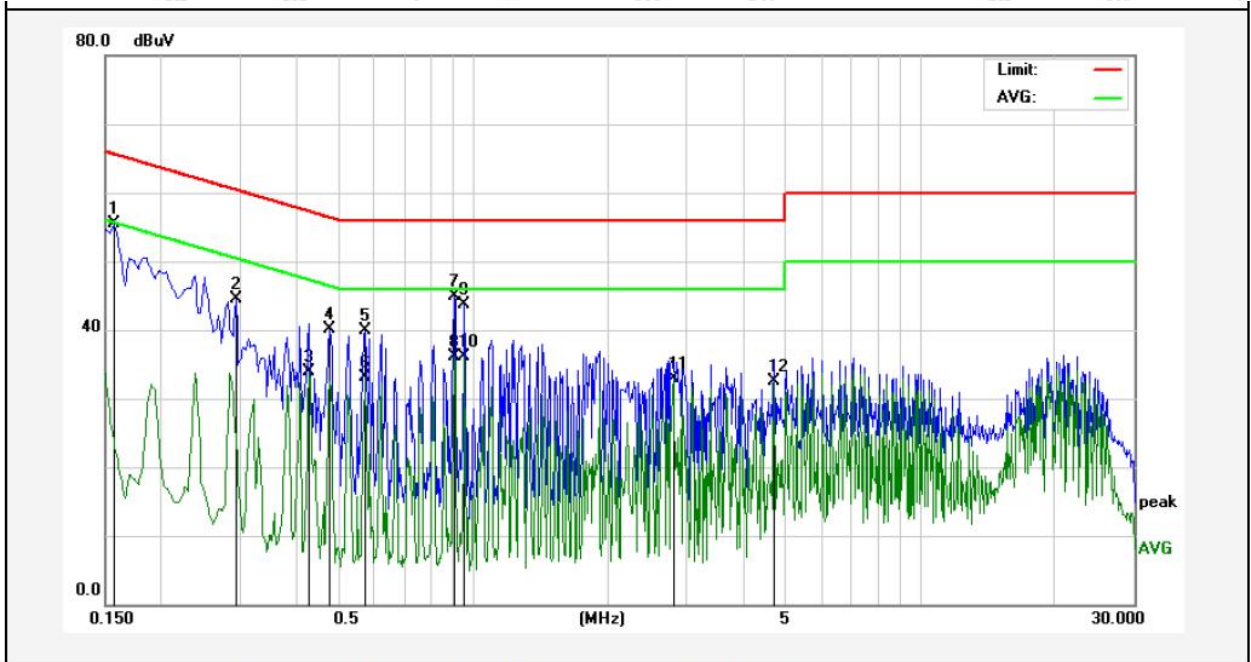

No.	Freq. (MHz)	Reading (dBuV)	Factor (dB)	Result (dBuV)	Limit (dBuV)	Over Limit (dB)	Detector	Remark
1	0.1580	45.75	9.83	55.58	65.56	-9.98	QP	
2	0.2940	34.67	9.84	44.51	60.41	-15.90	QP	
3	0.4300	24.08	9.82	33.90	47.25	-13.35	AVG	
4	0.4780	30.27	9.85	40.12	56.37	-16.25	QP	
5	0.5740	30.02	9.86	39.88	56.00	-16.12	QP	
6	0.5740	23.34	9.86	33.20	46.00	-12.80	AVG	
7	0.9060	35.10	9.86	44.96	56.00	-11.04	QP	
8	0.9060	26.27	9.86	36.13	46.00	-9.87	AVG	
9	0.9540	33.76	9.86	43.62	56.00	-12.38	QP	
10	0.9540	26.18	9.86	36.04	46.00	-9.96	AVG	
11	2.7980	23.01	9.85	32.86	46.00	-13.14	AVG	
12	4.7100	22.65	9.86	32.51	46.00	-13.49	AVG	



4. Radiation Spurious Emission

4.1. Test Standard and Limit

Test Standard	FCC Part15 C Section 15.209 and 15.205				
Test Limit	Frequency (MHz)	Field strength (microvolt/meter)	Limit (dBuV/m)	Remark	Measurement distance (m)
	0.009MHz~0.490MHz	2400/F(kHz)	-	-	300
	0.490MHz-1.705MHz	24000/F(kHz)	-	-	30
	1.705MHz-30MHz	30	-	-	30
	30MHz~88MHz	100	40.0	Quasi-peak	3
	88MHz~216MHz	150	43.5	Quasi-peak	3
	216MHz~960MHz	200	46.0	Quasi-peak	3
	960MHz~1000MHz	500	54.0	Quasi-peak	3
	Above 1000MHz	500	54.0	Average	3
-		-	74.0	Peak	3

Remark:

(1)The lower limit shall apply at the transition frequency.

(2) 15.35(b), Unless otherwise specified, the limit on peak radio frequency emissions is 20dB above the maximum permitted average emission limit applicable to the equipment under test. This peak limit applies to the total peak emission level radiated by the device.

4.2. Test Setup

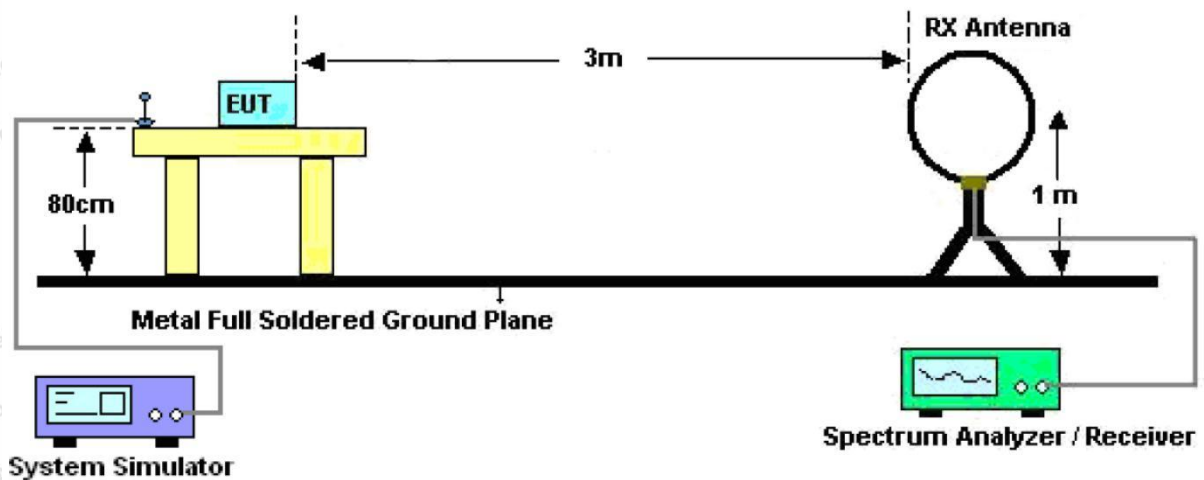

Figure 1. Below 30MHz



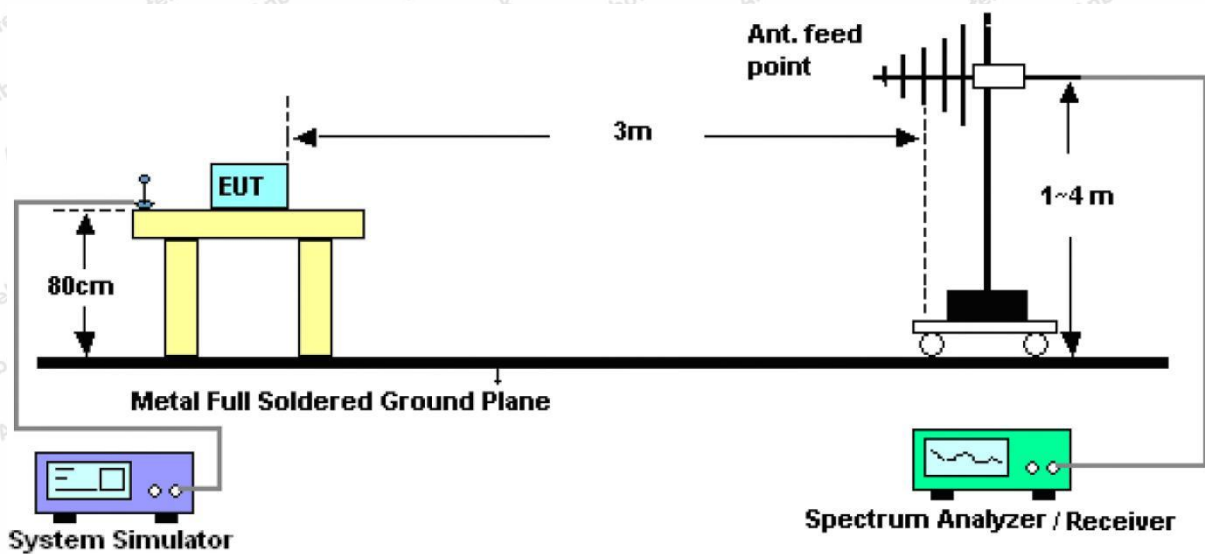

Figure 2. 30MHz to 1GHz

4.3. Test Procedure

For below 1GHz: The EUT is placed on a turntable, which is 0.8m above the ground plane.

The turn table can rotate 360 degrees to determine the position of the maximum emission level. The EUT is set 3 meters away from the receiving antenna which is mounted on a antenna tower. The antenna can be moved up and down from 1 to 4 meters to find out the maximum emission level. Rotated the EUT through three orthogonal axes to determine the maximum emissions, both horizontal and vertical polarization of the antenna are set on test. The EUT is tested in 9*6*6 Chamber. The device is evaluated in xyz orientation.

For 9kHz to 150kHz, Set the spectrum analyzer as:

RBW = 200Hz, VBW = 1kHz, Detector= Quasi-Peak, Trace mode= Max hold, Sweep- auto couple.

For 150kHz to 30MHz, Set the spectrum analyzer as:

RBW = 9KHz, VBW = 30kHz, Detector= Quasi-Peak, Trace mode= Max hold, Sweep- auto couple.

For 30MHz to 1000MHz, Set the spectrum analyzer as:

RBW = 100kHz, VBW = 300kHz, Detector= Quasi-Peak, Trace mode= Max hold, Sweep- auto couple.

4.4. Test Data

PASS

During the test, Pre-scan all kind of the place mode (X-axis, Y-axis, Z-axis), and found the X-axis is the worst case.



Test Results (Between 9KHz – 150KHz)

Test Mode: Mode 1
 Distance: 3m
 Power Source: AC 120V, 60Hz for adapter
 Temp.(°C)/Hum.(%RH): 22.5°C/50%RH

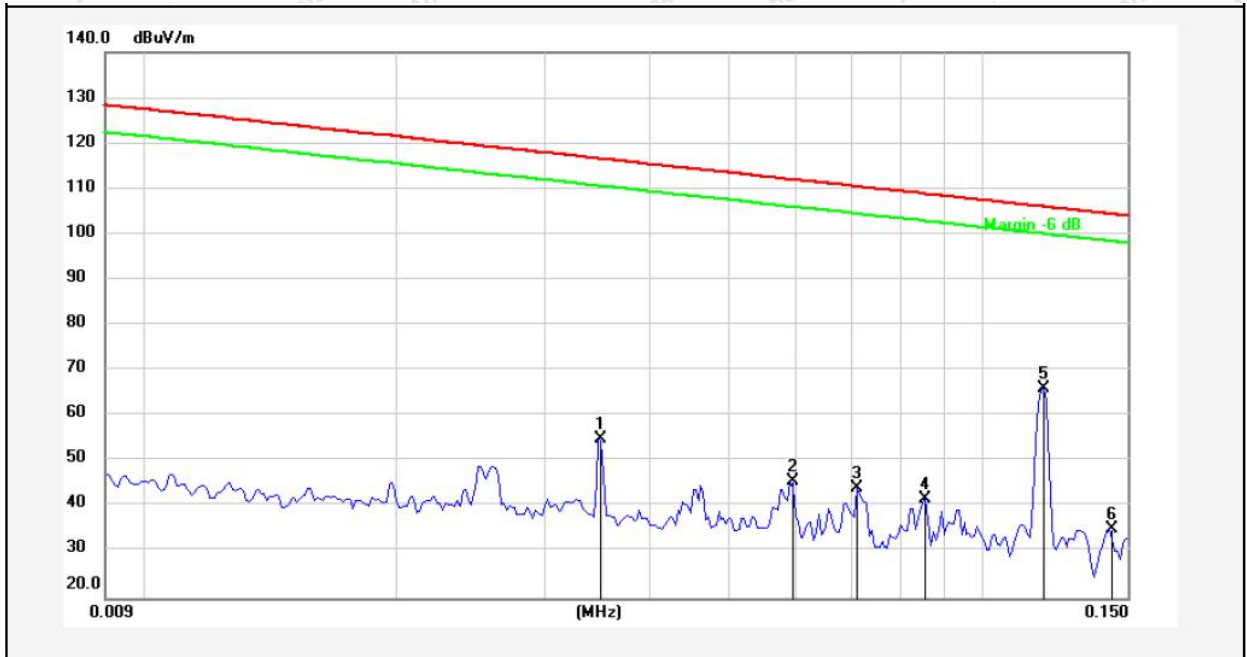

No.	Freq. (MHz)	Reading (dBuV)	Factor ()	Result (dBuV/m)	Limit (dBuV/m)	Over Limit (dB)	Detector	Height (cm)	degree (deg)	Remark
1	0.0350	34.32	20.49	54.81	116.65	-61.84	QP			
2	0.0593	25.24	20.37	45.61	112.08	-66.47	QP			
3	0.0711	23.75	20.37	44.12	110.51	-66.39	QP			
4	0.0855	21.32	20.38	41.70	108.91	-67.21	QP			
5	0.1189	45.60	20.33	65.93	106.06	-40.13	QP			
6	0.1428	14.71	20.33	35.04	104.47	-69.43	QP			



Test Results (Between 0.15MHz – 30MHz)

Test Mode: Mode 1
 Distance: 3m
 Power Source: AC 120V, 60Hz for adapter
 Temp.(°C)/Hum.(%RH): 22.5°C/50%RH

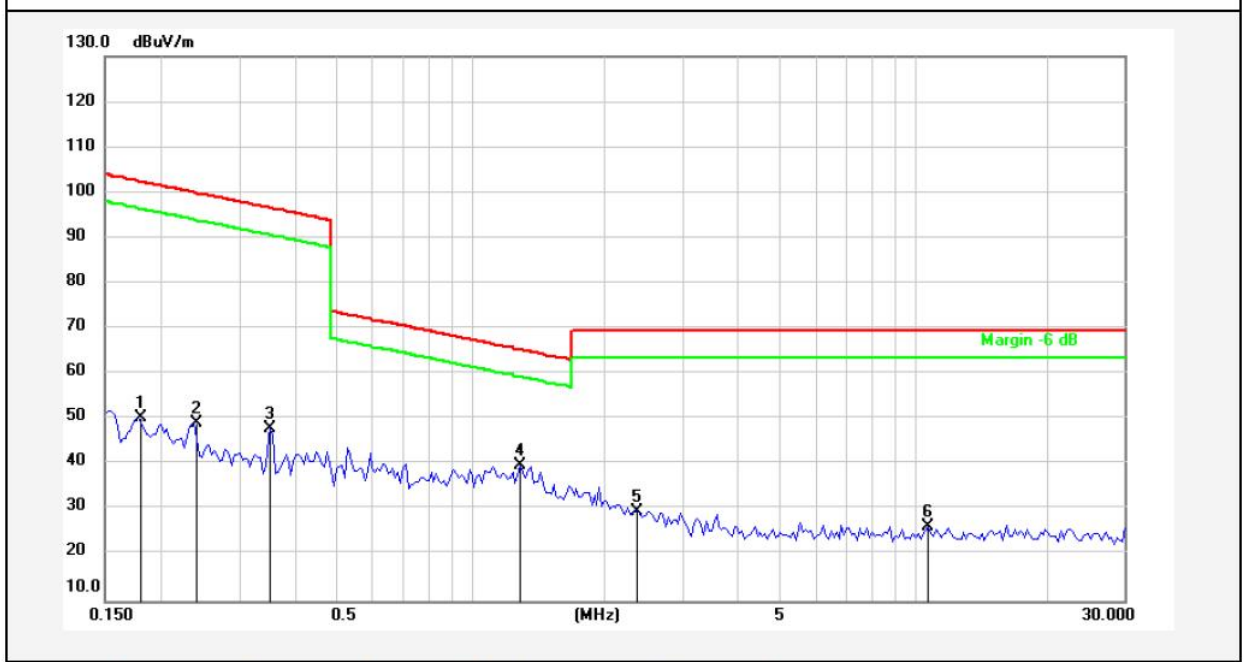

No.	Freq. (MHz)	Reading (dBuV)	Factor ()	Result (dBuV/m)	Limit (dBuV/m)	Over Limit (dB)	Detector	Height (cm)	degree (deg)	Remark
1	0.1782	29.99	20.32	50.31	102.53	-52.22	QP			
2	0.2385	28.82	20.30	49.12	100.02	-50.90	QP			
3	0.3548	27.63	20.28	47.91	96.59	-48.68	QP			
4	1.2994	19.58	20.26	39.84	65.35	-25.51	QP			
5	2.3899	9.40	20.29	29.69	69.50	-39.81	QP			
6	10.8186	5.94	20.52	26.46	69.50	-43.04	QP			

Remark: According to FCC PART 15.209 (d), the emission limits for the frequency bands 9–90 kHz, 110–490 kHz and above 1000 MHz, Radiated emission limits in these three bands are based on measurements employing an average detector.



Test Results (Between 30MHz –1000 MHz)

Test Mode: Mode 1
 Distance: 3m
 Power Source: AC 120V, 60Hz for adapter
 Polarization: Horizontal
 Temp.(°C)/Hum.(%RH): 22.5°C/50%RH

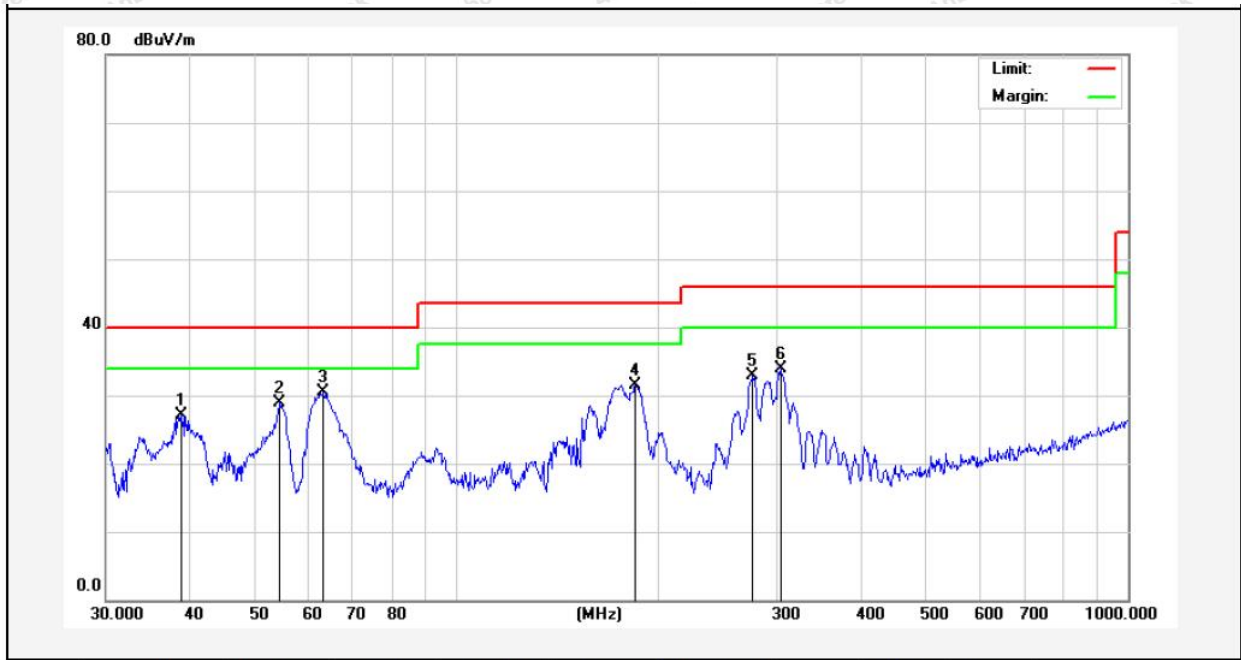

No.	Freq. (MHz)	Reading (dBuV)	Factor (dB/m)	Result (dBuV/m)	Limit (dBuV/m)	Over Limit (dB)	Detector	Height (cm)	degree (deg)	Remark
1	38.8878	43.61	-16.56	27.05	40.00	-12.95	QP			
2	54.4516	46.42	-17.42	29.00	40.00	-11.00	QP			
3	63.3132	49.23	-18.71	30.52	40.00	-9.48	QP			
4	184.4898	54.55	-22.98	31.57	43.50	-11.93	QP			
5	276.1235	52.09	-19.24	32.85	46.00	-13.15	QP			
6	303.5437	51.08	-17.08	34.00	46.00	-12.00	QP			



Test Mode: Mode 1
 Distance: 3m
 Power Source: AC 120V, 60Hz for adapter
 Polarization: Vertical
 Temp.(°C)/Hum.(%RH): 22.5°C/50%RH

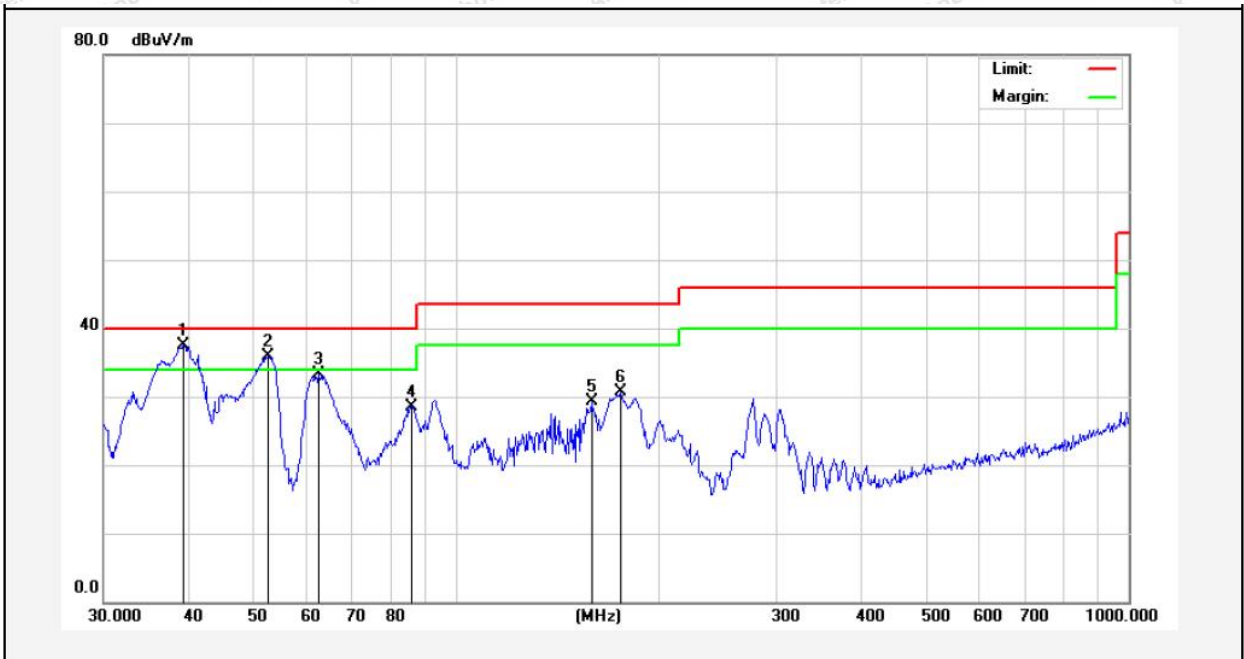

No.	Freq. (MHz)	Reading (dBuV)	Factor (dB/m)	Result (dBuV/m)	Limit (dBuV/m)	Over Limit (dB)	Detector	Height (cm)	degree (deg)	Remark
1	39.4371	52.44	-14.85	37.59	40.00	-2.41	QP			
2	52.7600	52.73	-16.80	35.93	40.00	-4.07	QP			
3	62.6507	51.72	-18.46	33.26	40.00	-6.74	QP			
4	86.2001	46.90	-18.31	28.59	40.00	-11.41	QP			
5	159.2251	50.93	-21.69	29.24	43.50	-14.26	QP			
6	175.6516	51.54	-20.83	30.71	43.50	-12.79	QP			



5. Antenna Requirement

5.1. Test Standard and Requirement

Test Standard	FCC Part15 Section 15.203
Requirement	1) 15.203 requirement: An intentional radiator shall be designed to ensure that no antenna other than that furnished by the responsible party shall be used with the device. The use of a permanently attached antenna or of an antenna that uses a unique coupling to the intentional radiator, the manufacturer may design the unit so that a broken antenna can be replaced by the user, but the use of a standard antenna jack or electrical connector is prohibited.

5.2. Antenna Connected Construction

The antenna is a Inductive loop coil Antenna which permanently attached, and the best case gain of the antenna is 0 dBi. It complies with the standard requirement.



APPENDIX I -- TEST SETUP PHOTOGRAPH

Please refer to separated files Appendix I -- Test Setup Photograph

APPENDIX II -- EXTERNAL PHOTOGRAPH

Please refer to separated files Appendix II -- External Photograph

APPENDIX III -- INTERNAL PHOTOGRAPH

Please refer to separated files Appendix III -- Internal Photograph

----- End of Report -----

