



Test report

Number: T251-0399/22
Project file: C20220801
Date: 2022-06-14
Pages: 52

Product: Tracker

Type reference: Bonnie & Clyde

Ratings: 9-45 Vdc (internal Lithium Ion battery 3,6 Vdc; 2500 mAh)
Protection class: III

Trademark: **COMODULE** 

Applicant: **COMODULE OÜ**
Dunkri 9, 10123 Tallinn, Estonia

Manufacturer: COMODULE OÜ
Dunkri 9, 10123 Tallinn, Estonia

Place of manufacture: COMODULE OÜ
Dunkri 9, 10123 Tallinn, Estonia

Summary of testing

Testing method: 47 CFR Part 15, Subpart C (Clause 15.247) in conjunction with ANSI C63.10:2013

Testing location: SIQ Ljubljana, Mašera-Spasičeva ulica 10, SI-1000 Ljubljana, Slovenia

Remarks: Date of receipt of test items: 2021-07-09
Number of items tested: 4
Date of performance of tests: 2022-04-05 - 2022-04-09
The test results presented in this report relate only to the items tested.
The product complies with the requirements of the testing methods.

Tested by: Luka Cvajnar

Approved by: Marjan Mak

The report shall not be reproduced except in full.



CONTENTS	page
1 GENERAL	3
1.1 DESCRIPTION OF EQUIPMENT UNDER TEST	3
1.2 DESCRIPTION OF THE TEST MODES	4
1.3 TEST EQUIPMENT USED FOR TESTING	5
1.4 TEST SETUP CONFIGURATIONS	6
2 TEST SUMMARY	8
2.1 APPLICATION OF DECISION RULE	9
3 TESTS RESULTS	10
3.1 47 CFR § 15.203 – ANTENNA REQUIREMENTS	10
3.2 47 CFR § 15.207 – AC LINE CONDUCTED EMISSION	11
3.3 47 CFR § 15.247(D) - SPURIOUS EMISSION - CONDUCTED	12
3.4 47 CFR § 15.205, § 15.209, § 15.247 (D) – SPURIOUS EMISSION - RADIATED	14
3.5 47 CFR § 15.247 (A) (2) – 6 DB EMISSION BANDWIDTH	31
3.6 47 CFR § 15.247 (B) (3) – MAXIMUM PEAK OUTPUT POWER	36
3.7 47 CFR § 15.247 (D) –100 KHZ BANDWIDTH OF FREQUENCY BAND EDGE	37
3.8 47 CFR § 15.247 (E) – POWER SPECTRAL DENSITY	44
4 ANNEX I – ADDITIONAL DATA	48
4.1 OCCUPIED BANDWIDTH (99% EMISSION BANDWIDTH)	50

1 GENERAL

EUT passed the performed tests.

History sheet			
Date	Report No.	Change	Revision
2022-06-14	T251-0399/22	Initial Test Report issued.	--

1.1 Description of equipment under test

Tracker

Type: **Bonnie & Clyde**

FCC ID: **2AQHSF0010262**

Contains FCC ID: **XPYUBX18ZO01**

IC: **25027 – F0010262**

Contains IC: **8595A – UBX18ZO01**

Adaptive / non-adaptive equipment	non-adaptive equipment
Modulation type	Other than FHSS
Operating mode	Single antenna
Operating temperature range	-20 °C to +45 °C
Maximum RF Output power	8 dBm
Operating frequency	2402 MHz – 2480 MHz
Number of channels	40
Antenna type and gain	Integral antenna, 0 dBi
Antenna Beamforming	/
Nominal channel bandwidth	1 MHz, 2 MHz

COMODULE product uses nRF52840 Bluetooth 5.2 SoC. Nordic Semiconductor's precompiled Bluetooth stack (SoftDevice) is used to maintain compliance with Bluetooth protocol requirements. A custom Bluetooth service is built on top of that.

Radio parameters: 2.4 GHz ISM band, 8 dBm maximum transmitter power, GFSK modulation.





1.2 Description of the test modes

The equipment uses only one antenna at any moment.

On all devices run test firmware Bluetooth Direct Test Mode and accompanied by a USB-UART converter interface. For testing purposes sample with integral antenna and modified sample with added SMA connector was provided. For testing nRFgo Studio software program from Nordic Semiconductor was used.

1.2.1 Tested Channels

Channels	Data rate	Frequency [MHz]	TX power Settings [dBm]	Packet type	Packet length (bytes)
0 (Lowest)	1&2 Mbps	2402	8	PRBS9	37
19 (Middle)	1&2 Mbps	2440	8	PRBS9	37
39 (Highest)	1&2 Mbps	2480	8	PRBS9	37

Normal test condition:

Ambient temperature: 15 °C to 35 °C

Relative humidity: 30 % to 60 %

Atmospheric pressure: 860 mbar to 1060 mbar

1.3 Test Equipment used for testing

Manufacturer	Model No.	Used	Calibrated	Calibrated until
Comtest engineering, SAC2 (together with controlling equipment)	SAC 3m	X	2022-03-30	2025-03-30
Maturo, Turn table (2 m diameter)	TT 2.0 SI	X	/	/
Maturo, Bore-sight antenna mast	BAM-4.0-P	X	/	/
Maturo, positioning equipment	NCD	X	/	/
Rohde & Schwarz, RFI receiver	ESU 26	X	2021-05-10	2022-11-10
R&S, Ultra Broadband Antenna	HL562E	X	2020-09-30	2022-09-30
R&S, Horn Antenna	HF907	X	2020-08-21	2022-08-21
EMCO, Horn Antenna	EMCO 3116	X	2021-10-27	2024-10-27
R&S, Spectrum Analyzer	FSV 40	X	2021-04-30	2022-10-30
R&S, Vector signal generator	SMBV100B	/	/	/
R&S, Signal generator	SMB100A	X	2021-04-30	2022-10-30
R&S High resolution power meter	OSP-B157W8	X	2021-05-03	2022-11-03
R&S Switch unit	OSP-B157WX	X	2021-05-03	2022-11-03
Wainwright Instruments, High pass	WHNX6-2555-	X	2020-06-08	2023-06-08
Wainwright Instruments, High pass	WHNX6-5925-	/	/	/
Wainwright Instruments, High pass	WHW2-16340-	/	/	/
Hp, Manual step attenuator	8494B 11 DB	/	/	/
Hp, Manual step attenuator	8496B 110 DB	/	/	/
PMI Low noise amplifier	PEC-42-1G40G	X	2022-04-01	2023-10-01
KEYSIGHT, attenuator	8491B 10 DB	/	/	/

1.3.1 Measurement uncertainty

The following measurement uncertainty levels have been estimated for tests performed on the product, as specified in ETSI TR 100 028-2 and C63.23. This represents an expanded uncertainty expressed at 95% confidence level using a coverage factor $k=2$.

Measurements	U _{LAB}	U _{ETSI TR 100 028-2}	U _{C63.23}
AC Line Conducted Emission	3.2 dB	/	±4,13
Spurious emission 30 – 300 MHz	4.2 dB	±6	/
Spurious emission 300 – 1000 MHz	4.4 dB	±6	/
Spurious emission 1 GHz – 18 GHz	5.1 dB	±6	/
Spurious emission 18 GHz – 26GHz	5.6 dB	±6	/
Tx spurious emission - conducted	< 1.8 dB	±4	/
6 dB Emission Bandwidth	< 2%	±5%	/
Maximum peak output power	< 1 dB	±0,75 dB	/
100 kHz Bandwidth of Frequency Band Edge	< 0.8 dB	/	/
Power Spectral Density	< 1.3 dB	±3 dB	/
Occupied bandwidth (99% emission bandwidth)	< 2%	±5%	/

Note: Measurement uncertainty calculated in accordance with ETSI TR 100 028-2 and C63.23.

1.4 Test setup configurations

1.4.1 Conducted measurement test setup

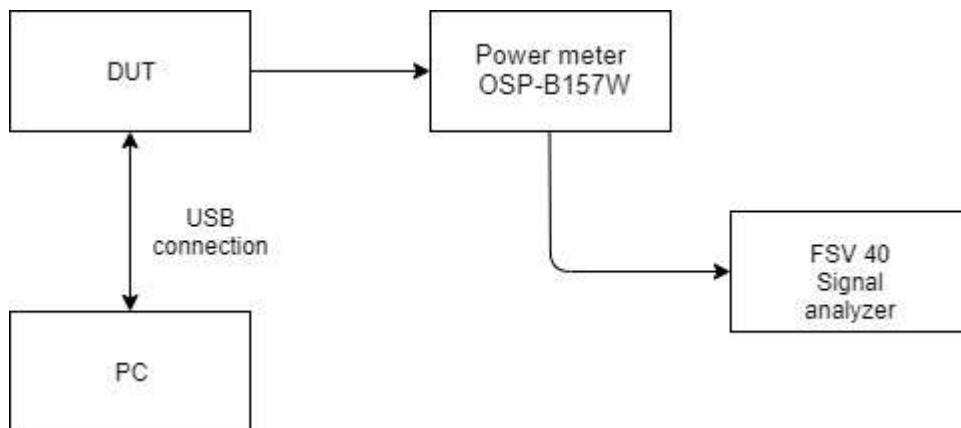

1.4.2 Radiated measurement test setup

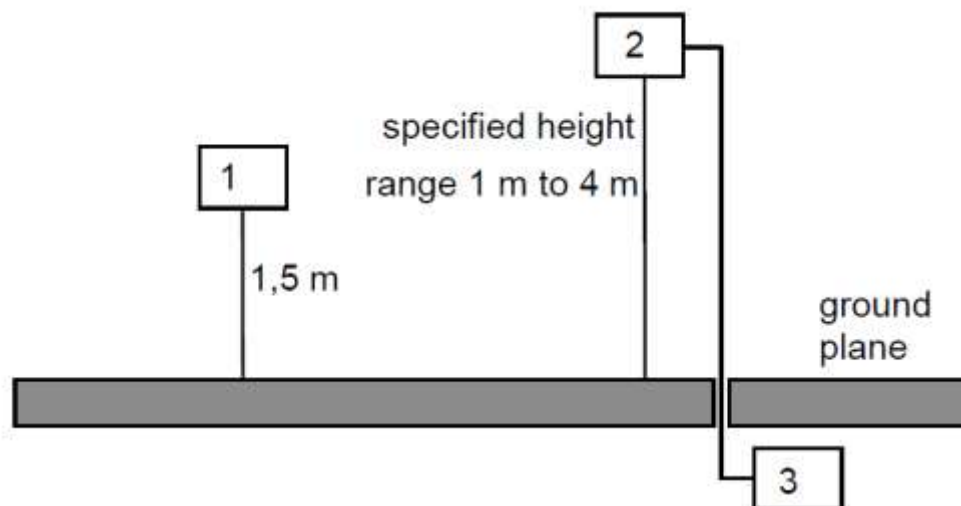

- 1) UUT
- 2) Measurement antenna
- 3) Measurement equipment

Note: Bellow 1G non-conductive Table 80 cm above ground plane and above 1G non-conductive Table 150 cm above ground plane.

1.4.3 AC Line Conducted Emission

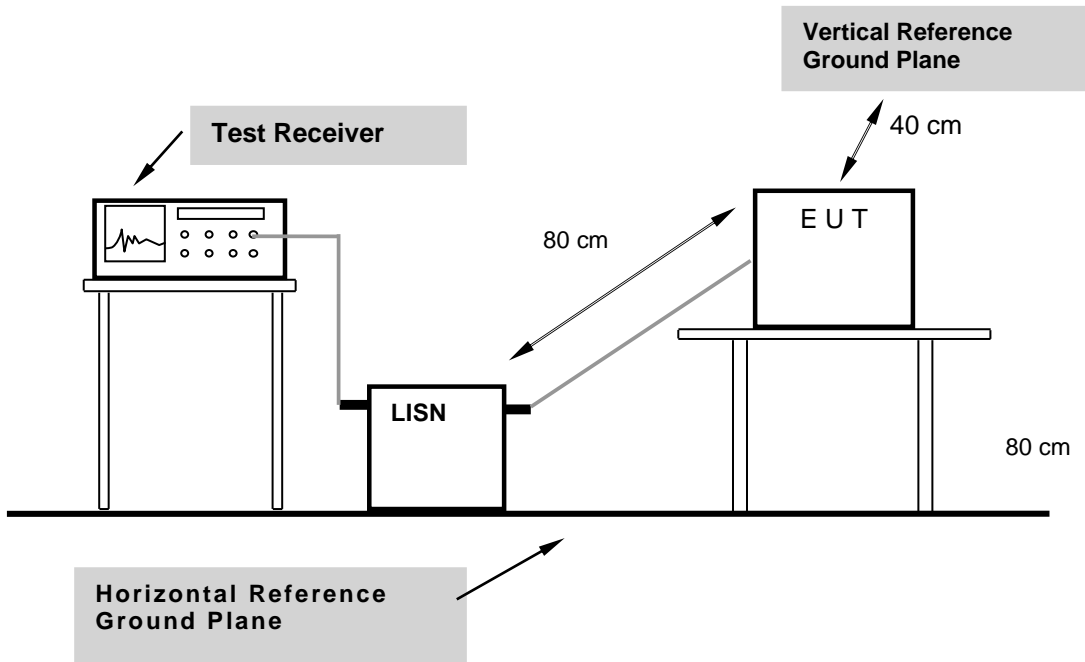

For the actual test configuration, please refer to the related item – Photographs of the Test Configuration.



2 TEST SUMMARY

47 CFR 15.247			
Test	47 CFR section	Section within the report	Conclusion
Antenna Requirement	§ 15.203	3.1	PASS
AC Line Conducted Emission	§ 15.207 (a)	3.2	N/A
Spurious emission - Conducted	§ 15.247 (d)	3.3	PASS
Spurious emission - Radiated	§ 15.205, § 15.209, § 15.247 (d)	3.4	PASS
6 dB Emission Bandwidth	§ 15.247 (a) (2)	3.5	PASS
Maximum peak output power	§ 15.247 (b) (3)	3.6	PASS
100 kHz Bandwidth of Frequency Band Edge	§ 15.247 (d)	3.7	PASS
Power Spectral Density	§ 15.247 (e)	3.8	PASS

2.1 Application of decision rule

Application of decision rule and statement of conformity is defined in document TN023 Decision rule and measurement uncertainty.

As a general rule Pass/Fail decisions are based on simple acceptance rule and acceptance limits chosen based on simple acceptance ($w = 0$, $AL = TL$) except if a decision rule is governed by particular standard or guidance document.

Decision rule:

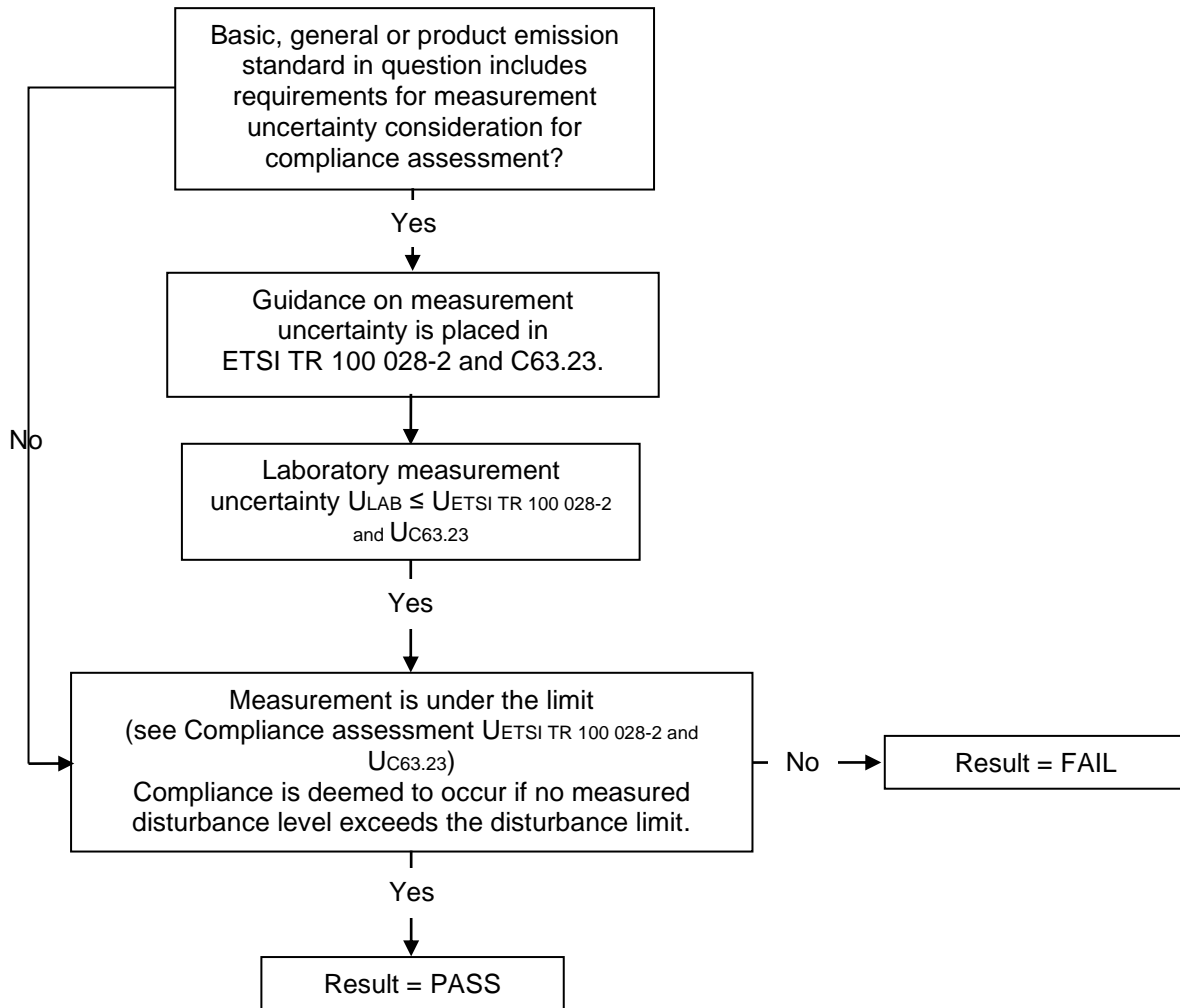



3 TESTS RESULTS

3.1 47 CFR § 15.203 – Antenna requirements

An intentional radiator shall be designed to ensure that no antenna other than that furnished by the responsible party shall be used with the device.

The use of a permanently attached antenna or of an antenna that uses a unique coupling to the intentional radiator shall be considered sufficient to comply with the provisions of this section. The manufacturer may design the unit so that a broken antenna can be replaced by the user, but the use of a standard antenna jack or electrical connector is prohibited.

According § 15.247 (b), if transmitting antennas of directional gain greater than 6 dBi are used, the conducted output power from the intentional radiator shall be reduced below the stated values in paragraphs § 15.247 (b)(1), (b)(2), and (b)(3) of this section, as appropriate, by the amount in dB that the directional gain of the antenna exceeds 6 dBi.

3.1.1 Antenna Details

Type	Gain	Result
PCB antenna	0 dBi	PASS

Comodule custom cellular and BLE combined antenna is used in the Clyde unit of the assembly. Bluetooth part of the antenna is connected via a second coax cable between the Bonnie and Clyde units. Antenna is located inside the Clyde enclosure and is not accessible externally.

3.2 47 CFR § 15.207 – AC Line Conducted Emission

For an intentional radiator that is designed to be connected to the public utility (AC) power line, the radio frequency voltage that is conducted back onto the AC power line on any frequency or frequencies, within the band 150 kHz to 30 MHz, shall not exceed the limits in the following table, as measured using a 50 μ H/50 ohms line impedance stabilization network (LISN). Compliance with the provisions of this paragraph shall be based on the measurement of the radio frequency voltage between each power line and ground at the power terminal. The lower limit applies at the boundary between the frequency ranges.

Frequency of Emission (MHz)	Conducted Limit (dBuV)	
	Quasi-Peak	Average
0.15–0.5	66 to 56*	56 to 46
0.5-5	56	46
5-30	60	50

*Decreases with the logarithm of the frequency.

3.2.1 Test procedure

EMI test receiver was set to investigate from 150 kHz to 30 MHz with the 9 kHz RBW. During conducted emission EUT was connected to a LISN and maximum emissions was recorded in the QP and average detection mode.

3.2.2 Test setup

For the test setup refer to chapter 1.4.

3.2.3 Test equipment

For the test equipment refer to chapter 1.3.

3.2.4 Test results

Test not applicable due to battery powered equipment.



3.3 47 CFR § 15.247(d) - Spurious emission - Conducted

§ 15.247 (d):

In any 100 kHz bandwidth outside the frequency band in which the spread spectrum or digitally modulated intentional radiator is operating, the radio frequency power that is produced by the intentional radiator shall be at least 20 dB below that in the 100 kHz bandwidth within the band that contains the highest level of the desired power, based on either an RF conducted or a radiated measurement, provided the transmitter demonstrates compliance with the peak conducted power limits. If the transmitter complies with the conducted power limits based on the use of RMS averaging over a time interval, as permitted under paragraph (b)(3) of this section, the attenuation required under this paragraph shall be 30 dB instead of 20 dB attenuation below the general limits specified in § 15.209(a) is not required. In addition, radiated emissions which fall in the restricted bands, as defined in § 15.205(a), must also comply with the radiated emission limits specified in § 15.209(a) (see § 15.205(c)).

3.3.1 Test setup

For the test setup refer to chapter 1.4

3.3.2 Test equipment

For the test equipment refer to chapter 1.3

3.3.3 Test results

Channel 2402 MHz:

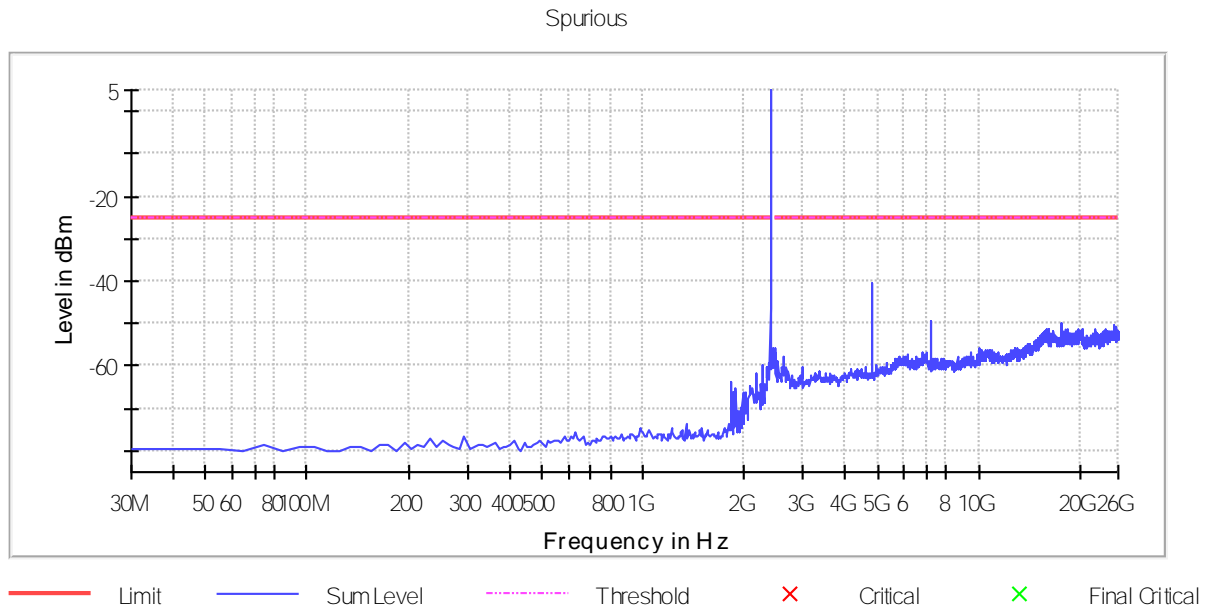

Channel 2440 MHz:

Spurious

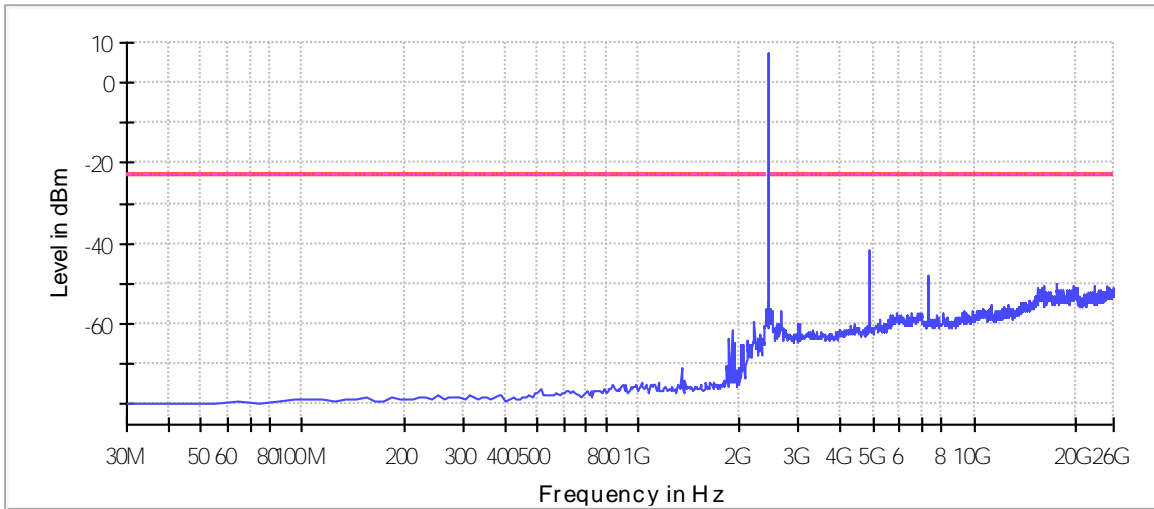

— Limit — Sum Level - - - Threshold × Critical × Final Critical

Channel 2480 MHz:

Spurious

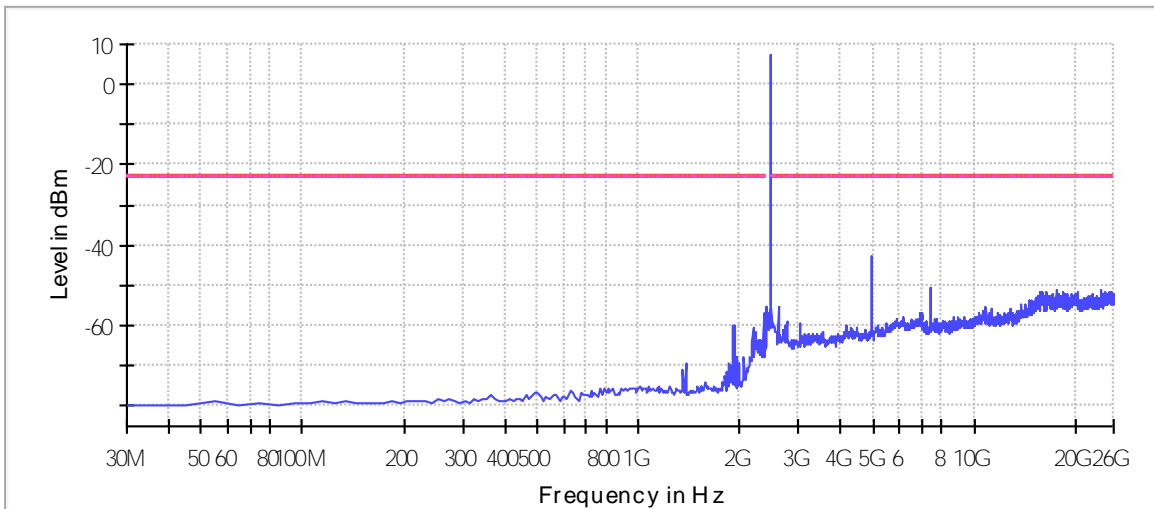

— Limit — Sum Level - - - Threshold × Critical × Final Critical



3.4 47 CFR § 15.205, § 15.209, § 15.247 (d) – Spurious emission - Radiated

§ 15.247 (d):

In any 100 kHz bandwidth outside the frequency band in which the spread spectrum or digitally modulated intentional radiator is operating, the radio frequency power that is produced by the intentional radiator shall be at least 20 dB below that in the 100 kHz bandwidth within the band that contains the highest level of the desired power, based on either an RF conducted or a radiated measurement, provided the transmitter demonstrates compliance with the peak conducted power limits. If the transmitter complies with the conducted power limits based on the use of RMS averaging over a time interval, as permitted under paragraph (b)(3) of this section, the attenuation required under this paragraph shall be 30 dB instead of 20 dB attenuation below the general limits specified in § 15.209(a) is not required. In addition, radiated emissions which fall in the restricted bands, as defined in § 15.205(a), must also comply with the radiated emission limits specified in § 15.209(a) (see § 15.205(c)).

§ 15.205:

Except as provided in paragraphs (d) and (e) of this section, the field strength of emissions appearing within these frequency bands shall not exceed the limits shown in § 15.209. At frequencies equal to or less than 1000 MHz, compliance with the limits in § 15.209 shall be demonstrated using measurement instrumentation employing a CISPR quasi-peak detector. Above 1000 MHz, compliance with the emission limits in § 15.209 shall be demonstrated based on the average value of the measured emissions. The provisions in § 15.35 apply to these measurements.

§ 15.209:

Except as provided elsewhere in this subpart, the emissions from an intentional radiator shall not exceed the field strength levels specified in the following table:

Frequency (MHz)	Field strength (microvolts/ meter)	Measurement distance (meters)
0.009-0.49	2400/F(kHz)	300
0.49-1.705	24000/F(kHz)	30
1.705-30	30	30
30-88	100*	3
88-216	150*	3
216-960	200*	3
Above 960	500	3

* Except as provided in paragraph (g), fundamental emissions from intentional radiators operating under this section shall not be located in the frequency bands 54-72 MHz, 76-88 MHz, 174-216 MHz or 470-806 MHz. However, operation within these frequency bands is permitted under other sections of this part, e.g., §§ 15.231 and 15.241.

§ 15.35:

Unless otherwise specified, on any frequency or frequencies above 1000 MHz, the radiated emission limits are based on the use of measurement instrumentation employing an average detector function. Unless otherwise specified, measurements above 1000 MHz shall be performed using a minimum resolution bandwidth of 1 MHz. When average radiated emission measurements are specified in this part, including average emission measurements below 1000 MHz, there also is a limit on the peak level of the radio frequency emissions. Unless otherwise specified, **e.g.**, see §§ 15.250, 15.252, 15.253(d), 15.255, 15.256, and 15.509 through 15.519, the limit on peak radio frequency emissions is 20 dB above the maximum permitted average emission limit applicable to the equipment under test. This peak limit applies to the total peak emission level radiated by the device, e.g., the total peak power level. Note that the use of a pulse desensitization correction factor may be needed to determine the total peak emission level. The instruction manual or application note for the measurement instrument should be consulted for determining pulse desensitization factors, as necessary.

3.4.1 Test procedure

According to ANSI C63.10-2013:

Preliminary tests shall be performed following the procedures in 6.3 on a site meeting the requirements of 5.2. For emissions from the EUT, the maximum level shall be determined by rotating the EUT and its antenna through 0° to 360°. For each mode of operation required to be tested, the frequency spectrum (based on findings from exploratory measurements) shall be monitored.

Final measurements are performed with the EUT rotated from 0° to 360°; the antenna height scanned in accordance with 6.6.3.1, 6.6.3.2, or 6.6.3.3, as appropriate; and the antenna rotated to repeat the measurements for both the horizontal and vertical antenna polarizations. Variations in cable or wire placement shall be explored to maximize the measured emissions.

The emission signal shall be kept within the illumination area of the 3 dB beamwidth of the antenna so that the maximum emission from the EUT is measured. This may be achieved by either pointing the

3.4.2 Test setup

For the test setup refer to chapter 1.4.

3.4.3 Test equipment

For the test equipment refer to chapter 1.3.

3.4.4 Test results



Radiated measurement:

Channel 2402 MHz:

EUT Information

EUT: Bonnie & Clyde
 Operating mode: TX 2402 MHz

Full Spectrum

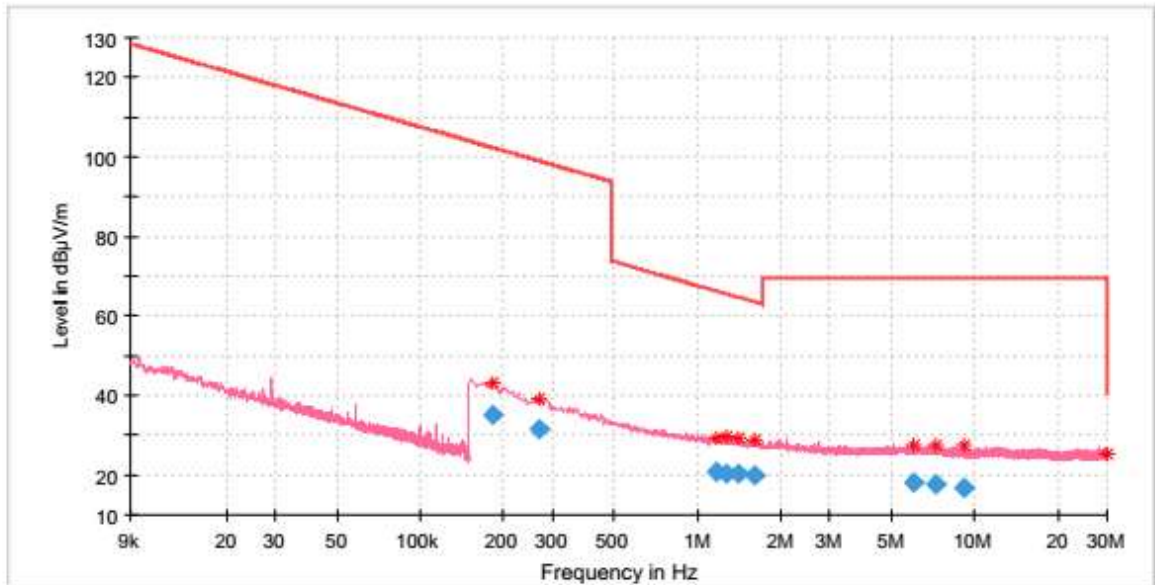

Final Result

Frequency (MHz)	QuasiPeak (dBµV/m)	Limit (dBµV/m)	Margin (dB)	Height (cm)	Pol	Azimuth (deg)
0.183750	34.98	102.32	67.33	100.0	V	122.0
0.269250	31.36	99.00	67.63	100.0	V	256.0
1.171500	20.69	66.25	45.57	100.0	V	235.0
1.275000	20.35	65.52	45.17	100.0	V	68.0
1.416750	20.16	64.60	44.44	100.0	V	0.0
1.614750	19.78	63.47	43.69	100.0	V	98.0
5.973000	17.98	69.50	51.52	100.0	V	232.0
7.199250	17.40	69.50	52.10	100.0	V	190.0
9.150000	16.81	69.50	52.69	100.0	V	186.0

EUT Information

EUT:

Bonnie & Clyde

Operating mode:

TX 2402 MHz

Full Spectrum

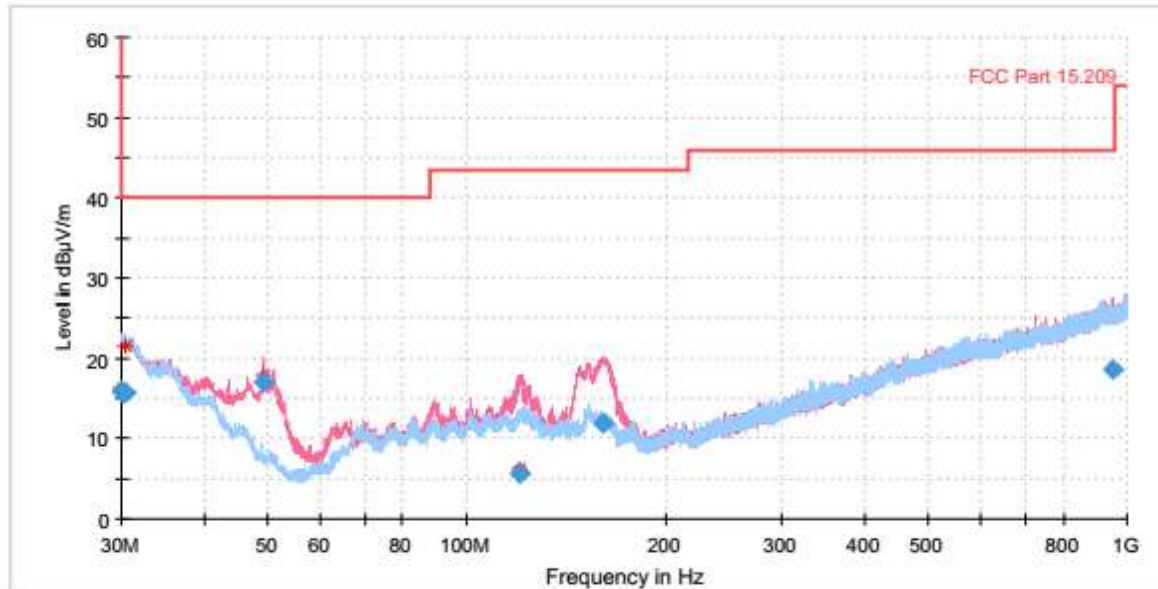

Final Result

Frequency (MHz)	QuasiPeak (dBµV/m)	Limit (dBµV/m)	Margin (dB)	Height (cm)	Pol	Azimuth (deg)
30.030000	15.84	40.00	24.16	106.0	H	295.0
30.270000	15.72	40.00	24.28	103.0	V	0.0
30.420000	15.75	40.00	24.25	104.0	H	129.0
49.350000	16.98	40.00	23.02	103.0	V	245.0
120.600000	5.60	43.50	37.90	182.0	V	85.0
161.010000	11.88	43.50	31.62	100.0	V	13.0
949.680000	18.55	46.00	27.45	184.0	V	328.0



EUT Information

EUT: Bonnie & Clyde
 Operating mode: TX 2402 MHz

Full Spectrum

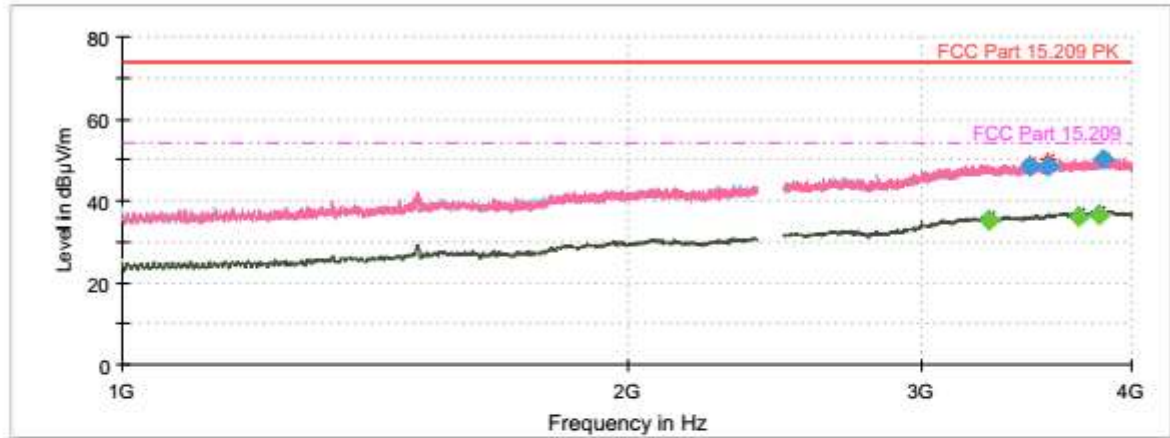

- Preview Result 2H-AVG
- Preview Result 1V-PK+
- FCC Part 15.209 PK
- ◆ Final_Result AVG
- Preview Result 1H-PK+
- * Critical_Freqs AVG
- - - FCC Part 15.209
- Preview Result 2V-AVG
- * Critical_Freqs PK+
- ◆ Final_Result PK+

Comment

Final Result

Frequency (MHz)	MaxPeak (dBµV/m)	Average (dBµV/m)	Limit (dBµV/m)	Margin (dB)	Height (cm)	Pol	Azimuth (deg)
3287.500000	---	35.13	54.00	18.87	150.0	H	359.0
3481.000000	48.56	---	74.00	25.44	150.0	V	317.0
3563.750000	48.55	---	74.00	25.45	150.0	V	69.0
3714.250000	---	35.90	54.00	18.10	150.0	V	103.0
3824.750000	---	36.54	54.00	17.46	150.0	H	355.0
3845.000000	50.04	---	74.00	23.96	150.0	V	272.0

EUT Information

EUT:
Operating mode:

Bonnie & Clyde
TX 2402 MHz

Full Spectrum

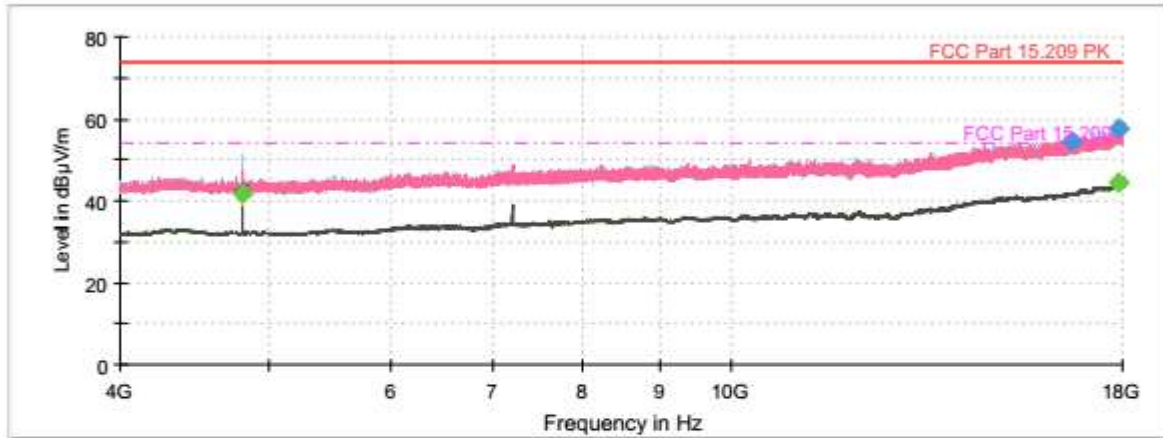

- Preview Result 2H-AVG
- Preview Result 1V-PK+
- FCC Part 15.209 PK
- ◆ Final_Result AVG
- Preview Result 1H-PK+
- * Critical_Freqs AVG
- - - FCC Part 15.209
- Preview Result 2V-AVG
- * Critical_Freqs PK+
- ◆ Final_Result PK+

Comment

Final Result

Frequency (MHz)	MaxPeak (dBµV/m)	Average (dBµV/m)	Limit (dBµV/m)	Margin (dB)	Height (cm)	Pol	Azimuth (deg)
4804.250000	---	41.64	54.00	12.36	150.0	H	0.0
16693.750000	54.51	---	74.00	19.49	150.0	V	0.0
17873.250000	---	44.36	54.00	9.64	150.0	V	0.0
17906.000000	57.45	---	74.00	16.55	150.0	V	359.0



EUT Information

EUT: Bonnie & Clyde
 Operating mode: TX 2402 MHz

Full Spectrum

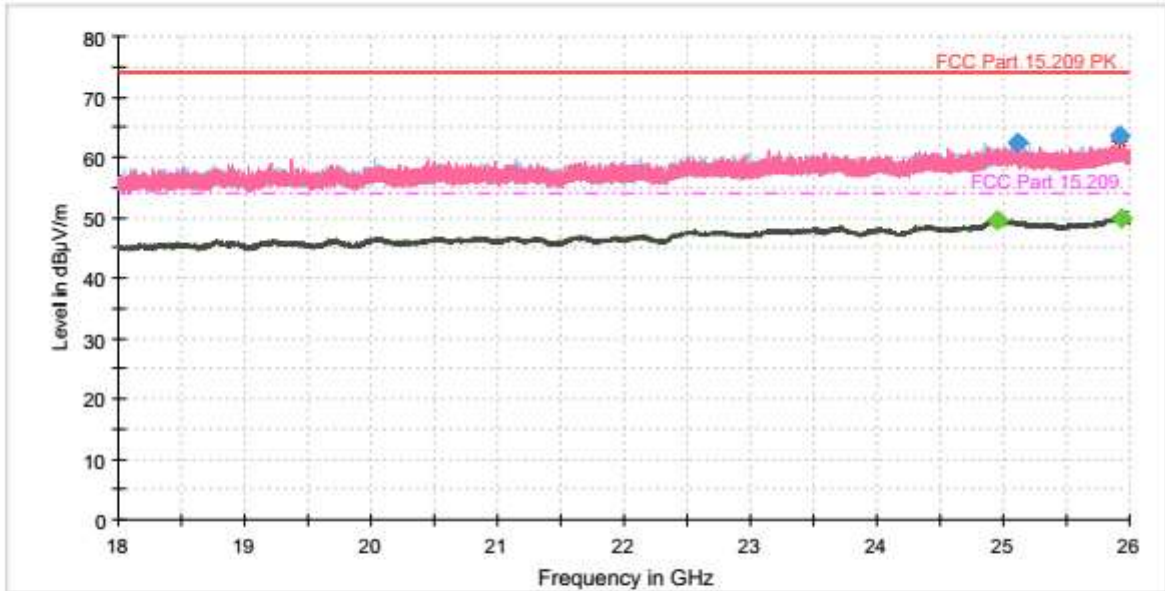

Final Result

Frequency (MHz)	MaxPeak (dBµV/m)	Average (dBµV/m)	Limit (dBµV/m)	Margin (dB)	Height (cm)	Pol	Azimuth (deg)
24943.750000	---	49.49	54.00	4.51	160.0	V	0.0
25110.500000	62.39	---	74.00	11.61	160.0	V	0.0
25915.000000	63.54	---	74.00	10.46	160.0	V	0.0
25942.500000	---	49.92	54.00	4.08	160.0	H	0.0

Channel 2440 MHz:

EUT Information

EUT: Bonnie & Clyde
 Operating mode: TX 2440 MHz

Full Spectrum

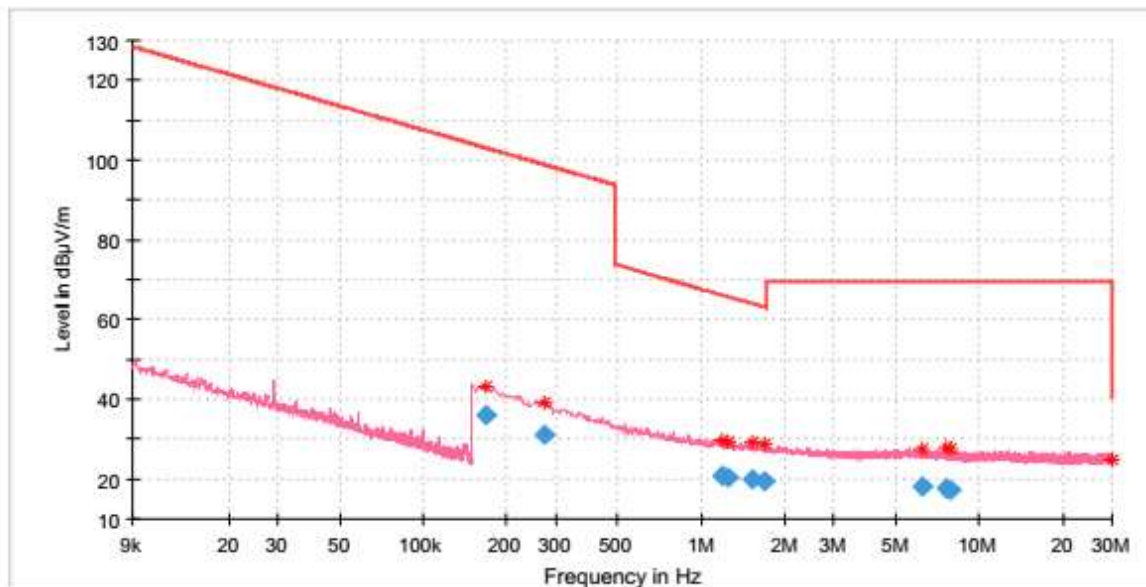

Final Result

Frequency (MHz)	QuasiPeak (dBµV/m)	Limit (dBµV/m)	Margin (dB)	Height (cm)	Pol	Azimuth (deg)
0.168000	36.02	103.09	67.07	100.0	V	190.0
0.273750	31.26	98.85	67.59	100.0	V	40.0
1.196250	20.67	66.07	45.40	100.0	V	17.0
1.252500	20.49	65.67	45.18	100.0	V	83.0
1.536000	19.83	63.90	44.07	100.0	V	0.0
1.693500	19.35	63.06	43.71	100.0	V	350.0
6.225000	17.87	69.50	51.63	100.0	V	156.0
7.662750	17.49	69.50	52.01	100.0	V	0.0
7.860750	17.18	69.50	52.32	100.0	V	119.0



EUT Information

EUT: Bonnie & Clyde
 Operating mode: TX 2440 MHz

Full Spectrum

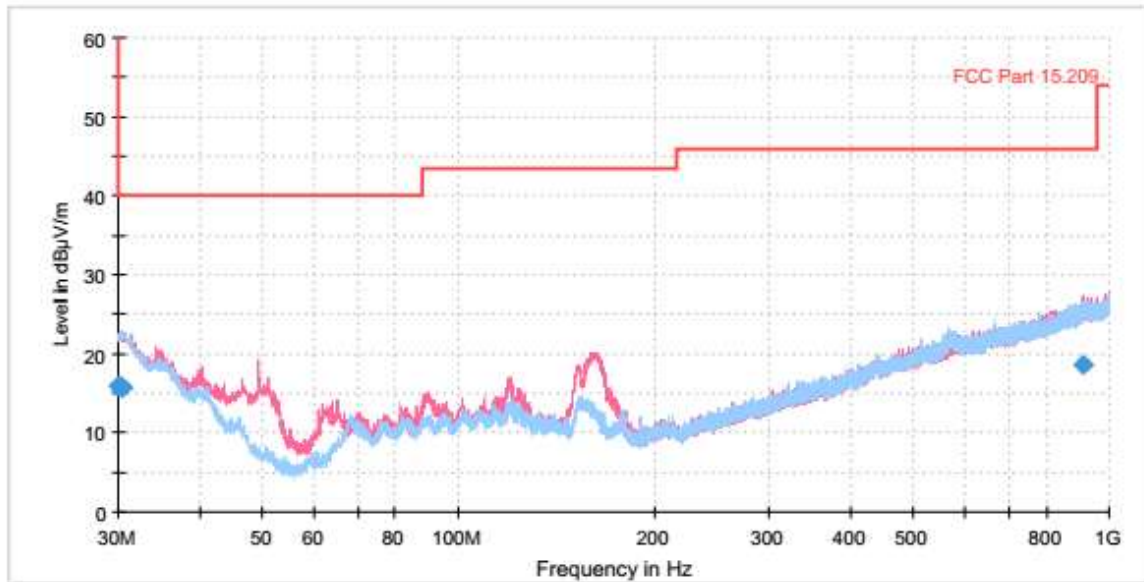

Final Result

Frequency (MHz)	QuasiPeak (dBµV/m)	Limit (dBµV/m)	Margin (dB)	Height (cm)	Pol	Azimuth (deg)
30.060000	15.83	40.00	24.17	123.0	V	257.0
30.180000	15.80	40.00	24.20	181.0	H	359.0
30.360000	15.70	40.00	24.30	104.0	V	0.0
915.090000	18.54	46.00	27.46	100.0	V	340.0

EUT Information

EUT: Bonnie & Clyde
 Operating mode: TX 2440 MHz

Full Spectrum

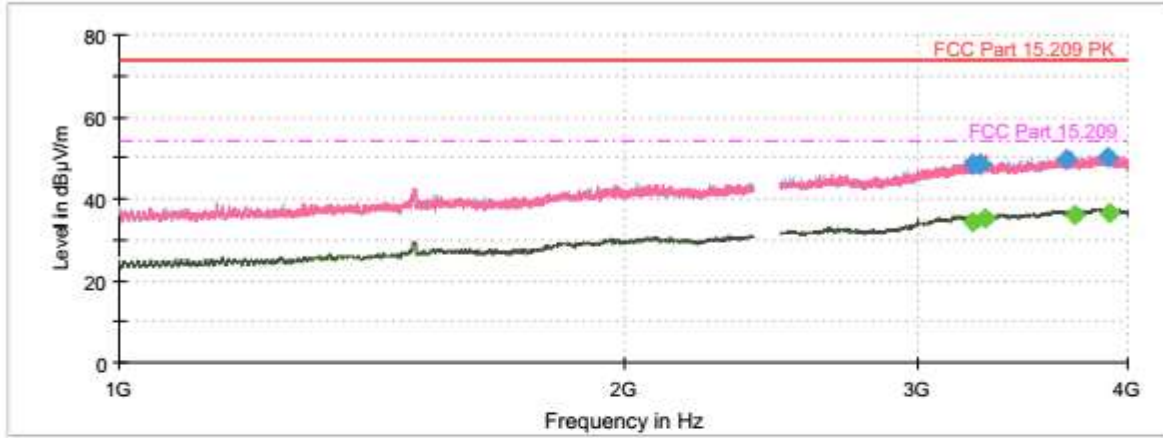

- ◆ Preview Result 2H-AVG
- ◆ Preview Result 1V-PK+
- FCC Part 15.209 PK
- ◆ Final_Result AVG
- * Preview Result 1H-PK+
- * Critical_Freqs AVG
- ◆ Preview Result 2V-AVG
- ◆ Critical_Freqs PK+
- ◆ Final_Result PK+

Comment

Final Result

Frequency (MHz)	MaxPeak (dBµV/m)	Average (dBµV/m)	Limit (dBµV/m)	Margin (dB)	Height (cm)	Pol	Azimuth (deg)
3229.000000	48.50	---	74.00	25.50	125.0	V	122.0
3229.750000	---	34.37	54.00	19.63	175.0	H	60.0
3268.000000	48.16	---	74.00	25.84	128.0	H	266.0
3286.250000	---	35.08	54.00	18.92	175.0	V	151.0
3680.750000	49.66	---	74.00	24.34	175.0	V	90.0
3716.000000	---	35.93	54.00	18.07	164.0	V	210.0
3886.000000	50.31	---	74.00	23.69	151.0	V	256.0
3900.250000	---	36.60	54.00	17.40	175.0	H	151.0



EUT Information

EUT: Bonnie & Clyde
 Operating mode: TX 2440 MHz

Full Spectrum

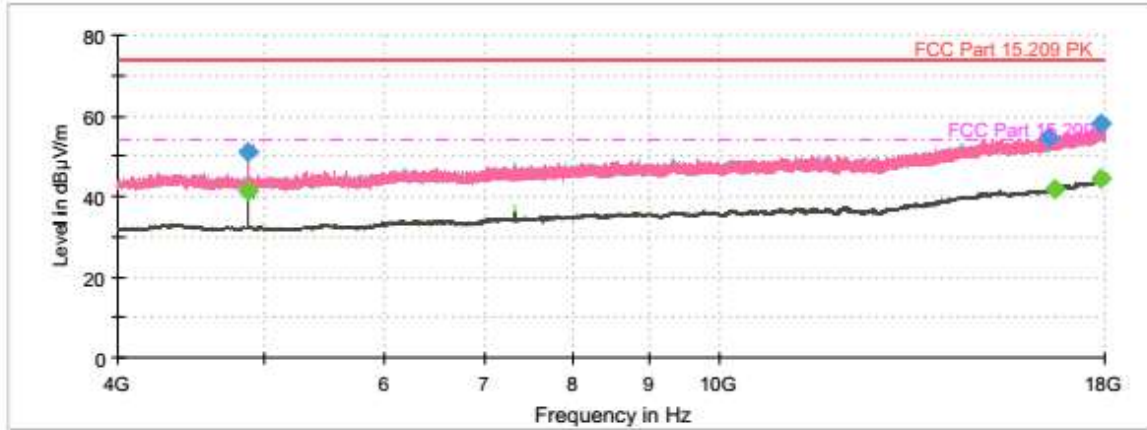

- ◆ Preview Result 2H-AVG
- Preview Result 1V-PK+
- FCC Part 15.209 PK
- ◆ Final_Result AVG
- * Preview Result 1H-PK+ Critical_Freqs AVG
- - - FCC Part 15.209
- * Preview Result 2V-AVG Critical_Freqs PK+
- ◆ Final_Result PK+

Comment

Final Result

Frequency (MHz)	MaxPeak (dBµV/m)	Average (dBµV/m)	Limit (dBµV/m)	Margin (dB)	Height (cm)	Pol	Azimuth (deg)
4879.750000	50.97	---	74.00	23.03	175.0	H	359.0
4880.500000	---	41.42	54.00	12.58	154.0	H	359.0
16527.000000	54.30	---	74.00	19.70	125.0	V	180.0
16653.250000	---	41.79	54.00	12.21	143.0	V	0.0
17873.250000	---	44.52	54.00	9.48	166.0	V	0.0
17883.000000	57.98	---	74.00	16.02	125.0	V	180.0

EUT Information

EUT: Bonnie & Clyde
 Operating mode: TX 2440 MHz

Full Spectrum

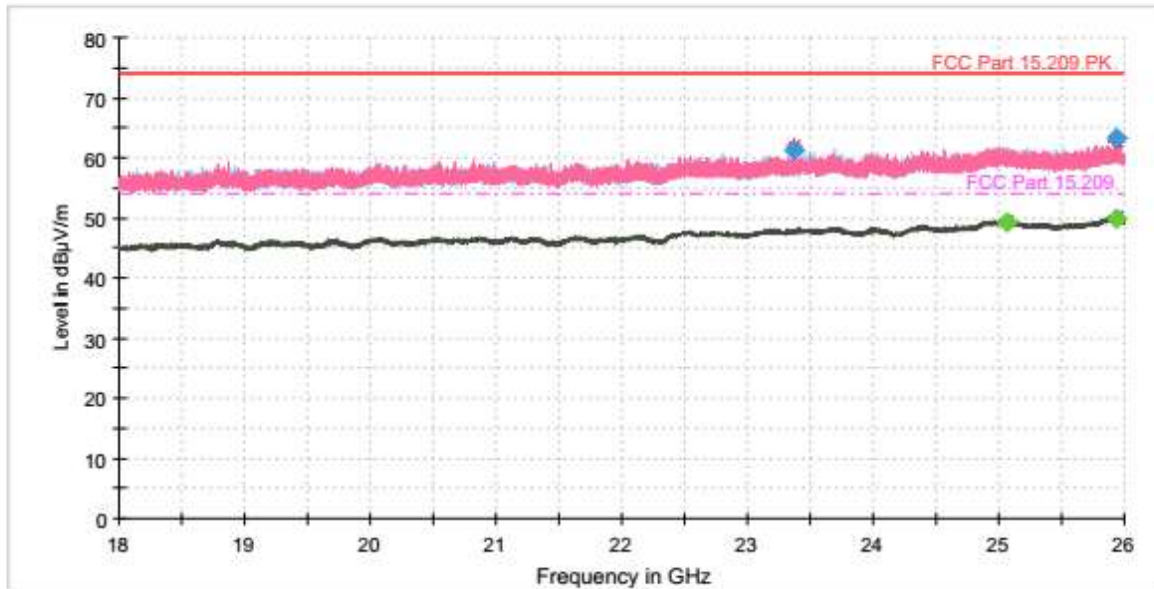

Final Result

Frequency (MHz)	MaxPeak (dBµV/m)	Average (dBµV/m)	Limit (dBµV/m)	Margin (dB)	Height (cm)	Pol	Azimuth (deg)
23378.000000	61.05	---	74.00	12.95	160.0	V	0.0
25065.000000	---	49.33	54.00	4.67	160.0	V	0.0
25927.750000	63.25	---	74.00	10.75	160.0	V	0.0
25929.000000	---	49.86	54.00	4.14	160.0	H	0.0



Channel 2480 MHz:

EUT Information

EUT: Bonnie & Clyde
 Operating mode: TX 2480 MHz

Full Spectrum

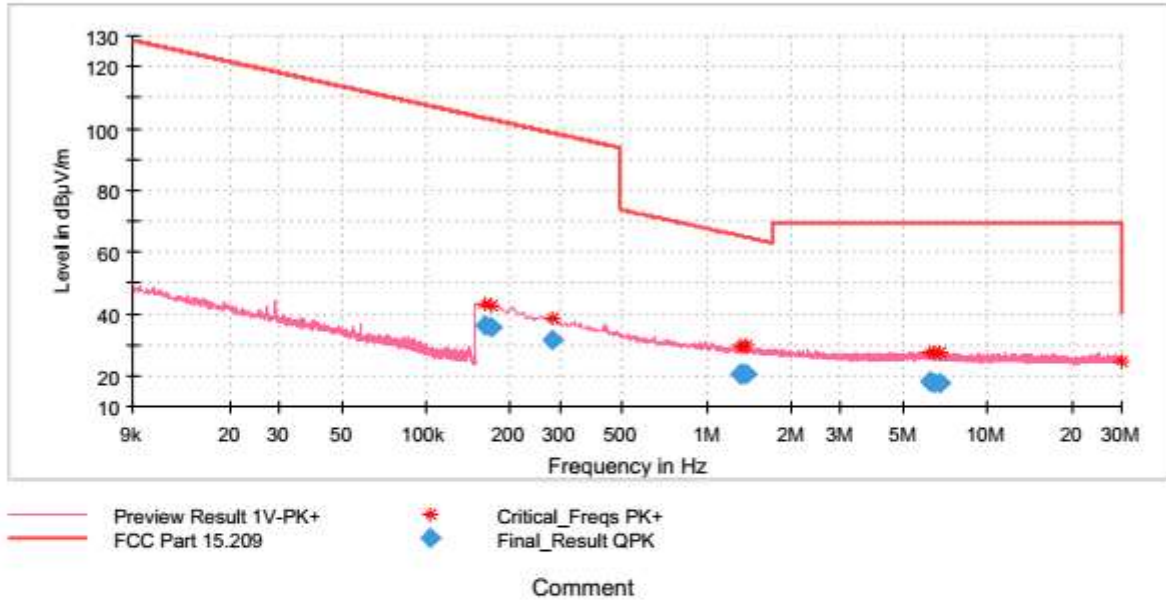

Final Result

Frequency (MHz)	QuasiPeak (dBµV/m)	Limit (dBµV/m)	Margin (dB)	Height (cm)	Pol	Azimuth (deg)
0.161250	35.95	103.45	67.50	100.0	V	163.0
0.170250	35.86	102.98	67.11	100.0	V	61.0
0.280500	31.83	98.64	66.81	100.0	V	356.0
1.308750	20.23	65.29	45.06	100.0	V	99.0
1.342500	20.32	65.07	44.75	100.0	V	319.0
1.383000	20.34	64.81	44.47	100.0	V	259.0
6.180000	17.92	69.50	51.58	100.0	V	7.0
6.434250	17.81	69.50	51.69	100.0	V	290.0
6.771750	17.78	69.50	51.72	100.0	V	207.0

EUT Information

EUT:

Bonnie & Clyde

Operating mode:

TX 2480 MHz

Full Spectrum

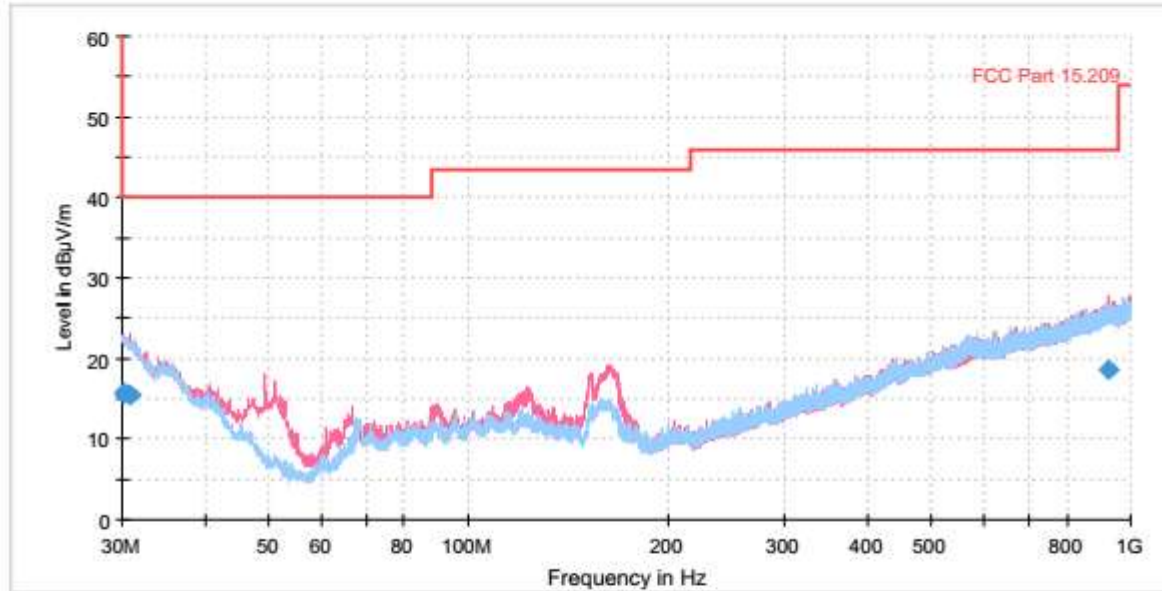

Final Result

Frequency (MHz)	QuasiPeak (dBµV/m)	Limit (dBµV/m)	Margin (dB)	Height (cm)	Pol	Azimuth (deg)
30.120000	15.78	40.00	24.22	125.0	H	355.0
30.180000	15.74	40.00	24.26	162.0	V	97.0
30.810000	15.39	40.00	24.61	103.0	V	345.0
924.360000	18.60	46.00	27.40	123.0	V	308.0



EUT Information

EUT: Bonnie & Clyde
 Operating mode: TX 2480 MHz

Full Spectrum

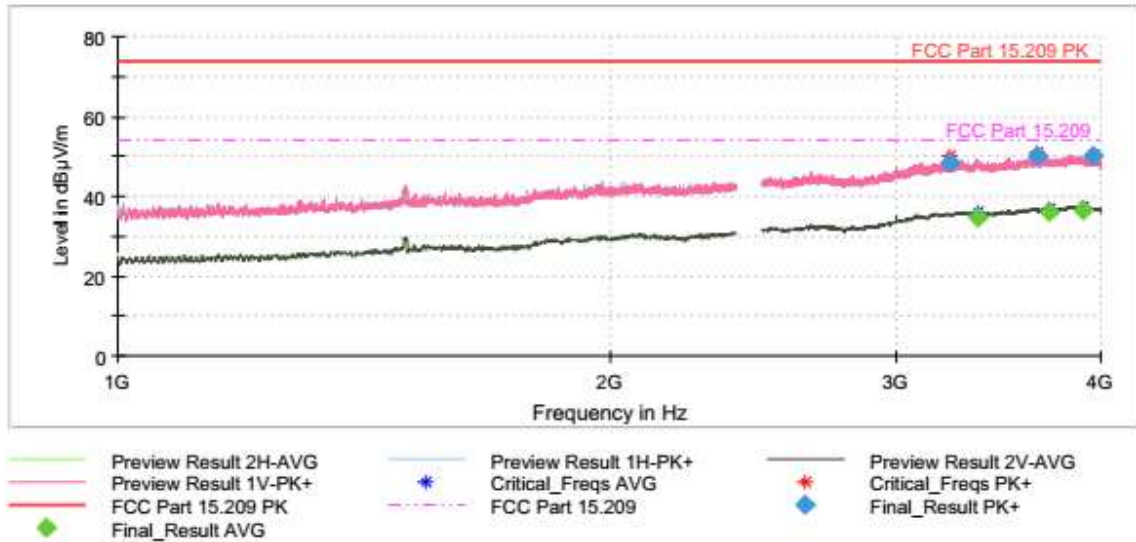

Comment

Final Result

Frequency (MHz)	MaxPeak (dBµV/m)	Average (dBµV/m)	Limit (dBµV/m)	Margin (dB)	Height (cm)	Poi	Azimuth (deg)
3231.750000	48.37	---	74.00	25.63	150.0	V	358.0
3361.000000	---	34.87	54.00	19.13	150.0	V	284.0
3654.250000	50.22	---	74.00	23.78	150.0	H	356.0
3714.500000	---	35.89	54.00	18.11	150.0	V	0.0
3900.500000	---	36.60	54.00	17.40	150.0	H	358.0
3954.250000	50.00	---	74.00	24.00	150.0	H	219.0

EUT Information

EUT: Bonnie & Clyde
 Operating mode: TX 2480 MHz

Full Spectrum

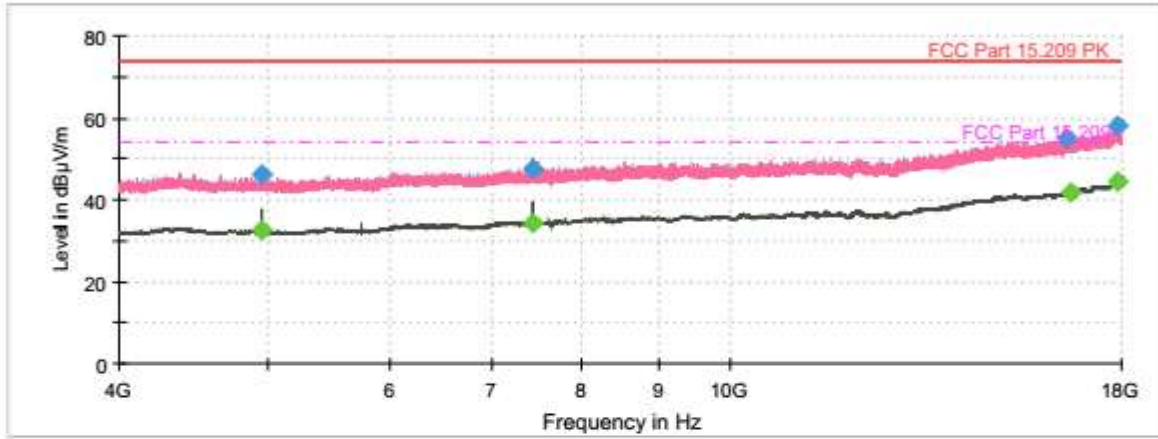

- Preview Result 2H-AVG
- Preview Result 1V-PK+
- FCC Part 15.209 PK
- ◆ Final_Result AVG
- * Preview Result 1H-PK+
- * Critical_Freqs AVG
- ◆ FCC Part 15.209
- * Preview Result 2V-AVG
- * Critical_Freqs PK+
- ◆ Final_Result PK+

Comment

Final Result

Frequency (MHz)	MaxPeak (dBµV/m)	Average (dBµV/m)	Limit (dBµV/m)	Margin (dB)	Height (cm)	Pol	Azimuth (deg)
4960.000000	46.04	---	74.00	27.96	166.0	V	357.0
4960.000000	---	32.49	54.00	21.51	125.0	V	357.0
7439.750000	---	34.15	54.00	19.85	129.0	V	357.0
7441.000000	47.30	---	74.00	26.70	141.0	V	357.0
16598.750000	55.03	---	74.00	18.97	154.0	H	0.0
16662.750000	---	41.82	54.00	12.19	141.0	H	359.0
17873.250000	---	44.44	54.00	9.56	175.0	H	0.0
17879.250000	57.97	---	74.00	16.03	175.0	V	0.0



EUT Information

EUT: Bonnie & Clyde
 Operating mode: TX 2480 MHz

Full Spectrum

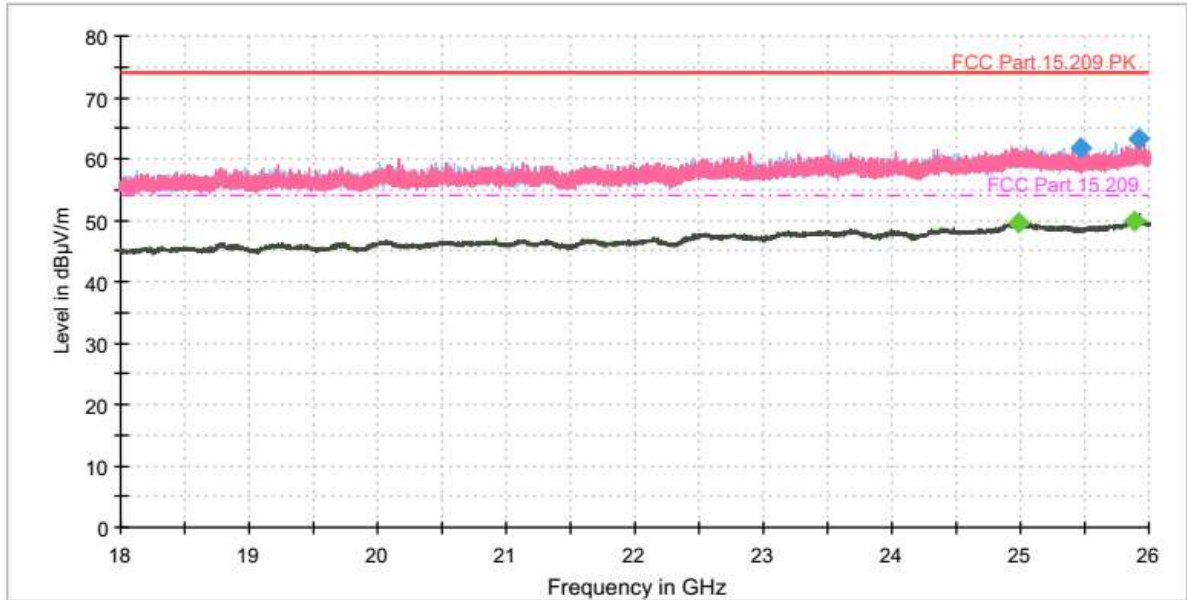

Final Result

Frequency (MHz)	MaxPeak (dBµV/m)	Average (dBµV/m)	Limit (dBµV/m)	Margin (dB)	Height (cm)	Pol	Azimuth (deg)
24979.750000	---	49.44	54.00	4.56	160.0	H	0.0
25469.500000	61.78	---	74.00	12.22	160.0	H	0.0
25888.250000	---	49.81	54.00	4.19	160.0	V	0.0
25911.500000	63.27	---	74.00	10.73	160.0	H	0.0

3.5 47 CFR § 15.247 (a) (2) – 6 dB Emission Bandwidth

Systems using digital modulation techniques may operate in the 902-928 MHz, 2400-2483.5 MHz, and 5725-5850 MHz bands. The minimum 6 dB bandwidth shall be at least 500 kHz.

3.5.1 Test procedure

According to ANSI C63.10-2013:

- a) The spectrum analyzer center frequency is set to the nominal EUT channel center frequency. The span range for the EMI receiver or spectrum analyzer shall be between two times and five times the OBW.
- b) The nominal IF filter bandwidth (3 dB RBW) shall be in the range of 1% to 5% of the OBW and video bandwidth (VBW) shall be approximately three times RBW, unless otherwise specified by the applicable requirement.
- c) Set the reference level of the instrument as required, keeping the signal from exceeding the maximum input mixer level for linear operation. In general, the peak of the spectral envelope shall be more than $[10 \log (OBW/RBW)]$ below the reference level. Specific guidance is given in 4.1.5.2.
- d) Steps a) through c) might require iteration to adjust within the specified tolerances.
- e) The dynamic range of the instrument at the selected RBW shall be more than 10 dB below the target “-xx dB down” requirement; that is, if the requirement calls for measuring the -20 dB OBW, the instrument noise floor at the selected RBW shall be at least 30 dB below the reference value.
- f) Set detection mode to peak and trace mode to max hold.
- g) Determine the reference value: Set the EUT to transmit an unmodulated carrier or modulated signal, as applicable. Allow the trace to stabilize. Set the spectrum analyzer marker to the highest level of the displayed trace (this is the reference value).
- h) Determine the “-xx dB down amplitude” using $[(\text{reference value}) - xx]$. Alternatively, this calculation may be made by using the marker-delta function of the instrument.
- i) If the reference value is determined by an unmodulated carrier, then turn the EUT modulation ON, and either clear the existing trace or start a new trace on the spectrum analyser and allow the new trace to stabilize. Otherwise, the trace from step g) shall be used for step j).
- j) Place two markers, one at the lowest frequency and the other at the highest frequency of the envelope of the spectral display, such that each marker is at or slightly below the “-xx dB down amplitude” determined in step h). If a marker is below this “-xx dB down amplitude” value, then it shall be as close as possible to this value. The occupied bandwidth is the frequency difference between the two markers. Alternatively, set a marker at the lowest frequency of the envelope of the spectral display, such that the marker is at or slightly below the “-xx dB down amplitude” determined in step h). Reset the marker-delta function and move the marker to the other side of the emission until the delta marker amplitude is at the same level as the reference marker amplitude. The marker-delta frequency reading at this point is the specified emission bandwidth.
- k) The occupied bandwidth shall be reported by providing plot(s) of the measuring instrument display; the plot axes and the scale units per division shall be clearly labeled. Tabular data may be reported in addition to the plot(s).



3.5.2 Test setup

For the test setup refer to chapter 1.4.

3.5.3 Test equipment

For the test setup refer to chapter 1.3.

3.5.4 Test results

Channel 2402 MHz:

DUT Frequency (MHz)	Bandwidth (MHz)	Limit Min (MHz)	Limit Max (MHz)	Band Edge Left (MHz)	Band Edge Right (MHz)
2402.000000	0.712872	0.500000	---	2401.762376	2402.475248

(continuation of the "6 dB Bandwidth" table from column 6 ...)

DUT Frequency (MHz)	Max Level (dBm)	Result
2402.000000	6.0	PASS

6dB Bandwidth

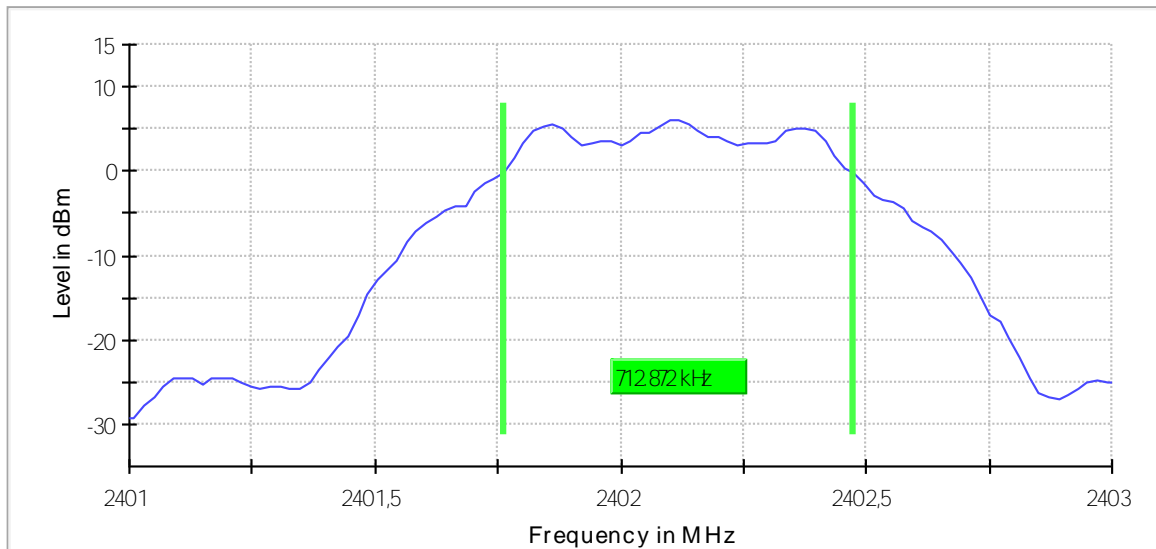

DUT Frequency (MHz)	Bandwidth (MHz)	Limit Min (MHz)	Limit Max (MHz)	Band Edge Left (MHz)	Band Edge Right (MHz)
2402.000000	1.188119	0.500000	---	2401.524752	2402.712871

(continuation of the "6 dB Bandwidth" table from column 6 ...)

DUT Frequency (MHz)	Max Level (dBm)	Result
2402.000000	6.0	PASS

6dB Bandwidth

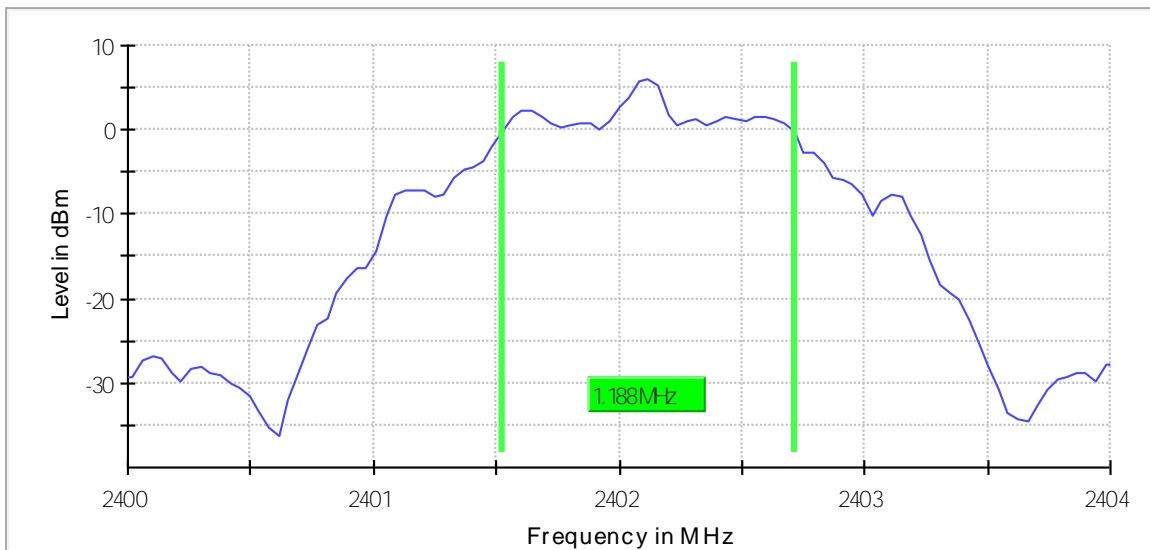



Channel 2440 MHz:

DUT Frequency (MHz)	Bandwidth (MHz)	Limit Min (MHz)	Limit Max (MHz)	Band Edge Left (MHz)	Band Edge Right (MHz)
2440.000000	0.712872	0.500000	---	2439.762376	2440.475248

(continuation of the "6 dB Bandwidth" table from column 6 ...)

DUT Frequency (MHz)	Max Level (dBm)	Result
2440.000000	6.1	PASS

6dB Bandwidth

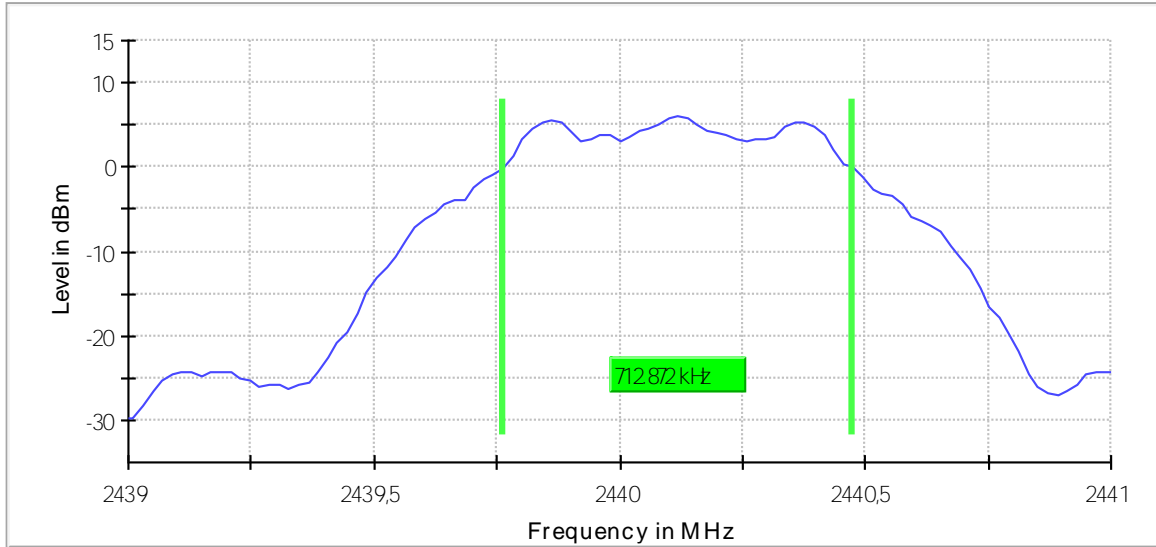

DUT Frequency (MHz)	Bandwidth (MHz)	Limit Min (MHz)	Limit Max (MHz)	Band Edge Left (MHz)	Band Edge Right (MHz)
2440.000000	1.188119	0.500000	---	2439.524752	2440.712871

(continuation of the "6 dB Bandwidth" table from column 6 ...)

DUT Frequency (MHz)	Max Level (dBm)	Result
2440.000000	6.0	PASS

6dB Bandwidth

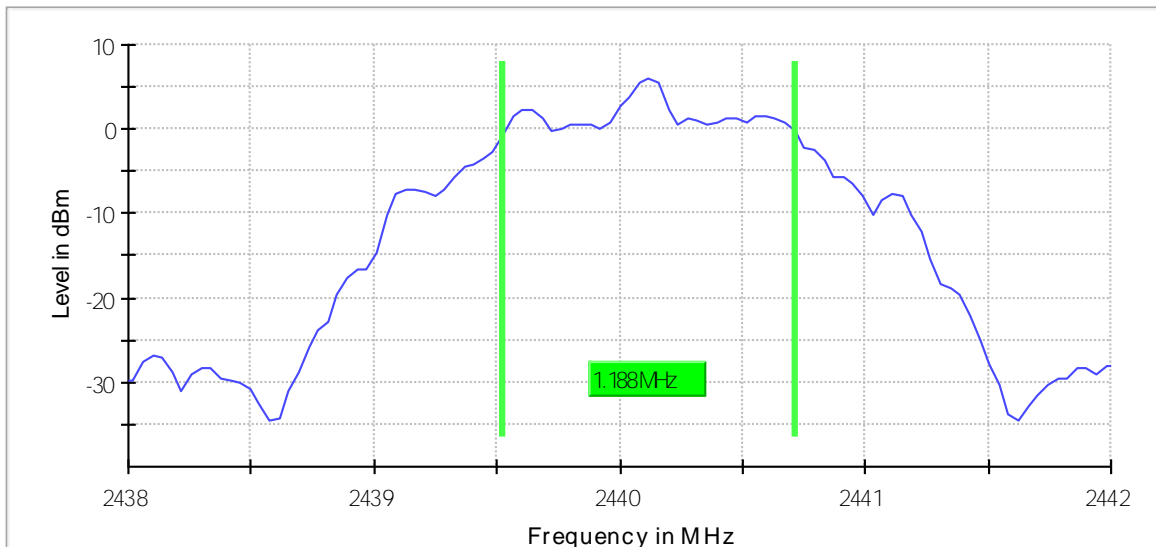

Channel 2480 MHz:

DUT Frequency (MHz)	Bandwidth (MHz)	Limit Min (MHz)	Limit Max (MHz)	Band Edge Left (MHz)	Band Edge Right (MHz)
2480.000000	0.712872	0.500000	---	2479.762376	2480.475248

(continuation of the "6 dB Bandwidth" table from column 6 ...)

DUT Frequency (MHz)	Max Level (dBm)	Result
2480.000000	6.3	PASS

6dB Bandwidth

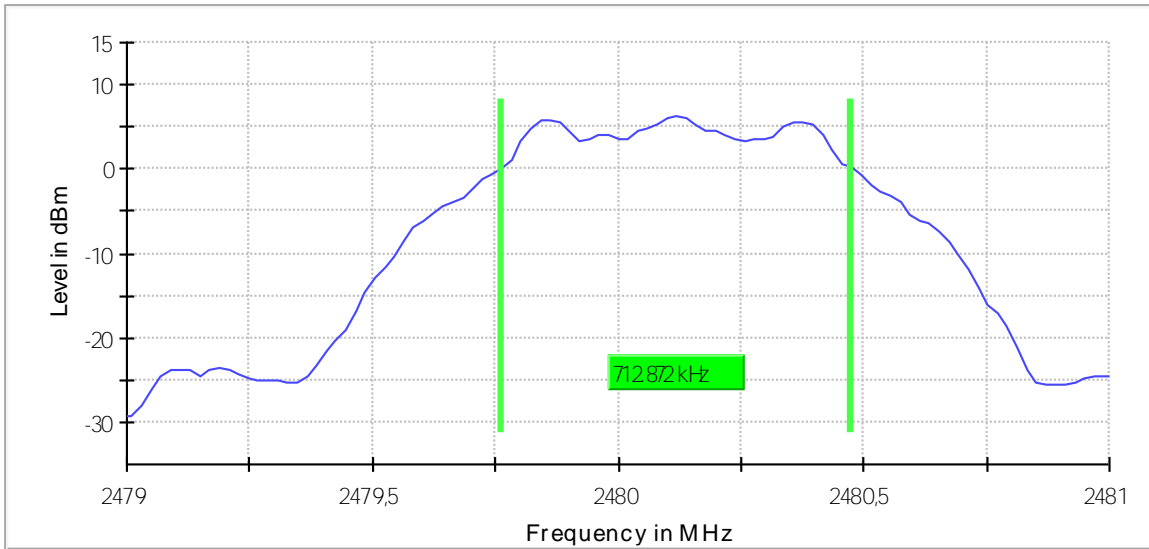

DUT Frequency (MHz)	Bandwidth (MHz)	Limit Min (MHz)	Limit Max (MHz)	Band Edge Left (MHz)	Band Edge Right (MHz)
2480.000000	1.188119	0.500000	---	2479.524752	2480.712871

(continuation of the "6 dB Bandwidth" table from column 6 ...)

DUT Frequency (MHz)	Max Level (dBm)	Result
2480.000000	6.3	PASS

6dB Bandwidth

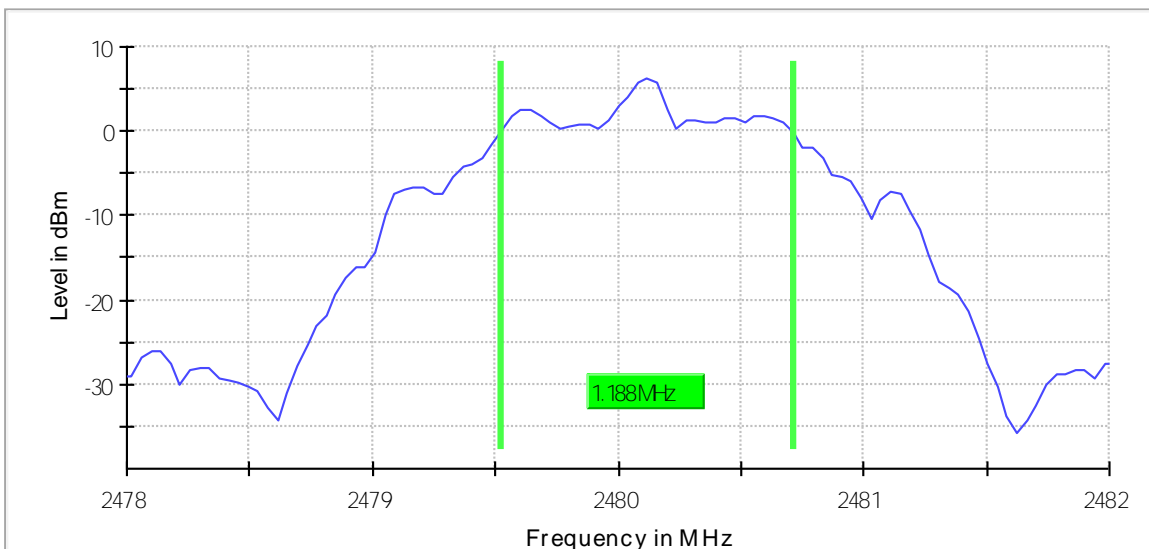



3.6 47 CFR § 15.247 (b) (3) – Maximum peak output power

For systems using digital modulation in the 902-928 MHz, 2400-2483.5 MHz, and 5725-5850 MHz bands: 1 Watt. As an alternative to a peak power measurement, compliance with the one Watt limit can be based on a measurement of the maximum conducted output power. Maximum Conducted Output Power is defined as the total transmit power delivered to all antennas and antenna elements averaged across all symbols in the signaling alphabet when the transmitter is operating at its maximum power control level. Power must be summed across all antennas and antenna elements. The average must not include any time intervals during which the transmitter is off or is transmitting at a reduced power level. If multiple modes of operation are possible (e.g., alternative modulation methods), the *maximum conducted output power* is the highest total transmit power occurring in any mode.

3.6.1 Test procedure

According to ANSI C63.10-2013:

Measurement using an RF average power meter. The procedure for this method is as follows:

- a) Measurements may be performed using a wideband RF power meter with a thermocouple detector or equivalent if all of the following conditions are satisfied:
- 1) The EUT is configured to transmit continuously, or to transmit with a constant duty cycle.
 - 2) At all times when the EUT is transmitting, it shall be transmitting at its maximum power control level.
 - 3) The integration period of the power meter exceeds the repetition period of the transmitted signal by at least a factor of five.
- b) If the transmitter does not transmit continuously, measure the duty cycle D of the transmitter output signal as described in 12.2.
- c) Measure the average power of the transmitter. This measurement is an average over both the ON and OFF periods of the transmitter.
- d) Adjust the measurement in dBm by adding $[10 \log (1 / D)]$, where D is the duty cycle {e.g., $[10 \log (1 / 0.25)]$, if the duty cycle is 25%}.

3.6.2 Test setup

For the test setup refer to chapter 1.4.

3.6.3 Test equipment

For the test setup refer to chapter 1.3.

3.6.4 Test results

47 CFR § 15.247 Requirement

DUT Frequency (MHz)	Conducted output power (dBm)	Limit Max (dBm)	Result
2402.000000	6.9	30.0	PASS
2440.000000	6.9	30.0	PASS
2480.000000	7.2	30.0	PASS

RSS 247 Requirement

DUT Frequency (MHz)	Conducted output power (dBm)	Limit Max (dBm)	Equivalent isotropically radiated power (e.i.r.p)	Limit Max (dBm)	Result
2402.000000	6.9	30.0	6.9	36.2	PASS
2440.000000	6.9	30.0	6.9	36.2	PASS
2480.000000	7.2	30.0	7.2	36.2	PASS

Results for 2 MHz bandwidth are the same as 1 MHz.

3.7 47 CFR § 15.247 (d) –100 kHz Bandwidth of Frequency Band Edge

In any 100 kHz bandwidth outside the frequency band in which the spread spectrum or digitally modulated intentional radiator is operating, the radio frequency power that is produced by the intentional radiator shall be at least 20 dB below that in the 100 kHz bandwidth within the band that contains the highest level of the desired power, based on either an RF conducted or a radiated measurement, provided the transmitter demonstrates compliance with the peak conducted power limits. If the transmitter complies with the conducted power limits based on the use of RMS averaging over a time interval, as permitted under paragraph (b)(3) of this section, the attenuation required under this paragraph shall be 30 dB instead of 20 dB attenuation below the general limits specified in § 15.209(a) is not required. In addition, radiated emissions which fall in the restricted bands, as defined in § 15.205(a), must also comply with the radiated emission limits specified in § 15.209(a) (see § 15.205(c)).

3.7.1 Test procedure

According to ANSI C63.10-2013:

a) Connect the EMI receiver or spectrum analyzer to the EUT using an appropriate RF cable connected to the EUT output. Configure the spectrum analyzer settings as described in step e) (be sure to enter all losses between the unlicensed wireless device output and the spectrum analyzer).

b) Set the EUT to the lowest frequency channel (for the hopping on test, the hopping sequence shall include the lowest frequency channel).

c) Set the EUT to operate at maximum output power and 100% duty cycle, or equivalent “normal mode of operation” as specified in 6.10.3.

d) If using the radiated method, then use the applicable procedure(s) of 6.4, 6.5, 6.6, and orient the EUT and measurement antenna positions to produce the highest emission level.

e) Perform the test as follows:

1) Span: Wide enough to capture the peak level of the emission operating on the channel closest to the band edge, as well as any modulation products that fall outside of the authorized band of operation.

2) Reference level: As required to keep the signal from exceeding the maximum instrument input mixer level for linear operation. In general, the peak of the spectral envelope shall be more than $[10 \log (OBW/RBW)]$ below the reference level. Specific guidance is given in 4.1.5.2.

3) Attenuation: Auto (at least 10 dB preferred).

4) Sweep time: Coupled.

5) Resolution bandwidth: 100 kHz.

6) Video bandwidth: 300 kHz.

7) Detector: Peak.

8) Trace: Max hold.

f) Allow the trace to stabilize. For the test with the hopping function turned ON, this can take several minutes to achieve.

g) Set the marker on the emission at the band edge, or on the highest modulation product outside of the band, if this level is greater than that at the band edge. Enable the marker-delta function, and then use the marker-to-peak function to move the marker to the peak of the in-band emission.

h) Repeat step c) through step e) for every applicable modulation.

i) Set the EUT to the highest frequency channel (for the hopping on test, the hopping sequence shall include the highest frequency channel) and repeat step c) through step d).

j) The band-edge measurement shall be reported by providing plot(s) of the measuring instrument display; the plot axes and the scale units per division shall be clearly labeled. Tabular data may be reported in addition to the plot(s).



3.7.2 Test setup

For the test setup refer to chapter 1.4.

3.7.3 Test equipment

For the test setup refer to chapter 1.3.

3.7.4 Test results – Conducted measurement of band edges

1 MHz bandwidth:

DUT Frequency (MHz)	Result
2402.000000	PASS

Measurements

Frequency (MHz)	Level (dBm)	Margin (dB)	Limit (dBm)	Result
2399.825000	-46.9	24.4	-22.6	PASS
2399.875000	-47.0	24.5	-22.6	PASS
2399.975000	-47.1	24.6	-22.6	PASS
2399.925000	-47.4	24.8	-22.6	PASS
2399.775000	-47.6	25.0	-22.6	PASS
2399.675000	-48.5	25.9	-22.6	PASS
2399.725000	-48.6	26.0	-22.6	PASS
2399.625000	-49.0	26.4	-22.6	PASS
2399.225000	-50.3	27.7	-22.6	PASS
2399.525000	-50.3	27.7	-22.6	PASS
2399.575000	-50.3	27.7	-22.6	PASS
2399.175000	-50.7	28.2	-22.6	PASS
2399.375000	-50.9	28.4	-22.6	PASS
2398.925000	-51.0	28.4	-22.6	PASS
2399.425000	-51.0	28.5	-22.6	PASS

Band Edge

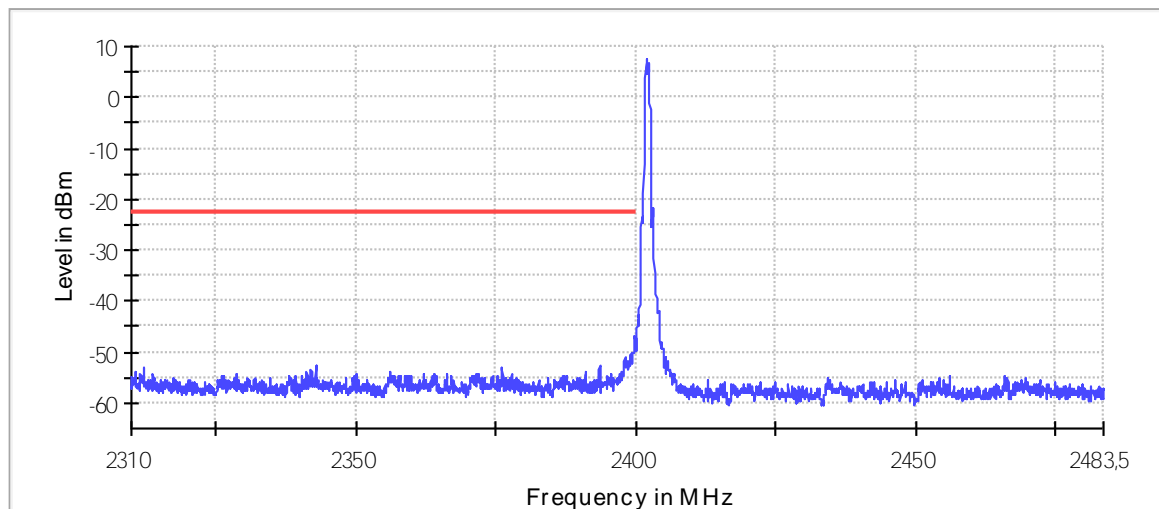

— Limit — SumLevel × Fail

DUT Frequency (MHz)	Result
2480.000000	PASS

Measurements

Frequency (MHz)	Level (dBm)	Margin (dB)	Limit (dBm)	Result
2483.875000	-50.8	28.5	-22.3	PASS
2483.825000	-50.8	28.5	-22.3	PASS
2483.925000	-51.2	28.9	-22.3	PASS
2483.575000	-51.6	29.3	-22.3	PASS
2483.525000	-51.8	29.5	-22.3	PASS
2483.625000	-51.8	29.5	-22.3	PASS
2484.875000	-51.9	29.6	-22.3	PASS
2485.575000	-52.0	29.6	-22.3	PASS
2483.675000	-52.3	30.0	-22.3	PASS
2484.925000	-52.4	30.1	-22.3	PASS
2484.275000	-52.4	30.1	-22.3	PASS
2485.525000	-52.5	30.2	-22.3	PASS
2484.225000	-52.5	30.2	-22.3	PASS
2483.725000	-52.6	30.3	-22.3	PASS
2484.325000	-52.6	30.3	-22.3	PASS

Band Edge

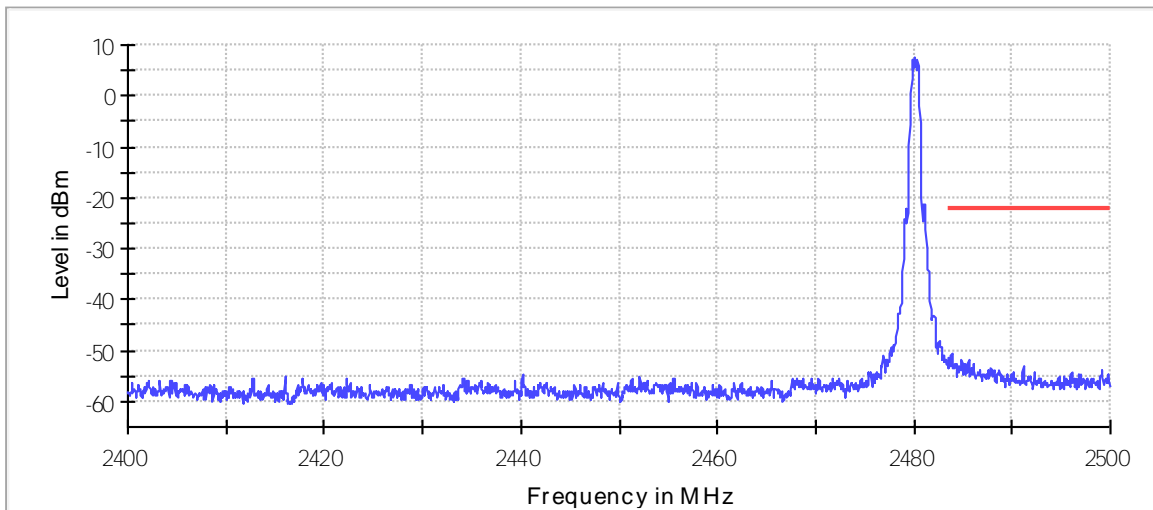

— Limit — Sum Level × Fail



2 MHz bandwidth:

DUT Frequency (MHz)	Result
2402.000000	PASS

Measurements

Frequency (MHz)	Level (dBm)	Margin (dB)	Limit (dBm)	Result
2399.975000	-28.5	5.9	-22.6	PASS
2399.925000	-31.5	8.9	-22.6	PASS
2399.875000	-33.1	10.5	-22.6	PASS
2399.825000	-34.9	12.3	-22.6	PASS
2399.775000	-35.3	12.8	-22.6	PASS
2399.725000	-38.2	15.6	-22.6	PASS
2399.675000	-42.5	19.9	-22.6	PASS
2399.525000	-42.9	20.3	-22.6	PASS
2399.575000	-43.0	20.4	-22.6	PASS
2399.475000	-43.6	21.0	-22.6	PASS
2399.625000	-43.9	21.4	-22.6	PASS
2398.875000	-44.3	21.7	-22.6	PASS
2399.275000	-44.4	21.8	-22.6	PASS
2398.825000	-44.5	21.9	-22.6	PASS
2399.325000	-44.7	22.1	-22.6	PASS

Band Edge

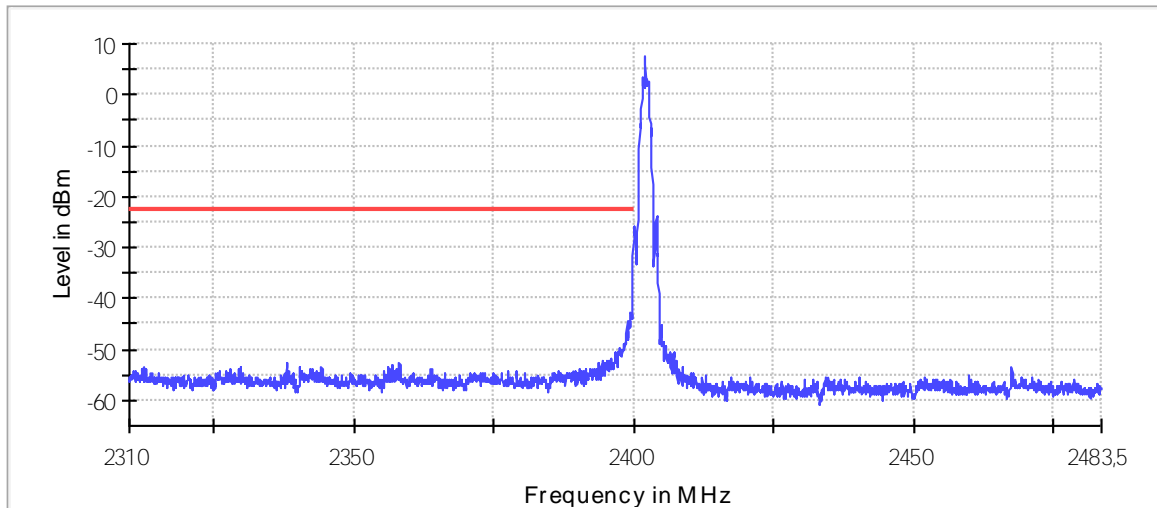

— Limit — SumLevel × Fail

DUT Frequency (MHz)	Result
2480.000000	PASS

Measurements

Frequency (MHz)	Level (dBm)	Margin (dB)	Limit (dBm)	Result
2483.675000	-47.0	24.7	-22.3	PASS
2483.625000	-47.1	24.8	-22.3	PASS
2483.825000	-47.4	25.0	-22.3	PASS
2483.875000	-47.6	25.2	-22.3	PASS
2484.275000	-48.1	25.7	-22.3	PASS
2484.475000	-48.3	26.0	-22.3	PASS
2483.575000	-48.3	26.0	-22.3	PASS
2483.725000	-48.4	26.1	-22.3	PASS
2484.325000	-48.5	26.2	-22.3	PASS
2484.225000	-48.6	26.2	-22.3	PASS
2484.525000	-48.6	26.3	-22.3	PASS
2485.275000	-48.8	26.4	-22.3	PASS
2483.775000	-48.8	26.5	-22.3	PASS
2484.425000	-48.9	26.6	-22.3	PASS
2485.225000	-49.0	26.6	-22.3	PASS

Band Edge

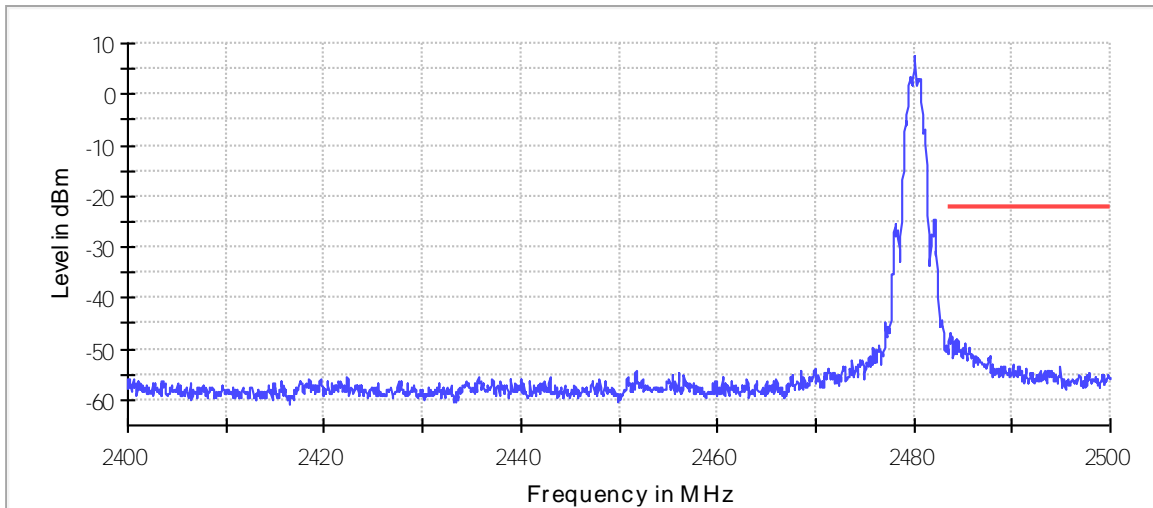

— Limit — Sum Level × Fail



3.7.5 Test results - Radiated measurements of band edges:

DUT Frequency (MHz)	Result
2402.000000	PASS

EUT Information

EUT: Bonnie & Clyde
Operating mode: TX 2402 MHz
Antenna polarization: Vertical

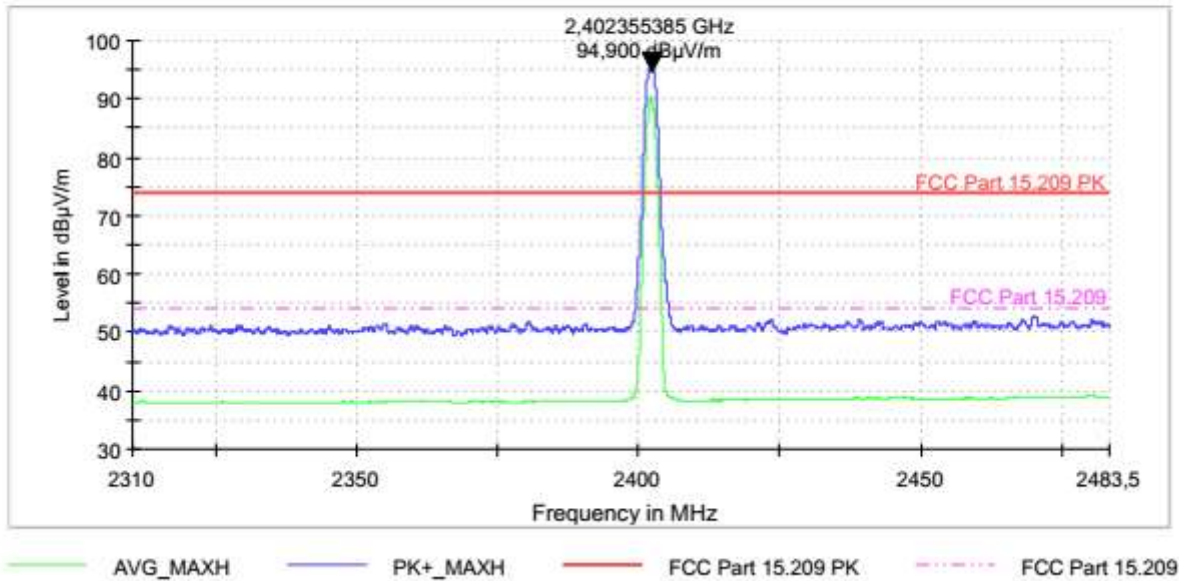

EUT Information

EUT: Bonnie & Clyde
Operating mode: TX 2402 MHz
Antenna polarization: Horizontal

FCC 2,4GHz LOWER BAND EDGE

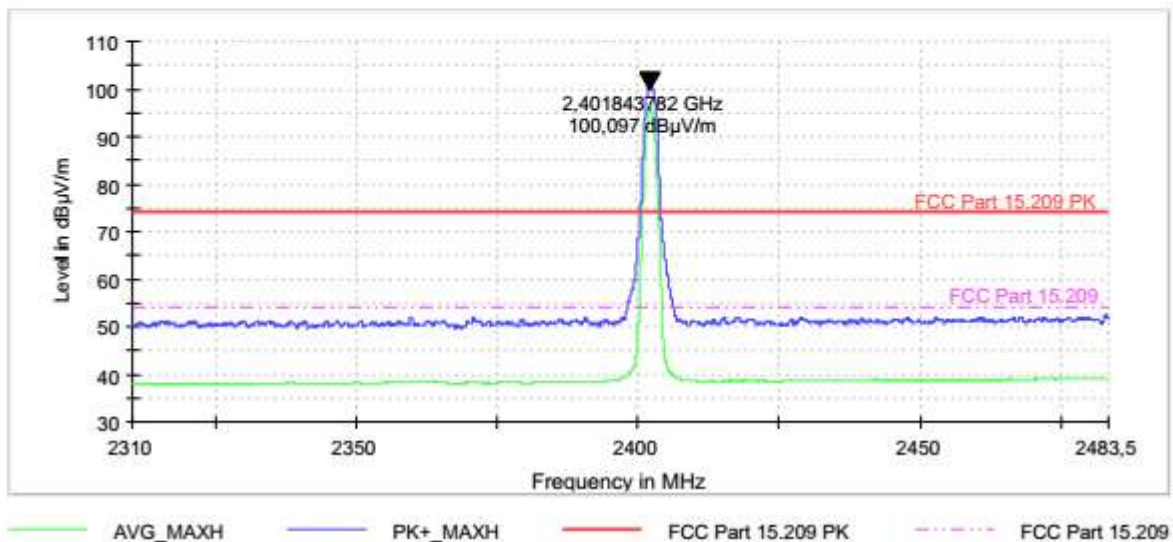

DUT Frequency (MHz)	Result
2480.000000	PASS

EUT Information

EUT
 Operating mode: Bonnie & Clyde
 TX 2480 MHz
 Antenna polarization: Vertical

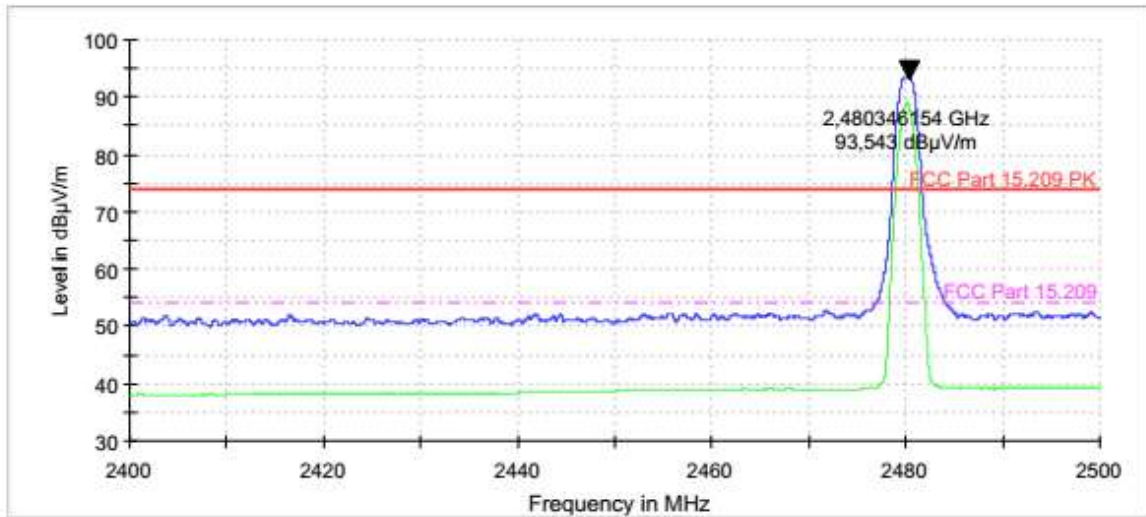

AVG_MAXH PK+_MAXH FCC Part 15.209 PK FCC Part 15.209

EUT Information

EUT
 Operating mode: Bonnie & Clyde
 TX 2480 MHz
 Antenna polarization: Horizontal

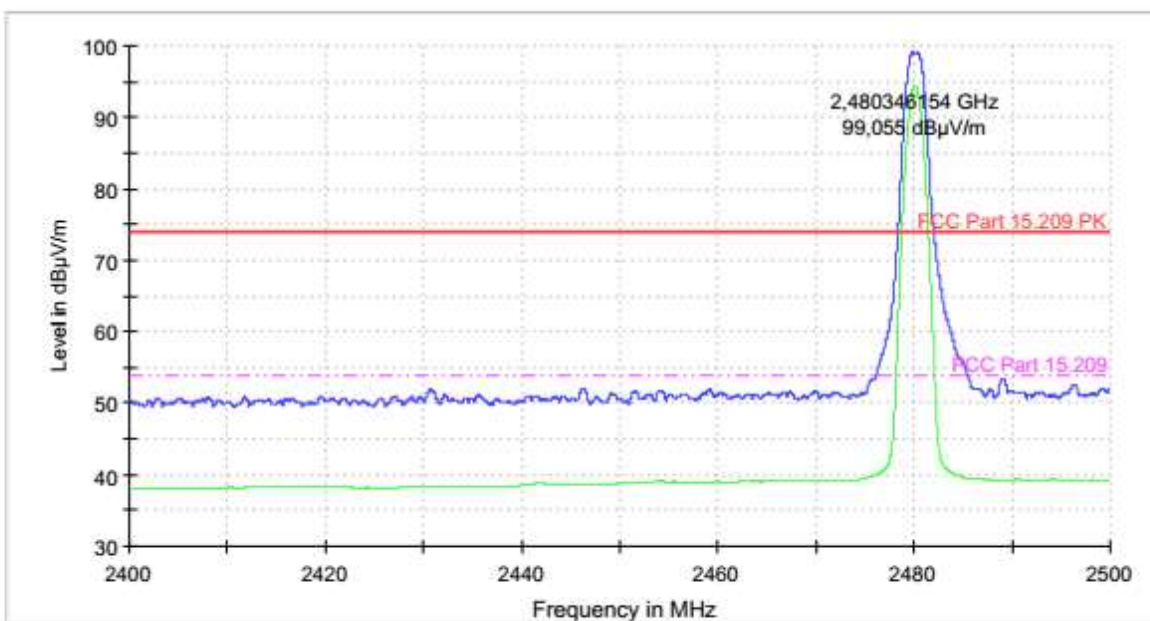



3.8 47 CFR § 15.247 (e) – Power Spectral Density

For digitally modulated systems, the power spectral density conducted from the intentional radiator to the antenna shall not be greater than 8 dBm in any 3 kHz band during any time interval of continuous transmission. This power spectral density shall be determined in accordance with the provisions of paragraph (b) of this section. The same method of determining the conducted output power shall be used to determine the power spectral density.

3.8.1 Test procedure

According ANSI C63.10-2013:

- a) Set analyser center frequency to EUT channel center frequency
- b) Set the RBW between 3 kHz to 100 kHz
- c) Set VBW > 3 x RBW
- d) Set the frequency span to 1.5 times the EUT bandwidth
- e) Use peak detector and max hold function. Trace to fully stabilize 3 times.
- f) If measured value exceeds requirements, then reduce RBW (no less than 3 kHz) and repeat

3.8.2 Test setup

For the test setup refer to chapter 1.4.

3.8.3 Test equipment

For the test setup refer to chapter 1.3.

3.8.4 Test results

1 MHz bandwidth:

DUT Frequency (MHz)	Frequency (MHz)	PSD (dBm)	Limit Max (dBm)	Result
2402.000000	2402.102500	-3.772	8.0	PASS

Peak Power Spectral Density

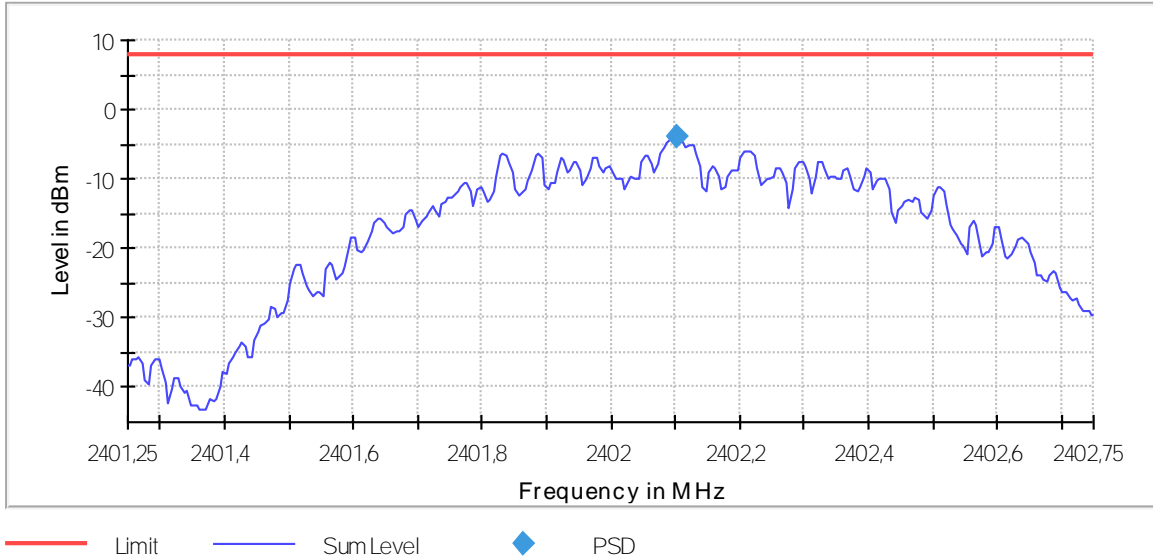

DUT Frequency (MHz)	Frequency (MHz)	PSD (dBm)	Limit Max (dBm)	Result
2440.000000	2440.107500	-3.683	8.0	PASS

Peak Power Spectral Density

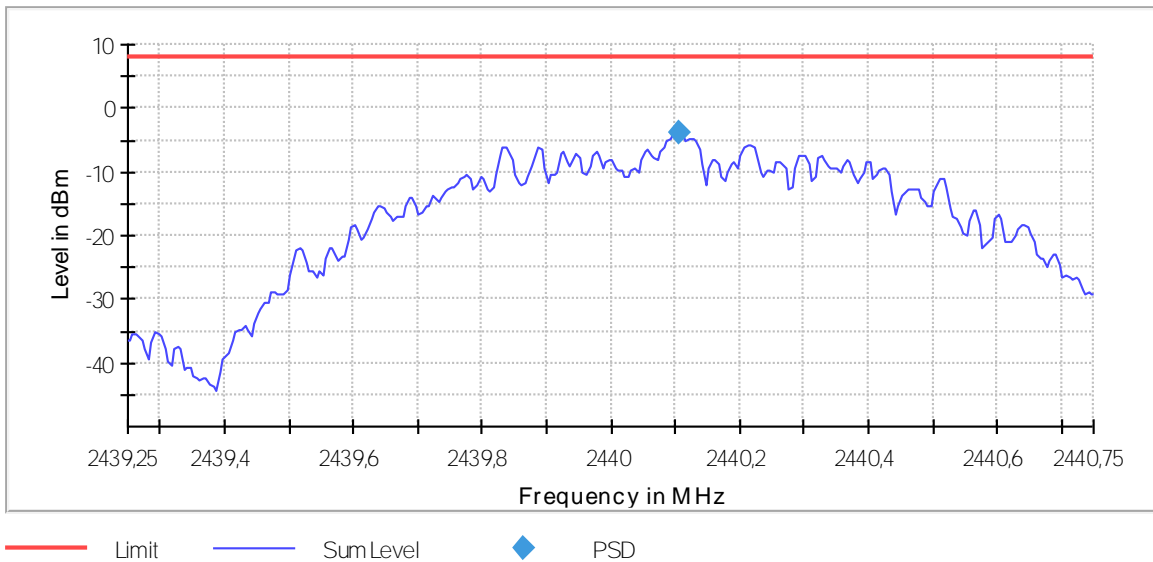



DUT Frequency (MHz)	Frequency (MHz)	PSD (dBm)	Limit Max (dBm)	Result
2480.000000	2480.107500	-3.399	8.0	PASS

Peak Power Spectral Density

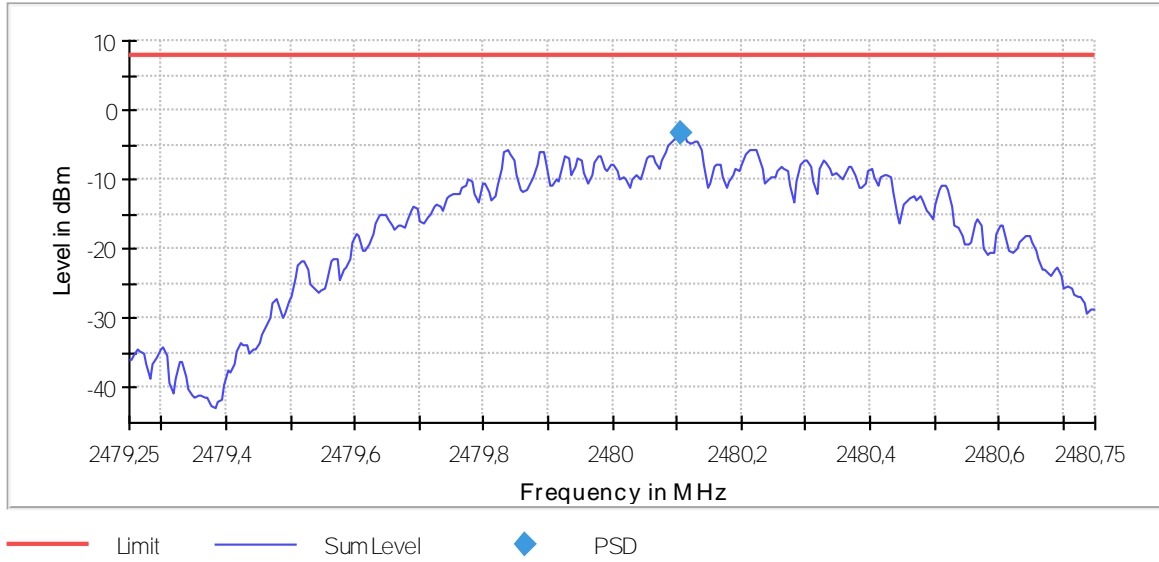

2 MHz bandwidth:

DUT Frequency (MHz)	Frequency (MHz)	PSD (dBm)	Limit Max (dBm)	Result
2402.000000	2402.102500	-3.655	8.0	PASS

Peak Power Spectral Density

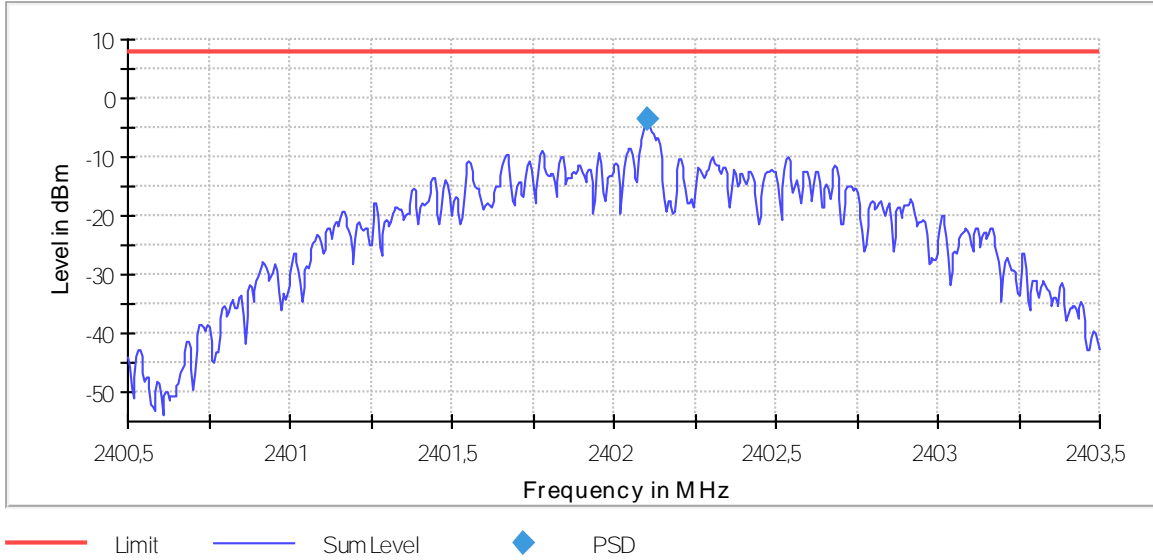

DUT Frequency (MHz)	Frequency (MHz)	PSD (dBm)	Limit Max (dBm)	Result
2440.000000	2440.107500	-3.763	8.0	PASS

Peak Power Spectral Density

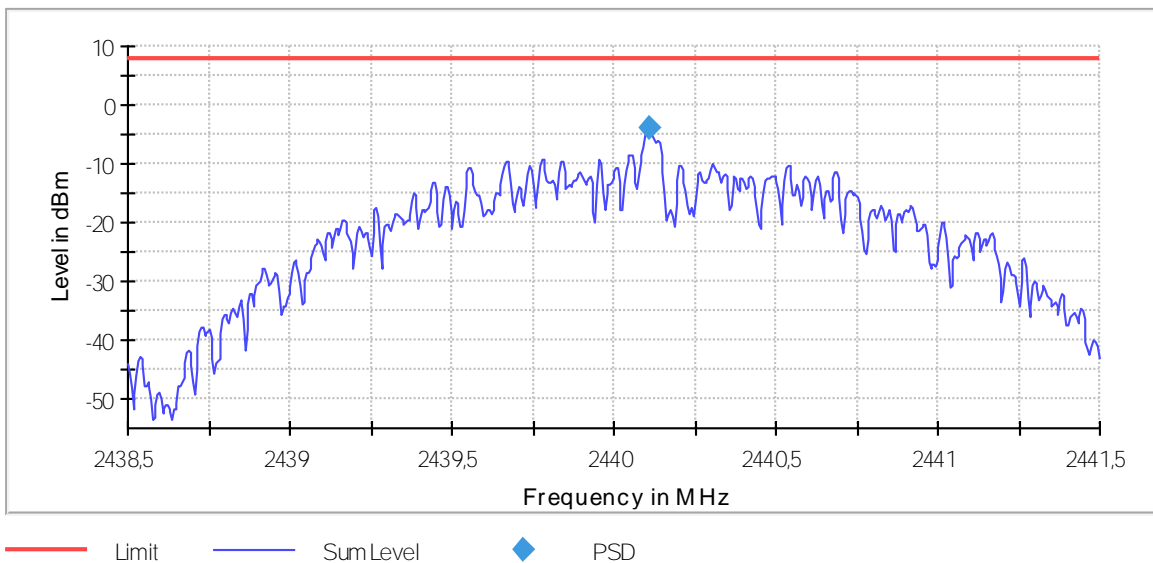



DUT Frequency (MHz)	Frequency (MHz)	PSD (dBm)	Limit Max (dBm)	Result
2480.000000	2480.107500	-3.543	8.0	PASS

Peak Power Spectral Density

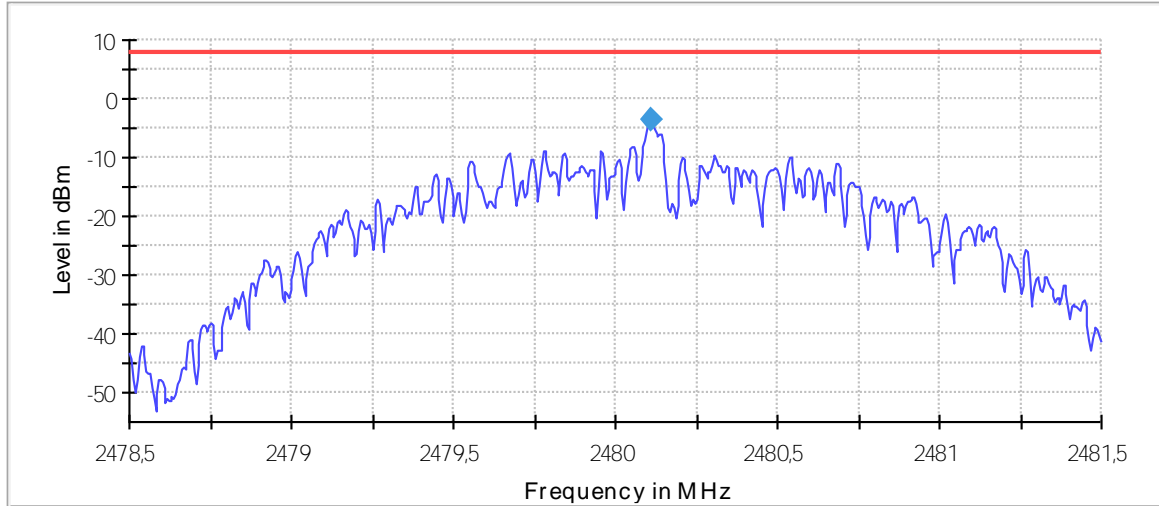

— Limit — SumLevel ◆ PSD

4 Annex I – Additional data

Cross-reference table				
Test	47 CFR requirements	IC requirements	Section within the report	Conclusion
Antenna Requirement	§ 15.203	RSS-Gen Issue 5 §6.8	3.1	PASS
AC Line Conducted Emission	§ 15.207 (a)	RSS-Gen Issue 5 §8.8	3.2	N/A
Spurious emission	§ 15.205, § 15.209, § 15.247 (d)	RSS-Gen Issue 5 §8.9* RSS-Gen Issue 5 §8.10* RSS-247 Issue 2 §5.5*	3.3	PASS
6 dB Emission Bandwidth	§ 15.247 (a) (2)	RSS-247 Issue 2 §5.2(a)	3.4	PASS
Maximum peak output power	§ 15.247 (b) (3)	RSS-247 Issue 2 §5.4(d)	3.5	PASS
100 kHz Bandwidth of Frequency Band Edge	§ 15.247 (d)	RSS-247 Issue 2 §5.5	3.6	PASS
Power Spectral Density	§ 15.247 (e)	RSS-247 Issue 2 §5.2(b)	3.7	PASS
<p>*Note: Radiated measurements performed in laboratory recognized by ISED Canada: – CAB identifier: SI0001 – ISED#: 21434</p>				



4.1 Occupied bandwidth (99% emission bandwidth)

The occupied bandwidth or the “99% emission bandwidth” is defined as the frequency range between two points, one above and the other below the carrier frequency, within which 99% of the total transmitted power of the fundamental transmitted emission is contained.

4.1.1 Test procedure

According to ANSI C63.10-2013:

a) The spectrum analyzer center frequency is set to the nominal EUT channel center frequency. The span range for the EMI receiver or spectrum analyzer shall be between two times and five times the OBW.

b) The nominal IF filter bandwidth (3 dB RBW) shall be in the range of 1% to 5% of the OBW and video bandwidth (VBW) shall be approximately three times RBW, unless otherwise specified by the applicable requirement.

c) Set the reference level of the instrument as required, keeping the signal from exceeding the maximum input mixer level for linear operation. In general, the peak of the spectral envelope shall be more than $[10 \log (OBW/RBW)]$ below the reference level. Specific guidance is given in 4.1.5.2.

d) Steps a) through c) might require iteration to adjust within the specified tolerances.

e) The dynamic range of the instrument at the selected RBW shall be more than 10 dB below the target “-xx dB down” requirement; that is, if the requirement calls for measuring the -20 dB OBW, the instrument noise floor at the selected RBW shall be at least 30 dB below the reference value.

f) Set detection mode to peak and trace mode to max hold.

g) Determine the reference value: Set the EUT to transmit an unmodulated carrier or modulated signal, as applicable. Allow the trace to stabilize. Set the spectrum analyser marker to the highest level of the displayed trace (this is the reference value).

h) Determine the “-xx dB down amplitude” using $[(\text{reference value}) - xx]$. Alternatively, this calculation may be made by using the marker-delta function of the instrument.

i) If the reference value is determined by an unmodulated carrier, then turn the EUT modulation ON, and either clear the existing trace or start a new trace on the spectrum analyser and allow the new trace to stabilize. Otherwise, the trace from step g) shall be used for step j).

j) Place two markers, one at the lowest frequency and the other at the highest frequency of the envelope of the spectral display, such that each marker is at or slightly below the “-xx dB down amplitude” determined in step h). If a marker is below this “-xx dB down amplitude” value, then it shall be as close as possible to this value. The occupied bandwidth is the frequency difference between the two markers. Alternatively, set a marker at the lowest frequency of the envelope of the spectral display, such that the marker is at or slightly below the “-xx dB down amplitude” determined in step h). Reset the marker-delta function and move the marker to the other side of the emission until the delta marker amplitude is at the same level as the reference marker amplitude. The marker-delta frequency reading at this point is the specified emission bandwidth.

k) The occupied bandwidth shall be reported by providing plot(s) of the measuring instrument display; the plot axes and the scale units per division shall be clearly labeled. Tabular data may be reported in addition to the plot(s).

4.1.2 Test setup

For the test setup refer to chapter 1.4.

4.1.3 Test equipment

For the test setup refer to chapter 1.3.

DUT Frequency (MHz)	Bandwidth (MHz)	Limit Min (MHz)	Limit Max (MHz)	Band Edge Left (MHz)	Band Edge Right (MHz)
2402.000000	1.050000	---	---	2401.592500	2402.642500

(continuation of the "99 % Bandwidth" table from column 6 ...)

DUT Frequency (MHz)	Result
2402.000000	PASS

99 % Bandwidth

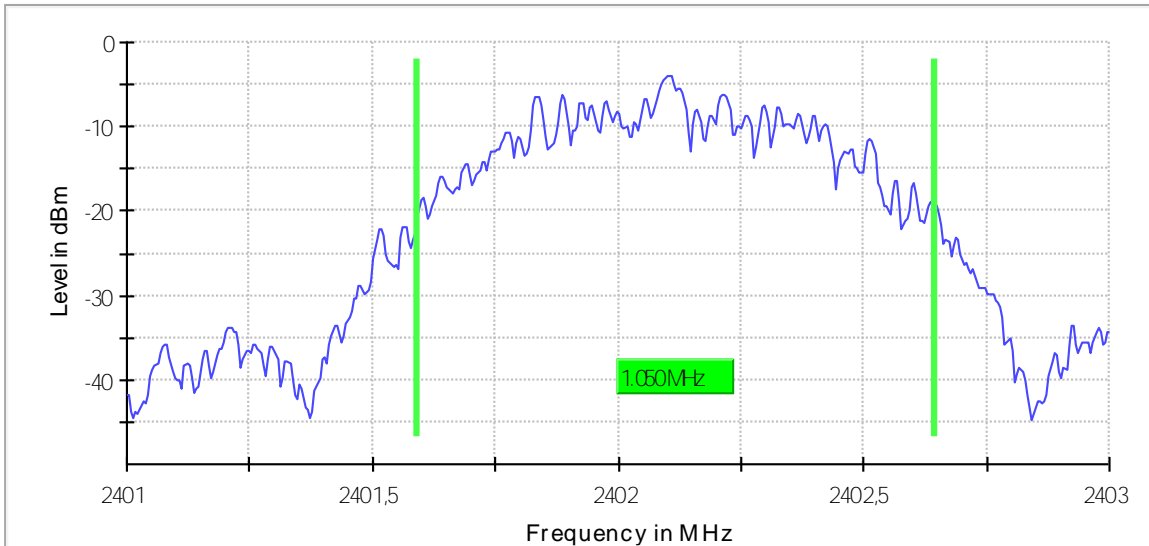

DUT Frequency (MHz)	Bandwidth (MHz)	Limit Min (MHz)	Limit Max (MHz)	Band Edge Left (MHz)	Band Edge Right (MHz)
2402.000000	2.030000	---	---	2401.115000	2403.145000

(continuation of the "99 % Bandwidth" table from column 6 ...)

DUT Frequency (MHz)	Result
2402.000000	PASS

99 % Bandwidth

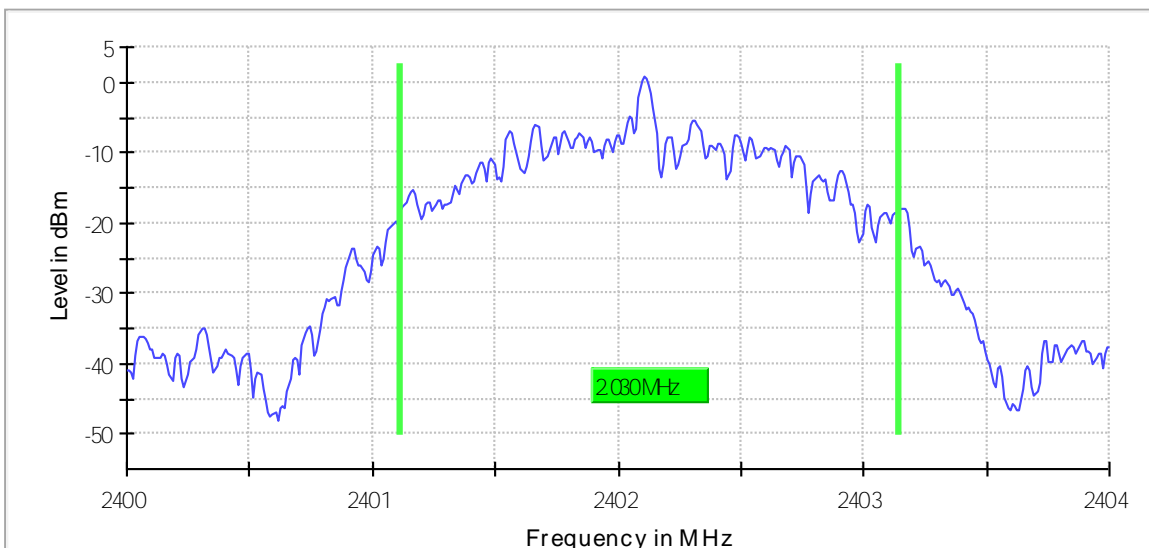



DUT Frequency (MHz)	Bandwidth (MHz)	Limit Min (MHz)	Limit Max (MHz)	Band Edge Left (MHz)	Band Edge Right (MHz)
2440.000000	1.050000	---	---	2439.592500	2440.642500

(continuation of the "99 % Bandwidth" table from column 6 ...)

DUT Frequency (MHz)	Result
2440.000000	PASS

99 % Bandwidth

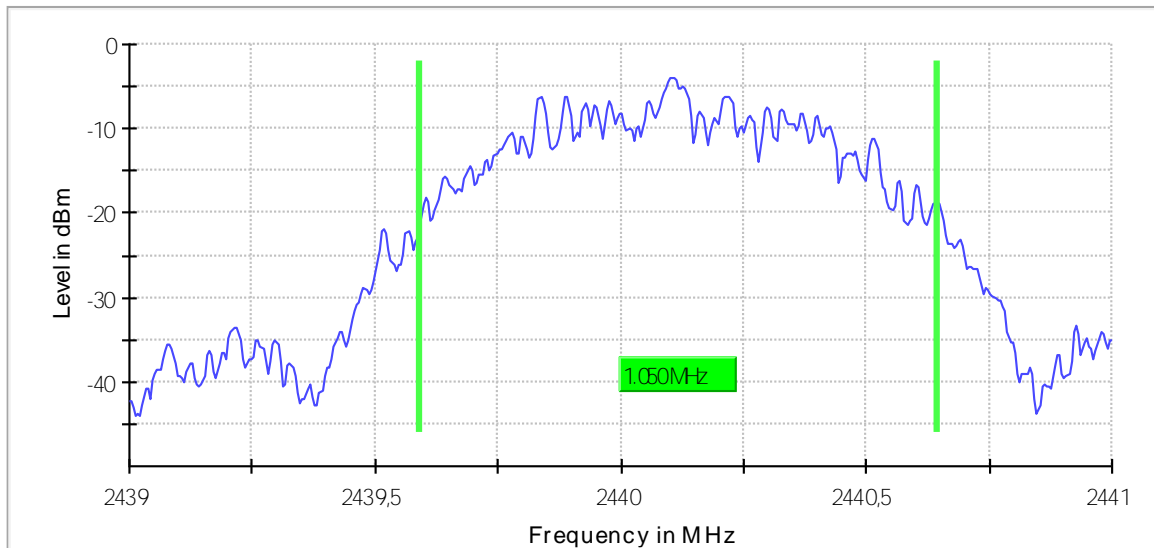

DUT Frequency (MHz)	Bandwidth (MHz)	Limit Min (MHz)	Limit Max (MHz)	Band Edge Left (MHz)	Band Edge Right (MHz)
2440.000000	2.030000	---	---	2439.115000	2441.145000

(continuation of the "99 % Bandwidth" table from column 6 ...)

DUT Frequency (MHz)	Result
2440.000000	PASS

99 % Bandwidth

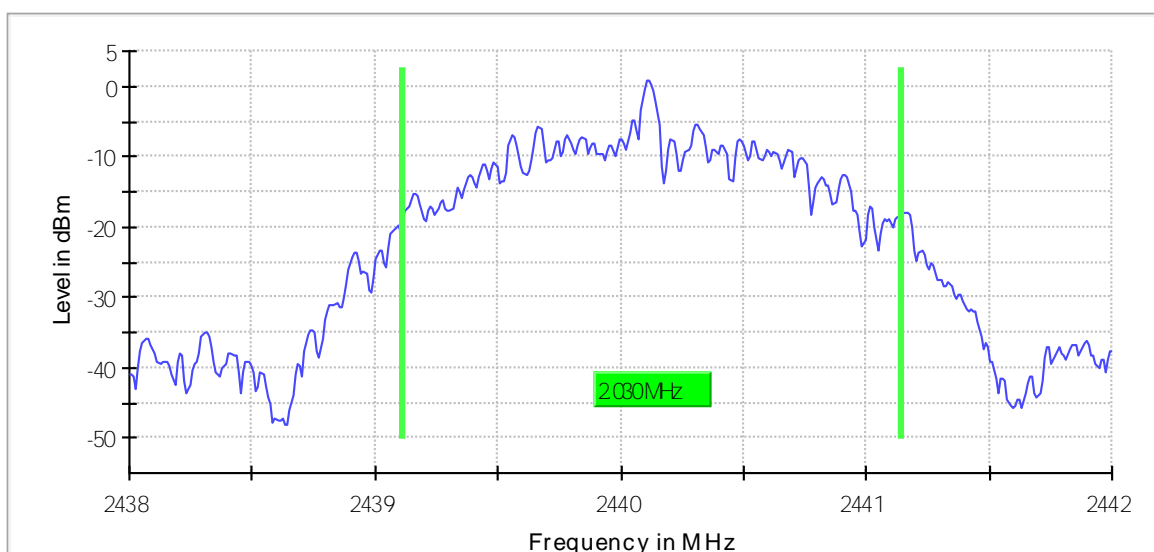

DUT Frequency (MHz)	Bandwidth (MHz)	Limit Min (MHz)	Limit Max (MHz)	Band Edge Left (MHz)	Band Edge Right (MHz)
2480.000000	1.050000	---	---	2479.597500	2480.647500

(continuation of the "99 % Bandwidth" table from column 6 ...)

DUT Frequency (MHz)	Result
2480.000000	PASS

99 % Bandwidth

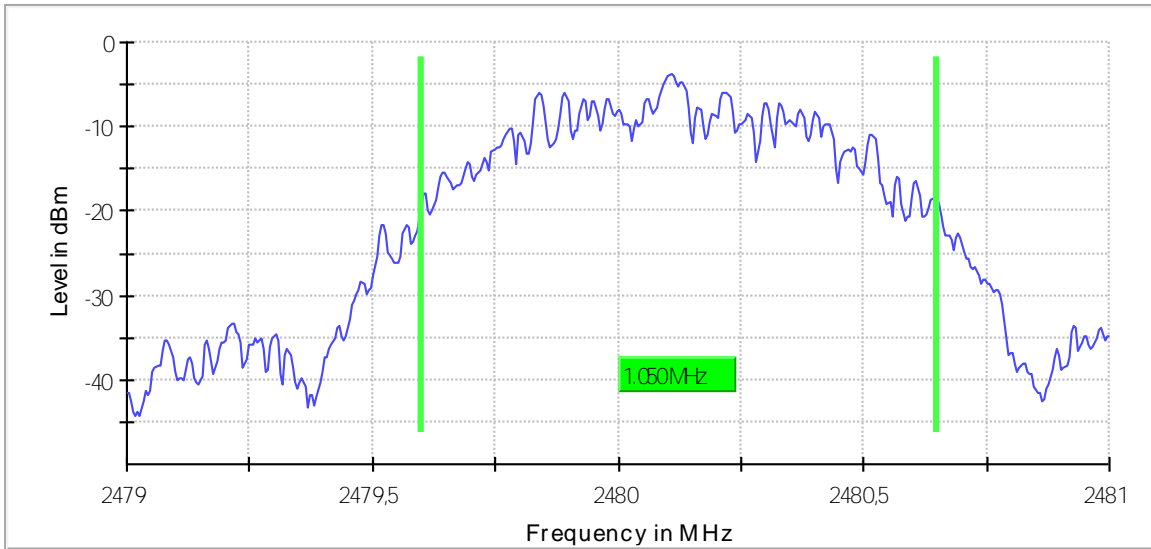

DUT Frequency (MHz)	Bandwidth (MHz)	Limit Min (MHz)	Limit Max (MHz)	Band Edge Left (MHz)	Band Edge Right (MHz)
2480.000000	2.040000	---	---	2479.115000	2481.155000

(continuation of the "99 % Bandwidth" table from column 6 ...)

DUT Frequency (MHz)	Result
2480.000000	PASS

99 % Bandwidth

