

FCC SAR Test Report

Client Name : SHENZHEN JUMPER TECHNOLOGY CO.,LTD
Address : 101,102,201,301 No.13-2 Pingxi South Rd., Pingxi
Community, Pingdi Street, Longgang District,
Shenzhen, Guangdong, China
Product Name : Portable computer
Date : Apr.20, 2020

Shenzhen Anbotek Compliance Laboratory Limited



Contents

- 1. Statement of Compliance 6
- 2. General Information 7
 - 2.1 Client Information 7
 - 2.2 Description of Equipment Under Test (EUT) 7
 - 2.3 Device Category and SAR Limits 9
 - 2.4 Applied Standard 9
 - 2.5 Environment of Test Site 9
 - 2.6 Test Configuration 9
- 3. Specific Absorption Rate (SAR) 10
 - 3.1 Introduction 10
 - 3.2 SAR Definition 10
- 4. SAR Measurement System 11
 - 4.1 E-Field Probe 12
 - 4.2 Data Acquisition Electronics (DAE) 12
 - 4.3 Robot 13
 - 4.4 Measurement Server 14
 - 4.5 Phantom 14
 - 4.6 Device Holder 16
 - 4.7 Data Storage and Evaluation 17
- 5. Test Equipment List 19
- 6. Tissue Simulating Liquids 20
- 7. System Verification Procedures 22
- 8. EUT Testing Position 24
 - 8.1 Body Worn Position 24
- 9. Measurement Procedures 25
 - 9.1 Spatial Peak SAR Evaluation 25
 - 9.2 Power Reference Measurement 26
 - 9.3 Area Scan Procedures 26
 - 9.4 Zoom Scan Procedures 27
 - 9.5 Volume Scan Procedures 28
 - 9.6 Power Drift Monitoring 28
- 10. Conducted Power 29
- 11. Antenna Location 33
- 12. SAR Test Results Summary 34
- 13. SAR Measurement Variability 38
- 14. Simultaneous Transmission Analysis 39
- 15. Measurement Uncertainty 41
- Appendix A. EUT Photos and Test Setup Photos 42
- Appendix B. Plots of SAR System Check 44

Appendix C.	Plots of SAR Test Data.....	47
Appendix D.	DASY System Calibration Certificate.....	51



TEST REPORT

Applicant : SHENZHEN JUMPER TECHNOLOGY CO.,LTD
Manufacturer : SHENZHEN JUMPER TECHNOLOGY CO.,LTD
Product Name : Portable computer
Model No. : EZpad GO
Trade Mark : N/A
Rating(s) : DC 7.6V form battery

Test Standard(s) : IEEE 1528:2013; IEC 62209-2:2010; FCC 47 CFR Part 2 (2.1093:2013);
ANSI/IEEE C95.1:2005;Reference FCC KDBs;

The device described above is tested by Shenzhen Anbotek Compliance Laboratory Limited to determine the maximum emission levels emanating from the device and the severe levels of the device can endure and its performance criterion. The measurement results are contained in this test report and Shenzhen Anbotek Compliance Laboratory Limited is assumed full of responsibility for the accuracy and completeness of these measurements. Also, this report shows that the EUT (Equipment Under Test) is technically compliant with the IEEE 1528:2013, IEC 62209-2:2010, FCC 47 CFR Part 2 (2.1093:2013), ANSI/IEEE C95.1:2005, and Reference FCC KDBs requirements.

This report applies to above tested sample only and shall not be reproduced in part without written approval of Shenzhen Anbotek Compliance Laboratory Limited.

Date of Receipt

Apr.10, 2020

Date of Test

Apr.12, 2020~ Apr.14, 2020

Prepared By



(Engineer / Kingkong Jin)

Reviewer

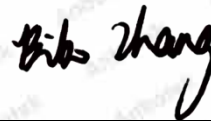

(Supervisor / Bibo Zhang)

Approved & Authorized Signer

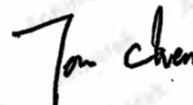

(Manager / Tom Chen)

Version

Version No.	Date	Description
01	Apr.20, 2020	Original

Shenzhen Anbotek Compliance Laboratory Limited

Address: 1/F., Building D, Sogood Science and Technology Park, Sanwei Community, Hangcheng Street, Bao'an District, Shenzhen, Guangdong, China.

Tel:(86) 755-26066440 Fax: (86) 755-26014772 Email: service@anbotek.com



Hotline
400-003-0500
www.anbotek.com

1. Statement of Compliance

The maximum results of Specific Absorption Rate (SAR) found during testing are as follows.

<Highest SAR Summary>

Exposure Configuration	Technology Band	Ant0 Reported 1g-SAR (W/kg)	Ant1 Reported 1g-SAR (W/kg)	SAR Test Limit (W/Kg)
Body (Gap 0mm)	WIFI 2.4G	0.497	0.466	1.6
	WIFI 5G	0.261	0.328	
Test Result		PASS		

<Max Simultaneous Transmission SAR>

Exposure Position	Max SAR (W/kg)		Sum (W/kg)	SAR Test Limit (W/Kg)
	Wifi 2.4G Ant 0	Wifi 5G Ant 1		
Front	0.337	0.223	0.560	1.6
Back	0.497	0.328	0.825	
Top Side	0.405	0.266	0.671	

This device is in compliance with Specific Absorption Rate (SAR) for general population/uncontrolled exposure limits (1.6 W/kg) specified in KDB 447498 D01 v06, 2015 and ANSI/IEEE C95.1-2005, and had been tested in accordance with the measurement methods and procedures specified in IEEE 1528-2013

2. General Information

2.1 Client Information

Applicant	:	SHENZHEN JUMPER TECHNOLOGY CO.,LTD
Address	:	101,102,201,301 No.13-2 Pingxi South Rd., Pingxi Community, Pingdi Street, Longgang District, Shenzhen, GuangDong, China
Manufacturer	:	SHENZHEN JUMPER TECHNOLOGY CO.,LTD
Address	:	101,102,201,301 No.13-2 Pingxi South Rd., Pingxi Community, Pingdi Street, Longgang District, Shenzhen, GuangDong, China

2.2 Description of Equipment Under Test (EUT)

Product Name:	Portable computer
Trade Mark:	N/A
Model/Type reference:	EZpad GO
List Model:	N/A
Power supply:	DC 7.6V form battery
WIFI	
WLAN	Supported 802.11 a/b/g/n/ac
Modulation Type	IEEE 802.11a: OFDM(64QAM, 16QAM, QPSK, BPSK) IEEE 802.11b: DSSS(CCK,DQPSK,DBPSK) IEEE 802.11g: OFDM(64QAM, 16QAM, QPSK, BPSK) IEEE 802.11n HT20: OFDM (64QAM, 16QAM, QPSK,BPSK) IEEE 802.11n HT40: OFDM (64QAM, 16QAM, QPSK,BPSK) IEEE 802.11ac20/40/80: OFDM(256QAM,64QAM, 16QAM, QPSK, BPSK)
Operation frequency	IEEE 802.11a:5180-5240MHz 5745-5825MHz IEEE 802.11b:2412-2462MHz IEEE 802.11g:2412-2462MHz IEEE 802.11n HT20:2412-2462MHz, 5180-5240MHz 5745-5825MHz IEEE 802.11n HT40:2422-2452MHz, 5190-5230MHz 5755-5795MHz IEEE 802.11ac20:5180-5240MHz 5745-5825MHz IEEE 802.11ac40:5190-5230MHz 5755-5795MHz IEEE 802.11ac80:5210MHz 5775MHz

Channel number	11 Channels for WIFI 20MHz Bandwidth(802.11b/g/n-HT20) 7 Channels for WIFI 40MHz Bandwidth(802.11n-HT40) 4 channels for 20MHz bandwidth(5180-5240MHz) 2 channels for 40MHz bandwidth(5190~5230MHz) 1 channels for 80MHz bandwidth(5210MHz) 5 channels for 20MHz bandwidth(5745-5825MHz) 2 channels for 40MHz bandwidth(5755~5795MHz) 1 channels for 80MHz bandwidth(5775MHz)
BT	
Operation frequency	2402-2480MHz
Channel Number	79 channels for Bluetooth (DSS) 40 channels for Bluetooth (DTS)
Channel Spacing	1MHz for Bluetooth (DSS) 2MHz for Bluetooth (DTS)
Modulation Type	GFSK, $\pi/4$ DQPSK, 8DPSK for Bluetooth (DSS) GFSK for Bluetooth (DTS)
Antenna Description	Two same FPC Antenna, but not support MIMO technology ANT0 used for BT / WIFI TX/RX, 2.34dBi(Max.) for 2.4G Band and 2.46dBi (Max.) for 5G Band ANT1 used for WIFI TX/RX, 2.34dBi(Max.) for 2.4G Band and 2.46dBi(Max.) for 5G Band

2.3 Device Category and SAR Limits

This device belongs to portable device category because its radiating structure is allowed to be used within 20 centimeters of the body of the user. Limit for General Population/Uncontrolled exposure should be applied for this device, it is 1.6 W/kg as averaged over any 1 gram of tissue.

2.4 Applied Standard

The Specific Absorption Rate (SAR) testing specification, method, and procedure for this device is in accordance with the following standards:

- FCC 47 CFR Part 2 (2.1093:2013)
- ANSI/IEEE C95.1:2005
- IEEE Std 1528:2013
- KDB 865664 D01 SAR Measurement 100 MHz to 6 GHz v01r04
- KDB 865664 D02 RF Exposure Reporting v01r02
- KDB 447498 D01 General RF Exposure Guidance v06
- KDB248227 D01 802.11 Wi-Fi SAR v02r02
- KDB 616217 D04 SAR for laptop and tablets

2.5 Environment of Test Site

Items	Required	Actual
Temperature (°C)	18-25	22~23
Humidity (%RH)	30-70	55~65

2.6 Test Configuration

For WIFI SAR testing, engineering testing software installed on the EUT can provide continuous transmitting RF signal.

3. Specific Absorption Rate (SAR)

3.1 Introduction

SAR is related to the rate at which energy is absorbed per unit mass in an object exposed to a radio field. The SAR distribution in a biological body is complicated and is usually carried out by experimental techniques or numerical modeling. The standard recommends limits for two tiers of groups, occupational/controlled and general population/uncontrolled, based on a person's awareness and ability to exercise control over his or her exposure. In general, occupational/controlled exposure limits are higher than the limits for general population/uncontrolled.

3.2 SAR Definition

The SAR definition is the time derivative (rate) of the incremental energy (dW) absorbed by (dissipated in) an incremental mass (dm) contained in a volume element (dv) of a given density (ρ). The equation description is as below:

$$SAR = \frac{d}{dt} \left(\frac{dW}{dm} \right) = \frac{d}{dt} \left(\frac{dW}{\rho dv} \right)$$

SAR is expressed in units of Watts per kilogram (W/kg)

SAR measurement can be either related to the temperature elevation in tissue by

$$SAR = c \left(\frac{\delta T}{\delta t} \right)$$

Where: C is the specific heat capacity, δT is the temperature rise and δt is the exposure duration, or related to the electrical field in the tissue by

$$SAR = \frac{\sigma |E|^2}{\rho}$$

Where: σ is the conductivity of the tissue, ρ is the mass density of the tissue and E is the RMS electrical field strength.

However for evaluating SAR of low power transmitter, electrical field measurement is typically applied.

4. SAR Measurement System

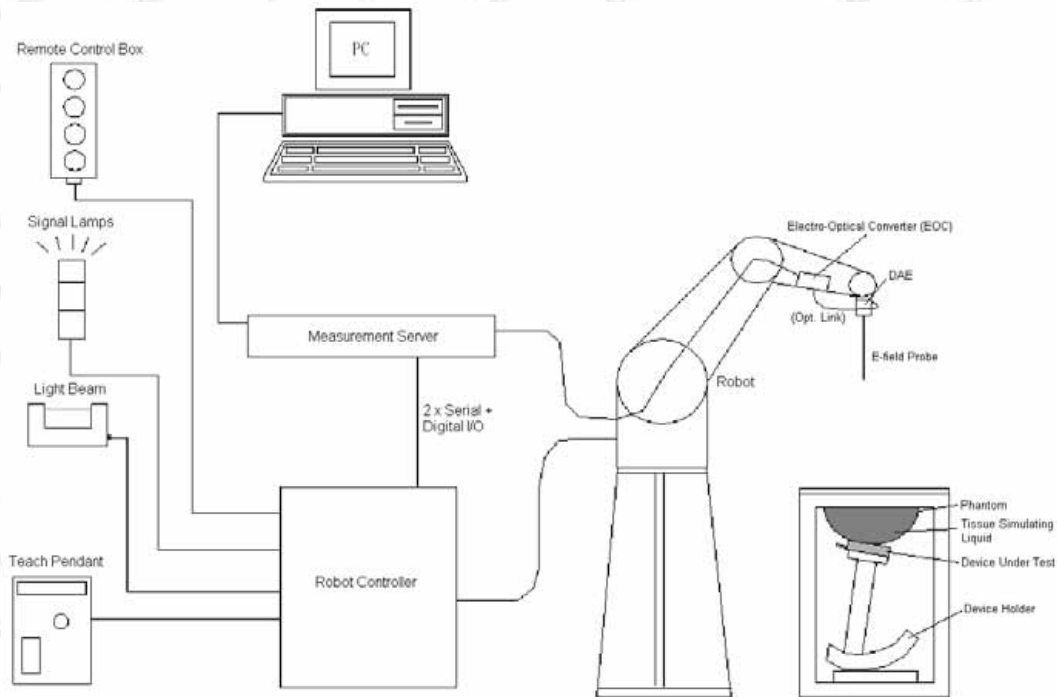

DASY System Configurations

The DASYS system for performance compliance tests is illustrated above graphically. This system consists of the following items:

- A standard high precision 6-axis robot with controller, a teach pendant and software
- A data acquisition electronic (DAE) attached to the robot arm extension
- A dosimetric probe equipped with an optical surface detector system
- The electro-optical converter (EOC) performs the conversion between optical and electrical signals
- A measurement server performs the time critical tasks such as signal filtering, control of the robot operation and fast movement interrupts.
- A probe alignment unit which improves the accuracy of the probe positioning
- A computer operating Windows XP
- DASYS software
- Remote control with teach pendant and additional circuitry for robot safety such as warning lamps, etc.
- The SAM twin phantom
- A device holder
- Tissue simulating liquid

- Dipole for evaluating the proper functioning of the system

components are described in details in the following sub-sections.

4.1 E-Field Probe

The SAR measurement is conducted with the dosimetric probe (manufactured by SPEAG). The probe is specially designed and calibrated for use in liquid with high permittivity. The dosimetric probe has special calibration in liquid at different frequency. This probe has a built in optical surface detection system to prevent from collision with phantom.

- **E-Field Probe Specification**
<EX3DV4 Probe>

Construction	Symmetrical design with triangular core Built-in shielding against static charges PEEK enclosure material (resistant to organic solvents, e.g., DGBE)	 <p>Photo of EX3DV4</p>
Frequency	10 MHz to 6 GHz; Linearity: ± 0.2 dB	
Directivity	± 0.3 dB in HSL (rotation around probe axis) ± 0.5 dB in tissue material (rotation normal to probe axis)	
Dynamic Range	10 μ W/g to 100 mW/g; Linearity: ± 0.2 dB (noise: typically < 1 μ W/g)	
Dimensions	Overall length: 330 mm (Tip: 20 mm) Tip diameter: 2.5 mm (Body: 12 mm) Typical distance from probe tip to dipole centers: 1 mm	

- **E-Field Probe Calibration**

Each probe needs to be calibrated according to a dosimetric assessment procedure with accuracy better than $\pm 10\%$. The spherical isotropy shall be evaluated and within ± 0.25 dB. The sensitivity parameters (NormX, NormY, and NormZ), the diode compression parameter (DCP) and the conversion factor (ConvF) of the probe are tested. The calibration data can be referred to appendix C of this report.

4.2 Data Acquisition Electronics (DAE)

The data acquisition electronics (DAE) consists of a highly sensitive electrometer-grade preamplifier with auto-zeroing, a channel and gain-switching multiplexer, a fast 16 bit AD-converter and a command decoder and control logic unit. Transmission to the measurement server is

accomplished through an optical downlink for data and status information as well as an optical uplink for commands and the clock.

The input impedance of the DAE is 200M Ω ; the inputs are symmetrical and floating. Common mode rejection is above 80dB.



Photo of DAE

4. 3 Robot

The SPEAG DASY system uses the high precision robots (DASY5: TX60XL) type from Stäubli SA (France). For the 6-axis controllersystem, the robot controller version (DASY5: CS8c) from Stäubli is used. The Stäubli robot series have many features that are important for our application:

- High precision (repeatability ± 0.035 mm)
- High reliability (industrial design)
- Jerk-free straight movements
- Low ELF interference (the closed metallic construction shields against motor control fields)



Photo of DASY5

4. 4 Measurement Server

The measurement server is based on a PC/104 CPU board with CPU (DASY5: 400 MHz, Intel Celeron), chipdisk (DASY5: 128 MB), RAM (DASY5: 128 MB). The necessary circuits for communication with the DAE electronic box, as well as the 16 bit AD converter system for optical detection and digital I/O interface are contained on the DASY I/O board, which is directly connected to the PC/104 bus of the CPU board.

The measurement server performs all the real-time data evaluation for field measurements and surface detection, controls robot movements and handles safety operations.



Photo of Server for DASY5

4. 5 Phantom

<SAM Twin Phantom>

Shell Thickness	2 ± 0.2 mm; Center ear point: 6 ± 0.2 mm	
Filling Volume	Approx. 25 liters	
Dimensions	Length: 1000 mm; Width: 500 mm; Height: adjustable feet	
Measurement Areas	Left Hand, Right Hand, Flat Phantom	

The bottom plate contains three pair of bolts for locking the device holder. The device holder positions are adjusted to the standard measurement positions in the three sections. A white cover is provided to tap the phantom during off-periods to prevent water evaporation and changes in the liquid parameters. On the phantom top, three reference markers are provided to identify the phantom position with respect to the robot.

<ELI4 Phantom>

Shell Thickness	2 ± 0.2 mm (sagging: <1%)	
Filling Volume	Approx. 30 liters	
Dimensions	Major ellipse axis: 600 mm Minor axis: 400 mm	

Photo of ELI4 Phantom

The ELI4 phantom is intended for compliance testing of handheld and body-mounted wireless devices in the frequency range of 30 MHz to 6 GHz. ELI4 is fully compatible with standard and all known tissue simulating liquids.

4. 6 Device Holder

The SAR in the phantom is approximately inversely proportional to the square of the distance between the source and the liquid surface. For a source at 5 mm distance, a positioning uncertainty of $\pm 0.5\text{mm}$ would produce a SAR uncertainty of $\pm 20\%$. Accurate device positioning is therefore crucial for accurate and repeatable measurements. The positions in which the devices must be measured are defined by the standards.

The DASY device holder is designed to cope with different positions given in the standard. It has two scales for the device rotation (with respect to the body axis) and the device inclination (with respect to the line between the ear reference points). The rotation center for both scales is the ear reference point (ERP). Thus the device needs no repositioning when changing the angles.

The DASY device holder is constructed of low-loss POM material having the following dielectric parameters: relative permittivity $\epsilon = 3$ and loss tangent $\delta = 0.02$. The amount of dielectric material has been reduced in the closest vicinity of the device, since measurements have suggested that the influence of the clamp on the test results could thus be lowered.



Device Holder

4.7 Data Storage and Evaluation

➤ Data Storage

The DASY software stores the assessed data from the data acquisition electronics as raw data (in microvolt readings from the probe sensors), together with all the necessary software parameters for the data evaluation (probe calibration data, liquid parameters and device frequency and modulation data) in measurement files. The post-processing software evaluates the desired unit and format for output each time the data is visualized or exported. This allows verification of the complete software setup even after the measurement and allows correction of erroneous parameter settings. For example, if a measurement has been performed with an incorrect crest factor parameter in the device setup, the parameter can be corrected afterwards and the data can be reevaluated.

The measured data can be visualized or exported in different units or formats, depending on the selected probe type (e.g., [V/m], [A/m], [mW/g]). Some of these units are not available in certain situations or give meaningless results, e.g., a SAR-output in a non-lose media, will always be zero. Raw data can also be exported to perform the evaluation with other software packages.

➤ Data Evaluation

The DASY post-processing software (SEMCAD) automatically executes the following procedures to calculate the field units from the microvolt readings at the probe connector. The parameters used in the evaluation are stored in the configuration modules of the software:

Probe parameters:	- Sensitivity	Norm _i , a _{i0} , a _{i1} , a _{i2}
	- Conversion factor	ConvF _i
	- Diode compression point	dcp _i
Device parameters:	- Frequency	f
	- Crest factor	cf
Media parameters:	- Conductivity	σ
	- Density	ρ

These parameters must be set correctly in the software. They can be found in the component documents or they can be imported into the software from the configuration files issued for the DASY components. In the direct measuring mode of the multi-meter option, the parameters of the actual system setup are used. In the scan visualization and export modes, the parameters stored in the corresponding document files are used.

The first step of the evaluation is a linearization of the filtered input signal to account for the compression characteristics of the detector diode. The compensation depends on the input signal, the diode type and the DC-transmission factor from the diode to the evaluation electronics. If the exciting field is pulsed, the crest factor of the signal must be known to correctly compensate for peak power.

The formula for each channel can be given as:

$$V_i = U_i + U_i^2 \cdot \frac{cf}{dcp_i}$$

with V_i = compensated signal of channel i, (i = x, y, z)

U_i = input signal of channel i, (i = x, y, z)

cf = crest factor of exciting field (DASY parameter)

dcp_i = diode compression point (DASY parameter)

From the compensated input signals, the primary field data for each channel can be evaluated:

$$\text{E-field Probes: } E_i = \sqrt{\frac{V_i}{\text{Norm}_i \cdot \text{ConvF}}}$$

$$\text{H-field Probes: } H_i = \sqrt{V_i} \cdot \frac{a_{i0} + a_{i1}f + a_{i2}f^2}{f}$$

with V_i = compensated signal of channel i, (i = x, y, z)

Norm_i= sensor sensitivity of channel i, (i = x, y, z), $\mu\text{V}/(\text{V/m})^2$ for E-field Probes

ConvF= sensitivity enhancement in solution

a_{ij} = sensor sensitivity factors for H-field probes

f = carrier frequency [GHz]

E_i = electric field strength of channel i in V/m

H_i = magnetic field strength of channel i in A/m

The RSS value of the field components gives the total field strength (Hermitian magnitude):

$$E_{\text{tot}} = \sqrt{E_x^2 + E_y^2 + E_z^2}$$

The primary field data are used to calculate the derived field units.

$$\text{SAR} = E_{\text{tot}}^2 \cdot \frac{\sigma}{\rho \cdot 1000}$$

with SAR = local specific absorption rate in mW/g

E_{tot} = total field strength in V/m

σ = conductivity in [mho/m] or [Siemens/m]

ρ = equivalent tissue density in g/cm³

Note that the density is set to 1, to account for actual head tissue density rather than the density of the tissue simulating liquid.

5. Test Equipment List

Manufacturer	Name of Equipment	Type/Model	Serial Number	Calibration	
				Last Cal.	Due Date
SPEAG	2450MHz System Validation Kit	D2450V2	910	Jun 15,2018	Jun 14,2021
SPEAG	5GHz System Validation Kit	D5GHzV2	1160	Oct 02,2018	Oct 01,2021
SPEAG	Data Acquisition Electronics	DAE4	387	Sept.03,2019	Sept.02,2020
SPEAG	Dosimetric E-Field Probe	EX3DV4	7396	May 06,2019	May 06,2020
Agilent	ENA Series Network Analyzer	E5071C	MY46317418	May. 22, 2019	May. 21, 2020
SPEAG	DAK	DAK-3.5	1226	NCR	NCR
SPEAG	ELI Phantom	QDOVA004AA	2058	NCR	NCR
AR	Amplifier	ZHL-42W	QA1118004	NCR	NCR
Agilent	Power Meter	N1914A	MY50001102	Nov. 06, 2019	Nov. 05, 2020
Agilent	Power Sensor	N8481H	MY51240001	Nov. 06, 2019	Nov. 05, 2020
R&S	Spectrum Analyzer	N9020A	MY51170037	May. 22, 2019	May. 21, 2020
Agilent	Signal Generation	N5182A	MY48180656	May. 22, 2019	May. 21, 2020
Worken	Directional Coupler	0110A056010-10	COM5BNW1A2	May. 22, 2019	May. 21, 2020

Note:

1. The calibration certificate of DASY can be referred to appendix C of this report.
2. The dipole calibration interval can be extended to 3 years with justification. The dipoles are also not physically damaged, or repaired during the interval.
3. The Insertion Loss calibration of Dual Directional Coupler and Attenuator were characterized via the network analyzer and compensated during system check.
4. The dielectric probe kit was calibrated via the network analyzer, with the specified procedure (calibrated in pure water) and calibration kit (standard) short circuit, before the dielectric measurement. The specific procedure and calibration kit are provided by Agilent.
5. In system check we need to monitor the level on the power meter, and adjust the power amplifier level to have precise power level to the dipole; the measured SAR will be normalized to 1W input power according to the ratio of 1W to the input power to the dipole. For system check, the calibration of the power amplifier is deemed not critically required for correct measurement; the power meter is critical and we do have calibration for it

6. Tissue Simulating Liquids

For the measurement of the field distribution inside the SAM phantom with DASY, the phantom must be filled with around 25 liters of homogeneous body tissue simulating liquid. For head SAR testing, the liquid height from the ear reference point (ERP) of the phantom to the liquid top surface is larger than 15 cm, which is shown in Fig. 6.1. For body SAR testing, the liquid height from the center of the flat phantom to the liquid top surface is larger than 15 cm, which is shown as followed:



Liquid depth in the body phantom (2450MHz)



Liquid depth in the body phantom (5GHz)

The following table gives the recipes for tissue simulating liquid.

Frequency (MHz)	Water (%)	Sugar (%)	Cellulose (%)	Salt (%)	Prevento I (%)	DGBE (%)	Conductivity (σ)	Permittivity (ϵ_r)
For Body								
5000	78.6	0	10.7	0	10.7	0	6.00	48.2

Shenzhen Anbotek Compliance Laboratory Limited

Address: 1/F., Building D, Sogood Science and Technology Park, Sanwei Community, Hangcheng Street, Bao'an District, Shenzhen, Guangdong, China.
Tel: (86) 755-26066440 Fax: (86) 755-26014772 Email: service@anbotek.com

Hotline
400-003-0500
www.anbotek.com

Tissue dielectric parameters for head and body phantoms				
Target Frequency	Head		Body	
(MHz)	ϵ_r	σ (s/m)	ϵ_r	σ (s/m)
835	41.5	0.90	55.2	0.97
1800-2000	40.0	1.40	53.3	1.52
2450	39.2	1.80	52.7	1.95
5200	36.00	4.66	49.0	5.30
5400	35.80	4.86	48.9	5.42
5600	35.50	5.07	48.5	5.77
5800	35.30	5.27	48.2	6.00

The following table shows the measuring results for simulating liquid.

Tissue Type	Measured Frequency (MHz)	Target Tissue		Measured Tissue				Liquid Temp.(°C)	Test Date
		ϵ_r	σ	ϵ_r	Dev. (%)	σ	Dev. (%)		
2450	2450	52.7	1.95	52.12	-1.10	1.93	-1.03	22.1	2020-04-12
5000	5200	49.0	5.30	50.47	3.00	5.11	-3.58	21.8	2020-04-14
5000	5800	48.20	6.00	46.36	-3.82	6.15	2.50	21.8	2020-04-14

7. System Verification Procedures

Each DASY system is equipped with one or more system validation kits. These units, together with the predefined measurement procedures within the DASY software, enable the user to conduct the system performance check and system validation. System validation kit includes a dipole, tripod holder to fix it underneath the flat phantom and a corresponding distance holder.

➤ Purpose of System Performance check

The system performance check verifies that the system operates within its specifications. System and operator errors can be detected and corrected. It is recommended that the system performance check be performed prior to any usage of the system in order to guarantee reproducible results. The system performance check uses normal SAR measurements in a simplified setup with a well characterized source. This setup was selected to give a high sensitivity to all parameters that might fail or vary over time. The system check does not intend to replace the calibration of the components, but indicates situations where the system uncertainty is exceeded due to drift or failure.

➤ System Setup

In the simplified setup for system evaluation, the EUT is replaced by a calibrated dipole and the power source is replaced by a continuous wave that comes from a signal generator. The calibrated dipole must be placed beneath the flat phantom section of the SAM twin phantom with the correct distance holder. The distance holder should touch the phantom surface with a light pressure at the reference marking and be oriented parallel to the long side of the phantom. The equipment setup is shown below:

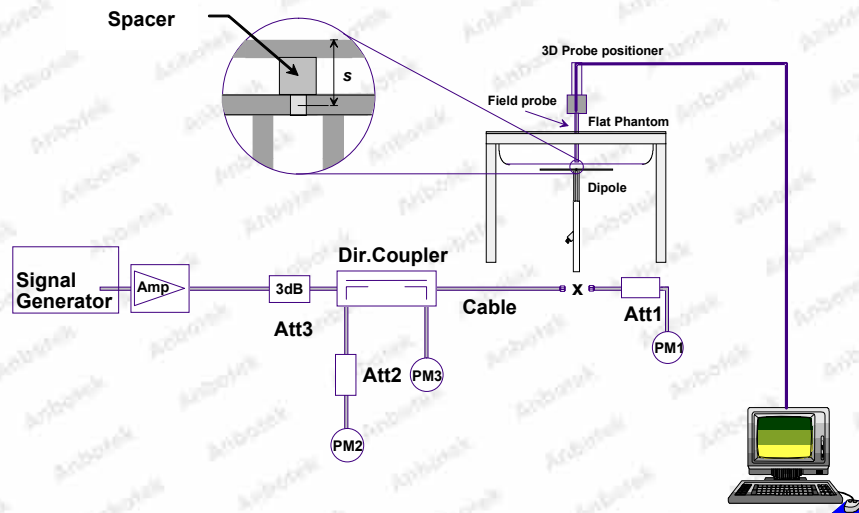

System Setup for System Evaluation

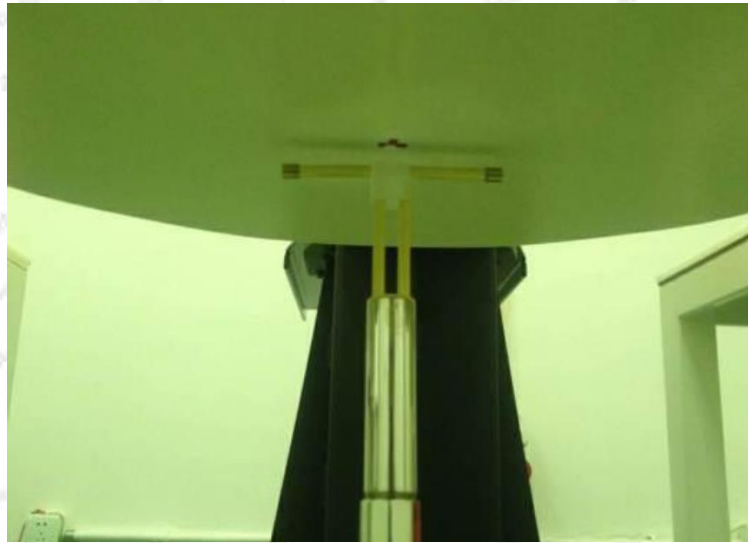

Photo of Dipole Setup

Validation Results

Comparing to the original SAR value provided by SPEAG, the verification data should be within its specification of 10%. The table below shows the target SAR and measured SAR after normalized to 1W input power. It indicates that the system performance check can meet the variation criterion and the plots can be referred to Appendix A of this report.

Frequency (MHz)	Liquid Type	Power fed onto reference dipole (mW)	Targeted SAR (W/kg)	Measured SAR (W/kg)	Normalized SAR (W/kg)	Deviation (%)	Test Date
2450	Body	250	51.8	12.74	50.96	-1.62	2020-04-12
5200	Body	100	77.8	7.48	74.8	3.86	2020-04-14
5800	Body	100	78.3	7.91	79.1	1.02	2020-04-14

Target and Measurement SAR after Normalized

8. EUT Testing Position

8.1 Body Worn Position

Body-worn operating configurations are tested with the belt-clips and holsters attached to the device and positioned against a flat phantom in a normal use configuration. Per KDB 648474 D04, body-worn accessory exposure is typically related to voice mode operations when handsets are carried in body-worn accessories. The body-worn accessory procedures in FCC KDB 447498 D01 v06, 2015 should be used to test for body-worn accessory SAR compliance, without a headset connected to it. This enables the test results for such configuration to be compatible with that required for hotspot mode when the body-worn accessory test separation distance is greater than or equal to that required for hotspot mode, when applicable. When the reported SAR for body-worn accessory, measured without a headset connected to the handset is < 1.2 W/kg, the highest reported SAR configuration for that wireless mode and frequency band should be repeated for that body-worn accessory with a handset attached to the handset.

Accessories for body-worn operation configurations are divided into two categories: those that do not contain metallic components and those that do contain metallic components and those that do contain metallic components. When multiple accessories that do not contain metallic components are supplied with the device, the device is tested with only the accessory that dictates the closest spacing to the body. Then multiple accessories that contain metallic components are tested with the device with each accessory. If multiple accessories share an identical metallic component (i.e. the same metallic belt-clip used with different holsters with no other metallic components) only the accessory that dictates the closest spacing to the body is tested.

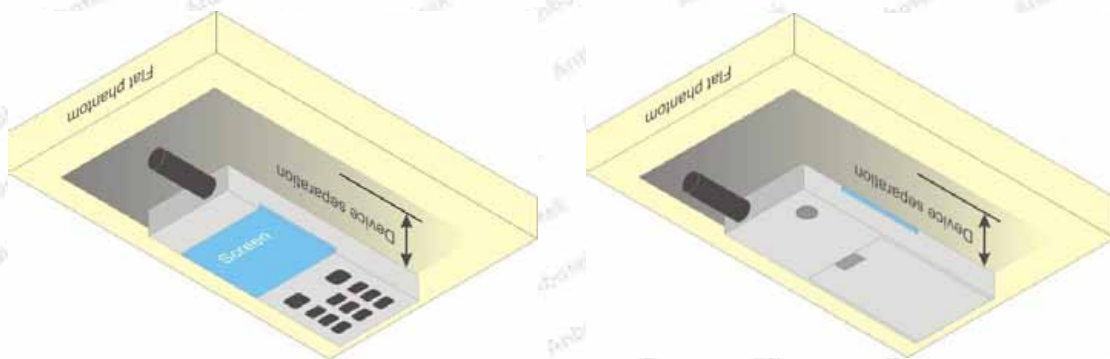

Body Worn Position

9. Measurement Procedures

The measurement procedures are as follows:

- (a) Use base station simulator (if applicable) or engineering software to transmit RF power continuously (continuous Tx) in the middle channel.
- (b) Keep EUT to radiate maximum output power or 100% duty factor (if applicable)
- (c) Measure output power through RF cable and power meter.
- (d) Place the EUT in the positions as setup photos demonstrates.
- (e) Set scan area, grid size and other setting on the DASY software.
- (f) Measure SAR transmitting at the middle channel for all applicable exposure positions.
- (g) Identify the exposure position and device configuration resulting the highest SAR
- (h) Measure SAR at the lowest and highest channels at the worst exposure position and device configuration if applicable.

According to the test standard, the recommended procedure for assessing the peak spatial-average SAR value consists of the following steps:

- (a) Power reference measurement
- (b) Area scan
- (c) Zoom scan
- (d) Power drift measurement

9.1 Spatial Peak SAR Evaluation

The procedure for spatial peak SAR evaluation has been implemented according to the test standard. It can be conducted for 1g and 10g, as well as for user-specific masses. The DASY software includes all numerical procedures necessary to evaluate the spatial peak SAR value.

The base for the evaluation is a "cube" measurement. The measured volume must include the 1g and 10g cubes with the highest averaged SAR values. For that purpose, the center of the measured volume is aligned to the interpolated peak SAR value of a previously performed area scan.

The entire evaluation of the spatial peak values is performed within the post-processing engine (SEMCAD). The system always gives the maximum values for the 1g and 10g cubes. The algorithm to find the cube with highest averaged SAR is divided into the following stages:

- (a) Extraction of the measured data (grid and values) from the Zoom Scan
- (b) Calculation of the SAR value at every measurement point based on all stored data (A/D values and measurement parameters)
- (c) Generation of a high-resolution mesh within the measured volume
- (d) Interpolation of all measured values from the measurement grid to the high-resolution grid
- (e) Extrapolation of the entire 3-D field distribution to the phantom surface over the distance from

sensor to surface

- (f) Calculation of the averaged SAR within masses of 1g and 10g

9. 2 Power Reference Measurement

The Power Reference Measurement and Power Drift Measurements are for monitoring the power drift of the device under test in the batch process. The minimum distance of probe sensors to surface determines the closest measurement point to phantom surface. This distance cannot be smaller than the distance of sensor calibration points to probe tip as defined in the probe properties.

9. 3 Area Scan Procedures

The area scan is used as a fast scan in two dimensions to find the area of high field values, before doing a fine measurement around the hot spot. The sophisticated interpolation routines implemented in DASY software can find the maximum found in the scanned area, within a range of the global maximum. The range (in dB0 is specified in the standards for compliance testing. For example, a 2 dB range is required in IEEE standard 1528 and IEC 62209 standards, whereby 3 dB is a requirement when compliance is assessed in accordance with the ARIB standard (Japan), if only one zoom scan follows the area scan, then only the absolute maximum will be taken as reference. For cases where multiple maximums are detected, the number of zoom scans has to be increased accordingly.

Area scan parameters extracted from FCC KDB 865664 D01 SAR measurement 100 MHz to 6 GHz.

	≤ 3 GHz	> 3 GHz
Maximum distance from closest measurement point (geometric center of probe sensors) to phantom surface	5 ± 1 mm	$\frac{1}{2} \cdot \delta \cdot \ln(2) \pm 0.5$ mm
Maximum probe angle from probe axis to phantom surface normal at the measurement location	30° ± 1°	20° ± 1°
Maximum area scan spatial resolution: $\Delta x_{Area}, \Delta y_{Area}$	≤ 2 GHz: ≤ 15 mm 2 – 3 GHz: ≤ 12 mm	3 – 4 GHz: ≤ 12 mm 4 – 6 GHz: ≤ 10 mm
	When the x or y dimension of the test device, in the measurement plane orientation, is smaller than the above, the measurement resolution must be ≤ the corresponding x or y dimension of the test device with at least one measurement point on the test device.	

9. 4 Zoom Scan Procedures

Zoom scans are used to assess the peak spatial SAR values within a cubic averaging volume containing 1 gram and 10gram of simulated tissue. The zoom scan measures points (refer to table below) within a cube whose base faces are centered on the maxima found in a preceding area scan job within the same procedure. When the measurement is done, the zoom scan evaluates the averaged SAR for 1 gram and 10 gram and displays these values next to the job's label.

Zoom scan parameters extracted from FCC KDB 865664 D01 SAR measurement 100 MHz to 6 GHz.

			≤ 3 GHz	> 3 GHz
Maximum zoom scan spatial resolution: $\Delta x_{Zoom}, \Delta y_{Zoom}$			≤ 2 GHz: ≤ 8 mm $2 - 3$ GHz: ≤ 5 mm*	$3 - 4$ GHz: ≤ 5 mm* $4 - 6$ GHz: ≤ 4 mm*
Maximum zoom scan spatial resolution, normal to phantom surface	uniform grid: $\Delta z_{Zoom}(n)$		≤ 5 mm	$3 - 4$ GHz: ≤ 4 mm $4 - 5$ GHz: ≤ 3 mm $5 - 6$ GHz: ≤ 2 mm
	graded grid	$\Delta z_{Zoom}(1)$: between 1 st two points closest to phantom surface	≤ 4 mm	$3 - 4$ GHz: ≤ 3 mm $4 - 5$ GHz: ≤ 2.5 mm $5 - 6$ GHz: ≤ 2 mm
		$\Delta z_{Zoom}(n>1)$: between subsequent points	$\leq 1.5 \cdot \Delta z_{Zoom}(n-1)$	
Minimum zoom scan volume	x, y, z	≥ 30 mm	$3 - 4$ GHz: ≥ 28 mm $4 - 5$ GHz: ≥ 25 mm $5 - 6$ GHz: ≥ 22 mm	
Note: δ is the penetration depth of a plane-wave at normal incidence to the tissue medium; see draft standard IEEE P1528-2011 for details. * When zoom scan is required and the <i>reported</i> SAR from the <i>area scan based 1-g SAR estimation</i> procedures of KDB 447498 is ≤ 1.4 W/kg, ≤ 8 mm, ≤ 7 mm and ≤ 5 mm zoom scan resolution may be applied, respectively, for 2 GHz to 3 GHz, 3 GHz to 4 GHz and 4 GHz to 6 GHz.				

9.5 Volume Scan Procedures

The volume scan is used for assess overlapping SAR distributions for antennas transmitting in different frequency bands. It is equivalent to an oversized zoom scan used in standalone measurements. The measurement volume will be used to enclose all the simultaneous transmitting antennas. For antennas transmitting simultaneously in different frequency bands, the volume scan is measured separately in each frequency band. In order to sum correctly to compute the 1g aggregateSAR, the EUT remain in the same test position for all measurements and all volume scan use the same spatial resolution and grid spacing. When all volume scan were completed, the software, SEMCAD postprocessor can combine and subsequently superpose these measurement data to calculating the multiband SAR.

9.6 Power Drift Monitoring

All SAR testing is under the EUT install full charged battery and transmit maximum output power. In DASY measurement software, the power reference measurement and power drift measurement procedures are used for monitoring the power drift of EUT during SAR test. Both these procedures measure the field at a specified reference position before and after the SAR testing. The software will calculate the field difference in dB. If the power drift more than 5%, the SAR will be retested.

10. Conducted Power

<WLAN 2.4GHz Conducted Power>

Ant0

Mode	Channel	Frequency (MHz)	Conducted Peak Power (dBm)	Tune-up Peak Power (dBm)	Conducted Average Power (dBm)	Tune-up Average Power (dBm)	Test Rate Data
802.11b	1	2412	17.20	17.5	14.57	15.0	1 Mbps
	6	2437	17.13	17.5	14.53	15.0	1 Mbps
	11	2462	17.06	17.5	14.44	15.0	1 Mbps
802.11g	1	2412	17.28	17.5	14.61	15.0	6 Mbps
	6	2437	17.24	17.5	14.56	15.0	6 Mbps
	11	2462	17.19	17.5	14.37	15.0	6 Mbps
802.11n(20MHz)	1	2412	17.29	17.5	14.64	15.0	MCS0
	6	2437	17.17	17.5	14.48	15.0	MCS0
	11	2462	17.11	17.5	14.34	15.0	MCS0
802.11n(40MHz)	3	2422	17.05	17.5	14.39	15.0	MCS0
	6	2437	17.12	17.5	14.49	15.0	MCS0
	9	2452	17.21	17.5	14.58	15.0	MCS0

Ant1

Mode	Channel	Frequency (MHz)	Conducted Peak Power (dBm)	Tune-up Peak Power (dBm)	Conducted Average Power (dBm)	Tune-up Average Power (dBm)	Test Rate Data
802.11b	1	2412	17.04	17.5	14.37	15.0	1 Mbps
	6	2437	17.23	17.5	14.53	15.0	1 Mbps
	11	2462	17.11	17.5	14.40	15.0	1 Mbps
802.11g	1	2412	17.25	17.5	14.51	15.0	6 Mbps
	6	2437	17.11	17.5	14.53	15.0	6 Mbps
	11	2462	17.02	17.5	14.33	15.0	6 Mbps
802.11n(20MHz)	1	2412	17.31	17.5	14.58	15.0	MCS0
	6	2437	17.13	17.5	14.50	15.0	MCS0
	11	2462	17.37	17.5	14.63	15.0	MCS0
802.11n(40MHz)	3	2422	17.25	17.5	14.54	15.0	MCS0

	6	2437	17.17	17.5	14.48	15.0	MCS0
	9	2452	17.22	17.5	14.49	15.0	MCS0

<WLAN 5G Conducted Power>

Ant0

Mode	Frequency range (MHz)	Channel	Frequency (MHz)	Output Power AV (dBm)	Tune-up Power (dBm)
802.11a	5150~ 5250	36	5180	11.04	12.0
		40	5200	11.07	12.0
		48	5240	11.12	12.0
	5725~5850	149	5745	10.92	12.0
		157	5785	11.13	12.0
		165	5825	10.96	12.0
802.11n(H20)	5150~ 5250	36	5180	11.06	12.0
		40	5200	11.00	12.0
		48	5240	10.99	12.0
	5725~5850	149	5745	11.02	12.0
		157	5785	11.16	12.0
		165	5825	11.04	12.0
802.11ac(H20)	5150~ 5250	36	5180	10.93	12.0
		40	5200	11.03	12.0
		48	5240	10.98	12.0
	5725~5850	149	5745	11.10	12.0
		157	5785	11.03	12.0
		165	5825	10.94	12.0
802.11n(H40)	5150~ 5250	38	5190	11.09	11.5
		46	5230	11.11	11.5
	5725~5850	151	5755	11.11	11.5
		159	5795	11.02	11.5
802.11ac(H40)	5150~ 5250	38	5190	11.17	11.5
		46	5230	11.00	11.5
	5725~5850	151	5755	11.13	11.5
		159	5795	10.95	11.5
802.11ac(H80)	5150~ 5250	42	5210	10.97	11.5
	5725~5850	156	5775	11.07	11.5

Ant1

Mode	Frequency range (MHz)	Channel	Frequency (MHz)	Output Power AV (dBm)	Tune-up Power (dBm)
802.11a	5150~ 5250	36	5180	11.19	12.0
		40	5200	10.97	12.0
		48	5240	11.21	12.0
	5725~5850	149	5745	11.12	12.0
		157	5785	11.10	12.0
		165	5825	11.25	12.0
802.11n(H20)	5150~ 5250	36	5180	11.15	12.0
		40	5200	10.99	12.0
		48	5240	11.01	12.0
	5725~5850	149	5745	10.99	12.0
		157	5785	11.17	12.0
		165	5825	11.17	12.0
802.11ac(H20)	5150~ 5250	36	5180	11.23	12.0
		40	5200	11.16	12.0
		48	5240	11.01	12.0
	5725~5850	149	5745	11.04	12.0
		157	5785	11.13	12.0
		165	5825	11.19	12.0
802.11n(H40)	5150~ 5250	38	5190	11.15	11.5
		46	5230	11.08	11.5
	5725~5850	151	5755	11.08	11.5
		159	5795	10.96	11.5
802.11ac(H40)	5150~ 5250	38	5190	11.07	11.5
		46	5230	11.04	11.5
	5725~5850	151	5755	11.00	11.5
		159	5795	11.03	11.5
802.11ac(H80)	5150~ 5250	42	5210	11.18	11.5
	5725~5850	156	5775	11.19	11.5

Shenzhen Anbotek Compliance Laboratory Limited

Address: 1/F., Building D, Sogood Science and Technology Park, Sanwei Community, Hangcheng Street, Bao'an District, Shenzhen, Guangdong, China.
 Tel: (86) 755-26066440 Fax: (86) 755-26014772 Email: service@anbotek.com

 Hotline
 400-003-0500
www.anbotek.com

<Bluetooth Conducted Power>

Mode	Channel	Frequency (MHz)	Conducted power (dBm)	Tune-up power(dBm)
GFSK	0	2402	0.02	1.0
	39	2441	0.72	1.0
	78	2480	0.51	1.0
π/4QPSK	0	2402	-0.46	0.0
	39	2441	0.24	1.0
	78	2480	0.02	1.0
8DPSK	0	2402	-0.46	0.0
	39	2441	0.24	1.0
	78	2480	-0.11	0.0
BLE(GFSK)	0	2402	-4.19	-4.0
	19	2440	-3.79	-3.0
	39	2480	-4.55	-4.0

Note:

Per KDB 447498 D01v05r02, the 1-g and 10-g SAR test exclusion thresholds for 100 MHz to 6 GHz at test separation distances ≤ 50 mm are determined by:

$$[(\text{max. power of channel, including tune-up tolerance, mW})/(\text{min. test separation distance, mm})] \cdot [\sqrt{f(\text{GHz})}] \leq 3.0$$

for 1-g SAR and ≤ 7.5 for 10-g extremity SAR

f(GHz) is the RF channel transmit frequency in GHz

Power and distance are rounded to the nearest mW and mm before calculation

The result is rounded to one decimal place for comparison

Band/Mode	F(GHz)	Position	SAR test exclusion threshold (mW)	RF output power		SAR test exclusion
				dBm	mW	
Bluetooth	2.45	Body	9.6	1.0	1.3	Yes

Per KDB 447498 D01, when the minimum test separation distance is <5mm, a distance of 5mm is applied to determine SAR test exclusion.

11. Antenna Location

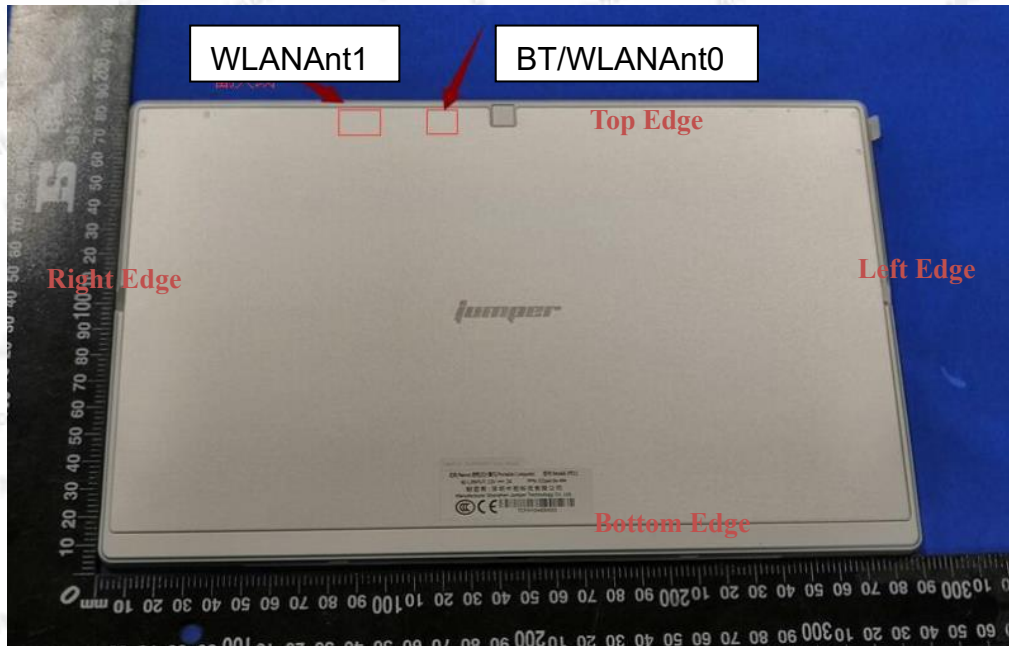

EUT BACK VIEW

Distance of The Antenna to the EUT surface and edge						
Antennas	Front	Back	Top Side	Bottom Side	Left Side	Right Side
Ant0	<25mm	<25mm	<25mm	>25mm	>25mm	>25mm
Ant1	<25mm	<25mm	<25mm	>25mm	>25mm	>25mm

Positions for SAR tests						
Antennas	Front	Back	Top Side	Bottom Side	Left Side	Right Side
Ant0	Yes	Yes	Yes	No	No	No
Ant1	Yes	Yes	Yes	No	No	No

Note:

The separation distance required for incorporation in qualified hosts is described in KDB Publication 447498 D01; item e) of 4.1 and item a) of 5.2.2 etc.

- a) ≤ 25 mm between the antenna and user for incorporation in laptop display screens 15
- b) ≤ 5 mm between the antenna and user; only when incorporation in the keyboard compartment is required by the hosts, for bottom surface and edge exposure conditions

12. SAR Test Results Summary

General Note:

- Per KDB 447498 D01 v06, 2015, the reported SAR is the measured SAR value adjusted for maximum tune-up tolerance.

Scaling Factor = tune-up limit power (mW) / EUT RF power (mW), where tune-up limit is the maximum rated power among all production units.

Reported SAR(W/kg)= Measured SAR(W/kg) Scaling Factor*

- Per KDB 447498 D01 v06, 2015, for each exposure position, if the highest output channel reported SAR ≤ 0.8W/kg, other channels SAR testing are not necessary

Ant0

Plot No.	Band	Mode	Test Position	Gap (cm)	Ch.	Freq. (MHz)	Average Power (dBm)	Tune-Up Limit (dBm)	Scaling Factor	Power Drift (dB)	Measured SAR _{1g} (W/kg)	Reported SAR _{1g} (W/kg)
#1	WIFI 2.4GHZ	b	Front	0.0	1	2412	14.57	15.0	1.104	0.08	0.301	0.332
	WIFI 2.4GHZ	b	Back	0.0	1	2412	14.57	15.0	1.104	-0.07	0.444	0.490
	WIFI 2.4GHZ	b	Top Side	0.0	1	2412	14.57	15.0	1.104	0.03	0.361	0.399
#2	WIFI 5.2GHZ	a	Front	0.0	48	5240	11.12	12.0	1.225	0.10	0.129	0.158
	WIFI 5.2GHZ	a	Back	0.0	48	5240	11.12	12.0	1.225	-0.06	0.189	0.231
	WIFI 5.2GHZ	a	Top Side	0.0	48	5240	11.12	12.0	1.225	-0.03	0.154	0.189
	WIFI 5.8GHZ	a	Front	0.0	157	5785	11.13	12.0	1.222	-0.06	0.141	0.172
	WIFI 5.8GHZ	a	Back	0.0	157	5785	11.13	12.0	1.222	0.10	0.208	0.254
	WIFI 5.8GHZ	a	Top Side	0.0	157	5785	11.13	12.0	1.222	-0.08	0.169	0.206

WLAN- Scaled Reported SAR							
Mode	Test Position	Frequency		Actual duty factor	maximum duty factor	Reported SAR (1g)(W/kg)	Scaled reported SAR (1g)(W/kg)
		CH	MHz				
802.11b	Front	1	2412	98.61%	100%	0.332	0.337
	Back	1	2412	98.61%	100%	0.490	0.497
	Top Side	1	2412	98.61%	100%	0.399	0.405
802.11a	Front	48	5240	97.5%	100%	0.158	0.162
	Back	48	5240	97.5%	100%	0.231	0.237
	Top Side	48	5240	97.5%	100%	0.189	0.194
	Front	157	5785	97.5%	100%	0.172	0.176
	Back	157	5785	97.5%	100%	0.254	0.261
	Top Side	157	5785	97.5%	100%	0.206	0.211

Ant1

Plot No.	Band	Mode	Test Position	Gap (cm)	Ch.	Freq. (MHz)	Average Power (dBm)	Tune-Up Limit (dBm)	Scaling Factor	Power Drift (dB)	Measured SAR _{1g} (W/kg)	Reported SAR _{1g} (W/kg)
	WIFI 2.4GHz	b	Front	0.0	6	2437	14.53	15.0	1.114	0.18	0.280	0.312
#3	WIFI 2.4GHz	b	Back	0.0	6	2437	14.53	15.0	1.114	-0.03	0.413	0.460
	WIFI 2.4GHz	b	Top Side	0.0	6	2437	14.53	15.0	1.114	0.03	0.335	0.373
	WIFI 5.2GHz	a	Front	0.0	48	5240	11.21	12.0	1.199	0.15	0.166	0.199
	WIFI 5.2GHz	a	Back	0.0	48	5240	11.21	12.0	1.199	0.13	0.245	0.294
	WIFI 5.2GHz	a	Top Side	0.0	48	5240	11.21	12.0	1.199	0.12	0.199	0.239
	WIFI 5.8GHz	a	Front	0.0	165	5825	11.25	12.0	1.189	-0.13	0.183	0.217
#4	WIFI 5.8GHz	a	Back	0.0	165	5825	11.25	12.0	1.189	0.16	0.269	0.320
	WIFI 5.8GHz	a	Top Side	0.0	165	5825	11.25	12.0	1.189	-0.06	0.218	0.259

WLAN- Scaled Reported SAR							
Mode	Test Position	Frequency		Actual duty factor	maximum duty factor	Reported SAR (1g)(W/kg)	Scaled reported SAR (1g)(W/kg)
		CH	MHz				
802.11b	Front	6	2437	98.61%	100%	0.312	0.316
	Back	6	2437	98.61%	100%	0.460	0.466
	Top Side	6	2437	98.61%	100%	0.373	0.378
802.11a	Front	48	5240	97.5%	100%	0.199	0.204
	Back	48	5240	97.5%	100%	0.294	0.302
	Top Side	48	5240	97.5%	100%	0.239	0.245
	Front	165	5825	97.5%	100%	0.217	0.223
	Back	165	5825	97.5%	100%	0.320	0.328
	Top Side	165	5825	97.5%	100%	0.259	0.266

Note:

- According to the above table, the initial test position for body is "Back", and its reported SAR is ≤ 0.4W/kg. Thus further SAR measurement is not required for the other (remaining) test positions. Because the reported SAR of the highest measured maximum output power channel for the exposure configuration is ≤ 0.8W/kg, no further SAR testing is required for 802.11b DSSS in that exposure configuration.
- When SAR measurement is required for 2.4 GHz 802.11g/n OFDM configurations, the measurement and test reduction procedures for OFDM are applied (section 5.3 of of KDB 248227D01v02r01). SAR is not required for the following 2.4 GHz OFDM conditions.
 - When KDB Publication 447498 SAR test exclusion applies to the OFDM configuration.
 - When the highest *reported* SAR for DSSS is adjusted by the ratio of OFDM to DSSS specified maximum output power and the adjusted SAR is ≤ 1.2 W/kg.

Shenzhen Anbotek Compliance Laboratory Limited

3. An **Initial Test Configuration** is determined for OFDM transmission modes according to the channel bandwidth, modulation and data rate combination(s) with the highest maximum output power specified for production units in each standalone and aggregated frequency band. SAR is measured using the highest measured maximum output power channel. For configurations with the same specified or measured maximum output power, additional transmission mode and test channel selection procedures are required (see section 5.3.2 of KDB 248227D01). SAR test reduction of subsequent highest output test channels is based on the *reported* SAR of the **Initial Test Configuration**.

4. **WiFi 5G SAR Test Procedures**

For devices that operate in only one of the U-NII-1 and U-NII-2A bands, the normally required SAR procedures for OFDM configurations are applied. For devices that operate in both U-NII bands using the same transmitter and antenna(s), SAR test reduction is determined according to the following:

- 1) When the same maximum output power is specified for both bands, begin SAR measurement in U-NII-2A band by applying the OFDM SAR requirements. If the highest reported SAR for a test configuration is ≤ 1.2 W/kg, SAR is not required for U-NII-1 band for that configuration (802.11 mode and exposure condition); otherwise, both bands are tested independently for SAR.
- 2) When different maximum output power is specified for the bands, begin SAR measurement in the band with higher specified maximum output power. The highest reported SAR for the tested configuration is adjusted by the ratio of lower to higher specified maximum output power for the two bands. When the adjusted SAR is ≤ 1.2 W/kg, SAR is not required for the band with lower maximum output power in that test configuration; otherwise, both bands are tested independently for SAR.

5. **OFDM Transmission Mode SAR Test Configuration and Channel Selection Requirements**

The **Initial Test Configuration** for 5 GHz OFDM transmission modes is determined by the 802.11 configuration with the highest maximum output power specified for production units, including tune-up tolerance, in each standalone and aggregated frequency band. SAR for the **Initial Test Configuration** is measured using the highest maximum output power channel determined by the default power measurement procedures. When multiple configurations in a frequency band have the same specified maximum output power, the **Initial Test Configuration** is determined according to the following steps applied sequentially.

- 1) The largest channel bandwidth configuration is selected among the multiple configurations with the same specified maximum output power.
- 2) If multiple configurations have the same specified maximum output power and largest channel bandwidth, the lowest order modulation among the largest channel bandwidth configurations is selected.
- 3) If multiple configurations have the same specified maximum output power, largest channel bandwidth and lowest order modulation, the lowest data rate configuration among these configurations is selected.
- 4) When multiple transmission modes (802.11a/g/n/ac) have the same specified maximum output power, largest channel bandwidth, lowest order modulation and lowest data rate, the lowest order 802.11 mode is selected; i.e., 802.11a is chosen over 802.11n then 802.11ac or 802.11g is chosen over 802.11n.

After an **Initial Test Configuration** is determined, if multiple test channels have the same measured maximum output power, the channel chosen for SAR measurement is determined according to the following. These channel selection

procedures apply to both the **Initial Test Configuration** and subsequent test configuration(s), with respect to the default power measurement procedures or additional power measurements required for further SAR test reduction. The same procedures also apply to subsequent highest output power channel(s) selection.

- 1) The channel closest to mid-band frequency is selected for SAR measurement.
- 2) For channels with equal separation from mid-band frequency; for example, high and low channels or two mid-band channels, the higher frequency (number) channel is selected for SAR measurement.

13. SAR Measurement Variability

SAR measurement variability must be assessed for each frequency band, which is determined by the SAR probe calibration point and tissue-equivalent medium used for the device measurements. When both head and body tissue-equivalent media are required for SAR measurements in a frequency band, the variability measurement procedures should be applied to the tissue medium with the highest measured SAR, using the highest measured SAR configuration for that tissue-equivalent medium. The following procedures are applied to determine if repeated measurements are required.

- 1) Repeated measurement is not required when the original highest measured SAR is < 0.80 W/kg; steps 2) through 4) do not apply.
- 2) When the original highest measured SAR is ≥ 0.80 W/kg, repeat that measurement once.
- 3) Perform a third repeated measurement only if the original, first or second repeated measurement is ≥ 1.5 W/kg and the ratio of largest to smallest SAR for the original, first and second repeated measurements is > 1.20 .

14. Simultaneous Transmission Analysis

No.	Simultaneous Transmission Configurations	Body
1	Wifi 2.4G Ant 0 + Wifi 5G Ant 1	Yes
2	Wifi 2.4G Ant 1 + Wifi 5G Ant 0	Yes
3	Wifi 2.4G Ant 1 + BT	Yes
4	Wifi 5G Ant 1 + BT	Yes

General note:

1. WLAN Ant0 and Bluetooth share the same antenna, and cannot transmit simultaneously.
2. WLAN Ant1 and Bluetooth cannot transmit simultaneously.
3. The reported SAR summation is calculated based on the same configuration and test position
4. For simultaneous transmission analysis, Bluetooth SAR is estimated per KDB 447498 D01 based on the formula below
 - a) $[(\text{max. Power of channel, including tune-up tolerance, mW}) / (\text{min. test separation distance, mm})]^x$ *
 $[\sqrt{f(\text{GHz})}] \text{W/kg}$ for test separation distances $\leq 50\text{mm}$; when $x=7.5$ for 1-g SAR, and $x=18.75$ for 10-g SAR.
 - b) When the minimum separation distance is $<5\text{mm}$, the distance is used 5mm to determine SAR test exclusion
 - c) 0.4 W/kg for 1-g SAR and 1.0W/kg for 10-g SAR, when the test separation distances is $>50\text{mm}$.

Bluetooth Max power	Exposure position	Body
	Test separation	0mm
1.0 dBm	Estimated SAR (W/kg)	0.053 W/kg

Wifi 2.4G Ant 0 + Wifi 5G Ant 1

Exposure Position	Max SAR (W/kg)		Sum
	Wifi 2.4G Ant 0	Wifi 5G Ant 1	(W/kg)
Front	0.337	0.223	0.560
Back	0.497	0.328	0.825
Top Side	0.405	0.266	0.671

Wifi 2.4G Ant 1 + Wifi 5G Ant 0

Exposure Position	Max SAR (W/kg)		Sum
	Wifi 2.4G Ant 1	Wifi 5G Ant 0	(W/kg)
Front	0.316	0.176	0.492
Back	0.466	0.261	0.727
Top Side	0.378	0.211	0.589

Wifi 2.4G Ant 1 + BT

Exposure Position	Max SAR (W/kg)		Sum
	Wifi 2.4G Ant 1	BT	(W/kg)
Front	0.316	0.053	0.369
Back	0.466	0.053	0.519
Top Side	0.378	0.053	0.431

Wifi 5G Ant 1 + BT

Exposure Position	Max SAR (W/kg)		Sum
	Wifi 5G Ant 1	BT	(W/kg)
Front	0.223	0.053	0.276
Back	0.328	0.053	0.381
Top Side	0.266	0.053	0.319

15. Measurement Uncertainty

Per KDB865664D01 SAR Measurement 100MHz to 6GHz, when the highest measured 1-g SAR within a frequency band is $<1.5\text{W/Kg}$, the extensive SAR measurement uncertainty analysis described in IEC 62209-2:2010 is not required in SAR reports submitted for equipment approval.

Appendix A. EUT Photos and Test Setup Photos



Back side(0mm)



Front side(0mm)



Top side(0mm)

Appendix B. Plots of SAR System Check

System Performance Check at 2450 MHz

Date:2020-04-12

DUT: Dipole 2450 MHz; Type: D2450V2; Serial: 910

Communication System: CW; Frequency: 2450 MHz;Duty Cycle: 1:1

Medium parameters used (interpolated): $f = 2450$ MHz; $\sigma = 1.93$ S/m; $\epsilon_r = 52.12$; $\rho = 1000$ kg/m³

Phantom section: Flat Section

DASY5 Configuration:

Probe: EX3DV4 - SN7396; ConvF(7.53, 7.53, 7.53); Calibrated: 05.06.2019;

Sensor-Surface: 3mm (Mechanical Surface Detection)

Electronics: DAE4 Sn387; Calibrated: 09.03.2019

Phantom: SAM 1; Type: SAM;

Measurement SW: DASY52, Version 52.8 (1); SEMCAD X Version 14.6.5 (6469)

Area Scan (61x91x1):Measurement grid: dx=10.00 mm, dy=10.00 mm

Maximum value of SAR (interpolated) = 19.225 mW/g

Zoom Scan (7x7x7)/Cube 0: Measurement grid: dx=5mm, dy=5mm, dz=5mm

Reference Value = 84.153 V/m; Power Drift = 0.05dB

Peak SAR (extrapolated) = 26.125 W/kg

SAR(1 g) = 12.74 mW/g; SAR(10 g) = 5.69 mW/g

Maximum value of SAR (measured) = 19.18mW/g

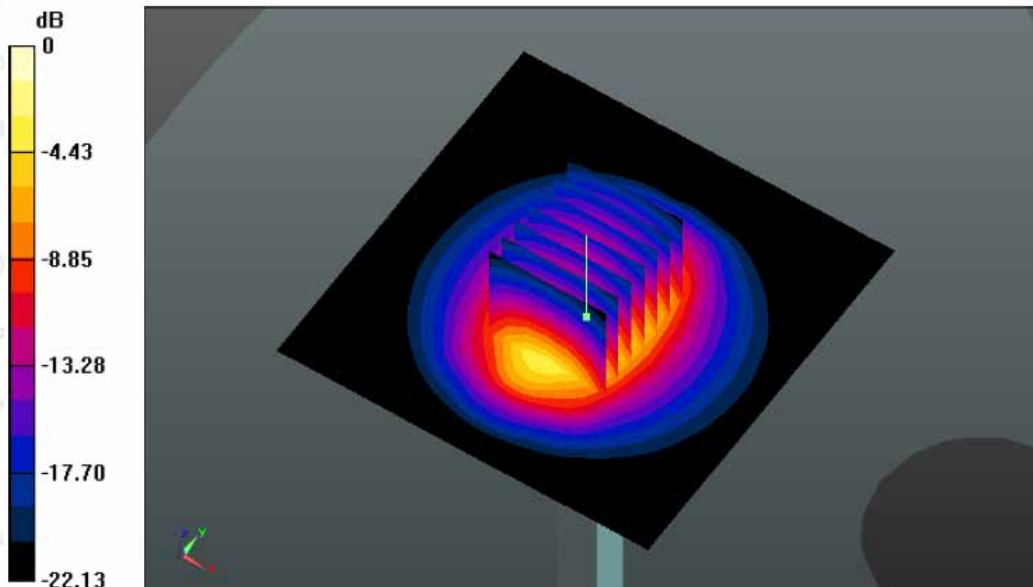

5200MHz System Check

Date:2020-04-14

DUT: Dipole 5 GHz; Type: D5GHzV2; Serial: D5GHzV2 - SN:1160

Communication System: UID 0, CW; Frequency: 5200 MHz; Duty Cycle: 1:1

Medium parameters used: $f = 5200$ MHz; $\sigma = 5.11$ S/m; $\epsilon_r = 50.47$; $\rho = 1000$ kg/m³

Phantom section: Flat Section

DASY5 Configuration:

- Probe: EX3DV4 – SN7396; ConvF(4.93, 4.93, 4.93); Calibrated: 05.06.2019;
- Sensor-Surface: 1.4mm (Mechanical Surface Detection)
- Electronics: DAE4 Sn387; Calibrated: 09.03.2019
- Phantom: SAM2; Type: QD000P40CD; Serial: TP:1670
- Measurement SW: DASY52, Version 52.8 (7); SEMCAD X Version 14.6.10 (7164)

Configuration/Pin=100mW/Area Scan (71x71x1):Interpolated grid: dx=1.000 mm, dy=1.000 mm

Maximum value of SAR (interpolated) = 19.05 W/kg

Configuration/Pin=100mW/Zoom Scan (7x7x7)/Cube 0:Measurement grid: dx=4mm, dy=4mm, dz=1.4mm

Reference Value = 60.064 V/m; Power Drift = 0.03 dB

Peak SAR (extrapolated) = 33.36 W/kg

SAR(1 g) = 7.48 W/kg; SAR(10 g) = 2.12 W/kg

Maximum value of SAR (measured) = 19.13 W/kg

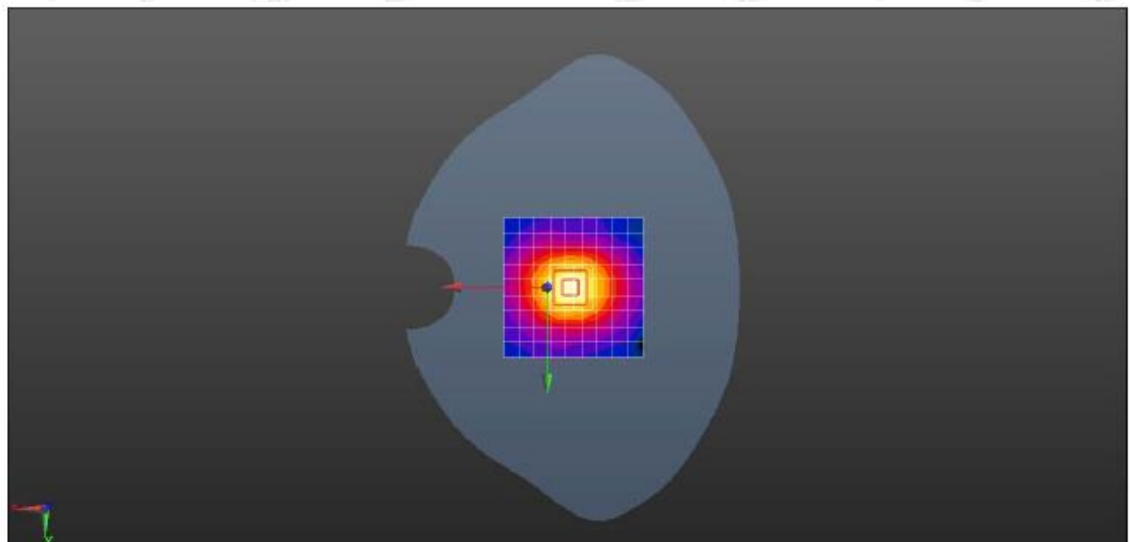
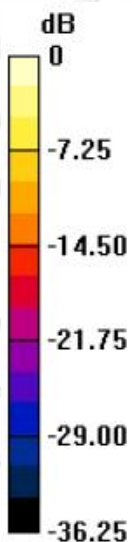

5800MHz System Check

Date:2020-04-14

DUT: Dipole 5 GHz; Type: D5GHzV2; Serial: D5GHzV2 - SN:1160

Communication System: UID 0, CW; Frequency: 5800 MHz; Duty Cycle: 1:1

Medium parameters used: $f = 5800$ MHz; $\sigma = 6.15$ S/m; $\epsilon_r = 46.36$; $\rho = 1000$ kg/m³

Phantom section: Flat Section

DASY5 Configuration:

- Probe: EX3DV4 – SN7396; ConvF(4.52, 4.52, 4.52); Calibrated: 05,06.2019;
- Sensor-Surface: 1.4mm (Mechanical Surface Detection)
- Electronics: DAE4 Sn387; Calibrated: 09.03.2019
- Phantom: SAM2; Type: QD000P40CD; Serial: TP:1670
- Measurement SW: DASY52, Version 52.8 (7); SEMCAD X Version 14.6.10 (7164)

Configuration/Pin=100mW/Area Scan (71x71x1):Interpolated grid: dx=1.000 mm, dy=1.000 mm
Maximum value of SAR (interpolated) = 18.9 W/kg

Configuration/Pin=100mW/Zoom Scan (7x7x7)/Cube 0:Measurement grid: dx=4mm, dy=4mm, dz=1.4mm

Reference Value = 49.005 V/m; Power Drift = 0.08 dB

Peak SAR (extrapolated) = 31.8 W/kg

SAR(1 g) = 7.91 W/kg; SAR(10 g) = 2.17 W/kg

Maximum value of SAR (measured) = 19.4 W/kg

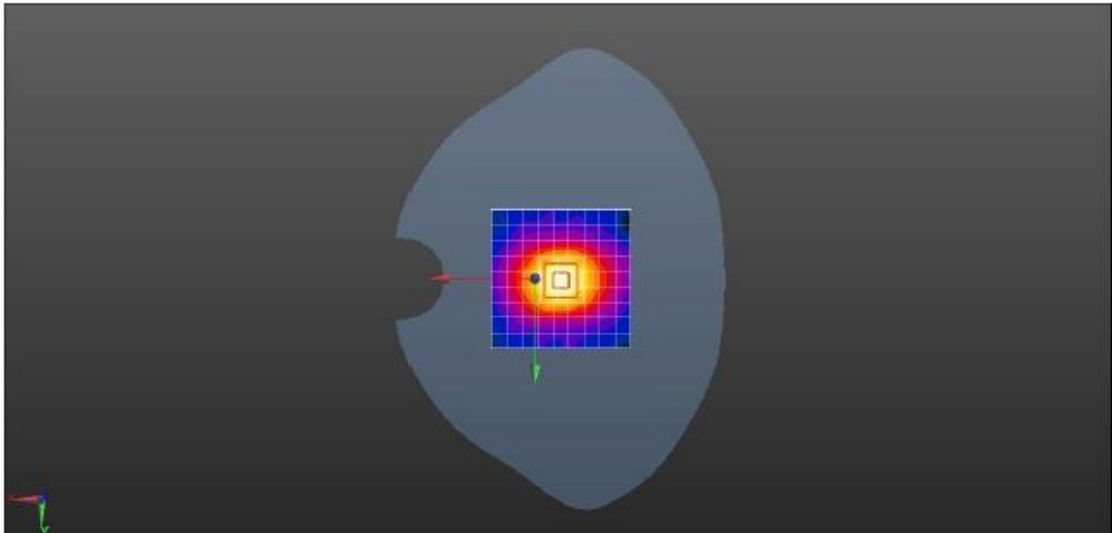
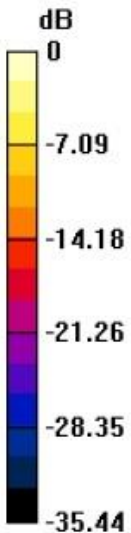

Appendix C. Plots of SAR Test Data

#1

Date:2020-04-12

WIFI 2.4G _802.11b_Body _Ch1

Communication System: UID 0, wifi (fcc) (0); Frequency: 2412 MHz;

Medium parameters used (interpolated): $f = 2412$ MHz; $\sigma = 1.92$ S/m; $\epsilon_r = 53.83$; $\rho = 1000$ kg/m³

Phantom section: Flat Section

DASY5 Configuration:

- Probe: EX3DV4 - SN7396; ConvF(7.53, 7.53, 7.53); Calibrated: 05.06.2019;
- Sensor-Surface: 4mm (Mechanical Surface Detection)
- Electronics: DAE4 Sn387; Calibrated: 09.03.2019
- Phantom: SAM 1; Type: SAM;
- Measurement SW: DASY52, Version 52.8 (2); SEMCAD X Version 14.6.10 (7164)

Area Scan (81x61x1): Interpolated grid: dx=1.000 mm, dy=1.000 mm

Maximum value of SAR (interpolated) =0.616 W/kg

Zoom Scan (7x7x7)/Cube 0: Measurement grid: dx=5mm, dy=5mm, dz=5mm

Reference Value = 6.122 V/m; Power Drift = -0.07 dB

Peak SAR (extrapolated) = 1.02 W/kg

SAR(1 g) = 0.444 W/kg; SAR(10 g) = 0.219 W/kg

Maximum value of SAR (measured) = 0.488 W/kg

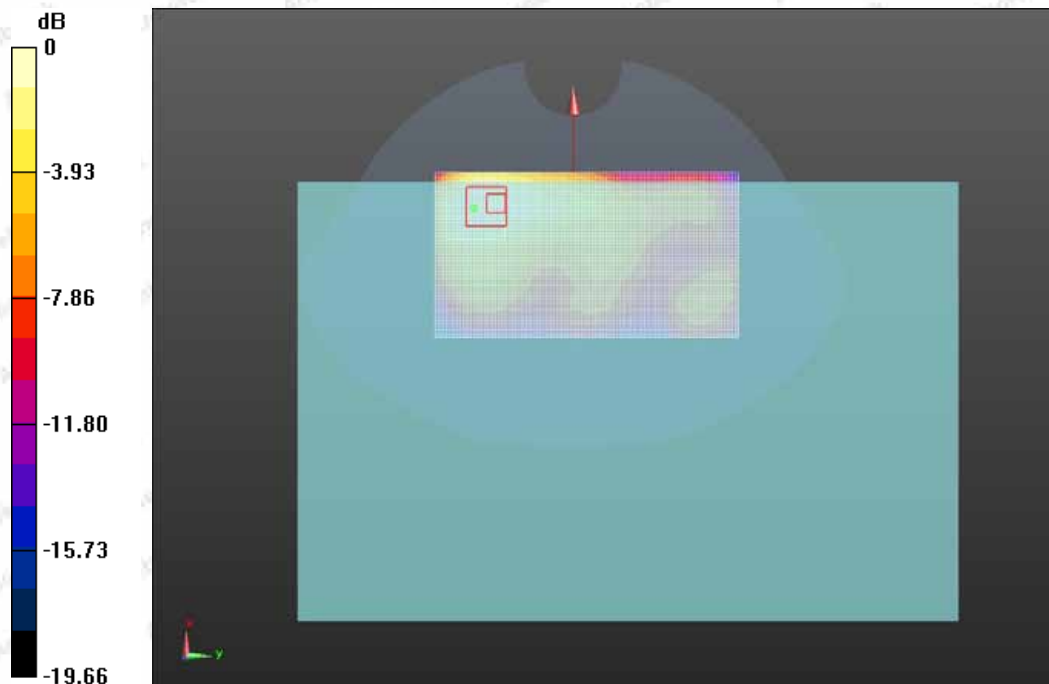

Date: 2020-04-14

WIFI 5.8G _Body _Ch157

Communication System: UID 0, 802.11a (0); Frequency: 5785MHz;

Medium parameters used (interpolated): $f = 5785$ MHz; $\sigma = 6.14$ S/m; $\epsilon_r = 46.55$; $\rho = 1000$ kg/m³

Phantom section: Flat Section

DASY5 Configuration:

- Probe: EX3DV4 – SN7396; ConvF(4.52, 4.52, 4.52); Calibrated: 05,06.2019;
- Sensor-Surface: 2mm (Mechanical Surface Detection)
- Electronics: DAE4 Sn387; Calibrated: 09.03.2019
- Phantom: SAM2; Type: QD000P40CD; Serial: TP:1670
- Measurement SW: DASY52, Version 52.8 (7); SEMCAD X Version 14.6.10 (7164)

Area Scan (9x13x1):Measurement grid: dx=10mm, dy=10mm

Maximum value of SAR (measured) = 0.378 W/kg

Zoom Scan (8x8x12)/Cube 0:Measurement grid: dx=4mm, dy=4mm, dz=2mm

Reference Value = 3.797 V/m; Power Drift = 0.10 dB

Peak SAR (extrapolated) = 1.01 W/kg

SAR(1 g) = 0.208 W/kg; SAR(10 g) = 0.075 W/kg

Maximum value of SAR (measured) = 0.534 W/kg

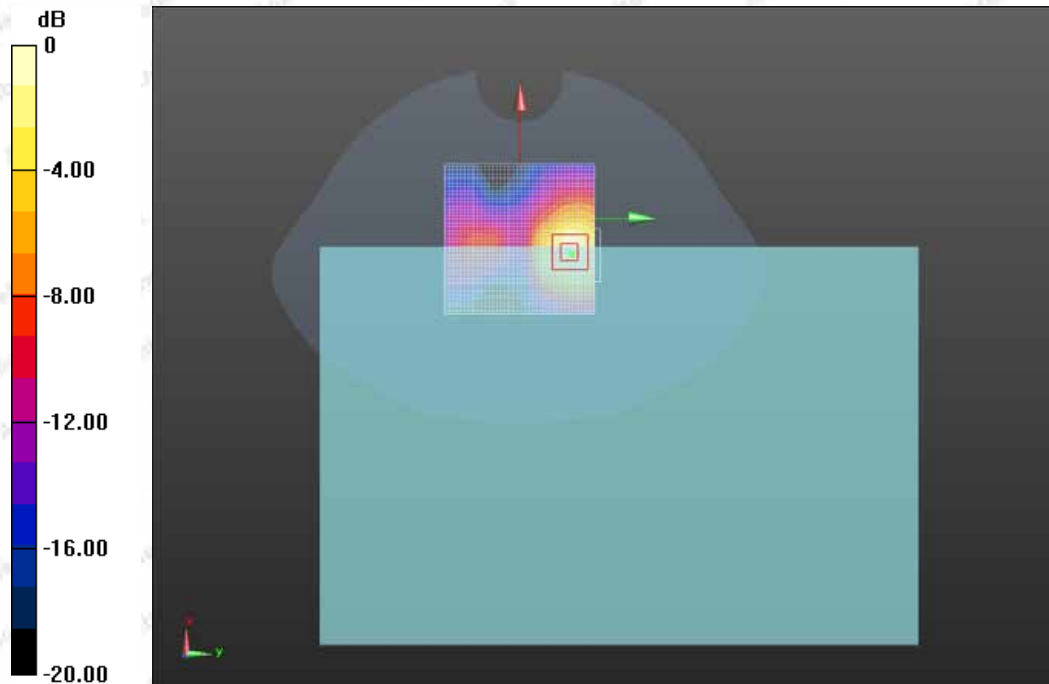

#3

Date:2020-04-12

WIFI 2.4G _802.11b_Body _C6

Communication System: UID 0, wifi (fcc) (0); Frequency: 2437 MHz;

Medium parameters used (interpolated): $f = 2437$ MHz; $\sigma = 1.93$ S/m; $\epsilon_r = 52.96$; $\rho = 1000$ kg/m³

Phantom section: Flat Section

DASY5 Configuration:

- Probe: EX3DV4 - SN7396; ConvF(7.53, 7.53, 7.53); Calibrated: 05,06.2019;
- Sensor-Surface: 4mm (Mechanical Surface Detection)
- Electronics: DAE4 Sn387; Calibrated: 09.03.2019
- Phantom: SAM 1; Type: SAM;
- Measurement SW: DASY52, Version 52.8 (2); SEMCAD X Version 14.6.10 (7164)

Area Scan (81x61x1): Interpolated grid: dx=1.000 mm, dy=1.000 mm

Maximum value of SAR (interpolated) =0.622 W/kg

Zoom Scan (7x7x7)/Cube 0: Measurement grid: dx=5mm, dy=5mm, dz=5mm

Reference Value = 6.455 V/m; Power Drift = -0.03 dB

Peak SAR (extrapolated) = 1.01 W/kg

SAR(1 g) = 0.413 W/kg; SAR(10 g) = 0.212 W/kg

Maximum value of SAR (measured) = 0.535 W/kg

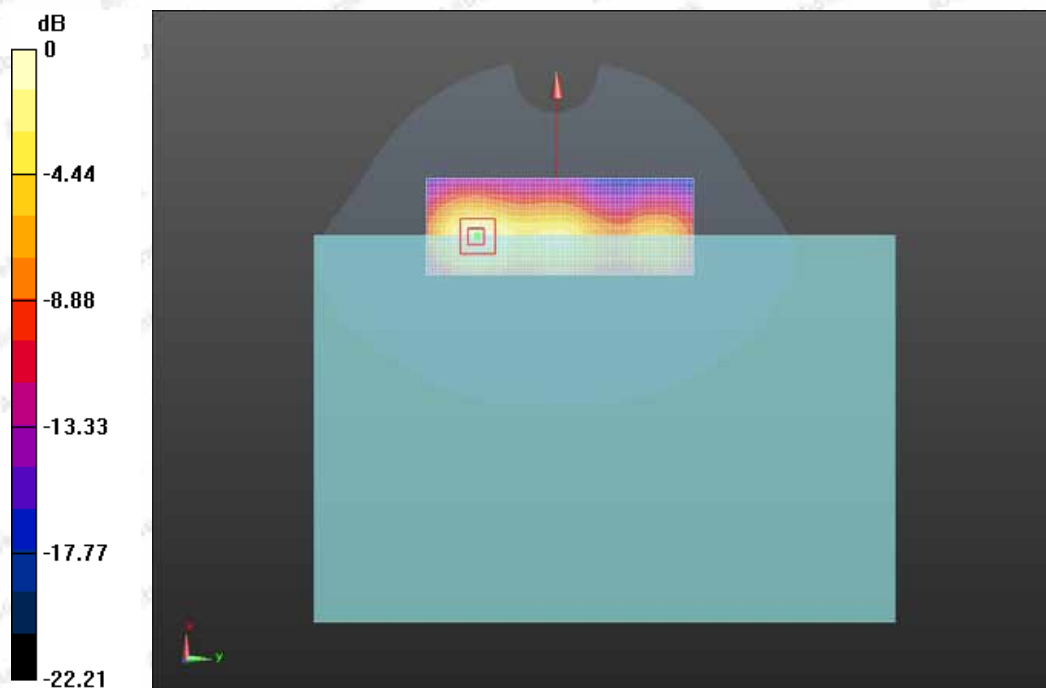

#4

Date: 2020-04-14

WIFI 5.8G _Body _Ch165

Communication System: UID 0, 802.11a (0); Frequency: 5825MHz;

Medium parameters used (interpolated): $f = 5825$ MHz; $\sigma = 6.23$ S/m; $\epsilon_r = 46.13$; $\rho = 1000$ kg/m³

Phantom section: Flat Section

DASY5 Configuration:

- Probe: EX3DV4 – SN7396; ConvF(4.52, 4.52, 4.52); Calibrated: 05,06.2019;
- Sensor-Surface: 2mm (Mechanical Surface Detection)
- Electronics: DAE4 Sn387; Calibrated: 09.03.2019
- Phantom: SAM2; Type: QD000P40CD; Serial: TP:1670
- Measurement SW: DASY52, Version 52.8 (7); SEMCAD X Version 14.6.10 (7164)

Area Scan (9x13x1):Measurement grid: dx=10mm, dy=10mm

Maximum value of SAR (measured) = 0.509 W/kg

Zoom Scan (8x8x12)/Cube 0:Measurement grid: dx=4mm, dy=4mm, dz=2mm

Reference Value = 4.659 V/m; Power Drift = 0.16 dB

Peak SAR (extrapolated) = 1.10 W/kg

SAR(1 g) = 0.269 W/kg; SAR(10 g) = 0.097 W/kg

Maximum value of SAR (measured) = 0.613 W/kg

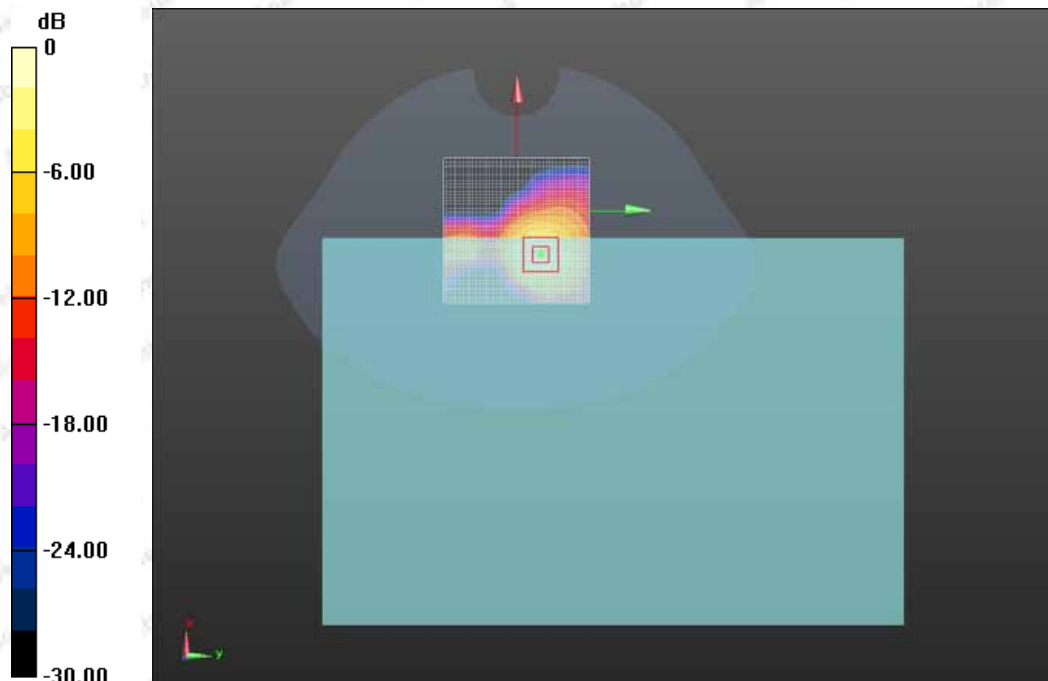





Shenzhen Anbotek Compliance Laboratory Limited

Address: 1/F., Building D, Sogood Science and Technology Park, Sanwei Community, Hangcheng Street, Bao'an District, Shenzhen, Guangdong, China.

Tel: (86) 755-26066440 Fax: (86) 755-26014772 Email: service@anbotek.com

Hotline
400-003-0500
www.anbotek.com

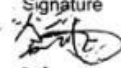
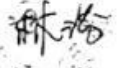
Appendix D. DASY System Calibration Certificate

		In Collaboration with s p e a g CALIBRATION LABORATORY						中国认可 国际互认 校准 CALIBRATION CNAS L0570		
Add: No.51 Xueyuan Road, Haidian District, Beijing, 100191, China Tel: +86-10-62304633-2218 Fax: +86-10-62304633-2209 E-mail: cttl@chinattl.com Http://www.chinattl.cn										
Client Anbotek (Auden)				Certificate No: Z19-68716						
CALIBRATION CERTIFICATE										
Object		EX3DV4 - SN:7396								
Calibration Procedure(s)		FF-Z11-007-03 Calibration Procedures for Dosimetric E-field Probes								
Calibration date:		May06, 2019								
This calibration Certificate documents the traceability to national standards, which realize the physical units of measurements(SI). The measurements and the uncertainties with confidence probability are given on the following pages and are part of the certificate.										
All calibrations have been conducted in the closed laboratory facility: environment temperature:(22±3)°C and humidity<70%.										
Calibration Equipment used (M&TE critical for calibration)										
Primary Standards		ID #	Cal Date(Calibrated by, Certificate No.)				Scheduled Calibration			
Power Meter	NRP2	101919	20-Jun-18 (CTTL, No.J18X07447)				Jun-19			
Power sensor	NRP-Z91	101547	20-Jun-18 (CTTL, No.J18X07447)				Jun-19			
Power sensor	NRP-Z91	101548	20-Jun-18 (CTTL, No.J18X07447)				Jun-19			
Reference10dBAttenuator	18N50W-10dB	13-Mar-19	(CTTL, No.J19X01547)				Mar-20			
Reference20dBAttenuator	18N50W-20dB	13-Mar-19	(CTTL, No.J19X01548)				Mar-20			
Reference Probe EX3DV4	SN 7433	26-Sep-18	(SPEAG, No.EX3-7433_Sep18)				Sep-19			
DAE4	SN 549	13-Dec-18	(SPEAG, No.DAE4-549_Dec18)				Dec -19			
Secondary Standards		ID #	Cal Date(Calibrated by, Certificate No.)				Scheduled Calibration			
SignalGenerator	MG3700A	6201052605	27-Jun-18 (CTTL, No.J18X04776)				Jun-19			
Network Analyzer	E5071C	MY46110673	13-Jan-19 (CTTL, No.J19X00285)				Jan -20			
Calibrated by:		Name	Function		Signature					
Reviewed by:		Yu Zongying	SAR Test Engineer							
Approved by:		Lin Hao	SAR Test Engineer							
		Qi Dianyuan	SAR Project Leader							
Issued: May07, 2019										
This calibration certificate shall not be reproduced except in full without written approval of the laboratory.										
Certificate No: Z19-68716					Page 1 of 11					



Add: No.51 Xueyuan Road, Haidian District, Beijing, 100191, China
Tel: +86-10-62304633-2218 Fax: +86-10-62304633-2209
E-mail: cntf@chinattl.com [Http://www.chinattl.cn](http://www.chinattl.cn)

Glossary:

TSL	tissue simulating liquid
NORM _{x,y,z}	sensitivity in free space
ConvF	sensitivity in TSL / NORM _{x,y,z}
DCP	diode compression point
CF	crest factor (1/duty_cycle) of the RF signal
A,B,C,D	modulation dependent linearization parameters
Polarization Φ	Φ rotation around probe axis
Polarization θ	θ rotation around an axis that is in the plane normal to probe axis (at measurement center), i $\theta=0$ is normal to probe axis

Connector Angle information used in DASY system to align probe sensor X to the robot coordinate system

Calibration is Performed According to the Following Standards:

- IEEE Std 1528-2013, "IEEE Recommended Practice for Determining the Peak Spatial-Averaged Specific Absorption Rate (SAR) in the Human Head from Wireless Communications Devices: Measurement Techniques", June 2013
- IEC 62209-1, "Procedure to measure the Specific Absorption Rate (SAR) for hand-held devices used in close proximity to the ear (frequency range of 300MHz to 3GHz)", February 2005
- IEC 62209-2, "Procedure to determine the Specific Absorption Rate (SAR) for wireless communication devices used in close proximity to the human body (frequency range of 30 MHz to 6 GHz)", March 2010
- KDB 865664, "SAR Measurement Requirements for 100 MHz to 6 GHz"

Methods Applied and Interpretation of Parameters:

- NORM_{x,y,z}:** Assessed for E-field polarization $\theta=0$ ($f \leq 900\text{MHz}$ in TEM-cell; $f > 1800\text{MHz}$: waveguide). NORM_{x,y,z} are only intermediate values, i.e., the uncertainties of NORM_{x,y,z} does not effect the E^2 -field uncertainty inside TSL (see below ConvF).
- NORM(f)_{x,y,z} = NORM_{x,y,z} * frequency_response** (see Frequency Response Chart). This linearization is implemented in DASY4 software versions later than 4.2. The uncertainty of the frequency response is included in the stated uncertainty of ConvF.
- DCP_{x,y,z}:** DCP are numerical linearization parameters assessed based on the data of power sweep (no uncertainty required). DCP does not depend on frequency nor media.
- PAR:** PAR is the Peak to Average Ratio that is not calibrated but determined based on the signal characteristics.
- A_{x,y,z}; B_{x,y,z}; C_{x,y,z}; VR_{x,y,z}; A,B,C** are numerical linearization parameters assessed based on the data of power sweep for specific modulation signal. The parameters do not depend on frequency nor media. VR is the maximum calibration range expressed in RMS voltage across the diode.
- ConvF and Boundary Effect Parameters:** Assessed in flat phantom using E-field (or Temperature Transfer Standard for $f \leq 800\text{MHz}$) and inside waveguide using analytical field distributions based on power measurements for $f > 800\text{MHz}$. The same setups are used for assessment of the parameters applied for boundary compensation (alpha, depth) of which typical uncertainty valued are given. These parameters are used in DASY4 software to improve probe accuracy close to the boundary. The sensitivity in TSL corresponds to NORM_{x,y,z} ConvF whereby the uncertainty corresponds to that given for ConvF. A frequency dependent ConvF is used in DASY version 4.4 and higher which allows extending the validity from $\pm 50\text{MHz}$ to $\pm 100\text{MHz}$.
- Spherical isotropy (3D deviation from isotropy):** in a field of low gradients realized using a flat phantom exposed by a patch antenna.
- Sensor Offset:** The sensor offset corresponds to the offset of virtual measurement center from the probe tip (on probe axis). No tolerance required.
- Connector Angle:** The angle is assessed using the information gained by determining the NORM (no uncertainty required).



Add: No.51 Xueyuan Road, Haidian District, Beijing, 100191, China
Tel: +86-10-62304633-2218 Fax: +86-10-62304633-2209
E-mail: cttl@chinattl.com [Http://www.chinattl.cn](http://www.chinattl.cn)

Probe EX3DV4

SN: 7396

Calibrated: May 06, 2019

Calibrated for DASY/EASY Systems

(Note: non-compatible with DASY2 system!)



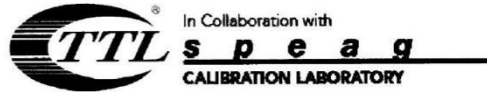

Add: No.51 Xueyuan Road, Haidian District, Beijing, 100191, China
Tel: +86-10-62304633-2218 Fax: +86-10-62304633-2209
E-mail: cttl@chinattl.com [Http://www.chinattl.cn](http://www.chinattl.cn)

DASY/EASY – Parameters of Probe: EX3DV4 – SN: 7396

Basic Calibration Parameters

	Sensor X	Sensor Y	Sensor Z	Unc (k=2)
Norm($\mu\text{V}/(\text{V}/\text{m})^2$) ^A	0.54	0.53	0.50	±10.0%
DCP(mV) ^B	97.8	104.5	102.5	

Modulation Calibration Parameters

UID	Communication System Name		A dB	B dB· μV	C	D dB	VR mV	Unc ^E (k=2)
0	CW	X	0.0	0.0	1.0	0.00	199.9	±2.4%
		Y	0.0	0.0	1.0		203.3	
		Z	0.0	0.0	1.0		195.0	

The reported uncertainty of measurement is stated as the standard uncertainty of Measurement multiplied by the coverage factor k=2, which for a normal distribution Corresponds to a coverage probability of approximately 95%.

^A The uncertainties of Norm X, Y, Z do not affect the E²-field uncertainty inside TSL (see Page 5 and Page 6).

^B Numerical linearization parameter: uncertainty not required.

^E Uncertainty is determined using the max. deviation from linear response applying rectangular distribution and is expressed for the square of the field value.

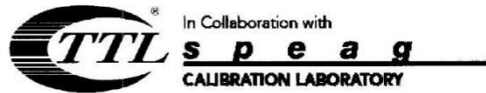

In Collaboration with
 Add: No.51 Xueyuan Road, Haidian District, Beijing, 100191, China
 Tel: +86-10-62304633-2218 Fax: +86-10-62304633-2209
 E-mail: ttl@chinattl.com Http://www.chinattl.cn

DASY/EASY – Parameters of Probe: EX3DV4 – SN: 7396

Calibration Parameter Determined in Head Tissue Simulating Media

f [MHz] ^C	Relative Permittivity ^F	Conductivity (S/m) ^F	ConvF X	ConvF Y	ConvF Z	Alpha ^G	Depth ^G (mm)	Unct. (k=2)
750	41.9	0.89	9.82	9.82	9.82	0.30	0.85	±12.1%
835	41.5	0.90	9.71	9.71	9.71	0.15	1.36	±12.1%
900	41.5	0.97	9.87	9.87	9.87	0.16	1.37	±12.1%
1750	40.1	1.37	8.61	8.61	8.61	0.25	1.04	±12.1%
1900	40.0	1.40	8.13	8.13	8.13	0.24	1.01	±12.1%
2100	39.8	1.49	8.14	8.14	8.14	0.24	1.04	±12.1%
2300	39.5	1.67	7.85	7.85	7.85	0.40	0.75	±12.1%
2450	39.2	1.80	7.57	7.57	7.57	0.50	0.75	±12.1%
2600	39.0	1.96	7.38	7.38	7.38	0.64	0.68	±12.1%
5250	35.9	4.71	5.33	5.33	5.33	0.45	1.30	±13.3%
5600	35.5	5.07	4.89	4.89	4.89	0.45	1.35	±13.3%
5750	35.4	5.22	4.92	4.92	4.92	0.45	1.45	±13.3%

^C Frequency validity above 300 MHz of ±100MHz only applies for DASY v4.4 and higher (Page 2), else it is restricted to ±50MHz. The uncertainty is the RSS of ConvF uncertainty at calibration frequency and the uncertainty for the indicated frequency band. Frequency validity below 300 MHz is ± 10, 25, 40, 50 and 70 MHz for ConvF assessments at 30, 64, 128, 150 and 220 MHz respectively. Above 5 GHz frequency validity can be extended to ± 110 MHz.

^F At frequency below 3 GHz, the validity of tissue parameters (ε and σ) can be relaxed to ±10% if liquid compensation formula is applied to measured SAR values. At frequencies above 3 GHz, the validity of tissue parameters (ε and σ) is restricted to ±5%. The uncertainty is the RSS of the ConvF uncertainty for indicated target tissue parameters.

^G Alpha/Depth are determined during calibration. SPEAG warrants that the remaining deviation due to the boundary effect after compensation is always less than ± 1% for frequencies below 3 GHz and below ± 2% for the frequencies between 3-6 GHz at any distance larger than half the probe tip diameter from the boundary.



Add: No.51 Xueyuan Road, Haidian District, Beijing, 100191, China
Tel: +86-10-62304633-2218 Fax: +86-10-62304633-2209
E-mail: cttl@chinattl.com [Http://www.chinattl.cn](http://www.chinattl.cn)

DASY/EASY – Parameters of Probe: EX3DV4 – SN: 7396

Calibration Parameter Determined in Body Tissue Simulating Media

f [MHz] ^C	Relative Permittivity ^F	Conductivity (S/m) ^F	ConvF X	ConvF Y	ConvF Z	Alpha ^G	Depth ^G (mm)	Unct. (k=2)
750	55.5	0.96	10.09	10.09	10.09	0.30	0.90	±12.1%
835	55.2	0.97	9.88	9.88	9.88	0.19	1.32	±12.1%
900	55.0	1.05	9.82	9.82	9.82	0.23	1.15	±12.1%
1750	53.4	1.49	8.24	8.24	8.24	0.24	1.06	±12.1%
1900	53.3	1.52	7.97	7.97	7.97	0.19	1.24	±12.1%
2100	53.2	1.62	8.18	8.18	8.18	0.19	1.39	±12.1%
2300	52.9	1.81	7.88	7.88	7.88	0.55	0.80	±12.1%
2450	52.7	1.95	7.53	7.53	7.53	0.46	0.89	±12.1%
2600	52.5	2.16	7.38	7.38	7.38	0.52	0.80	±12.1%
5250	48.9	5.36	4.93	4.93	4.93	0.45	1.80	±13.3%
5600	48.5	5.77	4.19	4.19	4.19	0.48	1.90	±13.3%
5750	48.3	5.94	4.52	4.52	4.52	0.48	1.95	±13.3%

^C Frequency validity above 300 MHz of ±100MHz only applies for DASY v4.4 and higher (Page 2), else it is restricted to ±50MHz. The uncertainty is the RSS of ConvF uncertainty at calibration frequency and the uncertainty for the indicated frequency band. Frequency validity below 300 MHz is ± 10, 25, 40, 50 and 70 MHz for ConvF assessments at 30, 64, 128, 150 and 220 MHz respectively. Above 5 GHz frequency validity can be extended to ± 110 MHz.

^F At frequency below 3 GHz, the validity of tissue parameters (ϵ and σ) can be relaxed to ±10% if liquid compensation formula is applied to measured SAR values. At frequencies above 3 GHz, the validity of tissue parameters (ϵ and σ) is restricted to ±5%. The uncertainty is the RSS of the ConvF uncertainty for indicated target tissue parameters.

^G Alpha/Depth are determined during calibration. SPEAG warrants that the remaining deviation due to the boundary effect after compensation is always less than ± 1% for frequencies below 3 GHz and below ± 2% for the frequencies between 3-6 GHz at any distance larger than half the probe tip diameter from the boundary.

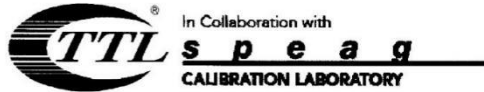

Add: No.51 Xueyuan Road, Haidian District, Beijing, 100191, China
Tel: +86-10-62304633-2218 Fax: +86-10-62304633-2209
E-mail: cttl@chinattl.com [Http://www.chinattl.cn](http://www.chinattl.cn)

Frequency Response of E-Field (TEM-Cell: ifi110 EXX, Waveguide: R22)

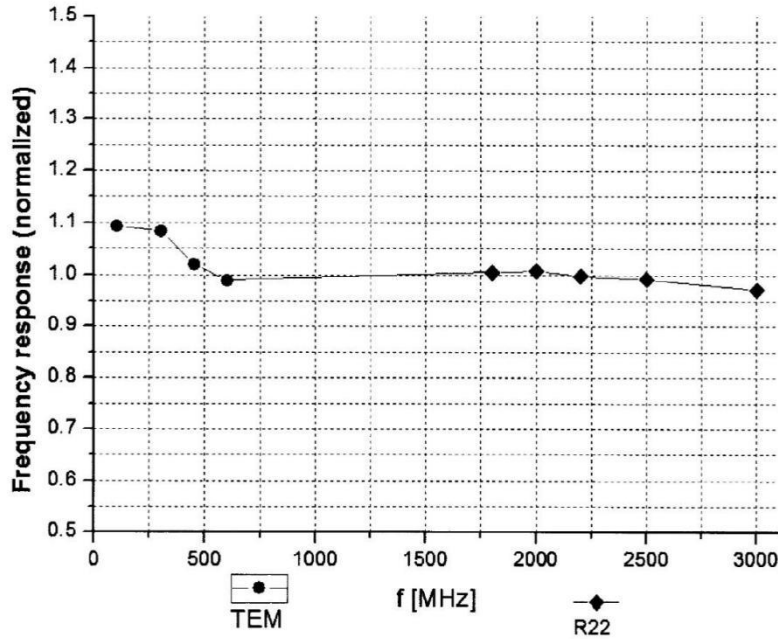

Uncertainty of Frequency Response of E-field: $\pm 7.4\%$ (k=2)



Add: No.51 Xueyuan Road, Haidian District, Beijing, 100191, China
Tel: +86-10-62304633-2218 Fax: +86-10-62304633-2209
E-mail: cttl@chinattl.com [Http://www.chinattl.cn](http://www.chinattl.cn)

Receiving Pattern (Φ), $\theta=0^\circ$

f=600 MHz, TEM

f=1800 MHz, R22

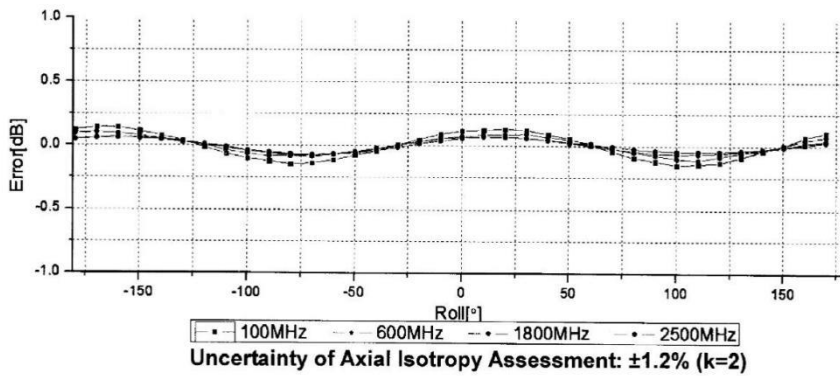
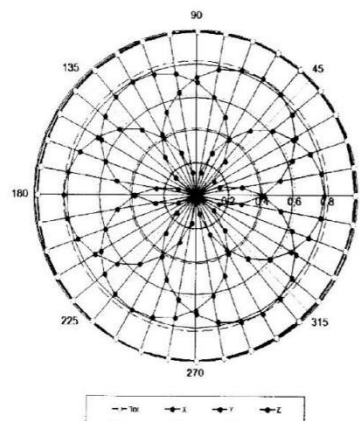
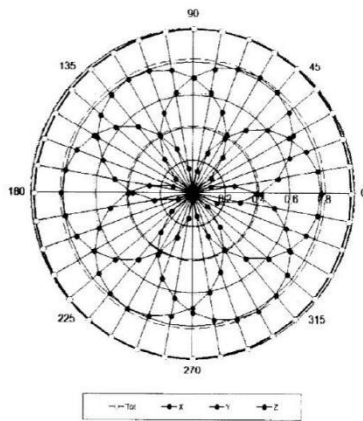

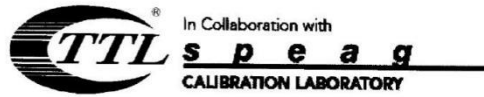

Add: No.51 Xueyuan Road, Haidian District, Beijing, 100191, China
Tel: +86-10-62304633-2218 Fax: +86-10-62304633-2209
E-mail: cttl@chinattl.com Http://www.chinattl.cn

**Dynamic Range f(SAR_{head})
(TEM cell, f = 900 MHz)**

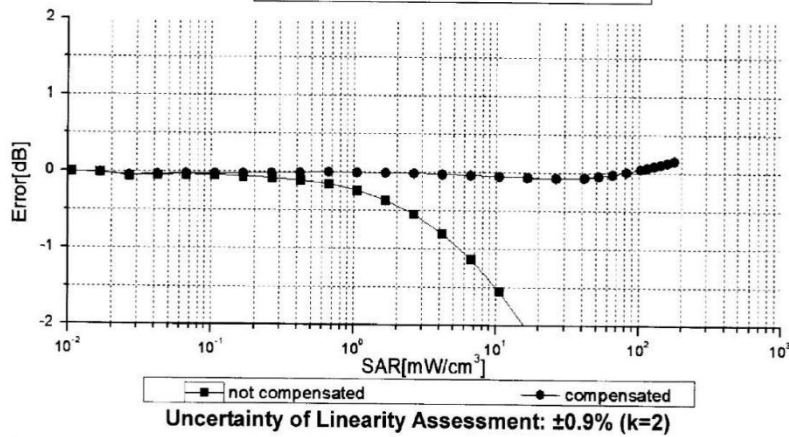
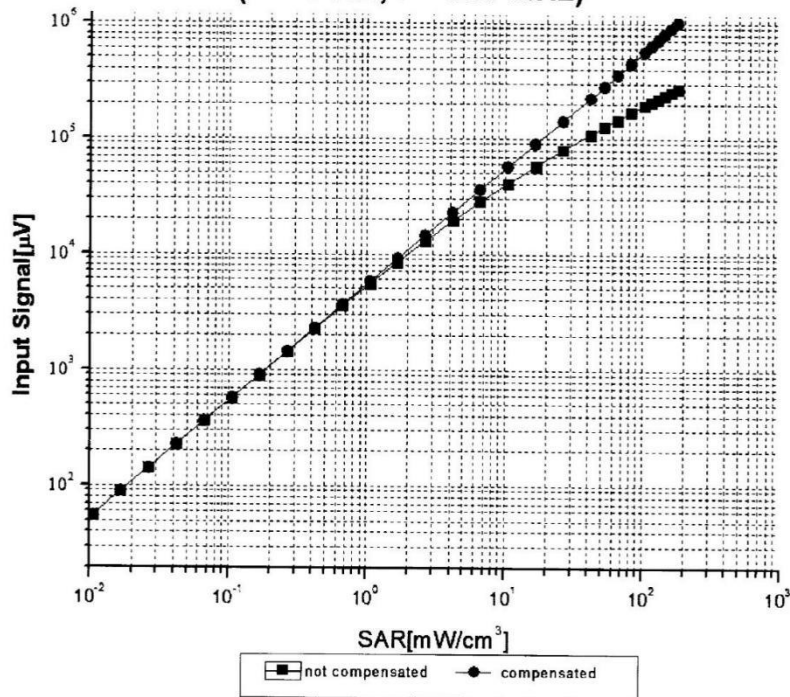

Certificate No: Z18-98671

Page 9 of 11

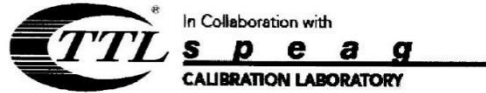

Add: No.51 Xueyuan Road, Haidian District, Beijing, 100191, China
Tel: +86-10-62304633-2218 Fax: +86-10-62304633-2209
E-mail: cttl@chinattl.com Http://www.chinattl.cn

Conversion Factor Assessment

f=900 MHz, WGLS R9(H_convF)

f=1750 MHz, WGLS R22(H_convF)

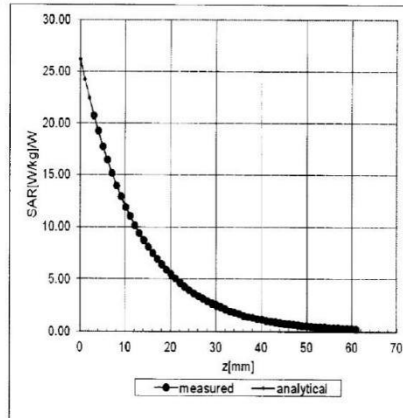
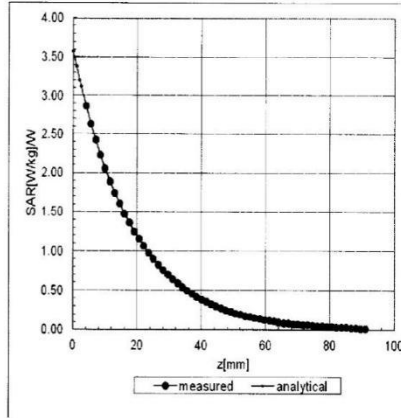

Deviation from Isotropy in Liquid

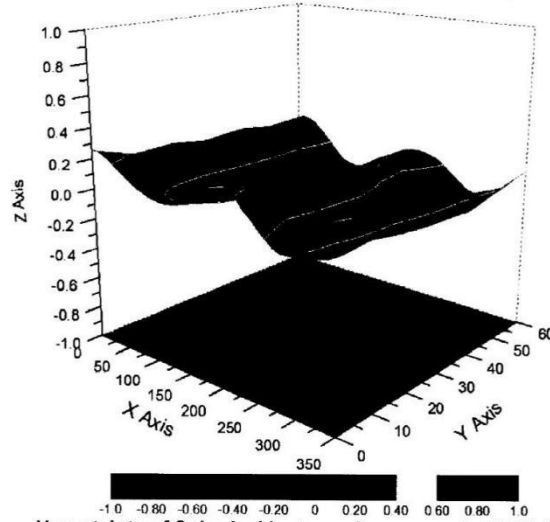

Uncertainty of Spherical Isotropy Assessment: $\pm 3.2\%$ (K=2)

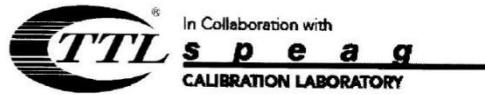

Add: No 51 Xueyuan Road, Haidian District, Beijing, 100191, China
Tel: +86-10-62304633-2218 Fax: +86-10-62304633-2209
E-mail: cttl@chinattl.com Http://www.chinattl.cn

DASY/EASY – Parameters of Probe: EX3DV4 – SN: 7396

Other Probe Parameters

Sensor Arrangement	Triangular
Connector Angle (°)	156.9
Mechanical Surface Detection Mode	enabled
Optical Surface Detection Mode	disable
Probe Overall Length	337mm
Probe Body Diameter	10mm
Tip Length	9mm
Tip Diameter	2.5mm
Probe Tip to Sensor X Calibration Point	1mm
Probe Tip to Sensor Y Calibration Point	1mm
Probe Tip to Sensor Z Calibration Point	1mm
Recommended Measurement Distance from Surface	1.4mm

Schmid & Partner Engineering AG

s p e a g

Zeughausstrasse 43, 8004 Zurich, Switzerland
Phone +41 44 245 9700, Fax +41 44 245 9779
info@speag.com, http://www.speag.com

IMPORTANT NOTICE

USAGE OF THE DAE 4

The DAE unit is a delicate, high precision instrument and requires careful treatment by the user. There are no serviceable parts inside the DAE. Special attention shall be given to the following points:

Battery Exchange: The battery cover of the DAE4 unit is closed using a screw, over tightening the screw may cause the threads inside the DAE to wear out.

Shipping of the DAE: Before shipping the DAE to SPEAG for calibration, remove the batteries and pack the DAE in an antistatic bag. This antistatic bag shall then be packed into a larger box or container which protects the DAE from impacts during transportation. The package shall be marked to indicate that a fragile instrument is inside.

E-Stop Failures: Touch detection may be malfunctioning due to broken magnets in the E-stop. Rough handling of the E-stop may lead to damage of these magnets. Touch and collision errors are often caused by dust and dirt accumulated in the E-stop. To prevent E-stop failure, the customer shall always mount the probe to the DAE carefully and keep the DAE unit in a non-dusty environment if not used for measurements.

Repair: Minor repairs are performed at no extra cost during the annual calibration. However, SPEAG reserves the right to charge for any repair especially if rough unprofessional handling caused the defect.

DASY Configuration Files: Since the exact values of the DAE input resistances, as measured during the calibration procedure of a DAE unit, are not used by the DASY software, a nominal value of 200 MOhm is given in the corresponding configuration file.

Important Note:

Warranty and calibration is void if the DAE unit is disassembled partly or fully by the Customer.

Important Note:

Never attempt to grease or oil the E-stop assembly. Cleaning and readjusting of the E-stop assembly is allowed by certified SPEAG personnel only and is part of the annual calibration procedure.

Important Note:

To prevent damage of the DAE probe connector pins, use great care when installing the probe to the DAE. Carefully connect the probe with the connector notch oriented in the mating position. Avoid any rotational movement of the probe body versus the DAE while turning the locking nut of the connector. The same care shall be used when disconnecting the probe from the DAE.

Schmid & Partner Engineering

TN_BR040315AD DAE4.doc

11.12.2009

Shenzhen Anbotek Compliance Laboratory Limited

Address: 1/F., Building D, Sogood Science and Technology Park, Sanwei Community, Hangcheng Street, Bao'an District, Shenzhen, Guangdong, China.

Tel: (86) 755-26066440 Fax: (86) 755-26014772 Email: service@anbotek.com



Hotline
400-003-0500

www.anbotek.com

**Calibration Laboratory of
Schmid & Partner
Engineering AG**
Zeughausstrasse 43, 8004 Zurich, Switzerland



S Schweizerischer Kalibrierdienst
C Service suisse d'étalonnage
S Servizio svizzero di taratura
S Swiss Calibration Service

Accredited by the Swiss Accreditation Service (SAS)
The Swiss Accreditation Service is one of the signatories to the EA
Multilateral Agreement for the recognition of calibration certificates

Accreditation No.: **SCS 0108**

Client **Anbotek (Auden)**

Certificate No: **DAE4-387_Sep03**

CALIBRATION CERTIFICATE			
Object	DAE4 - SD 000 D04 BM - SN: 387		
Calibration procedure(s)	QA CAL-06.v29 Calibration procedure for the data acquisition electronics (DAE)		
Calibration date:	September 03, 2019		
This calibration certificate documents the traceability to national standards, which realize the physical units of measurements (SI). The measurements and the uncertainties with confidence probability are given on the following pages and are part of the certificate.			
All calibrations have been conducted in the closed laboratory facility: environment temperature (22 ± 3)°C and humidity < 70%.			
Calibration Equipment used (M&TE critical for calibration)			
Primary Standards	ID #	Cal Date (Certificate No.)	Scheduled Calibration
Keithley Multimeter Type 2001	SN: 0810278	11 -Aug-19 (No:21092)	Aug-20
Secondary Standards	ID #	Check Date (in house)	Scheduled Check
Auto DAE Calibration Unit	SE UWS 053 AA 1001	05-Jan-19 (in house check)	In house check: Jan-20
Calibrator Box V2.1	SE UMS 006 AA 1002	05-Jan-19 (in house check)	In house check: Jan-20
Calibrated by:	Name Dominique Steffen	Function Laboratory Technician	Signature
Approved by:	Sven Kühn	Deputy Manager	
This calibration certificate shall not be reproduced except in full without written approval of the laboratory.			Issued: September 03, 2019

**Calibration Laboratory of
Schmid & Partner
Engineering AG**
Zeughausstrasse 43, 8004 Zurich, Switzerland



S Schweizerischer Kalibrierdienst
C Service suisse d'étalonnage
S Servizio svizzero di taratura
S Swiss Calibration Service

Accredited by the Swiss Accreditation Service (SAS)

The Swiss Accreditation Service is one of the signatories to the EA
Multilateral Agreement for the recognition of calibration certificates

Accreditation No.: **SCS 0108**

Glossary

DAE data acquisition electronics
Connector angle information used in DASY system to align probe sensor X to the robot coordinate system.

Methods Applied and Interpretation of Parameters

- **DC Voltage Measurement:** Calibration Factor assessed for use in DASY system by comparison with a calibrated instrument traceable to national standards. The figure given corresponds to the full scale range of the voltmeter in the respective range.
- **Connector angle:** The angle of the connector is assessed measuring the angle mechanically by a tool inserted. Uncertainty is not required.
- The following parameters as documented in the Appendix contain technical information as a result from the performance test and require no uncertainty.
 - **DC Voltage Measurement Linearity:** Verification of the Linearity at +10% and -10% of the nominal calibration voltage. Influence of offset voltage is included in this measurement.
 - **Common mode sensitivity:** Influence of a positive or negative common mode voltage on the differential measurement.
 - **Channel separation:** Influence of a voltage on the neighbor channels not subject to an input voltage.
 - **AD Converter Values with inputs shorted:** Values on the internal AD converter corresponding to zero input voltage
 - **Input Offset Measurement:** Output voltage and statistical results over a large number of zero voltage measurements.
 - **Input Offset Current:** Typical value for information; Maximum channel input offset current, not considering the input resistance.
 - **Input resistance:** Typical value for information: DAE input resistance at the connector, during internal auto-zeroing and during measurement.
 - **Low Battery Alarm Voltage:** Typical value for information. Below this voltage, a battery alarm signal is generated.
 - **Power consumption:** Typical value for information. Supply currents in various operating modes.



DC Voltage Measurement

A/D - Converter Resolution nominal
 High Range: 1LSB = 6.1 μ V , full range = -100...+300 mV
 Low Range: 1LSB = 61nV , full range = -1.....+3mV
 DASy measurement parameters: Auto Zero Time: 3 sec; Measuring time: 3 sec

Calibration Factors	X	Y	Z
High Range	404.489 \pm 0.02% (k=2)	404.852 \pm 0.02% (k=2)	404.862 \pm 0.02% (k=2)
Low Range	3.97827 \pm 1.50% (k=2)	3.95875 \pm 1.50% (k=2)	3.97982 \pm 1.50% (k=2)

Connector Angle

Connector Angle to be used in DASy system	53.0 $^{\circ}$ \pm 1 $^{\circ}$
---	------------------------------------

Appendix (Additional assessments outside the scope of SCS0108)

1. DC Voltage Linearity

High Range	Reading (μV)	Difference (μV)	Error (%)
Channel X + Input	200032.85	-3.31	-0.00
Channel X + Input	20007.64	1.88	0.01
Channel X - Input	-20003.48	1.18	-0.01
Channel Y + Input	200034.23	-1.43	-0.00
Channel Y + Input	20006.60	0.91	0.00
Channel Y - Input	-20004.04	0.72	-0.00
Channel Z + Input	200035.38	-0.83	-0.00
Channel Z + Input	20003.69	-2.11	-0.01
Channel Z - Input	-20006.38	-1.59	0.01

Low Range	Reading (μV)	Difference (μV)	Error (%)
Channel X + Input	2001.63	0.08	0.00
Channel X + Input	202.29	0.70	0.35
Channel X - Input	-197.90	0.60	-0.30
Channel Y + Input	2001.33	-0.07	-0.00
Channel Y + Input	200.86	-0.60	-0.30
Channel Y - Input	-199.87	-1.23	0.62
Channel Z + Input	2001.61	0.27	0.01
Channel Z + Input	200.60	-0.70	-0.35
Channel Z - Input	-199.51	-0.85	0.43

2. Common mode sensitivity

DASY measurement parameters: Auto Zero Time: 3 sec; Measuring time: 3 sec

	Common mode Input Voltage (mV)	High Range Average Reading (μV)	Low Range Average Reading (μV)
Channel X	200	13.50	11.56
	-200	-8.64	-11.18
Channel Y	200	-0.81	-1.28
	-200	1.05	0.09
Channel Z	200	7.17	6.91
	-200	-9.46	-9.01

3. Channel separation

DASY measurement parameters: Auto Zero Time: 3 sec; Measuring time: 3 sec

	Input Voltage (mV)	Channel X (μV)	Channel Y (μV)	Channel Z (μV)
Channel X	200	-	-1.70	0.33
Channel Y	200	10.70	-	-0.38
Channel Z	200	7.11	7.89	-

4. AD-Converter Values with inputs shorted

DASY measurement parameters: Auto Zero Time: 3 sec; Measuring time: 3 sec

	High Range (LSB)	Low Range (LSB)
Channel X	15969	17466
Channel Y	15661	16162
Channel Z	15990	16190

5. Input Offset Measurement

DASY measurement parameters: Auto Zero Time: 3 sec; Measuring time: 3 sec

Input 10M Ω

	Average (μ V)	min. Offset (μ V)	max. Offset (μ V)	Std. Deviation (μ V)
Channel X	0.73	-2.58	3.29	0.62
Channel Y	0.41	-0.49	1.23	0.40
Channel Z	-0.80	-1.88	0.30	0.42

6. Input Offset Current

Nominal Input circuitry offset current on all channels: <25fA

7. Input Resistance (Typical values for information)

	Zeroing (kOhm)	Measuring (MOhm)
Channel X	200	200
Channel Y	200	200
Channel Z	200	200

8. Low Battery Alarm Voltage (Typical values for information)

Typical values	Alarm Level (VDC)
Supply (+ Vcc)	+7.9
Supply (- Vcc)	-7.6

9. Power Consumption (Typical values for information)

Typical values	Switched off (mA)	Stand by (mA)	Transmitting (mA)
Supply (+ Vcc)	+0.01	+6	+14
Supply (- Vcc)	-0.01	-8	-9

**Calibration Laboratory of
Schmid & Partner
Engineering AG**
Zeughausstrasse 43, 8004 Zurich, Switzerland



S Schweizerischer Kalibrierdienst
C Service suisse d'étalonnage
S Servizio svizzero di taratura
S Swiss Calibration Service

Accredited by the Swiss Accreditation Service (SAS)
The Swiss Accreditation Service is one of the signatories to the EA
Multilateral Agreement for the recognition of calibration certificates

Accreditation No.: SCS 0108

Client **Anbotek (Außen)**

Certificate No: **D5GHzV2-1160_Oct11**

CALIBRATION CERTIFICATE

Object: **D5GHzV2 - SN: 1160**

Calibration procedure(s): **QA CAL-22.v2
Calibration procedure for dipole validation kits between 3-6 GHz**

Calibration date: **October 02, 2018**

This calibration certificate documents the traceability to national standards, which realize the physical units of measurements (SI).
The measurements and the uncertainties with confidence probability are given on the following pages and are part of the certificate.

All calibrations have been conducted in the closed laboratory facility; environment temperature (22 ± 3) °C and humidity < 70%.

Calibration Equipment used (MATE critical for calibration)

Primary Standards	ID #	Cal Date (Certificate No.)	Scheduled Calibration
Power meter EPM-442A	GB37480704	07-Oct-17 (No. 217-02020)	Oct-15
Power sensor HP 8481A	US37292783	07-Oct-17 (No. 217-02020)	Oct-15
Power sensor HP 8481A	MY41092317	07-Oct-17 (No. 217-02021)	Oct-15
Reference 20 dB Attenuator	SN: 5058 (20k)	01-Apr-18 (No. 217-02131)	Mar-16
Type-N mismatch combination	SN: 5047.2 / 06327	01-Apr-18 (No. 217-02134)	Mar-16
Reference Probe EX3DV4	SN: 3503	30-Dec-17 (No. EX3-3503, Dec14)	Dec-15
DAE4	SN: 601	17-Aug-18 (No. DAE4-601, Aug15)	Aug-16
Secondary Standards	ID #	Check Date (in house)	Scheduled Check
RF generator R&S SMT-06	100972	18-Jun-15 (in house check Jun-15)	In house check: Jun-18
Network Analyzer HP 8753E	US37390585 S4206	18-Oct-15 (in house check Oct-14)	In house check: Oct-15

Calibrated by:	Leif Klynsner	Function: Laboratory Technician	Signature:
Approved by:	Katja Pokovic	Technical Manager	

issued: October 6, 2018

This calibration certificate shall not be reproduced except in full without written approval of the laboratory.

**Calibration Laboratory of
Schmid & Partner
Engineering AG**
Zeughausstrasse 43, 8004 Zurich, Switzerland



S Schweizerischer Kalibrierdienst
C Service suisse d'étalonnage
S Servizio svizzero di taratura
S Swiss Calibration Service

Accredited by the Swiss Accreditation Service (SAS)
The Swiss Accreditation Service is one of the signatories to the EA
Multilateral Agreement for the recognition of calibration certificates

Accreditation No.: **SCS 0108**

Glossary:

TSL	tissue simulating liquid
ConvF	sensitivity in TSL / NORM x,y,z
N/A	not applicable or not measured

Calibration is Performed According to the Following Standards:

- IEEE Std 1528-2013, "IEEE Recommended Practice for Determining the Peak Spatial-Averaged Specific Absorption Rate (SAR) in the Human Head from Wireless Communications Devices: Measurement Techniques", June 2013
- IEC 62209-2, "Procedure to determine the Specific Absorption Rate (SAR) for wireless communication devices used in close proximity to the human body (frequency range of 30 MHz to 6 GHz)", March 2010
- KDB 865664, "SAR Measurement Requirements for 100 MHz to 6 GHz"

Additional Documentation:

- DASY4/5 System Handbook

Methods Applied and Interpretation of Parameters:

- Measurement Conditions:** Further details are available from the Validation Report at the end of the certificate. All figures stated in the certificate are valid at the frequency indicated.
- Antenna Parameters with TSL:** The dipole is mounted with the spacer to position its feed point exactly below the center marking of the flat phantom section, with the arms oriented parallel to the body axis.
- Feed Point Impedance and Return Loss:** These parameters are measured with the dipole positioned under the liquid filled phantom. The impedance stated is transformed from the measurement at the SMA connector to the feed point. The Return Loss ensures low reflected power. No uncertainty required.
- Electrical Delay:** One-way delay between the SMA connector and the antenna feed point. No uncertainty required.
- SAR measured:** SAR measured at the stated antenna input power.
- SAR normalized:** SAR as measured, normalized to an input power of 1 W at the antenna connector.
- SAR for nominal TSL parameters:** The measured TSL parameters are used to calculate the nominal SAR result.

The reported uncertainty of measurement is stated as the standard uncertainty of measurement multiplied by the coverage factor $k=2$, which for a normal distribution corresponds to a coverage probability of approximately 95%.

Measurement Conditions

DASY system configuration, as far as not given on page 1.

DASY Version	DASY5	V52.8.8
Extrapolation	Advanced Extrapolation	
Phantom	Modular Flat Phantom V5.0	
Distance Dipole Center - TSL	10 mm	with Spacer
Zoom Scan Resolution	dx, dy = 4.0 mm, dz = 1.4 mm	Graded Ratio = 1.4 (Z direction)
Frequency	5200 MHz ± 1 MHz 5300 MHz ± 1 MHz 5800 MHz ± 1 MHz 5800 MHz ± 1 MHz	

Head TSL parameters at 5200 MHz

The following parameters and calculations were applied.

	Temperature	Permittivity	Conductivity
Nominal Head TSL parameters	22.0 °C	36.0	4.66 mho/m
Measured Head TSL parameters	(22.0 ± 0.2) °C	36.4 ± 6 %	4.57 mho/m ± 6 %
Head TSL temperature change during test	< 0.5 °C	---	---

SAR result with Head TSL at 5200 MHz

SAR averaged over 1 cm ³ (1 g) of Head TSL	Condition	
SAR measured	100 mW input power	8.06 W/kg
SAR for nominal Head TSL parameters	normalized to 1W	80.7 W/kg ± 19.9 % (k=2)

SAR averaged over 10 cm ³ (10 g) of Head TSL	condition	
SAR measured	100 mW input power	2.31 W/kg
SAR for nominal Head TSL parameters	normalized to 1W	23.1 W/kg ± 19.5 % (k=2)

Head TSL parameters at 5300 MHz

The following parameters and calculations were applied.

	Temperature	Permittivity	Conductivity
Nominal Head TSL parameters	22.0 °C	35.9	4.76 mho/m
Measured Head TSL parameters	(22.0 ± 0.2) °C	36.2 ± 6 %	4.68 mho/m ± 6 %
Head TSL temperature change during test	< 0.5 °C	—	—

SAR result with Head TSL at 5300 MHz

SAR averaged over 1 cm ³ (1 g) of Head TSL	Condition	
SAR measured	100 mW input power	8.26 W/kg
SAR for nominal Head TSL parameters	normalized to 1W	82.7 W / kg ± 19.9 % (k=2)

SAR averaged over 10 cm ³ (10 g) of Head TSL	condition	
SAR measured	100 mW input power	2.39 W/kg
SAR for nominal Head TSL parameters	normalized to 1W	23.9 W/kg ± 19.5 % (k=2)

Head TSL parameters at 5600 MHz

The following parameters and calculations were applied.

	Temperature	Permittivity	Conductivity
Nominal Head TSL parameters	22.0 °C	35.5	5.07 mho/m
Measured Head TSL parameters	(22.0 ± 0.2) °C	35.7 ± 6 %	5.03 mho/m ± 6 %
Head TSL temperature change during test	< 0.5 °C	—	—

SAR result with Head TSL at 5600 MHz

SAR averaged over 1 cm ³ (1 g) of Head TSL	Condition	
SAR measured	100 mW input power	8.69 W/kg
SAR for nominal Head TSL parameters	normalized to 1W	87.0 W/kg ± 19.9 % (k=2)

SAR averaged over 10 cm ³ (10 g) of Head TSL	condition	
SAR measured	100 mW input power	2.47 W/kg
SAR for nominal Head TSL parameters	normalized to 1W	24.7 W/kg ± 19.5 % (k=2)

Head TSL parameters at 5800 MHz

The following parameters and calculations were applied.

	Temperature	Permittivity	Conductivity
Nominal Head TSL parameters	22.0 °C	35.3	5.27 mho/m
Measured Head TSL parameters	(22.0 ± 0.2) °C	35.3 ± 6 %	5.26 mho/m ± 6 %
Head TSL temperature change during test	< 0.5 °C	—	—

SAR result with Head TSL at 5800 MHz

SAR averaged over 1 cm ³ (1 g) of Head TSL	Condition	
SAR measured	100 mW input power	8.20 W/kg
SAR for nominal Head TSL parameters	normalized to 1W	82.0 W/kg ± 19.9 % (k=2)

SAR averaged over 10 cm ³ (10 g) of Head TSL	condition	
SAR measured	100 mW input power	2.31 W/kg
SAR for nominal Head TSL parameters	normalized to 1W	23.1 W/kg ± 19.5 % (k=2)

Body TSL parameters at 5200 MHz

The following parameters and calculations were applied.

	Temperature	Permittivity	Conductivity
Nominal Body TSL parameters	22.0 °C	49.0	5.30 mho/m.
Measured Body TSL parameters	(22.0 ± 0.2) °C	47.9 ± 6 %	5.35 mho/m ± 6 %
Body TSL temperature change during test	< 0.5 °C	—	—

SAR result with Body TSL at 5200 MHz

SAR averaged over 1 cm ³ (1 g) of Body TSL	Condition	
SAR measured	100 mW input power	7.81 W/kg
SAR for nominal Body TSL parameters	normalized to 1W	77.8 W/kg ± 19.9 % (k=2)

SAR averaged over 10 cm ³ (10 g) of Body TSL	condition	
SAR measured	100 mW input power	2.18 W/kg
SAR for nominal Body TSL parameters	normalized to 1W	21.7 W/kg ± 19.5 % (k=2)

Body TSL parameters at 5300 MHz

The following parameters and calculations were applied.

	Temperature	Permittivity	Conductivity
Nominal Body TSL parameters	22.0 °C	48.9	5.42 mho/m
Measured Body TSL parameters	(22.0 ± 0.2) °C	47.7 ± 6 %	5.49 mho/m ± 6 %
Body TSL temperature change during test	< 0.5 °C	—	—

SAR result with Body TSL at 5300 MHz

SAR averaged over 1 cm ³ (1 g) of Body TSL	Condition	
SAR measured	100 mW input power	7.88 W/kg
SAR for nominal Body TSL parameters	normalized to 1W	78.4 W/kg ± 19.9 % (k=2)

SAR averaged over 10 cm ³ (10 g) of Body TSL	condition	
SAR measured	100 mW input power	2.20 W/kg
SAR for nominal Body TSL parameters	normalized to 1W	21.9 W/kg ± 19.5 % (k=2)

Body TSL parameters at 5600 MHz

The following parameters and calculations were applied.

	Temperature	Permittivity	Conductivity
Nominal Body TSL parameters	22.0 °C	48.5	5.77 mho/m
Measured Body TSL parameters	(22.0 ± 0.2) °C	46.7 ± 6 %	5.99 mho/m ± 6 %
Body TSL temperature change during test	< 0.5 °C	—	—

SAR result with Body TSL at 5600 MHz

SAR averaged over 1 cm ³ (1 g) of Body TSL	Condition	
SAR measured	100 mW input power	8.20 W/kg
SAR for nominal Body TSL parameters	normalized to 1W	81.5 W/kg ± 19.9 % (k=2)

SAR averaged over 10 cm ³ (10 g) of Body TSL	condition	
SAR measured	100 mW input power	2.30 W/kg
SAR for nominal Body TSL parameters	normalized to 1W	22.8 W/kg ± 19.5 % (k=2)

Body TSL parameters at 5800 MHz

The following parameters and calculations were applied.

	Temperature	Permittivity	Conductivity
Nominal Body TSL parameters	22.0 °C	48.2	6.00 mho/m
Measured Body TSL parameters	(22.0 ± 0.2) °C	46.4 ± 6 %	6.27 mho/m ± 6 %
Body TSL temperature change during test	< 0.5 °C	—	—

SAR result with Body TSL at 5800 MHz

SAR averaged over 1 cm ³ (1 g) of Body TSL	Condition	
SAR measured	100 mW input power	7.88 W/kg
SAR for nominal Body TSL parameters	normalized to 1W	78.3 W/kg ± 19.9 % (k=2)

SAR averaged over 10 cm ³ (10 g) of Body TSL	condition	
SAR measured	100 mW input power	2.20 W/kg
SAR for nominal Body TSL parameters	normalized to 1W	21.8 W/kg ± 19.5 % (k=2)

Appendix (Additional assessments outside the scope of SCS 0108)

Antenna Parameters with Head TSL at 5200 MHz

Impedance, transformed to feed point	48.1 Ω - 8.5 j Ω
Return Loss	-21.0 dB

Antenna Parameters with Head TSL at 5300 MHz

Impedance, transformed to feed point	50.2 Ω - 5.2 j Ω
Return Loss	-25.7 dB

Antenna Parameters with Head TSL at 5600 MHz

Impedance, transformed to feed point	54.8 Ω - 2.5 j Ω
Return Loss	-25.7 dB

Antenna Parameters with Head TSL at 5800 MHz

Impedance, transformed to feed point	53.0 Ω - 3.0 j Ω
Return Loss	-27.7 dB



Antenna Parameters with Body TSL at 5200 MHz

Impedance, transformed to feed point	48.6 Ω - 6.8 jΩ
Return Loss	-23.0 dB

Antenna Parameters with Body TSL at 5300 MHz

Impedance, transformed to feed point	49.0 Ω - 4.2 jΩ
Return Loss	-27.1 dB

Antenna Parameters with Body TSL at 5600 MHz

Impedance, transformed to feed point	56.2 Ω - 0.7 jΩ
Return Loss	-24.6 dB

Antenna Parameters with Body TSL at 5800 MHz

Impedance, transformed to feed point	55.9 Ω - 1.7 jΩ
Return Loss	-24.6 dB

General Antenna Parameters and Design

Electrical Delay (one direction)	1.199 ns
----------------------------------	----------

After long term use with 100W radiated power, only a slight warming of the dipole near the feedpoint can be measured.

The dipole is made of standard semirigid coaxial cable. The center conductor of the feeding line is directly connected to the second arm of the dipole. The antenna is therefore short-circuited for DC-signals. On some of the dipoles, small end caps are added to the dipole arms in order to improve matching when loaded according to the position as explained in the "Measurement Conditions" paragraph. The SAR data are not affected by this change. The overall dipole length is still according to the Standard.

No excessive force must be applied to the dipole arms, because they might bend or the soldered connections near the feedpoint may be damaged.

Additional EUT Data

Manufactured by	SPEAG
Manufactured on	June 06, 2013

DASY5 Validation Report for Head TSL

Date: 24.09.2018

Test Laboratory: SPEAG, Zurich, Switzerland

DUT: Dipole 5GHz; Type: D5GHzV2; Serial: D5GHzV2 - SN: 1160

Communication System: UID 0 - CW; Frequency: 5200 MHz, Frequency: 5300 MHz, Frequency: 5600 MHz, Frequency: 5800 MHz

Medium parameters used: $f = 5200$ MHz; $\sigma = 4.57$ S/m; $\epsilon_r = 36.4$; $\rho = 1000$ kg/m³, Medium parameters used: $f = 5300$ MHz; $\sigma = 4.68$ S/m; $\epsilon_r = 36.2$; $\rho = 1000$ kg/m³, Medium parameters used: $f = 5600$ MHz; $\sigma = 5.03$ S/m; $\epsilon_r = 35.7$; $\rho = 1000$ kg/m³, Medium parameters used: $f = 5800$ MHz; $\sigma = 5.26$ S/m; $\epsilon_r = 35.3$; $\rho = 1000$ kg/m³

Phantom section: Flat Section

Measurement Standard: DASY5 (IEEE/IEC/ANSI C63.19-2011)

DASY52 Configuration:

- Probe: EX3DV4 - SN3503; ConvF(5.51, 5.51, 5.51); Calibrated: 30.12.2017, ConvF(5.21, 5.21, 5.21); Calibrated: 30.12.2017, ConvF(4.92, 4.92, 4.92); Calibrated: 30.12.2017, ConvF(4.9, 4.9, 4.9); Calibrated: 30.12.2017,
- Sensor-Surface: 1.4mm (Mechanical Surface Detection)
- Electronics: DAE4 Sn601; Calibrated: 17.08.2018
- Phantom: Flat Phantom 5.0 (front); Type: QD000P50AA; Serial: 1001
- DASY52 52.8.8(1222); SEMCAD X 14.6.10(7331)

Dipole Calibration for Head Tissue/Pin=100mW, dist=10mm, f=5200 MHz/Zoom Scan,**dist=1.4mm (8x8x7)/Cube 0:** Measurement grid: dx=4mm, dy=4mm, dz=1.4mm

Reference Value = 64.41 V/m; Power Drift = 0.08 dB

Peak SAR (extrapolated) = 29.3 W/kg

SAR(1 g) = 8.06 W/kg; SAR(10 g) = 2.31 W/kg

Maximum value of SAR (measured) = 18.7 W/kg

Dipole Calibration for Head Tissue/Pin=100mW, dist=10mm, f=5300 MHz/Zoom Scan,**dist=1.4mm (8x8x7)/Cube 0:** Measurement grid: dx=4mm, dy=4mm, dz=1.4mm

Reference Value = 65.31 V/m; Power Drift = 0.05 dB

Peak SAR (extrapolated) = 31.1 W/kg

SAR(1 g) = 8.26 W/kg; SAR(10 g) = 2.39 W/kg

Maximum value of SAR (measured) = 19.4 W/kg

Dipole Calibration for Head Tissue/Pin=100mW, dist=10mm, f=5600 MHz/Zoom Scan,**dist=1.4mm (8x8x7)/Cube 0:** Measurement grid: dx=4mm, dy=4mm, dz=1.4mm

Reference Value = 65.34 V/m; Power Drift = 0.03 dB

Peak SAR (extrapolated) = 34.7 W/kg

SAR(1 g) = 8.69 W/kg; SAR(10 g) = 2.47 W/kg

Maximum value of SAR (measured) = 21.0 W/kg

Dipole Calibration for Head Tissue/Pin=100mW, dist=10mm, f=5800 MHz/Zoom Scan,
dist=1.4mm (8x8x7)/Cube 0: Measurement grid: dx=4mm, dy=4mm, dz=1.4mm
Reference Value = 62.41 V/m; Power Drift = 0.03 dB
Peak SAR (extrapolated) = 34.5 W/kg
SAR(1 g) = 8.2 W/kg; SAR(10 g) = 2.31 W/kg
Maximum value of SAR (measured) = 20.5 W/kg

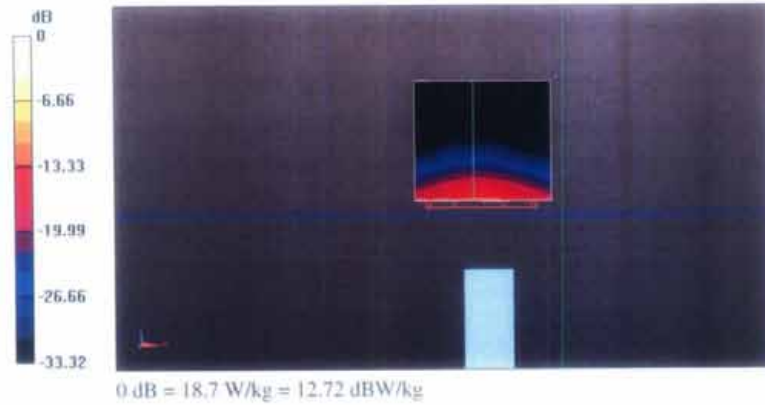

Impedance Measurement Plot for Head TSL

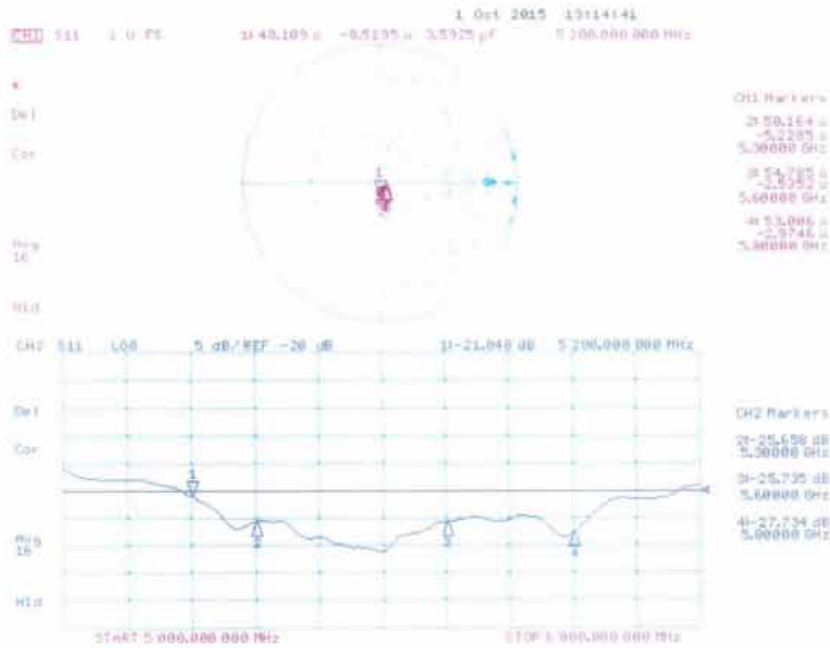

DASY5 Validation Report for Body TSL

Date: 05.10.2018

Test Laboratory: SPEAG, Zurich, Switzerland

DUT: Dipole 5GHz; Type: D5GHzV2; Serial: D5GHzV2 - SN: 1160

Communication System: UID 0 - CW; Frequency: 5200 MHz, Frequency: 5300 MHz, Frequency: 5600 MHz, Frequency: 5800 MHz

Medium parameters used: $f = 5200$ MHz; $\sigma = 5.35$ S/m; $\epsilon_r = 47.9$; $\rho = 1000$ kg/m³. Medium parameters used: $f = 5300$ MHz; $\sigma = 5.49$ S/m; $\epsilon_r = 47.7$; $\rho = 1000$ kg/m³. Medium parameters used: $f = 5600$ MHz; $\sigma = 5.99$ S/m; $\epsilon_r = 46.7$; $\rho = 1000$ kg/m³. Medium parameters used: $f = 5800$ MHz; $\sigma = 6.27$ S/m; $\epsilon_r = 46.4$; $\rho = 1000$ kg/m³

Phantom section: Flat Section

Measurement Standard: DASY5 (IEEE/IEC/ANSI C63.19-2011)

DASY52 Configuration:

- Probe: EX3DV4 - SN3503; ConvF(4.95, 4.95, 4.95); Calibrated: 30.12.2017, ConvF(4.78, 4.78, 4.78); Calibrated: 30.12.2017; ConvF(4.35, 4.35, 4.35); Calibrated: 30.12.2017, ConvF(4.32, 4.32, 4.32); Calibrated: 30.12.2017;
- Sensor-Surface: 1.4mm (Mechanical Surface Detection)
- Electronics: DAE4 Sn601; Calibrated: 17.08.2018
- Phantom: Flat Phantom 5.0 (back); Type: QD000P50AA; Serial: 1002
- DASY52 52.8.8(1222); SEMCAD X 14.6.10(7331)

Dipole Calibration for Body Tissue/Pin=100mW, dist=10mm, f=5200 MHz/Zoom Scan, dist=1.4mm (8x8x7)/Cube 0:

Measurement grid: dx=4mm, dy=4mm, dz=1.4mm

Reference Value = 67.32 V/m; Power Drift = -0.04 dB

Peak SAR (extrapolated) = 30.4 W/kg

SAR(1 g) = 7.81 W/kg; SAR(10 g) = 2.18 W/kg

Maximum value of SAR (measured) = 18.2 W/kg

Dipole Calibration for Body Tissue/Pin=100mW, dist=10mm, f=5300 MHz/Zoom Scan, dist=1.4mm (8x8x7)/Cube 0:

Measurement grid: dx=4mm, dy=4mm, dz=1.4mm

Reference Value = 67.22 V/m; Power Drift = -0.06 dB

Peak SAR (extrapolated) = 31.6 W/kg

SAR(1 g) = 7.88 W/kg; SAR(10 g) = 2.2 W/kg

Maximum value of SAR (measured) = 18.8 W/kg

Dipole Calibration for Body Tissue/Pin=100mW, dist=10mm, f=5600 MHz/Zoom Scan, dist=1.4mm (8x8x7)/Cube 0:

Measurement grid: dx=4mm, dy=4mm, dz=1.4mm

Reference Value = 67.36 V/m; Power Drift = -0.03 dB

Peak SAR (extrapolated) = 36.6 W/kg

SAR(1 g) = 8.2 W/kg; SAR(10 g) = 2.3 W/kg

Maximum value of SAR (measured) = 20.2 W/kg

Dipole Calibration for Body Tissue/Pin=100mW, dist=10mm, f=5800 MHz/Zoom Scan,
dist=1.4mm (8x8x7)/Cube 0: Measurement grid: dx=4mm, dy=4mm, dz=1.4mm
Reference Value = 65.22 V/m; Power Drift = -0.03 dB
Peak SAR (extrapolated) = 37.1 W/kg
SAR(1 g) = 7.88 W/kg; SAR(10 g) = 2.2 W/kg
Maximum value of SAR (measured) = 19.7 W/kg

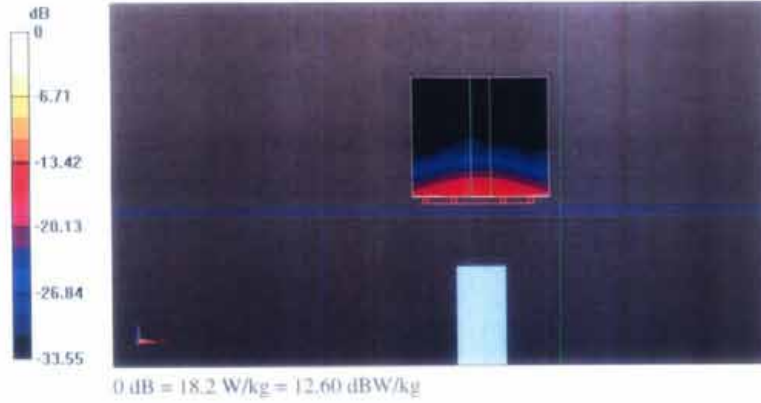

Impedance Measurement Plot for Body TSL

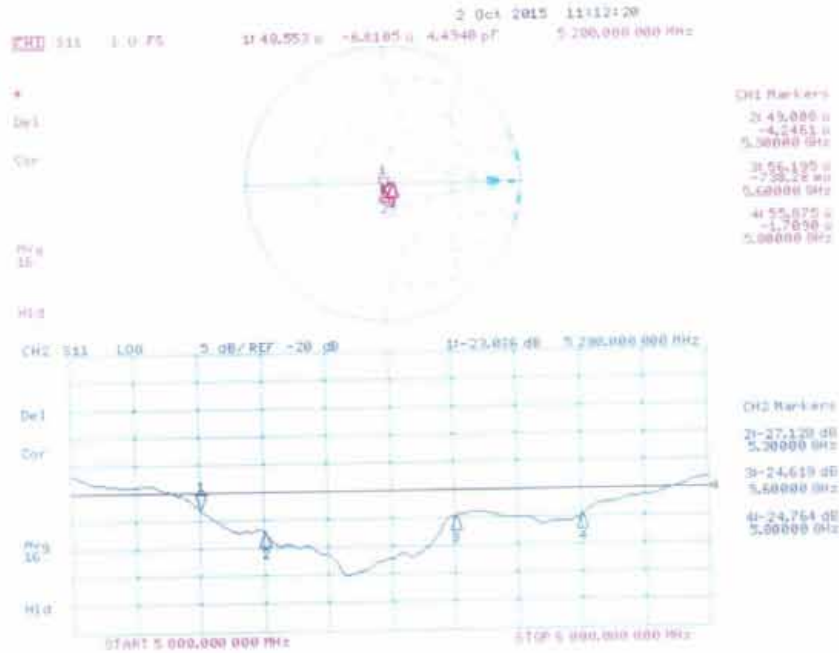



In Collaboration with
s p e a g
CALIBRATION LABORATORY



中国认可
国际互认
校准
CALIBRATION
CNAS L0570

Add: No.51 Xueyuan Road, Haidian District, Beijing, 100191, China
Tel: +86-10-62304633-2079 Fax: +86-10-62304633-2504
E-mail: cttl@chinattl.com [Http://www.chinattl.cn](http://www.chinattl.cn)

Client

Anbotek (Auden)

Certificate No: Z18-97091

CALIBRATION CERTIFICATE

Object: D2450V2 - SN: 910

Calibration Procedure(s):
FD-Z11-2-003-01
Calibration Procedures for dipole validation kits

Calibration date: Jun 15, 2018

This calibration Certificate documents the traceability to national standards, which realize the physical units of measurements(SI). The measurements and the uncertainties with confidence probability are given on the following pages and are part of the certificate.

All calibrations have been conducted in the closed laboratory facility: environment temperature(22±3)°C and humidity<70%.

Calibration Equipment used (M&TE critical for calibration)

Primary Standards	ID #	Cal Date(Calibrated by, Certificate No.)	Scheduled Calibration
Power Meter NRP2	101919	01-Jul-17 (CTTL, No.J17X04256)	Jun-18
Power sensor NRP-Z91	101547	01-Jul-17 (CTTL, No.J17X04256)	Jun-18
Reference Probe EX3DV4	SN 7307	19-Feb-18(SPEAG,No.EX3-7307_Feb18)	Feb-19
DAE4	SN 771	02-Feb-18(CTTL-SPEAG,No.Z18-97011)	Feb-19
Secondary Standards	ID #	Cal Date(Calibrated by, Certificate No.)	Scheduled Calibration
Signal Generator E4438C	MY49071430	01-Feb-18 (CTTL, No.J18X00893)	Jan-19
Network Analyzer E5071C	MY46110673	26-Jan-18 (CTTL, No.J18X00894)	Jan-19

	Name	Function	Signature
Calibrated by:	Zhao Jing	SAR Test Engineer	
Reviewed by:	Qi Dianyuan	SAR Project Leader	
Approved by:	Lu Bingsong	Deputy Director of the laboratory	

Issued: Jun 17, 2018

This calibration certificate shall not be reproduced except in full without written approval of the laboratory.





In Collaboration with

s p e a g**CALIBRATION LABORATORY**

Add: No.51 Xueyuan Road, Haidian District, Beijing, 100191, China

Tel: +86-10-62304633-2079

Fax: +86-10-62304633-2504

E-mail: ettl@chinattl.com

Http://www.chinattl.cn

Glossary:

TSL	tissue simulating liquid
ConvF	sensitivity in TSL / NORM _{x,y,z}
N/A	not applicable or not measured

Calibration is Performed According to the Following Standards:

- IEEE Std 1528-2013, "IEEE Recommended Practice for Determining the Peak Spatial-Averaged Specific Absorption Rate (SAR) in the Human Head from Wireless Communications Devices: Measurement Techniques", June 2013
- IEC 62209-1, "Procedure to measure the Specific Absorption Rate (SAR) For hand-held devices used in close proximity to the ear (frequency range of 300MHz to 3GHz)", February 2005
- IEC 62209-2, "Procedure to measure the Specific Absorption Rate (SAR) For wireless communication devices used in close proximity to the human body (frequency range of 30MHz to 6GHz)", March 2010
- KDB865664, SAR Measurement Requirements for 100 MHz to 6 GHz

Additional Documentation:

- DASY4/5 System Handbook

Methods Applied and Interpretation of Parameters:

- Measurement Conditions:** Further details are available from the Validation Report at the end of the certificate. All figures stated in the certificate are valid at the frequency indicated.
- Antenna Parameters with TSL:** The dipole is mounted with the spacer to position its feed point exactly below the center marking of the flat phantom section, with the arms oriented parallel to the body axis.
- Feed Point Impedance and Return Loss:** These parameters are measured with the dipole positioned under the liquid filled phantom. The impedance stated is transformed from the measurement at the SMA connector to the feed point. The Return Loss ensures low reflected power. No uncertainty required.
- Electrical Delay:** One-way delay between the SMA connector and the antenna feed point. No uncertainty required.
- SAR measured:** SAR measured at the stated antenna input power.
- SAR normalized:** SAR as measured, normalized to an input power of 1 W at the antenna connector.
- SAR for nominal TSL parameters:** The measured TSL parameters are used to calculate the nominal SAR result.

The reported uncertainty of measurement is stated as the standard uncertainty of Measurement multiplied by the coverage factor $k=2$, which for a normal distribution Corresponds to a coverage probability of approximately 95%.





In Collaboration with

s p e a g
CALIBRATION LABORATORY

Add: No.51 Xueyuan Road, Haidian District, Beijing, 100191, China

Tel: +86-10-62304633-2079

Fax: +86-10-62304633-2504

E-mail: cttl@chinattl.com

Http://www.chinattl.cn

Measurement Conditions

DASY system configuration, as far as not given on page 1.

DASY Version	DASY52	52.8.8.1258
Extrapolation	Advanced Extrapolation	
Phantom	Triple Flat Phantom 5.1C	
Distance Dipole Center - TSL	10 mm	with Spacer
Zoom Scan Resolution	dx, dy, dz = 5 mm	
Frequency	2450 MHz ± 1 MHz	

Head TSL parameters

The following parameters and calculations were applied.

	Temperature	Permittivity	Conductivity
Nominal Head TSL parameters	22.0 °C	39.2	1.80 mho/m
Measured Head TSL parameters	(22.0 ± 0.2) °C	39.0 ± 6 %	1.77 mho/m ± 6 %
Head TSL temperature change during test	<1.0 °C	----	----

SAR result with Head TSL

SAR averaged over 1 cm ³ (1 g) of Head TSL	Condition	
SAR measured	250 mW input power	13.0 mW / g
SAR for nominal Head TSL parameters	normalized to 1W	52.4 mW / g ± 20.8 % (k=2)
SAR averaged over 10 cm ³ (10 g) of Head TSL	Condition	
SAR measured	250 mW input power	6.06 mW / g
SAR for nominal Head TSL parameters	normalized to 1W	24.3 mW / g ± 20.4 % (k=2)

Body TSL parameters

The following parameters and calculations were applied.

	Temperature	Permittivity	Conductivity
Nominal Body TSL parameters	22.0 °C	52.7	1.95 mho/m
Measured Body TSL parameters	(22.0 ± 0.2) °C	52.9 ± 6 %	1.97 mho/m ± 6 %
Body TSL temperature change during test	<1.0 °C	----	----

SAR result with Body TSL

SAR averaged over 1 cm ³ (1 g) of Body TSL	Condition	
SAR measured	250 mW input power	13.0 mW / g
SAR for nominal Body TSL parameters	normalized to 1W	51.8 mW / g ± 20.8 % (k=2)
SAR averaged over 10 cm ³ (10 g) of Body TSL	Condition	
SAR measured	250 mW input power	6.18 mW / g
SAR for nominal Body TSL parameters	normalized to 1W	24.7 mW / g ± 20.4 % (k=2)





In Collaboration with
s p e a g
CALIBRATION LABORATORY

Add: No.51 Xueyuan Road, Haidian District, Beijing, 100191, China
Tel: +86-10-62304633-2079 Fax: +86-10-62304633-2504
E-mail: cttl@chinattl.com Http://www.chinattl.cn

Appendix

Antenna Parameters with Head TSL

Impedance, transformed to feed point	54.6Ω+ 2.77jΩ
Return Loss	- 25.8dB

Antenna Parameters with Body TSL

Impedance, transformed to feed point	50.7Ω+ 4.28jΩ
Return Loss	- 27.3dB

General Antenna Parameters and Design

Electrical Delay (one direction)	1.263 ns
----------------------------------	----------

After long term use with 100W radiated power, only a slight warming of the dipole near the feedpoint can be measured.

The dipole is made of standard semirigid coaxial cable. The center conductor of the feeding line is directly connected to the second arm of the dipole. The antenna is therefore short-circuited for DC-signals. On some of the dipoles, small end caps are added to the dipole arms in order to improve matching when loaded according to the position as explained in the "Measurement Conditions" paragraph. The SAR data are not affected by this change. The overall dipole length is still according to the Standard. No excessive force must be applied to the dipole arms, because they might bend or the soldered connections near the feedpoint may be damaged.

Additional EUT Data

Manufactured by	SPEAG
-----------------	-------



In Collaboration with
s p e a g
CALIBRATION LABORATORY

Add: No.51 Xueyuan Road, Haidian District, Beijing, 100191, China
Tel: +86-10-62304633-2079 Fax: +86-10-62304633-2504
E-mail: cttl@chinattl.com Http://www.chinattl.cn

DASY5 Validation Report for Head TSL

Date: 06.15.2018

Test Laboratory: CTTL, Beijing, China

DUT: Dipole 2450 MHz; Type: D2450V2; Serial: D2450V2 - SN: 910

Communication System: UID 0, CW; Frequency: 2450 MHz; Duty Cycle: 1:1

Medium parameters used: $f = 2450$ MHz; $\sigma = 1.767$ S/m; $\epsilon_r = 39.01$; $\rho = 1000$ kg/m³

Phantom section: Right Section

Measurement Standard: DASY5 (IEEE/IEC/ANSI C63.19-2007)

DASY5 Configuration:

- Probe: EX3DV4 - SN7307; ConvF(7.36, 7.36, 7.36); Calibrated: 2/19/2018;
- Sensor-Surface: 2mm (Mechanical Surface Detection)
- Electronics: DAE4 Sn771; Calibrated: 2018-02-02
- Phantom: Triple Flat Phantom 5.1C; Type: QD 000 P51 CA; Serial: 1161/1
- Measurement SW: DASY52, Version 52.8 (8); SEMCAD X Version 14.6.10 (7372)

Dipole Calibration/Zoom Scan (7x7x7) (7x7x7)/Cube 0: Measurement grid: dx=5mm, dy=5mm, dz=5mm

Reference Value = 106.5 V/m; Power Drift = 0.02 dB

Peak SAR (extrapolated) = 26.7 W/kg

SAR(1 g) = 13 W/kg; SAR(10 g) = 6.06 W/kg

Maximum value of SAR (measured) = 19.7 W/kg

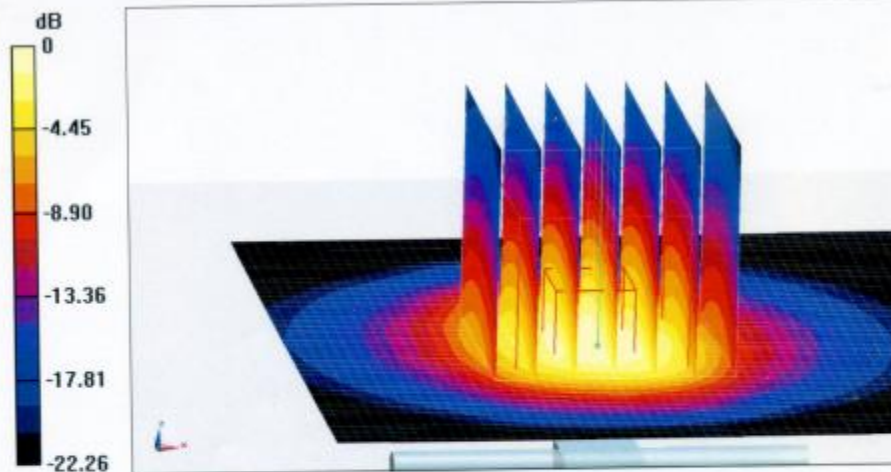
**0 dB = 19.7 W/kg = 12.94 dBW/kg**



In Collaboration with
s p e a g
CALIBRATION LABORATORY

Add: No.51 Xueyuan Road, Haidian District, Beijing, 100191, China
Tel: +86-10-62304633-2079 Fax: +86-10-62304633-2504
E-mail: cttl@chinattl.com Http://www.chinattl.cn

Impedance Measurement Plot for Head TSL

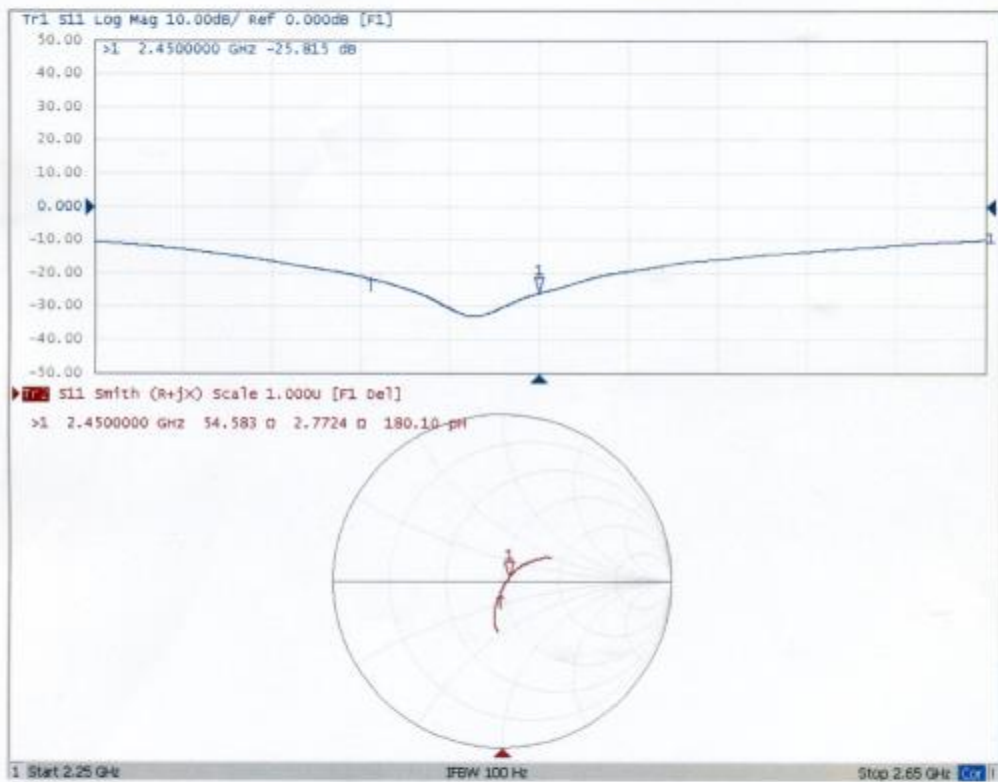



In Collaboration with
s p e a g
CALIBRATION LABORATORY

Add: No.51 Xueyuan Road, Haidian District, Beijing, 100191, China
Tel: +86-10-62304633-2079 Fax: +86-10-62304633-2504
E-mail: cttl@chinattl.com Http://www.chinattl.cn

DASY5 Validation Report for Body TSL

Date: 06.15.2018

Test Laboratory: CTTL, Beijing, China

DUT: Dipole 2450 MHz; Type: D2450V2; Serial: D2450V2 - SN: 910

Communication System: UID 0, CW; Frequency: 2450 MHz; Duty Cycle: 1:1

Medium parameters used: $f = 2450$ MHz; $\sigma = 1.972$ S/m; $\epsilon_r = 52.92$; $\rho = 1000$ kg/m³

Phantom section: Center Section

Measurement Standard: DASY5 (IEEE/IEC/ANSI C63.19-2007)

DASY5 Configuration:

- Probe: EX3DV4 - SN7307; ConvF(7.22, 7.22, 7.22); Calibrated: 2/19/2018;
- Sensor-Surface: 2mm (Mechanical Surface Detection)
- Electronics: DAE4 Sn771; Calibrated: 2018-02-02
- Phantom: Triple Flat Phantom 5.1C; Type: QD 000 P51 CA; Serial: 1161/1
- Measurement SW: DASY52, Version 52.8 (8); SEMCAD X Version 14.6.10 (7372)

Dipole Calibration/Zoom Scan (7x7x7) (7x7x7)/Cube 0: Measurement grid: dx=5mm, dy=5mm, dz=5mm

Reference Value = 98.89 V/m; Power Drift = 0.03 dB

Peak SAR (extrapolated) = 25.6 W/kg

SAR(1 g) = 13 W/kg; SAR(10 g) = 6.18 W/kg

Maximum value of SAR (measured) = 19.3 W/kg

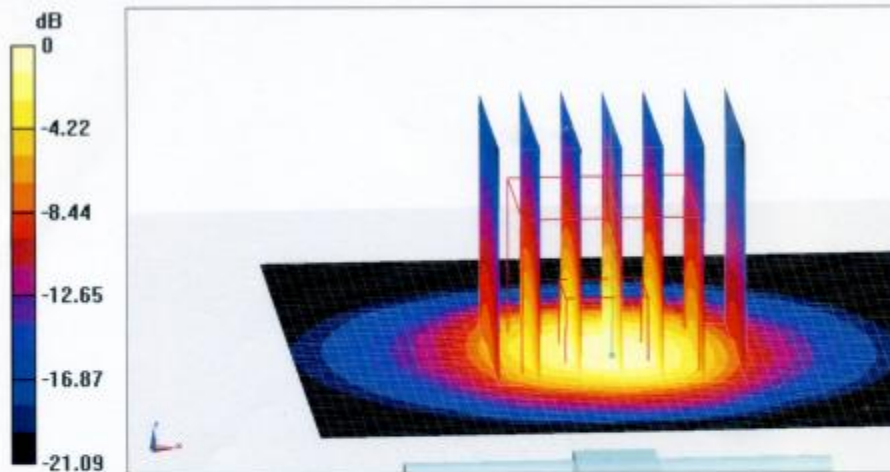

0 dB = 19.3 W/kg = 12.86 dBW/kg





In Collaboration with
s p e a g
CALIBRATION LABORATORY

Add: No.51 Xueyuan Road, Haidian District, Beijing, 100191, China
Tel: +86-10-62304633-2079 Fax: +86-10-62304633-2504
E-mail: cntl@chinattl.com Http://www.chinattl.cn

Impedance Measurement Plot for Body TSL

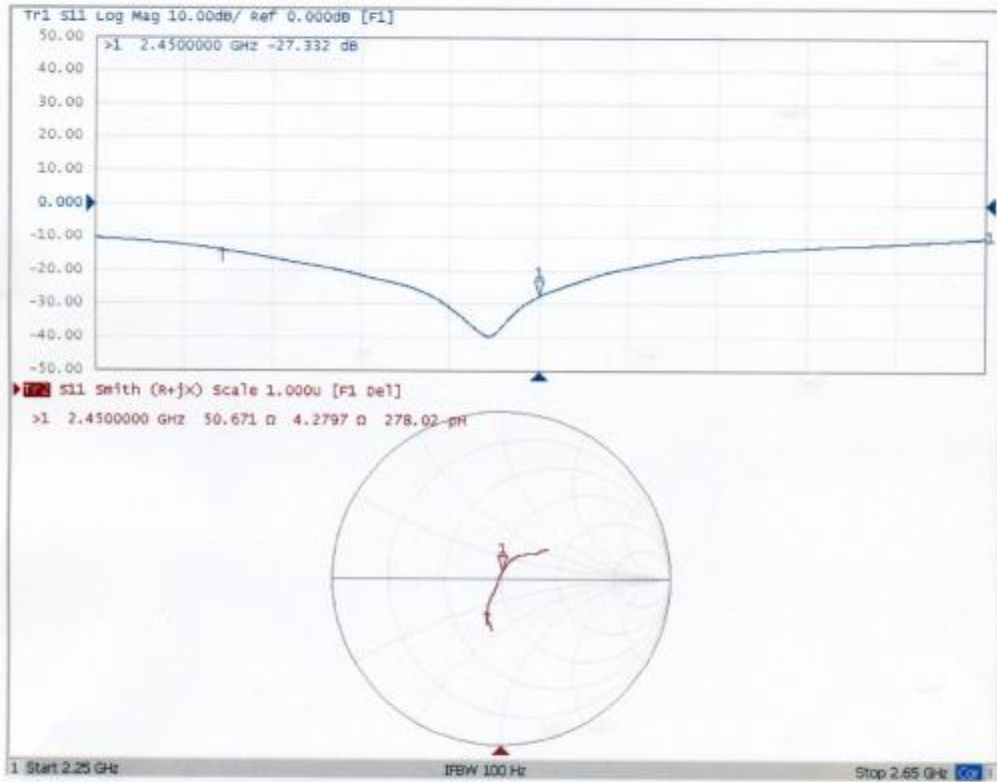

Extended Calibration SAR Dipole

Referring to KDB865664 D01, if dipoles are verified in return loss (<-20dBm, within 20% of prior calibration), and in impedance (within 5 ohm of prior calibration), the annual calibration is not necessary and the calibration interval can be extended.

Justification of Extended Calibration SAR Dipole D2450V2– serial no.910

Body						
Date of Measurement	Return-Loss (dB)	Delta (%)	Real Impedance (ohm)	Delta (ohm)	Imaginary Impedance (johm)	Delta (johm)
2018-06-15	-27.3	/	50.7	/	4.28	/
2019-06-20	-26.2	-4.03%	51.5	0.8	3.93	0.35

Justification of Extended Calibration SAR Dipole D5GHzV2– serial no. 1160

5.2G Body						
Date of Measurement	Return-Loss (dB)	Delta (%)	Real Impedance (ohm)	Delta (ohm)	Imaginary Impedance (johm)	Delta (johm)
2018-10-02	-23.0	/	48.6	/	-6.8	/
2019-09-29	-22.7	-1.3%	49.1	0.5	-7.2	0.4

Justification of Extended Calibration SAR Dipole D5GHzV2– serial no. 1160

5.8G Body						
Date of Measurement	Return-Loss (dB)	Delta (%)	Real Impedance (ohm)	Delta (ohm)	Imaginary Impedance (johm)	Delta (johm)
2018-10-02	-24.8	/	55.9	/	-1.7	/
2019-09-29	-23.6	-4.8%	57.3	1.4	-1.2	0.4

The Return-Loss is <-20dB, and within 20% of prior calibration; the impedance is within 5 ohm of prior calibration. Therefore the value result should support extended.

*******END OF REPORT*******