



Shenzhen Global Test Service Co.,Ltd.

1F, Building No. 13A, Zhonghaixin Science and Technology City, No.12,6 Road, Ganli Industrial Park, Buji Street, Longgang District, Shenzhen, Guangdong

FCC PART 15 SUBPART C TEST REPORT

FCC PART 15.247

Report Reference No......: **GTS20190329001-1-26**

FCC ID..... : **2AQAA-EZBOXI3**

Compiled by

(position+printed name+signature)..: File administrators Jimmy Wang

Supervised by

(position+printed name+signature)..: Test Engineer Aaron Tan



Approved by

(position+printed name+signature)..: Manager Jason Hu

Date of issue.....: May. 30, 2019

Representative Laboratory Name .: **Shenzhen Global Test Service Co.,Ltd.**

Address.....: 1F, Building No. 13A, Zhonghaixin Science and Technology City, No.12,6 Road, Ganli Industrial Park, Buji Street, Longgang District, Shenzhen, Guangdong

Applicant's name.....: **SHENZHEN JUMPER TECHNOLOGY CO.,LTD**

Address: 101,102,201,301 No.13-2 Pingxi South Rd.,Pingxi Community,Pingdi Street,Longgang District,Shenzhen,GuangDong

Test specification

Standard: **FCC Part 15.247: Operation within the bands 902-928 MHz, 2400-2483.5 MHz and 5725-5850 MHz**

TRF Originator.....: Shenzhen Global Test Service Co.,Ltd.

Master TRF.....: Dated 2014-12

Shenzhen Global Test Service Co.,Ltd. All rights reserved.

This publication may be reproduced in whole or in part for non-commercial purposes as long as the Shenzhen Global Test Service Co.,Ltd. is acknowledged as copyright owner and source of the material. Shenzhen Global Test Service Co.,Ltd. takes no responsibility for and will not assume liability for damages resulting from the reader's interpretation of the reproduced material due to its placement and context.

Test item description

Trade Mark: N/A

Manufacturer: **SHENZHEN JUMPER TECHNOLOGY CO.,LTD**

Model/Type reference.....: EZbox i3

Listed Models: N/A

Operation Frequency.....: From 2412MHz to 2462MHz

Rating: DC 12V from adapter

Result.....: **PASS**

TEST REPORT

Test Report No. :	GTS20190329001-1-26	May. 30, 2019
		Date of issue

Equipment under Test : MINI PC

Model /Type : EZbox i3

Listed Models : N/A

Applicant : **SHENZHEN JUMPER TECHNOLOGY CO.,LTD**

Address : 101,102,201,301 No.13-2 Pingxi South Rd.,Pingxi Community,Pingdi Street,Longgang District,Shenzhen,GuangDong

Manufacturer : **SHENZHEN JUMPER TECHNOLOGY CO.,LTD**

Address : 101,102,201,301 No.13-2 Pingxi South Rd.,Pingxi Community,Pingdi Street,Longgang District,Shenzhen,GuangDong

Test Result:	PASS
---------------------	-------------

The test report merely corresponds to the test sample.
It is not permitted to copy extracts of these test result without the written permission of the test laboratory.

Contents

<u>1.</u>	<u>TEST STANDARDS</u>	<u>4</u>
<u>2.</u>	<u>SUMMARY</u>	<u>5</u>
2.1.	General Remarks	5
2.2.	Product Description	5
2.3.	Equipment Under Test	6
2.4.	Short description of the Equipment under Test (EUT)	6
2.5.	EUT operation mode	6
2.6.	Block Diagram of Test Setup	6
2.7.	Related Submittal(s) / Grant (s)	7
2.8.	Special Accessories	7
2.9.	Modifications	7
<u>3.</u>	<u>TEST ENVIRONMENT</u>	<u>8</u>
3.1.	Address of the test laboratory	8
3.2.	Test Facility	8
3.3.	Environmental conditions	8
3.4.	Test Description	9
3.5.	Statement of the measurement uncertainty	10
3.6.	Equipments Used during the Test	11
<u>4.</u>	<u>TEST CONDITIONS AND RESULTS</u>	<u>12</u>
4.1.	AC Power Conducted Emission	12
4.2.	Radiated Emission.....	15
4.3.	Maximum Peak Output Power.....	20
4.4.	Power Spectral Density	24
4.5.	6dB Bandwidth	29
4.6.	Band Edge Compliance of RF Emission	34
4.7.	Antenna Requirement.....	41
<u>5.</u>	<u>TEST SETUP PHOTOS OF THE EUT</u>	<u>42</u>
<u>6.</u>	<u>EXTERNAL AND INTERNAL PHOTOS OF THE EUT</u>	<u>43</u>

1. TEST STANDARDS

The tests were performed according to following standards:

[FCC Rules Part 15.247](#): Frequency Hopping, Direct Spread Spectrum and Hybrid Systems that are in operation within the bands of 902-928 MHz, 2400-2483.5 MHz, and 5725-5850 MHz.

[ANSI C63.10-2013](#): American National Standard for Testing Unlicensed Wireless Devices

[KDB558074 D01 v05r02](#): Guidance for Compliance Measurements on Digital Transmission Systems (DTS) ,Frequency Hopping Spread Spectrum System(HFSS), and Hybrid System Devices Operating Under §15.247 of The FCC rules.

2. SUMMARY

2.1. General Remarks

Date of receipt of test sample	:	May. 10, 2019
Testing commenced on	:	May. 29, 2019
Testing concluded on	:	May. 30, 2019

2.2. Product Description

Product Name:	MINI PC
Trade Mark:	/
Model/Type reference:	EZbox i3
Antenna Type	FPC
Power supply:	DC 12V from adapter
Adapter information:	Model: JHD-AP036E-120300AA-A Input: AC 100-240V~50/60Hz 1.2A Output:DC 12V/3A
WIFI	
WLAN	Supported 802.11 a/b/g/n/ac
Modulation Type	IEEE 802.11a: OFDM(64QAM, 16QAM, QPSK, BPSK) IEEE 802.11b: DSSS(CCK,DQPSK,DBPSK) IEEE 802.11g: OFDM(64QAM, 16QAM, QPSK, BPSK) IEEE 802.11n HT20: OFDM (64QAM, 16QAM, QPSK,BPSK) IEEE 802.11n HT40: OFDM (64QAM, 16QAM, QPSK,BPSK) IEEE 802.11ac20/40/80: OFDM(64QAM, 16QAM, QPSK, BPSK)
Operation frequency	IEEE 802.11a:5180-5240MHz,5745-5825MHz IEEE 802.11b:2412-2462MHz IEEE 802.11g:2412-2462MHz IEEE 802.11n HT20:2412-2462MHz, 5180-5240MHz,5745-5825MHz IEEE 802.11n HT40:2422-2452MHz, 5190-5230MHz,5755-5795MHz IEEE 802.11ac:5180-5240MHz,5745-5825MHz IEEE 802.11ac40:5190-5230MHz,5755-5795MHz IEEE 802.11ac:5210MHz,5775MHz
Antenna gain	Antenna 0:1.11dBi for 2.4G WiFi/0.78dBi for 5G WiFi; Antenna 1:1.11dBi for 2.4G WiFi/0.78dBi for 5G WiFi;
BT/EDR	
Modulation Type	GFSK,8DPSK, $\pi/4$ -DQPSK
Operation frequency	2402-2480MHz
Antenna gain	1.11dBi Max
BLE	
Modulation Type	GFSK
Operation frequency	2402-2480MHz
Antenna gain	1.11dBi Max

2.3. Equipment Under Test

Power supply system utilised

Power supply voltage	:	<input type="radio"/> 230V / 50 Hz	<input type="radio"/> 120V / 60Hz
		<input type="radio"/> 12 V DC	<input type="radio"/> 24 V DC
		<input checked="" type="radio"/> Other (specified in blank below)	

DC 12V From Adapter AC 120V/60Hz

2.4. Short description of the Equipment under Test (EUT)

This is a MINI PC.

For more details, refer to the user’s manual of the EUT.

2.5. EUT operation mode

The application provider specific test software to control sample in continuous TX and RX (Duty Cycle >98%) for testing meet KDB558074 test requirement.

NOTE:

Equipment with 2 diversity antennas operating in switched diversity mode by which at any moment in time only 1 antenna is used.

IEEE 802.11b/g/n: Thirteen channels are provided to the EUT.

Channel	Frequency(MHz)	Channel	Frequency(MHz)
1	2412	8	2447
2	2417	9	2452
3	2422	10	2457
4	2427	11	2462
5	2432		
6	2437		
7	2442		

2.6. Block Diagram of Test Setup

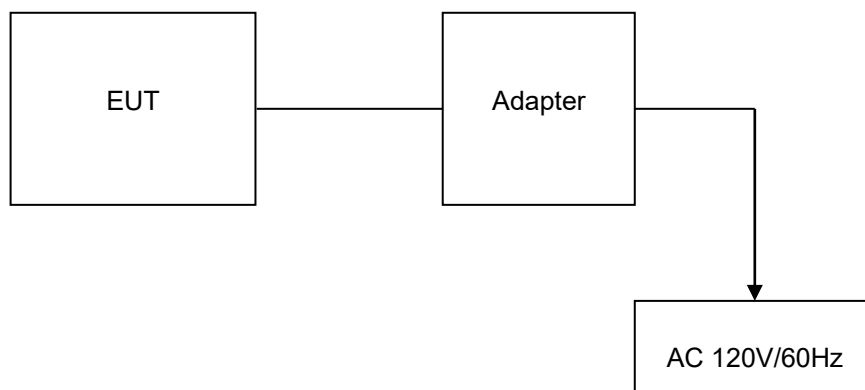

2.7. Related Submittal(s) / Grant (s)

This submittal(s) (test report) is intended for **FCC ID: 2AQAA-EZBOXI3** filing to comply with Section 15.247 of the FCC Part 15, Subpart C Rules.

2.8. Special Accessories

Manufacturer	Description	Model	Serial Number	Certificate
AOC	HDMI display	Satellite S40Dt-A	D26T	DOC

2.9. Modifications

No modifications were implemented to meet testing criteria.

3. TEST ENVIRONMENT

3.1. Address of the test laboratory

Shenzhen Global Test Service Co.,Ltd.

1F, Building No. 13A, Zhonghaixin Science and Technology City, No.12,6 Road, Ganli Industrial Park, Buji Street, Longgang District, Shenzhen, Guangdong

3.2. Test Facility

The test facility is recognized, certified, or accredited by the following organizations:

CNAS (No. CNAS L8169)

Shenzhen Global Test Service Co., Ltd. has been assessed and proved to be in compliance with CNAS-CL01 Accreditation Criteria for Testing and Calibration Laboratories (identical to ISO/IEC 17025: 2017 General Requirements) for the Competence of Testing and Calibration Laboratories.

A2LA (Certificate No. 4758.01)

Shenzhen Global Test Service Co., Ltd. has been assessed by the American Association for Laboratory Accreditation (A2LA). Certificate No. 4758.01.

3.3. Environmental conditions

During the measurement the environmental conditions were within the listed ranges:

Temperature:	15-35 ° C
Humidity:	30-60 %
Atmospheric pressure:	950-1050mbar

3.4. Test Description

Test Specification clause	Test case	Test Mode	Test Channel	Recorded In Report		Pass	Fail	NA	NP	Remark
§15.247(b)(4)	Antenna gain	802.11b	<input checked="" type="checkbox"/> Lowest <input checked="" type="checkbox"/> Middle <input checked="" type="checkbox"/> Highest	802.11b	<input checked="" type="checkbox"/> Lowest <input checked="" type="checkbox"/> Middle <input checked="" type="checkbox"/> Highest	<input checked="" type="checkbox"/>	<input type="checkbox"/>	<input type="checkbox"/>	<input type="checkbox"/>	complies
§15.247(e)	Power spectral density	802.11b 802.11g 802.11n HT20 802.11n HT40	<input checked="" type="checkbox"/> Lowest <input checked="" type="checkbox"/> Middle <input checked="" type="checkbox"/> Highest	802.11b 802.11g 802.11n HT20 802.11n HT40	<input checked="" type="checkbox"/> Lowest <input checked="" type="checkbox"/> Middle <input checked="" type="checkbox"/> Highest	<input checked="" type="checkbox"/>	<input type="checkbox"/>	<input type="checkbox"/>	<input type="checkbox"/>	complies
§15.247(a)(2)	Spectrum bandwidth – 6 dB bandwidth	802.11b 802.11g 802.11n HT20 802.11n HT40	<input checked="" type="checkbox"/> Lowest <input checked="" type="checkbox"/> Middle <input checked="" type="checkbox"/> Highest	802.11b 802.11g 802.11n HT20 802.11n HT40	<input checked="" type="checkbox"/> Lowest <input checked="" type="checkbox"/> Middle <input checked="" type="checkbox"/> Highest	<input checked="" type="checkbox"/> <input checked="" type="checkbox"/>	<input type="checkbox"/>	<input type="checkbox"/>	<input type="checkbox"/>	complies
§15.247(b)(1)	Maximum output power	802.11b 802.11g 802.11n HT20 802.11n HT40	<input checked="" type="checkbox"/> Lowest <input checked="" type="checkbox"/> Middle <input checked="" type="checkbox"/> Highest	802.11b 802.11g 802.11n HT20 802.11n HT40	<input checked="" type="checkbox"/> Lowest <input checked="" type="checkbox"/> Middle <input checked="" type="checkbox"/> Highest	<input checked="" type="checkbox"/> <input checked="" type="checkbox"/> <input checked="" type="checkbox"/>	<input type="checkbox"/>	<input type="checkbox"/>	<input type="checkbox"/>	complies
§15.247(d)	Band edge compliance conducted	802.11b 802.11g 802.11n HT20 802.11n HT40	<input checked="" type="checkbox"/> Lowest <input checked="" type="checkbox"/> Highest	802.11b 802.11g 802.11n HT20 802.11n HT40	<input checked="" type="checkbox"/> Lowest <input checked="" type="checkbox"/> Highest	<input checked="" type="checkbox"/> <input checked="" type="checkbox"/>	<input type="checkbox"/>	<input type="checkbox"/>	<input type="checkbox"/>	complies
§15.205	Band edge compliance radiated	802.11b 802.11g 802.11n HT20 802.11n HT40	<input checked="" type="checkbox"/> Lowest <input checked="" type="checkbox"/> Highest	802.11b 802.11g 802.11n HT20 802.11n HT40	<input checked="" type="checkbox"/> Lowest <input checked="" type="checkbox"/> Highest	<input checked="" type="checkbox"/>	<input type="checkbox"/>	<input type="checkbox"/>	<input type="checkbox"/>	complies
§15.247(d)	TX spurious emissions conducted	802.11b 802.11g 802.11n HT20 802.11n HT40	<input checked="" type="checkbox"/> Lowest <input checked="" type="checkbox"/> Middle <input checked="" type="checkbox"/> Highest	802.11b 802.11g 802.11n HT20 802.11n HT40	<input checked="" type="checkbox"/> Lowest <input checked="" type="checkbox"/> Middle <input checked="" type="checkbox"/> Highest	<input checked="" type="checkbox"/> <input checked="" type="checkbox"/>	<input type="checkbox"/>	<input type="checkbox"/>	<input type="checkbox"/>	complies
§15.247(d)	TX spurious emissions radiated	802.11b 802.11g 802.11n HT20 802.11n HT40	<input checked="" type="checkbox"/> Lowest <input checked="" type="checkbox"/> Middle <input checked="" type="checkbox"/> Highest	802.11b 802.11g 802.11n HT20 802.11n HT40	<input checked="" type="checkbox"/> Lowest <input checked="" type="checkbox"/> Middle <input checked="" type="checkbox"/> Highest	<input checked="" type="checkbox"/>	<input type="checkbox"/>	<input type="checkbox"/>	<input type="checkbox"/>	complies
§15.109	RX spurious emissions radiated	-/-	-/-	-/-	-/-	<input type="checkbox"/>	<input type="checkbox"/>	<input checked="" type="checkbox"/>	<input type="checkbox"/>	complies
§15.209(a)	TX spurious Emissions radiated < 30 MHz	802.11b	-/-	802.11b	-/-	<input checked="" type="checkbox"/>	<input type="checkbox"/>	<input type="checkbox"/>	<input type="checkbox"/>	complies
§15.107(a) §15.207	Conducted Emissions < 30 MHz	802.11b	-/-	802.11b	-/-	<input checked="" type="checkbox"/>	<input type="checkbox"/>	<input type="checkbox"/>	<input type="checkbox"/>	complies

Remark:

1. The measurement uncertainty is not included in the test result.
2. NA = Not Applicable; NP = Not Performed

Preliminary tests were performed in different data rate to find the worst radiated emission. The data rate shown in the table below is the worst-case rate with respect to the specific test item. Investigation has been done on all the possible configurations for searching the worst cases. The following table is a list of the test modes shown in this test report.

Test Items	Mode	Data Rate	Channel
Maximum Peak Conducted Output Power Power Spectral Density 6dB Bandwidth Spurious RF conducted emission Radiated Emission 9kHz~1GHz& Radiated Emission 1GHz~10 th Harmonic	11b/DSSS	1 Mbps	1/7/11
	11g/OFDM	6 Mbps	1/7/11
	11n(20MHz)/OFDM	6.5Mbps	1/7/11
	11n(40MHz)/OFDM	13.5Mbps	3/7/11
Band Edge	11b/DSSS	1 Mbps	1/11
	11g/OFDM	6 Mbps	1/11
	11n(20MHz)/OFDM	6.5Mbps	1/11
	11n(40MHz)/OFDM	13.5Mbps	3/9

3.5. Statement of the measurement uncertainty

The data and results referenced in this document are true and accurate. The reader is cautioned that there may be errors within the calibration limits of the equipment and facilities. The measurement uncertainty was calculated for all measurements listed in this test report acc. to CISPR 16 - 4 „Specification for radio disturbance and immunity measuring apparatus and methods – Part 4: Uncertainty in EMC Measurements“ and is documented in the Shenzhen Global Test Service Co.,Ltd quality system acc. to DIN EN ISO/IEC 17025. Furthermore, component and process variability of devices similar to that tested may result in additional deviation. The manufacturer has the sole responsibility of continued compliance of the device.

Hereafter the best measurement capability for Shenzhen GTS laboratory is reported:

Test	Range	Measurement Uncertainty	Notes
Radiated Emission	30~1000MHz	4.10 dB	(1)
Radiated Emission	1~18GHz	4.32 dB	(1)
Radiated Emission	18-40GHz	5.54 dB	(1)
Conducted Disturbance	0.15~30MHz	3.12 dB	(1)

- (1) This uncertainty represents an expanded uncertainty expressed at approximately the 95% confidence level using a coverage factor of k=2.

3.6. Equipments Used during the Test

Test Equipment	Manufacturer	Model No.	Serial No.	Calibration Date	Calibration Due Date
LISN	R&S	ENV216	3560.6550.08	2018/09/28	2019/09/27
LISN	R&S	ESH2-Z5	893606/008	2018/09/27	2019/09/26
By-log Antenna	SCHWARZBECK	VULB9163	000976	2018/09/29	2019/09/28
EMI Test Receiver	R&S	ESCI	101102	2018/09/26	2019/09/25
Spectrum Analyzer	Agilent	N9020A	MY48010425	2018/09/17	2019/09/16
Spectrum Analyzer	R&S	FSV40-N	101800	2018/09/17	2019/09/16
Controller	EM Electronics	Controller EM 1000	N/A	2018/09/21	2019/09/20
Double Ridged Horn Antenna (1~18GHz)	SCHWARZBECK	BBHA 9120D	01622	2018/09/19	2019/09/18
Double Ridged Horn Antenna	Rohde&Schwarz	HF907	100265	2018/09/19	2019/09/18
Active Loop Antenna	SCHWARZBECK	FMZB1519	1519-037	2018/09/19	2019/09/18
Horn Antenna (18GHz~40GHz)	ETS	3116	00086467	2018/12/29	2019/12/28
Amplifier (26.5GHz~40GHz)	EMCI	EMC2654045	980028	2018/09/18	2019/09/17
Amplifier (0.1GHz~26.5GHz)	EMCI	EMC012645SE	980355	2018/09/19	2019/09/18
Temperature/Humidity Meter	Gangxing	CTH-608	02	2018/09/20	2019/09/19
High-Pass Filter	K&L	9SH10-2700/X12750-O/O	N/A	2018/09/20	2019/09/19
High-Pass Filter	K&L	41H10-1375/U12750-O/O	N/A	2018/09/20	2019/09/19
Data acquisition card	Agilent	U2531A	TW53323507	2018/09/20	2019/09/19
Power Sensor	Agilent	U2021XA	MY5365004	2018/09/20	2019/09/19
RF Cable	HUBER+SUHNER	RG214	N/A	2018/09/20	2019/09/19
Conducted Emission Test Software	ES-K1	V1.71	N/A	N/A	N/A
Radiated Emission Test Software	JS32-RE	V2.5.0.9	N/A	N/A	N/A

Note: The Cal.Interval was one year.

4. TEST CONDITIONS AND RESULTS

4.1. AC Power Conducted Emission

TEST CONFIGURATION

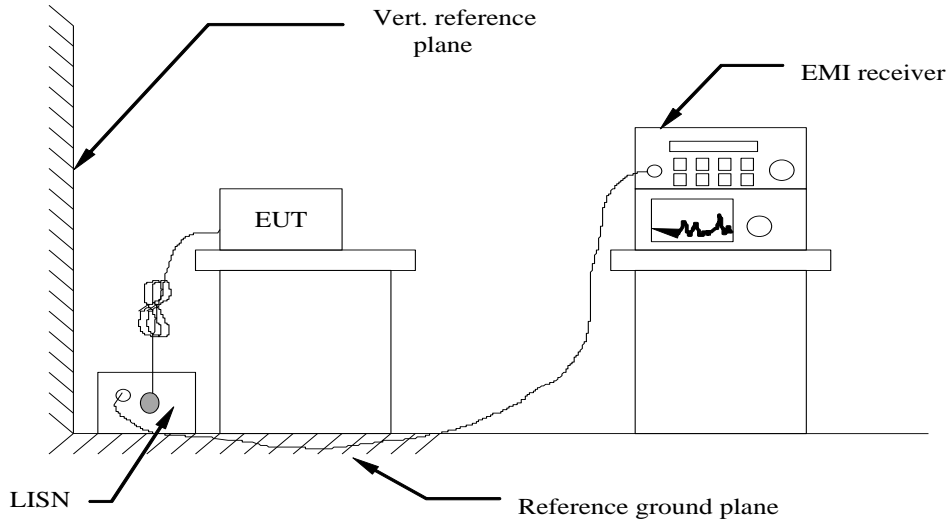

TEST PROCEDURE

- 1 The equipment was set up as per the test configuration to simulate typical actual usage per the user's manual. The EUT is a tabletop system, a wooden table with a height of 0.8 meters is used and is placed on the ground plane as per ANSI C63.10-2013.
- 2 Support equipment, if needed, was placed as per ANSI C63.10-2013
- 3 All I/O cables were positioned to simulate typical actual usage as per ANSI C63.10-2013
- 4 The EUT received DC 12V power from adapter, the adapter received AC120V/60Hz and AC 240V/60Hz power through a Line Impedance Stabilization Network (LISN) which supplied power source and was grounded to the ground plane.
- 5 All support equipments received AC power from a second LISN, if any.
- 6 The EUT test program was started. Emissions were measured on each current carrying line of the EUT using a spectrum Analyzer / Receiver connected to the LISN powering the EUT. The LISN has two monitoring points: Line 1 (Hot Side) and Line 2 (Neutral Side). Two scans were taken: one with Line 1 connected to Analyzer / Receiver and Line 2 connected to a 50 ohm load; the second scan had Line 1 connected to a 50 ohm load and Line 2 connected to the Analyzer / Receiver.
- 7 Analyzer / Receiver scanned from 150 KHz to 30MHz for emissions in each of the test modes.
- 8 During the above scans, the emissions were maximized by cable manipulation.

AC Power Conducted Emission Limit

For intentional device, according to § 15.207(a) AC Power Conducted Emission Limits is as following :

Frequency range (MHz)	Limit (dBuV)	
	Quasi-peak	Average
0.15-0.5	66 to 56*	56 to 46*
0.5-5	56	46
5-30	60	50

* Decreases with the logarithm of the frequency.

TEST RESULTS

Remark: We measured Conducted Emission at 802.11b/802.11g/802.11n HT20/802.11n HT40 mode in AC 120V/60Hz , the worst case was recorded .

Power supply:

DC 12V from Adapter
AC 120V/60Hz

Polarization

L

SCAN TABLE: "Voltage (9K-30M) FIN"
Short Description: 150K-30M Voltage

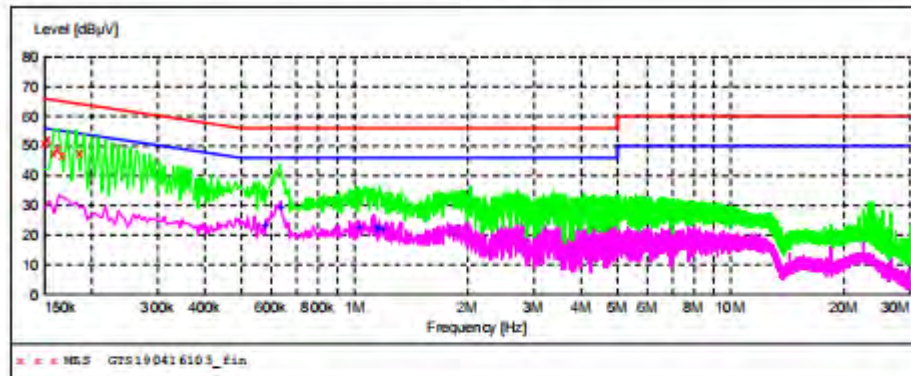

MEASUREMENT RESULT: "GTS190416103_fin"

4/16/2019 10:20AM

Frequency MHz	Level dBµV	Transd dB	Limit dBµV	Margin dB	Detector	Line	FE
0.150000	51.20	10.1	66	14.8	QP	L1	GND
0.154500	52.00	10.1	66	13.8	QP	L1	GND
0.159000	47.30	10.0	66	18.2	QP	L1	GND
0.163500	48.90	10.0	65	16.4	QP	L1	GND
0.168000	46.90	10.0	65	18.2	QP	L1	GND
0.186000	47.40	10.0	64	16.8	QP	L1	GND

MEASUREMENT RESULT: "GTS190416103_fin2"

4/16/2019 10:20AM

Frequency MHz	Level dBµV	Transd dB	Limit dBµV	Margin dB	Detector	Line	FE
0.582000	23.00	9.7	46	23.0	AV	L1	GND
0.636000	29.70	9.7	46	16.3	AV	L1	GND
1.032000	22.40	9.6	46	23.6	AV	L1	GND
1.144500	22.30	9.6	46	23.7	AV	L1	GND
1.149000	22.00	9.6	46	24.0	AV	L1	GND
1.189500	22.10	9.6	46	23.9	AV	L1	GND

Power supply:	DC 12V from Adapter AC 120V/60Hz	Polarization	N
---------------	-------------------------------------	--------------	---

SCAN TABLE: "Voltage (9K-30M) FIN"
Short Description: 150K-30M Voltage

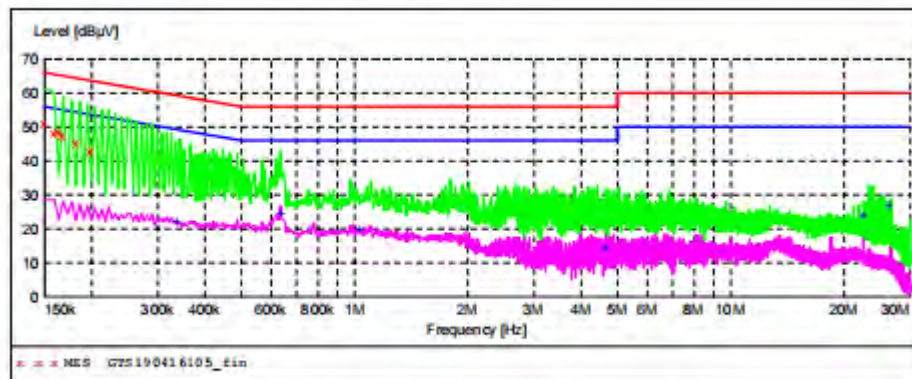

MEASUREMENT RESULT: "GTS190416105_fin"

4/16/2019 10:26AM

Frequency MHz	Level dBµV	Transd dB	Limit dBµV	Margin dB	Detector	Line	FE
0.150000	50.90	10.1	66	15.1	QP	N	GND
0.159000	48.00	10.0	66	17.5	QP	N	GND
0.163500	48.90	10.0	65	16.4	QP	N	GND
0.168000	47.70	10.0	65	17.4	QP	N	GND
0.181500	45.30	10.0	64	19.1	QP	N	GND
0.199500	43.10	10.0	64	20.5	QP	N	GND

MEASUREMENT RESULT: "GTS190416105_fin2"

4/16/2019 10:26AM

Frequency MHz	Level dBµV	Transd dB	Limit dBµV	Margin dB	Detector	Line	FE
0.339000	22.00	9.9	49	27.2	AV	N	GND
0.636000	24.60	9.7	46	21.4	AV	N	GND
1.032000	19.60	9.6	46	26.4	AV	N	GND
4.654500	14.40	9.3	46	31.6	AV	N	GND
22.528500	23.70	7.0	50	26.3	AV	N	GND
26.623500	26.80	7.0	50	23.2	AV	N	GND

4.2. Radiated Emission

TEST CONFIGURATION

Frequency range 9 KHz – 30MHz

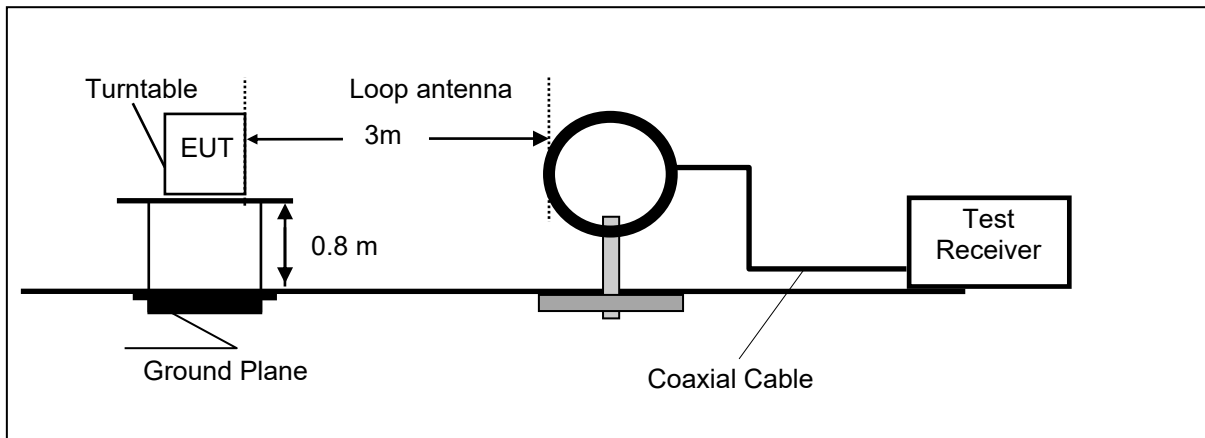

Frequency range 30MHz – 1000MHz

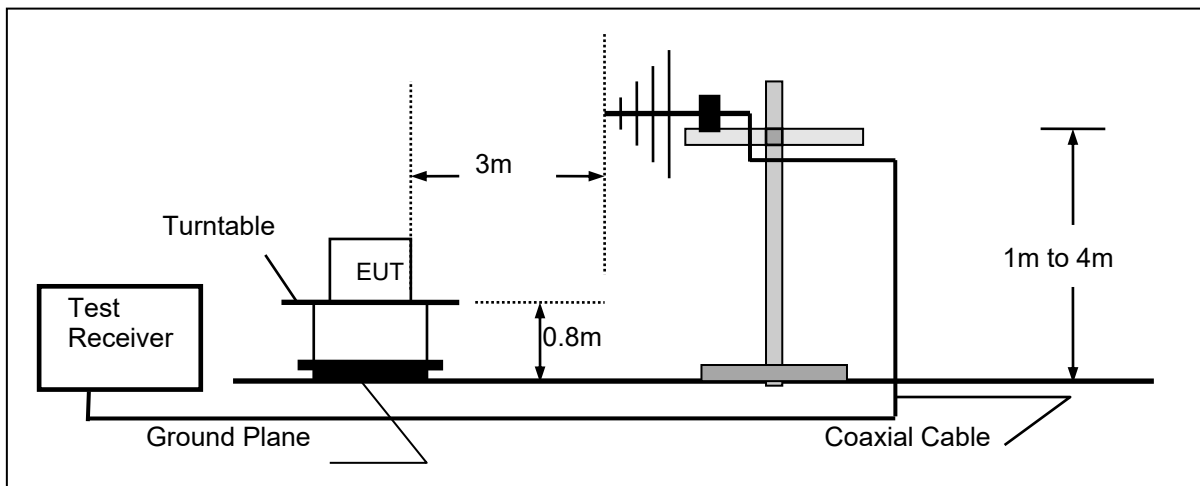

Frequency range above 1GHz-25GHz

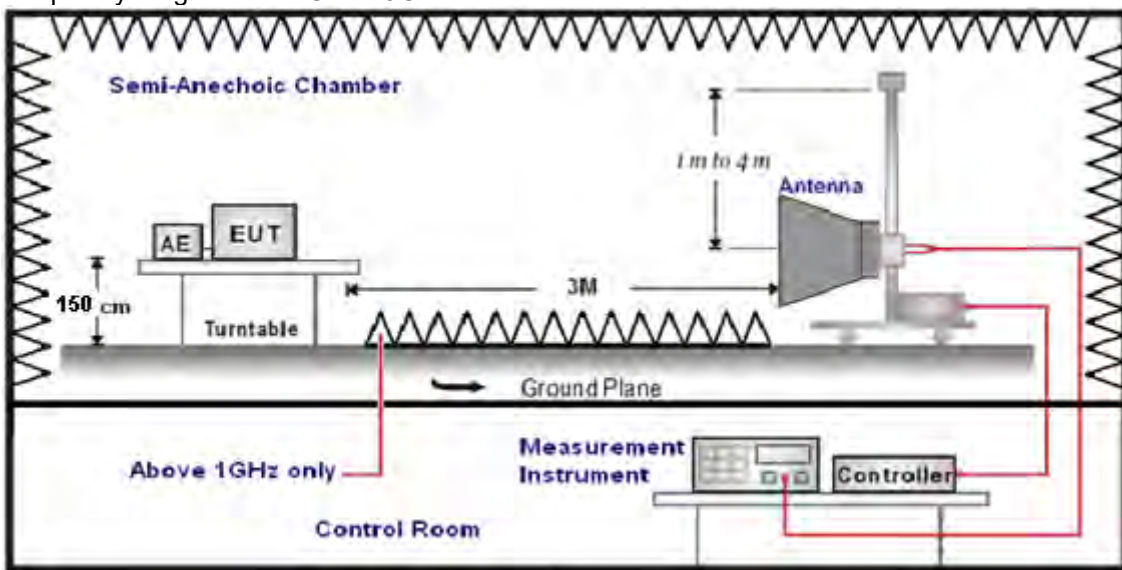

TEST PROCEDURE

1. The EUT was placed on a turn table which is 0.8m above ground plane when testing frequency range 30MHz –1GHz;the EUT was placed on a turn table which is 1.5m above ground plane when testing frequency range 1GHz – 25GHz.
2. Maximum procedure was performed by raising the receiving antenna from 1m to 4m and rotating the turn table from 0° to 360° to acquire the highest emissions from EUT.
3. And also, each emission was to be maximized by changing the polarization of receiving antenna both horizontal and vertical.
4. Repeat above procedures until all frequency measurements have been completed.
5. Radiated emission test frequency band from 30MHz to 25GHz.
6. The distance between test antenna and EUT as following table states:

Test Frequency range	Test Antenna Type	Test Distance
9KHz-30MHz	Active Loop Antenna	3
30MHz-1GHz	Ultra-Broadband Antenna	3
1GHz-18GHz	Double Ridged Horn Antenna	3
18GHz-25GHz	Horn Antenna	1

7. Setting test receiver/spectrum as following table states:

Test Frequency range	Test Receiver/Spectrum Setting	Detector
9KHz-150KHz	RBW=200Hz/VBW=3KHz, Sweep time=Auto	QP
150KHz-30MHz	RBW=9KHz/VBW=100KHz, Sweep time=Auto	QP
30MHz-1GHz	RBW=120KHz/VBW=1000KHz, Sweep time=Auto	QP
1GHz-40GHz	Peak Value: RBW=1MHz/VBW=3MHz, Sweep time=Auto Average Value: RBW=1MHz/VBW=10Hz, Sweep time=Auto	Peak

Field Strength Calculation

The field strength is calculated by adding the Antenna Factor and Cable Factor and subtracting the Amplifier Gain and Duty Cycle Correction Factor(if any) from the measured reading. The basic equation with a sample calculation is as follows:

FS = RA + AF + CL - AG

Where FS = Field Strength	CL = Cable Attenuation Factor (Cable Loss)
RA = Reading Amplitude	AG = Amplifier Gain
AF = Antenna Factor	

Transd=AF +CL-AG

RADIATION LIMIT

For intentional device, according to § 15.209(a), the general requirement of field strength of radiated emission from intentional radiators at a distance of 3 meters shall not exceed the following table. According to § 15.247(d), in any 100kHz bandwidth outside the frequency band in which the EUT is operating, the radio frequency power that is produced by the intentional radiator shall be at least 20dB below that in the100kHz bandwidth within the band that contains the highest level of desired power.

The pre-test have done for the EUT in three axes and found the worst emission at position shown in test setup photos.

Frequency (MHz)	Distance (Meters)	Radiated (dBµV/m)	Radiated (µV/m)
0.009-0.49	3	20log(2400/F(KHz))+40log(300/3)	2400/F(KHz)
0.49-1.705	3	20log(24000/F(KHz))+ 40log(30/3)	24000/F(KHz)
1.705-30	3	20log(30)+ 40log(30/3)	30
30-88	3	40.0	100
88-216	3	43.5	150
216-960	3	46.0	200
Above 960	3	54.0	500

TEST RESULTS

Remark: We measured Radiated Emission at 802.11b/802.11g/802.11n HT20/802.11n HT40 mode from 30 MHz to 25GHz in AC 120V/60Hz and the worst case was recorded.

For 30MHz-1GHz

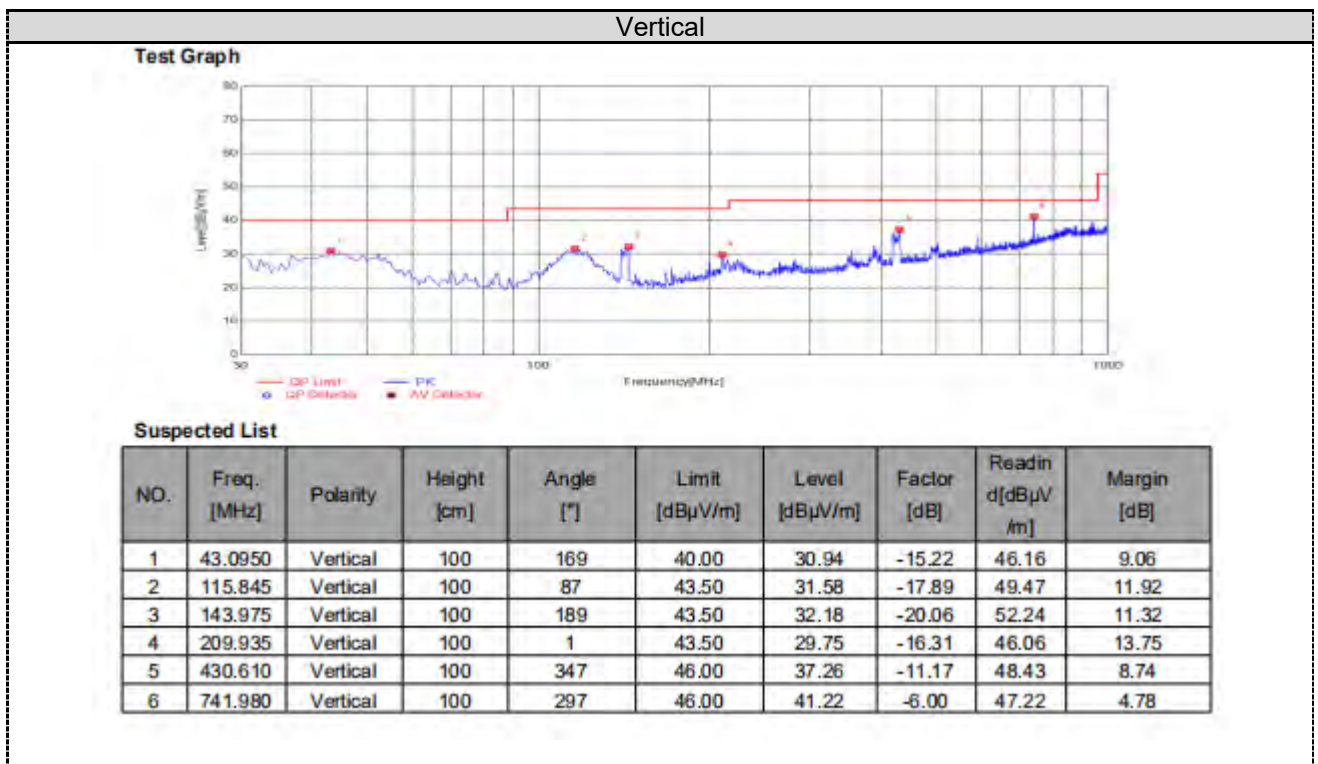
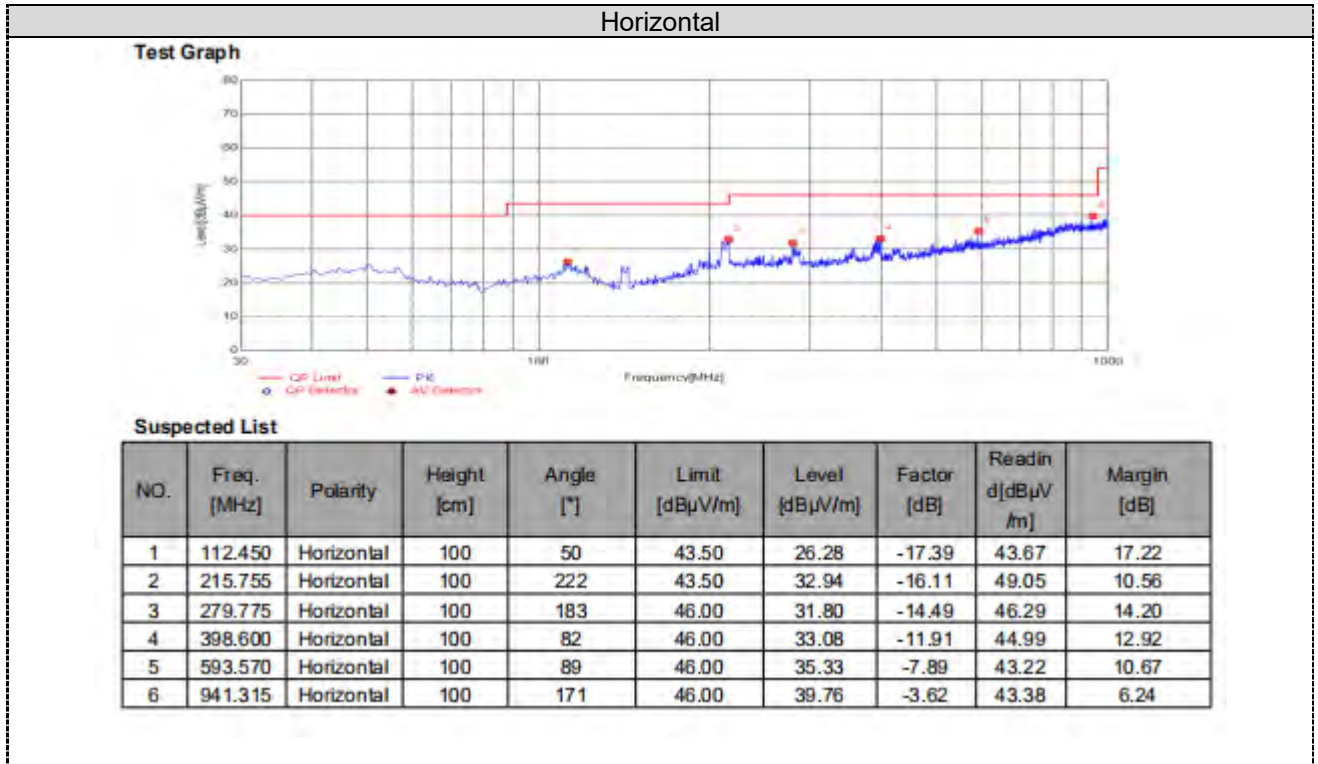

NOTE:the worst case was ant 0.
For 1GHz to 25GHz

802.11b Mode (above 1GHz)

Frequency(MHz):				2412			Polarity:			HORIZONTAL		
No.	Frequency (MHz)	Emission Level (dBuV/m)		Limit (dBuV/m)	Margin (dB)	Antenna Height (m)	Table Angle (Degree)	Raw Value (dBuV)	Antenna Factor (dB/m)	Cable Factor (dB)	Pre-amplifier	Correction Factor (dB/m)
1	4824	50.36	PK	74	23.64	1	133	48.26	31.6	7.00	36.5	2.10
1	4824	40.85	AV	54	13.15	1	133	38.75	31.6	7.00	36.5	2.10

Frequency(MHz):				2442			Polarity:			HORIZONTAL		
No.	Frequency (MHz)	Emission Level (dBuV/m)		Limit (dBuV/m)	Margin (dB)	Antenna Height (m)	Table Angle (Degree)	Raw Value (dBuV)	Antenna Factor (dB/m)	Cable Factor (dB)	Pre-amplifier	Correction Factor (dB/m)
1	4874.00	49.74	PK	74	24.26	1	112	47.62	31.02	7.60	36.5	2.12
1	4874.00	40.66	AV	54	13.34	1	112	38.54	31.02	7.60	36.5	2.12

Frequency(MHz):				2462			Polarity:			HORIZONTAL		
No.	Frequency (MHz)	Emission Level (dBuV/m)		Limit (dBuV/m)	Margin (dB)	Antenna Height (m)	Table Angle (Degree)	Raw Value (dBuV)	Antenna Factor (dB/m)	Cable Factor (dB)	Pre-amplifier	Correction Factor (dB/m)
1	4924.00	51.38	PK	74	22.62	1	175	48.18	31.58	7.82	36.2	3.20
1	4924.00	41.47	AV	54	12.53	1	175	38.27	31.58	7.82	36.2	3.20

802.11g Mode (above 1GHz)

Frequency(MHz):				2412			Polarity:			HORIZONTAL		
No.	Frequency (MHz)	Emission Level (dBuV/m)		Limit (dBuV/m)	Margin (dB)	Antenna Height (m)	Table Angle (Degree)	Raw Value (dBuV)	Antenna Factor (dB/m)	Cable Factor (dB)	Pre-amplifier	Correction Factor (dB/m)
1	4824	50.01	PK	74	23.99	1	186	47.91	31.6	7.00	36.5	2.10
1	4824	41.64	AV	54	12.36	1	186	39.54	31.6	7.00	36.5	2.10

Frequency(MHz):				2442			Polarity:			HORIZONTAL		
No.	Frequency (MHz)	Emission Level (dBuV/m)		Limit (dBuV/m)	Margin (dB)	Antenna Height (m)	Table Angle (Degree)	Raw Value (dBuV)	Antenna Factor (dB/m)	Cable Factor (dB)	Pre-amplifier	Correction Factor (dB/m)
1	4874.00	50.11	PK	74	23.89	1	148	47.99	31.02	7.60	36.5	2.12
1	4874.00	41.99	AV	54	12.01	1	148	39.87	31.02	7.60	36.5	2.12

Frequency(MHz):				2462			Polarity:			HORIZONTAL		
No.	Frequency (MHz)	Emission Level (dBuV/m)		Limit (dBuV/m)	Margin (dB)	Antenna Height (m)	Table Angle (Degree)	Raw Value (dBuV)	Antenna Factor (dB/m)	Cable Factor (dB)	Pre-amplifier	Correction Factor (dB/m)
1	4924.00	50.86	PK	74	23.14	1	142	47.66	31.58	7.82	36.2	3.20
1	4924.00	42.05	AV	54	11.95	1	142	38.85	31.58	7.82	36.2	3.20

802.11n HT20 Mode (above 1GHz)

Frequency(MHz):				2412			Polarity:			HORIZONTAL		
No.	Frequency (MHz)	Emission Level (dBuV/m)		Limit (dBuV/m)	Margin (dB)	Antenna Height (m)	Table Angle (Degree)	Raw Value (dBuV)	Antenna Factor (dB/m)	Cable Factor (dB)	Pre-amplifier	Correction Factor (dB/m)
1	4824	50.39	PK	74	23.61	1	89	48.29	31.6	7.00	36.5	2.10
1	4824	40.85	AV	54	13.15	1	89	38.75	31.6	7.00	36.5	2.10

Frequency(MHz):				2442			Polarity:			HORIZONTAL		
No.	Frequency (MHz)	Emission Level (dBuV/m)		Limit (dBuV/m)	Margin (dB)	Antenna Height (m)	Table Angle (Degree)	Raw Value (dBuV)	Antenna Factor (dB/m)	Cable Factor (dB)	Pre-amplifier	Correction Factor (dB/m)
1	4874.00	50.73	PK	74	23.27	1	107	48.61	31.02	7.60	36.5	2.12
1	4874.00	41.36	AV	54	12.64	1	107	39.24	31.02	7.60	36.5	2.12

Frequency(MHz):				2462			Polarity:			HORIZONTAL		
No.	Frequency (MHz)	Emission Level (dBuV/m)		Limit (dBuV/m)	Margin (dB)	Antenna Height (m)	Table Angle (Degree)	Raw Value (dBuV)	Antenna Factor (dB/m)	Cable Factor (dB)	Pre-amplifier	Correction Factor (dB/m)
1	4924.00	51.64	PK	74	22.36	1	140	48.44	31.58	7.82	36.2	3.20
1	4924.00	42.34	AV	54	11.66	1	140	39.14	31.58	7.82	36.2	3.20

802.11n HT40 Mode (above 1GHz)

Frequency(MHz):				2422			Polarity:			HORIZONTAL		
No.	Frequency (MHz)	Emission Level (dBuV/m)		Limit (dBuV/m)	Margin (dB)	Antenna Height (m)	Table Angle (Degree)	Raw Value (dBuV)	Antenna Factor (dB/m)	Cable Factor (dB)	Pre-amplifier	Correction Factor (dB/m)
1	4844	49.52	PK	74	24.48	1	110	47.42	31.62	7.02	36.5	2.14
1	4844	41.79	AV	54	12.21	1	110	39.69	31.62	7.02	36.5	2.14

Frequency(MHz):				2442			Polarity:			HORIZONTAL		
No.	Frequency (MHz)	Emission Level (dBuV/m)		Limit (dBuV/m)	Margin (dB)	Antenna Height (m)	Table Angle (Degree)	Raw Value (dBuV)	Antenna Factor (dB/m)	Cable Factor (dB)	Pre-amplifier	Correction Factor (dB/m)
1	4874.00	50.65	PK	74	23.35	1	165	48.53	31.02	7.60	36.5	2.12
1	4874.00	41.19	AV	54	12.81	1	165	39.07	31.02	7.60	36.5	2.12

Frequency(MHz):				2452			Polarity:			HORIZONTAL		
No.	Frequency (MHz)	Emission Level (dBuV/m)		Limit (dBuV/m)	Margin (dB)	Antenna Height (m)	Table Angle (Degree)	Raw Value (dBuV)	Antenna Factor (dB/m)	Cable Factor (dB)	Pre-amplifier	Correction Factor (dB/m)
1	4904.00	51.11	PK	74	22.89	1	137	47.91	31.55	7.80	36.2	3.15
1	4904.00	43.15	AV	54	10.85	1	137	39.95	31.55	7.80	36.2	3.15

REMARKS:

1. Emission level (dBuV/m) = Raw Value (dBuV) + Correction Factor (dB/m)
2. Correction Factor (dB/m) = Antenna Factor (dB/m) + Cable Factor (dB) - Pre-amplifier Factor
3. Margin value = Limit value - Emission level.
4. -- Mean the PK detector measured value is below average limit.
5. The other emission levels were very low against the limit.

4.3. Maximum Peak Output Power

TEST CONFIGURATION

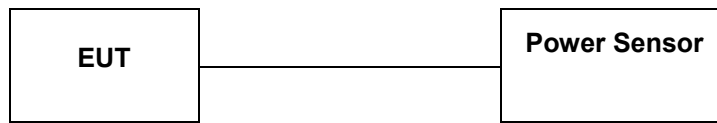

TEST PROCEDURE

According to KDB558074 D01 DTS Measurement Guidance Section 9.1 Maximum peak conducted output power, 9.1.2. and Average conducted output power, 9.2.3.1.

The maximum peak conducted output power may be measured using a broadband peak RF power meter. The power meter shall have a video bandwidth that is greater than or equal to the DTS bandwidth and shall utilize a fast-responding diode detector.

The maximum Average conducted output power may be measured using a wideband RF power meter with a thermocouple detector or equivalent. The power meter shall have a video bandwidth that is greater than or equal to the DTS bandwidth and shall utilize a fast-responding diode detector.

LIMIT

The Maximum Peak Output Power Measurement is 30dBm.

TEST RESULTS

Antenna 0

Type	Channel	Output power PK (dBm)	Output power AV (dBm)	Limit (dBm)	Result
802.11b	01	13.39	9.09	30.00	Pass
	06	13.63	9.31		
	11	13.47	9.21		
802.11g	01	13.28	8.97	30.00	Pass
	06	13.75	9.43		
	11	13.46	9.01		
802.11n(HT20)	01	13.61	9.18	30.00	Pass
	06	13.54	9.25		
	11	13.28	9.11		
802.11n(HT40)	03	13.06	9.02	30.00	Pass
	06	13.71	9.08		
	09	13.79	9.18		

Antenna 1

Type	Channel	Output power PK (dBm)	Output power AV (dBm)	Limit (dBm)	Result
802.11b	01	13.36	9.38	30.00	Pass
	06	13.74	9.34		
	11	13.76	8.76		
802.11g	01	12.92	8.80	30.00	Pass
	06	13.49	8.97		
	11	13.35	9.25		
802.11n(HT20)	01	13.41	8.73	30.00	Pass
	06	13.29	9.47		
	11	13.29	9.38		
802.11n(HT40)	03	13.18	9.11	30.00	Pass
	06	13.47	8.88		
	09	13.86	8.92		

Note: 1.The test results including the cable lose.
Duty cycle used in all test items: 100%

Antenna 0:

802.11b



802.11g

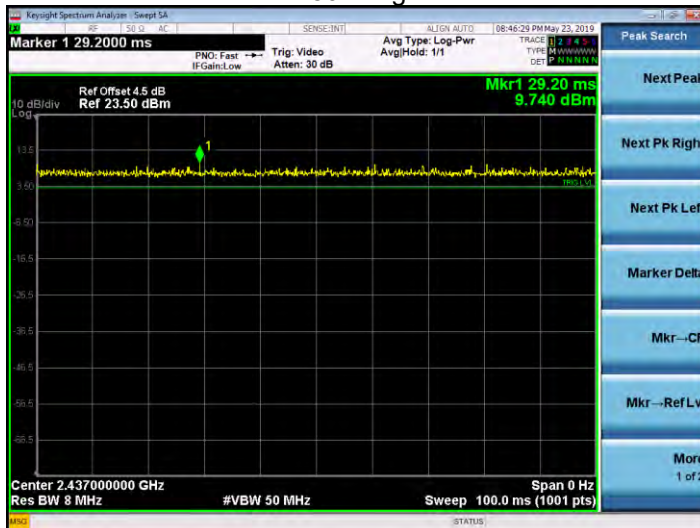

802.11n20

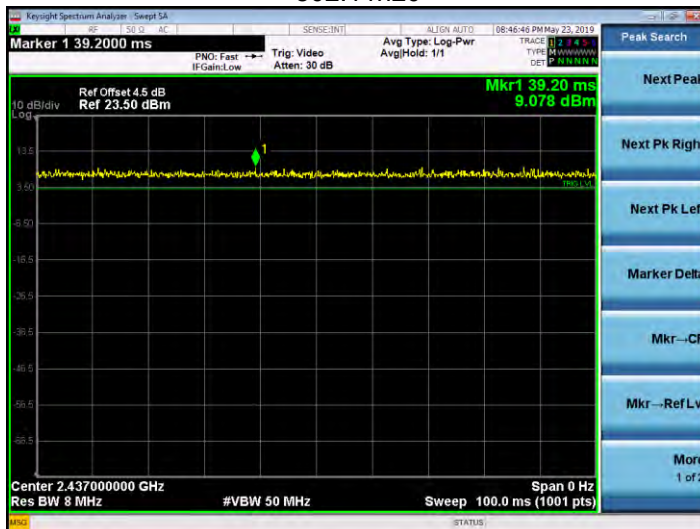

802.11n40

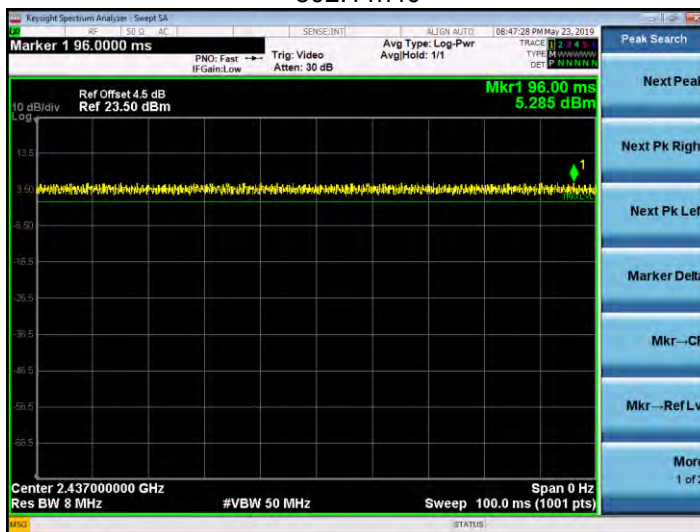

Antenna 1:

802.11b

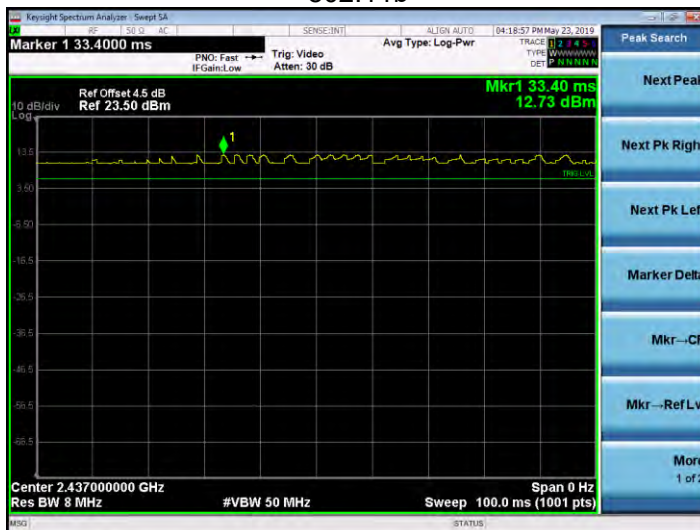

802.11g

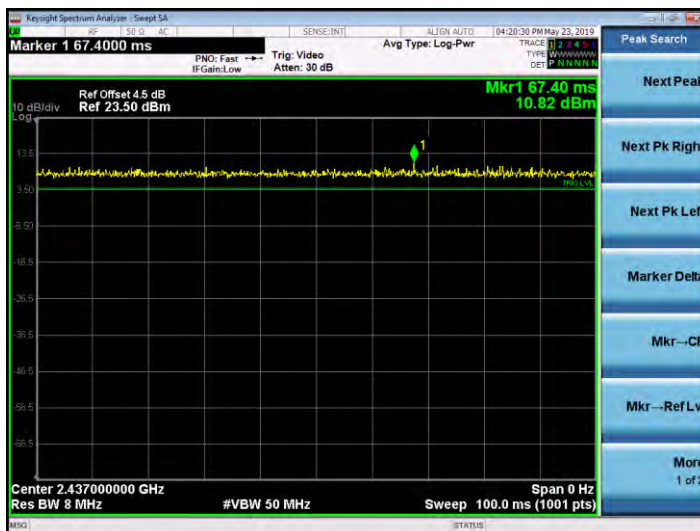

802.11n20

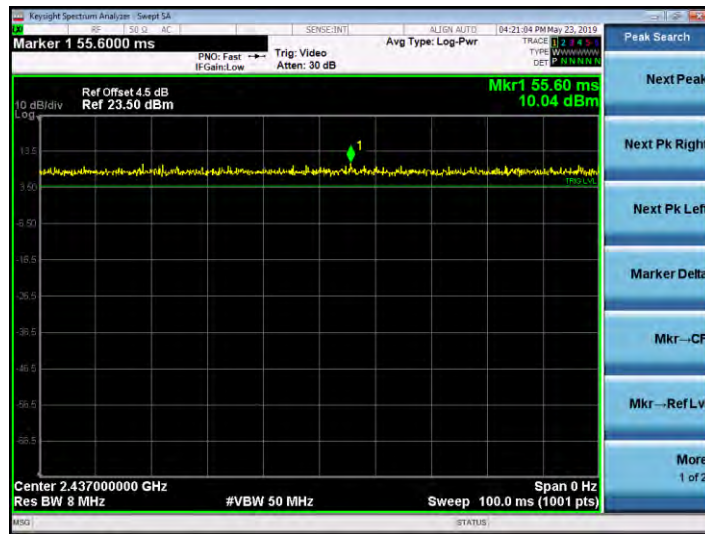

802.11n40

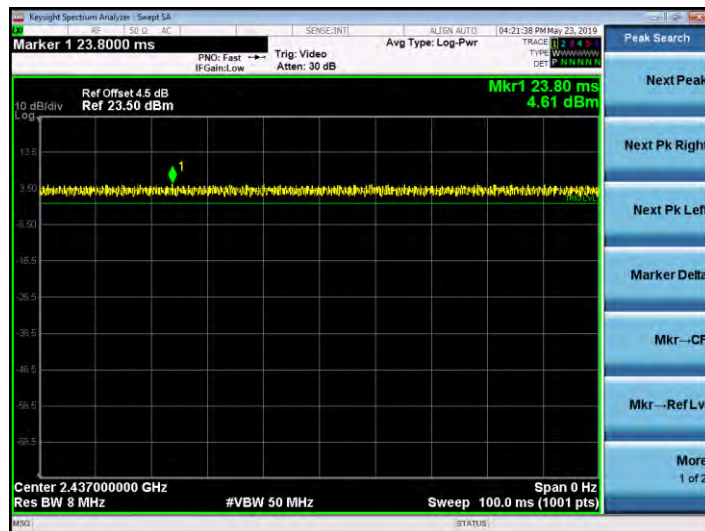

4.4. Power Spectral Density

TEST CONFIGURATION

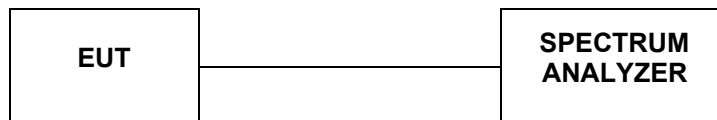

TEST PROCEDURE

According to KDB 558074 D01 Method PKPSD (peak PSD) This procedure shall be used if maximum peak conducted output power was used to demonstrate compliance, and is optional if the maximum conducted (average) output power was used to demonstrate compliance.

1. Set analyzer center frequency to DTS channel center frequency.
2. Set the span to 1.5 times the DTS bandwidth.
3. Set the RBW to: $3 \text{ kHz} \leq \text{RBW} \leq 100 \text{ kHz}$.
4. Set the VBW $\geq 3 \text{ RBW}$.
5. Detector = peak.
6. Sweep time = auto couple.
7. Trace mode = max hold.
8. Allow trace to fully stabilize.
9. Use the peak marker function to determine the maximum amplitude level within the RBW.
10. If measured value exceeds limit, reduce RBW (no less than 3 kHz) and repeat.

LIMIT

For digitally modulated systems, the power spectral density conducted from the intentional radiator to the antenna shall not be greater than 8 dBm in any 3 kHz band during any time interval of continuous transmission.

TEST RESULTS

Antenna 0:

Type	Channel	Power Spectral Density (dBm/3KHz)	Limit (dBm/3KHz)	Result
802.11b	01	-17.798	8.00	Pass
	06	-18.301		
	11	-18.876		
802.11g	01	-22.366	8.00	Pass
	06	-22.701		
	11	-23.066		
802.11n(HT20)	01	-22.809	8.00	Pass
	06	-22.914		
	11	-22.517		
802.11n(HT40)	03	-24.965	8.00	Pass
	06	-26.319		
	09	-24.641		

Antenna 1:

Type	Channel	Power Spectral Density (dBm/3KHz)	Limit (dBm/3KHz)	Result
802.11b	01	-17.901	8.00	Pass
	06	-17.820		
	11	-18.078		
802.11g	01	-23.060	8.00	Pass
	06	-22.000		
	11	-23.291		
802.11n(HT20)	01	-23.024	8.00	Pass
	06	-22.523		
	11	-22.799		
802.11n(HT40)	03	-24.732	8.00	Pass
	06	-24.255		
	09	-23.000		

Antenna 0:

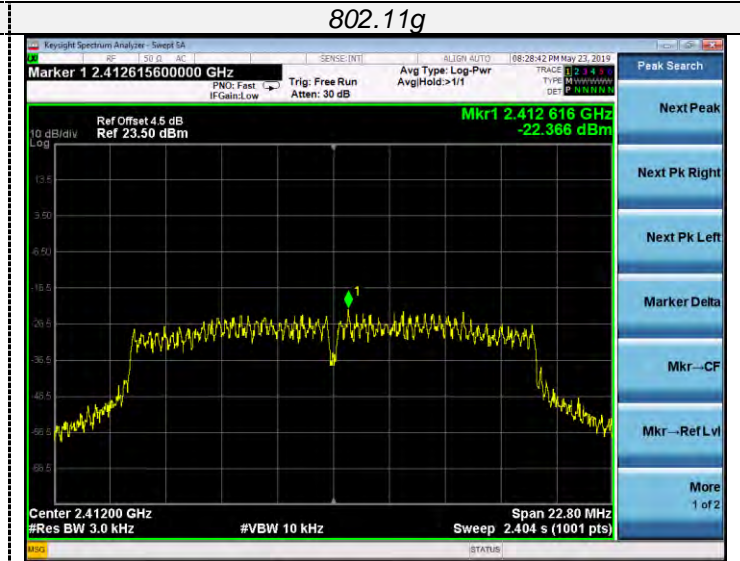

CH11

CH11

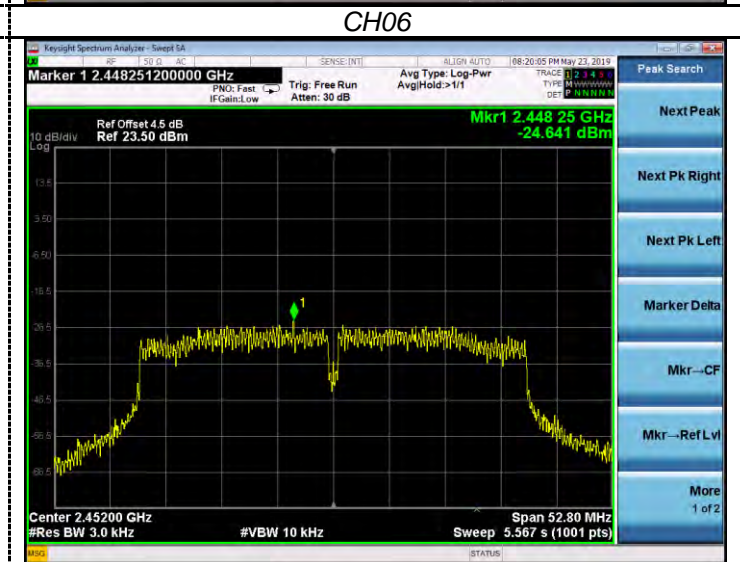
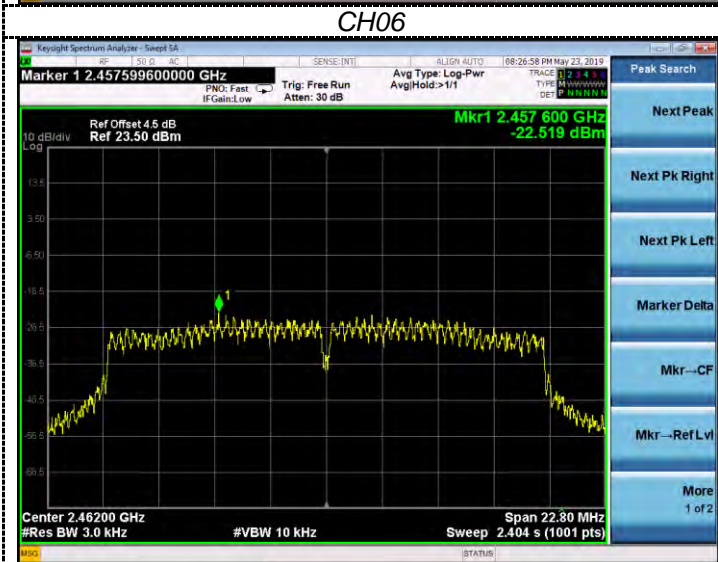
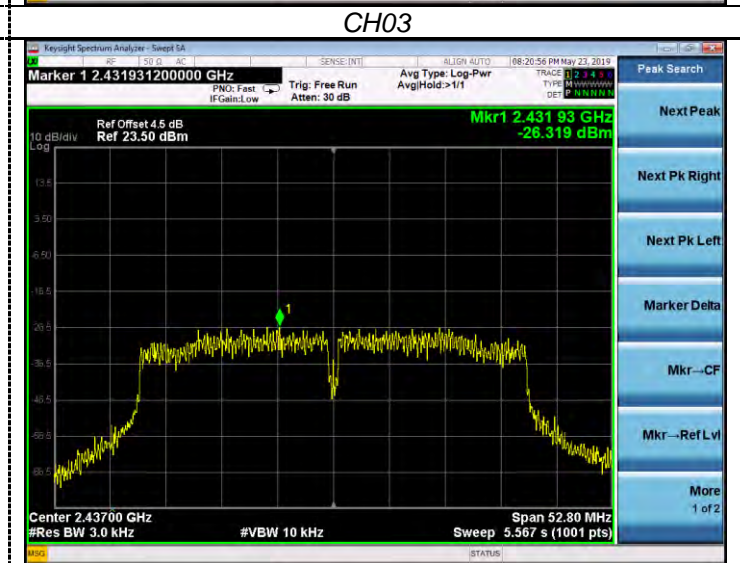
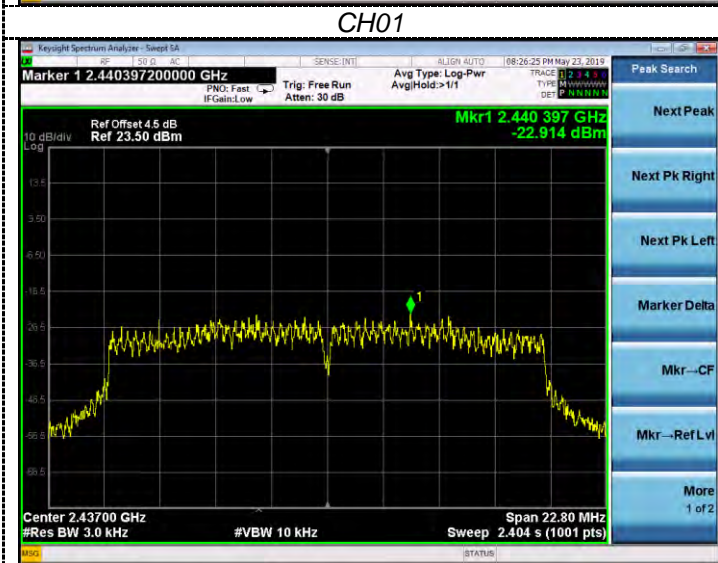
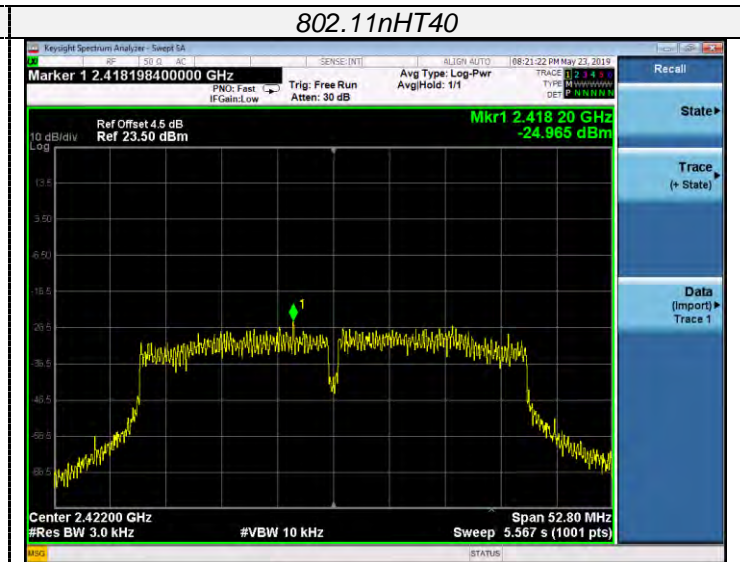

CH11

CH09

Antenna 1:

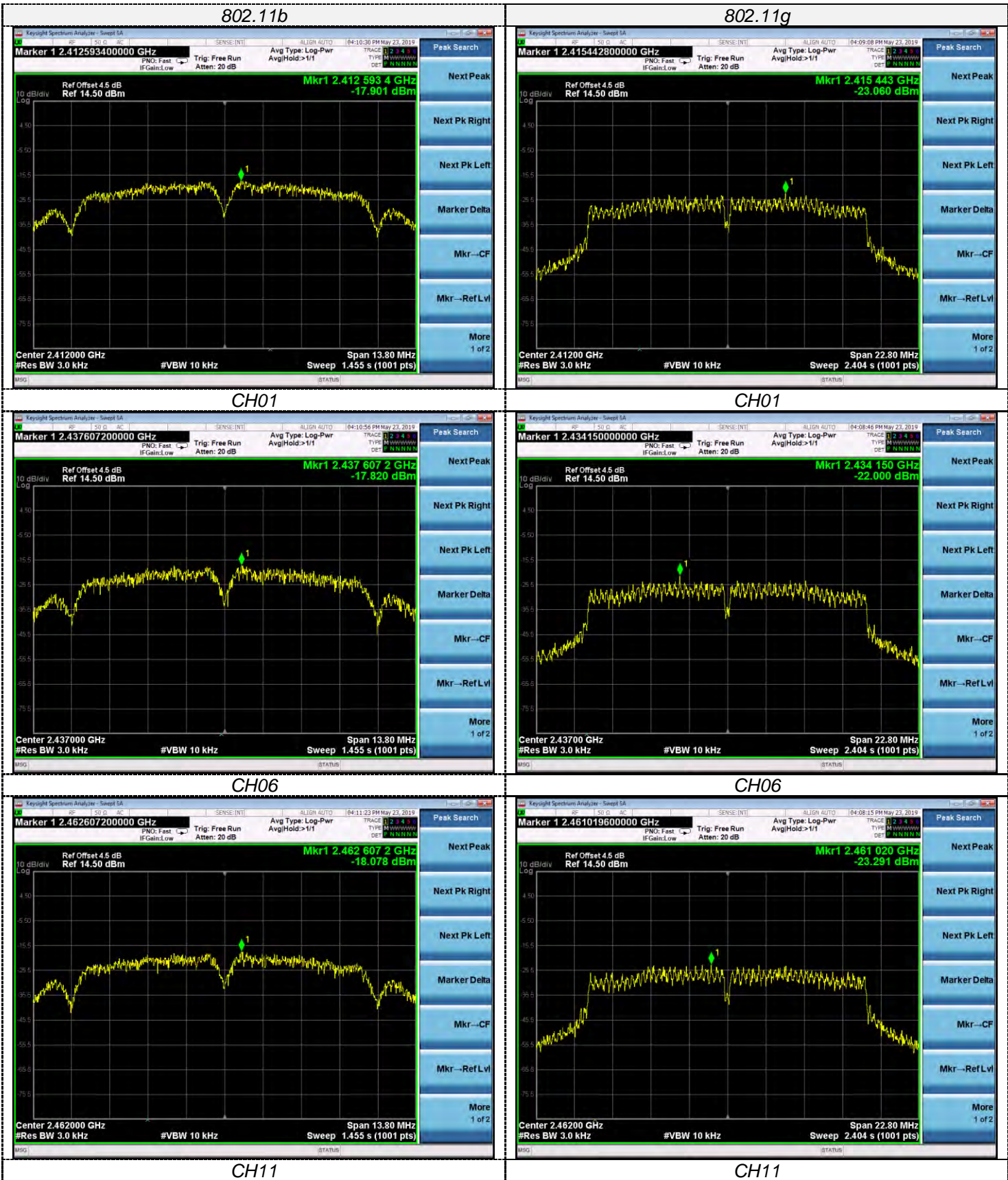

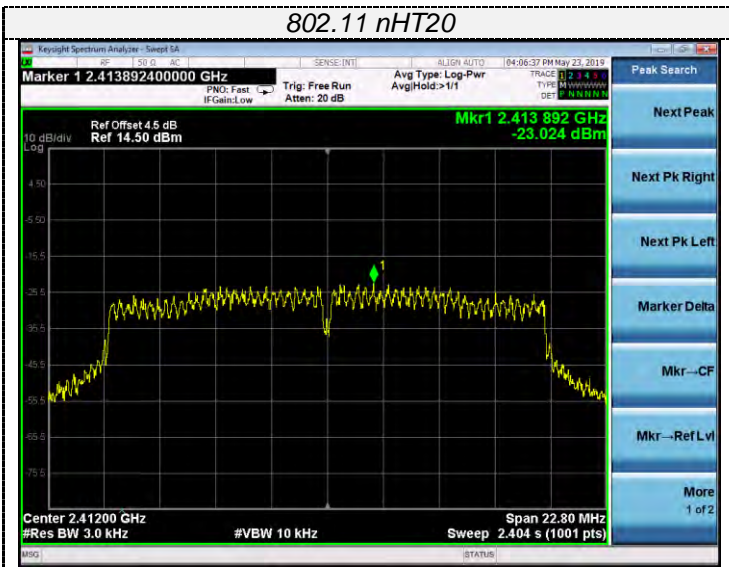

CH01

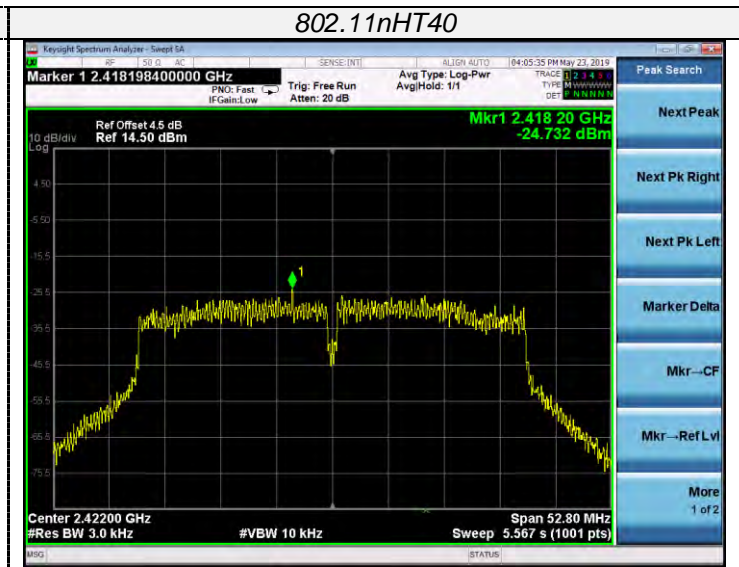

CH03



CH06

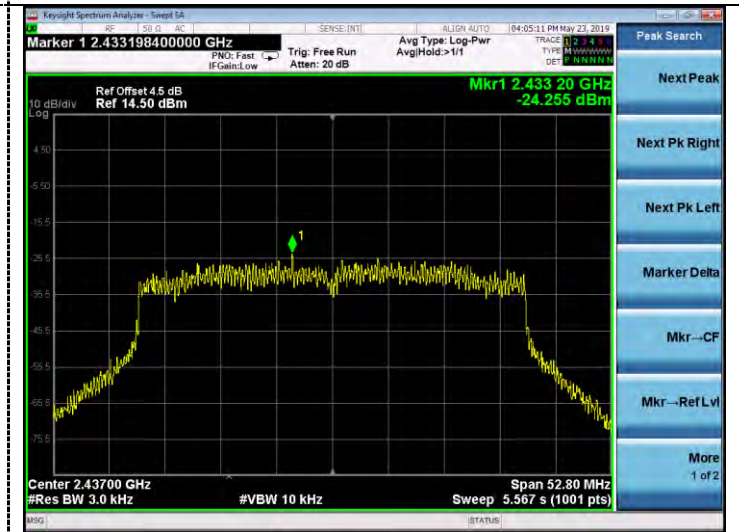

CH06

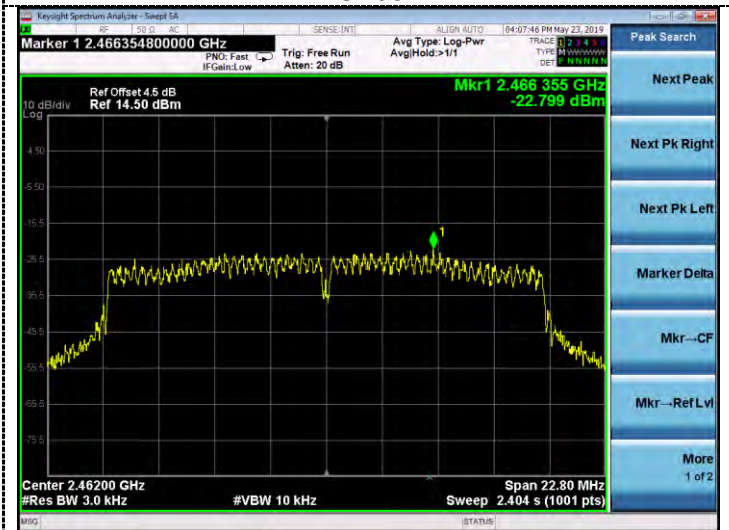

CH11

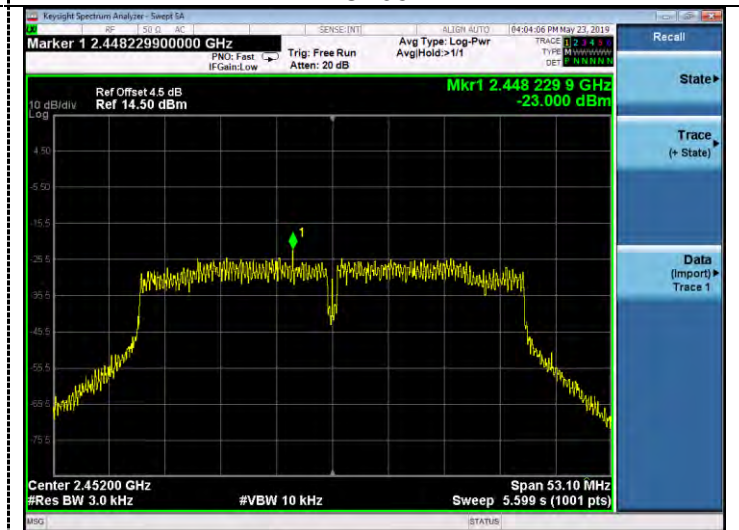

CH09

4.5. 6dB Bandwidth

TEST CONFIGURATION

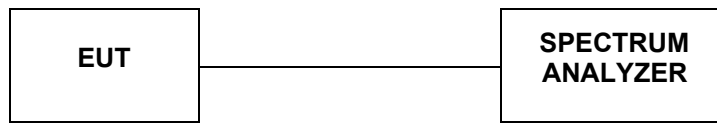

TEST PROCEDURE

The transmitter output was connected to the spectrum analyzer through an attenuator. The bandwidth of the fundamental frequency was measured by spectrum analyzer with RBW=100 KHz and VBW=300KHz. The 6dB bandwidth is defined as the total spectrum the power of which is higher than peak power minus 6dB. According to KDB558074 D01 for one of the following procedures may be used to determine the modulated DTS device signal bandwidth.

1. Set RBW = 100 kHz.
2. Set the video bandwidth (VBW) ≥ 3 RBW.
3. Detector = Peak.
4. Trace mode = max hold.
5. Sweep = auto couple.
6. Allow the trace to stabilize.
7. Measure the maximum width of the emission that is constrained by the frequencies associated with the two outermost amplitude points (upper and lower frequencies) that are attenuated by 6 dB relative to the maximum level measured in the fundamental emission.

LIMIT

For digital modulation systems, the minimum 6 dB bandwidth shall be at least 500 kHz

TEST RESULTS

Antenna 0

Type	Channel	6dB Bandwidth (MHz)	Limit (KHz)	Result
802.11b	01	9.16	≥ 500	Pass
	06	9.16		
	11	9.20		
802.11g	01	15.20	≥ 500	Pass
	06	15.20		
	11	15.16		
802.11nHT20	01	15.20	≥ 500	Pass
	06	15.20		
	11	15.20		
802.11nHT40	03	35.20	≥ 500	Pass
	06	33.20		
	09	35.20		

Antenna 1

Type	Channel	6dB Bandwidth (MHz)	Limit (KHz)	Result
802.11b	01	9.20	≥ 500	Pass
	06	9.20		
	11	9.24		
802.11g	01	15.24	≥ 500	Pass
	06	15.16		
	11	15.16		
802.11nHT20	01	15.16	≥ 500	Pass
	06	15.16		
	11	15.16		
802.11nHT40	03	35.20	≥ 500	Pass
	06	35.20		
	09	35.36		

Antenna 0

802.11b

802.11g



CH01

CH01

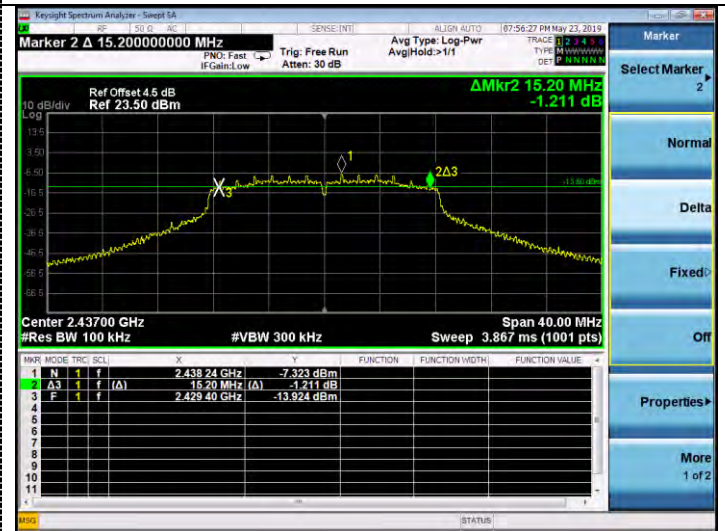

CH06

CH06

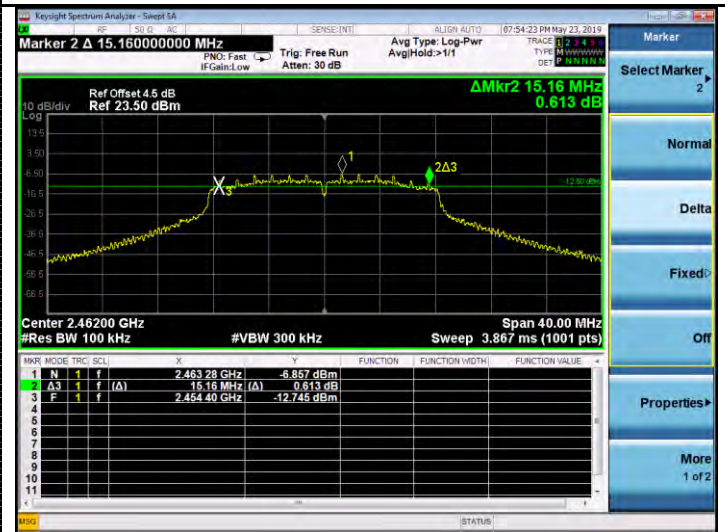

CH11

CH11

802.11n HT20

802.11n HT40

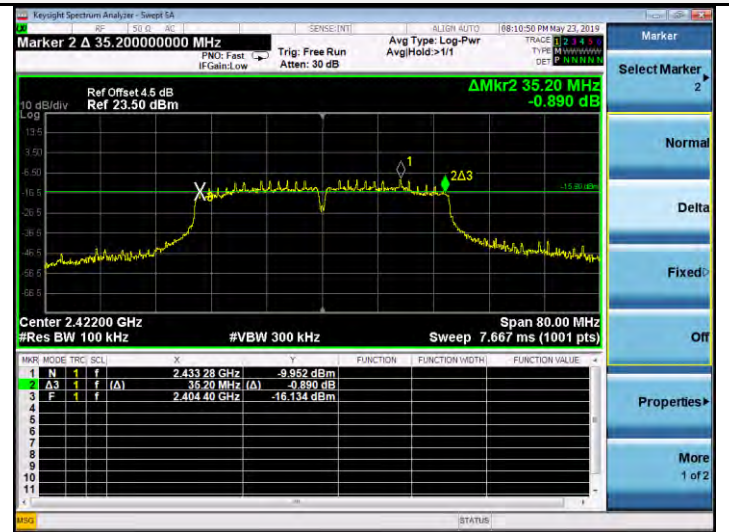

CH01

CH03

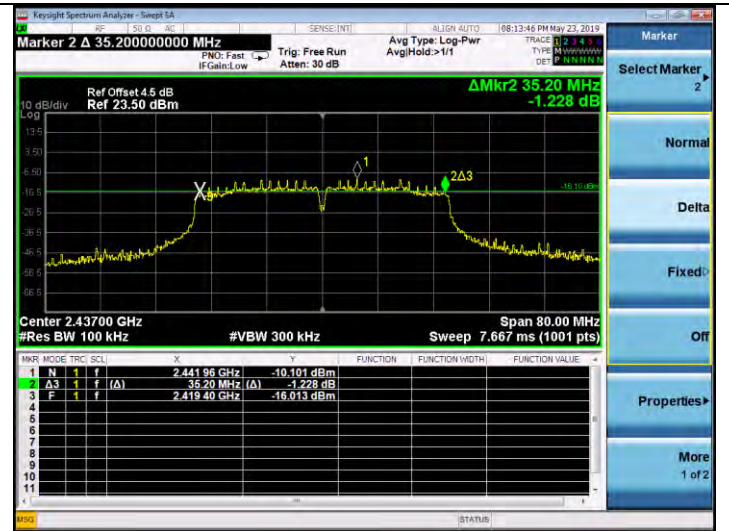

CH06

CH06

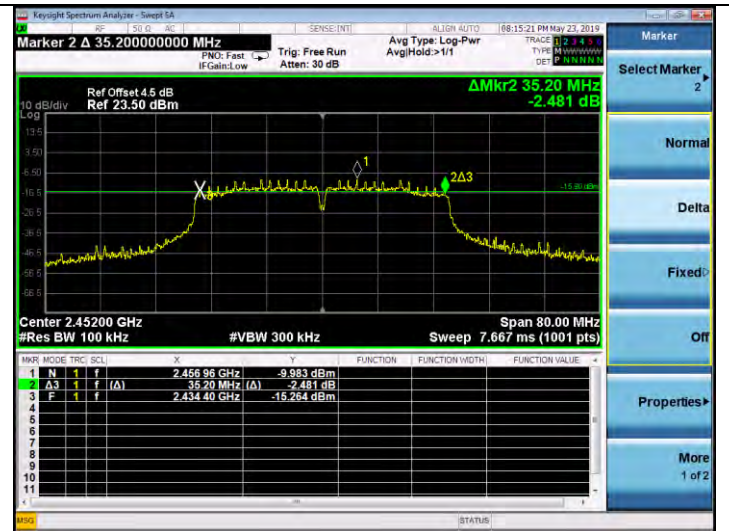

CH11

CH09

Antenna 1

802.11b

802.11g

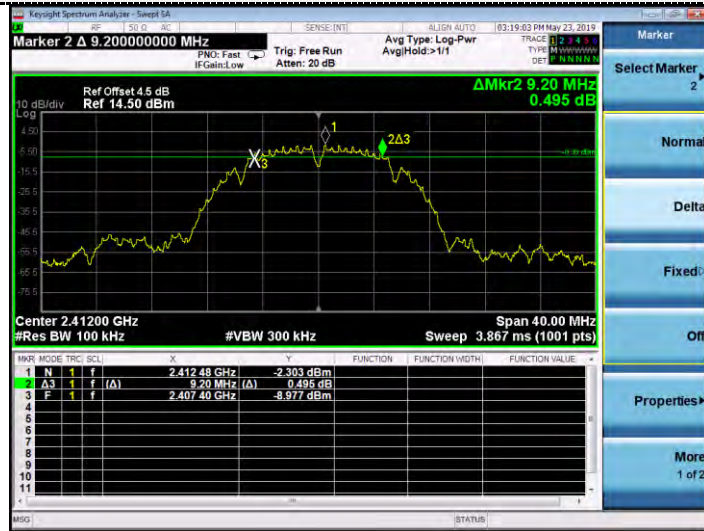

CH01

CH01

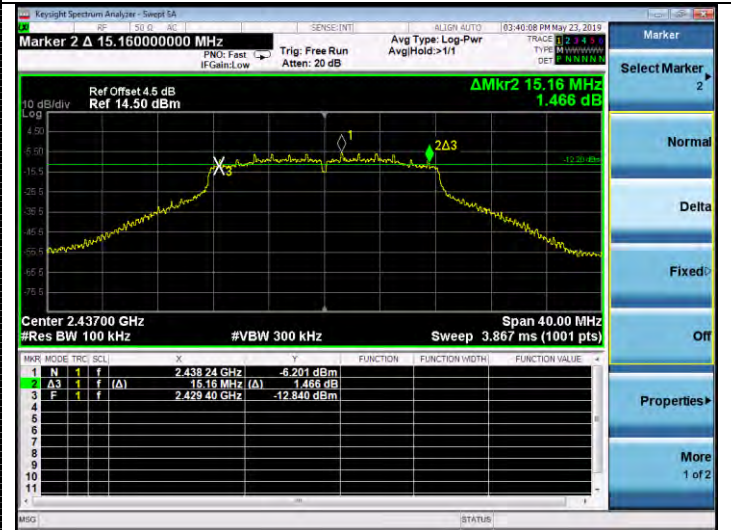

CH06

CH06



CH11

CH11

802.11n HT20

802.11n HT40

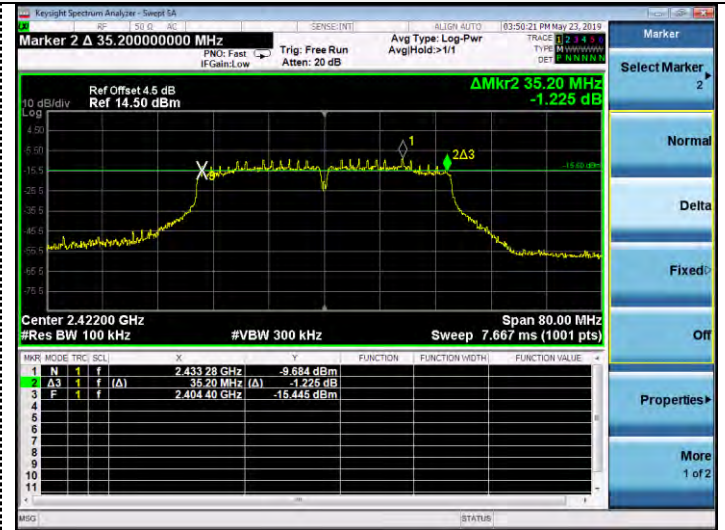

CH01

CH03

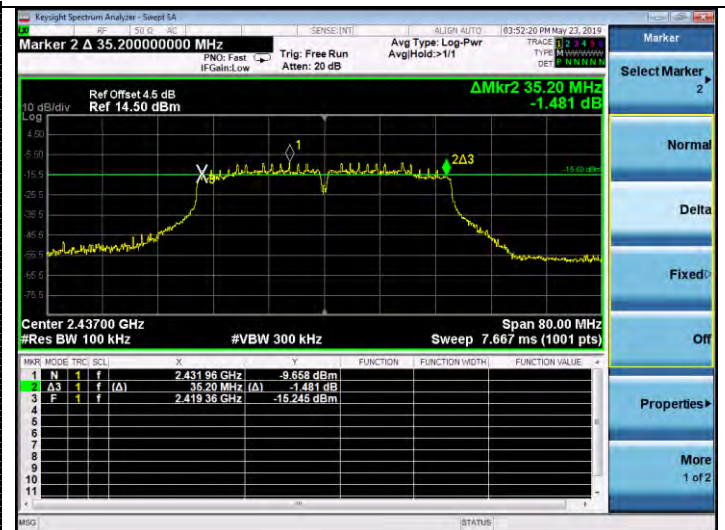
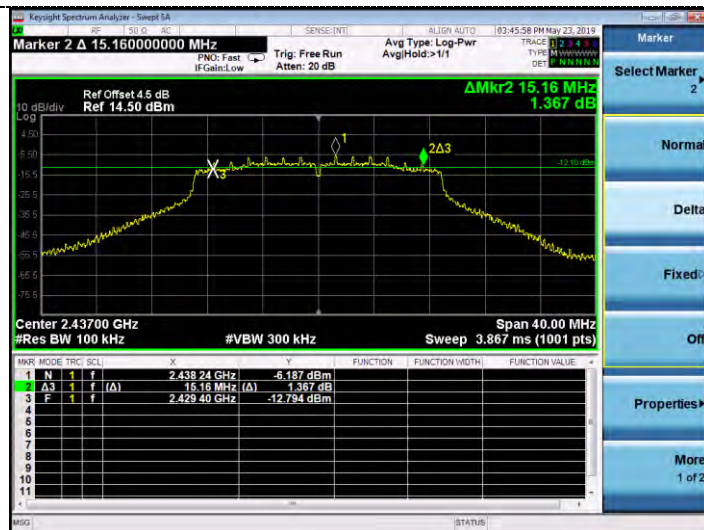

CH06

CH06

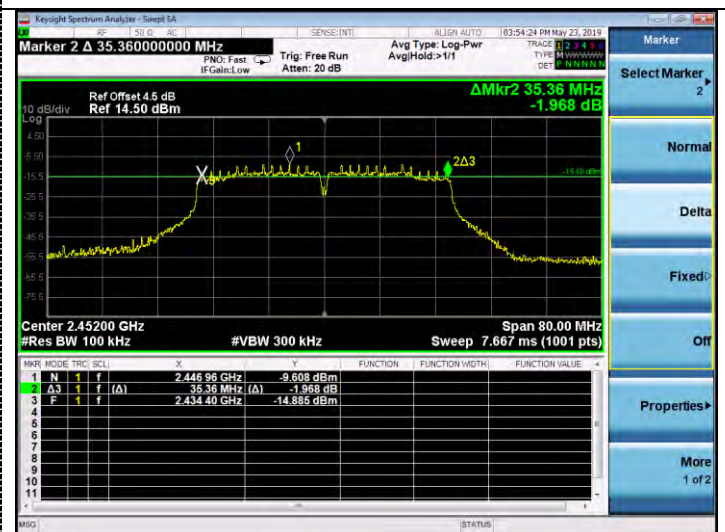

CH11

CH09

4.6. Band Edge Compliance of RF Emission

TEST REQUIREMENT

In any 100 kHz bandwidth outside the frequency band in which the spread spectrum or digitally modulated intentional radiator is operating, the radio frequency power that is produced by the intentional radiator shall be at least 20 dB below that in the 100 kHz bandwidth within the band that contains the highest level of the desired power, based on either an RF conducted or a radiated measurement, provided the transmitter demonstrates compliance with the peak conducted power limits. If the transmitter complies with the conducted power limits based on the use of RMS averaging over a time interval, as permitted under paragraph (b)(3) of this section, the attenuation required under this paragraph shall be 30 dB instead of 20 dB. Attenuation below the general limits specified in §15.209(a) is not required. In addition, radiated emissions which fall in the restricted bands, as defined in §15.205(a), must also comply with the radiated emission limits specified in §15.209(a) (see §15.205(c)).

TEST PROCEDURE

According to KDB 558074 D01 for Antenna-port conducted measurement. Antenna-port conducted measurements may also be used as an alternative to radiated measurements for demonstrating compliance in the restricted frequency bands. If conducted measurements are performed, then proper impedance matching must be ensured and an additional radiated test for cabinet/case spurious emissions is required.

1. Check the calibration of the measuring instrument using either an internal calibrator or a known signal from an external generator.
2. Remove the antenna from the EUT and then connect to a low loss RF cable from the antenna port to a EMI test receiver, then turn on the EUT and make it operate in transmitting mode. Then set it to Low Channel and High Channel within its operating range, and make sure the instrument is operated in its linear range.
3. Set both RBW and VBW of spectrum analyzer to 100 kHz with a convenient frequency span including 100kHz bandwidth from band edge, for Radiated emissions restricted band RBW=1MHz, VBW=3MHz for peak detector and RBW=1MHz, VBW=10Hz for average detector.
4. Measure the highest amplitude appearing on spectral display and set it as a reference level. Plot the graph with marking the highest point and edge frequency.
5. Repeat above procedures until all measured frequencies were complete.
6. Measure the conducted output power (in dBm) using the detector specified by the appropriate regulatory agency (see 12.2.2, 12.2.3, and 12.2.4 for guidance regarding measurement procedures for determining quasi-peak, peak, and average conducted output power, respectively).
7. Add the maximum transmit antenna gain (in dBi) to the measured output power level to determine the EIRP level (see 12.2.5 for guidance on determining the applicable antenna gain)
8. Add the appropriate maximum ground reflection factor to the EIRP level (6 dB for frequencies \leq 30 MHz, 4.7 dB for frequencies between 30 MHz and 1000 MHz, inclusive and 0 dB for frequencies $>$ 1000 MHz).
9. For devices with multiple antenna-ports, measure the power of each individual chain and sum the EIRP of all chains in linear terms (e.g., Watts, mW).
10. Convert the resultant EIRP level to an equivalent electric field strength using the following relationship:

$$E = \text{EIRP} - 20\log D + 104.8$$

where:

E = electric field strength in dB μ V/m,

EIRP = equivalent isotropic radiated power in dBm

D = specified measurement distance in meters.

11. Since the out-of-band characteristics of the EUT transmit antenna will often be unknown, the use of a conservative antenna gain value is necessary. Thus, when determining the EIRP based on the measured conducted power, the upper bound on antenna gain for a device with a single RF output shall be selected as the maximum in-band gain of the antenna across all operating bands, or 2 dBi, whichever is greater. However, for devices that operate in multiple frequency bands while using the same transmit antenna, the highest gain of the antenna within the operating band nearest in frequency to the restricted band emission being measured may be used in lieu of the overall highest gain when the emission is at a frequency that is within 20 percent of the nearest band edge frequency, but in no case shall a value less than 2 dBi be used.
12. Compare the resultant electric field strength level to the applicable regulatory limit.
13. Perform radiated spurious emission test dures until all measured frequencies were complete.

LIMIT

Below -20dB of the highest emission level in operating band.

Radiated emissions which fall in the restricted bands, as defined in § 15.205(a), must also comply with the radiated emission limits specified in § 15.209(a).

TEST RESULTS

NOTE:we test the ant0&ant1,and record the worst case which was ant0
4.6.1 For Radiated Bandedge Measurement

802.11b

Frequency(MHz):			2412			Polarity:			HORIZONTAL		
Frequency (MHz)	Emission Level (dBuV/m)		Limit (dBuV/m)	Margin (dB)	Antenna Height (m)	Table Angle (Degree)	Raw Value (dBuV)	Antenna Factor (dB/m)	Cable Factor (dB)	Pre-amplifier	Correction Factor (dB/m)
2390.00	49.07	PK	74	24.93	1	122	54.38	27.49	3.32	36.12	-5.31
2390.00	38.65	AV	54	15.35	1	122	43.96	27.49	3.32	36.12	-5.31
Frequency(MHz):			2412			Polarity:			VERTICAL		
Frequency (MHz)	Emission Level (dBuV/m)		Limit (dBuV/m)	Margin (dB)	Antenna Height (m)	Table Angle (Degree)	Raw Value (dBuV)	Antenna Factor (dB/m)	Cable Factor (dB)	Pre-amplifier	Correction Factor (dB/m)
2390.00	49.01	PK	74	24.99	1	97	54.32	27.49	3.32	36.12	-5.31
2390.00	38.46	AV	54	15.54	1	97	43.77	27.49	3.32	36.12	-5.31
Frequency(MHz):			2462			Polarity:			HORIZONTAL		
Frequency (MHz)	Emission Level (dBuV/m)		Limit (dBuV/m)	Margin (dB)	Antenna Height (m)	Table Angle (Degree)	Raw Value (dBuV)	Antenna Factor (dB/m)	Cable Factor (dB)	Pre-amplifier	Correction Factor (dB/m)
2483.50	48.45	PK	74	24.67	1	157	54.17	27.45	3.38	36.55	-5.72
2483.50	38.41	AV	54	12.37	1	157	44.13	27.45	3.38	36.55	-5.72
Frequency(MHz):			2462			Polarity:			VERTICAL		
Frequency (MHz)	Emission Level (dBuV/m)		Limit (dBuV/m)	Margin (dB)	Antenna Height (m)	Table Angle (Degree)	Raw Value (dBuV)	Antenna Factor (dB/m)	Cable Factor (dB)	Pre-amplifier	Correction Factor (dB/m)
2483.50	48.61	PK	74	24.67	1	324	54.33	27.45	3.38	36.55	-5.72
2483.50	38.11	AV	54	12.37	1	324	43.83	27.45	3.38	36.55	-5.72

802.11g

Frequency(MHz):			2412			Polarity:			HORIZONTAL		
Frequency (MHz)	Emission Level (dBuV/m)		Limit (dBuV/m)	Margin (dB)	Antenna Height (m)	Table Angle (Degree)	Raw Value (dBuV)	Antenna Factor (dB/m)	Cable Factor (dB)	Pre-amplifier	Correction Factor (dB/m)
2390.00	48.54	PK	74	25.46	1	122	53.85	27.49	3.32	36.12	-5.31
2390.00	39.51	AV	54	14.49	1	122	44.82	27.49	3.32	36.12	-5.31
Frequency(MHz):			2412			Polarity:			VERTICAL		
Frequency (MHz)	Emission Level (dBuV/m)		Limit (dBuV/m)	Margin (dB)	Antenna Height (m)	Table Angle (Degree)	Raw Value (dBuV)	Antenna Factor (dB/m)	Cable Factor (dB)	Pre-amplifier	Correction Factor (dB/m)
2390.00	48.34	PK	74	25.66	1	97	53.65	27.49	3.32	36.12	-5.31
2390.00	39.22	AV	54	14.78	1	97	44.53	27.49	3.32	36.12	-5.31
Frequency(MHz):			2462			Polarity:			HORIZONTAL		
Frequency (MHz)	Emission Level (dBuV/m)		Limit (dBuV/m)	Margin (dB)	Antenna Height (m)	Table Angle (Degree)	Raw Value (dBuV)	Antenna Factor (dB/m)	Cable Factor (dB)	Pre-amplifier	Correction Factor (dB/m)
2483.50	48.25	PK	74	24.67	1	157	53.97	27.45	3.38	36.55	-5.72
2483.50	38.45	AV	54	12.37	1	157	44.17	27.45	3.38	36.55	-5.72
Frequency(MHz):			2462			Polarity:			VERTICAL		
Frequency (MHz)	Emission Level (dBuV/m)		Limit (dBuV/m)	Margin (dB)	Antenna Height (m)	Table Angle (Degree)	Raw Value (dBuV)	Antenna Factor (dB/m)	Cable Factor (dB)	Pre-amplifier	Correction Factor (dB/m)
2483.50	48.79	PK	74	24.67	1	324	54.51	27.45	3.38	36.55	-5.72
2483.50	37.5	AV	54	12.37	1	324	43.22	27.45	3.38	36.55	-5.72

802.11n HT20

Frequency(MHz):			2412			Polarity:			HORIZONTAL		
Frequency (MHz)	Emission Level (dBuV/m)		Limit (dBuV/m)	Margin (dB)	Antenna Height (m)	Table Angle (Degree)	Raw Value (dBuV)	Antenna Factor (dB/m)	Cable Factor (dB)	Pre-amplifier	Correction Factor (dB/m)
2390.00	48.62	PK	74	25.38	1	141	53.93	27.49	3.32	36.12	-5.31
2390.00	38.11	AV	54	15.89	1	141	43.42	27.49	3.32	36.12	-5.31
Frequency(MHz):			2412			Polarity:			VERTICAL		
Frequency (MHz)	Emission Level (dBuV/m)		Limit (dBuV/m)	Margin (dB)	Antenna Height (m)	Table Angle (Degree)	Raw Value (dBuV)	Antenna Factor (dB/m)	Cable Factor (dB)	Pre-amplifier	Correction Factor (dB/m)
2390.00	49.47	PK	74	24.53	1	262	54.78	27.49	3.32	36.12	-5.31
2390.00	38.68	AV	54	15.32	1	262	43.99	27.49	3.32	36.12	-5.31
Frequency(MHz):			2462			Polarity:			HORIZONTAL		
Frequency (MHz)	Emission Level (dBuV/m)		Limit (dBuV/m)	Margin (dB)	Antenna Height (m)	Table Angle (Degree)	Raw Value (dBuV)	Antenna Factor (dB/m)	Cable Factor (dB)	Pre-amplifier	Correction Factor (dB/m)
2483.50	48.29	PK	74	24.67	1	104	54.01	27.45	3.38	36.55	-5.72
2483.50	38.84	AV	54	12.37	1	104	44.56	27.45	3.38	36.55	-5.72
Frequency(MHz):			2462			Polarity:			VERTICAL		
Frequency (MHz)	Emission Level (dBuV/m)		Limit (dBuV/m)	Margin (dB)	Antenna Height (m)	Table Angle (Degree)	Raw Value (dBuV)	Antenna Factor (dB/m)	Cable Factor (dB)	Pre-amplifier	Correction Factor (dB/m)
2483.50	48.05	PK	74	24.67	1	227	53.77	27.45	3.38	36.55	-5.72
2483.50	37.77	AV	54	12.37	1	227	43.49	27.45	3.38	36.55	-5.72

802.11n HT40

Frequency(MHz):			2422			Polarity:			HORIZONTAL		
Frequency (MHz)	Emission Level (dBuV/m)		Limit (dBuV/m)	Margin (dB)	Antenna Height (m)	Table Angle (Degree)	Raw Value (dBuV)	Antenna Factor (dB/m)	Cable Factor (dB)	Pre-amplifier	Correction Factor (dB/m)
2390.00	48.76	PK	74	25.24	1	136	54.07	27.49	3.32	36.12	-5.31
2390.00	38.52	AV	54	15.48	1	136	43.83	27.49	3.32	36.12	-5.31
Frequency(MHz):			2422			Polarity:			VERTICAL		
Frequency (MHz)	Emission Level (dBuV/m)		Limit (dBuV/m)	Margin (dB)	Antenna Height (m)	Table Angle (Degree)	Raw Value (dBuV)	Antenna Factor (dB/m)	Cable Factor (dB)	Pre-amplifier	Correction Factor (dB/m)
2390.00	48.92	PK	74	25.08	1	211	54.23	27.49	3.32	36.12	-5.31
2390.00	39.39	AV	54	14.61	1	211	44.7	27.49	3.32	36.12	-5.31
Frequency(MHz):			2452			Polarity:			HORIZONTAL		
Frequency (MHz)	Emission Level (dBuV/m)		Limit (dBuV/m)	Margin (dB)	Antenna Height (m)	Table Angle (Degree)	Raw Value (dBuV)	Antenna Factor (dB/m)	Cable Factor (dB)	Pre-amplifier	Correction Factor (dB/m)
2483.50	47.71	PK	74	24.67	1	104	53.43	27.45	3.38	36.55	-5.72
2483.50	38.88	AV	54	12.37	1	104	44.6	27.45	3.38	36.55	-5.72
Frequency(MHz):			2452			Polarity:			VERTICAL		
Frequency (MHz)	Emission Level (dBuV/m)		Limit (dBuV/m)	Margin (dB)	Antenna Height (m)	Table Angle (Degree)	Raw Value (dBuV)	Antenna Factor (dB/m)	Cable Factor (dB)	Pre-amplifier	Correction Factor (dB/m)
2483.50	48.65	PK	74	24.67	1	130	54.37	27.45	3.38	36.55	-5.72
2483.50	39.14	AV	54	12.37	1	130	44.86	27.45	3.38	36.55	-5.72

4.6.2 For Conducted Bandedge Measurement

Antenna 0

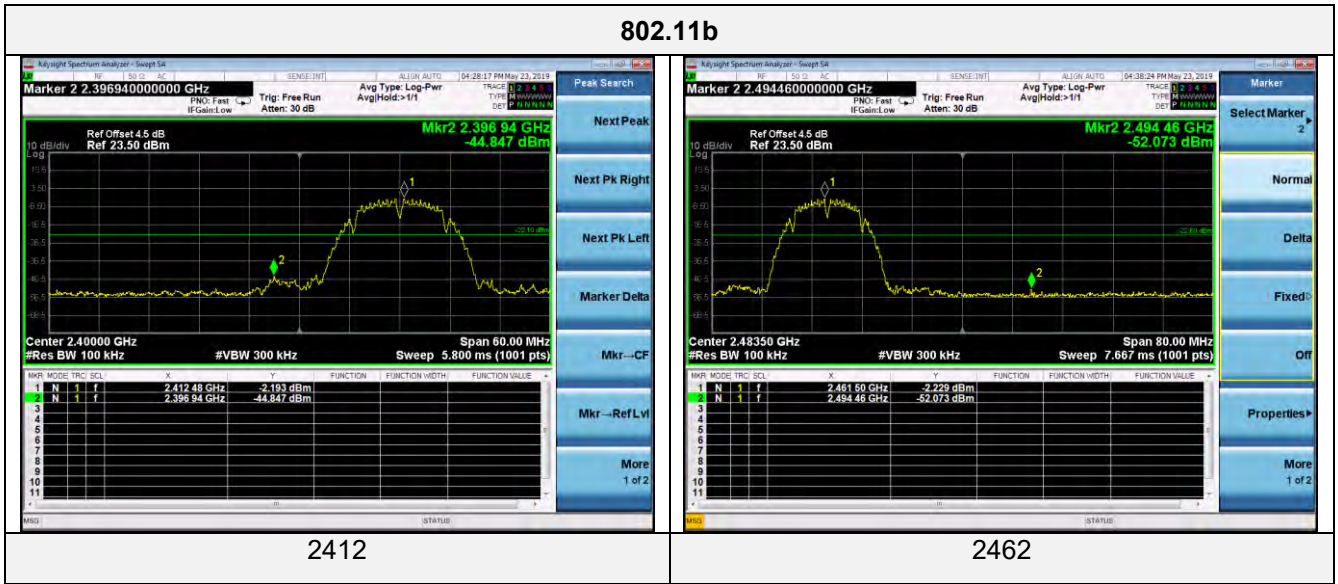

802.11n HT20

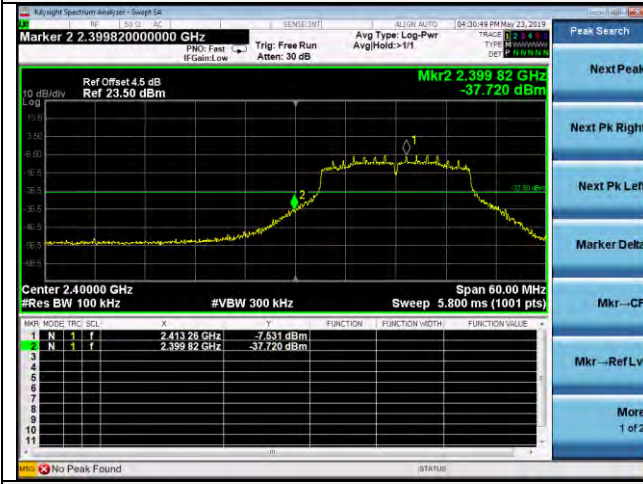

2412

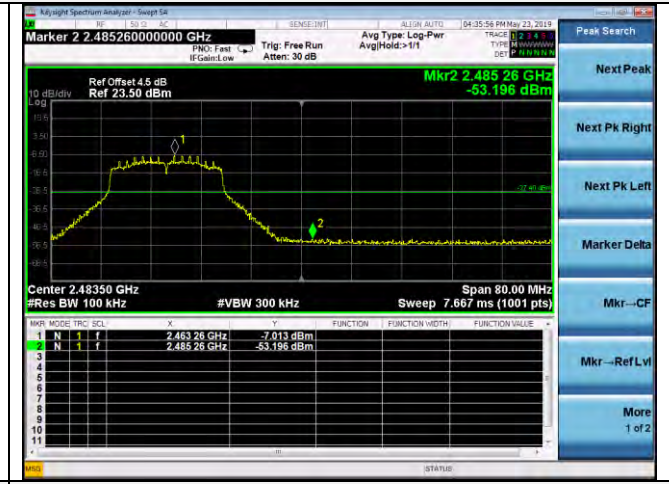

2462

802.11n HT40

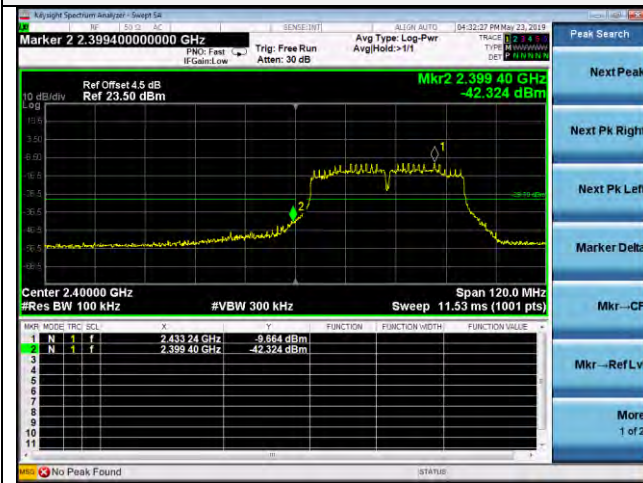

2422

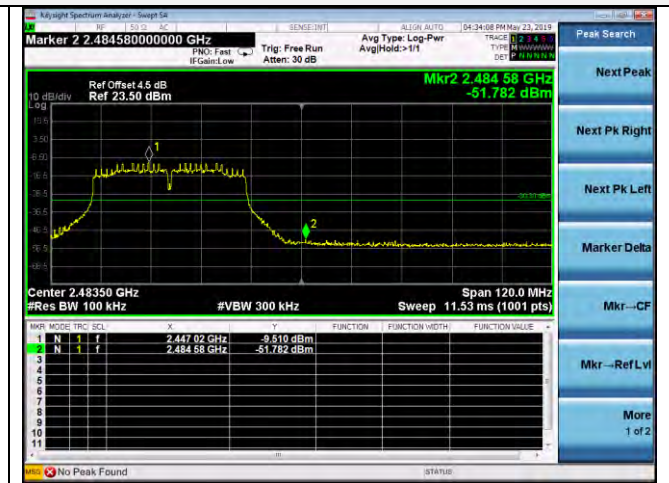

2452

Antenna 1

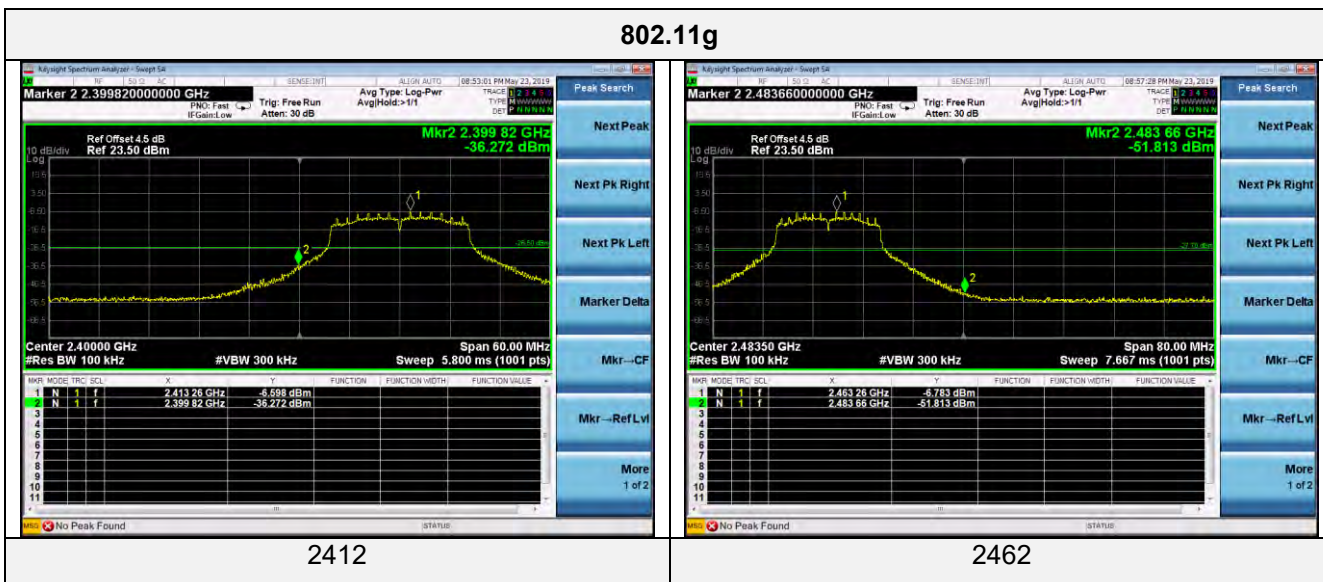
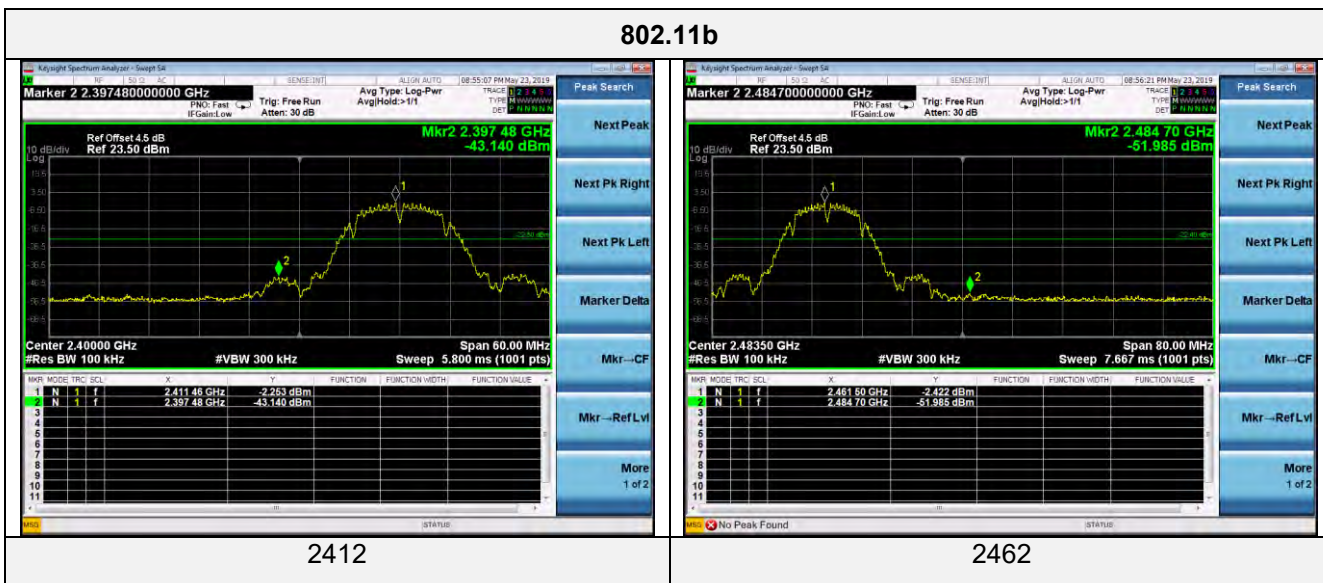

802.11n HT20

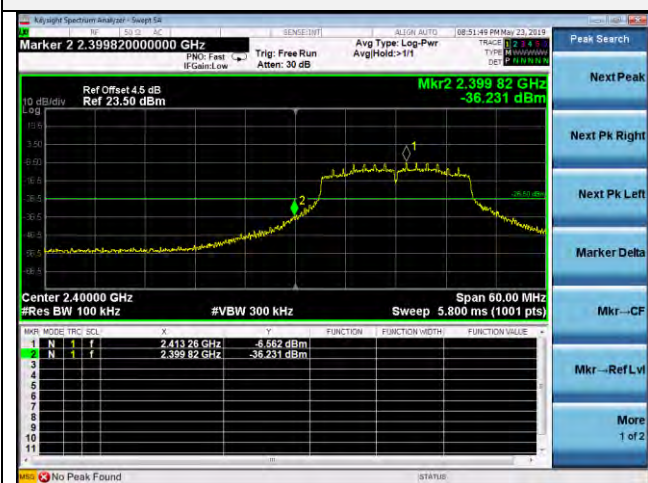

2412

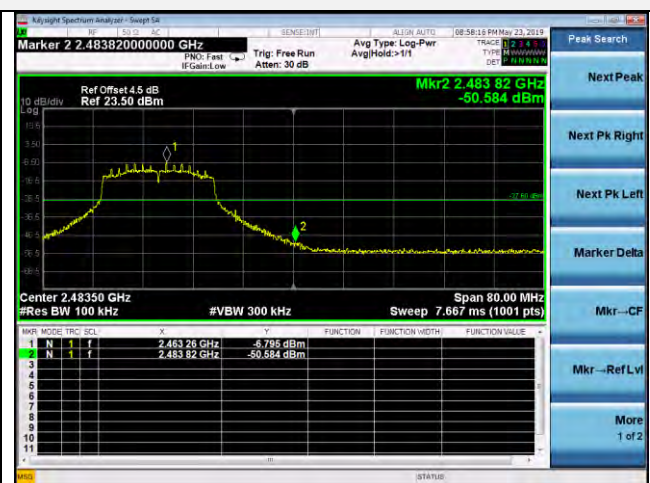

2462

802.11n HT40

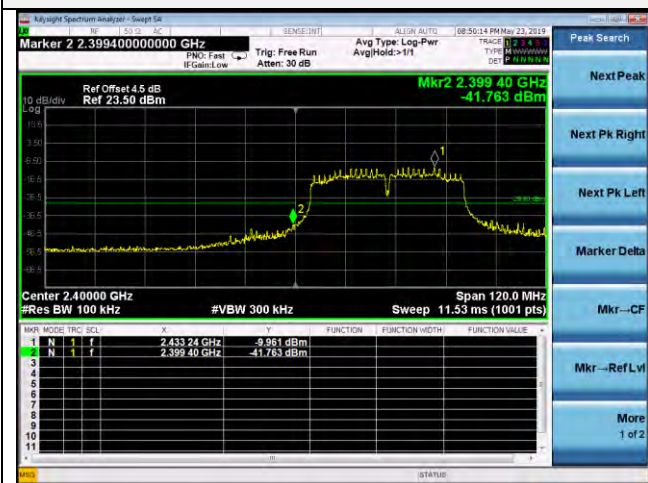

2422

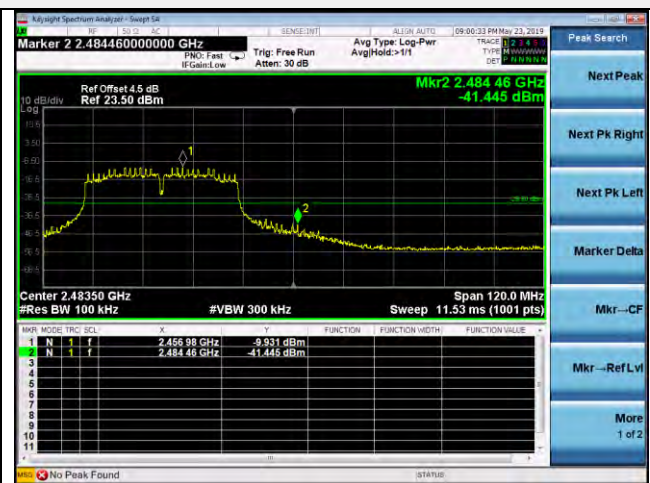

2452

4.7. Antenna Requirement

Standard Applicable

For intentional device, according to FCC 47 CFR Section 15.203, an intentional radiator shall be designed to ensure that no antenna other than that furnished by the responsible party shall be used with the device.

And according to FCC 47 CFR Section 15.247 (c), if transmitting antennas of directional gain greater than 6dBi are used, the power shall be reduced by the amount in dB that the directional gain of the antenna exceeds 6dBi.

Antenna Information

The antenna is FPC antenna, through the buckle stretched out, The directional gains of antenna used for transmitting is 1.11dBi.

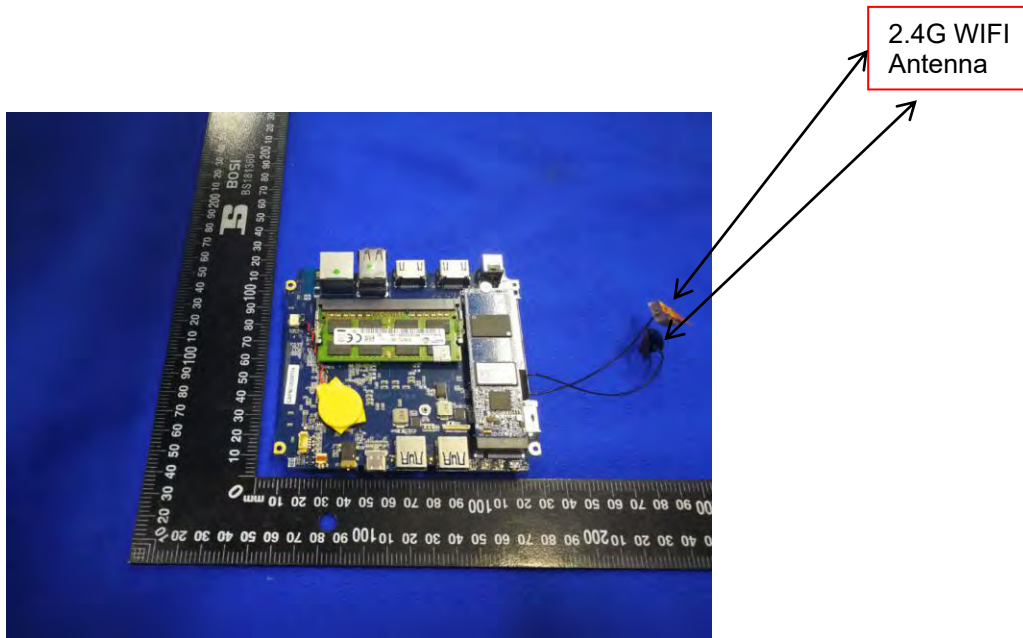

5. Test Setup Photos of the EUT

Radiated



conducted



6. External and Internal Photos of the EUT

Reference to the test report No. GTS20190329001-1-23

.....**End of Report**.....