

26dB Bandwidth

802.11ac40

802.11ac80

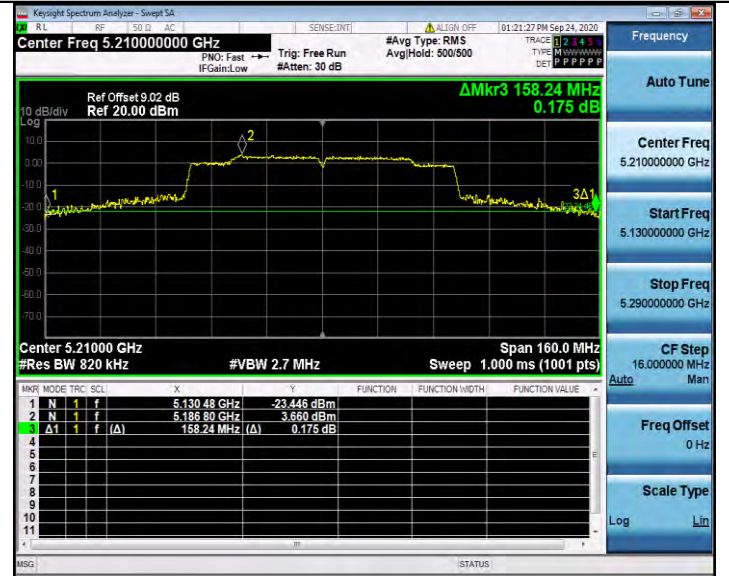

CH38

CH42

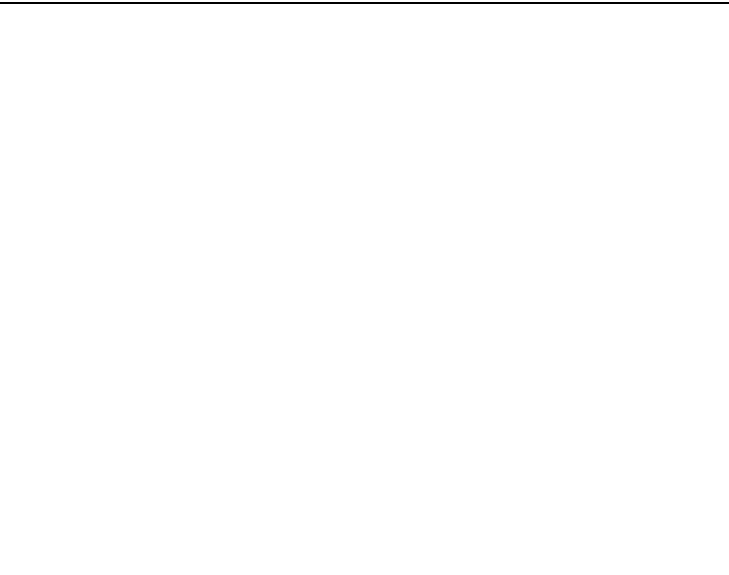
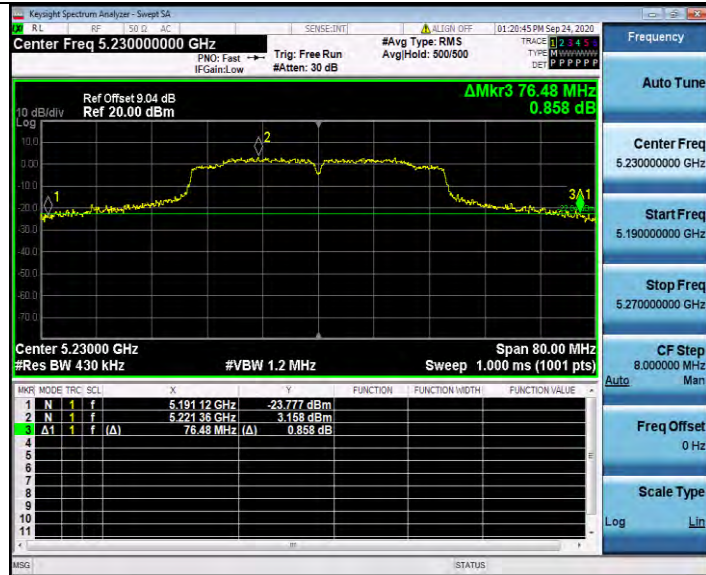

CH46

Antenna 1:

99%Bandwidth

802.11a

802.11n HT20



CH36

CH36

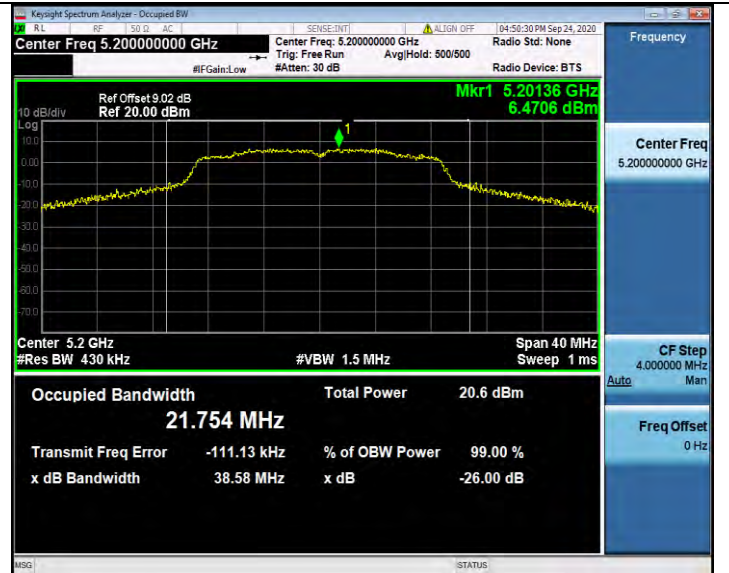

CH40

CH40



CH48

CH48

99%Bandwidth

802.11ac20

802.11n HT40



CH36

CH38



CH40

CH46

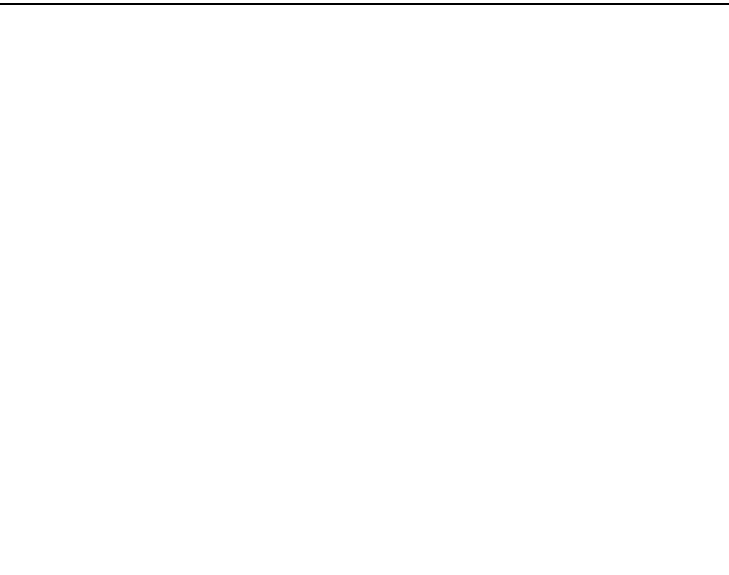
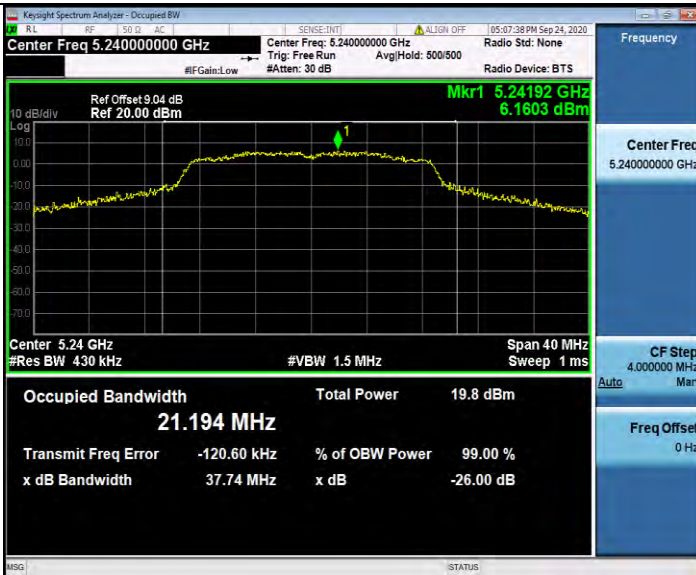

CH48

99%Bandwidth

802.11ac40

802.11ac80



CH38

CH42



CH46

26dB Bandwidth

802.11a

802.11n HT20



CH36

CH36



CH40

CH40



CH48

CH48

26dB Bandwidth

802.11ac20

802.11n HT40

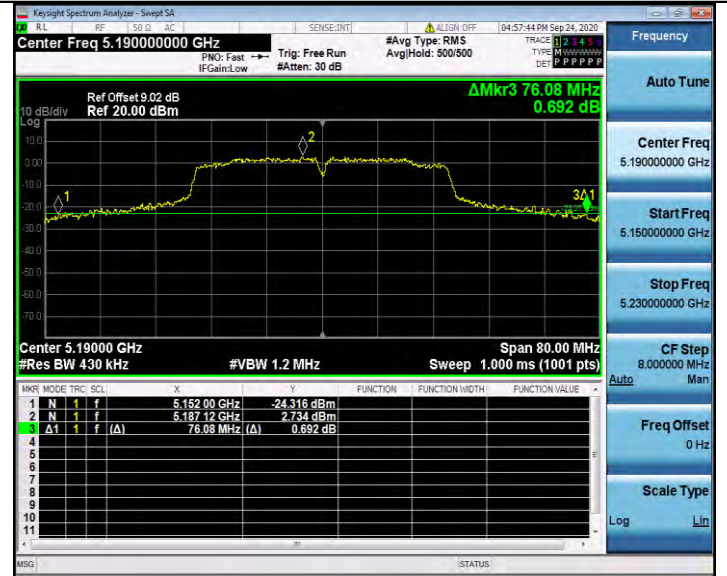
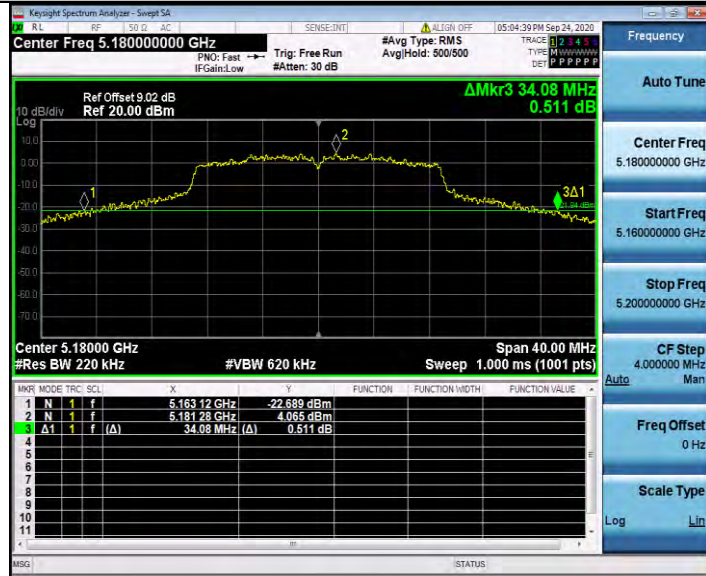

CH36

CH38

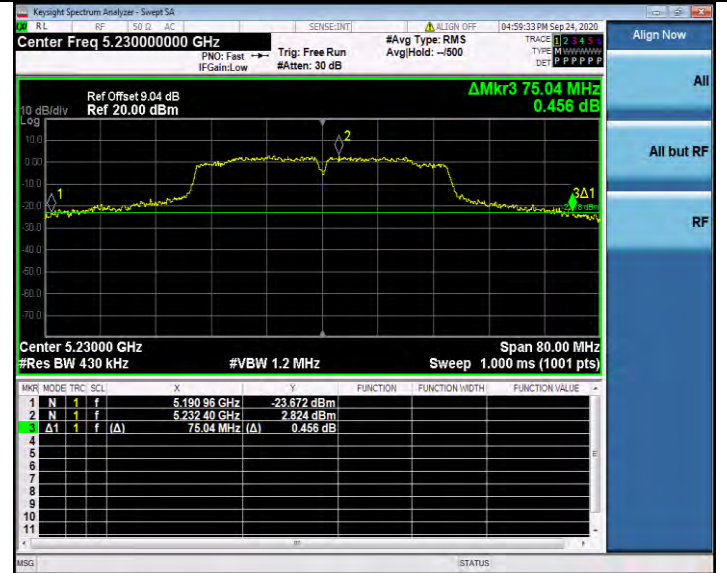

CH40

CH46



CH48

26dB Bandwidth

802.11ac40

802.11ac80

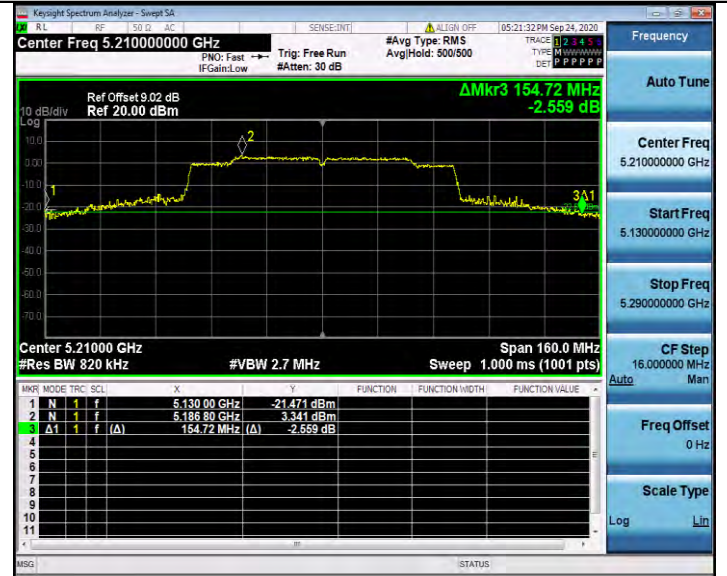
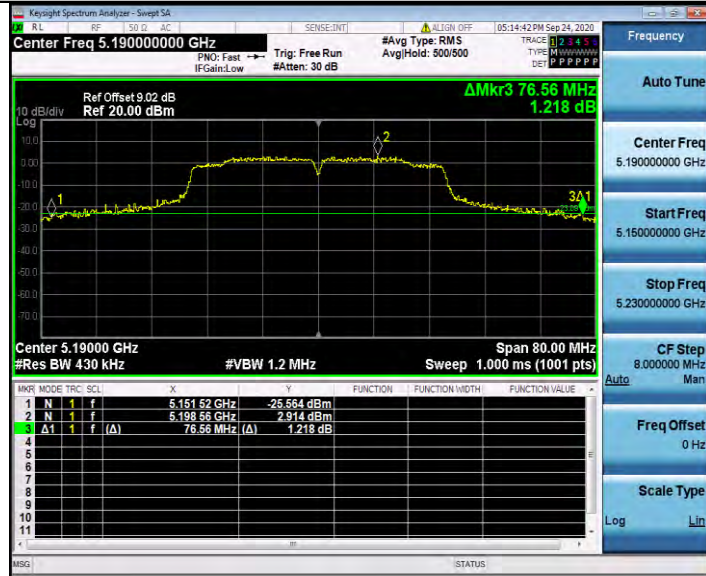

CH38

CH42

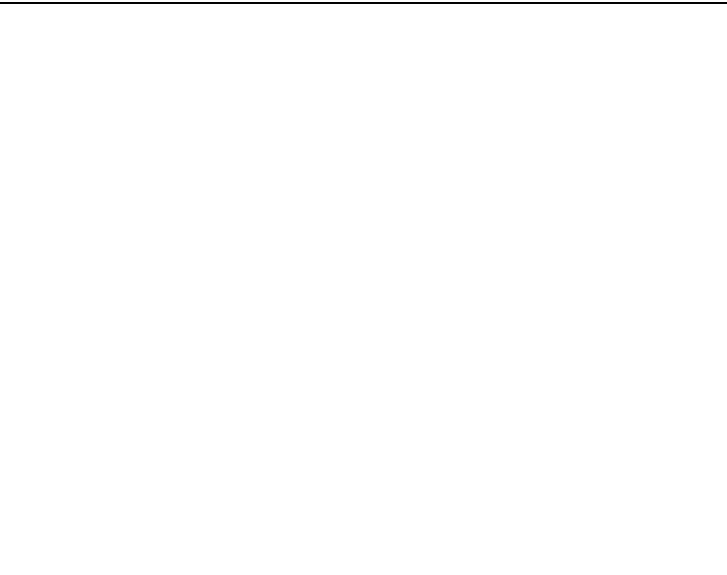
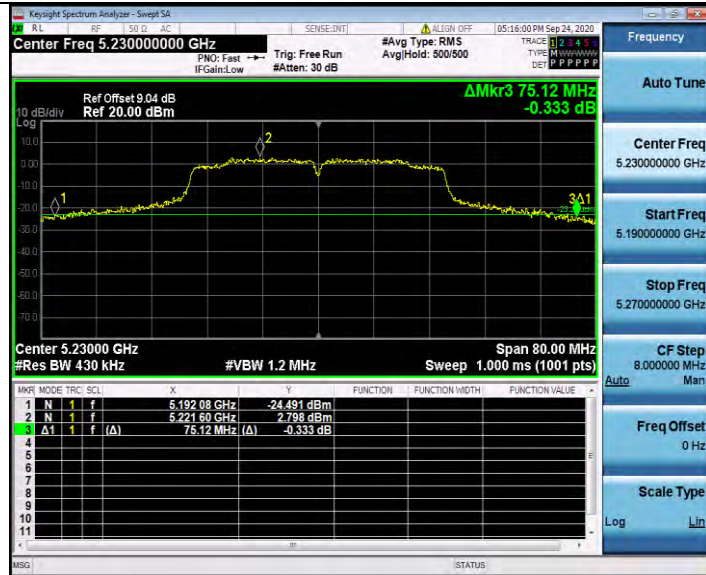

CH46

### 4.8. Band Edge Compliance

#### TEST CONFIGURATION

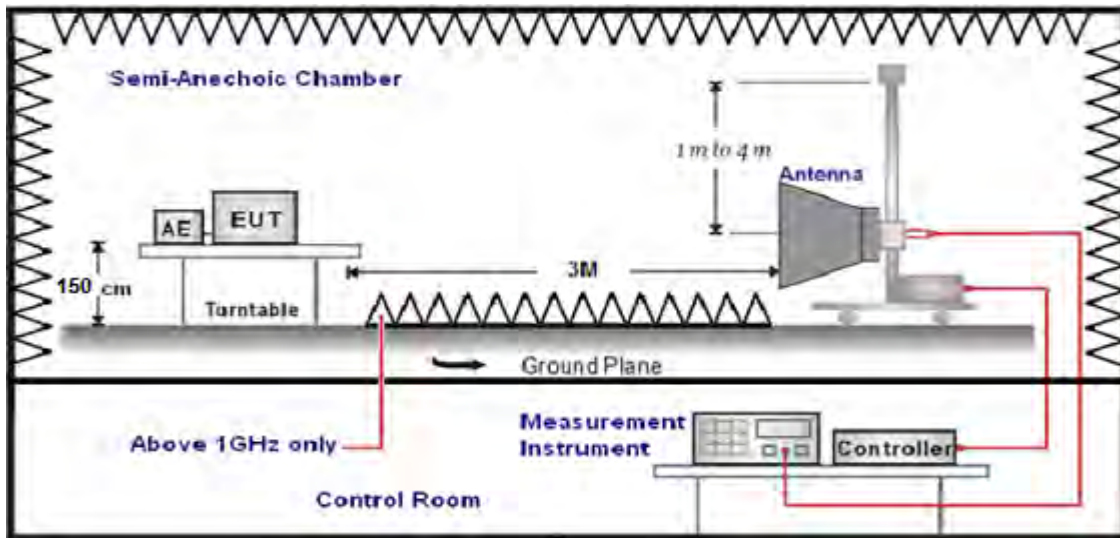

#### LIMIT

20dBc in any 100 kHz bandwidth outside the operating frequency band. In case the emission fall within the restricted band specified on 15.205(a), then the 15.209(a) limit in the table below has to be followed.

Frequency (MHz)	Distance (Meters)	Radiated (dBµV/m)	Radiated (µV/m)
0.009-0.49	3	$20\log(2400/F(KHz))+40\log(300/3)$	$2400/F(KHz)$
0.49-1.705	3	$20\log(24000/F(KHz))+ 40\log(30/3)$	$24000/F(KHz)$
1.705-30	3	$20\log(30)+ 40\log(30/3)$	30
30-88	3	40.0	100
88-216	3	43.5	150
216-960	3	46.0	200
Above 960	3	54.0	500

According to §15.407 (b): Except as shown in paragraph (b)(7) of this section, the maximum emissions outside of the frequency bands of operation shall be attenuated in accordance with the following limits

Frequency (MHz)	EIRP Limit (dBm)	Equivalent Field Strength at 3m (dBµV/m)
5150-5250	-27	68.2
5250-5350	-27	68.2
5470-5725	-27	68.2
5725-5850	-27 (beyond 10MHz of the bandedge)	68.2
	-17 (within 10 MHz of band edge)	78.2

#### TEST PROCEDURE

1. The EUT was placed on a turn table which is 1.5m above 1GHz.
2. Maximum procedure was performed by raising the receiving antenna from 1m to 4m and rotating the turn table from 0° to 360° to acquire the highest emissions from EUT.
3. And also, each emission was to be maximized by changing the polarization of receiving antenna both horizontal and vertical.
4. Repeat above procedures until all frequency measurements have been completed..
5. The distance between test antenna and EUT as following table states:

Test Frequency range	Test Antenna Type	Test Distance
1GHz-18GHz	Double Ridged Horn Antenna	3



6. Setting test receiver/spectrum as following table states:

Test Frequency range	Test Receiver/Spectrum Setting	Detector
1GHz-18GHz	Peak Value: RBW=1MHz/VBW=3MHz, Sweep time=Auto Average Value: RBW=1MHz/VBW=10Hz, Sweep time=Auto	Peak

**Field Strength Calculation**

The field strength is calculated by adding the Antenna Factor and Cable Factor and subtracting the Amplifier Gain and Duty Cycle Correction Factor(if any) from the measured reading. The basic equation with a sample calculation is as follows:

**FS = RA + AF + CL - AG**

Where FS = Field Strength	CL = Cable Attenuation Factor (Cable Loss)
RA = Reading Amplitude	AG = Amplifier Gain
AF = Antenna Factor	

**TEST RESULTS**

Remark:For radiated bandedge We measured at both mode, recorded worst case in antenna 0's 802.11 ac20 mode;

## For Radiated Bandedge Measurement

Temperature	23.4°C	Humidity	54.5%
Test Engineer	Moon Tan	Configurations	IEEE 802.11a/n/ac

**NOTE: We measured Radiated Emission at Antenna 0 & Antenna 1 mode from 1GHz to 25GHz and the worst case was recorded(Antenna 0).**

802.11 ac20/ Channel 36 :5180 MHz									
Freq (MHz)	Read Level (dBμV)	Antenna Factor (dB/m)	PRM Factor (dB)	Cable Loss (dB)	Result Level (dBμV/m)	Limit Line (dBμV/m)	Margin (dB)	Detector	Polarization
4500.0	35.21	35.58	29.04	8.28	50.03	74.00	-23.97	Peak	Horizontal
4500.0	30.10	35.58	29.04	8.28	44.92	54.00	-9.08	AV	Horizontal
5150.0	39.02	35.58	29.04	8.28	53.84	74.00	-20.16	Peak	Horizontal
5150.0	30.72	35.58	29.04	8.28	45.54	54.00	-8.46	AV	Horizontal

802.11 ac20/ Channel 48 :5240 MHz									
Freq (MHz)	Read Level (dBμV)	Antenna Factor (dB/m)	PRM Factor (dB)	Cable Loss (dB)	Result Level (dBμV/m)	Limit Line (dBμV/m)	Margin (dB)	Detector	Polarization
5350.0	35.14	35.42	29.06	8.39	49.89	74.00	-24.11	Peak	Horizontal
5350.0	30.26	35.42	29.06	8.39	45.01	54.00	-8.99	AV	Horizontal
5460.0	39.28	35.42	29.06	8.39	54.03	74.00	-19.97	Peak	Horizontal
5460.0	30.56	35.42	29.06	8.39	45.31	54.00	-8.69	AV	Horizontal

802.11 ac20/ Channel 149 :5745 MHz									
Freq (MHz)	Read Level (dBμV)	Antenna Factor (dB/m)	PRM Factor (dB)	Cable Loss (dB)	Result Level (dBμV/m)	Limit Line (dBμV/m)	Margin (dB)	Detector	Polarization
5650.0	30.06	35.35	29.07	8.43	44.77	68.20	-23.43	Peak	Horizontal
5700.0	30.15	35.35	29.07	8.43	44.86	68.20	-23.34	Peak	Horizontal
5720.0	32.27	35.35	29.07	8.43	46.98	68.20	-21.22	Peak	Horizontal
5725.0	30.53	35.35	29.07	8.43	45.24	68.20	-22.96	Peak	Horizontal

802.11 ac20/ Channel 165 :5825 MHz									
Freq (MHz)	Read Level (dBμV)	Antenna Factor (dB/m)	PRM Factor (dB)	Cable Loss (dB)	Result Level (dBμV/m)	Limit Line (dBμV/m)	Margin (dB)	Detector	Polarization
5850.0	30.24	35.3	29.11	8.51	44.94	68.20	-23.26	Peak	Horizontal
5855.0	30.29	35.3	29.11	8.51	44.99	68.20	-23.21	Peak	Horizontal
5875.0	32.23	35.3	29.11	8.51	46.93	68.20	-21.27	Peak	Horizontal
5925.0	30.72	35.3	29.11	8.51	45.42	68.20	-22.78	Peak	Horizontal

## REMARKS:

1. Result Level = Read Level + Antenna Factor + Cable loss - PRM Factor.
2. Margin value = Result Level-Limit value.
2. The other emission levels were very low against the limit.
3. The average measurement was not performed when the peak measured data under the limit of average detection.
4. Detector AV is setting spectrum/receiver. RBW=1MHz/VBW=10Hz/Sweep time=Auto/Detector=Peak;

For Conducted Band edge Measurement

Temperature	23.6°C	Humidity	55.7%
Test Engineer	Moon Tan	Configurations	IEEE 802.11a/n/ac

The test results have included the antenna gain

Antenna 0:  
5150-5250MHz:

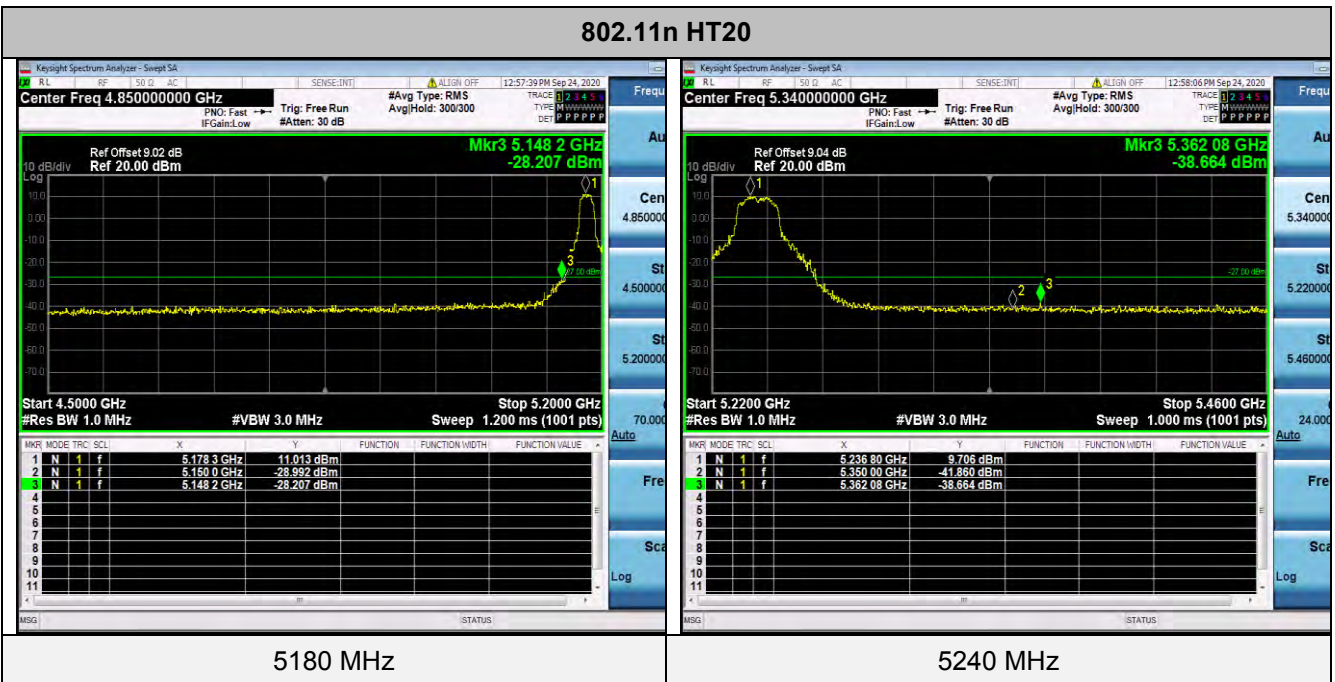
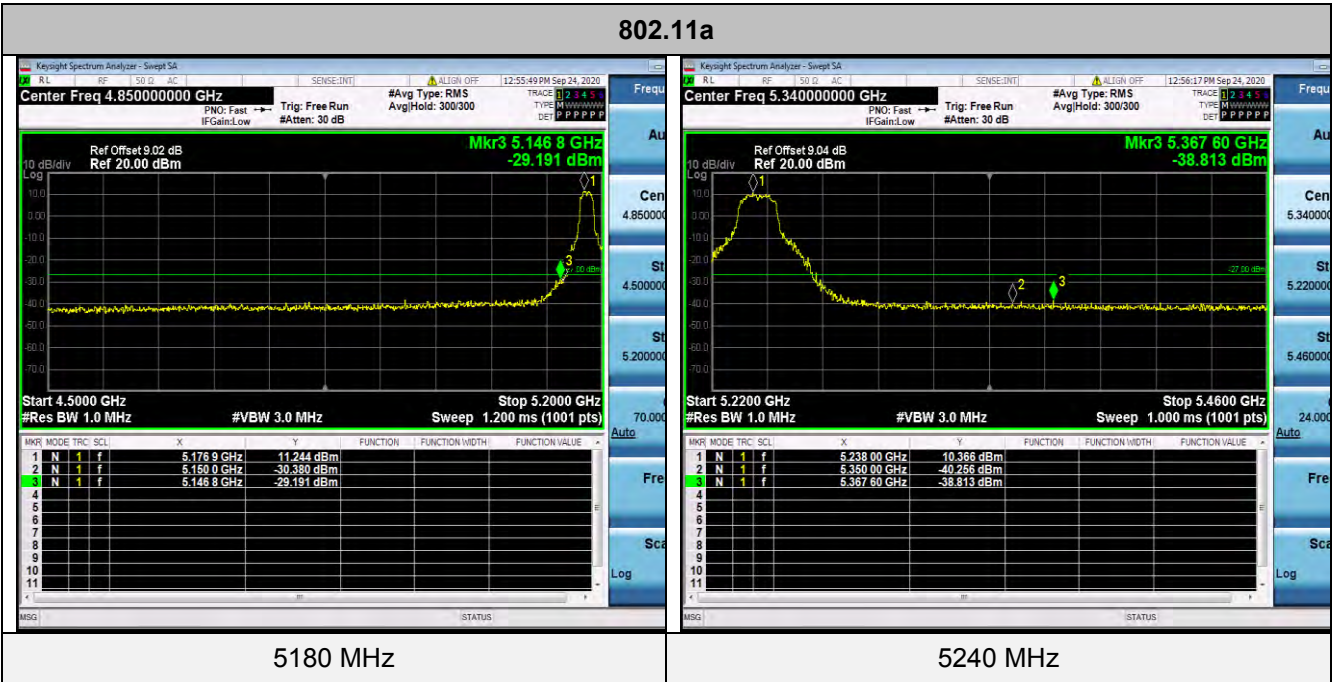

802.11ac20



5180 MHz

5240 MHz

802.11n HT40



5190 MHz

5230 MHz

802.11ac40

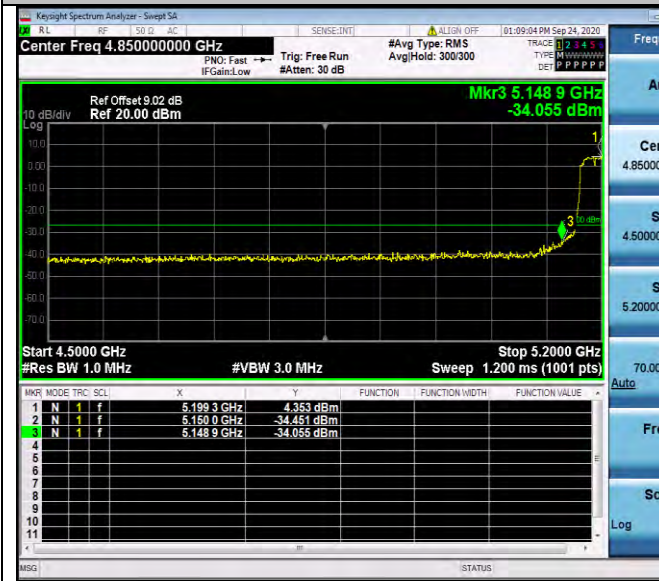

5190 MHz



5230 MHz

802.11ac80

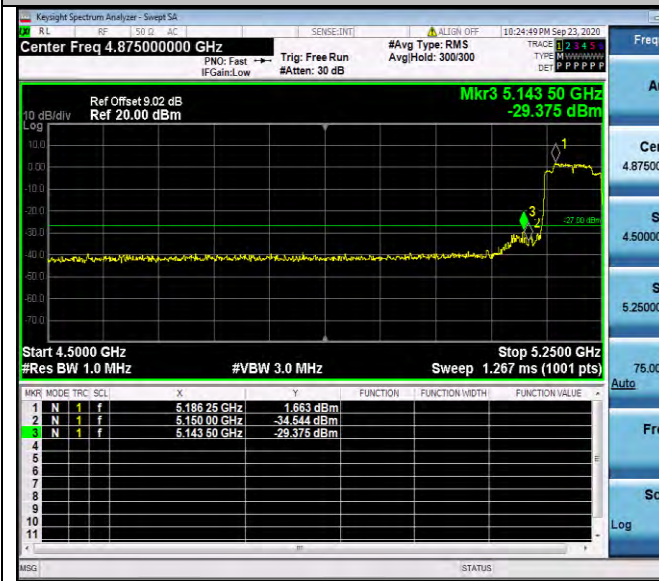

5210 MHz



5210 MHz

5725-5850MHz:

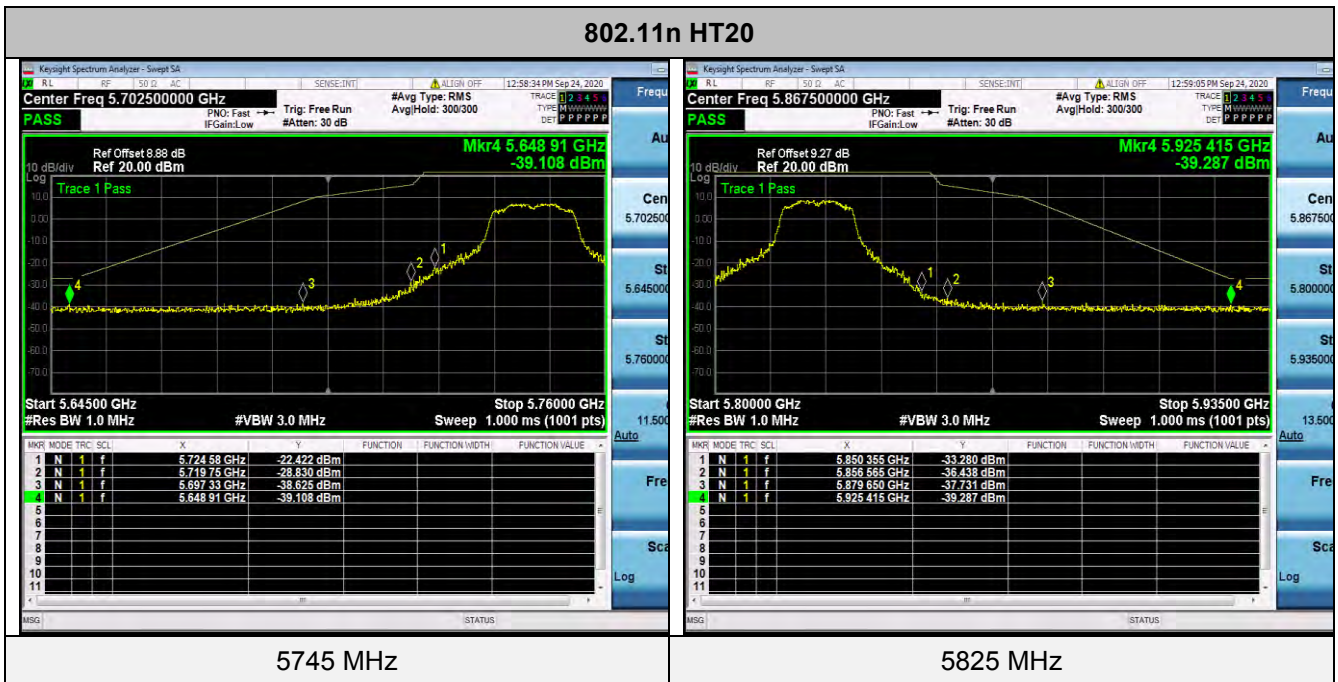

802.11ac20

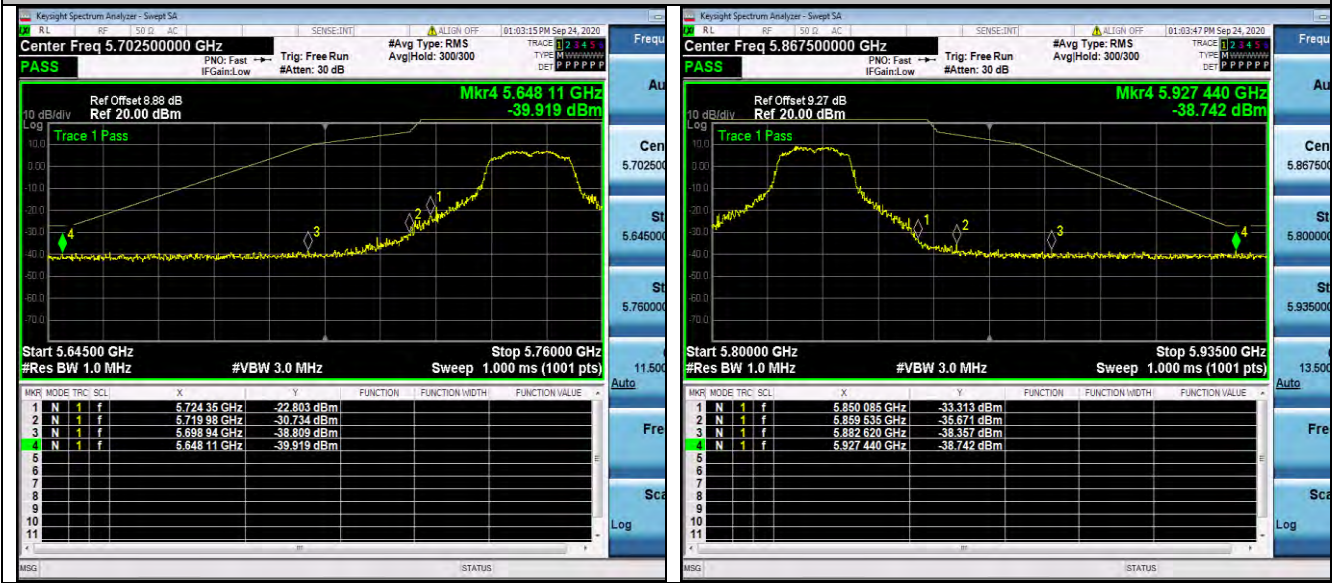

5745 MHz

5825 MHz

802.11n HT40



5755 MHz

5795 MHz

802.11ac40

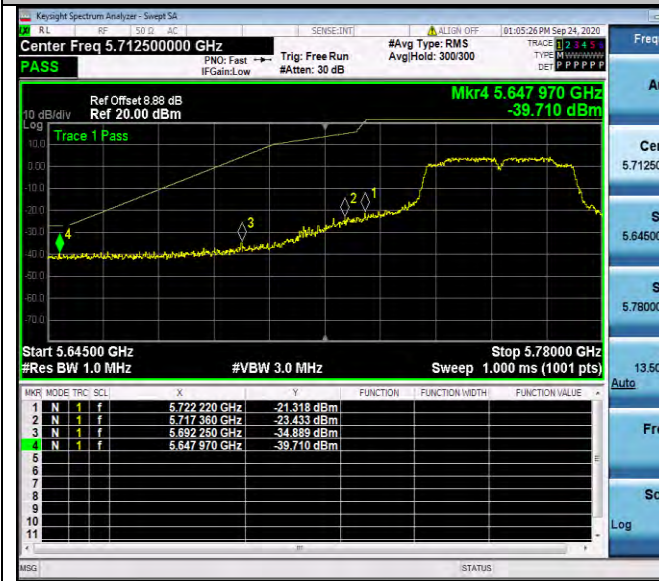

5755 MHz



5795 MHz

802.11ac80

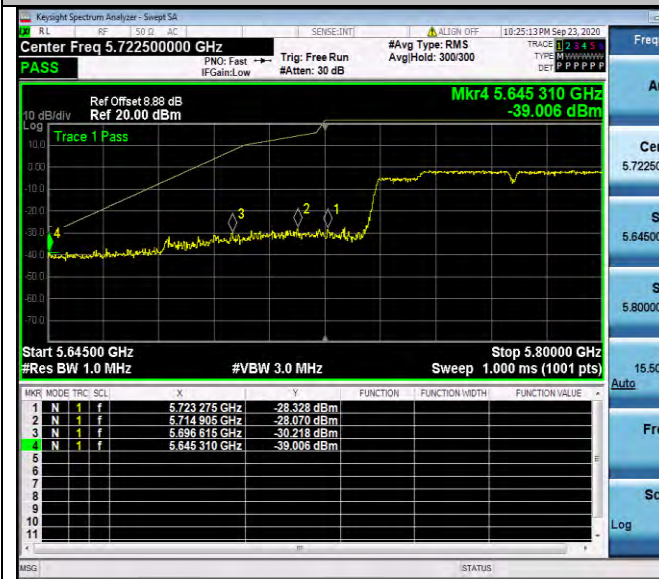

5775 MHz



5775 MHz



Antenna 1:  
5150-5250MHz:

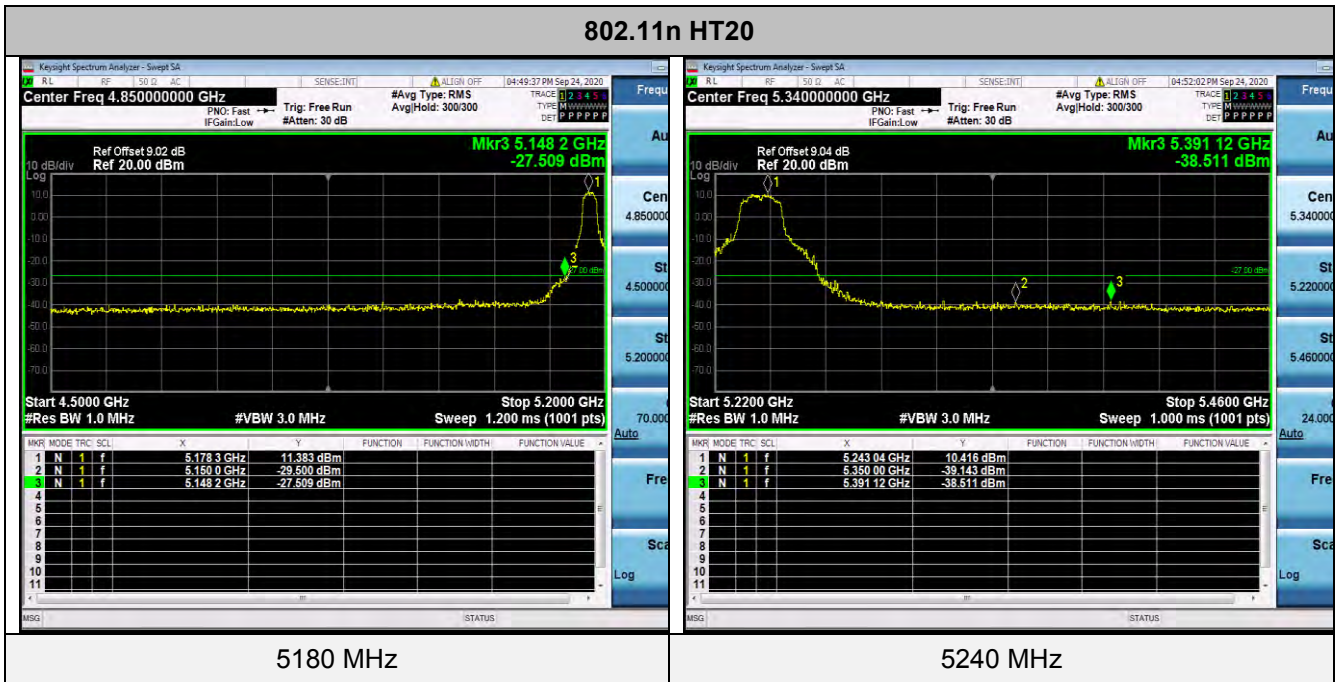
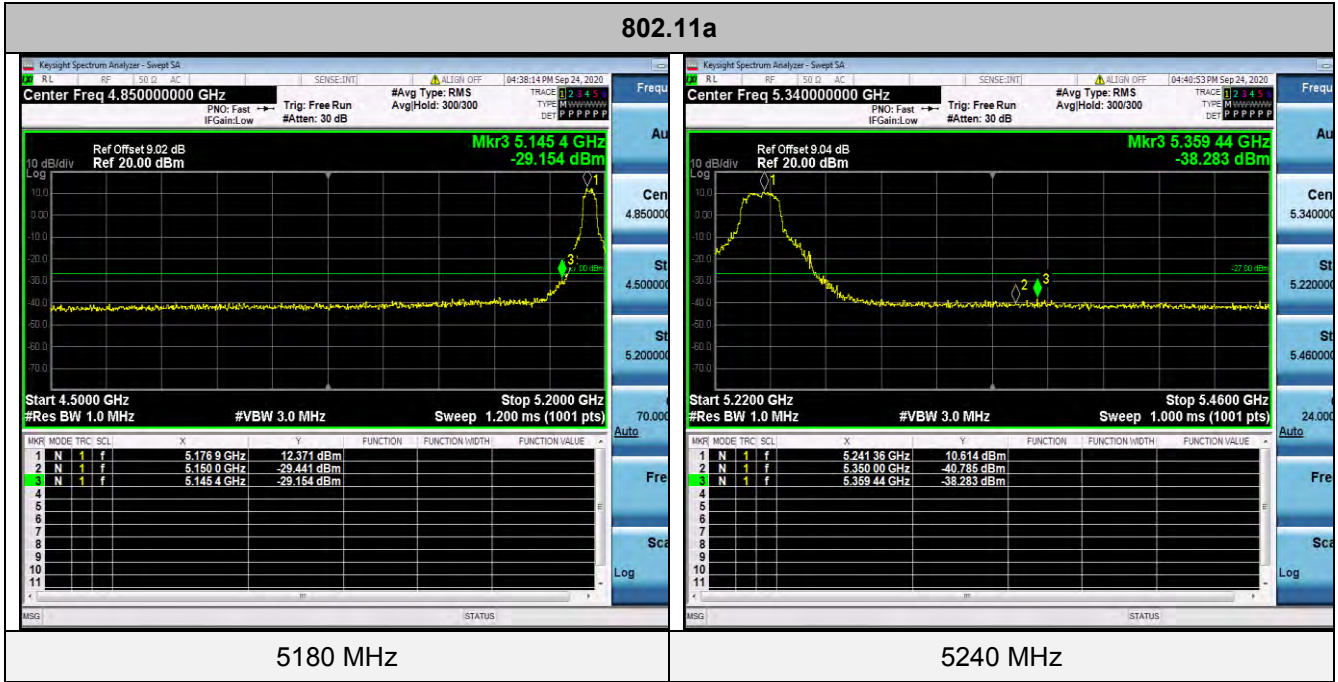

802.11ac20



5180 MHz

5240 MHz

802.11n HT40



5190 MHz

5230 MHz

802.11ac40

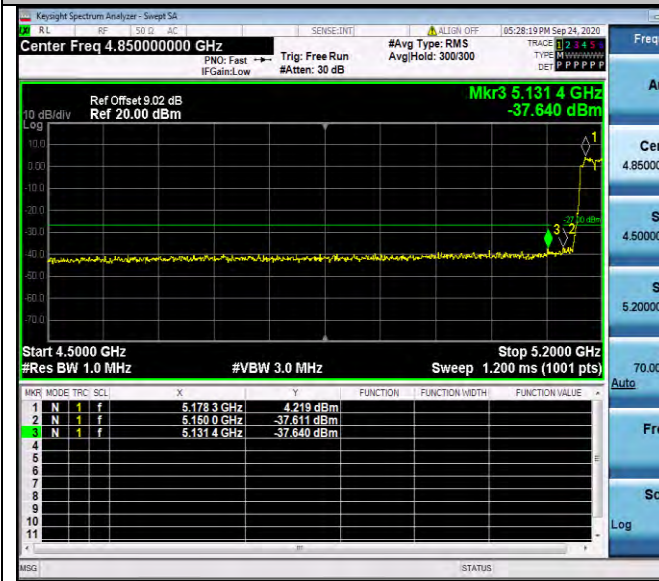

5190 MHz

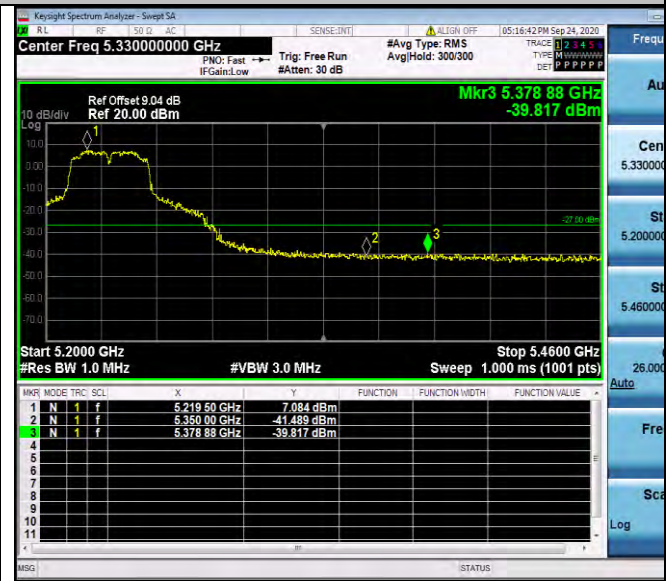

5230 MHz

802.11ac80

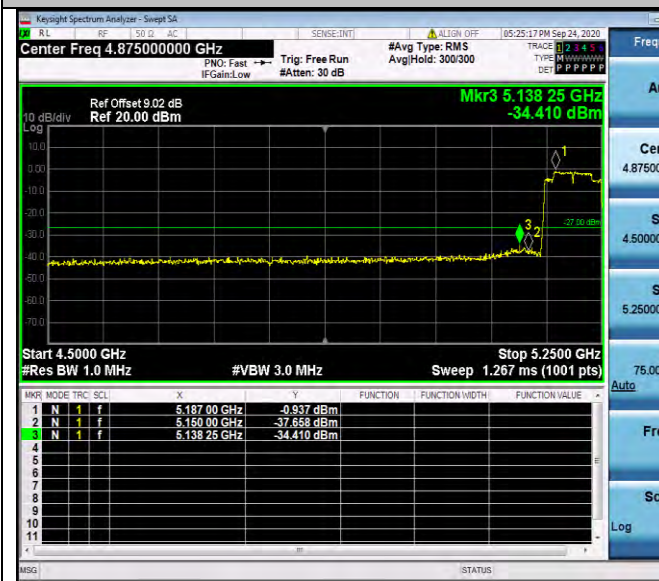

5210 MHz



5210 MHz

5725-5850MHz:

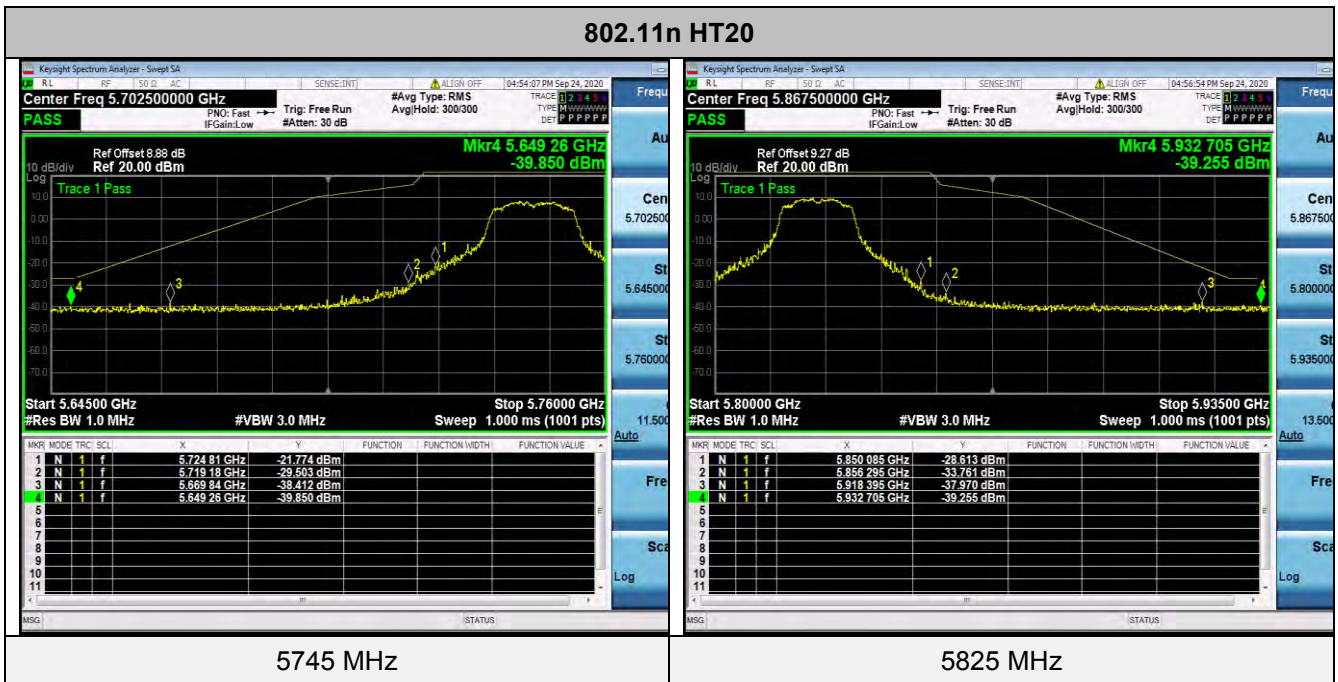
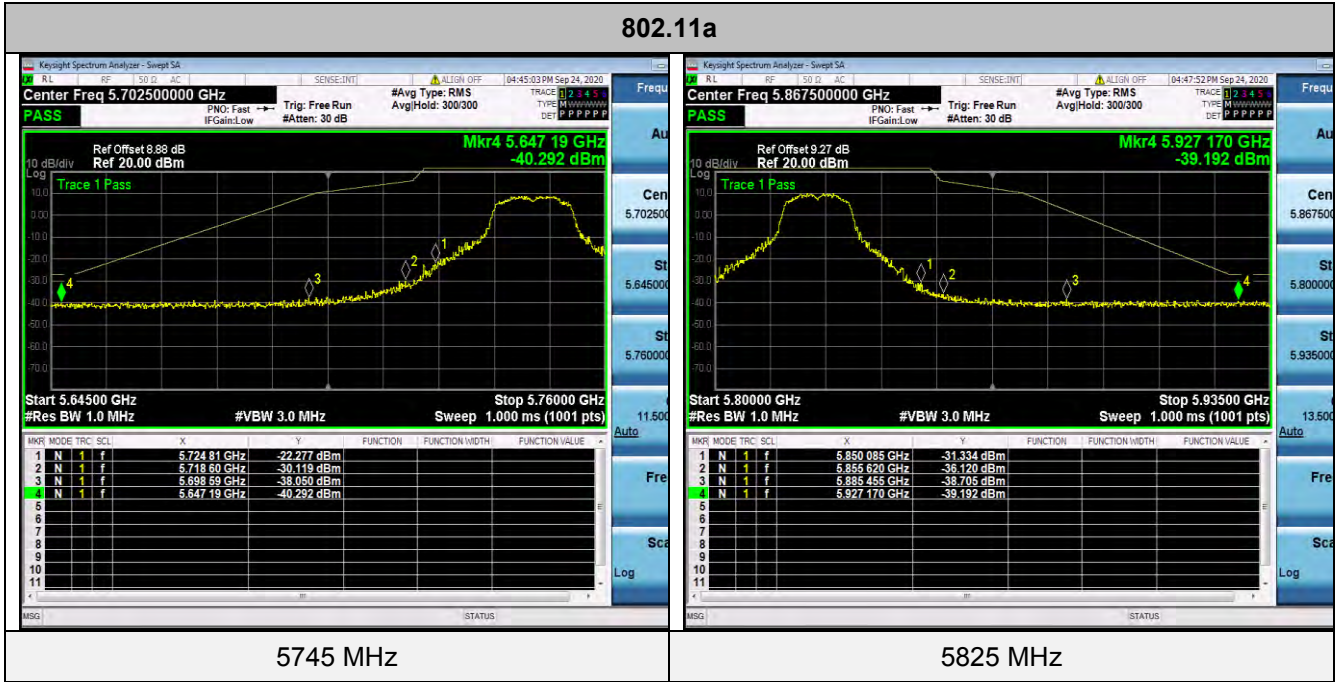

802.11ac20

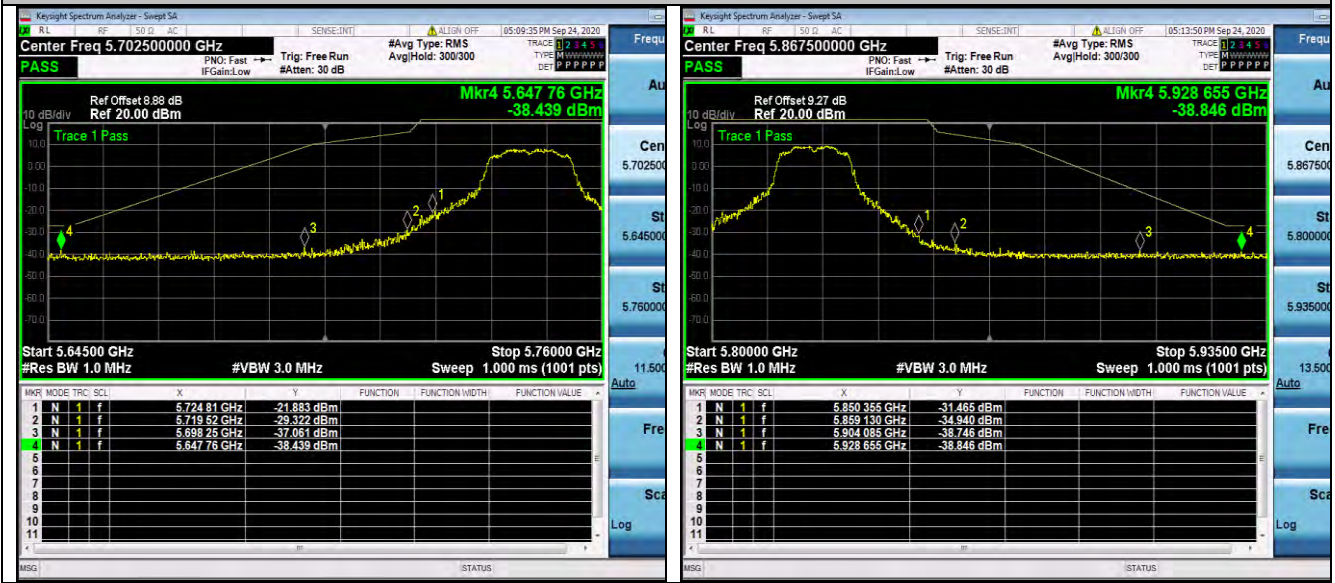

5745 MHz

5825 MHz

802.11n HT40



5755 MHz

5795 MHz

802.11ac40

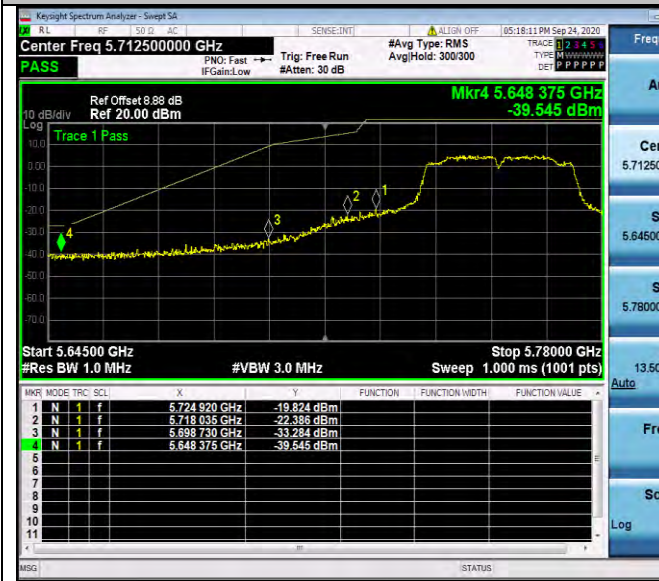

5755 MHz



5795 MHz

802.11ac80



5775 MHz



5775 MHz

## 4.9. Frequency Stability

### Standard Applicable

According to FCC §15.407(g) “Manufacturers of U-NII devices are responsible for ensuring frequency stability such that an emission is maintained within the band of operation under all conditions of normal operation as specified in the user manual.”

According to FCC §2.1055(a) “The frequency stability shall be measured with variation of ambient temperature as follows:”

(1) From -30° to + 50° centigrade for all equipment except that specified in paragraphs (a) (2) and (3) of this section.

(2) From -20° to + 50° centigrade for equipment to be licensed for use in the Maritime Services under part 80 of this chapter, except for Class A, B, and S Emergency Position Indicating Radiobeacons (EPIRBS), and equipment to be licensed for use above 952 MHz at operational fixed stations in all services, stations in the Local Television Transmission Service and Point-to-Point Microwave Radio Service under part 21 of this chapter, equipment licensed for use aboard aircraft in the Aviation Services under part 87 of this chapter, and equipment authorized for use in the Family Radio Service under part 95 of this chapter.

(3) From 0° to + 50° centigrade for equipment to be licensed for use in the Radio Broadcast Services under part 73 of this chapter.

### Test Configuration

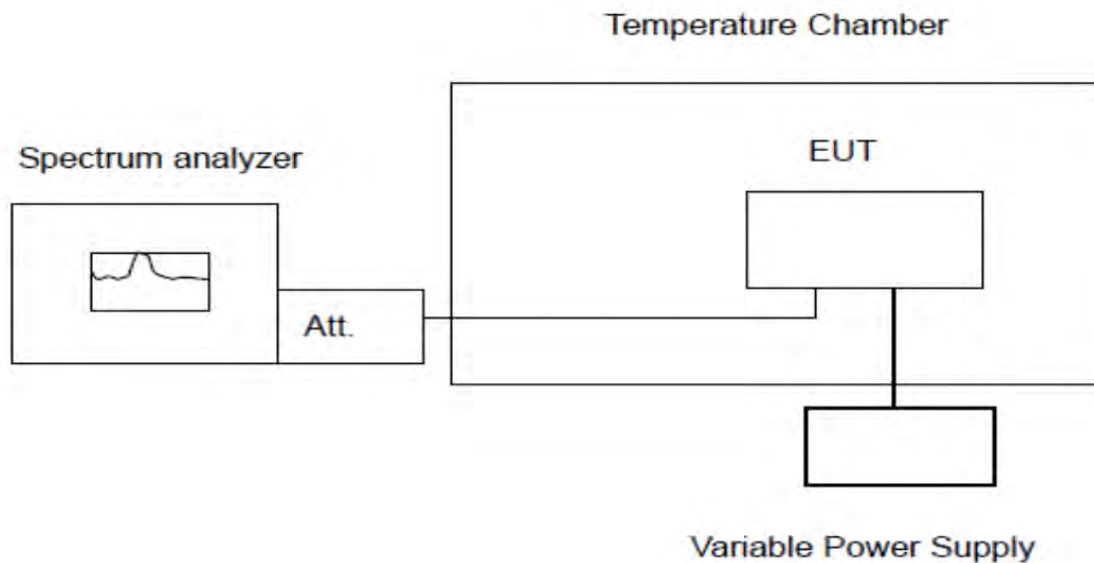

### Test Procedure

The equipment under test was connected to an external AC or DC power supply and input rated voltage. RF output was connected to a frequency counter or spectrum analyzer via feed through attenuators. The EUT was placed inside the temperature chamber. Set the spectrum analyzer RBW low enough to obtain the desired frequency resolution and measure EUT 20 degree operating frequency as reference frequency. Turn EUT off and set the chamber temperature to -30 degree. After the temperature stabilized for approximately 30 minutes recorded the frequency. Repeat step measure with 10 degree increased per stage until the highest temperature of +50 degree reached.

### Test Results

PASS

Remark:

1. Measured all conditions and recorded worst case.

IEEE 802.11a Mode / 5180 – 5240 MHz / 5180 MHz

Environment Temperature (Degree)	Voltage (V)	Measured Frequency (MHz)	Limit Range (MHz)	Test Results
20	DC 8.36V	5180.003	5150 – 5250	PASS
20	DC 6.84V	5180.014	5150 – 5250	PASS
50	DC 7.6V	5179.998	5150 – 5250	PASS
40	DC 7.6V	5180.011	5150 – 5250	PASS
30	DC 7.6V	5179.967	5150 – 5250	PASS
20	DC 7.6V	5179.995	5150 – 5250	PASS
10	DC 7.6V	5179.990	5150 – 5250	PASS
0	DC 7.6V	5180.024	5150 – 5250	PASS
-10	DC 7.6V	5180.019	5150 – 5250	PASS
-20	DC 7.6V	5179.977	5150 – 5250	PASS
-30	DC 7.6V	5180.115	5150 – 5250	PASS

IEEE 802.11a Mode / 5180 – 5240 MHz / 5240 MHz

Environment Temperature (Degree)	Voltage (V)	Measured Frequency (MHz)	Limit Range (MHz)	Test Results
20	DC 8.36V	5240.002	5150 – 5250	PASS
20	DC 6.84V	5239.995	5150 – 5250	PASS
50	DC 7.6V	5239.991	5150 – 5250	PASS
40	DC 7.6V	5239.991	5150 – 5250	PASS
30	DC 7.6V	5239.999	5150 – 5250	PASS
20	DC 7.6V	5239.969	5150 – 5250	PASS
10	DC 7.6V	5240.019	5150 – 5250	PASS
0	DC 7.6V	5240.027	5150 – 5250	PASS
-10	DC 7.6V	5239.979	5150 – 5250	PASS
-20	DC 7.6V	5240.019	5150 – 5250	PASS
-30	DC 7.6V	5240.136	5150 – 5250	PASS



IEEE 802.11a Mode / 5745 – 5825 MHz / 5745 MHz

Environment Temperature (Degree)	Voltage (V)	Measured Frequency (MHz)	Limit Range (MHz)	Test Results
20	DC 8.36V	5744.979	5725 – 5850	PASS
20	DC 6.84V	5744.955	5725 – 5850	PASS
50	DC 7.6V	5745.004	5725 – 5850	PASS
40	DC 7.6V	5745.005	5725 – 5850	PASS
30	DC 7.6V	5745.008	5725 – 5850	PASS
20	DC 7.6V	5744.999	5725 – 5850	PASS
10	DC 7.6V	5745.014	5725 – 5850	PASS
0	DC 7.6V	5744.988	5725 – 5850	PASS
-10	DC 7.6V	5745.036	5725 – 5850	PASS
-20	DC 7.6V	5745.032	5725 – 5850	PASS
-30	DC 7.6V	5475.158	5725 – 5850	PASS

IEEE 802.11a Mode / 5745 – 5825 MHz / 5825 MHz

Environment Temperature (Degree)	Voltage (V)	Measured Frequency (MHz)	Limit Range (MHz)	Test Results
20	DC 8.36V	5825.022	5725 – 5850	PASS
20	DC 6.84V	5824.992	5725 – 5850	PASS
50	DC 7.6V	5824.983	5725 – 5850	PASS
40	DC 7.6V	5825.028	5725 – 5850	PASS
30	DC 7.6V	5825.021	5725 – 5850	PASS
20	DC 7.6V	5824.999	5725 – 5850	PASS
10	DC 7.6V	5825.040	5725 – 5850	PASS
0	DC 7.6V	5825.008	5725 – 5850	PASS
-10	DC 7.6V	5824.995	5725 – 5850	PASS
-20	DC 7.6V	5824.997	5725 – 5850	PASS
-30	DC 7.6V	5825.254	5725 – 5850	PASS

## 4.10. Antenna Requirement

### Standard Applicable

For intentional device, according to FCC 47 CFR Section 15.203, an intentional radiator shall be designed to ensure that no antenna other than that furnished by the responsible party shall be used with the device.

And according to FCC 47 CFR Section 15.407 (a), if transmitting antennas of directional gain greater than 6dBi are used, the power shall be reduced by the amount in dB that the directional gain of the antenna exceeds 6dBi.

### **Antenna Information**

The antenna is FPC antenna, through the buckle stretched out, The directional gains of antenna used for transmitting is 4.8dBi.

Reference to the Test Report: **GTS20200908004-1-11.**

**5. TEST SETUP PHOTOS OF THE EUT**

Reference to the test report No. GTS20200908004-1-11.

**6. EXTERNAL AND INTERNAL PHOTOS OF THE EUT**

Reference to the test report No. GTS20200908004-1-11.

.....**End of Report**.....