

## 天线规格书

### Antenna specification for approval

客户名称 Customer name	中柏		
机型 Model	S16-16 寸塑胶壳-卓创 G142K-MB 主板-3165 模块		
天线频段 Antenna frequency	2.4GHZ&5GHz		
天线功能 Antenna function	WIFI&BT&5Gwifi(副) 天线		
天线材质 Antenna material	FPC	FPC 颜色 FPC color	黑色
型号 model	SF2146B-1B2-A		
料号 Material number	SF2146B-1R24G-475-A		
客户料号 Customer Part Number			
索沃德承认签章 Ward accepted the signature		客户承认签章 Client acknowledges signature	
结构 structure	采购 Purchase		
文控 Document control	结构 structure		
射频 radio frequency	工程 engineering		
审核 To examine	品质 QC		
承办人 Responsible	审核 To examine		
日期 date 2023.01.03	盖章区 Seal area	日期 date 2023.01.03	盖章区 Seal area

**二:概述**

**(1)Antenna performance**

1. This approval sheet supports for MID project. FPC antennas include in this project. This report is for the performance of WIFI&BT antenna.
2. Antenna shape size: Meet the requirement of MID
3. Antenna band: 2.4GHz~5GHz
4. Antenna material: Antenna material meet the requirement of MID
5. Adhesive performance: Adhesive performance meet the requirement of MID
6. Antenna performance meet the spec below:

Description	2.4GHz~6GHz	Units
VSWR	≤2.0	
Average Antenna Gain	≥-4.5	dB
Antenna Efficiency	≥40	%
Feed Impedance	50 ohms	
Operating Temperature	-40 to +85 deg C	
Polarization / Azimuth	Linear / Omni-directional	

**(2)Mechanical Information**

Mechanical Dimension	
Cable Length	475mm/GRAY
Description	WIFI&BT antenna
Material	FPC
Coaxial Cable	50Ω/O. D. 0.81mm
Environmental	
Operation Temperature	-40 to +85 deg C
Storage Temperature	-40 to +85 deg C

## 三: 匹配电路图&机器图片&天线图片

### (1) Matching circuit

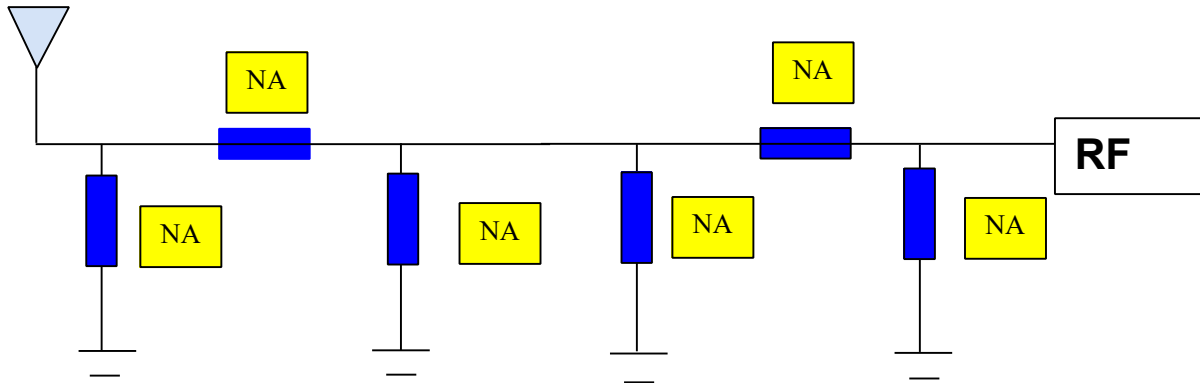



### 四: Standing wave ratio and Gain



Passive Test For 2.4G				Passive Test For 5G			
Freq	Effi	Effi	Gain	Freq	Effi	Effi	Gain
(MHz)	(%)	(dB)	(dBi)	(MHz)	(%)	(dB)	(dBi)
2400	38.52	-4.14	1.87	5000	44.25	-3.54	1.24
2410	35.95	-4.44	1.85	5100	43.74	-3.59	2.24
2420	39.55	-4.03	2.21	5200	41.61	-3.81	1.86
2430	40.9	-3.88	2.41	5300	49.36	-3.07	2.65
2440	44.76	-3.49	2.67	5400	42.45	-3.72	2.41
2450	46.29	-3.35	2.84	5500	43.07	-3.66	3.05
2460	41.85	-3.78	2.23	5600	46.43	-3.33	2.63
2470	36.71	-4.35	1.52	5700	48.49	-3.14	2.13
2480	34.99	-4.56	1.01	5800	49.83	-3.02	2.14
2490	34.45	-4.63	1.2	5900	48.64	-3.13	2.04
2500	32.54	-4.88	1.29	6000	46.55	-3.32	2.68



六:Environmental treatment

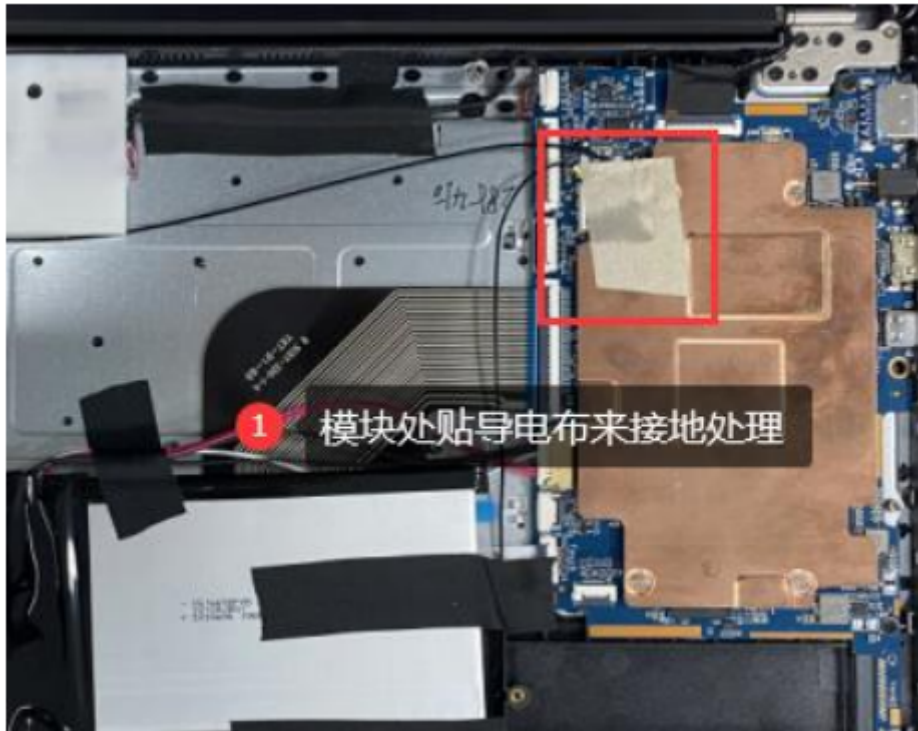

## 七:3D pattern

2400.000MHz

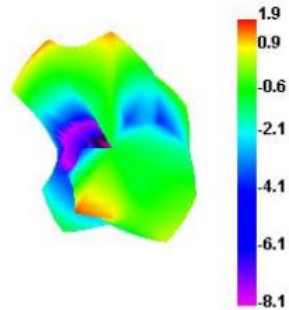

2450.000MHz

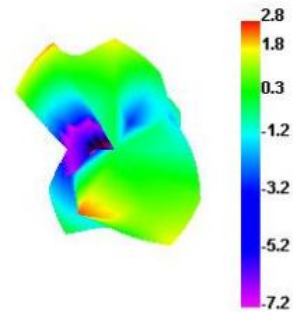

2500.000MHz

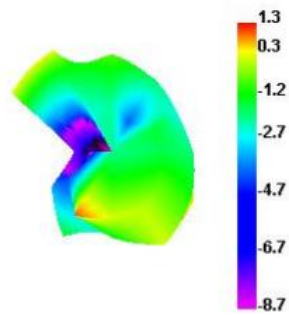

5000.000MHz

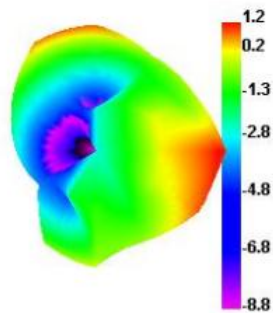

5500.000MHz

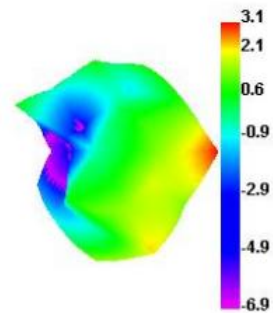

6000.000MHz

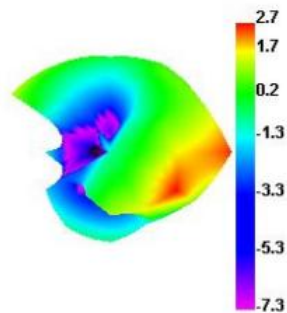

## 八:Antenna drawing



