

TEST REPORT

Applicant: Shenzhen Intellirocks Tech. Co., Ltd.

Address of Applicant: No.2901-2904, 3002, Block C, Section 1, Chuangzhi Yuncheng Building, Liuxian Avenue, Xili Community, Xili Street, Nanshan District, Shenzhen, Guangdong, China

Manufacturer: Shenzhen Intellirocks Tech. Co., Ltd.

Address of Manufacturer: No.2901-2904, 3002, Block C, Section 1, Chuangzhi Yuncheng Building, Liuxian Avenue, Xili Community, Xili Street, Nanshan District, Shenzhen, Guangdong, China

Equipment Under Test (EUT)

Product Name: Govee Aura Table Lamp

Model No.: H6052

FCC ID: 2AQA6-H6052

Applicable standards: FCC CFR Title 47 Part 15 Subpart C Section 15.247

Date of sample receipt: November 10, 2020

Date of Test: November 11, 2020-January 05, 2021

Date of report issued: January 05, 2021

Test Result : PASS *

* In the configuration tested, the EUT complied with the standards specified above.

Authorized Signature:

Robinson Luo
Laboratory Manager

This results shown in this test report refer only to the sample(s) tested, this test report cannot be reproduced, except in full, without prior written permission of the company. The report would be invalid without specific stamp of test institute and the signatures of compiler and approver.

2 Version

Version No.	Date	Description
00	January 05, 2021	Original

Prepared By:



Date:

January 05, 2021

Project Engineer

Check By:



Reviewer

Date:

January 05, 2021

3 Contents

	Page
1 COVER PAGE	1
2 VERSION	2
3 CONTENTS	3
4 TEST SUMMARY	4
5 GENERAL INFORMATION	5
5.1 GENERAL DESCRIPTION OF EUT	5
5.2 TEST MODE	7
5.3 DESCRIPTION OF SUPPORT UNITS	7
5.4 DEVIATION FROM STANDARDS	7
5.5 ABNORMALITIES FROM STANDARD CONDITIONS	7
5.6 TEST FACILITY	7
5.7 TEST LOCATION	7
5.8 ADDITIONAL INSTRUCTIONS	7
6 TEST INSTRUMENTS LIST	8
7 TEST RESULTS AND MEASUREMENT DATA	10
7.1 ANTENNA REQUIREMENT	10
7.2 CONDUCTED EMISSIONS	11
7.3 CONDUCTED OUTPUT POWER	14
7.4 CHANNEL BANDWIDTH	16
7.5 POWER SPECTRAL DENSITY	18
7.6 BAND EDGES	20
7.6.1 Conducted Emission Method	20
7.6.2 Radiated Emission Method	21
7.7 SPURIOUS EMISSION	24
7.7.1 Conducted Emission Method	24
7.7.2 Radiated Emission Method	26
8 TEST SETUP PHOTO	33
9 EUT CONSTRUCTIONAL DETAILS	33

4 Test Summary

Test Item	Section in CFR 47	Result
Antenna requirement	15.203/15.247 (c)	Pass
AC Power Line Conducted Emission	15.207	Pass
Conducted Output Power	15.247 (b)(3)	Pass
Channel Bandwidth	15.247 (a)(2)	Pass
Power Spectral Density	15.247 (e)	Pass
Band Edge	15.247(d)	Pass
Spurious Emission	15.205/15.209	Pass

Remarks:

1. Pass: The EUT complies with the essential requirements in the standard.
2. Test according to ANSI C63.10:2013

Measurement Uncertainty

Test Item	Frequency Range	Measurement Uncertainty	Notes
Radiated Emission	30MHz-200MHz	3.8039dB	(1)
Radiated Emission	200MHz-1GHz	3.9679dB	(1)
Radiated Emission	1GHz-18GHz	4.29dB	(1)
Radiated Emission	18GHz-40GHz	3.30dB	(1)
AC Power Line Conducted Emission	0.15MHz ~ 30MHz	3.44dB	(1)

Note (1): The measurement uncertainty is for coverage factor of k=2 and a level of confidence of 95%.

5 General Information

5.1 General Description of EUT

Product Name:	Govee Aura Table Lamp
Model No.:	H6052
Serial No.:	SYA371
Hardware version:	1.00.01
Software version:	1.00.05
Test sample(s) ID:	GTS202011000110-1
Sample(s) Status:	Engineer sample
Operation Frequency:	2402MHz~2480MHz
Channel Numbers:	40
Channel Separation:	2MHz
Modulation Type:	GFSK
Antenna Type:	PCB Antenna
Antenna Gain:	1.5dBi(Declare by applicant)
Power Supply:	Adapter Model No: CW1201000US Input: AC 100-240V, 50/60Hz, 0.4A MAX Output: DC 12V, 1000mA

Operation Frequency each of channel							
Channel	Frequency	Channel	Frequency	Channel	Frequency	Channel	Frequency
1	2402 MHz	11	2422 MHz	21	2442 MHz	31	2462 MHz
2	2404 MHz	12	2424 MHz	22	2444 MHz	32	2464 MHz
3	2406 MHz	13	2426 MHz	23	2446 MHz	33	2466 MHz
4	2408 MHz	14	2428 MHz	24	2448 MHz	34	2468 MHz
5	2410 MHz	15	2430 MHz	25	2450 MHz	35	2470 MHz
6	2412 MHz	16	2432 MHz	26	2452 MHz	36	2472 MHz
7	2414 MHz	17	2434 MHz	27	2454 MHz	37	2474 MHz
8	2416 MHz	18	2436 MHz	28	2456 MHz	38	2476 MHz
9	2418 MHz	19	2438 MHz	29	2458 MHz	39	2478 MHz
10	2420 MHz	20	2440 MHz	30	2460 MHz	40	2480 MHz

Note: in section 15.31(m), regards to the operating frequency range over 10 MHz, the Lowest frequency, the middle frequency, and the highest frequency of channel were selected to perform the test, and the selected channel see below:

Channel	Frequency
The lowest channel	2402MHz
The middle channel	2440MHz
The Highest channel	2480MHz

5.2 Test mode

Transmitting mode	Keep the EUT in continuously transmitting mode
-------------------	--

5.3 Description of Support Units

None.

5.4 Deviation from Standards

None.

5.5 Abnormalities from Standard Conditions

None.

5.6 Test Facility

<p>The test facility is recognized, certified, or accredited by the following organizations:</p> <ul style="list-style-type: none"> ● FCC —Registration No.: 381383 Global United Technology Services Co., Ltd., Shenzhen EMC Laboratory has been registered and fully described in a report filed with the (FCC) Federal Communications Commission. The acceptance letter from the FCC is maintained in files. Registration 381383. ● IC —Registration No.: 9079A The 3m Semi-anechoic chamber of Global United Technology Services Co., Ltd. has been registered by Certification and Engineering Bureau of Industry Canada for radio equipment testing with Registration No.: 9079A. ● NVLAP (LAB CODE:600179-0) Global United Technology Services Co., Ltd., is accredited by the National Voluntary Laboratory Accreditation Program (NVLAP). LAB CODE:600179-0
--

5.7 Test Location

All tests were performed at:
<p>Global United Technology Services Co., Ltd. Address: No. 123-128, Tower A, Jinyuan Business Building, No.2, Laodong Industrial Zone, Xixiang Road, Baoan District, Shenzhen, Guangdong, China 518102 Tel: 0755-27798480 Fax: 0755-27798960</p>

5.8 Additional Instructions

Test Software	Special test command provided by manufacturer
Power level setup	Default

6 Test Instruments list

Radiated Emission:						
Item	Test Equipment	Manufacturer	Model No.	Inventory No.	Cal.Date (mm-dd-yy)	Cal.Due date (mm-dd-yy)
1	3m Semi- Anechoic Chamber	ZhongYu Electron	9.2(L)*6.2(W)* 6.4(H)	GTS250	July. 02 2020	July. 01 2025
2	Control Room	ZhongYu Electron	6.2(L)*2.5(W)* 2.4(H)	GTS251	N/A	N/A
3	EMI Test Receiver	Rohde & Schwarz	ESU26	GTS203	June. 25 2020	June. 24 2021
4	BiConiLog Antenna	SCHWARZBECK MESS-ELEKTRONIK	VULB9163	GTS214	June. 25 2020	June. 24 2021
5	Double -ridged waveguide horn	SCHWARZBECK MESS-ELEKTRONIK	BBHA 9120 D	GTS208	June. 25 2020	June. 24 2021
6	Horn Antenna	ETS-LINDGREN	3160	GTS217	June. 25 2020	June. 24 2021
7	EMI Test Software	AUDIX	E3	N/A	N/A	N/A
8	Coaxial Cable	GTS	N/A	GTS213	June. 25 2020	June. 24 2021
9	Coaxial Cable	GTS	N/A	GTS211	June. 25 2020	June. 24 2021
10	Coaxial cable	GTS	N/A	GTS210	June. 25 2020	June. 24 2021
11	Coaxial Cable	GTS	N/A	GTS212	June. 25 2020	June. 24 2021
12	Amplifier(100kHz-3GHz)	HP	8347A	GTS204	June. 25 2020	June. 24 2021
13	Amplifier(2GHz-20GHz)	HP	84722A	GTS206	June. 25 2020	June. 24 2021
14	Amplifier (18-26GHz)	Rohde & Schwarz	AFS33-18002 650-30-8P-44	GTS218	June. 25 2020	June. 24 2021
15	Band filter	Amindeon	82346	GTS219	June. 25 2020	June. 24 2021
16	Power Meter	Anritsu	ML2495A	GTS540	June. 25 2020	June. 24 2021
17	Power Sensor	Anritsu	MA2411B	GTS541	June. 25 2020	June. 24 2021
18	Wideband Radio Communication Tester	Rohde & Schwarz	CMW500	GTS575	June. 25 2020	June. 24 2021
19	Splitter	Agilent	11636B	GTS237	June. 25 2020	June. 24 2021
20	Loop Antenna	ZHINAN	ZN30900A	GTS534	June. 25 2020	June. 24 2021
21	Breitband hornantenne	SCHWARZBECK	BBHA 9170	GTS579	Oct. 18 2020	Oct. 17 2021
22	Amplifier	TDK	PA-02-02	GTS574	Oct. 18 2020	Oct. 17 2021
23	Amplifier	TDK	PA-02-03	GTS576	Oct. 18 2020	Oct. 17 2021
24	PSA Series Spectrum Analyzer	Rohde & Schwarz	FSP	GTS578	June. 25 2020	June. 24 2021

Conducted Emission						
Item	Test Equipment	Manufacturer	Model No.	Inventory No.	Cal.Date (mm-dd-yy)	Cal.Due date (mm-dd-yy)
1	Shielding Room	ZhongYu Electron	7.3(L)x3.1(W)x2.9(H)	GTS252	May.15 2019	May.14 2022
2	EMI Test Receiver	R&S	ESCI 7	GTS552	June. 25 2020	June. 24 2021
3	Coaxial Switch	ANRITSU CORP	MP59B	GTS225	June. 25 2020	June. 24 2021
4	ENV216 2-L-V-NETZNACHB.DE	ROHDE&SCHWARZ	ENV216	GTS226	June. 25 2020	June. 24 2021
5	Coaxial Cable	GTS	N/A	GTS227	N/A	N/A
6	EMI Test Software	AUDIX	E3	N/A	N/A	N/A
7	Thermo meter	KTJ	TA328	GTS233	June. 25 2020	June. 24 2021
8	Absorbing clamp	Elektronik-Feinmechanik	MDS21	GTS229	June. 25 2020	June. 24 2021
9	ISN	SCHWARZBECK	NTFM 8158	GTD565	June. 25 2020	June. 24 2021

RF Conducted Test:						
Item	Test Equipment	Manufacturer	Model No.	Serial No.	Cal.Date (mm-dd-yy)	Cal.Due date (mm-dd-yy)
1	MXA Signal Analyzer	Agilent	N9020A	GTS566	June. 25 2020	June. 24 2021
2	EMI Test Receiver	R&S	ESCI 7	GTS552	June. 25 2020	June. 24 2021
3	Spectrum Analyzer	Agilent	E4440A	GTS533	June. 25 2020	June. 24 2021
4	MXG vector Signal Generator	Agilent	N5182A	GTS567	June. 25 2020	June. 24 2021
5	ESG Analog Signal Generator	Agilent	E4428C	GTS568	June. 25 2020	June. 24 2021
6	USB RF Power Sensor	DARE	RPR3006W	GTS569	June. 25 2020	June. 24 2021
7	RF Switch Box	Shongyi	RFSW3003328	GTS571	June. 25 2020	June. 24 2021
8	Programmable Constant Temp & Humi Test Chamber	WEWON	WHTH-150L-40-880	GTS572	June. 25 2020	June. 24 2021

General used equipment:						
Item	Test Equipment	Manufacturer	Model No.	Inventory No.	Cal.Date (mm-dd-yy)	Cal.Due date (mm-dd-yy)
1	Humidity/ Temperature Indicator	KTJ	TA328	GTS243	June. 25 2020	June. 24 2021
2	Barometer	ChangChun	DYM3	GTS255	June. 25 2020	June. 24 2021

7 Test results and Measurement Data

7.1 Antenna requirement

Standard requirement:	FCC Part15 C Section 15.203 /247(c)
<p>15.203 requirement:</p> <p>An intentional radiator shall be designed to ensure that no antenna other than that furnished by the responsible party shall be used with the device. The use of a permanently attached antenna or of an antenna that uses a unique coupling to the intentional radiator, the manufacturer may design the unit so that a broken antenna can be replaced by the user, but the use of a standard antenna jack or electrical connector is prohibited.</p>	
<p>15.247(c) (1)(i) requirement:</p> <p>(i) Systems operating in the 2400-2483.5 MHz band that is used exclusively for fixed. Point-to-point operations may employ transmitting antennas with directional gain greater than 6dBi provided the maximum conducted output power of the intentional radiator is reduced by 1 dB for every 3 dB that the directional gain of the antenna exceeds 6dBi.</p>	
<p>E.U.T Antenna:</p> <p><i>The antenna is PCB antenna, the best case gain of the antenna is 1.5dBi, reference to the appendix II for details</i></p>	

7.2 Conducted Emissions

Test Requirement:	FCC Part15 C Section 15.207					
Test Method:	ANSI C63.10:2013					
Test Frequency Range:	150KHz to 30MHz					
Class / Severity:	Class B					
Receiver setup:	RBW=9KHz, VBW=30KHz, Sweep time=auto					
Limit:	Frequency range (MHz)		Limit (dBuV)			
			Quasi-peak		Average	
	0.15-0.5		66 to 56*		56 to 46*	
	0.5-5		56		46	
5-30		60		50		
* Decreases with the logarithm of the frequency.						
Test setup:						
	<p><i>Remark</i> E.U.T: Equipment Under Test LISN: Line Impedance Stabilization Network Test table height=0.8m</p>					
Test procedure:	<ol style="list-style-type: none"> 1. The E.U.T and simulators are connected to the main power through a line impedance stabilization network (L.I.S.N.). This provides a 50ohm/50uH coupling impedance for the measuring equipment. 2. The peripheral devices are also connected to the main power through a LISN that provides a 50ohm/50uH coupling impedance with 50ohm termination. (Please refer to the block diagram of the test setup and photographs). 3. Both sides of A.C. line are checked for maximum conducted interference. In order to find the maximum emission, the relative positions of equipment and all of the interface cables must be changed according to ANSI C63.10: 2013 on conducted measurement. 					
Test Instruments:	Refer to section 6.0 for details					
Test mode:	Refer to section 5.2 for details					
Test environment:	Temp.:	25 °C	Humid.:	52%	Press.:	1012mbar
Test voltage:	AC 120V, 60Hz					
Test results:	Pass					

Remark: Both high and low voltages have been tested to show only the worst low voltage test data.

Measurement data

Pre-scan all test modes, found worst case at 2402MHz, and so only show the test result of 2402MHz

Line

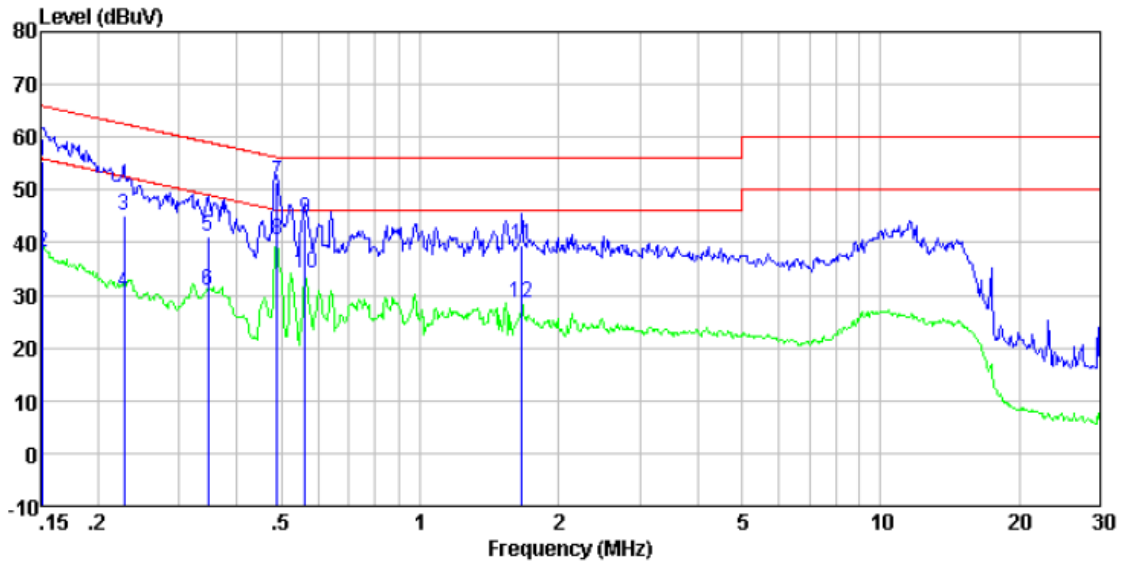

Freq MHz	Reading level dBuV	LISN/ISN factor dB/m	Cable loss dB	Level dBuV	Limit level dBuV	Over limit dB	Remark
0.15	35.04	20.40	0.07	55.51	65.91	-10.40	QP
0.15	17.75	20.40	0.07	38.22	55.91	-17.69	Average
0.23	24.65	20.40	0.11	45.16	62.52	-17.36	QP
0.23	10.17	20.40	0.11	30.68	52.52	-21.84	Average
0.35	20.50	20.38	0.10	40.98	59.05	-18.07	QP
0.35	10.29	20.38	0.10	30.77	49.05	-18.28	Average
0.49	31.15	20.32	0.11	51.58	56.19	-4.61	QP
0.49	20.01	20.32	0.11	40.44	46.19	-5.75	Average
0.56	24.11	20.30	0.12	44.53	56.00	-11.47	QP
0.56	13.76	20.30	0.12	34.18	46.00	-11.82	Average
1.66	19.27	20.20	0.17	39.64	56.00	-16.36	QP
1.66	8.29	20.20	0.17	28.66	46.00	-17.34	Average

Neutral

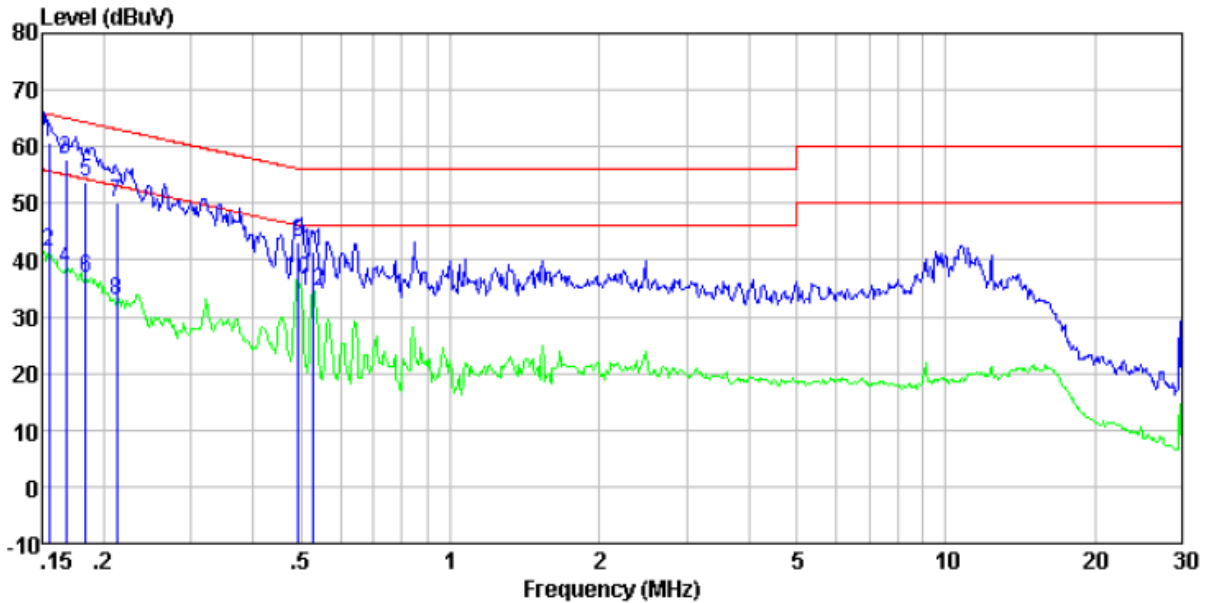

Freq MHz	Reading level dBuV	LISN/ISN factor dB/m	Cable loss dB	Level dBuV	Limit level dBuV	Over limit dB	Remark
0.15	40.22	20.40	0.07	60.69	65.74	-5.05	QP
0.15	20.94	20.40	0.07	41.41	55.74	-14.33	Average
0.17	37.15	20.40	0.09	57.64	65.08	-7.44	QP
0.17	18.05	20.40	0.09	38.54	55.08	-16.54	Average
0.18	33.35	20.40	0.10	53.85	64.33	-10.48	QP
0.18	16.43	20.40	0.10	36.93	54.33	-17.40	Average
0.21	29.76	20.40	0.11	50.27	63.10	-12.83	QP
0.21	12.20	20.40	0.11	32.71	53.10	-20.39	Average
0.49	22.58	20.32	0.11	43.01	56.10	-13.09	QP
0.49	16.06	20.32	0.11	36.49	46.10	-9.61	Average
0.53	21.05	20.31	0.11	41.47	56.00	-14.53	QP
0.53	14.15	20.31	0.11	34.57	46.00	-11.43	Average

Notes:

1. An initial pre-scan was performed on the line and neutral lines with peak detector.
2. Quasi-Peak and Average measurement were performed at the frequencies with maximized peak emission.
3. Final Level = Receiver Read level + LISN Factor + Cable Loss

7.3 Conducted Output Power

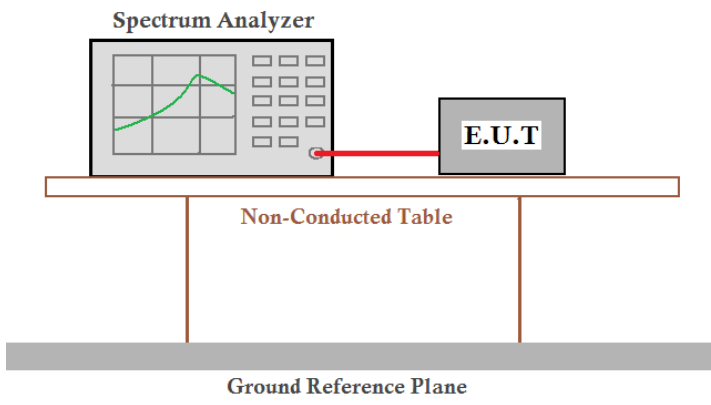
Test Requirement:	FCC Part15 C Section 15.247 (b)(3)
Test Method:	ANSI C63.10:2013 and KDB558074 D01 15.247 Meas Guidance v05r02
Limit:	30dBm
Test setup:	 <p>The diagram illustrates the test setup. A Spectrum Analyzer is connected to an E.U.T. (Equipment Under Test) via a red cable. Both are placed on a Non-Conducted Table. Below the table is a Ground Reference Plane.</p>
Test Instruments:	Refer to section 6.0 for details
Test mode:	Refer to section 5.2 for details
Test results:	Pass

Measurement Data

Test channel	Peak Output Power (dBm)	Limit(dBm)	Result
Lowest	-1.53	30.00	Pass
Middle	-1.99		
Highest	-2.77		

Test plot as follows:

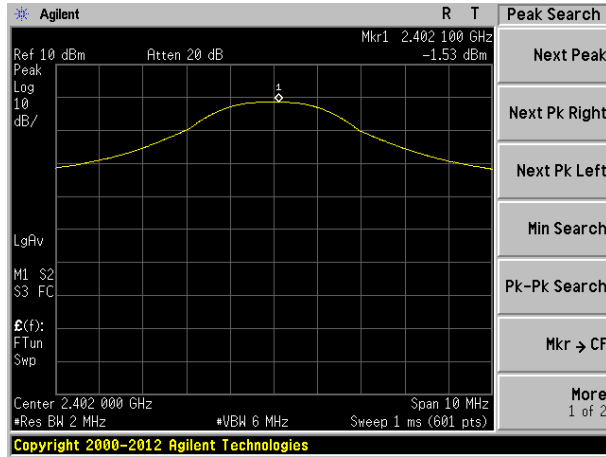

Lowest channel

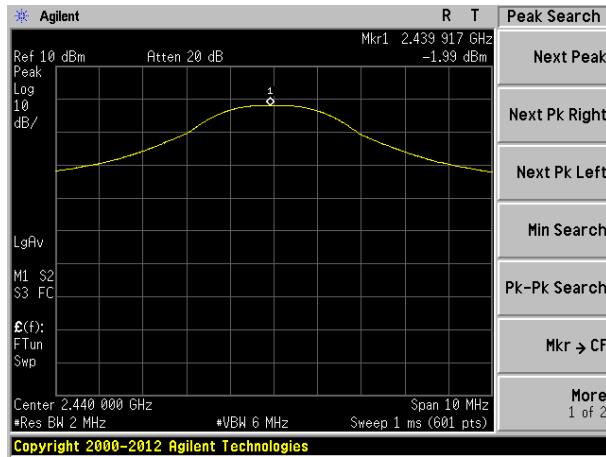

Middle channel

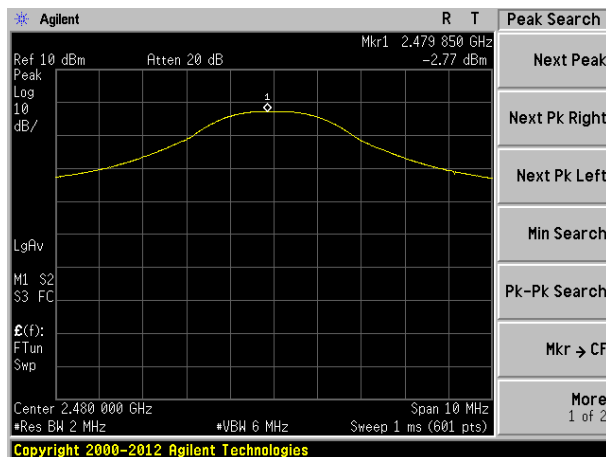

Highest channel

7.4 Channel Bandwidth

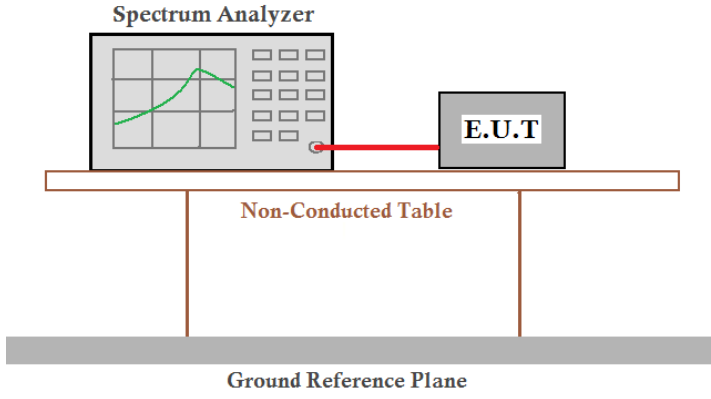
Test Requirement:	FCC Part15 C Section 15.247 (a)(2)
Test Method:	ANSI C63.10:2013 and KDB558074 D01 15.247 Meas Guidance v05r02
Limit:	Channel Bandwidth >500KHz
Test setup:	 <p>The diagram illustrates the test setup. A Spectrum Analyzer is connected to an E.U.T. (Equipment Under Test) via a red cable. Both are placed on a Non-Conducted Table, which is supported by a Ground Reference Plane.</p>
Test Instruments:	Refer to section 6.0 for details
Test mode:	Refer to section 5.2 for details
Test results:	Pass

Measurement Data

Test channel	Channel Bandwidth (MHz)	Limit(KHz)	Result
Lowest	0.677	>500	Pass
Middle	0.695		
Highest	0.681		

Test plot as follows:

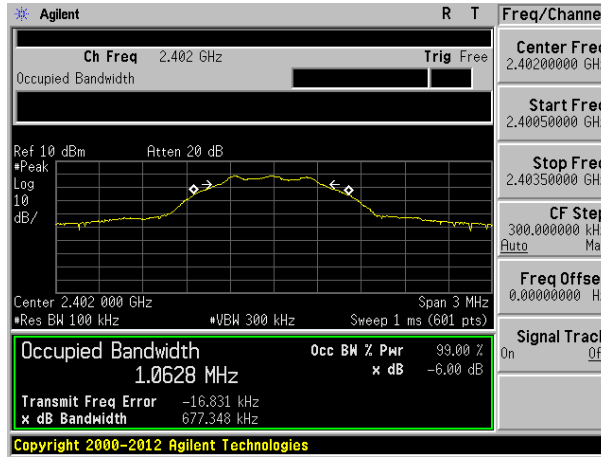

Lowest channel

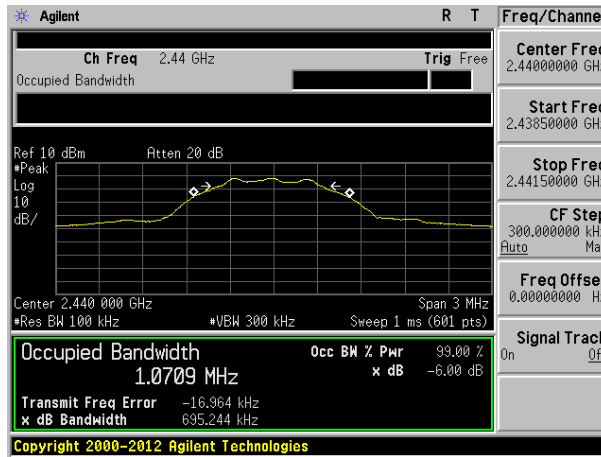

Middle channel

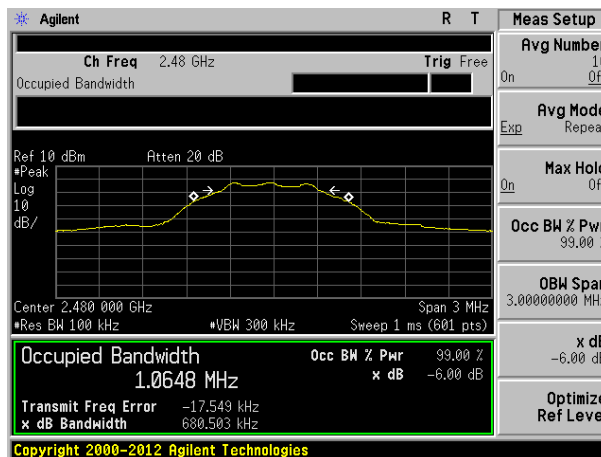

Highest channel

7.5 Power Spectral Density

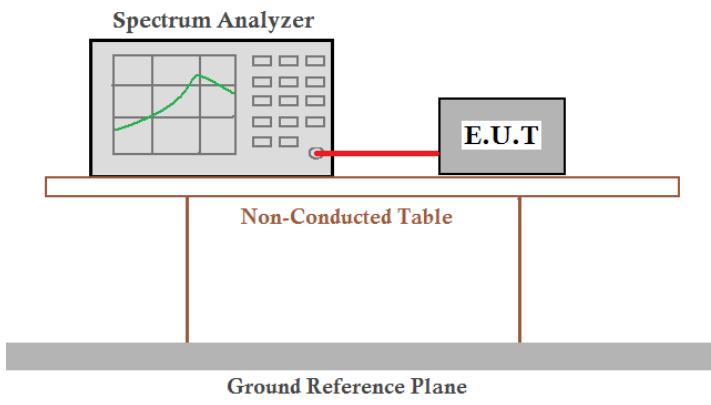
Test Requirement:	FCC Part15 C Section 15.247 (e)
Test Method:	ANSI C63.10:2013 and KDB558074 D01 15.247 Meas Guidance v05r02
Limit:	8dBm/3kHz
Test setup:	 <p>The diagram illustrates the test setup. A Spectrum Analyzer is connected to an E.U.T. (Equipment Under Test) via a red cable. Both are placed on a Non-Conducted Table, which is supported by a Ground Reference Plane.</p>
Test Instruments:	Refer to section 6.0 for details
Test mode:	Refer to section 5.2 for details
Test results:	Pass

Measurement Data

Test channel	Power Spectral Density (dBm/3kHz)	Limit(dBm/3kHz)	Result
Lowest	-14.24	8.00	Pass
Middle	-13.79		
Highest	-15.21		

Test plot as follows:

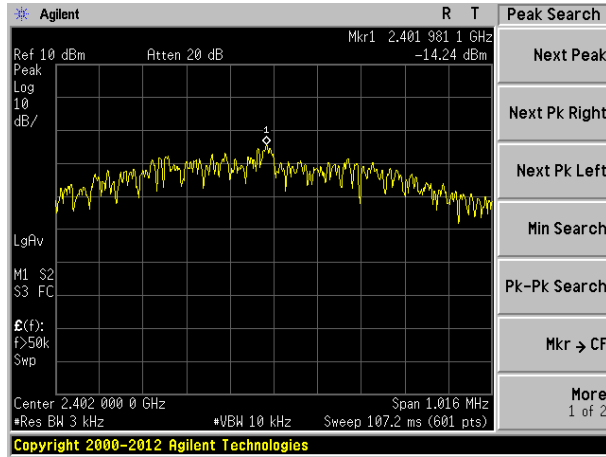

Lowest channel

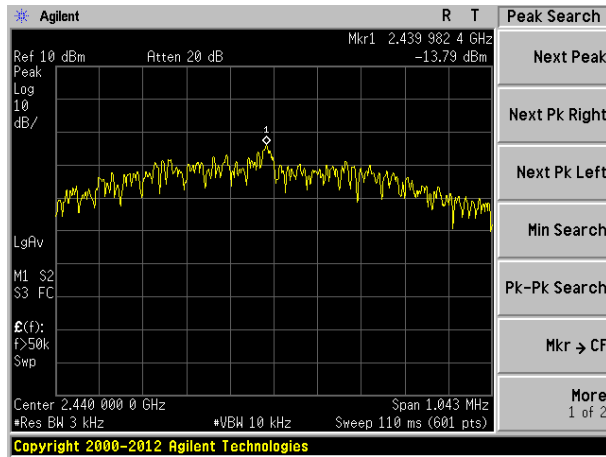

Middle channel

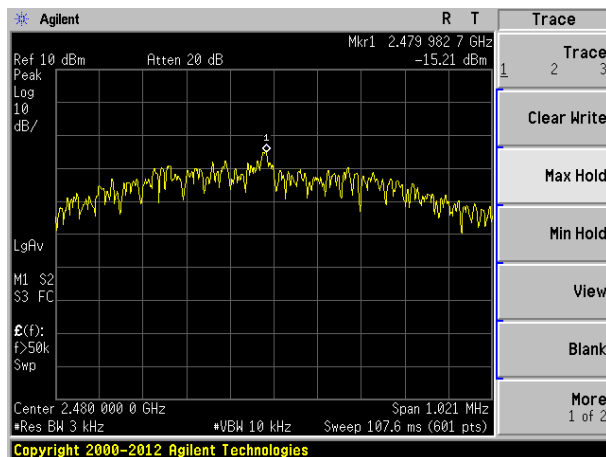

Highest channel

7.6 Band edges

7.6.1 Conducted Emission Method

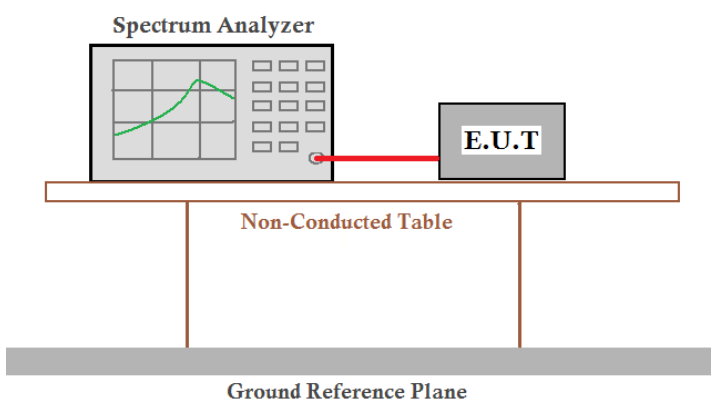
Test Requirement:	FCC Part15 C Section 15.247 (d)
Test Method:	ANSI C63.10:2013 and KDB558074 D01 15.247 Meas Guidance v05r02
Limit:	In any 100 kHz bandwidth outside the frequency band in which the spread spectrum intentional radiator is operating, the radio frequency power that is produced by the intentional radiator shall be at least 20 dB below that in the 100 kHz bandwidth within the band that contains the highest level of the desired power, based on either an RF conducted or a radiated measurement.
Test setup:	 <p>The diagram illustrates the test setup. A Spectrum Analyzer is connected to an Equipment Under Test (E.U.T.) via a red cable. Both are placed on a Non-Conducted Table. Below the table is a Ground Reference Plane.</p>
Test Instruments:	Refer to section 6.0 for details
Test mode:	Refer to section 5.2 for details
Test results:	Pass

Test plot as follows:

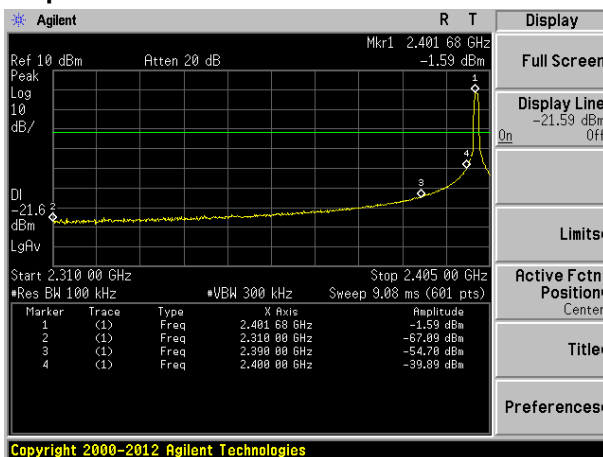

Lowest channel

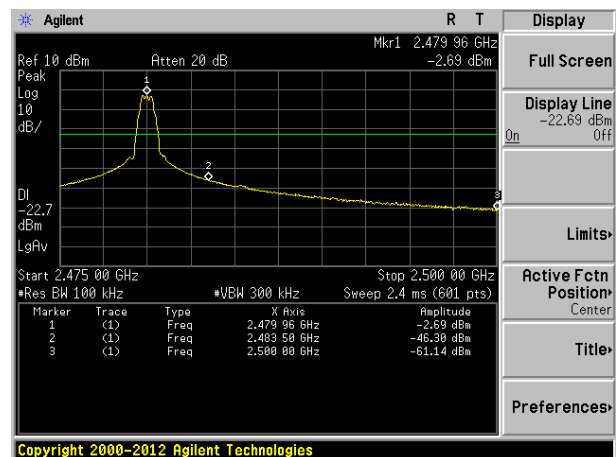

Highest channel

7.6.2 Radiated Emission Method

Test Requirement:	FCC Part15 C Section 15.209 and 15.205				
Test Method:	ANSI C63.10:2013				
Test Frequency Range:	All of the restrict bands were tested, only the worst band's (2310MHz to 2500MHz) data was showed.				
Test site:	Measurement Distance: 3m				
Receiver setup:	Frequency	Detector	RBW	VBW	Value
	Above 1GHz	Peak	1MHz	3MHz	Peak
		RMS	1MHz	3MHz	Average
Limit:	Frequency		Limit (dBuV/m @3m)		Value
	Above 1GHz		54.00		Average
			74.00		Peak
Test setup:					
Test Procedure:	<ol style="list-style-type: none"> 1. The EUT was placed on the top of a rotating table 1.5m above the ground at a 3 meter camber. The table was rotated 360 degrees to determine the position of the highest radiation. 2. The EUT was set 3 meters away from the interference-receiving antenna, which was mounted on the top of a variable-height antenna tower. 3. The antenna height is varied from one meter to four meters above the ground to determine the maximum value of the field strength. Both horizontal and vertical polarizations of the antenna are set to make the measurement. 4. For each suspected emission, the EUT was arranged to its worst case and then the antenna was tuned to heights from 1 meter to 4 meters and the rota table was turned from 0 degrees to 360 degrees to find the maximum reading. 5. The test-receiver system was set to Peak Detect Function and Specified Bandwidth with Maximum Hold Mode. 6. If the emission level of the EUT in peak mode was 10dB lower than the limit specified, then testing could be stopped and the peak values of the EUT would be reported. Otherwise the emissions that did not have 10dB margin would be re-tested one by one using peak, quasi-peak or average method as specified and then reported in a data sheet. 7. The radiation measurements are performed in X, Y, Z axis positioning. And found the X axis positioning which it is worse case, only the test worst case mode is recorded in the report. 				
Test Instruments:	Refer to section 6.0 for details				
Test mode:	Refer to section 5.2 for details				
Test results:	Pass				

Measurement data

Remark: The pre-test were performed on lowest, middle and highest frequencies, only the worst case's (lowest and highest frequencies) data was showed.

Test channel:	Lowest
---------------	--------

Peak value:

Frequency (MHz)	Read Level (dBuV)	Antenna Factor (dB/m)	Cable Loss (dB)	Preamp Factor (dB)	Level (dBuV/m)	Limit Line (dBuV/m)	Over Limit (dB)	Polarization
2310.00	47.63	27.91	5.30	24.64	56.20	74.00	-17.80	Horizontal
2390.00	52.09	27.59	5.38	24.71	60.35	74.00	-13.65	Horizontal
2400.00	53.86	27.41	5.39	24.72	61.94	74.00	-12.06	Horizontal
2310.00	48.63	27.91	5.30	24.64	57.20	74.00	-16.80	Vertical
2390.00	53.64	27.59	5.38	24.71	61.90	74.00	-12.10	Vertical
2400.00	55.35	27.41	5.39	24.72	63.43	74.00	-10.57	Vertical

Average value:

Frequency (MHz)	Read Level (dBuV)	Antenna Factor (dB/m)	Cable Loss (dB)	Preamp Factor (dB)	Level (dBuV/m)	Limit Line (dBuV/m)	Over Limit (dB)	Polarization
2310.00	37.10	27.91	5.30	24.64	45.67	54.00	-8.33	Horizontal
2390.00	38.62	27.59	5.38	24.71	46.88	54.00	-7.12	Horizontal
2400.00	40.32	27.41	5.39	24.72	48.40	54.00	-5.60	Horizontal
2310.00	37.39	27.91	5.30	24.64	45.96	54.00	-8.04	Vertical
2390.00	39.72	27.59	5.38	24.71	47.98	54.00	-6.02	Vertical
2400.00	40.66	27.41	5.39	24.72	48.74	54.00	-5.26	Vertical

Test channel:	Highest
---------------	---------

Peak value:

Frequency (MHz)	Read Level (dBuV)	Antenna Factor (dB/m)	Cable Loss (dB)	Preamp Factor (dB)	Level (dBuV/m)	Limit Line (dBuV/m)	Over Limit (dB)	Polarization
2483.50	50.30	27.53	5.47	24.80	58.50	74.00	-15.50	Horizontal
2500.00	48.56	27.55	5.49	24.86	56.74	74.00	-17.26	Horizontal
2483.50	51.93	27.53	5.47	24.80	60.13	74.00	-13.87	Vertical
2500.00	50.02	27.55	5.49	24.86	58.20	74.00	-15.80	Vertical

Average value:

Frequency (MHz)	Read Level (dBuV)	Antenna Factor (dB/m)	Cable Loss (dB)	Preamp Factor (dB)	Level (dBuV/m)	Limit Line (dBuV/m)	Over Limit (dB)	Polarization
2483.50	37.99	27.53	5.47	24.80	46.19	54.00	-7.81	Horizontal
2500.00	37.31	27.55	5.49	24.86	45.49	54.00	-8.51	Horizontal
2483.50	37.38	27.53	5.47	24.80	45.58	54.00	-8.42	Vertical
2500.00	37.63	27.55	5.49	24.86	45.81	54.00	-8.19	Vertical

Remark:

1. *Final Level = Receiver Read level + Antenna Factor + Cable Loss – Preamplifier Factor*
2. *The emission levels of other frequencies are very lower than the limit and not show in test report.*

7.7 Spurious Emission

7.7.1 Conducted Emission Method

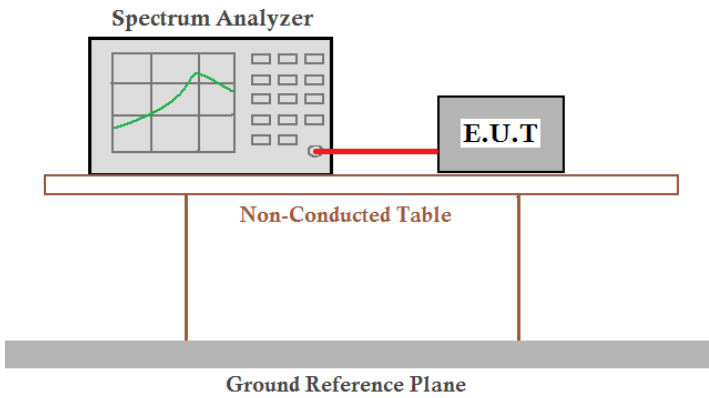
Test Requirement:	FCC Part15 C Section 15.247 (d)
Test Method:	ANSI C63.10:2013 and KDB558074 D01 15.247 Meas Guidance v05r02
Limit:	In any 100 kHz bandwidth outside the frequency band in which the spread spectrum intentional radiator is operating, the radio frequency power that is produced by the intentional radiator shall be at least 20 dB below that in the 100 kHz bandwidth within the band that contains the highest level of the desired power, based on either an RF conducted or a radiated measurement.
Test setup:	 <p>The diagram illustrates the test setup. A Spectrum Analyzer is connected to an E.U.T. (Equipment Under Test) via a red cable. Both are placed on a Non-Conducted Table, which is supported by two legs. Below the table is a Ground Reference Plane.</p>
Test Instruments:	Refer to section 6.0 for details
Test mode:	Refer to section 5.2 for details
Test results:	Pass

Test plot as follows:

Lowest channel

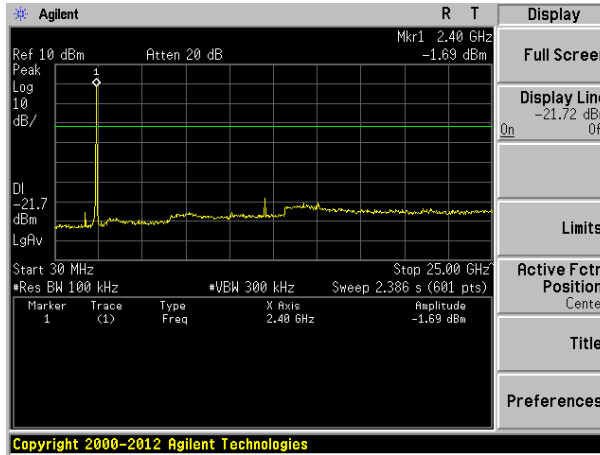

30MHz~25GHz

Middle channel

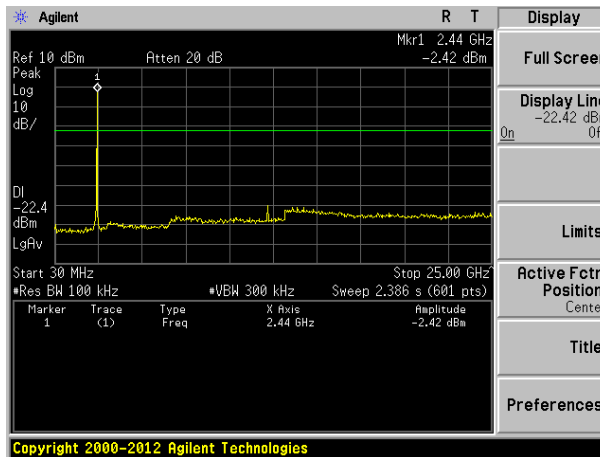

30MHz~25GHz

Highest channel

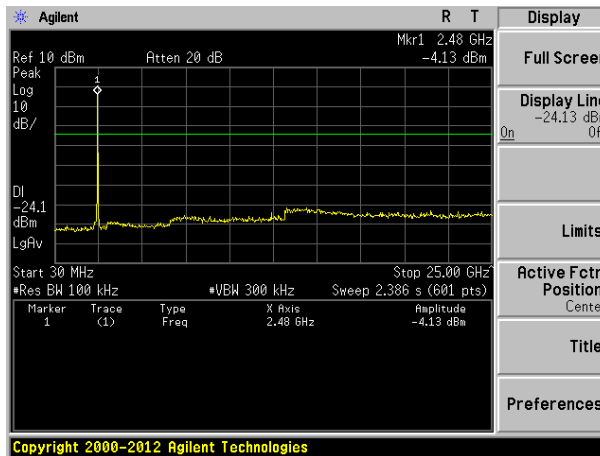

30MHz~25GHz

7.7.2 Radiated Emission Method

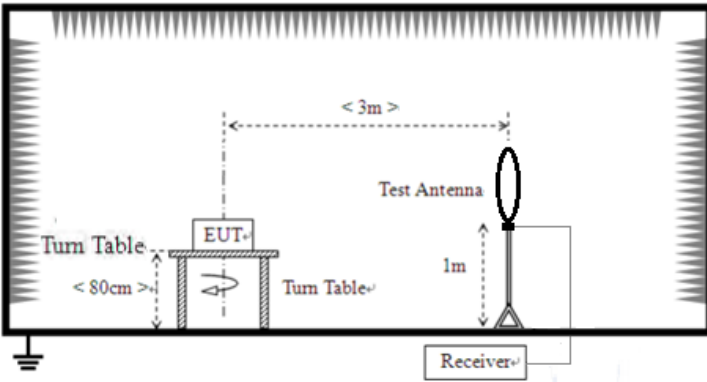
Test Requirement:	FCC Part15 C Section 15.209				
Test Method:	ANSI C63.10:2013				
Test Frequency Range:	9kHz to 25GHz				
Test site:	Measurement Distance: 3m				
Receiver setup:	Frequency	Detector	RBW	VBW	Value
	9KHz-150KHz	Quasi-peak	200Hz	600Hz	Quasi-peak
	150KHz-30MHz	Quasi-peak	9KHz	30KHz	Quasi-peak
	30MHz-1GHz	Quasi-peak	120KHz	300KHz	Quasi-peak
	Above 1GHz	Peak	1MHz	3MHz	Peak
Peak		1MHz	10Hz	Average	
Limit: (Spurious Emissions)	Frequency	Limit (uV/m)	Value	Measurement Distance	
	0.009MHz-0.490MHz	2400/F(KHz)	QP	300m	
	0.490MHz-1.705MHz	24000/F(KHz)	QP	300m	
	1.705MHz-30MHz	30	QP	30m	
	30MHz-88MHz	100	QP	3m	
	88MHz-216MHz	150	QP		
	216MHz-960MHz	200	QP		
	960MHz-1GHz	500	QP		
	Above 1GHz	500	Average		
5000		Peak			
Test setup:	For radiated emissions from 9kHz to 30MHz				
	 <p>The diagram illustrates the test setup for radiated emissions from 9kHz to 30MHz. It shows an Equipment Under Test (EUT) placed on a turn table. A test antenna is positioned 3m away from the EUT and 1m high. A receiver is connected to the test antenna. The turn table height is indicated as less than 80cm.</p>				
For radiated emissions from 30MHz to 1GHz					

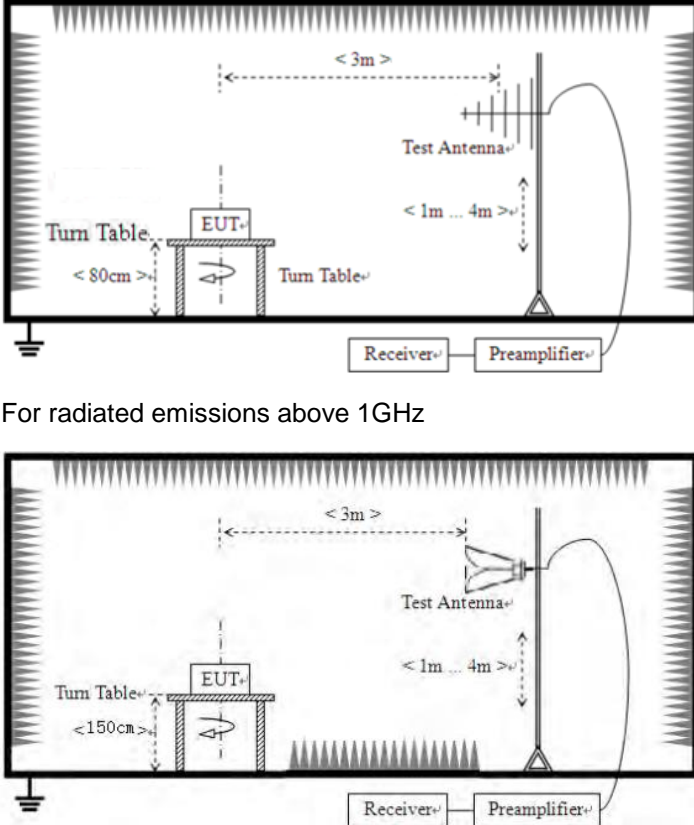
	 <p>For radiated emissions above 1GHz</p>
<p>Test Procedure:</p>	<ol style="list-style-type: none"> 1. The EUT was placed on the top of a rotating table (0.8m for below 1G and 1.5m for above 1G) above the ground at a 3 meter camber. The table was rotated 360 degrees to determine the position of the highest radiation. 2. The EUT was set 3 meters away from the interference-receiving antenna, which was mounted on the top of a variable-height antenna tower. 3. The antenna height is varied from one meter to four meters above the ground to determine the maximum value of the field strength. Both horizontal and vertical polarizations of the antenna are set to make the measurement. 4. For each suspected emission, the EUT was arranged to its worst case and then the antenna was tuned to heights from 1 meter to 4 meters and the rota table was turned from 0 degrees to 360 degrees to find the maximum reading. 5. The test-receiver system was set to Peak Detect Function and Specified Bandwidth with Maximum Hold Mode. 6. If the emission level of the EUT in peak mode was 10dB lower than the limit specified, then testing could be stopped and the peak values of the EUT would be reported. Otherwise the emissions that did not have 10dB margin would be re-tested one by one using peak, quasi-peak or average method as specified and then reported in a data sheet.
<p>Test Instruments:</p>	<p>Refer to section 6.0 for details</p>
<p>Test mode:</p>	<p>Refer to section 5.2 for details</p>

Test environment:	Temp.:	25 °C	Humid.:	52%	Press.:	1012mbar
Test voltage:	AC 120V, 60Hz					
Test results:	Pass					

Remark:

Pre-scan all kind of the place mode (X-axis, Y-axis, Z-axis), and found the X-axis which it is worse case.

Measurement data:

■ **9 kHz ~ 30 MHz**

The low frequency, which started from 9 kHz to 30 MHz, was pre-scanned and the result which was 20 dB lower than the limit line per 15.31(o) was not reported.

■ **Below 1GHz**

Pre-scan all test modes, found worst case at 2402MHz, and so only show the test result of 2402MHz

Horizontal

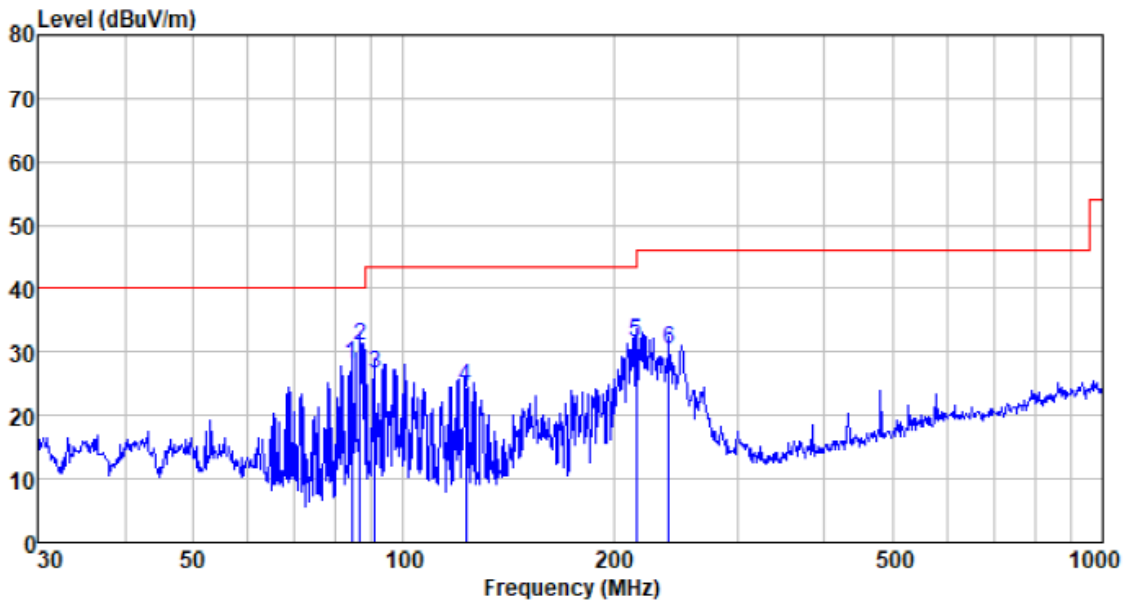

Freq MHz	Reading level dBuV	Antenna factor dB/m	Cable loss dB	Preamp factor dB	level dBuV/m	Limit level dBuV/m	Over limit dB	Remark
84.405	54.63	8.92	1.07	36.59	28.03	40.00	-11.97	QP
86.807	56.75	9.68	1.08	36.61	30.90	40.00	-9.10	QP
91.175	51.22	10.84	1.12	36.65	26.53	43.50	-16.97	QP
122.834	50.76	9.12	1.38	36.90	24.36	43.50	-19.14	QP
215.268	56.15	10.98	1.93	37.35	31.71	43.50	-11.79	QP
239.987	53.99	11.85	2.07	37.37	30.54	46.00	-15.46	QP

Vertical

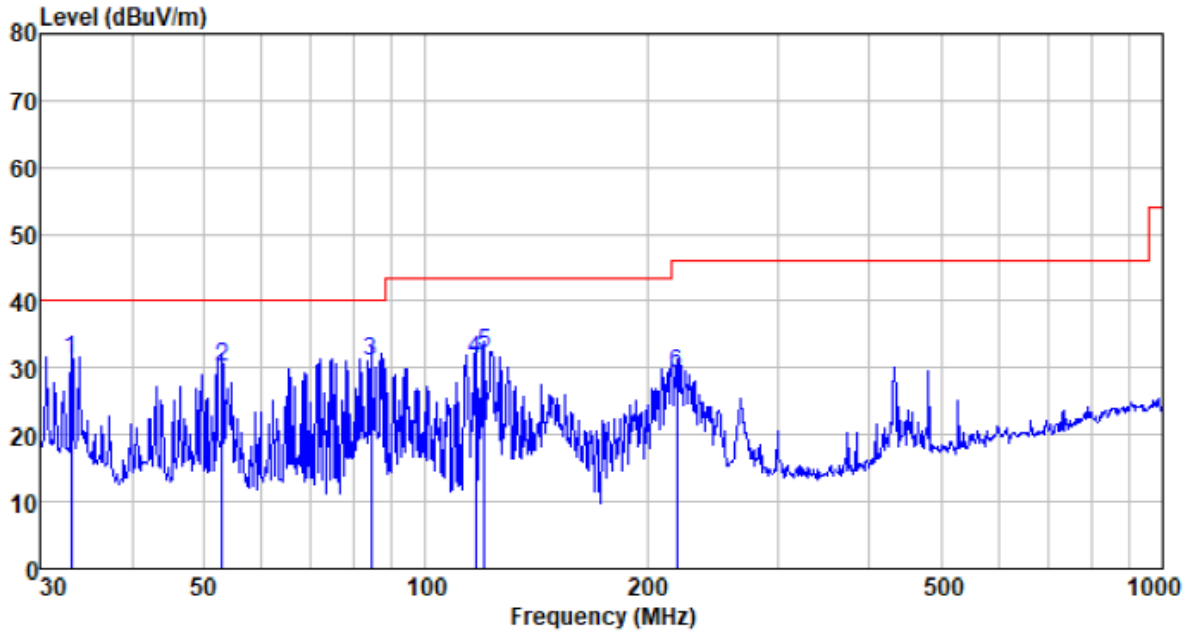

Freq MHz	Reading level dBuV	Antenna factor dB/m	Cable loss dB	Preamp factor dB	level dBuV/m	Limit level dBuV/m	Over limit dB	Remark
33.095	54.75	11.26	0.59	35.23	31.37	40.00	-8.63	QP
52.945	53.57	12.00	0.80	36.22	30.15	40.00	-9.85	QP
84.405	57.74	8.92	1.07	36.59	31.14	40.00	-8.86	QP
116.950	56.72	10.01	1.34	36.86	31.21	43.50	-12.29	QP
120.277	58.17	9.42	1.36	36.88	32.07	43.50	-11.43	QP
219.075	53.62	11.13	1.95	37.35	29.35	46.00	-16.65	QP

■ Above 1GHz

Test channel:	Lowest
---------------	--------

Peak value:

Frequency (MHz)	Read Level (dBuV)	Antenna Factor (dB/m)	Cable Loss (dB)	Preamp Factor (dB)	Level (dBuV/m)	Limit Line (dBuV/m)	Over Limit (dB)	polarization
4804.00	36.03	31.78	8.60	32.09	44.32	74.00	-29.68	Vertical
7206.00	30.98	36.15	11.65	32.00	46.78	74.00	-27.22	Vertical
9608.00	30.71	37.95	14.14	31.62	51.18	74.00	-22.82	Vertical
12010.00	*					74.00		Vertical
14412.00	*					74.00		Vertical
4804.00	40.05	31.78	8.60	32.09	48.34	74.00	-25.66	Horizontal
7206.00	32.62	36.15	11.65	32.00	48.42	74.00	-25.58	Horizontal
9608.00	30.01	37.95	14.14	31.62	50.48	74.00	-23.52	Horizontal
12010.00	*					74.00		Horizontal
14412.00	*					74.00		Horizontal

Average value:

Frequency (MHz)	Read Level (dBuV)	Antenna Factor (dB/m)	Cable Loss (dB)	Preamp Factor (dB)	Level (dBuV/m)	Limit Line (dBuV/m)	Over Limit (dB)	polarization
4804.00	25.08	31.78	8.60	32.09	33.37	54.00	-20.63	Vertical
7206.00	19.81	36.15	11.65	32.00	35.61	54.00	-18.39	Vertical
9608.00	18.97	37.95	14.14	31.62	39.44	54.00	-14.56	Vertical
12010.00	*					54.00		Vertical
14412.00	*					54.00		Vertical
4804.00	29.17	31.78	8.60	32.09	37.46	54.00	-16.54	Horizontal
7206.00	21.90	36.15	11.65	32.00	37.70	54.00	-16.30	Horizontal
9608.00	18.59	37.95	14.14	31.62	39.06	54.00	-14.94	Horizontal
12010.00	*					54.00		Horizontal
14412.00	*					54.00		Horizontal

Test channel:	Middle
---------------	--------

Peak value:

Frequency (MHz)	Read Level (dBuV)	Antenna Factor (dB/m)	Cable Loss (dB)	Preamp Factor (dB)	Level (dBuV/m)	Limit Line (dBuV/m)	Over Limit (dB)	polarization
4880.00	35.89	31.85	8.67	32.12	44.29	74.00	-29.71	Vertical
7320.00	30.89	36.37	11.72	31.89	47.09	74.00	-26.91	Vertical
9760.00	30.63	38.35	14.25	31.62	51.61	74.00	-22.39	Vertical
12200.00	*					74.00		Vertical
14640.00	*					74.00		Vertical
4880.00	39.89	31.85	8.67	32.12	48.29	74.00	-25.71	Horizontal
7320.00	32.52	36.37	11.72	31.89	48.72	74.00	-25.28	Horizontal
9760.00	29.92	38.35	14.25	31.62	50.90	74.00	-23.10	Horizontal
12200.00	*					74.00		Horizontal
14640.00	*					74.00		Horizontal

Average value:

Frequency (MHz)	Read Level (dBuV)	Antenna Factor (dB/m)	Cable Loss (dB)	Preamp Factor (dB)	Level (dBuV/m)	Limit Line (dBuV/m)	Over Limit (dB)	polarization
4880.00	24.98	31.85	8.67	32.12	33.38	54.00	-20.62	Vertical
7320.00	19.74	36.37	11.72	31.89	35.94	54.00	-18.06	Vertical
9760.00	18.91	38.35	14.25	31.62	39.89	54.00	-14.11	Vertical
12200.00	*					54.00		Vertical
14640.00	*					54.00		Vertical
4880.00	29.05	31.85	8.67	32.12	37.45	54.00	-16.55	Horizontal
7320.00	21.82	36.37	11.72	31.89	38.02	54.00	-15.98	Horizontal
9760.00	18.52	38.35	14.25	31.62	39.50	54.00	-14.50	Horizontal
12200.00	*					54.00		Horizontal
14640.00	*					54.00		Horizontal

Test channel:	Highest
---------------	---------

Peak value:

Frequency (MHz)	Read Level (dBuV)	Antenna Factor (dB/m)	Cable Loss (dB)	Preamp Factor (dB)	Level (dBuV/m)	Limit Line (dBuV/m)	Over Limit (dB)	polarization
4960.00	35.85	31.93	8.73	32.16	44.35	74.00	-29.65	Vertical
7440.00	30.87	36.59	11.79	31.78	47.47	74.00	-26.53	Vertical
9920.00	30.61	38.81	14.38	31.88	51.92	74.00	-22.08	Vertical
12400.00	*					74.00		Vertical
14880.00	*					74.00		Vertical
4960.00	39.84	31.93	8.73	32.16	48.34	74.00	-25.66	Horizontal
7440.00	32.49	36.59	11.79	31.78	49.09	74.00	-24.91	Horizontal
9920.00	29.89	38.81	14.38	31.88	51.20	74.00	-22.80	Horizontal
12400.00	*					74.00		Horizontal
14880.00	*					74.00		Horizontal

Average value:

Frequency (MHz)	Read Level (dBuV)	Antenna Factor (dB/m)	Cable Loss (dB)	Preamp Factor (dB)	Level (dBuV/m)	Limit Line (dBuV/m)	Over Limit (dB)	polarization
4960.00	24.98	31.93	8.73	32.16	33.48	54.00	-20.52	Vertical
7440.00	19.74	36.59	11.79	31.78	36.34	54.00	-17.66	Vertical
9920.00	18.91	38.81	14.38	31.88	40.22	54.00	-13.78	Vertical
12400.00	*					54.00		Vertical
14880.00	*					54.00		Vertical
4960.00	29.05	31.93	8.73	32.16	37.55	54.00	-16.45	Horizontal
7440.00	21.83	36.59	11.79	31.78	38.43	54.00	-15.57	Horizontal
9920.00	18.52	38.81	14.38	31.88	39.83	54.00	-14.17	Horizontal
12400.00	*					54.00		Horizontal
14880.00	*					54.00		Horizontal

Remark:

1. Final Level = Receiver Read level + Antenna Factor + Cable Loss – Preamplifier Factor
2. “*”, means this data is the too weak instrument of signal is unable to test.
3. The emission levels of other frequencies are very lower than the limit and not show in test report.

8 Test Setup Photo

Reference to the **appendix I** for details.

9 EUT Constructional Details

Reference to the **appendix II** for details.

-----End-----