

H604A说明书

版本:1.0

料号:807-0003-00302

折叠尺寸:105×145 (mm)

展开尺寸:210×145 (mm)

材质:80G书页纸

工艺:单色印刷

折叠方式:骑马订

页数:12页



# User Manual



Model: H604A  
Govee Gaming Light Kit



# Safety Instructions

Read and follow all the safety instructions:

- This product is not waterproof. Avoid exposing its components to splashes, water drops, or every high-humidity environments.
- Be careful of static electricity during installation and usage and keep away from sharp objects and strong corrosive chemicals.
- When bending the light strip during installation, avoid folding its component as this may affect its service life.
- The internal light sources cannot be replaced. If they sustain damage, the product should be replaced.
- External dimmers cannot be used with this product.
- Avoid installing the light bars near potentially dangerous sources (e.g., candles, liquid-filled objects.)

## Introduction

Thanks for choosing Govee Gaming Light Kit. The gaming camera included in this kit can automatically detect onscreen colors and project them on the wall behind via the light bars and the neon light strip. The real-time lighting effects will be synced perfectly with your movies, TV shows, sports, and gaming world, bringing you another level of immersive experience to your daily entertainment. This Kit also supports intelligent voice control for hands-free access to your gaming lighting.

## What You Get

Light Bars	2
Neon Light Strip	1
Gaming Camera	1
Power Adapter	1
Headphone Linking Cable	1
Foam Stickers	8
Mounting Clips	9
User Manual	1
Quick Start Guide	1

## At a Glance

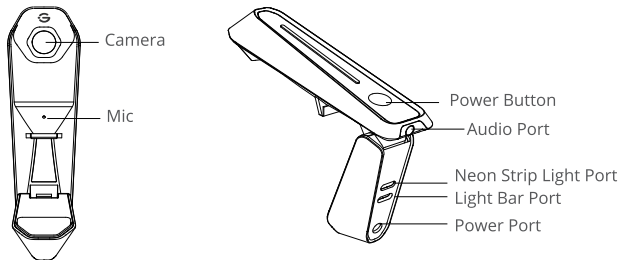

Gaming Camera

Power Button

Press to turn on and off.

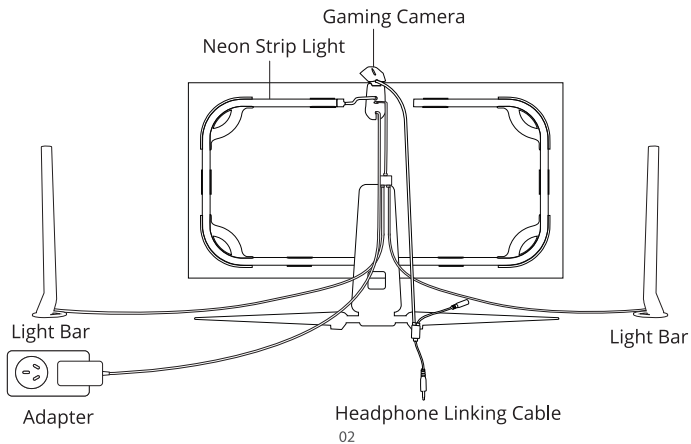

# Pairing Your Device with Govee Home App

## What You Need:

- A Wi-Fi router supporting 2.4GHz and 802.11 b/g/n bands. 5GHz is not supported.

## Pairing Instructions:

- ① Download Govee Home App from the App Store (iOS) or Google Play (Android).
- ② Open Govee Home App, tap the “+” icon in the top right corner and search for “H604A”.
- ③ Tap the device icon and follow the onscreen instructions to complete pairing.



# Calibrating the Camera Using Govee Home App

1. Ensure the camera is positioned at the top-center of the screen.

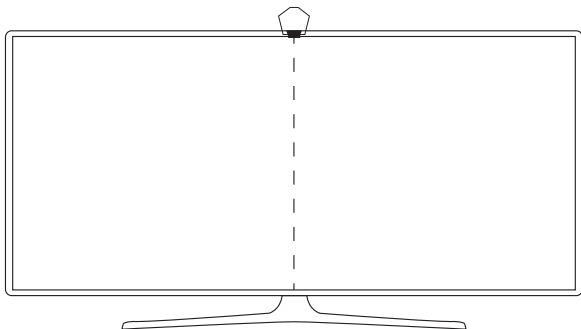

2. Gently place the provided foam stickers to the 7 position points on the screen as shown in the image here.

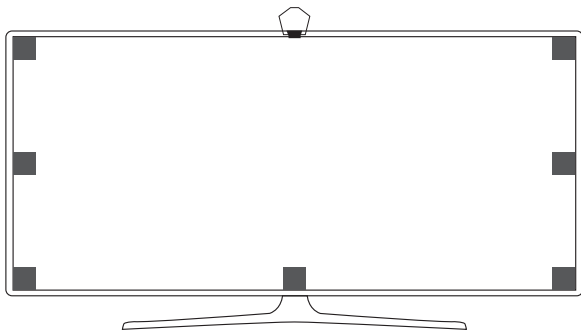

3. Open Govee Home App, go to the "Device Settings" page and click "Calibration". Follow the onscreen instructions to complete calibrating.

**Tips:**

- Drag the position points in the calibration image to the foam stickers located on the screen.

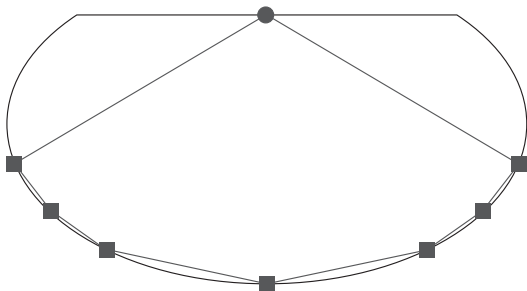

- The image may be warped due to the nature of the fish-eye camera. Make sure the calibration points match up correctly. Note that the calibration lines should not overlap or cross.

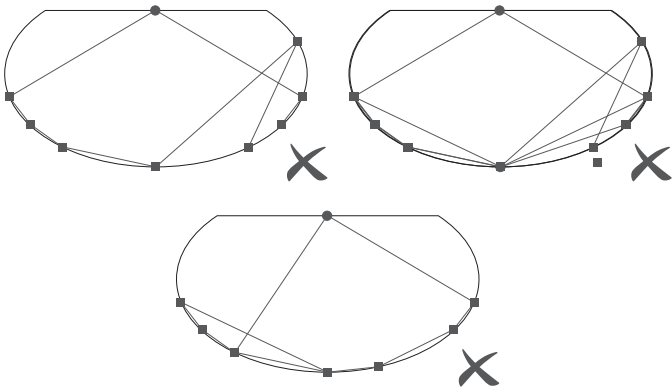

● Camera    ■ Position Points

## Specifications

Power Supply for Adapter	AC 100 - 240V
Power Input	12VDC 3A
Color	RGBIC
Camera Pixel	1080P
Working Temperature	-10°C to 45°C/14°F to 113°F



# Troubleshooting

- ❶ Cannot connect to Wi-Fi.
  - Power on the device to check if it can function properly.
  - Do not skip connecting to Wi-Fi during pairing process.
  - Ensure your Wi-Fi router is 2.4GHz capable (5GHz is not supported).
  - Ensure you entered the correct Wi-Fi password during the Wi-Fi connection process.
  - Use another smartphone to pair with the device to check if your Wi-Fi network is working.
  - Shorten the distance between the device and the Wi-Fi router to less than 50ft, then try reconnecting.
- ❷ In video mode, the light color is not consistent with the color onscreen.
  - Ensure there are no strong external light sources interfering with the camera.
  - Ensure the camera is installed at the top-center of the screen.
  - Make sure the light bars on both side are 1foot away from the monitor, and the light bars should be aligned with the monitor.
  - Face the bars' light-emitting surfaces towards the wall behind to achieve maximized lighting effects.
  - Calibrate the camera again by following the instructions previously provided.
- ❸ Calibration has failed.
  - Check the stability of the Wi-Fi connection. A stable connection is required for successful calibration.
  - Follow the app instructions to calibrate.
- ❹ Cannot pair or connect with Alexa or Google Assistant.
  - Ensure the stability of the Wi-Fi connection.
  - Go to the "Device Settings" page and click "User Guide" to follow the instructions to pair the device again.
- ❺ The synchronization effect for Music mode is not working properly.
  - Ensure the camera is close to the music source, which will help the mic pick up sounds better.

- Try switching the mic source to the smartphone.
  - Make sure your headphones are fully plugged into the camera.
- 6 The mounting clip is not sticking properly
- Wipe the installation surface fully to ensure it is dry and clean.
  - Press the mounting clip firmly against the surface for a few seconds to ensure it is fully secured.
- 7 Only one user can control the device.
- Each device can only be controlled by one account.
  - If multiple users wish to control the same device, ensure they are using the same account.

## Customer Service

 Warranty: 12-Month Limited Warranty

 Support: Lifetime Technical Support

 Email: [support@govee.com](mailto:support@govee.com)

 Official Website: [www.govee.com](http://www.govee.com)

 @Govee    @govee\_official    @govee.official

 @Goveeofficial    @Govee.smarthome

# FCC and ISED Canada Statement

This device complies with Part 15 of the FCC Rules and Industry Canada licence-exempt RSS standard(s). Operation is subject to the following two conditions:

- (1) This device may not cause harmful interference, and
- (2) This device must accept any interference received, including interference that may cause undesired operation.

Warning: Changes or modifications not expressly approved by the party responsible for compliance could void the user's authority to operate the equipment.

Le présent appareil est conforme aux CNR d'Industrie Canada applicables aux appareils radio exempts de licence. L'exploitation est autorisée aux deux conditions suivantes :

- (1) l'appareil ne doit pas produire de brouillage, et
- (2) l'utilisateur de l'appareil doit accepter tout brouillage radioélectrique subi, même si le brouillage est susceptible d'en compromettre le fonctionnement.

**NOTE:** This equipment has been tested and found to comply with the limits for a Class B digital device, pursuant to Part 15 of the FCC Rules.

These limits are designed to provide reasonable protection against harmful interference in a residential installation. This equipment generates uses and can radiate radio frequency energy and, if not installed and used in accordance with the instructions, may cause harmful interference to radio communications. However, there is no guarantee that interference will not occur in a particular installation. If this equipment does cause harmful interference to radio or television reception, which can be determined by turning the equipment off and on, the user is encouraged to try to correct the interference by one or more of the following measures:

1. Reorient or relocate the receiving antenna.
2. Increase the separation between the equipment and receiver.
3. Connect the equipment into an outlet on a circuit different from that to which the receiver is connected.
4. Consult the dealer or an experienced radio/TV technician for help.

This Class B digital apparatus complies with Canadian ICES-005.  
Cet appareil numérique de la classe B est conforme à la norme NMB-005 du Canada.

The Bluetooth® word mark and logos are registered trademarks owned by Bluetooth SIG, Inc. and any use of such marks by Shenzhen Intellirocks Tech. Co., Ltd. is under license.

Govee is a trademark of Shenzhen Intellirocks Tech Co., Ltd.  
Copyright ©2021 Shenzhen Intellirocks Tech Co., Ltd. All Rights Reserved.

# FCC and IC Radiation Exposure Statement

This equipment complies with FCC and IC radiation exposure limits set forth for an uncontrolled environment. This equipment should be installed and operated with minimum distance 20cm between the radiator & your body.

la distance entre l'utilisation et l'appareil ne doit pas être inférieure à 20 cm.

This device uses a non-replaceable light source. When the light source reaches the end of its life cycle, this device should be replaced. Not intended for illumination. Only used for creating ambiance.

- 1.Do not connect the rope light to the supply while it is in the packing or wound onto a reel;
- 2.Do not use the rope light when covered or recessed into a surface;
- 3.Do not open or cut the rope light;

## **Responsible party :**

Name: GOVEE MOMENTS(US) TRADING LIMITED

Address: 13013 WESTERN AVE STE 5 BLUE ISLAND IL 60406-2448

Email: support@govee.com

Contact information: <https://www.govee.com/support>



FOR INDOOR USE ONLY

POUR UNE UTILISATION EN INTÉRIEUR UNIQUEMENT



Govee Home App

For FAQs and more information,  
please visit: [www.govee.com](http://www.govee.com)