

FCC Test Report

Client Name : Beijing Silion Technology Corp.,LTD.

Client Address : 5 Floor, Building A, No.3 Longyu North St.,
Changping District, Beijing, 102200, China

Product Name : RFID module

Report Date : Mar. 28, 2024



Shenzhen Anbotek Compliance Laboratory Limited

Shenzhen Anbotek Compliance Laboratory Limited

Address: 1/F., Building D, Sogood Science and Technology Park, Sanwei Community,
Hangcheng Street, Bao'an District, Shenzhen, Guangdong, China.
Tel: (86) 0755-26066440 Fax: (86) 0755-26014772 Email: service@anbotek.com

Code: AB-RF-05-b



Hotline

400-003-0500

www.anbotek.com.cn



Contents

1. General Information	5
1.1. Client Information	5
1.2. Description of Device (EUT)	5
1.3. Auxiliary Equipment Used During Test	6
1.4. Description of Test Modes	6
1.5. Description Of Test Setup	7
1.6. Test Equipment List	8
1.7. Measurement Uncertainty	9
1.8. Description of Test Facility	9
2. Summary of Test Results	10
3. Conducted Emission Test	11
3.1. Test Standard and Limit	11
3.2. Test Setup	11
3.3. Test Procedure	11
3.4. Test Data	11
4. Radiation Spurious Emission and Band Edge	14
4.1. Test Standard and Limit	14
4.2. Test Setup	14
4.3. Test Procedure	15
4.4. Test Data	16
5. Antenna Requirement	19
5.1. Test Standard and Requirement	19
5.2. Antenna Connected Construction	19
APPENDIX I -- TEST SETUP PHOTOGRAPH	20
APPENDIX II -- EXTERNAL PHOTOGRAPH	20
APPENDIX III -- INTERNAL PHOTOGRAPH	20



TEST REPORT

Applicant : Beijing Silion Technology Corp.,LTD.
Manufacturer : Beijing Silion Technology Corp.,LTD.
Product Name : RFID module
Model No. : SIM7100, SIM3100, SIM5100
Trade Mark : N.A.
Rating(s) : Input: 5V $\overline{=}$ 3A

Test Standard(s) : FCC Part15 Subpart C, Section 15.247

Test Method(s) : ANSI C63.10: 2020

The device described above is tested by Shenzhen Anbotek Compliance Laboratory Limited to determine the maximum emission levels emanating from the device and the severe levels of the device can endure and its performance criterion. The measurement results are contained in this test report and Shenzhen Anbotek Compliance Laboratory Limited is assumed full of responsibility for the accuracy and completeness of these measurements. Also, this report shows that the EUT (Equipment Under Test) is technically compliant with the FCC Part 15 Subpart C requirements.

This report applies to above tested sample only and shall not be reproduced in part without written approval of Shenzhen Anbotek Compliance Laboratory Limited.

Date of receipt

Mar. 15, 2024

Date of Test

Mar. 15, 2024~Mar. 20, 2024

Prepared by

Ella Liang

(Ella Liang)

Approved & Authorized Signer

Edward Pan

(Edward Pan)



Revision History

Report Version	Description	Issued Date
R00	Original Issue.	Mar. 28, 2024

Note 1:

This is the amended report application which was based on the original report 18220WC20246301. The difference between the original device and current one described as following:

1. Change the model name to "SIM7100, SIM3100, SIM5100".
2. Change a few parts of the main board.

Based on the change made to the device, the spurious emission test items were performed.



1. General Information

1.1. Client Information

Applicant	:	Beijing Silion Technology Corp.,LTD.
Address	:	5 Floor, Building A, No.3 Longyu North St., Changping District, Beijing, 102200, China
Manufacturer	:	Beijing Silion Technology Corp.,LTD.
Address	:	5 Floor, Building A, No.3 Longyu North St., Changping District, Beijing, 102200, China
Factory	:	Beijing Silion Technology Corp.,LTD.
Address	:	5 Floor, Building A, No.3 Longyu North St., Changping District, Beijing, 102200, China

1.2. Description of Device (EUT)

Product Name	:	RFID module
Model No.	:	SIM7100, SIM3100, SIM5100 (Note: All samples are the same except the model number, appearance and color, so we prepare "SIM7100" for tests only.)
Trade Mark	:	N.A.
Test Power Supply	:	DC 5V by USB serial via AC 120V, 60Hz for Adapter
Test Sample No.	:	1-2-1(Normal Sample), 1-2-2(Engineering Sample)
Adapter	:	N.A.
RF Specification		
Support Technology	:	<input checked="" type="checkbox"/> RFID
Operation Mode	:	<input type="checkbox"/> DSSS <input checked="" type="checkbox"/> FHSS
Support Bandwidth	:	<input type="checkbox"/> 125KHz <input type="checkbox"/> 250KHz <input checked="" type="checkbox"/> 500KHz
Operation Frequency	:	902.75~927.25MHz
Number of Channel	:	50 Channels
Modulation Type	:	ASK
Antenna Type	:	External Antenna
Antenna Gain(Peak)	:	3.04 dBi(Provided by customer)
Remark: 1) For a more detailed features description, please refer to the manufacturer's specifications or the User's Manual.		



1.3. Auxiliary Equipment Used During Test

Description	Rating(s)
Adapter	Model: PG120D3000G Input: 100-240V~50/60Hz, 1.2A Output: 12.0V=3.0A 36.0W
MacBook Air	Model: A1466 Input: 14.85V/3.05A CMIIT ID:C02HXB48DRVC

1.4. Description of Test Modes

Channel	Freq. (MHz)	Channel	Freq. (MHz)	Channel	Freq. (MHz)	Channel	Freq. (MHz)	Channel	Freq. (MHz)
01	902.75	02	903.25	03	903.75	04	904.25	05	904.75
06	905.25	07	905.75	08	906.25	09	906.75	10	907.25
11	907.75	12	908.25	13	908.75	14	909.25	15	909.75
16	910.25	17	910.75	18	911.25	19	911.75	20	912.25
21	912.75	22	913.25	23	913.75	24	914.25	25	914.75
26	915.25	27	915.75	28	916.25	29	916.75	30	917.25
31	917.75	32	918.25	33	918.75	34	919.25	35	919.75
36	920.25	37	920.75	38	921.25	39	921.75	40	922.25
41	922.75	42	923.25	43	923.75	44	924.25	45	924.75
46	925.25	47	925.75	48	926.25	49	926.75	50	927.25

Note:

1. The engineering test program was provided and the EUT was programmed to be in continuously transmitting mode.
2. EUT was tested with Channel 1, 25 and 50.



1.5. Description Of Test Setup

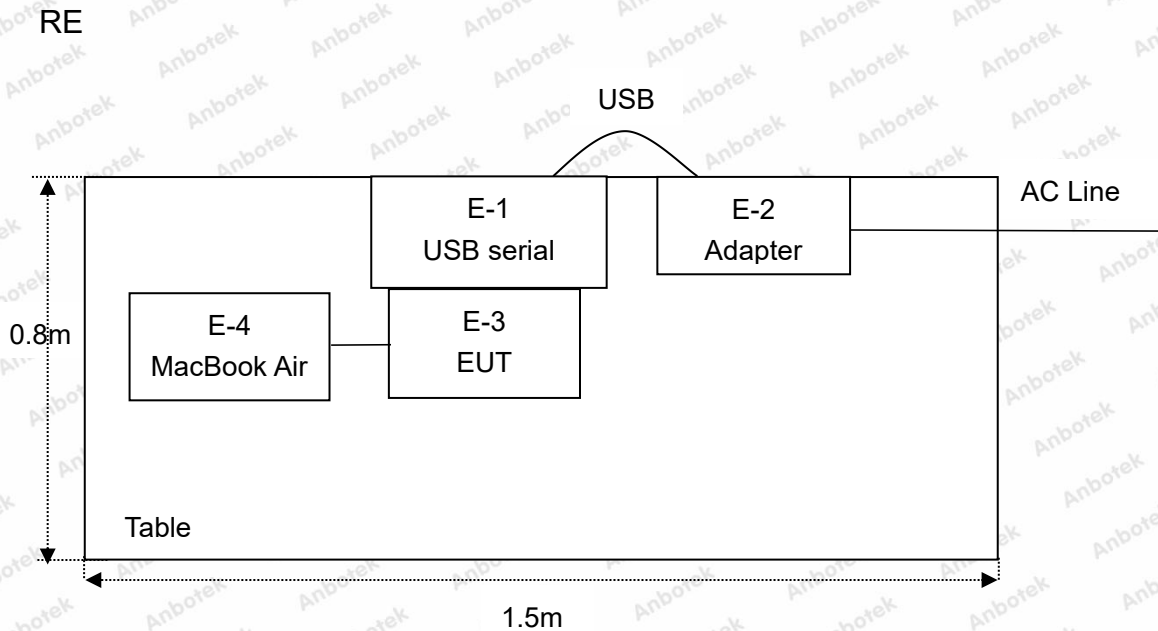
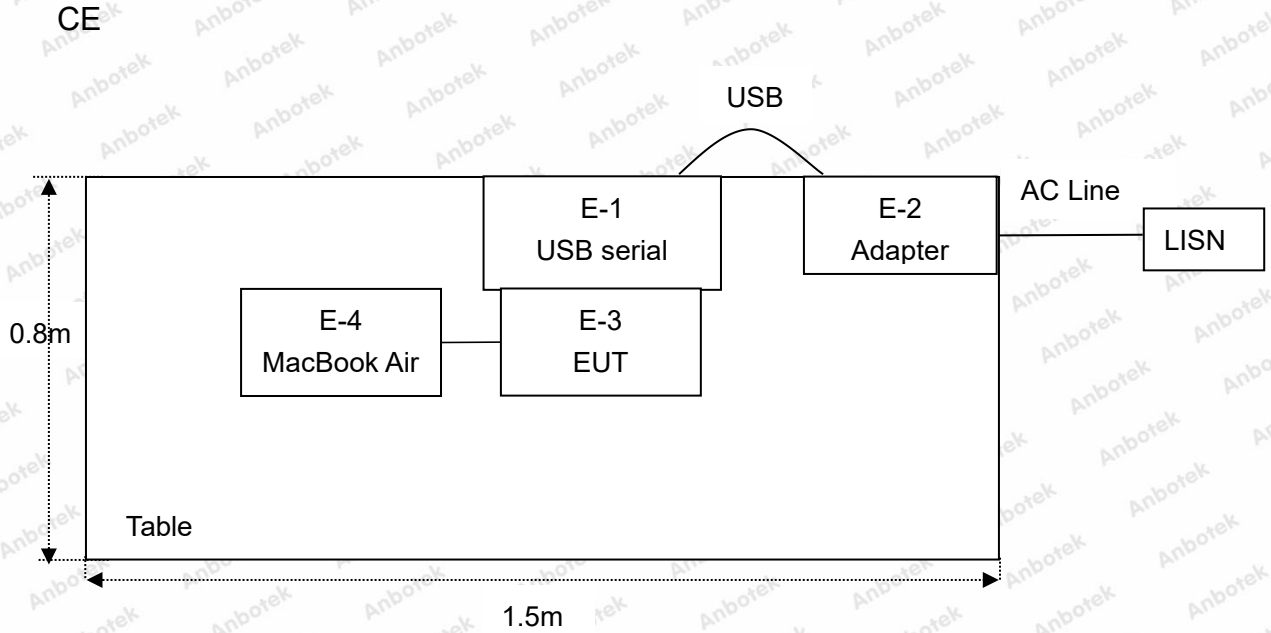

1.6. Test Equipment List

Item	Equipment	Manufacturer	Model No.	Serial No.	Last Cal.	Cal. Interval
1.	L.I.S.N. Artificial Mains Network	Rohde & Schwarz	ENV216	100055	Oct. 12, 2023	1 Year
2.	Three Phase V-type Artificial Power Network	CYBERTEK	EM5040DT	E215040DT001	Jul. 05, 2023	1 Year
3.	EMI Test Receiver	Rohde & Schwarz	ESCI	100627	Oct. 12, 2023	1 Year
4.	EMI Test Receiver	Rohde & Schwarz	ESR26	101481	Oct. 12, 2023	1 Year
5.	MXA Spectrum Analysis	Agilent	N9020A	MY51170037	Oct. 12, 2023	1 Year
6.	EMI Preamplifier	SKET Electronic	LNPA-0118G -45	SKET-PA-002	Oct. 12, 2023	1 Year
7.	Double Ridged Horn Antenna	SCHWARZBECK	BBHA 9120D	02555	Oct. 16, 2022	3 Year
8.	Bilog Broadband Antenna	Schwarzbeck	VULB9163	345	Oct. 23, 2022	3 Year
9.	Loop Antenna	Schwarzbeck	FMZB1519B	00053	Oct. 12, 2023	1 Year
10.	Horn Antenna	A-INFO	LB-180400- KF	J211060628	Oct. 12, 2023	1 Year
11.	Pre-amplifier	SONOMA	310N	186860	Oct. 12, 2023	1 Year
12.	EMI Test Software EZ-EMC	SHURPLE	N/A	N/A	N/A	N/A
13.	MXA Spectrum Analysis	KEYSIGHT	N9020A	MY53280032	Oct. 12, 2023	1 Year
14.	MXG RF Vector Signal Generator	Agilent	N5182A	MY48180656	Oct. 12, 2023	1 Year
15.	Signal Generator	Agilent	E4421B	MY41000743	Oct. 12, 2023	1 Year
16.	DC Power Supply	IVYTECH	IV3605	1804D360510	Oct. 20, 2023	1 Year
17.	Constant Temperature Humidity Chamber	ZHONGJIAN	ZJ-KHWS80 B	N/A	Oct. 16, 2023	1 Year
18.	Spectrum Analyzer	Rohde & Schwarz	FSV40-N	101792	May. 26, 2023	1 Year



1.7. Measurement Uncertainty

Radiation Uncertainty	:	Ur = 3.9 dB (Horizontal)
		Ur = 3.8 dB (Vertical)
Conduction Uncertainty	:	Uc = 3.4 dB

1.8. Description of Test Facility

The test facility is recognized, certified, or accredited by the following organizations:

FCC-Registration No.: 434132

Shenzhen Anbotek Compliance Laboratory Limited, EMC Laboratory has been registered and fully described in a report filed with the (FCC) Federal Communications Commission. The acceptance letter from the FCC is maintained in our files. Registration No. 434132.

ISED-Registration No.: 8058A

Shenzhen Anbotek Compliance Laboratory Limited, EMC Laboratory has been registered and fully described in a report filed with the (ISED) Innovation, Science and Economic Development Canada. The acceptance letter from the ISED is maintained in our files. Registration 8058A.

Test Location

Shenzhen Anbotek Compliance Laboratory Limited.

1/F, Building D, Sogood Science and Technology Park, Sanwei community, Hangcheng Street, Bao'an District, Shenzhen, Guangdong, China.



2. Summary of Test Results

Standard Section	Test Item	Result
15.203/15.247(c)	Antenna Requirement	PASS
15.207	Conducted Emission	PASS
15.205/15.209	Spurious Emission	PASS

Remark: "N/A" is an abbreviation for Not Applicable.



3. Conducted Emission Test

3.1. Test Standard and Limit

Test Standard	FCC Part15 Section 15.207		
	Frequency	Maximum RF Line Voltage (dBuV)	
		Quasi-peak Level	Average Level
Test Limit	150kHz~500kHz	66 ~ 56 *	56 ~ 46 *
	500kHz~5MHz	56	46
	5MHz~30MHz	60	50

Remark: (1) *Decreasing linearly with logarithm of the frequency.
 (2) The lower limit shall apply at the transition frequency.

3.2. Test Setup

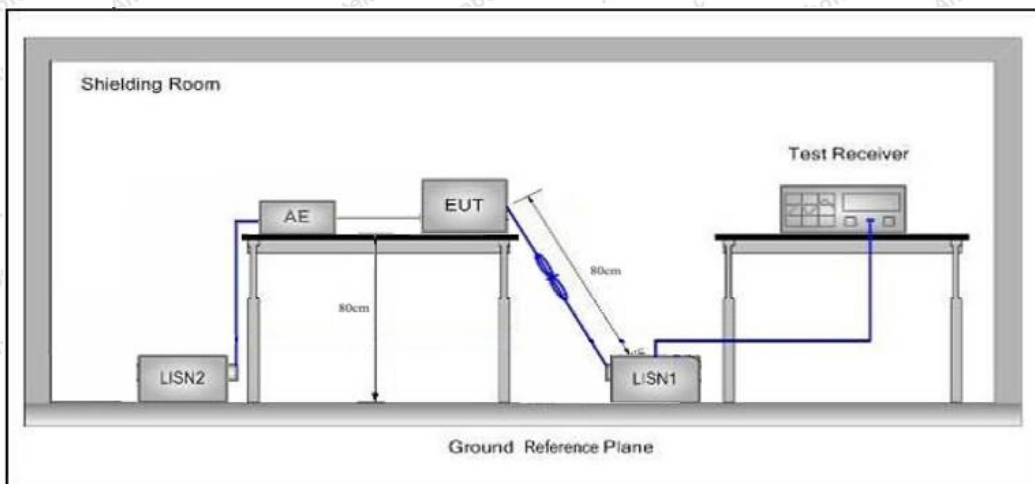

3.3. Test Procedure

The EUT system is connected to the power mains through a line impedance stabilization network (L.I.S.N.). This provides a 50ohm coupling impedance for the EUT system. Please refer the block diagram of the test setup and photographs. Both sides of AC line are checked to find out the maximum conducted emission. In order to find the maximum emission levels, the relative positions of equipment and all of the interface cables shall be changed according to FCC ANSI C63.10: 2020 on Conducted Emission Measurement.

The bandwidth of test receiver (ESCI) set at 9kHz.

The frequency range from 150kHz to 30MHz is checked.

3.4. Test Data

During the test, pre-scan all modes, only the worst case is recorded in the report.

Please to see the following pages.



Conducted Emission Test Data

Test Site: 1# Shielded Room
 Operating Condition: High CH (927.25MHz)
 Test Specification: DC 5V by USB serial via AC 120V, 60Hz for Adapter
 Comment: Live Line
 Temp.(°C)/Hum.(%RH): 23.9°C/45%RH

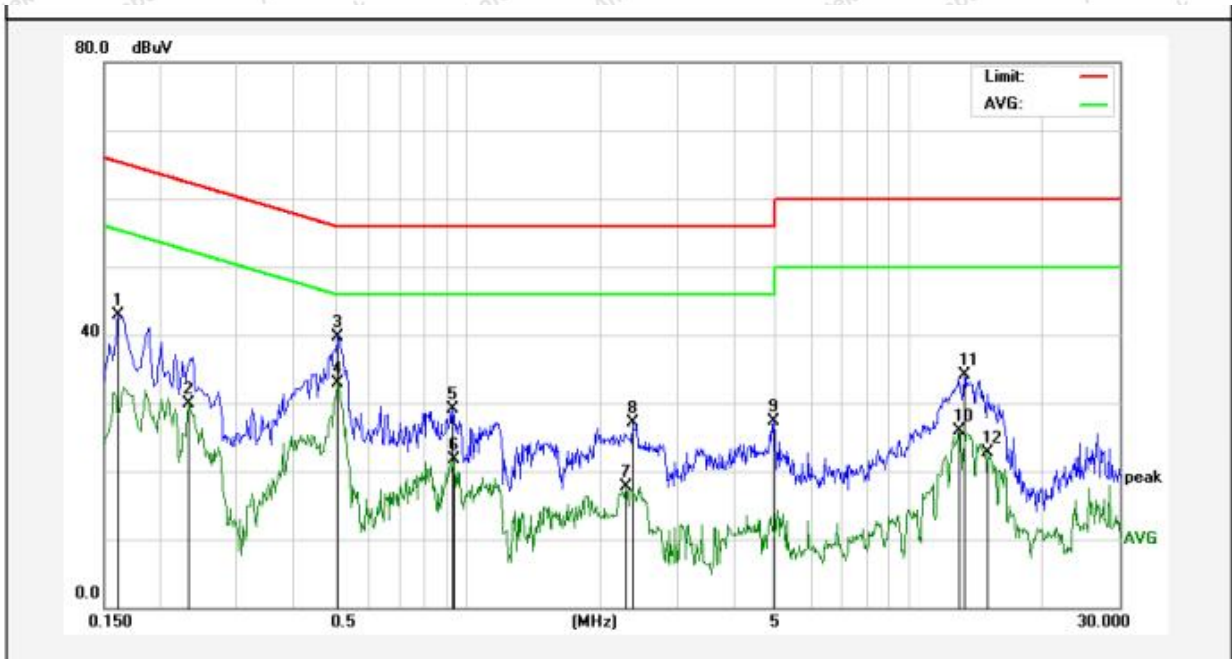

No.	Freq. (MHz)	Reading (dBuV)	Factor (dB)	Result (dBuV)	Limit (dBuV)	Over Limit (dB)	Detector	Remark
1	0.1620	33.27	9.70	42.97	65.36	-22.39	QP	
2	0.2340	20.21	9.71	29.92	52.30	-22.38	AVG	
3	0.5100	29.97	9.76	39.73	56.00	-16.27	QP	
4	0.5100	23.21	9.76	32.97	46.00	-13.03	AVG	
5	0.9260	19.45	9.74	29.19	56.00	-26.81	QP	
6	0.9340	11.94	9.74	21.68	46.00	-24.32	AVG	
7	2.2860	7.91	9.72	17.63	46.00	-28.37	AVG	
8	2.3660	17.31	9.72	27.03	56.00	-28.97	QP	
9	4.9259	17.58	9.74	27.32	56.00	-28.68	QP	
10	13.0379	16.02	9.93	25.95	50.00	-24.05	AVG	
11	13.3978	24.14	9.93	34.07	60.00	-25.93	QP	
12	15.1179	12.66	9.99	22.65	50.00	-27.35	AVG	



Conducted Emission Test Data

Test Site: 1# Shielded Room
 Operating Condition: High CH (927.25MHz)
 Test Specification: DC 5V by USB serial via AC 120V, 60Hz for Adapter
 Comment: Neutral Line
 Temp.(°C)/Hum.(%RH): 23.9°C/45%RH

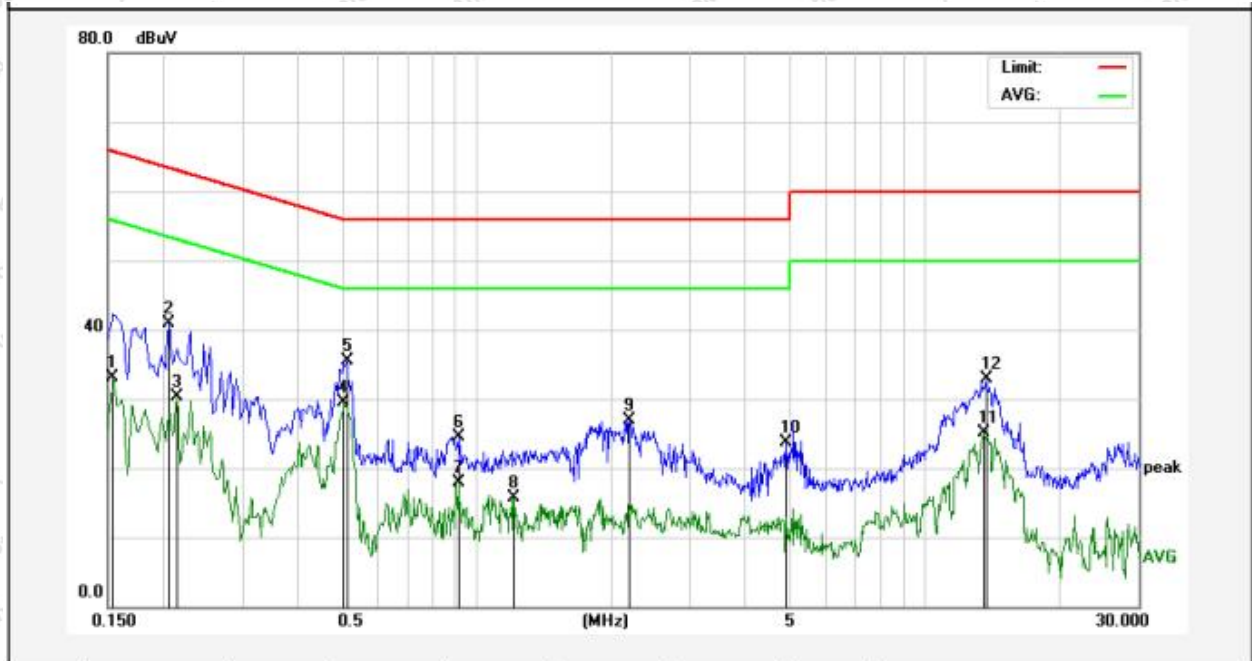

No.	Freq. (MHz)	Reading (dBuV)	Factor (dB)	Result (dBuV)	Limit (dBuV)	Over Limit (dB)	Detector	Remark
1	0.1539	23.38	9.70	33.08	55.78	-22.70	AVG	
2	0.2058	31.16	9.71	40.87	63.37	-22.50	QP	
3	0.2139	20.68	9.71	30.39	53.05	-22.66	AVG	
4	0.5060	19.66	9.76	29.42	46.00	-16.58	AVG	
5	0.5140	25.72	9.76	35.48	56.00	-20.52	QP	
6	0.9100	14.85	9.74	24.59	56.00	-31.41	QP	
7	0.9100	8.15	9.74	17.89	46.00	-28.11	AVG	
8	1.2137	5.99	9.73	15.72	46.00	-30.28	AVG	
9	2.1979	17.18	9.72	26.90	56.00	-29.10	QP	
10	4.9218	13.88	9.74	23.62	56.00	-32.38	QP	
11	13.5976	15.19	9.95	25.14	50.00	-24.86	AVG	
12	13.7057	22.96	9.95	32.91	60.00	-27.09	QP	



4. Radiation Spurious Emission and Band Edge

4.1. Test Standard and Limit

Test Standard	FCC Part15 C Section 15.209 and 15.205				
	Frequency (MHz)	Field strength (microvolt/meter)	Limit (dBuV/m)	Remark	Measurement distance (m)
Test Limit	0.009MHz~0.490MHz	2400/F(kHz)	-	-	300
	0.490MHz~1.705MHz	24000/F(kHz)	-	-	30
	1.705MHz~30MHz	30	-	-	30
	30MHz~88MHz	100	40.0	Quasi-peak	3
	88MHz~216MHz	150	43.5	Quasi-peak	3
	216MHz~960MHz	200	46.0	Quasi-peak	3
	960MHz~1000MHz	500	54.0	Quasi-peak	3
	Above 1000MHz	500	54.0	Average	3
		-	74.0	Peak	3

Remark:

(1)The lower limit shall apply at the transition frequency.

(2) 15.35(b), Unless otherwise specified, the limit on peak radio frequency emissions is 20dB above the maximum permitted average emission limit applicable to the equipment under test. This peak limit applies to the total peak emission level radiated by the device.

4.2. Test Setup

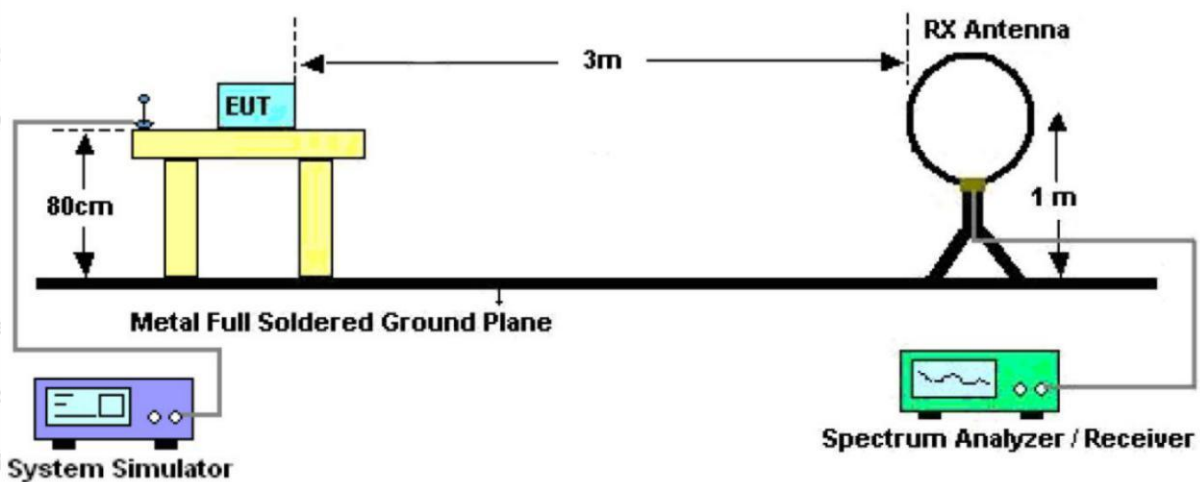

Figure 1. Below 30MHz



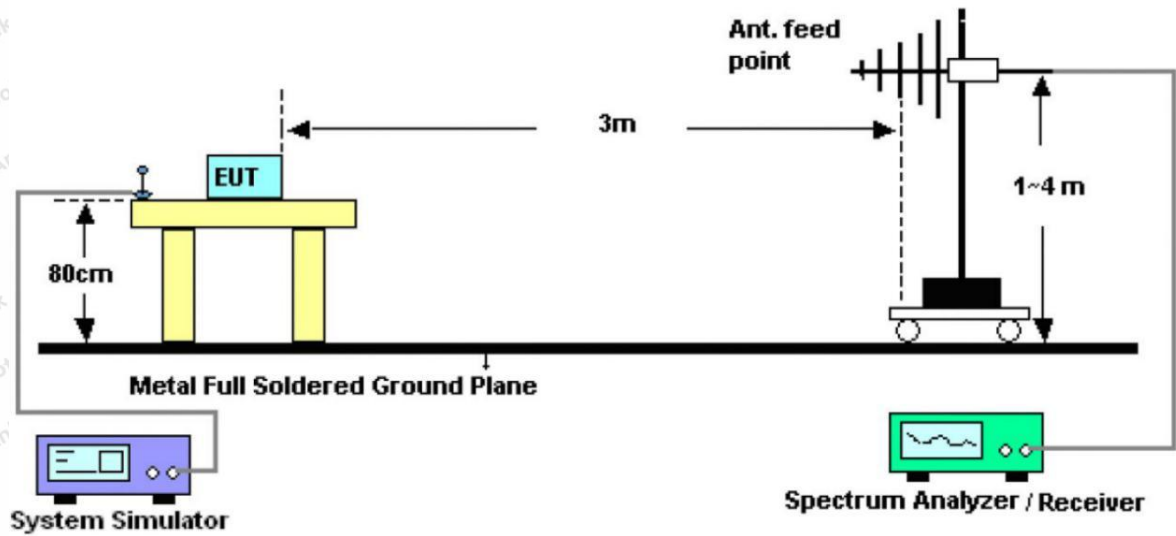

Figure 2. 30MHz to 1GHz

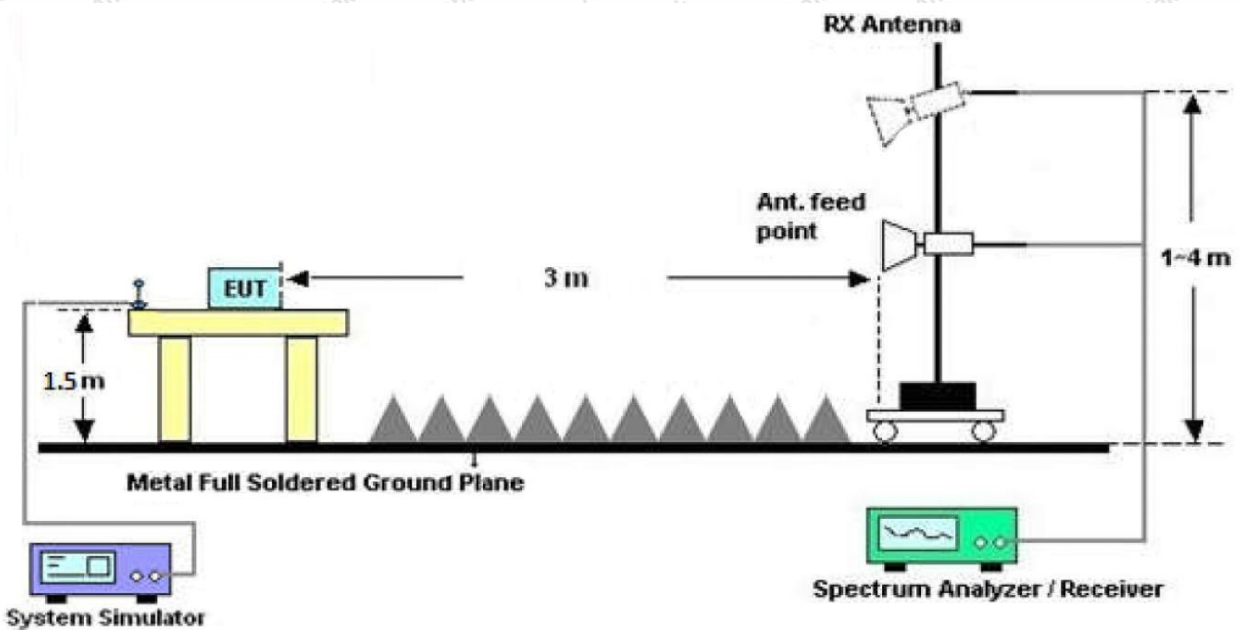

Figure 3. Above 1 GHz

4.3. Test Procedure

For below 1GHz: The EUT is placed on a turntable, which is 0.8m above the ground plane.

For above 1GHz: The EUT is placed on a turntable, which is 1.5m above the ground plane.

The turn table can rotate 360 degrees to determine the position of the maximum emission level. The EUT is set 3 meters away from the receiving antenna which is mounted on a antenna tower. The antenna can be moved up and down from 1 to 4 meters to find out the maximum emission level. Rotated the EUT through three orthogonal axes to determine the maximum emissions, both horizontal and vertical polarization of the antenna are set on test. The EUT is tested in 9*6*6 Chamber. The device is evaluated in xyz orientation.



For the radiated emission test above 1GHz:

Place the measurement antenna away from each area of the EUT determined to be a source of emissions at the specified measurement distance, while keeping the measurement antenna aimed at the source of emissions at each frequency of significant emissions, with polarization oriented for maximum response. The measurement antenna may have to be higher or lower than the EUT, depending on the radiation pattern of the emission and staying aimed at the emission source for receiving the maximum signal. The final measurement antenna elevation shall be that which maximizes the emissions. The measurement antenna elevation for maximum emissions shall be restricted to a range of heights of from 1 m to 4 m above the ground or reference ground plane.

For 9kHz to 150kHz, Set the spectrum analyzer as:

RBW = 200Hz, VBW =1kHz, Detector= Quasi-Peak, Trace mode= Max hold, Sweep- auto couple.

For 150kHz to 30MHz, Set the spectrum analyzer as:

RBW = 9KHz, VBW =30kHz, Detector= Quasi-Peak, Trace mode= Max hold, Sweep- auto couple.

For 30MHz to 1000MHz, Set the spectrum analyzer as:

RBW = 100kHz, VBW =300kHz, Detector= Quasi-Peak, Trace mode= Max hold, Sweep- auto couple.

For above 1GHz, Set the spectrum analyzer as:

RBW =1MHz, VBW =1MHz, Detector= Peak, Trace mode= Max hold, Sweep- auto couple.

RBW =1MHz, VBW =10Hz, Detector= Average, Trace mode= Max hold, Sweep- auto couple.

4.4. Test Data

PASS

During the test, Pre-scan all kind of the place mode (X-axis, Y-axis, Z-axis), and found the X-axis is the worst case.

The test results of 9kHz-30MHz was attenuated more than 20dB below the permissible limits, so the results don't record in the report.

During the test, pre-scan all modes, only the worst case is recorded in the report.



Test Results (30~1000MHz)

Test Mode: High CH (927.25MHz)
 Power Source: DC 5V by USB serial via AC 120V, 60Hz for Adapter
 Polarization: Horizontal
 Temp.(°C)/Hum.(%RH): 23.6°C/47%RH

Fundamental

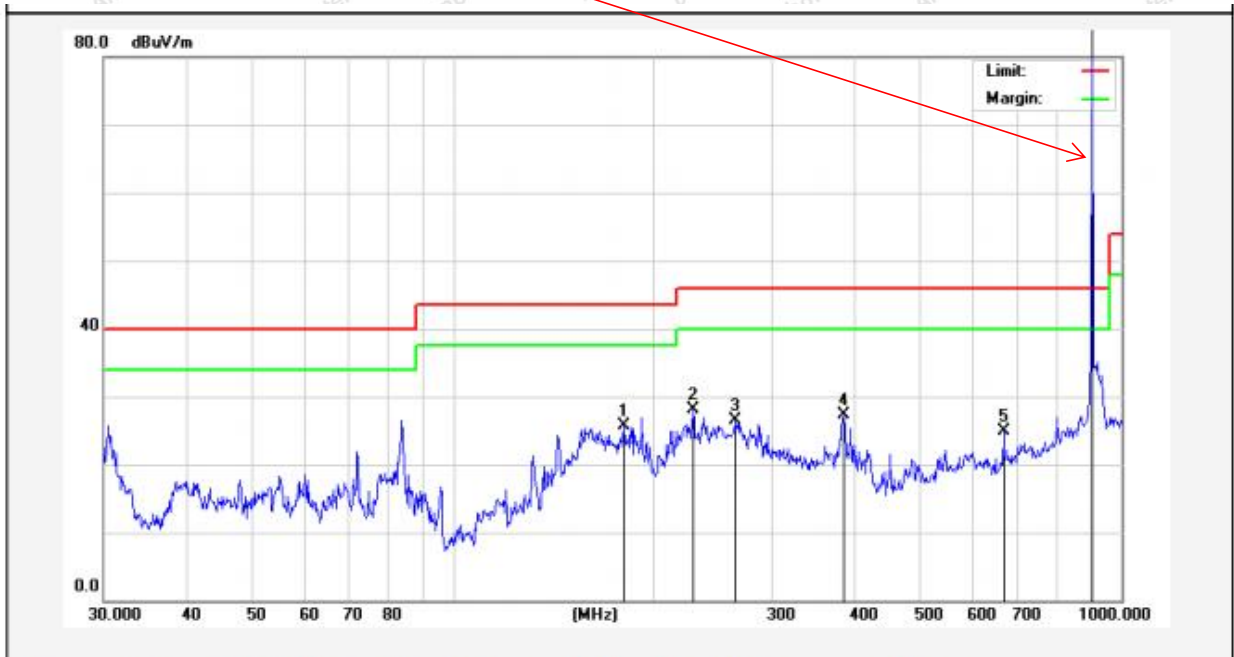

No.	Freq. (MHz)	Reading (dBuV)	Factor (dB/m)	Result (dBuV/m)	Limit (dBuV/m)	Over Limit (dB)	Detector	Height (cm)	degree (deg)	Remark
1	180.0165	48.85	-23.18	25.67	43.50	-17.83	QP			
2	228.4901	49.89	-21.86	28.03	46.00	-17.97	QP			
3	263.8190	46.79	-20.30	26.49	46.00	-19.51	QP			
4	383.9318	43.31	-16.10	27.21	46.00	-18.79	QP			
5	665.8034	35.28	-10.42	24.86	46.00	-21.14	QP			
6	903.3093	108.31	-6.19	102.12	/	/	peak			



Test Results (30~1000MHz)

Test Mode: High CH (927.25MHz)
 Power Source: DC 5V by USB serial via AC 120V, 60Hz for Adapter
 Polarization: Vertical
 Temp.(°C)/Hum.(%RH): 23.6°C/47%RH

Fundamental



No.	Freq. (MHz)	Reading (dBuV)	Factor (dB/m)	Result (dBuV/m)	Limit (dBuV/m)	Over Limit (dB)	Detector	Height (cm)	degree (deg)	Remark
1	131.7573	54.25	-22.60	31.65	43.50	-11.85	QP			
2	191.7450	51.16	-22.68	28.48	43.50	-15.02	QP			
3	278.0668	44.83	-19.06	25.77	46.00	-20.23	QP			
4	487.3149	40.61	-14.20	26.41	46.00	-19.59	QP			
5	672.8444	34.64	-10.32	24.32	46.00	-21.68	QP			
6	903.3093	102.74	-6.19	96.55	/	/	peak			



5. Antenna Requirement

5.1. Test Standard and Requirement

Test Standard	FCC Part15 Section 15.203 /247(c)
Requirement	<p>1) 15.203 requirement: An intentional radiator shall be designed to ensure that no antenna other than that furnished by the responsible party shall be used with the device. The use of a permanently attached antenna or of an antenna that uses a unique coupling to the intentional radiator, the manufacturer may design the unit so that a broken antenna can be replaced by the user, but the use of a standard antenna jack or electrical connector is prohibited.</p> <p>2) 15.247(c) (1)(i) requirement: Systems operating in the 2400-2483.5 MHz band that is used exclusively for fixed. Point-to-point operations may employ transmitting antennas with directional gain greater than 6dBi provided the maximum conducted output power of the intentional radiator is reduced by 1 dB for every 3 dB that the directional gain of the antenna exceeds 6 dBi.</p>

5.2. Antenna Connected Construction

The antenna is External Antenna which permanently attached, and the best case gain of the antenna is 3.04dBi. It complies with the standard requirement.



APPENDIX I -- TEST SETUP PHOTOGRAPH

Please refer to separated files Appendix I -- Test Setup Photograph

APPENDIX II -- EXTERNAL PHOTOGRAPH

Please refer to separated files Appendix II -- External Photograph

APPENDIX III -- INTERNAL PHOTOGRAPH

Please refer to separated files Appendix III -- Internal Photograph

----- End of Report -----

