

# FCC SAR EVALUATION REPORT

In accordance with the requirements of  
FCC 47 CFR Part 2(2.1093), ANSI/IEEE C95.1-1992 and  
IEEE Std 1528-2013

**Product Name :** Mobile Phone

**Trademark :** Easyfone

**Model Name :** Chaperon-T300

**Family Model :** N/A

**Report No. :** STR220517001005E

**FCC ID :** 2AQ8SCHAPERONT300

**Prepared for**

Shen Zhen Yixun Electronic Technology Co., Ltd.  
14D, HuaqiaoXinyuan, WanzhongCity, Xinniu Community, Minzhi St., Longhua Dist.,  
Shenzhen, Guangdong, China

**Prepared by**

Shenzhen NTEK Testing Technology Co., Ltd.  
1/F, Building E, Fenda Science Park, Sanwei Community, Xixiang Street,  
Bao'an District, Shenzhen 518126 P.R.China.  
Tel.: 400-800-6106, 0755-2320 0050, 0755-2320 0090  
Website: <http://www.ntek.org.cn>

### TEST RESULT CERTIFICATION

**Applicant's name** ..... : Shen Zhen Yixun Electronic Technology Co., Ltd.  
 Address ..... : 14D, HuaqiaoXinyuan, WanzhongCity, Xinniu Community, Minzhi St.,  
 Longhua Dist., Shenzhen, Guangdong, China

**Manufacturer's Name**..... : Shen Zhen Yixun Electronic Technology Co., Ltd.  
 Address ..... : 14D, HuaqiaoXinyuan, WanzhongCity, Xinniu Community, Minzhi St.,  
 Longhua Dist., Shenzhen, Guangdong, China

**Product description**

Product name..... : Mobile Phone  
 Trademark ..... : Easyfone  
 Model Name ..... : Chaperon-T300  
 Family Model..... : N/A  
 FCC 47 CFR Part 2(2.1093)

**Standards**..... : ANSI/IEEE C95.1-1992;IEEE Std 1528-2013  
 Published RF exposure KDB procedures

This device described above has been tested by Shenzhen NTEK. In accordance with the measurement methods and procedures specified in IEEE Std 1528-2013 and KDB 865664 D01. Testing has shown that this device is capable of compliance with localized specific absorption rate (SAR) specified in FCC 47 CFR Part 2(2.1093) and ANSI/IEEE C95.1-1992. The test results in this report apply only to the tested sample of the stated device/equipment. Other similar device/equipment will not necessarily produce the same results due to production tolerance and measurement uncertainties.

This report shall not be reproduced except in full, without the written approval of Shenzhen NTEK, this document may be altered or revised by Shenzhen NTEK, personal only, and shall be noted in the revision of the document.

**Date of Test**

Date (s) of performance of tests ..... : May. 20, 2022 ~ Jun. 06, 2022  
 Date of Issue ..... : Jun. 28, 2022  
 Test Result ..... : **Pass**

Prepared By : Jacob . chen  
 (Test Engineer) : (Jacob Chen)

Approved By : Alex  
 (Lab Manager) : (Alex Li)

※ ※ **Revision History** ※ ※

REV.	DESCRIPTION	ISSUED DATE	REMARK
Rev.1.0	Initial Test Report Release	Jun. 28, 2022	Jacob Chen

## TABLE OF CONTENTS

1. General Information .....	6
1.1. RF exposure limits.....	6
1.2. Statement of Compliance .....	7
1.3. EUT Description .....	7
1.4. Test specification(s) .....	9
1.5. Ambient Condition.....	9
2. SAR Measurement System .....	10
2.1. SATIMO SAR Measurement Set-up Diagram .....	10
2.2. Robot .....	11
2.3. E-Field Probe.....	12
2.3.1. E-Field Probe Calibration .....	12
2.4. SAM phantoms .....	13
2.4.1. Technical Data .....	14
2.5. Device Holder .....	15
2.6. Test Equipment List .....	16
3. SAR Measurement Procedures .....	18
3.1. Power Reference .....	18
3.2. Area scan & Zoom scan.....	18
3.3. Description of interpolation/extrapolation scheme .....	20
3.4. Volumetric Scan .....	20
3.5. Power Drift .....	20
4. System Verification Procedure .....	21
4.1. Tissue Verification .....	21
4.1.1. Tissue Dielectric Parameter Check Results .....	22
4.2. System Verification Procedure .....	23
4.2.1. System Verification Results.....	24
5. SAR Measurement variability and uncertainty .....	25
5.1. SAR measurement variability.....	25
5.2. SAR measurement uncertainty .....	25
6. RF Exposure Positions.....	26
6.1. Ear and handset reference point .....	26
6.2. Definition of the cheek position .....	26
6.3. Definition of the tilt position .....	28
6.4. Body Worn Accessory .....	28
7. RF Output Power .....	30
7.1. GSM Conducted Power .....	30
7.2. WCDMA Conducted Power .....	31
7.3. LTE Conducted Power .....	31
7.4. WLAN & Bluetooth Output Power .....	37

8. Stand-alone SAR test exclusion.....	37
9. SAR Results .....	38
9.1. SAR measurement results .....	38
9.1.1. SAR measurement Result of GSM850.....	38
9.1.2. SAR measurement Result of GSM1900.....	39
9.1.3. SAR measurement Result of WCDMA Band 2.....	39
9.1.4. SAR measurement Result of WCDMA Band 5.....	40
9.1.5. SAR measurement Result of LTE Band 2 .....	41
9.1.6. SAR measurement Result of LTE Band 4 .....	42
9.1.7. SAR measurement Result of WLAN 2.4G .....	43
9.2. SAR Summation Scenario.....	44
10. Appendix A. Photo documentation .....	44
11. Appendix B. System Check Plots.....	45
12. Appendix C. Plots of High SAR Measurement.....	54
13. Appendix D. Calibration Certificate .....	83

## 1. General Information

### 1.1. RF exposure limits

(A).Limits for Occupational/Controlled Exposure (W/kg)

Whole-Body	Partial-Body	Hands, Wrists, Feet and Ankles
0.4	8.0	20.0

(B).Limits for General Population/Uncontrolled Exposure (W/kg)

Whole-Body	Partial-Body	Hands, Wrists, Feet and Ankles
0.08	1.6	4.0

NOTE: **Whole-Body SAR** is averaged over the entire body, **partial-body SAR** is averaged over any 1 gram of tissue defined as a tissue volume in the shape of a cube. **SAR for hands, wrists, feet and ankles** is averaged over any 10 grams of tissue defined as a tissue volume in the shape of a cube.

#### **Occupational/Controlled Environments:**

Are defined as locations where there is exposure that may be incurred by people who are aware of the potential for exposure, (i.e. as a result of employment or occupation).

#### **General Population/Uncontrolled Environments:**

Are defined as locations where there is the exposure of individuals who have no knowledge or control of their exposure.

NOTE  
HEAD AND TRUNK LIMIT  
1.6 W/kg  
APPLIED TO THIS EUT

### 1.2. Statement of Compliance

The maximum results of Specific Absorption Rate (SAR) found during testing for Chaperon-T300 are as follows.

RF Exposure Conditions		Equipment Class -Highest Reported SAR (W/kg)			
		PCE	DTS	NII	DSS
1-g Head		1.220	0.143	N/A	N/A
1-g Body-Worn (Separation distance of 10mm)		1.304	0.082	N/A	N/A
Max Simultaneous Tx	Head	1.517	1.363	N/A	1.517
	Body-Worn	1.453	1.386	N/A	1.453

Note: The Max Simultaneous Tx is calculated based on the same configuration and test position. This device is in compliance with Specific Absorption Rate (SAR) for general population/uncontrolled exposure limits (1.6 W/kg) specified in FCC 47 CFR Part 2(2.1093) and ANSI/IEEE C95.1-1992, and had been tested in accordance with the measurement methods and procedures specified in IEEE Std 1528-2013 & KDB 865664 D01.

### 1.3. EUT Description

Device Information			
Product Name	Mobile Phone		
Trade Name	Easyfone		
Model Name	Chaperon-T300		
Family Model	N/A		
FCC ID	2AQ8SCHAPERONT300		
Device Phase	Identical Prototype		
Exposure Category	General population / Uncontrolled environment		
Antenna	PIFA Antenna		
Battery Information	DC 3.7V, 1500mAh, 5.55Wh		
Hard Ware Version	GS052 V1.0		
Soft Ware Version	GS052-Easyfone-Prime-A1-4G-20211117-LC-V1.07		
Device Operating Configurations			
Supporting Mode(s)	GSM 850/1900, WCDMA Band 2/5, LTE Band 2/4, WLAN 2.4G, Bluetooth		
Test Modulation	GSM(GMSK/8PSK), WCDMA(QPSK), LTE(QPSK/16QAM), WLAN(DSSS/OFDM),Bluetooth(GFSK, π/4-DQPSK, 8DPSK),		
Device Class	B		
Operating Frequency Range(s)	Band	Tx (MHz)	Rx (MHz)
	GSM 850	824-849	869-894
	GSM 1900	1850-1910	1930-1990

	WCDMA Band 2	1850-1910	1930-1990
	WCDMA Band 5	824-849	869-894
	LTE Band 2	1850-1910	1930-1990
	LTE Band 4	1710-1755	2110-2155
	WLAN 2.4G	2412-2472	
	Bluetooth	2402-2480	
GPRS Multislot Class(12)	Max Number of Timeslots in Uplink		4
	Max Number of Timeslots in Downlink		4
	Max Total Timeslot		5
EGPRS Multislot Class(12)	Max Number of Timeslots in Uplink		4
	Max Number of Timeslots in Downlink		4
	Max Total Timeslot		5
Power Class	4, tested with power level 5(GSM 850)		
	1, tested with power level 0(GSM 1900)		
	3, tested with power control "all 1"(WCDMA Band 2)		
	3, tested with power control "all 1"(WCDMA Band 5)		
	3, tested with power control all Max.(LTE Band 2)		
	3, tested with power control all Max.(LTE Band 4)		



**1.4. Test specification(s)**

FCC 47 CFR Part 2(2.1093)
ANSI/IEEE C95.1-1992
IEEE Std 1528-2013
KDB 865664 D01 SAR measurement 100 MHz to 6 GHz
KDB 865664 D02 RF Exposure Reporting
KDB 447498 D01 General RF Exposure Guidance
KDB 248227 D01 802.11 Wi-Fi SAR
KDB 941225 D01 3G SAR Procedures
KDB 941225 D05 SAR for LTE Devices
KDB 648474 D04 Handset SAR

**1.5. Ambient Condition**

Ambient temperature	20°C – 24°C
Relative Humidity	30% – 70%

## 2. SAR Measurement System

### 2.1. SATIMO SAR Measurement Set-up Diagram

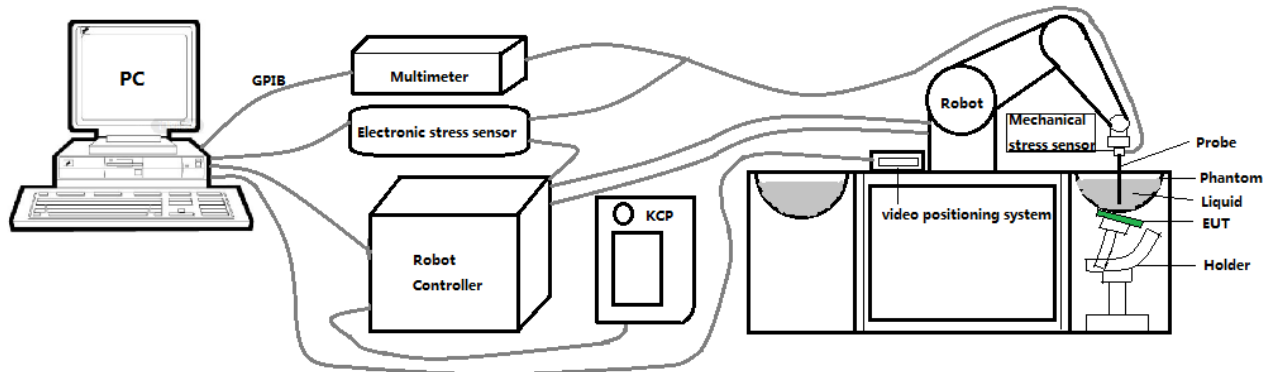

These measurements were performed with the automated near-field scanning system OPENSAR from SATIMO. The system is based on a high precision robot (working range: 901 mm), which positions the probes with a positional repeatability of better than  $\pm 0.03$  mm. The SAR measurements were conducted with dosimetric probe (manufactured by SATIMO), designed in the classical triangular configuration and optimized for dosimetric evaluation.

The first step of the field measurement is the evaluation of the voltages induced on the probe by the device under test. Probe diode detectors are nonlinear. Below the diode compression point, the output voltage is proportional to the square of the applied E-field; above the diode compression point, it is linear to the applied E-field. The compression point depends on the diode, and a calibration procedure is necessary for each sensor of the probe.

The Keithley multimeter reads the voltage of each sensor and send these three values to the PC. The corresponding E field value is calculated using the probe calibration factors, which are stored in the working directory. This evaluation includes linearization of the diode characteristics. The field calculation is done separately for each sensor. Each component of the E field is displayed on the "Dipole Area Scan Interface" and the total E field is displayed on the "3D Interface"

## 2.2. Robot

The SATIMO SAR system uses the high precision robots from KUKA. For the 6-axis controller system, the robot controller version (KUKA) from KUKA is used. The KUKA robot series have many features that are important for our application:



- High precision (repeatability  $\pm 0.03$  mm)
- High reliability (industrial design)
- Jerk-free straight movements
- Low ELF interference (the closed metallic construction shields against motor control fields)

### 2.3. E-Field Probe

This E-field detection probe is composed of three orthogonal dipoles linked to special Schottky diodes with low detection thresholds. The probe allows the measurement of electric fields in liquids such as the one defined in the IEEE and CENELEC standards.

For the measurements the Specific Dosimetric E-Field Probe SN 08/16 EPGO287 with following specifications is used



- Dynamic range: 0.01-100 W/kg
  - Tip Diameter : 2.5 mm
  - Distance between probe tip and sensor center: 1 mm
  - Distance between sensor center and the inner phantom surface: 2 mm (repeatability better than  $\pm 1$  mm).
  - Probe linearity:  $\pm 0.08$  dB
  - Axial isotropy:  $\pm 0.01$  dB
  - Hemispherical Isotropy:  $\pm 0.01$  dB
  - Calibration range: 650MHz to 5900MHz for head & body simulating liquid.
  - Lower detection limit: 8mW/kg
- Angle between probe axis (evaluation axis) and surface normal line: less than  $30^\circ$ .

#### 2.3.1. E-Field Probe Calibration

Each probe needs to be calibrated according to a dosimetric assessment procedure with accuracy better than  $\pm 10\%$ . The spherical isotropy shall be evaluated and within  $\pm 0.25$ dB. The sensitivity parameters (Norm X, Norm Y, and Norm Z), the diode compression parameter (DCP) and the conversion factor (Conv F) of the probe are tested. The calibration data can be referred to appendix D of this report.

## 2.4. SAM phantoms

Photo of SAM phantom SN 16/15 SAM119



The SAM phantom is used to measure the SAR relative to people exposed to electro-magnetic field radiated by mobile phones.

**2.4.1. Technical Data**

Serial Number	Shell thickness	Filling volume	Dimensions	Positionner Material	Permittivity	Loss Tangent
<b>SN 16/15 SAM119</b>	2 mm ±0.2 mm	27 liters	Length:1000 mm Width:500 mm Height:200 mm	Gelcoat with fiberglass	3.4	0.02

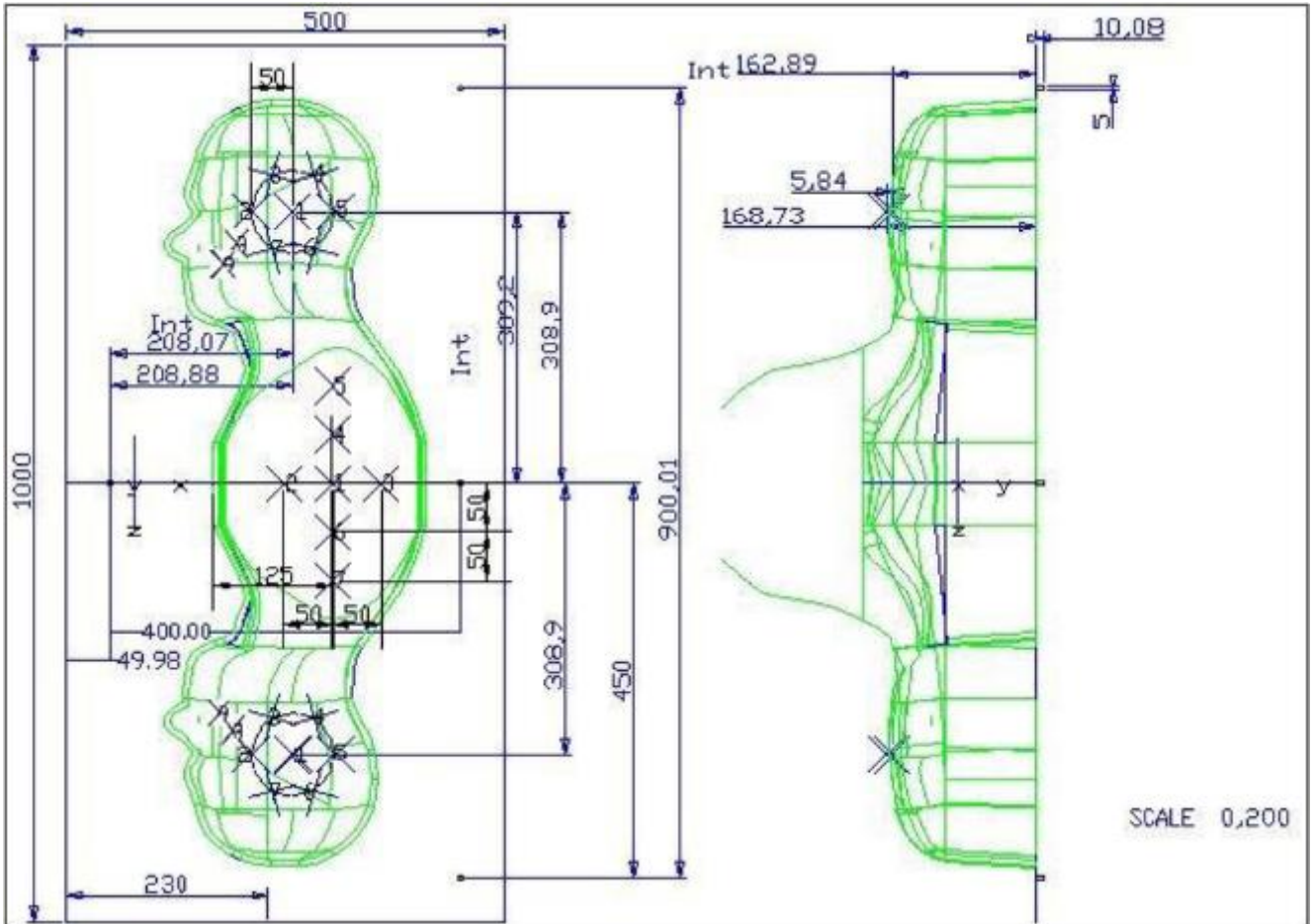

Serial Number	Left Head(mm)		Right Head(mm)		Flat Part(mm)	
	1	2	1	2	1	2
<b>SN 16/15 SAM119</b>	2	2.02	2	2.08	1	2.09
	3	2.05	3	2.06	2	2.06
	4	2.07	4	2.07	3	2.08
	5	2.08	5	2.08	4	2.10
	6	2.05	6	2.07	5	2.10
	7	2.05	7	2.05	6	2.07
	8	2.07	8	2.06	7	2.07
	9	2.08	9	2.06	-	-

The test, based on ultrasonic system, allows measuring the thickness with an accuracy of 10 µm.

## 2.5. Device Holder

The positioning system allows obtaining cheek and tilting position with a very good accuracy. In compliance with CENELEC, the tilt angle uncertainty is lower than 1 degree.

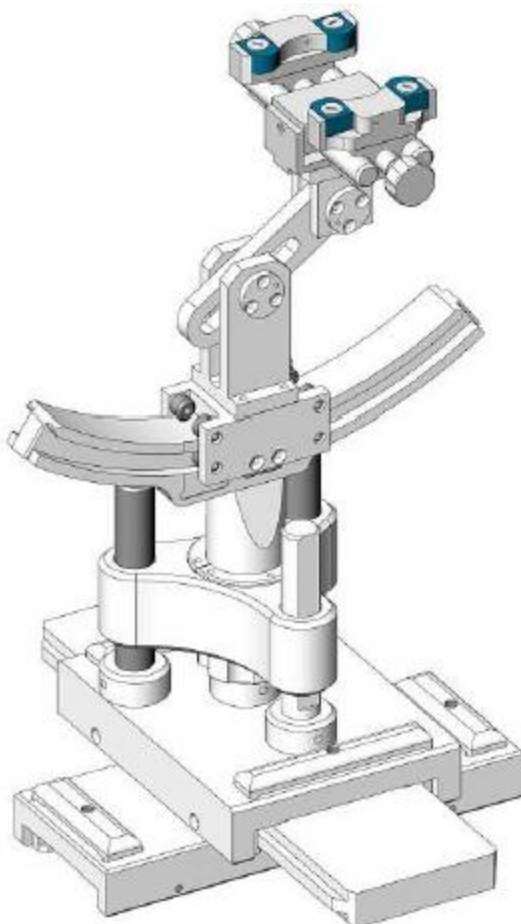

Serial Number	Holder Material	Permittivity	Loss Tangent
SN 16/15 MSH100	Delrin	3.7	0.005

## 2.6. Test Equipment List

This table gives a complete overview of the SAR measurement equipment.

Devices used during the test described are marked

	Manufacturer	Name of Equipment	Type/Model	Serial Number	Calibration	
					Last Cal.	Due Date
<input checked="" type="checkbox"/>	MVG	E FIELD PROBE	SSE2	SN 08/16 EPGO287	Feb. 01, 2022	Jan. 31, 2023
<input type="checkbox"/>	MVG	750 MHz Dipole	SID750	SN 03/15 DIP 0G750-355	Mar. 01, 2021	Feb. 28, 2024
<input checked="" type="checkbox"/>	MVG	835 MHz Dipole	SID835	SN 03/15 DIP 0G835-347	Mar. 01, 2021	Feb. 28, 2024
<input type="checkbox"/>	MVG	900 MHz Dipole	SID900	SN 03/15 DIP 0G900-348	Mar. 01, 2021	Feb. 28, 2024
<input checked="" type="checkbox"/>	MVG	1800 MHz Dipole	SID1800	SN 03/15 DIP 1G800-349	Mar. 01, 2021	Feb. 28, 2024
<input checked="" type="checkbox"/>	MVG	1900 MHz Dipole	SID1900	SN 03/15 DIP 1G900-350	Mar. 01, 2021	Feb. 28, 2024
<input type="checkbox"/>	MVG	2000 MHz Dipole	SID2000	SN 03/15 DIP 2G000-351	Mar. 01, 2021	Feb. 28, 2024
<input checked="" type="checkbox"/>	MVG	2450 MHz Dipole	SID2450	SN 03/15 DIP 2G450-352	Mar. 01, 2021	Feb. 28, 2024
<input type="checkbox"/>	MVG	2600 MHz Dipole	SID2600	SN 03/15 DIP 2G600-356	Mar. 01, 2021	Feb. 28, 2024
<input type="checkbox"/>	MVG	5000 MHz Dipole	SWG5500	SN 13/14 WGA 33	Mar. 01, 2021	Feb. 28, 2024
<input checked="" type="checkbox"/>	MVG	Liquid measurement Kit	SCLMP	SN 21/15 OCPG 72	NCR	NCR
<input checked="" type="checkbox"/>	MVG	Power Amplifier	N.A	AMPLISAR_28/14_003	NCR	NCR
<input checked="" type="checkbox"/>	KEITHLEY	Millivoltmeter	2000	4072790	NCR	NCR
<input checked="" type="checkbox"/>	R&S	Universal radio communication tester	CMU200	117858	Jul. 01, 2021	Jun. 30, 2022
<input checked="" type="checkbox"/>	R&S	Wideband radio communication tester	CMW500	103917	Jul. 01, 2021	Jun. 30, 2022
<input checked="" type="checkbox"/>	HP	Network Analyzer	8753D	3410J01136	Jul. 01, 2021	Jun. 30, 2022
<input checked="" type="checkbox"/>	Agilent	PSG Analog Signal Generator	E8257D	MY51110112	Jul. 01, 2021	Jun. 30, 2022



<input checked="" type="checkbox"/>	Agilent	Power meter	E4419B	MY45102538	Jul. 01, 2021	Jun. 30, 2022
<input checked="" type="checkbox"/>	Agilent	Power sensor	E9301A	MY41495644	Jul. 01, 2021	Jun. 30, 2022
<input checked="" type="checkbox"/>	Agilent	Power sensor	E9301A	US39212148	Jul. 01, 2021	Jun. 30, 2022
<input checked="" type="checkbox"/>	MCLI/USA	Directional Coupler	CB11-20	0D2L51502	Jul. 17, 2020	Jul. 16, 2023

### 3. SAR Measurement Procedures

The measurement procedures are as follows:

<Conducted power measurement>

- (a) For WWAN power measurement, use base station simulator to configure EUT WWAN transmission in conducted connection with RF cable, at maximum power in each supported wireless interface and frequency band.
- (b) Read the WWAN RF power level from the base station simulator.
- (c) For WLAN/Bluetooth power measurement, use engineering software to configure EUT WLAN/Bluetooth continuously transmission, at maximum RF power in each supported wireless interface and frequency band.
- (d) Connect EUT RF port through RF cable to the power meter, and measure WLAN/Bluetooth output power.

<SAR measurement>

- (a) Use base station simulator to configure EUT WWAN transmission in radiated connection, and engineering software to configure EUT WLAN/Bluetooth continuously transmission, at maximum RF power, in the highest power channel.
- (b) Place the EUT in the positions as Appendix A demonstrates.
- (c) Set scan area, grid size and other setting on the OPENSAR software.
- (d) Measure SAR results for the highest power channel on each testing position.
- (e) Find out the largest SAR result on these testing positions of each band.
- (f) Measure SAR results for other channels in worst SAR testing position if the reported SAR of highest power channel is larger than 0.8 W/kg.

According to the test standard, the recommended procedure for assessing the peak spatial-average SAR value consists of the following steps:

- (a) Power reference measurement
- (b) Area scan
- (c) Zoom scan
- (d) Power drift measurement

#### 3.1. Power Reference

The Power Reference Measurement and Power Drift Measurements are for monitoring the power drift of the device under test in the batch process. The minimum distance of probe sensors to surface determines the closest measurement point to phantom surface. This distance cannot be smaller than the distance of sensor calibration points to probe tip as defined in the probe properties.

#### 3.2. Area scan & Zoom scan

The area scan is a 2D scan to find the hot spot location on the DUT. The zoom scan is a 3D scan above the hot spot to calculate the 1g and 10g SAR value.

Measurement of the SAR distribution with a grid of 8 to 16 mm \* 8 to 16 mm and a constant distance to the inner surface of the phantom. Since the sensors cannot directly measure at the inner phantom surface, the values between the sensors and the inner phantom surface are extrapolated. With these values the area of the maximum SAR is calculated by an interpolation scheme. Around this point, a cube of 30 \* 30 \* 30 mm or 32 \* 32 \* 32 mm is assessed by measuring 5 or 8 \* 5 or 8 \* 4 or 5 mm. With these data, the peak spatial-average SAR value can be calculated.

From the scanned SAR distribution, identify the position of the maximum SAR value, in addition identify the positions of any local maxima with SAR values within 2 dB of the maximum value that will not be within the zoom scan of other peaks; additional peaks shall be measured only when the primary peak is within 2 dB of the SAR compliance limit (e.g., 1 W/kg for 1,6 W/kg 1 g limit, or 1,26 W/kg for 2 W/kg, 10 g limit).

Area scan & Zoom scan scan parameters extracted from FCC KDB 865664 D01 SAR measurement 100 MHz to 6 GHz.

		≤ 3 GHz	> 3 GHz	
Maximum distance from closest measurement point (geometric center of probe sensors) to phantom surface		5 ± 1 mm	½·δ·ln(2) ± 0.5 mm	
Maximum probe angle from probe axis to phantom surface normal at the measurement location		30° ± 1°	20° ± 1°	
Maximum area scan spatial resolution: Δx <sub>Area</sub> , Δy <sub>Area</sub>		≤ 2 GHz: ≤ 15 mm 2 – 3 GHz: ≤ 12 mm	3 – 4 GHz: ≤ 12 mm 4 – 6 GHz: ≤ 10 mm	
		When the x or y dimension of the test device, in the measurement plane orientation, is smaller than the above, the measurement resolution must be ≤ the corresponding x or y dimension of the test device with at least one measurement point on the test device.		
Maximum zoom scan spatial resolution: Δx <sub>Zoom</sub> , Δy <sub>Zoom</sub>		≤ 2 GHz: ≤ 8 mm 2 – 3 GHz: ≤ 5 mm*	3 – 4 GHz: ≤ 5 mm* 4 – 6 GHz: ≤ 4 mm*	
Maximum zoom scan spatial resolution, normal to phantom surface	uniform grid: Δz <sub>Zoom</sub> (n)	≤ 5 mm	3 – 4 GHz: ≤ 4 mm 4 – 5 GHz: ≤ 3 mm 5 – 6 GHz: ≤ 2 mm	
	graded grid	Δz <sub>Zoom</sub> (1): between 1 <sup>st</sup> two points closest to phantom surface	≤ 4 mm	3 – 4 GHz: ≤ 3 mm 4 – 5 GHz: ≤ 2.5 mm 5 – 6 GHz: ≤ 2 mm
		Δz <sub>Zoom</sub> (n>1): between subsequent points	≤ 1.5·Δz <sub>Zoom</sub> (n-1)	
Minimum zoom scan volume	x, y, z	≥ 30 mm	3 – 4 GHz: ≥ 28 mm 4 – 5 GHz: ≥ 25 mm 5 – 6 GHz: ≥ 22 mm	

Note: δ is the penetration depth of a plane-wave at normal incidence to the tissue medium; see draft standard IEEE P1528-2011 for details.

\* When zoom scan is required and the *reported* SAR from the *area scan based 1-g SAR estimation* procedures of KDB 447498 is ≤ 1.4 W/kg, ≤ 8 mm, ≤ 7 mm and ≤ 5 mm zoom scan resolution may be applied, respectively, for 2 GHz to 3 GHz, 3 GHz to 4 GHz and 4 GHz to 6 GHz.

### 3.3. Description of interpolation/extrapolation scheme

The local SAR inside the phantom is measured using small dipole sensing elements inside a probe body. The probe tip must not be in contact with the phantom surface in order to minimise measurements errors, but the highest local SAR will occur at the surface of the phantom.

An extrapolation is used to determine these highest local SAR values. The extrapolation is based on a fourth-order least-square polynomial fit of measured data. The local SAR value is then extrapolated from the liquid surface with a 1 mm step.

The measurements have to be performed over a limited time (due to the duration of the battery) so the step of measurement is high. It could vary between 5 and 8 mm. To obtain an accurate assessment of the maximum SAR averaged over 10 grams and 1 gram requires a very fine resolution in the three dimensional scanned data array.

### 3.4. Volumetric Scan

The volumetric scan consists of a full 3D scan over a specific area. This 3D scan is useful for multi Tx SAR measurement. Indeed, it is possible with OpenSAR to add, point by point, several volumetric scans to calculate the SAR value of the combined measurement as it is defined in the standard IEEE1528 and IEC62209.

### 3.5. Power Drift

All SAR testing is under the EUT installed with a full charged battery and transmit maximum output power. In OpenSAR measurement software, the power reference measurement and power drift measurement procedures are used for monitoring the power drift of EUT during SAR test. Both these procedures measure the field at a specified reference position before and after the SAR testing. The software will calculate the field difference in V/m. If the power drifts more than  $\pm 5\%$ , the SAR will be retested.

## 4. System Verification Procedure

### 4.1. Tissue Verification

The following tissue formulations are provided for reference only as some of the parameters have not been thoroughly verified. The composition of ingredients may be modified accordingly to achieve the desired target tissue parameters required for routine SAR evaluation.

Ingredients (% of weight)	Head Tissue									
	750	835	900	1800	1900	2000	2450	2600	5200	5800
Frequency Band (MHz)										
Water	34.40	34.40	34.40	55.36	55.36	57.87	57.87	57.87	65.53	65.53
NaCl	0.79	0.79	0.79	0.35	0.35	0.16	0.16	0.16	0.00	0.00
1,2-Propanediol	64.81	64.81	64.81	0.00	0.00	0.00	0.00	0.00	0.00	0.00
Triton X-100	0.00	0.00	0.00	30.45	30.45	19.97	19.97	19.97	24.24	24.24
DGBE	0.00	0.00	0.00	13.84	13.84	22.00	22.00	22.00	10.23	10.23

For SAR measurement of the field distribution inside the phantom, the phantom must be filled with homogeneous tissue simulating liquid to a depth of at least 15 cm. For head SAR testing, the liquid depth from the ear reference point (ERP) of the phantom to the liquid top surface is larger than 15 cm.

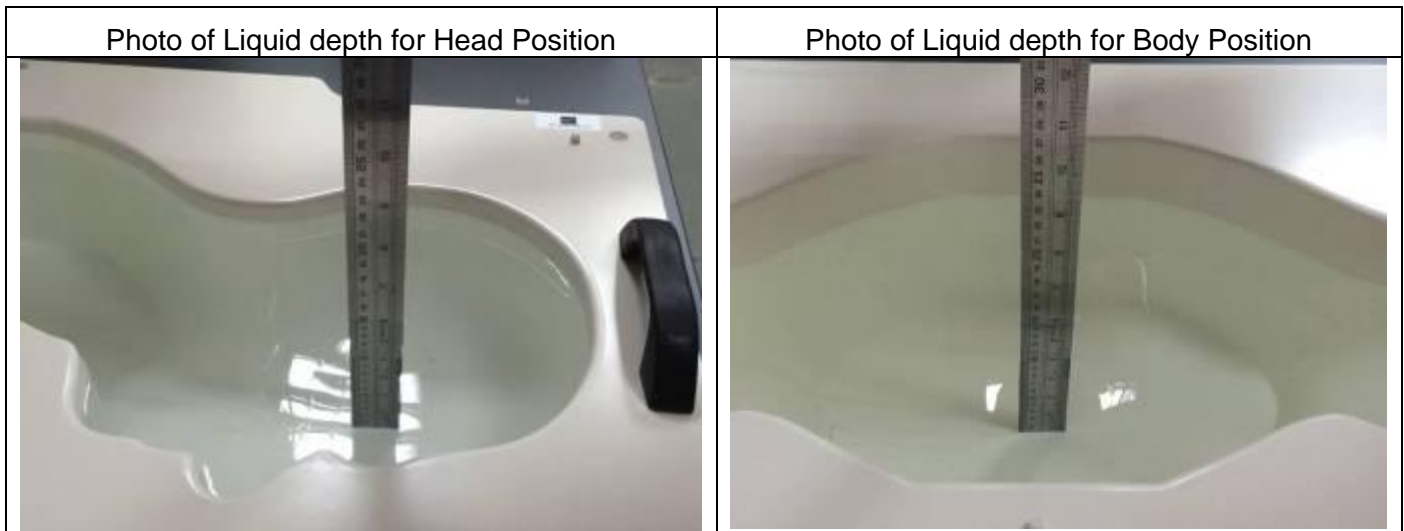

#### 4.1.1. Tissue Dielectric Parameter Check Results

The simulating liquids should be checked at the beginning of a series of SAR measurements to determine if the dielectric parameters are within the tolerances of the specified target values. The measured conductivity and relative permittivity should be within  $\pm 5\%$  of the target values.

Tissue Type	Measured Frequency (MHz)	Target Tissue		Measured Tissue		Liquid Temp.	Test Date
		$\epsilon_r (\pm 5\%)$	$\sigma$ (S/m) ( $\pm 5\%$ )	$\epsilon_r$	$\sigma$ (S/m)		
Head 850	835	41.50 (39.43~43.58)	0.90 (0.86~0.95)	41.90	0.91	21.8 °C	May. 25, 2022
Head 1800	1800	40.00 (38.00~42.00)	1.40 (1.33~1.47)	38.63	1.38	21.3 °C	May. 20, 2022
Head 1900	1900	40.00 (38.00~42.00)	1.40 (1.33~1.47)	38.18	1.47	21.6 °C	May. 24, 2022
Head 2450	2450	39.20 (37.24~41.16)	1.80 (1.71~1.89)	38.28	1.78	21.5 °C	Jun. 06, 2022

NOTE: The dielectric parameters of the tissue-equivalent liquid should be measured under similar ambient conditions and within 2 °C of the conditions expected during the SAR evaluation to satisfy protocol requirements.

## 4.2. System Verification Procedure

The system verification is performed for verifying the accuracy of the complete measurement system and performance of the software. The dipole is connected to the signal source consisting of signal generator and amplifier via a directional coupler, N-connector cable and adaption to SMA. It is fed with a power of 100mW (below 5GHz) or 100mW (above 5GHz). To adjust this power a power meter is used. The power sensor is connected to the cable before the system verification to measure the power at this point and do adjustments at the signal generator. At the outputs of the directional coupler both return loss as well as forward power are controlled during the system verification to make sure that emitted power at the dipole is kept constant. This can also be checked by the power drift measurement after the test (result on plot).

The system verification is shown as below picture:

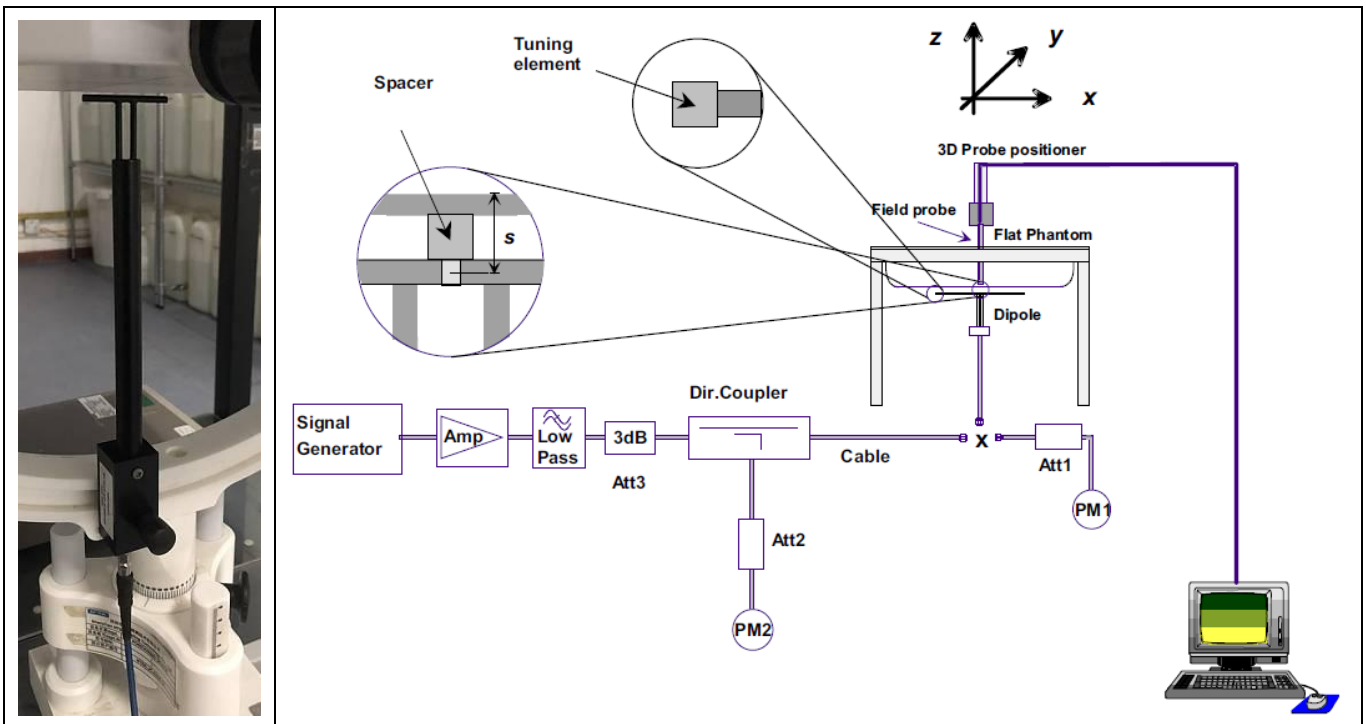

**4.2.1. System Verification Results**

Comparing to the original SAR value provided by SATIMO, the verification data should be within its specification of  $\pm 10\%$ . Below table shows the target SAR and measured SAR after normalized to 1W input power. The table below indicates the system performance verification can meet the variation criterion and the plots can be referred to Appendix B of this report.

System Verification	Target SAR (1W) ( $\pm 10\%$ )		Measured SAR (Normalized to 1W)		Liquid Temp.	Test Date
	1-g (W/Kg)	10-g (W/Kg)	1-g (W/Kg)	10-g (W/Kg)		
835MHz	9.84 (8.86~10.82)	6.22 (5.60~6.84)	10.43	6.25	21.8 °C	May. 25, 2022
1800MHz	37.96 (34.17~41.75)	19.81 (17.83~21.79)	35.98	18.56	21.3 °C	May. 20, 2022
1900MHz	40.37 (36.34~44.40)	20.48 (18.44~22.52)	37.05	20.84	21.6 °C	May. 24, 2022
2450MHz	53.69 (48.33~59.05)	23.94 (21.55~26.33)	58.57	25.34	21.5 °C	Jun. 06, 2022



## 5. SAR Measurement variability and uncertainty

### 5.1. SAR measurement variability

Per KDB865664 D01 SAR measurement 100 MHz to 6 GHz, SAR measurement variability must be assessed for each frequency band, which is determined by the SAR probe calibration point and tissue-equivalent medium used for the device measurements. The additional measurements are repeated after the completion of all measurements requiring the same head or body tissue-equivalent medium in a frequency band. The test device should be returned to ambient conditions (normal room temperature) with the battery fully charged before it is re-mounted on the device holder for the repeated measurement(s) to minimize any unexpected variations in the repeated results.

- 1) Repeated measurement is not required when the original highest measured SAR is  $< 0.80$  W/kg; steps 2) through 4) do not apply.
- 2) When the original highest measured SAR is  $\geq 0.80$  W/kg, repeat that measurement once.
- 3) Perform a second repeated measurement only if the ratio of largest to smallest SAR for the original and first repeated measurements is  $> 1.20$  or when the original or repeated measurement is  $\geq 1.45$  W/kg (~ 10% from the 1-g SAR limit).
- 4) Perform a third repeated measurement only if the original, first or second repeated measurement is  $\geq 1.5$  W/kg and the ratio of largest to smallest SAR for the original, first and second repeated measurements is  $> 1.20$ .

### 5.2. SAR measurement uncertainty

Per KDB865664 D01 SAR Measurement 100 MHz to 6 GHz, when the highest measured 1-g SAR within a frequency band is  $< 1.5$  W/kg, the extensive SAR measurement uncertainty analysis described in IEEE Std 1528-2013 is not required in SAR reports submitted for equipment approval. The equivalent ratio (1.5/1.6) is applied to extremity and occupational exposure conditions.

## 6. RF Exposure Positions

### 6.1. Ear and handset reference point

Figure 6.1.1 shows the front, back, and side views of the SAM phantom. The center-of-mouth reference point is labeled “M”, the left ear reference point (ERP) is marked “LE”, and the right ERP is marked “RE”.



Fig 6.1.1 Front, back, and side views of SAM phantom

### 6.2. Definition of the cheek position

1. Define two imaginary lines on the handset, the vertical centerline and the horizontal line. The vertical centerline passes through two points on the front side of the handset: the midpoint of the width  $w_t$  of the handset at the level of the acoustic output (point A in Figure 6.2.1 and Figure 6.2.2), and the midpoint of the width  $w_b$  of the bottom of the handset (point B). The horizontal line is perpendicular to the vertical centerline and passes through the center of the acoustic output (see Figure 6.2.1). The two lines intersect at point A. Note that for many handsets, point A coincides with the center of the acoustic output; however, the acoustic output may be located elsewhere on the horizontal line. Also note that the vertical centerline is not necessarily parallel to the front face of the handset (see Figure 6.2.2), especially for clamshell handsets, handsets with flip covers, and other irregularly-shaped handsets.
2. Position the handset close to the surface of the phantom such that point A is on the (virtual) extension of the line passing through points RE and LE on the phantom (see Figure 6.2.3), such that the plane defined by the vertical centerline and the horizontal line of the handset is approximately parallel to the sagittal plane of the phantom.
3. Translate the handset towards the phantom along the line passing through RE and LE until handset point A touches the pinna at the ERP
4. While maintaining the handset in this plane, rotate it around the LE-RE line until the vertical centerline is in the plane normal to the plane containing B-M and N-F lines, i.e., the Reference Plane.
5. Rotate the handset around the vertical centerline until the handset (horizontal line) is parallel to the N-F line.

6. While maintaining the vertical centerline in the Reference Plane, keeping point A on the line passing through RE and LE, and maintaining the handset contact with the pinna, rotate the handset about the N-F line until any point on the handset is in contact with a phantom point below the pinna on the cheek. See Figure 6.2.3. The actual rotation angles should be documented in the test report.

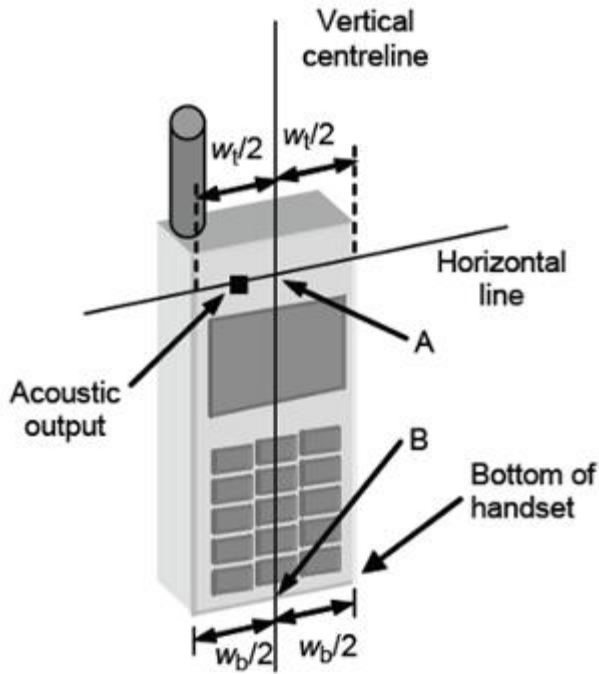

Fig 6.2.1 Handset vertical and horizontal reference lines—“fixed case”

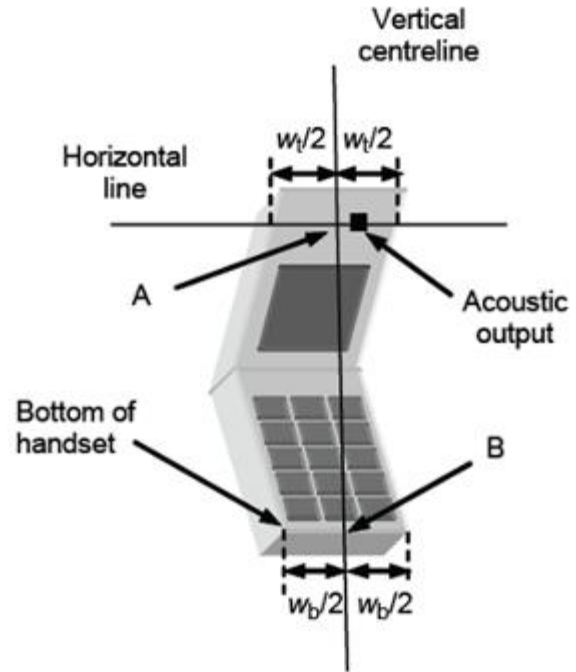

Fig 6.2.2 Handset vertical and horizontal reference lines—“clam-shell case”

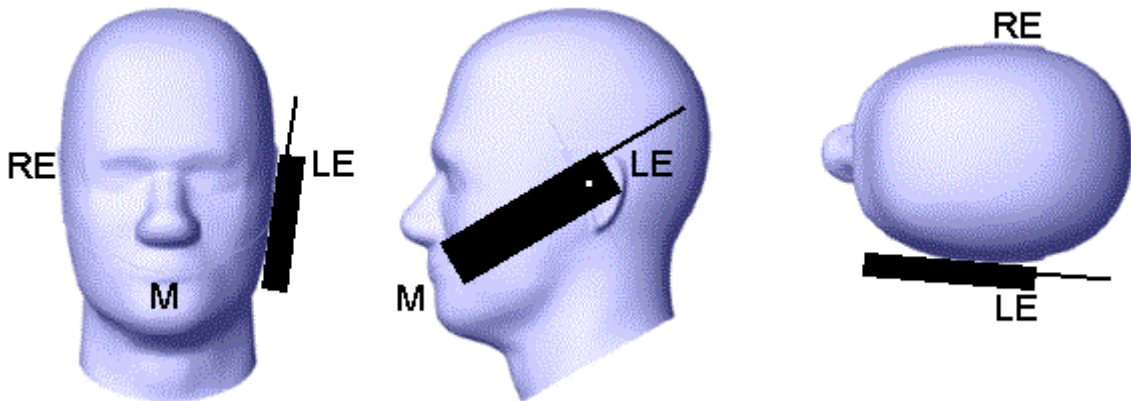

Fig 6.2.3 cheek or touch position. The reference points for the right ear (RE), left ear (LE), and mouth (M), which establish the Reference Plane for handset positioning, are indicated.

### 6.3. Definition of the tilt position

1. While maintaining the orientation of the handset, retract the handset parallel to the reference plane far enough away from the phantom to enable a rotation of the device by 15 degree.
2. Rotate the Handset around the horizontal line by 15 degree (see Figure 6.3.1).
3. While maintaining the orientation of the handset, move the handset towards the phantom on a line passing through RE and LE until any part of the handset touches the ear. The tilt position is obtained when the contact is on the pinna. If the contact is at any location other than the pinna, e.g., the antenna with the back of the phantom head, the angle of the handset shall be reduced. In this case, the tilt position is obtained if any part of the handset is in contact with the pinna as well as a second part of the handset is in contact with the phantom, e.g., the antenna with the back of the head.

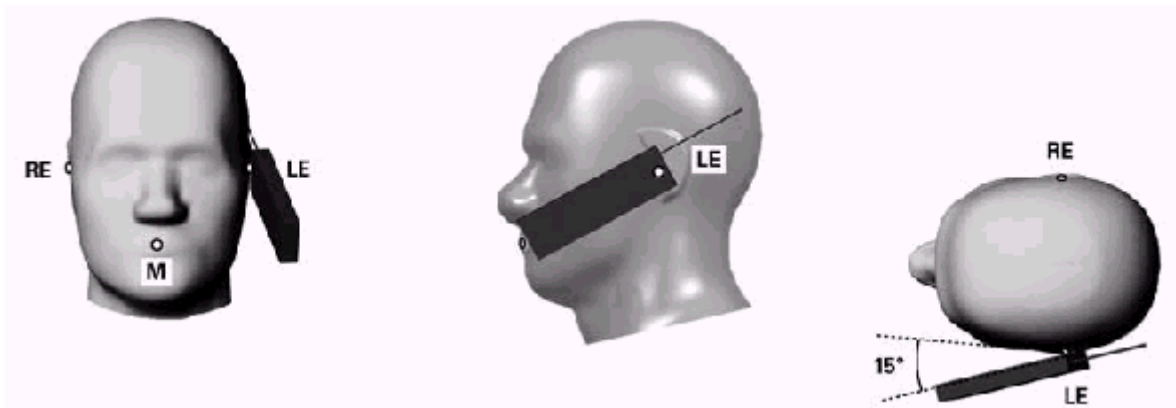

Figure 6.3.1 – Tilt position of the wireless device on the left side of SAM

### 6.4. Body Worn Accessory

1. Body-worn operating configurations are tested with the belt-clips and holsters attached to the device and positioned against a flat phantom in a normal use configuration (see Figure 6.4.1). Per KDB 648474 D04, body-worn accessory exposure is typically related to voice mode operations when handsets are carried in body-worn accessories. The body-worn accessory procedures in FCC KDB 447498 D01 should be used to test for body-worn accessory SAR compliance, without a headset connected to it. This enables the test results for such configuration to be compatible with that required for hotspot mode when the body-worn accessory test separation distance is greater than or equal to that required for hotspot mode, when applicable. When the reported SAR for body-worn accessory, measured without a headset connected to the handset is  $< 1.2$  W/kg, the highest reported SAR configuration for that wireless mode and frequency band should be repeated for that body-worn accessory with a handset attached to the handset.
2. Accessories for body-worn operation configurations are divided into two categories: those that do not contain metallic components and those that do contain metallic components and those that do contain metallic components. When multiple accessories that do not contain metallic components are supplied with the device, the device is tested with only the accessory that dictates the closest

spacing to the body. Then multiple accessories that contain metallic components are test with the device with each accessory. If multiple accessories share an identical metallic component (i.e. the same metallic belt-chip used with different holsters with no other metallic components) only the accessory that dictates the closest spacing to the body is tested.

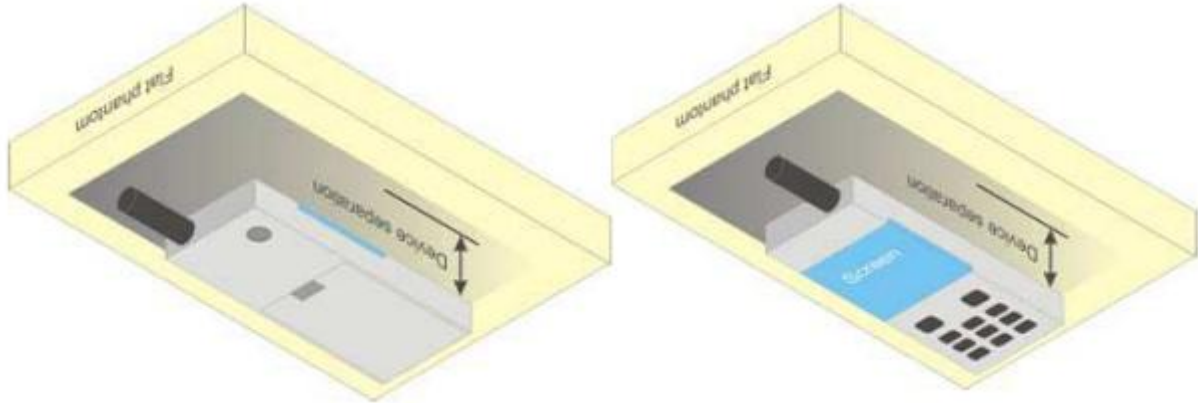

Figure 6.4.1 – Test positions for body-worn devices

## 7. RF Output Power

### 7.1. GSM Conducted Power

Band GSM850		Burst-Averaged output Power (dBm)			Frame-Averaged output Power (dBm)			
Tx Channel	Tune-up	128	189	251	Tune-up	128	189	251
Frequency (MHz)	(dBm)	824.2	836.4	848.8	(dBm)	824.2	836.4	848.8
GSM (GMSK)	34.00	33.50	33.66	33.49	24.97	24.47	24.63	24.46
GPRS(GMSK,1 Tx slot)	34.00	33.49	33.64	33.44	24.97	24.46	24.61	24.41
GPRS(GMSK,2 Tx slot)	31.50	31.35	31.44	31.25	25.48	25.33	25.42	25.23
GPRS(GMSK,3 Tx slot)	29.50	29.43	29.49	29.32	25.24	25.17	25.23	25.06
GPRS(GMSK,4 Tx slot)	27.50	27.17	27.21	27.04	24.49	24.16	24.20	24.03
EGPRS(8PSK,1 Tx slot)	27.50	26.39	27.18	26.25	18.47	17.36	18.15	17.22
EGPRS(8PSK,2 Tx slot)	26.50	25.38	26.49	25.23	20.48	19.36	20.47	19.21
EGPRS(8PSK,3 Tx slot)	23.50	21.89	23.22	22.20	19.24	17.63	18.96	17.94
EGPRS(8PSK,4 Tx slot)	21.00	19.43	20.58	19.70	17.99	16.42	17.57	16.69
Band GSM1900		Burst-Averaged output Power (dBm)			Frame-Averaged output Power (dBm)			
Tx Channel	Tune-up	512	661	810	Tune-up	512	661	810
Frequency (MHz)	(dBm)	1850.2	1880.0	1909.8	(dBm)	1850.2	1880.0	1909.8
GSM (GMSK)	30.50	30.35	30.46	30.49	21.47	21.32	21.43	21.46
GPRS(GMSK,1 Tx slot)	31.00	30.37	30.50	30.51	21.97	21.34	21.47	21.48
GPRS(GMSK,2 Tx slot)	28.50	28.40	28.17	27.90	22.48	22.38	22.15	21.88
GPRS(GMSK,3 Tx slot)	27.00	26.92	26.65	26.35	22.74	22.66	22.39	22.09
GPRS(GMSK,4 Tx slot)	25.00	24.91	24.65	24.34	21.99	21.90	21.64	21.33
EGPRS(8PSK,1 Tx slot)	27.50	27.14	27.37	26.61	18.47	18.11	18.34	17.58
EGPRS(8PSK,2 Tx slot)	26.50	25.82	26.15	24.93	20.48	19.80	20.13	18.91
EGPRS(8PSK,3 Tx slot)	23.50	22.79	23.40	22.59	19.24	18.53	19.14	18.33
EGPRS(8PSK,4 Tx slot)	21.50	20.21	21.48	19.72	18.49	17.20	18.47	16.71

Note: The frame-averaged power is linearly scaled the maximum burst averaged power over 8 time slots.

The calculated method are shown as below:

Frame-averaged power = Maximum burst averaged power (1 TS) - 9.03 dB

Frame-averaged power = Maximum burst averaged power (2 TS) - 6.02 dB

Frame-averaged power = Maximum burst averaged power (3 TS) - 4.26 dB

Frame-averaged power = Maximum burst averaged power (4 TS) - 3.01 dB

**7.2. WCDMA Conducted Power**

Band	WCDMA Band 2			
Tx Channel	Tune-up	9262	9400	9538
Frequency (MHz)		1852.4	1880	1907.6
RMC 12.2Kbps	23.50	23.35	23.37	23.44
HSDPA Subtest-1	23.50	23.05	22.78	22.55
HSDPA Subtest-2	23.00	22.65	22.44	22.16
HSDPA Subtest-3	22.50	22.19	22.16	21.76
HSDPA Subtest-4	22.50	22.23	22.02	21.80
HSUPA Subtest-1	23.00	22.91	22.54	22.30
HSUPA Subtest-2	23.00	22.90	22.68	22.43
HSUPA Subtest-3	23.00	22.57	22.31	22.14
HSUPA Subtest-4	23.00	22.85	22.72	22.47
HSUPA Subtest-5	23.00	22.77	22.42	22.16
Band	WCDMA Band 5			
Tx Channel	Tune-up	4132	4182	4233
Frequency (MHz)		826.4	836.4	846.6
RMC12.2K	23.50	23.28	23.08	23.04
HSDPA Sub 1	23.00	22.52	22.49	22.58
HSDPA Sub 2	22.50	22.23	22.26	22.35
HSDPA Sub 3	22.50	21.91	21.98	22.13
HSDPA Sub 4	22.00	21.88	21.91	21.85
HSUPA Sub 1	22.50	22.45	22.46	22.41
HSUPA Sub 2	23.00	22.48	22.43	22.57
HSUPA Sub 3	22.50	22.01	21.99	22.46
HSUPA Sub 4	23.00	22.41	22.49	22.54
HSUPA Sub 5	22.50	22.28	22.41	22.24

**7.3. LTE Conducted Power**

Band	Band Width	Modulation	RB Configuration		Tune-up (dBm)	Channel/Frequency(MHz)		
			RB Size	RB Offset		18607/1850.7	18900/1880	19193/1909.3
LTE Band 2	1.4MHz	QPSK	1	0	24.50	23.68	24.17	24.29
			1	2	24.50	23.95	24.24	24.29
			1	5	24.50	23.91	24.25	24.27
			3	0	24.50	24.07	24.06	24.20
			3	1	24.50	24.10	24.14	24.17

		16QAM	3	2	24.50	24.09	24.08	24.21
			6	0	23.50	22.94	23.07	23.10
			1	0	24.00	23.40	23.28	23.46
			1	2	24.00	23.40	23.29	23.52
			1	5	24.00	23.33	23.26	23.44
			3	0	24.00	23.42	23.21	23.59
			3	1	24.00	23.45	23.16	23.58
			3	2	24.00	23.38	23.18	23.57
			6	0	22.50	22.27	22.12	22.38
Band	Band Width	Modulation	RB Configuration		Tune-up (dBm)	Channel/Frequency(MHz)		
			RB Size	RB Offset		18615/1851.5	18900/1880	19185/1908.5
LTE Band 2	3MHz	QPSK	1	0	24.50	22.87	24.32	24.16
			1	7	24.50	23.85	24.33	24.10
			1	14	24.50	23.93	24.31	24.15
			8	0	23.50	22.99	23.10	23.08
			8	4	23.50	22.90	23.09	23.06
			8	7	23.50	22.81	23.00	23.13
			15	0	23.50	22.95	23.07	23.12
		16QAM	1	0	24.00	23.03	23.76	23.23
			1	7	24.00	23.03	23.75	23.34
			1	14	24.00	23.05	23.74	23.31
			8	0	22.50	22.03	22.07	22.29
			8	4	22.50	22.01	22.08	22.30
			8	7	22.50	22.04	22.06	22.27
			15	0	22.50	22.11	22.14	22.20
Band	Band Width	Modulation	RB Configuration		Tune-up (dBm)	Channel/Frequency(MHz)		
			RB Size	RB Offset		18625/1852.5	18900/1880	19175/1907.5
LTE Band 2	5MHz	QPSK	1	0	24.50	24.00	23.89	24.11
			1	12	24.50	23.90	23.88	24.15
			1	24	24.50	23.99	23.92	24.11
			12	0	23.50	22.89	23.05	23.17
			12	6	23.50	22.95	23.11	23.01
			12	11	23.50	22.93	22.96	23.09
			25	0	23.50	22.91	23.08	23.00
		16QAM	1	0	24.00	22.73	23.09	23.72
			1	12	24.00	22.73	23.08	23.74



Band	Band Width	Modulation	RB Configuration		Tune-up (dBm)	Channel/Frequency(MHz)		
			RB Size	RB Offset		18650/1855	18900/1880	19150/1905
			1	24	24.00	22.76	23.05	23.73
			12	0	22.50	21.90	22.26	22.22
			12	6	22.50	21.90	22.17	22.28
			12	11	22.50	21.91	22.18	22.23
			25	0	22.50	22.16	22.15	22.38
LTE Band 2	10MHz	QPSK	1	0	24.50	23.92	24.06	24.28
			1	24	24.50	23.94	24.11	24.30
			1	49	24.50	23.89	24.04	24.35
			25	0	23.50	22.97	23.04	23.06
			25	12	23.50	22.88	23.19	23.12
			25	24	23.50	22.97	23.09	23.09
			50	0	23.50	23.00	23.12	23.06
		16QAM	1	0	24.50	24.14	23.72	23.51
			1	24	24.50	24.15	23.79	23.54
			1	49	24.50	24.12	23.79	23.54
			25	0	22.50	21.99	22.29	22.26
			25	12	22.50	22.04	22.24	22.25
			25	24	22.50	22.04	22.21	22.33
Band	Band Width	Modulation	RB Configuration		Tune-up (dBm)	Channel/Frequency(MHz)		
			RB Size	RB Offset		18675/1857.5	18900/1880	19125/1902.5
LTE Band 2	15MHz	QPSK	1	0	24.50	22.97	24.35	24.09
			1	37	24.50	23.93	24.32	24.17
			1	74	24.50	23.95	24.33	24.16
			36	0	23.50	22.92	23.02	23.02
			36	18	23.50	23.00	22.97	23.11
			36	37	23.50	22.85	23.03	23.11
			75	0	23.50	22.95	23.00	23.06
		16QAM	1	0	24.50	24.18	24.18	23.87
			1	37	24.50	24.18	24.22	23.79
			1	74	24.50	24.16	24.27	23.85
			36	0	22.50	22.14	22.18	22.30
			36	18	22.50	22.07	22.24	22.29
			36	37	22.50	22.10	22.15	22.37
Band	Band	Modulation	RB		Tune-up	Channel/Frequency(MHz)		

	Width		Configuration		(dBm)			
			RB Size	RB Offset		18700/1860	18900/1880	19100/1900
LTE Band 2	20MHz	QPSK	1	0	24.50	24.17	23.98	23.93
			1	49	24.50	24.08	24.01	23.85
			1	99	24.50	24.24	24.03	24.00
			50	0	23.50	23.07	23.08	23.16
			50	24	23.50	22.85	23.17	23.04
			50	49	23.50	22.96	23.10	23.21
		16QAM	100	0	23.50	23.01	23.14	23.00
			1	0	24.00	22.84	22.72	23.47
			1	49	24.00	22.73	22.79	23.40
			1	99	24.00	22.81	22.71	23.51
			50	0	22.50	22.21	22.13	22.20
			50	24	22.50	22.17	22.20	22.26
			50	49	22.50	22.20	22.28	22.29

Band	Band Width	Modulation	RB Configuration		Tune-up (dBm)	Channel/Frequency(MHz)		
			RB Size	RB Offset		19957/1710.7	20175/1732.5	20393/1754.3
LTE Band 4	1.4MHz	QPSK	1	0	23.00	22.53	22.09	22.62
			1	2	23.00	22.62	22.13	22.56
			1	5	23.00	22.57	22.17	22.55
			3	0	23.00	22.49	22.16	22.47
			3	1	23.00	22.56	22.18	22.41
			3	2	23.00	22.52	22.15	22.34
		16QAM	6	0	21.50	21.45	21.12	21.31
			1	0	23.00	22.63	21.93	21.97
			1	2	23.00	22.56	21.99	21.91
			1	5	23.00	22.64	21.93	22.01
			3	0	22.00	21.75	21.36	21.83
			3	1	22.00	21.81	21.32	21.74
			3	2	22.00	21.74	21.36	21.68
			6	0	21.00	20.65	20.21	20.54
Band	Band Width	Modulation	RB Configuration		Tune-up (dBm)	Channel/Frequency(MHz)		
			RB Size	RB Offset		19965/1711.5	20175/1732.5	20385/1753.5
LTE	3MHz	QPSK	1	0	23.00	22.43	22.16	22.62

Band 4			1	7	23.00	22.47	22.11	22.61
			1	14	23.00	22.42	22.16	22.55
			8	0	22.00	21.55	21.15	21.31
			8	4	22.00	21.51	21.20	21.33
			8	7	22.00	21.41	21.16	21.27
			15	0	22.00	21.59	21.16	21.33
			15	0	21.00	20.61	20.39	20.48
		16QAM	1	0	23.00	22.75	21.93	21.87
			1	7	23.00	22.79	22.01	21.98
			1	14	23.00	22.67	21.95	22.00
			8	0	21.00	20.54	20.43	20.48
			8	4	21.00	20.50	20.57	20.45
			8	7	21.00	20.40	20.52	20.40
			15	0	21.00	20.61	20.39	20.48
Band	Band Width	Modulation	RB Configuration		Tune-up (dBm)	Channel/Frequency(MHz)		
			RB Size	RB Offset		19975/1712.5	20175/1732.5	20375/1752.5
LTE Band 4	5MHz	QPSK	1	0	22.50	22.36	22.20	22.24
			1	12	22.50	22.23	22.24	22.22
			1	24	22.50	22.24	22.23	22.18
			12	0	22.00	21.50	21.20	21.30
			12	6	22.00	21.38	21.09	21.36
			12	11	22.00	21.38	21.08	21.32
			25	0	21.50	21.37	21.09	21.27
		16QAM	1	0	22.00	21.75	20.82	21.54
			1	12	22.00	21.65	20.83	21.52
			1	24	22.00	21.69	20.88	21.52
			12	0	21.00	20.52	20.09	20.45
			12	6	21.00	20.42	20.23	20.48
			12	11	21.00	20.35	20.14	20.47
			25	0	20.50	20.47	20.37	20.44
Band	Band Width	Modulation	RB Configuration		Tune-up (dBm)	Channel/Frequency(MHz)		
			RB Size	RB Offset		20000/1715	20175/1732.5	20350/1750
LTE Band 4	10MHz	QPSK	1	0	23.00	22.52	22.15	22.61
			1	24	23.00	22.29	22.19	22.71
			1	49	23.00	22.28	22.22	22.64
			25	0	21.50	21.31	21.14	21.38
			25	12	21.50	21.32	21.22	21.36

Band	Band Width	Modulation	RB Configuration		Tune-up (dBm)	Channel/Frequency(MHz)		
			RB Size	RB Offset		20025/1717.5	20175/1732.5	20325/1747.5
		16QAM	25	24	21.50	21.30	21.15	21.31
			50	0	21.50	21.47	21.18	21.39
			1	0	23.00	22.68	21.32	21.65
			1	24	23.00	22.62	21.28	21.71
			1	49	23.00	22.59	21.30	21.65
			25	0	21.00	20.43	20.29	20.51
			25	12	21.00	20.42	20.37	20.46
			25	24	21.00	20.43	20.39	20.52
			50	0	21.00	20.48	20.36	20.53
LTE Band 4	15MHz	QPSK	1	0	23.00	22.54	22.27	22.15
			1	37	23.00	22.28	22.16	22.29
			1	74	23.00	22.23	22.26	22.19
			36	0	21.50	21.29	21.10	21.40
			36	18	21.50	21.38	21.19	21.40
			36	37	21.50	21.24	21.12	21.24
			75	0	21.50	21.44	21.15	21.41
		16QAM	1	0	23.00	22.75	21.35	22.05
			1	37	23.00	22.59	21.31	22.18
			1	74	23.00	22.55	21.35	22.13
			36	0	20.50	20.44	20.41	20.42
			36	18	20.50	20.41	20.49	20.44
			36	37	20.50	20.32	20.47	20.45
			75	0	21.00	20.52	20.33	20.58
			LTE Band 4	20MHz	QPSK	1	0	23.00
1	49	23.00				22.40	22.09	22.21
1	99	23.00	22.42	22.18		22.35		
50	0	21.50	21.30	21.25		21.24		
50	24	21.50	21.25	21.10		21.38		
50	49	21.50	21.17	21.12		21.32		
100	0	21.50	21.27	21.19		21.39		
16QAM	1	0	22.00	21.21		21.54	21.44	
	1	49	22.00	21.01		21.33	21.59	

			1	99	22.00	21.00	21.51	21.66
			50	0	21.00	20.52	20.41	20.30
			50	24	21.00	20.53	20.36	20.45
			50	49	21.00	20.47	20.30	20.42
			100	0	20.50	20.44	20.26	20.43

**7.4. WLAN & Bluetooth Output Power**

Mode	Channel	Frequency (MHz)	Tune-up	Output Power (dBm)
802.11b	1	2412	15.00	13.96
	6	2437	15.00	14.78
	11	2462	15.00	13.31
802.11g	1	2412	14.50	13.39
	6	2437	14.50	14.22
	11	2462	14.50	12.37
802.11n (HT20)	1	2412	14.00	13.18
	6	2437	14.00	13.96
	11	2462	14.00	12.06

NOTE: Power measurement results of WLAN 2.4G.

BR+EDR	Output Power (dBm)				
	Channel	Tune-up	Data Rates		
			0CH	39CH	78CH
	1M	8.000	7.114	6.903	7.250
	2M	8.000	7.773	7.733	7.962
	3M	8.500	7.817	7.801	8.093

NOTE: Power measurement results of Bluetooth.

**8. Stand-alone SAR test exclusion**

Refer to FCC KDB 447498D01, the 1-g SAR and 10-g SAR test exclusion thresholds for 100 MHz to 6 GHz at test separation distances ≤ 50 mm are determined by:

$$[(\text{max. power of channel, including tune-up tolerance, mW}) / (\text{min. test separation distance, mm})] \cdot [\sqrt{f_{(\text{GHZ})}}] \leq 3.0 \text{ for 1-g SAR and } \leq 7.5 \text{ for 10-g extremity SAR, where:}$$

- $f_{(\text{GHZ})}$  is the RF channel transmit frequency in GHz
- Power and distance are rounded to the nearest mW and mm before calculation
- The result is rounded to one decimal place for comparison

When the minimum test separation distance is < 5 mm, a distance of 5 mm is applied to determine SAR test exclusion.

Mode	Pmax (dBm)	Pmax (mW)	Distance (mm)	f (GHz)	Calculation Result	SAR Exclusion threshold	SAR test exclusion
Bluetooth	8.50	7.08	5	2.480	2.23	3	Yes

NOTE: Standalone SAR test exclusion for Bluetooth.

When standalone SAR test exclusion applies to an antenna that transmits simultaneously with other antennas, the standalone SAR must be estimated according to following to determine simultaneous transmission SAR test exclusion:

$[(\text{max. power of channel, including tune-up tolerance, mW}) / (\text{min. test separation distance, mm})] * [\sqrt{f_{(\text{GHz})}} / x] \text{ W/kg}$  for test separation distances  $\leq 50\text{mm}$ , where  $x = 7.5$  for 1-g SAR and  $x = 18.75$  for 10-g SAR.

When the minimum test separation distance is  $< 5 \text{ mm}$ , a distance of  $5 \text{ mm}$  is applied to determine SAR test exclusion.

Mode	Position	P <sub>max</sub> (dBm)	P <sub>max</sub> (mW)	Distance (mm)	f (GHz)	x	Estimated SAR (W/Kg)
Bluetooth	Head	8.50	7.08	5	2.48	7.5	0.297
Bluetooth	Body	8.50	7.08	10	2.48	7.5	0.149

NOTE: Estimated SAR calculation for Bluetooth

## 9. SAR Results

### 9.1. SAR measurement results

#### 9.1.1. SAR measurement Result of GSM850

Test Position of Head	Test channel /Freq.	Test Mode	SAR Value (W/kg)		Power Drift ( $\pm 5\%$ )	Conducted power (dBm)	Tune-up power (dBm)	Scaled SAR 1g (W/Kg)	Date
			1g	10g					
Left Cheek	189/836.4	GPRS(GMSK 2TS)	1.024	0.663	-2.76	31.44	31.50	1.038	2022/5/25
Left Tilt 15 Degree	189/836.4	GPRS(GMSK 2TS)	0.544	0.338	-2.24	31.44	31.50	0.552	2022/5/25
Right Cheek	189/836.4	GPRS(GMSK 2TS)	0.884	0.555	-2.59	31.44	31.50	0.896	2022/5/25
Right Tilt 15 Degree	189/836.4	GPRS(GMSK 2TS)	0.399	0.258	2.43	31.44	31.50	0.405	2022/5/25
Left Cheek	128/824.2	GPRS(GMSK 2TS)	1.179	0.715	-2.43	31.35	31.50	1.220	2022/5/25
Left Cheek Repeated	128/824.2	GPRS(GMSK 2TS)	1.170	0.711	1.35	31.35	31.50	1.211	2022/5/25
Left Cheek	251/848.8	GPRS(GMSK 2TS)	1.034	0.667	-0.87	31.25	31.50	1.095	2022/5/25
Right Cheek	128/824.2	GPRS(GMSK 2TS)	1.068	0.657	-0.58	31.35	31.50	1.106	2022/5/25
Right Cheek	128/824.2	GPRS(GMSK 2TS)	1.059	0.648	2.35	31.35	31.50	1.096	2022/5/25

Repeated									
Right Cheek	251/848.8	GPRS(GMSK 2TS)	0.979	0.584	3.56	31.25	31.50	1.037	2022/5/25

NOTE: Head SAR test results of GSM850.

Test Position of Body-Worn with 10mm	Test channel /Freq.	Test Mode	SAR Value (W/kg)		Power Drift (±5%)	Conducted power (dBm)	Tune-up power (dBm)	Scaled SAR 1g (W/Kg)	Date
			1g	10g					
Front Side	189/836.4	GPRS(GMSK 2TS)	0.666	0.436	0.50	31.44	31.50	0.675	2022/5/25
Back Side	189/836.4	GPRS(GMSK 2TS)	1.177	0.770	1.08	31.44	31.50	1.193	2022/5/25
Back Side	128/824.2	GPRS(GMSK 2TS)	1.260	0.818	-0.73	31.35	31.50	1.304	2022/5/25
Back Side Repeated	128/824.2	GPRS(GMSK 2TS)	1.254	0.814	0.25	31.35	31.50	1.298	2022/5/25
Back Side	251/848.8	GPRS(GMSK 2TS)	1.186	0.752	0.35	31.25	31.50	1.256	2022/5/25

NOTE: Body-Worn SAR test results of GSM850

**9.1.2. SAR measurement Result of GSM1900**

Test Position of Head	Test channel /Freq.	Test Mode	SAR Value (W/kg)		Power Drift (±5%)	Conducted power (dBm)	Tune-up power (dBm)	Scaled SAR 1g (W/Kg)	Date
			1g	10g					
Left Cheek	661/1880	GPRS(GMSK 3TS)	0.225	0.129	2.22	26.65	27.00	0.244	2022/5/24
Left Tilt 15 Degree	661/1880	GPRS(GMSK 3TS)	0.126	0.069	-3.29	26.65	27.00	0.137	2022/5/24
Right Cheek	661/1880	GPRS(GMSK 3TS)	0.202	0.112	-3.96	26.65	27.00	0.219	2022/5/24
Right Tilt 15 Degree	661/1880	GPRS(GMSK 3TS)	0.094	0.052	-3.94	26.65	27.00	0.102	2022/5/24

NOTE: Head SAR test results of GSM1900

Test Position of Body-Worn with 10mm	Test channel /Freq.	Test Mode	SAR Value (W/kg)		Power Drift (±5%)	Conducted power (dBm)	Tune-up power (dBm)	Scaled SAR 1g (W/Kg)	Date
			1g	10g					
Front Side	661/1880	GPRS(GMSK 3TS)	0.108	0.065	-1.76	26.65	27.00	0.117	2022/5/24
Back Side	661/1880	GPRS(GMSK 3TS)	0.147	0.091	-2.83	26.65	27.00	0.159	2022/5/24

NOTE: Body-Worn SAR test results of GSM1900

**9.1.3. SAR measurement Result of WCDMA Band 2**

Test Position of Head	Test channel /Freq.	Test Mode	SAR Value (W/kg)		Power Drift (±5%)	Conducted power (dBm)	Tune-up power (dBm)	Scaled SAR 1g (W/Kg)	Date
			1g	10g					
Left Cheek	9400/1880	RMC12.2K	0.498	0.272	-1.87	23.37	23.50	0.513	2022/5/24

Left Tilt 15 Degree	9400/1880	RMC12.2K	0.297	0.161	0.30	23.37	23.50	0.306	2022/5/24
Right Cheek	9400/1880	RMC12.2K	0.472	0.247	-3.70	23.37	23.50	0.486	2022/5/24
Right Tilt 15 Degree	9400/1880	RMC12.2K	0.246	0.132	0.18	23.37	23.50	0.253	2022/5/24

NOTE: Head SAR test results of WCDMA Band 2

Test Position of Body-Worn with 10mm	Test channel /Freq.	Test Mode	SAR Value (W/kg)		Power Drift (±5%)	Conducted power (dBm)	Tune-up power (dBm)	Scaled SAR 1g (W/Kg)	Date
			1g	10g					
Front Side	9400/1880	RMC12.2K	0.192	0.110	-0.19	23.37	23.50	0.198	2022/5/24
Back Side	9400/1880	RMC12.2K	0.306	0.175	0.06	23.37	23.50	0.315	2022/5/24

NOTE: Body-Worn SAR test results of WCDMA Band 2

**9.1.4. SAR measurement Result of WCDMA Band 5**

Test Position of Head	Test channel /Freq.	Test Mode	SAR Value (W/kg)		Power Drift (±5%)	Conducted power (dBm)	Tune-up power (dBm)	Scaled SAR 1g (W/Kg)	Date
			1g	10g					
Left Cheek	4182/836.4	RMC12.2K	0.798	0.511	3.84	23.08	23.50	0.879	2022/5/25
Left Cheek Repeated	4182/836.4	RMC12.2K	0.791	0.502	1.25	23.08	23.50	0.871	2022/5/25
Left Tilt 15 Degree	4182/836.4	RMC12.2K	0.463	0.296	-2.36	23.08	23.50	0.510	2022/5/25
Right Cheek	4182/836.4	RMC12.2K	0.725	0.454	2.40	23.08	23.50	0.799	2022/5/25
Right Tilt 15 Degree	4182/836.4	RMC12.2K	0.395	0.253	-2.44	23.08	23.50	0.435	2022/5/25
Left Cheek	4182/836.4	RMC12.2K	0.788	0.501	0.76	23.28	23.50	0.829	2022/5/25
Left Cheek	4182/836.4	RMC12.2K	0.706	0.439	1.20	23.04	23.50	0.785	2022/5/25

NOTE: Head SAR test results of WCDMA Band 5

Test Position of Body-Worn with 10mm	Test channel /Freq.	Test Mode	SAR Value (W/kg)		Power Drift (±5%)	Conducted power (dBm)	Tune-up power (dBm)	Scaled SAR 1g (W/Kg)	Date
			1g	10g					
Front Side	4182/836.4	RMC12.2K	0.618	0.414	2.75	23.08	23.50	0.681	2022/5/25
Back Side	4182/836.4	RMC12.2K	1.021	0.684	0.08	23.08	23.50	1.125	2022/5/25
Back Side	4132/826.4	RMC12.2K	1.034	0.698	0.30	23.28	23.50	1.088	2022/5/25
Back Side	4132/826.4	RMC12.2K	1.028	0.694	1.34	23.28	23.50	1.081	2022/5/25



Repeated									
Back Side	4233/846.6	RMC12.2K	1.030	0.686	-0.01	23.04	23.50	1.145	2022/5/25

NOTE: Body-Worn SAR test results of WCDMA Band 5

**9.1.5. SAR measurement Result of LTE Band 2**

Test Position of Head	Test channel /Freq.	Test Mode	SAR Value (W/kg)		Power Drift (±5%)	Conducted power (dBm)	Tune-up power (dBm)	Scaled SAR 1g (W/Kg)	Date
			1g	10g					
<b>1RB</b>									
Left Cheek	18900/1880	20M QPSK(1,99)	0.486	0.268	-1.00	24.03	24.50	0.542	2022/5/24
Left Tilt 15 Degree	18900/1880	20M QPSK(1,99)	0.263	0.145	-3.86	24.03	24.50	0.293	2022/5/24
Right Cheek	18900/1880	20M QPSK(1,99)	0.460	0.241	0.42	24.03	24.50	0.513	2022/5/24
Right Tilt 15 Degree	18900/1880	20M QPSK(1,99)	0.250	0.136	1.81	24.03	24.50	0.279	2022/5/24
<b>50%RB</b>									
Left Cheek	18900/1880	20M QPSK(50,49)	0.281	0.145	-3.75	23.10	23.50	0.308	2022/5/24
Left Tilt 15 Degree	18900/1880	20M QPSK(50,49)	0.142	0.073	2.52	23.10	23.50	0.156	2022/5/24
Right Cheek	18900/1880	20M QPSK(50,49)	0.247	0.142	-2.78	23.10	23.50	0.271	2022/5/24
Right Tilt 15 Degree	18900/1880	20M QPSK(50,49)	0.128	0.081	-0.47	23.10	23.50	0.140	2022/5/24

NOTE: Head SAR test results of LTE Band 2

Test Position of Body-Worn with 10mm	Test channel /Freq.	Test Mode	SAR Value (W/kg)		Power Drift (±5%)	Conducted power (dBm)	Tune-up power (dBm)	Scaled SAR 1g (W/Kg)	Date
			1g	10g					
<b>1RB</b>									
Front Side	18900/1880	20M QPSK(1,99)	0.216	0.123	3.90	24.03	24.50	0.241	2022/5/24

Back Side	18900/1880	20M QPSK(1,99)	0.350	0.201	0.11	24.03	24.50	0.390	2022/5/24
50%RB									
Front Side	18900/1880	20M QPSK(50,49)	0.112	0.072	-5.00	23.10	23.50	0.123	2022/5/24
Back Side	18900/1880	20M QPSK(50,49)	0.202	0.115	2.23	23.10	23.50	0.221	2022/5/24

NOTE: Body-Worn SAR test results of LTE Band 2

**9.1.6. SAR measurement Result of LTE Band 4**

Test Position of Head	Test channel /Freq.	Test Mode	SAR Value (W/kg)		Power Drift (±5%)	Conducted power (dBm)	Tune-up power (dBm)	Scaled SAR 1g (W/Kg)	Date
			1g	10g					
1RB									
Left Cheek	20175/1732.5	20M QPSK(1,0)	0.593	0.339	1.79	22.16	23.00	0.720	2022/5/20
Left Tilt 15 Degree	20175/1732.5	20M QPSK(1,0)	0.321	0.182	0.84	22.16	23.00	0.389	2022/5/20
Right Cheek	20175/1732.5	20M QPSK(1,0)	0.556	0.308	-2.55	22.16	23.00	0.675	2022/5/20
Right Tilt 15 Degree	20175/1732.5	20M QPSK(1,0)	0.296	0.164	-2.91	22.16	23.00	0.359	2022/5/20
50%RB									
Left Cheek	20175/1732.5	20M QPSK(50,24)	0.304	0.176	3.57	21.10	21.50	0.333	2022/5/20
Left Tilt 15 Degree	20175/1732.5	20M QPSK(50,24)	0.166	0.109	0.14	21.10	21.50	0.182	2022/5/20
Right Cheek	20175/1732.5	20M QPSK(50,24)	0.291	0.161	-0.93	21.10	21.50	0.319	2022/5/20
Right Tilt 15 Degree	20175/1732.5	20M QPSK(50,24)	0.155	0.093	-1.72	21.10	21.50	0.170	2022/5/20

NOTE: Head SAR test results of LTE Band 4

Test Position of Body-Worn with 10mm	Test channel /Freq.	Test Mode	SAR Value (W/kg)		Power Drift (±5%)	Conducted power (dBm)	Tune-up power (dBm)	Scaled SAR 1g (W/Kg)	Date
			1g	10g					
<b>1RB</b>									
Front Side	20175/173 2.5	20M QPSK(1,0)	0.354	0.198	1.74	22.16	23.00	0.430	2022/5/20
Back Side	20175/173 2.5	20M QPSK(1,0)	0.560	0.330	-1.45	22.16	23.00	0.679	2022/5/20
<b>50%RB</b>									
Front Side	20175/173 2.5	20M QPSK(50,2 4)	0.179	0.105	-3.23	21.10	21.50	0.196	2022/5/20
Back Side	20175/173 2.5	20M QPSK(50,2 4)	0.331	0.171	-1.30	21.10	21.50	0.363	2022/5/20

NOTE: Body-Worn SAR test results of LTE Band 4

**9.1.7. SAR measurement Result of WLAN 2.4G**

Test Position of Head	Test channel /Freq.	Test Mode	SAR Value (W/kg)		Power Drift (±5%)	Conducted power (dBm)	Tune-up power (dBm)	Scaled SAR 1g (W/Kg)	Date
			1g	10g					
Left Cheek	6/2437	802.11b	0.136	0.071	-1.78	14.78	15.00	0.143	2022/6/6
Left Tilt 15 Degree	6/2437	802.11b	0.080	0.041	-2.66	14.78	15.00	0.084	2022/6/6
Right Cheek	6/2437	802.11b	0.122	0.064	1.28	14.78	15.00	0.128	2022/6/6
Right Tilt 15 Degree	6/2437	802.11b	0.065	0.034	-3.81	14.78	15.00	0.068	2022/6/6

NOTE: Head SAR test results of WLAN 2.4G

Test Position of Body-Worn with 10mm	Test channel /Freq.	Test Mode	SAR Value (W/kg)		Power Drift (±5%)	Conducted power (dBm)	Tune-up power (dBm)	Scaled SAR 1g (W/Kg)	Date
			1g	10g					
Front Side	6/2437	802.11b	0.066	0.032	-2.44	14.78	15.00	0.069	2022/6/6
Back Side	6/2437	802.11b	0.078	0.039	-0.78	14.78	15.00	0.082	2022/6/6

NOTE: Body-Worn SAR test results of WLAN 2.4G

**9.2. SAR Summation Scenario**

Per KDB 447498 D01, simultaneous transmission SAR is compliant if,

- 1) Scalar SAR summation < 1.6W/kg.
- 2) SPLSR =  $(SAR_1 + SAR_2)^{1.5} / (\text{min. separation distance, mm})$ , and the peak separation distance is determined from the square root of  $[(x_1-x_2)^2 + (y_1-y_2)^2 + (z_1-z_2)^2]$ , where  $(x_1, y_1, z_1)$  and  $(x_2, y_2, z_2)$  are the coordinates of the extrapolated peak SAR locations in the zoom scan. If  $SPLSR \leq 0.04$ , simultaneously transmission SAR measurement is not necessary.

Test Position		Scaled SAR <sub>MAX</sub>		Σ 1-g SAR (W/Kg)	SPLSR	Remark
		WWAN	DTS			
Head	Left Cheek	1.220	0.143	1.363	N/A	N/A
	Left Tilt 15 Degree	0.552	0.084	0.636	N/A	N/A
	Right Cheek	1.106	0.128	1.234	N/A	N/A
	Right Tilt 15 Degree	0.435	0.068	0.503	N/A	N/A
Body-Worn	Front Side	0.681	0.069	0.750	N/A	N/A
	Back Side	1.304	0.082	1.386	N/A	N/A

NOTE: 1-g SAR Simultaneous Tx Combination of WWAN and DTS.

Test Position		Scaled SAR <sub>MAX</sub>		Σ 1-g SAR (W/Kg)	SPLSR	Remark
		WWAN	DSS			
Head	Left Cheek	1.220	0.297	1.517	N/A	N/A
	Left Tilt 15 Degree	0.552	0.297	0.849	N/A	N/A
	Right Cheek	1.106	0.297	1.403	N/A	N/A
	Right Tilt 15 Degree	0.435	0.297	0.732	N/A	N/A
Body-Worn	Front Side	0.681	0.149	0.830	N/A	N/A
	Back Side	1.304	0.149	1.453	N/A	N/A

NOTE: 1-g SAR Simultaneous Tx Combination of WWAN and DSS.

**10. Appendix A. Photo documentation**

Refer to appendix Test Setup photo---SAR

## 11. Appendix B. System Check Plots

Table of contents
-------------------

MEASUREMENT 1 System Performance Check - 835MHz
---

MEASUREMENT 2 System Performance Check - 1800MHz
--

MEASUREMENT 3 System Performance Check - 1900MHz
--

MEASUREMENT 4 System Performance Check - 2450MHz
--

# MEASUREMENT 1

Date of measurement: 25/5/2022

## A. Experimental conditions.

<b>Area Scan</b>	<u>dx=15mm dy=15mm, h= 5.00 mm</u>
<b>ZoomScan</b>	<u>5x5x7, dx=8mm dy=8mm dz=5mm</u>
<b>Phantom</b>	<u>Validation plane</u>
<b>Device Position</b>	<u>Dipole</u>
<b>Band</b>	<u>CW835</u>
<b>Channels</b>	<u>Middle</u>
<b>Signal</b>	<u>CW (Crest factor: 1.0)</u>

## B. SAR Measurement Results

<b>Frequency (MHz)</b>	835.000000
<b>Relative permittivity (real part)</b>	41.904657
<b>Relative permittivity (imaginary part)</b>	19.639930
<b>Conductivity (S/m)</b>	0.911075
<b>Variation (%)</b>	1.970000

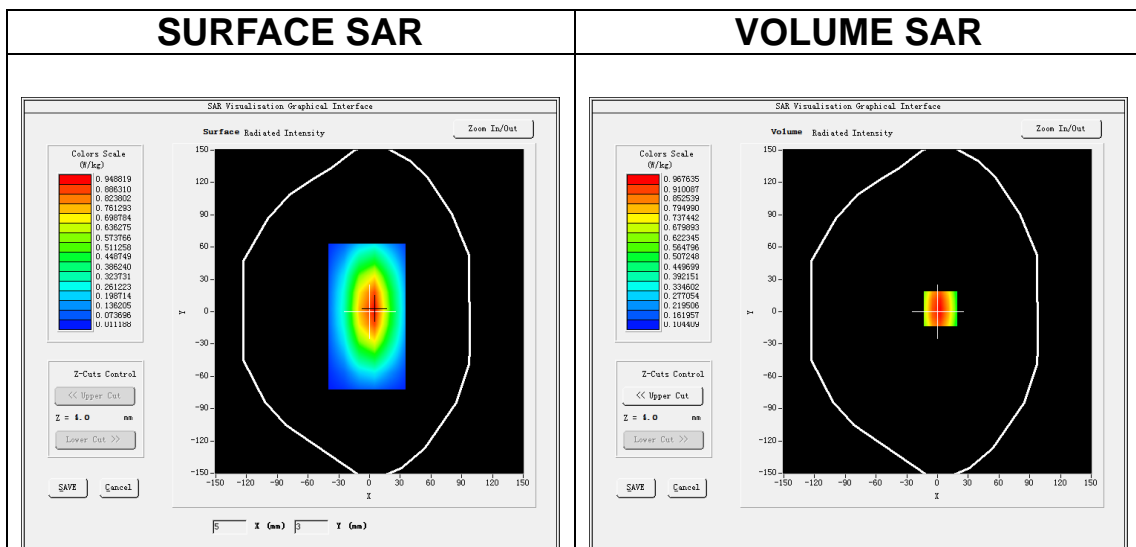

**Maximum location: X=3.00, Y=3.00**

**SAR Peak: 1.30 W/kg**

<b>SAR 10g (W/Kg)</b>	0.625191
<b>SAR 1g (W/Kg)</b>	1.043231

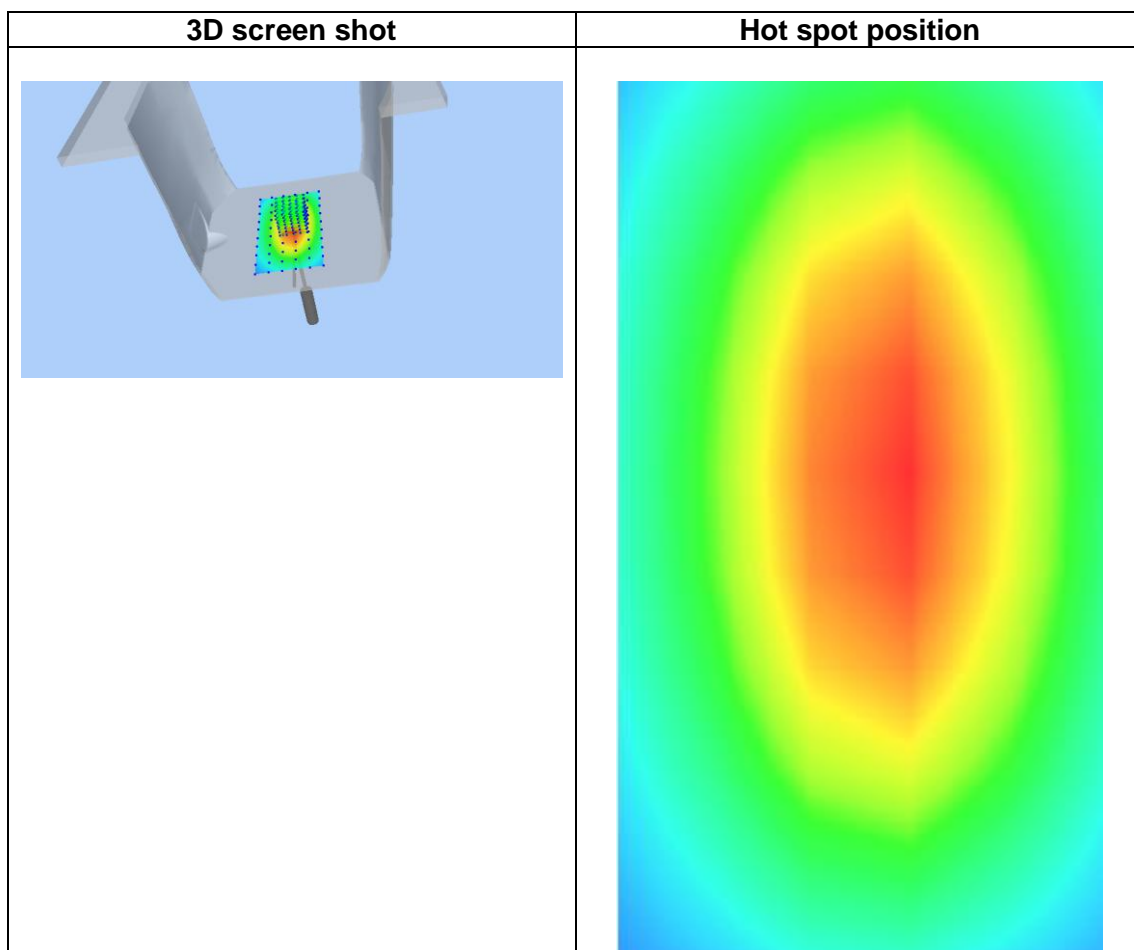
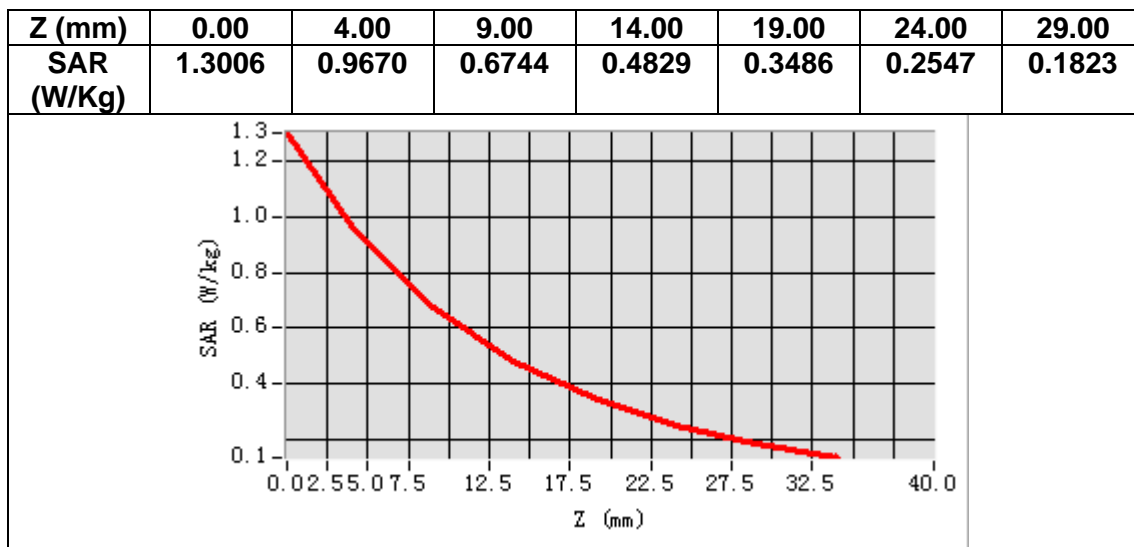

# MEASUREMENT 2

Date of measurement: 20/5/2022

## A. Experimental conditions.

<b>Area Scan</b>	<u>dx=15mm dy=15mm, h= 5.00 mm</u>
<b>ZoomScan</b>	<u>5x5x7, dx=8mm dy=8mm dz=5mm</u>
<b>Phantom</b>	<u>Validation plane</u>
<b>Device Position</b>	<u>Dipole</u>
<b>Band</b>	<u>CW1800</u>
<b>Channels</b>	<u>Middle</u>
<b>Signal</b>	<u>CW (Crest factor: 1.0)</u>

## B. SAR Measurement Results

<b>Frequency (MHz)</b>	1800.000000
<b>Relative permittivity (real part)</b>	38.628363
<b>Relative permittivity (imaginary part)</b>	13.750537
<b>Conductivity (S/m)</b>	1.375054
<b>Variation (%)</b>	-2.520000

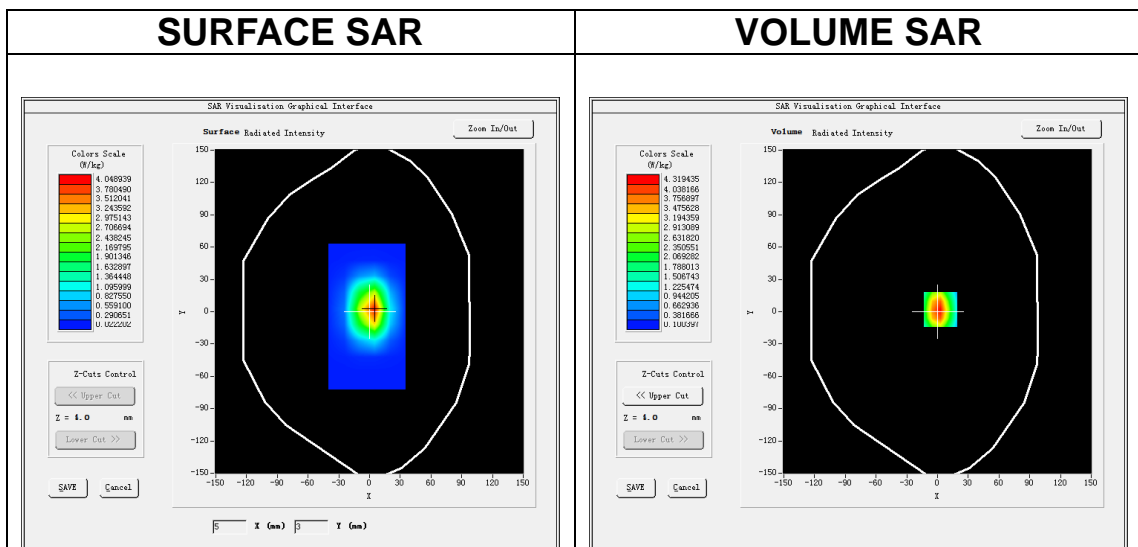

**Maximum location: X=3.00, Y=2.00**

**SAR Peak: 6.82 W/kg**

<b>SAR 10g (W/Kg)</b>	1.856296
<b>SAR 1g (W/Kg)</b>	3.598160



Z (mm)	0.00	4.00	9.00	14.00	19.00	24.00	29.00
SAR (W/Kg)	6.7404	4.3195	2.4349	1.4223	0.8532	0.5251	0.3259

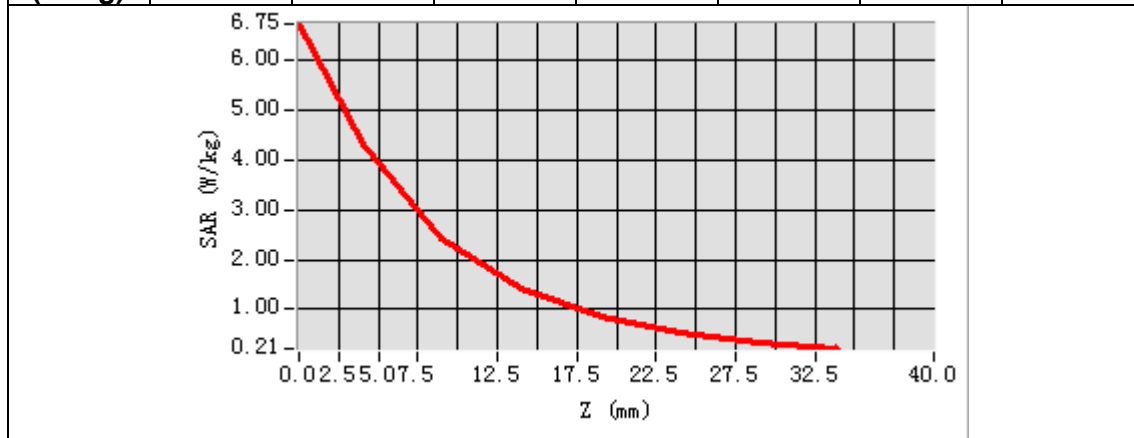

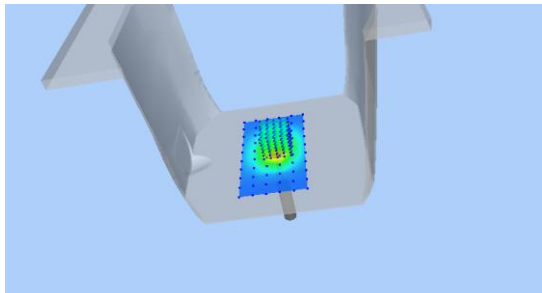
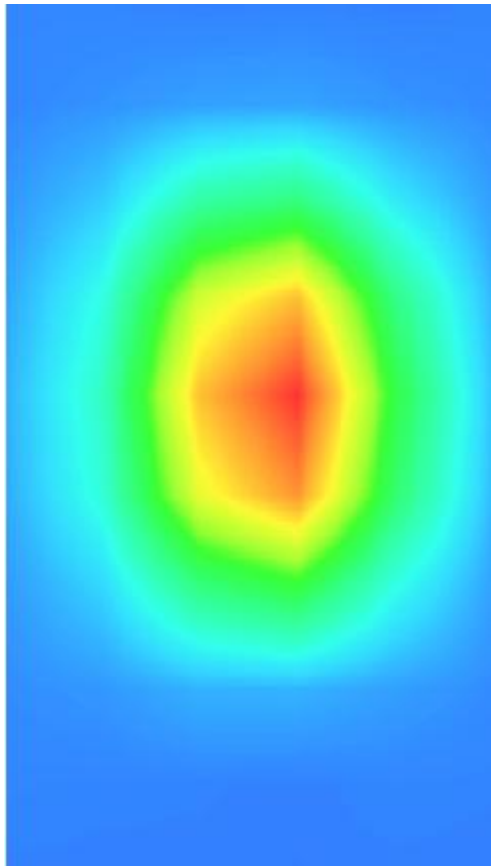
3D screen shot	Hot spot position
	

# MEASUREMENT 3

Date of measurement: 24/5/2022

## A. Experimental conditions.

<b>Area Scan</b>	<u>dx=15mm dy=15mm, h= 5.00 mm</u>
<b>ZoomScan</b>	<u>5x5x7, dx=8mm dy=8mm dz=5mm</u>
<b>Phantom</b>	<u>Validation plane</u>
<b>Device Position</b>	<u>Dipole</u>
<b>Band</b>	<u>CW1900</u>
<b>Channels</b>	<u>Middle</u>
<b>Signal</b>	<u>CW (Crest factor: 1.0)</u>

## B. SAR Measurement Results

<b>Frequency (MHz)</b>	1900.000000
<b>Relative permittivity (real part)</b>	38.180775
<b>Relative permittivity (imaginary part)</b>	13.879897
<b>Conductivity (S/m)</b>	1.465100
<b>Variation (%)</b>	2.050000

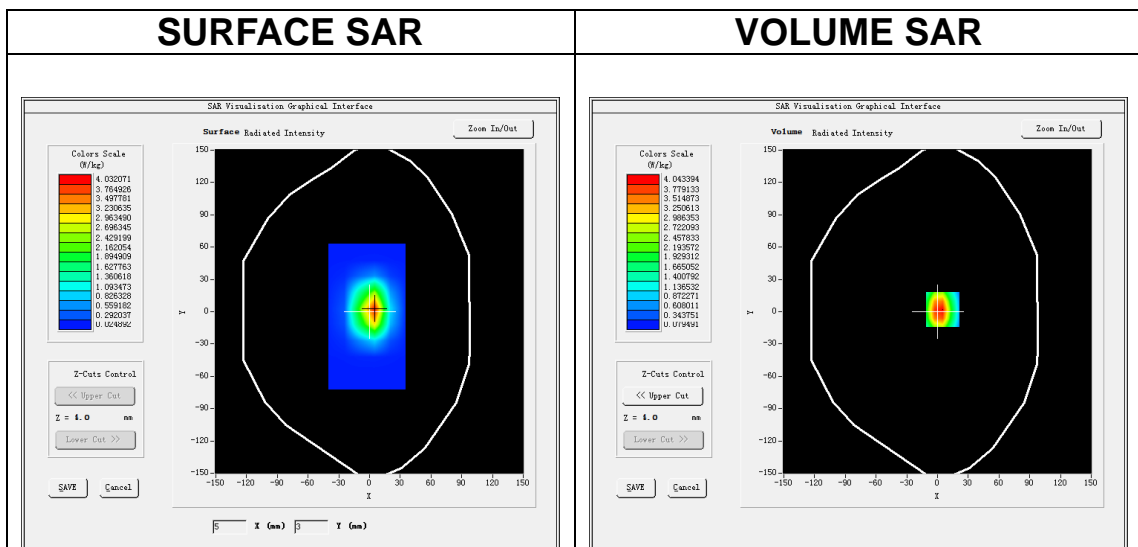

**Maximum location: X=5.00, Y=2.00**

**SAR Peak: 6.70 W/kg**

<b>SAR 10g (W/Kg)</b>	2.084384
<b>SAR 1g (W/Kg)</b>	3.705097

Z (mm)	0.00	4.00	9.00	14.00	19.00	24.00	29.00
SAR (W/Kg)	6.3274	4.0412	2.2637	1.3005	0.7678	0.4539	0.2786

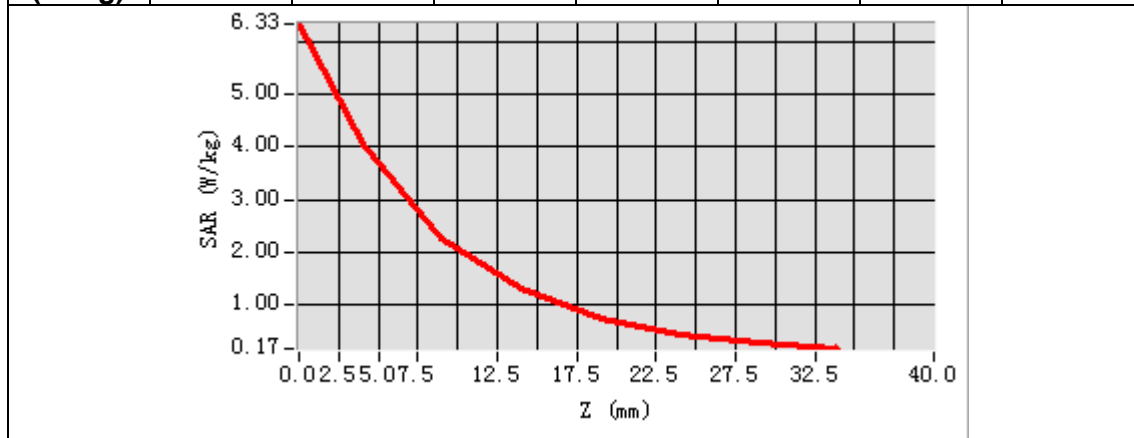

3D screen shot	Hot spot position

# MEASUREMENT 4

Date of measurement: 6/6/2022

## A. Experimental conditions.

<b>Area Scan</b>	<u>dx=12mm dy=12mm, h= 5.00 mm</u>
<b>ZoomScan</b>	<u>7x7x7, dx=5mm dy=5mm dz=5mm</u>
<b>Phantom</b>	<u>Validation plane</u>
<b>Device Position</b>	<u>Dipole</u>
<b>Band</b>	<u>CW2450</u>
<b>Channels</b>	<u>Middle</u>
<b>Signal</b>	<u>CW (Crest factor: 1.0)</u>

## B. SAR Measurement Results

<b>Frequency (MHz)</b>	2450.000000
<b>Relative permittivity (real part)</b>	38.280244
<b>Relative permittivity (imaginary part)</b>	13.068313
<b>Conductivity (S/m)</b>	1.778743
<b>Variation (%)</b>	1.570000

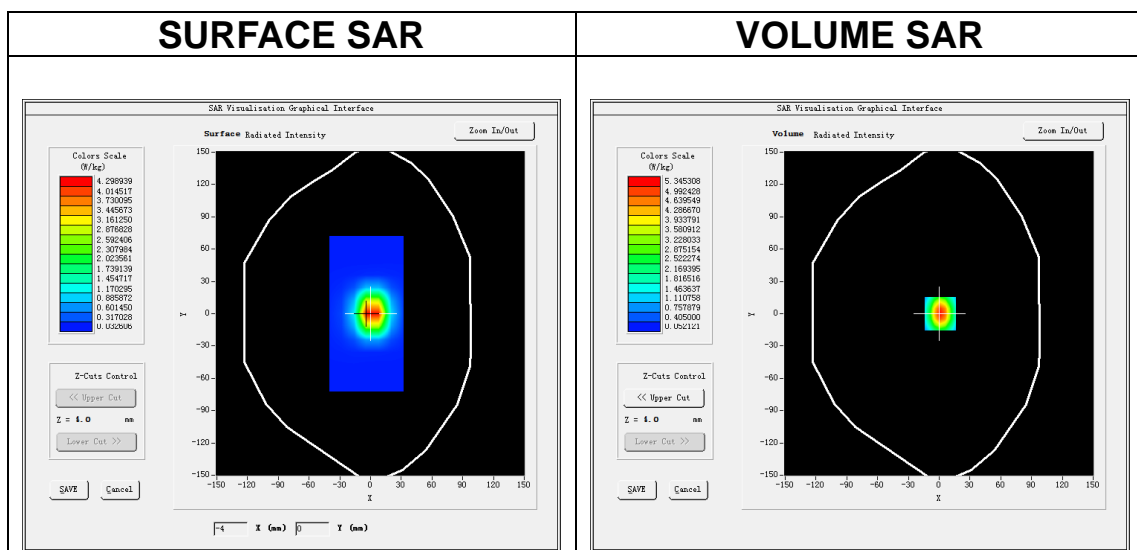

**Maximum location: X=1.00, Y=0.00**

**SAR Peak: 9.33 W/kg**

<b>SAR 10g (W/Kg)</b>	2.534172
<b>SAR 1g (W/Kg)</b>	5.857128

Z (mm)	0.00	4.00	9.00	14.00	19.00	24.00	29.00
SAR (W/Kg)	9.4240	5.3411	2.4354	1.1312	0.5468	0.2741	0.1483

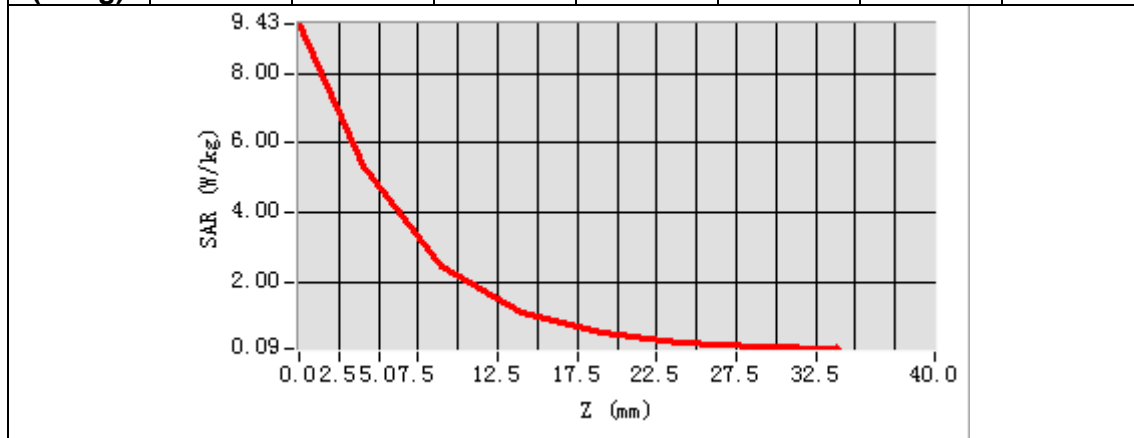

3D screen shot	Hot spot position

## 12. Appendix C. Plots of High SAR Measurement

Table of contents
MEASUREMENT 1 GSM 850 Head
MEASUREMENT 2 GSM 850 Body
MEASUREMENT 3 GSM 1900 Head
MEASUREMENT 4 GSM 1900 Body
MEASUREMENT 5 WCDMA Band 2 Head
MEASUREMENT 6 WCDMA Band 2 Body
MEASUREMENT 7 WCDMA Band 5 Head
MEASUREMENT 8 WCDMA Band 5 Body
MEASUREMENT 9 WLAN 2.4G Head
MEASUREMENT 10 WLAN 2.4G Body
MEASUREMENT 11 LTE Band 2 Head
MEASUREMENT 12 LTE Band 2 Body
MEASUREMENT 13 LTE Band 4 Head
MEASUREMENT 14 LTE Band 4 Body

# MEASUREMENT 1

Date of measurement: 25/5/2022

## A. Experimental conditions.

<b>Area Scan</b>	<u>dx=15mm dy=15mm, h= 5.00 mm</u>
<b>ZoomScan</b>	<u>5x5x7,dx=8mm dy=8mm dz=5mm</u>
<b>Phantom</b>	<u>Left head</u>
<b>Device Position</b>	<u>Cheek</u>
<b>Band</b>	<u>GSM850</u>
<b>Channels</b>	<u>Low</u>
<b>Signal</b>	<u>TDMA (Crest factor: 4.0)</u>

## B. SAR Measurement Results

<b>Frequency (MHz)</b>	824.200000
<b>Relative permittivity (real part)</b>	41.967537
<b>Relative permittivity (imaginary part)</b>	19.605930
<b>Conductivity (S/m)</b>	0.897734
<b>Variation (%)</b>	-2.430000

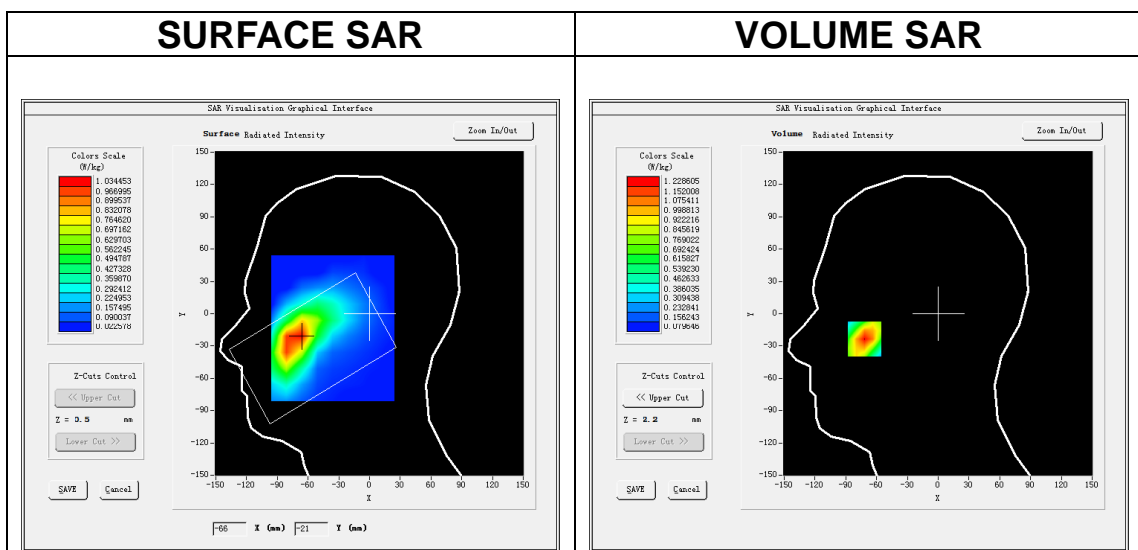

**Maximum location: X=-72.00, Y=-23.00**

**SAR Peak: 1.87 W/kg**

<b>SAR 10g (W/Kg)</b>	0.715359
<b>SAR 1g (W/Kg)</b>	1.179375

Z (mm)	0.00	4.00	9.00	14.00	19.00	24.00	29.00
SAR (W/Kg)	1.8627	1.2286	0.7772	0.5588	0.4206	0.2871	0.2025

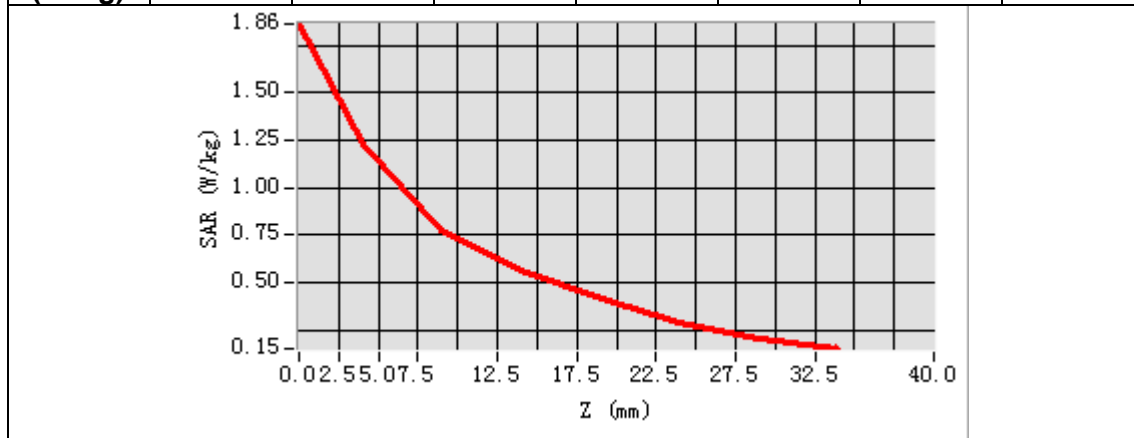

3D screen shot	Hot spot position



# MEASUREMENT 2

Date of measurement: 25/5/2022

## A. Experimental conditions.

<b>Area Scan</b>	<u>dx=15mm dy=15mm, h= 5.00 mm</u>
<b>ZoomScan</b>	<u>5x5x7, dx=8mm dy=8mm dz=5mm</u>
<b>Phantom</b>	<u>Validation plane</u>
<b>Device Position</b>	<u>Body</u>
<b>Band</b>	<u>GSM850</u>
<b>Channels</b>	<u>Low</u>
<b>Signal</b>	<u>TDMA (Crest factor: 4.0)</u>

## B. SAR Measurement Results

<b>Frequency (MHz)</b>	824.200000
<b>Relative permittivity (real part)</b>	41.967537
<b>Relative permittivity (imaginary part)</b>	19.605930
<b>Conductivity (S/m)</b>	0.897734
<b>Variation (%)</b>	-0.730000

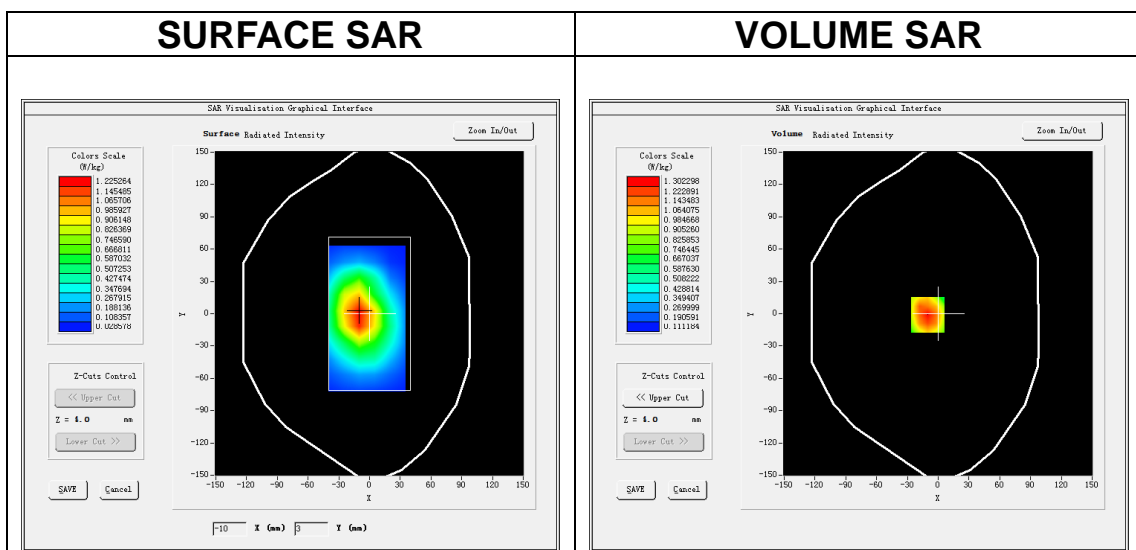

**Maximum location: X=-10.00, Y=-1.00**  
**SAR Peak: 1.87 W/kg**

<b>SAR 10g (W/Kg)</b>	0.818418
<b>SAR 1g (W/Kg)</b>	1.260114

Z (mm)	0.00	4.00	9.00	14.00	19.00	24.00	29.00
SAR (W/Kg)	1.8909	1.3023	0.8552	0.6695	0.4653	0.3323	0.2278

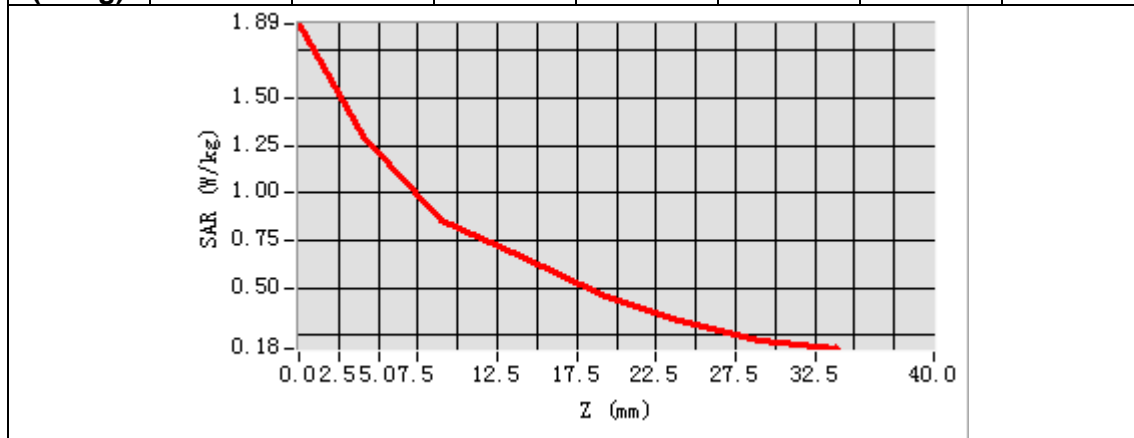

3D screen shot	Hot spot position

# MEASUREMENT 3

Date of measurement: 24/5/2022

## A. Experimental conditions.

<b>Area Scan</b>	<u>dx=15mm dy=15mm, h= 5.00 mm</u>
<b>ZoomScan</b>	<u>5x5x7,dx=8mm dy=8mm dz=5mm</u>
<b>Phantom</b>	<u>Left head</u>
<b>Device Position</b>	<u>Cheek</u>
<b>Band</b>	<u>GSM1900</u>
<b>Channels</b>	<u>Middle</u>
<b>Signal</b>	<u>TDMA (Crest factor: 2.7)</u>

## B. SAR Measurement Results

<b>Frequency (MHz)</b>	1880.000000
<b>Relative permittivity (real part)</b>	38.267174
<b>Relative permittivity (imaginary part)</b>	13.897697
<b>Conductivity (S/m)</b>	1.451537
<b>Variation (%)</b>	2.220000

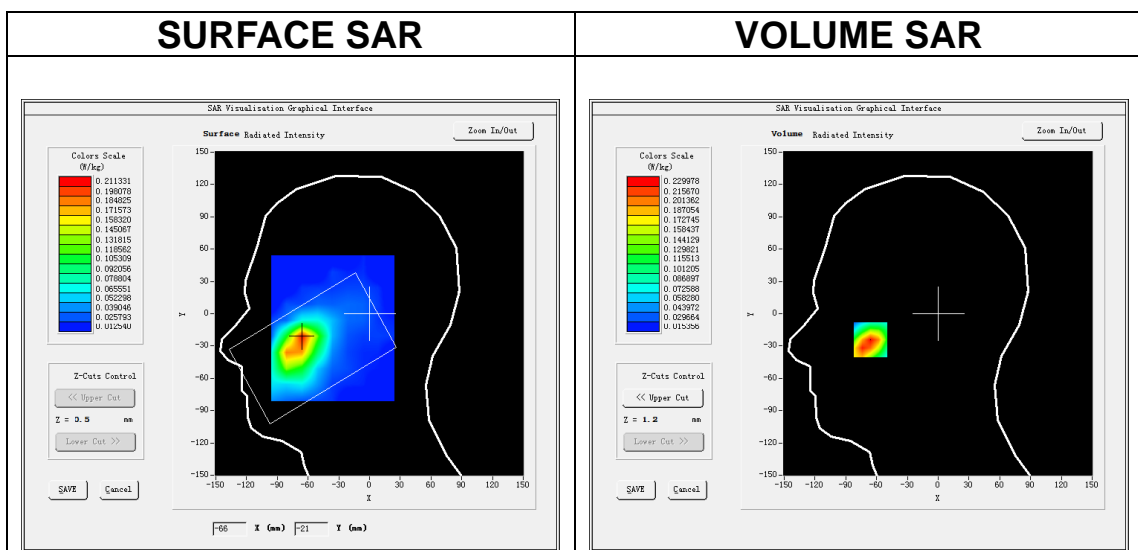

**Maximum location: X=-66.00, Y=-24.00**

**SAR Peak: 0.34 W/kg**

<b>SAR 10g (W/Kg)</b>	0.128810
<b>SAR 1g (W/Kg)</b>	0.224708

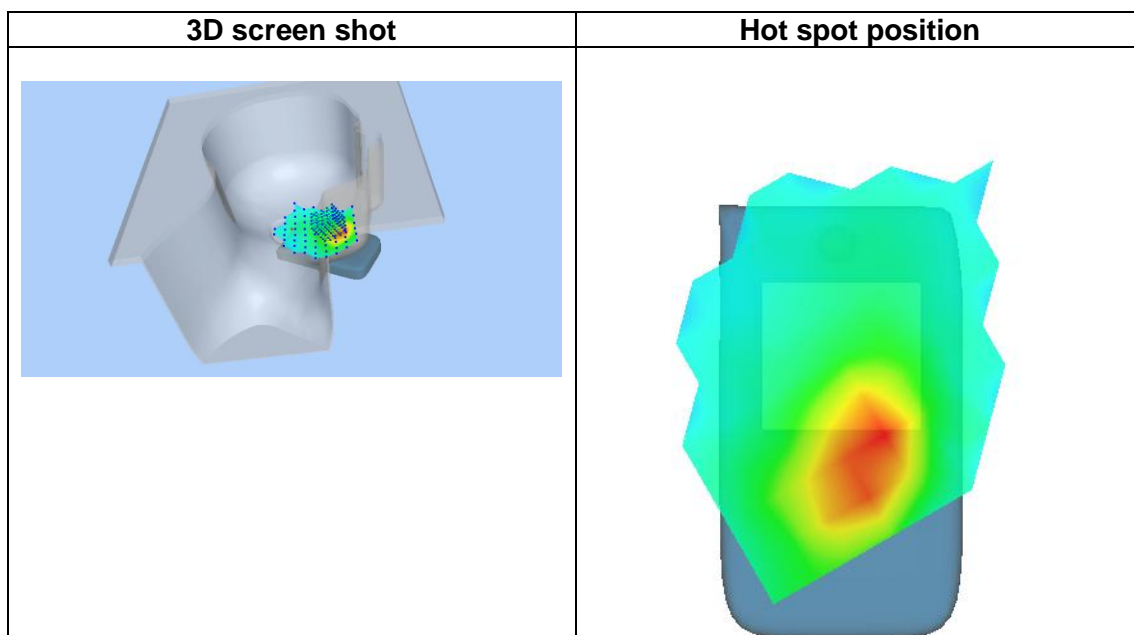
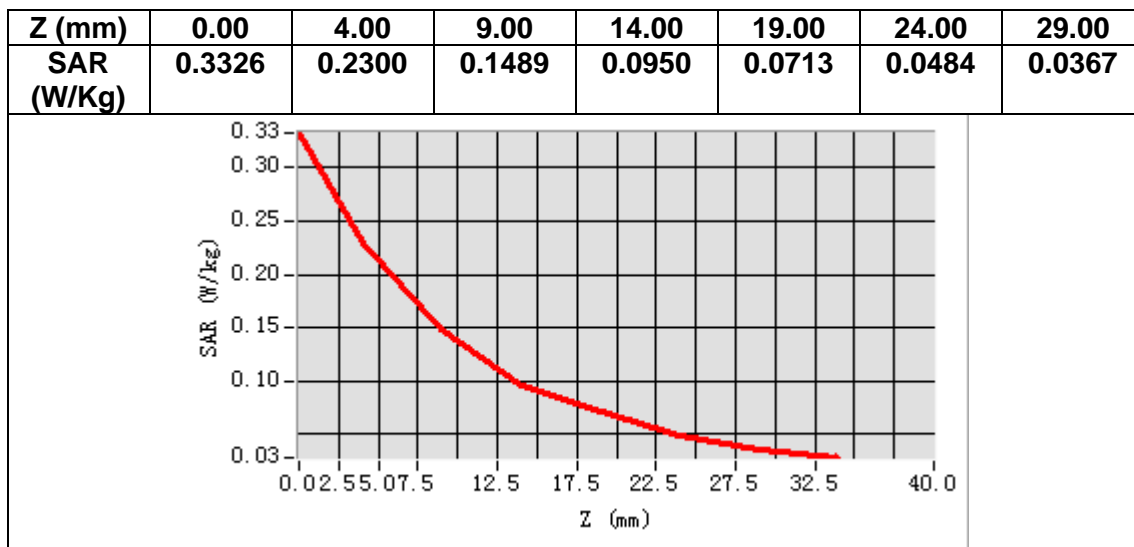

# MEASUREMENT 4

Date of measurement: 24/5/2022

## A. Experimental conditions.

<b>Area Scan</b>	<u>dx=15mm dy=15mm, h= 5.00 mm</u>
<b>ZoomScan</b>	<u>5x5x7, dx=8mm dy=8mm dz=5mm</u>
<b>Phantom</b>	<u>Validation plane</u>
<b>Device Position</b>	<u>Body</u>
<b>Band</b>	<u>GSM1900</u>
<b>Channels</b>	<u>Middle</u>
<b>Signal</b>	<u>TDMA (Crest factor: 2.7)</u>

## B. SAR Measurement Results

<b>Frequency (MHz)</b>	1880.000000
<b>Relative permittivity (real part)</b>	38.267174
<b>Relative permittivity (imaginary part)</b>	13.897697
<b>Conductivity (S/m)</b>	1.451537
<b>Variation (%)</b>	-2.830000

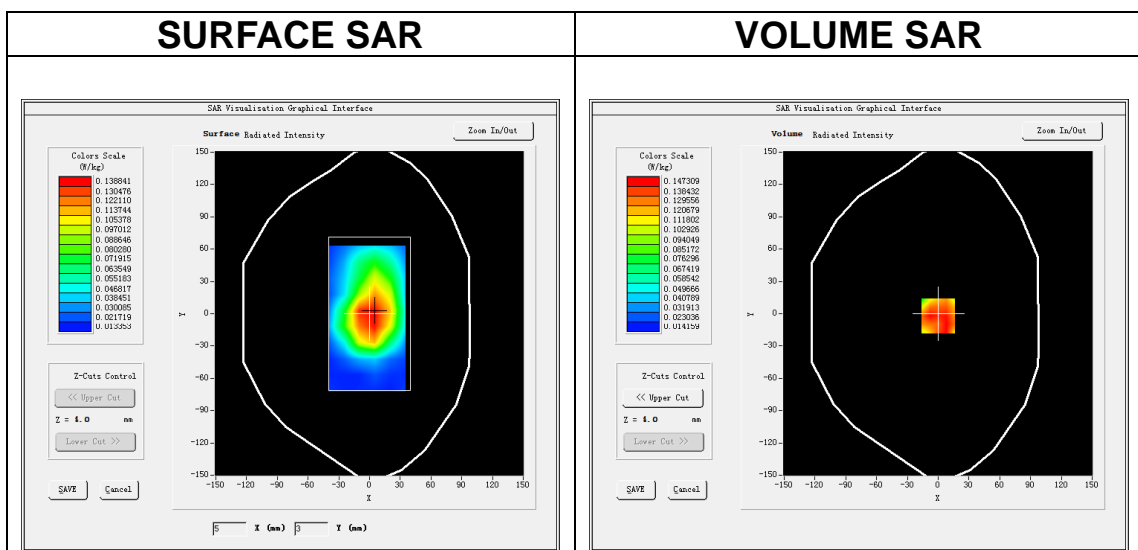

**Maximum location: X=0.00, Y=-2.00**

**SAR Peak: 0.23 W/kg**

<b>SAR 10g (W/Kg)</b>	0.091288
<b>SAR 1g (W/Kg)</b>	0.147113

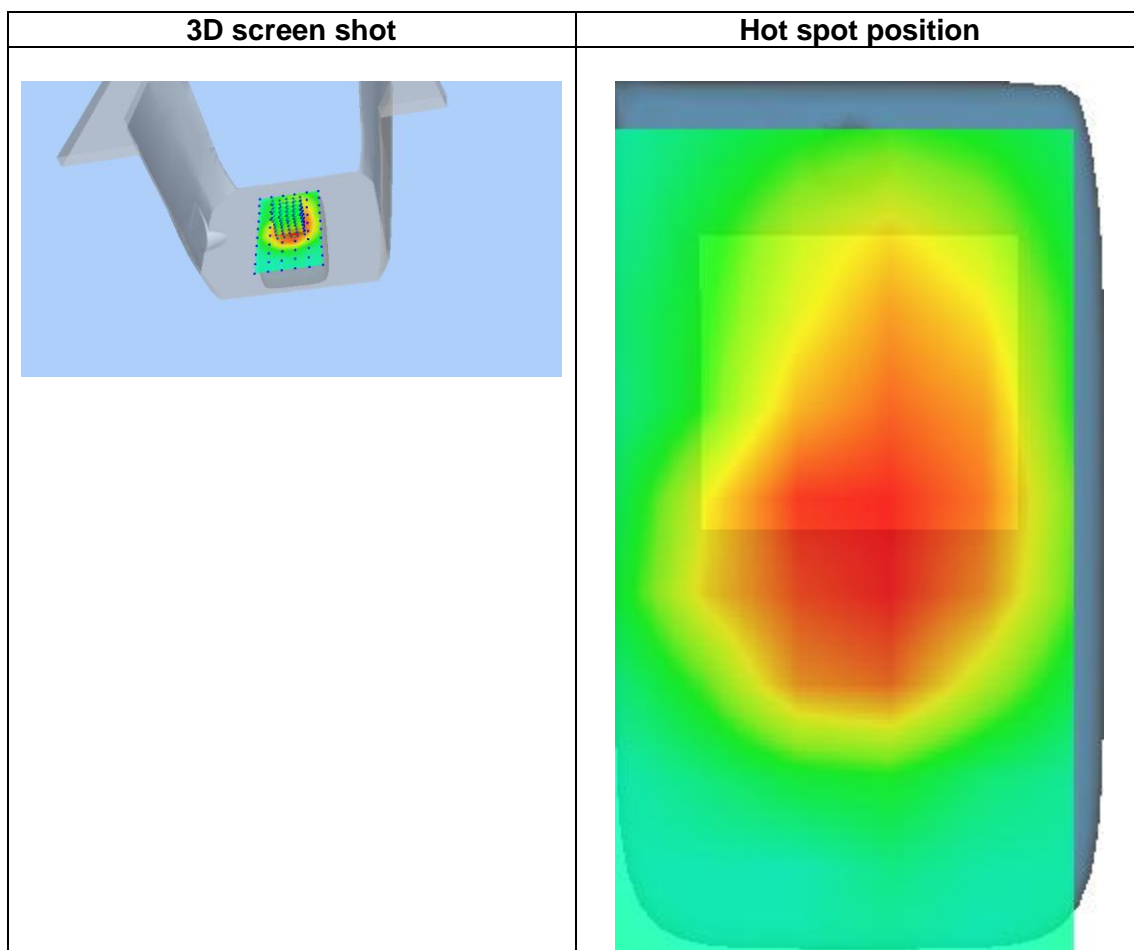
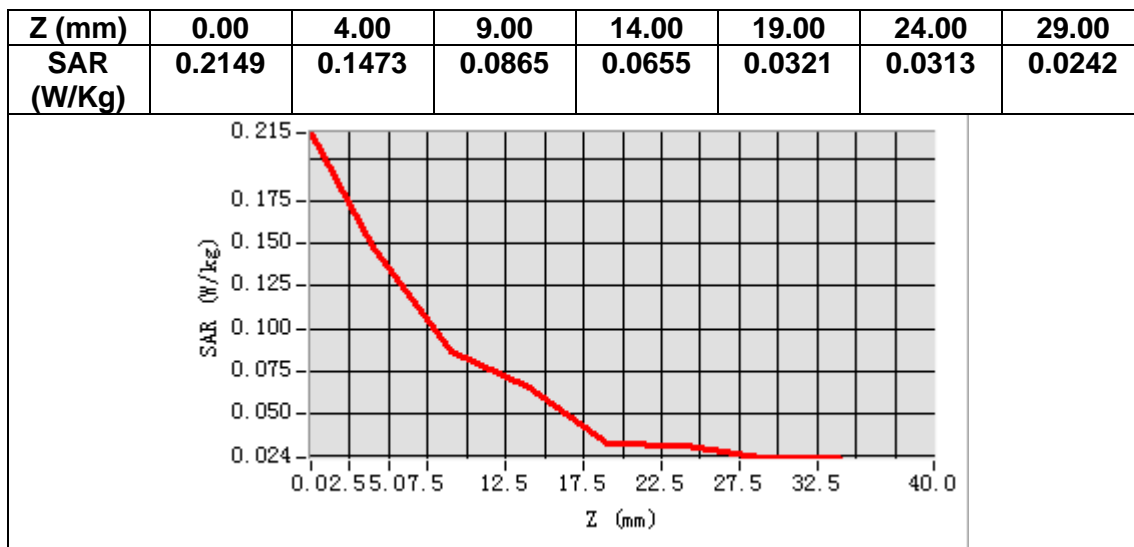

# MEASUREMENT 5

Date of measurement: 24/5/2022

## A. Experimental conditions.

<b>Area Scan</b>	<u>dx=15mm dy=15mm, h= 5.00 mm</u>
<b>ZoomScan</b>	<u>5x5x7, dx=8mm dy=8mm dz=5mm</u>
<b>Phantom</b>	<u>Left head</u>
<b>Device Position</b>	<u>Cheek</u>
<b>Band</b>	<u>Band2 WCDMA1900</u>
<b>Channels</b>	<u>Middle</u>
<b>Signal</b>	<u>WCDMA (Crest factor: 1.0)</u>

## B. SAR Measurement Results

<b>Frequency (MHz)</b>	1880.000000
<b>Relative permittivity (real part)</b>	38.267174
<b>Relative permittivity (imaginary part)</b>	13.897697
<b>Conductivity (S/m)</b>	1.451537
<b>Variation (%)</b>	-1.870000

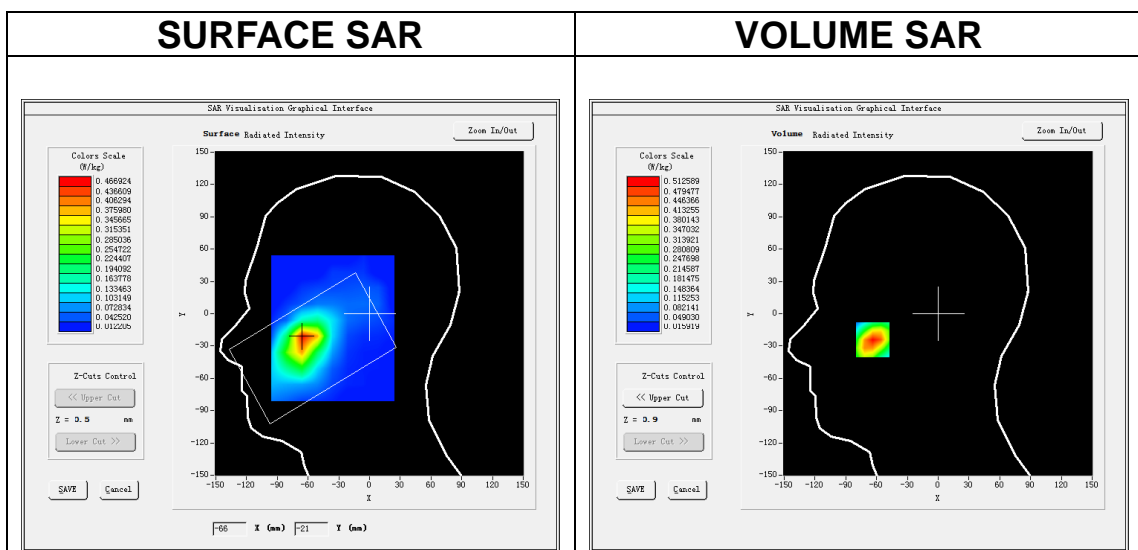

**Maximum location: X=-64.00, Y=-24.00**

**SAR Peak: 0.77 W/kg**

<b>SAR 10g (W/Kg)</b>	0.271659
<b>SAR 1g (W/Kg)</b>	0.498134

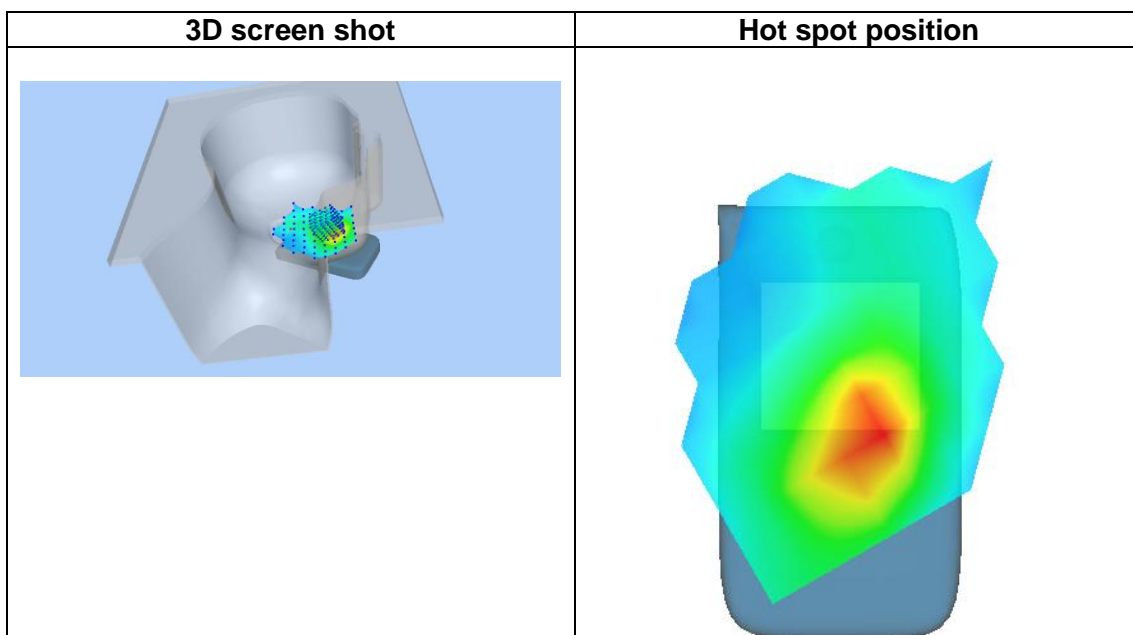
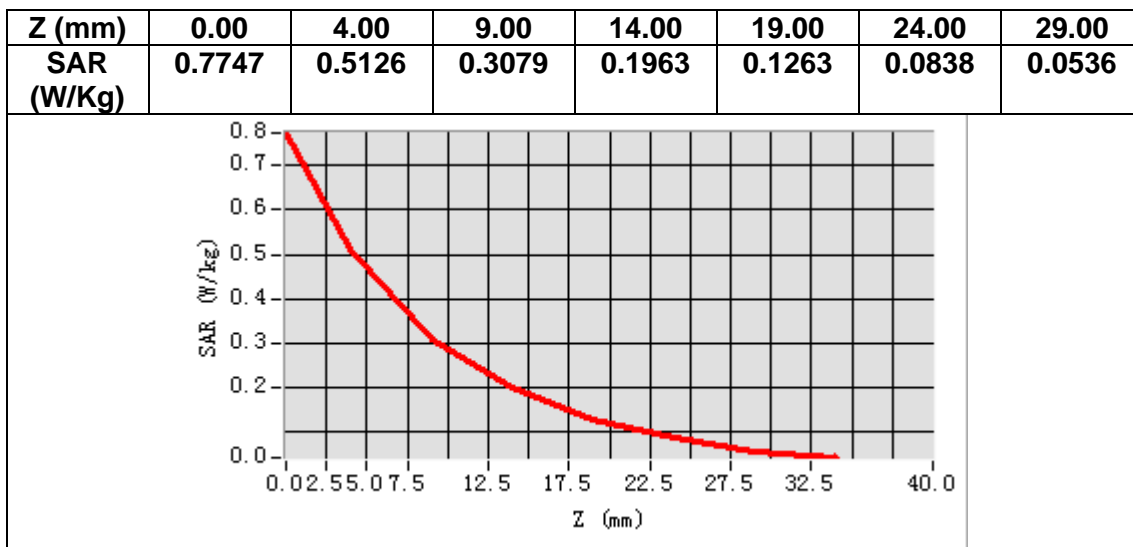



# MEASUREMENT 6

Date of measurement: 24/5/2022

## A. Experimental conditions.

<b>Area Scan</b>	<u>dx=15mm dy=15mm, h= 5.00 mm</u>
<b>ZoomScan</b>	<u>5x5x7, dx=8mm dy=8mm dz=5mm</u>
<b>Phantom</b>	<u>Validation plane</u>
<b>Device Position</b>	<u>Body</u>
<b>Band</b>	<u>Band2 WCDMA1900</u>
<b>Channels</b>	<u>Middle</u>
<b>Signal</b>	<u>WCDMA (Crest factor: 1.0)</u>

## B. SAR Measurement Results

<b>Frequency (MHz)</b>	1880.000000
<b>Relative permittivity (real part)</b>	38.267174
<b>Relative permittivity (imaginary part)</b>	13.897697
<b>Conductivity (S/m)</b>	1.451537
<b>Variation (%)</b>	0.060000

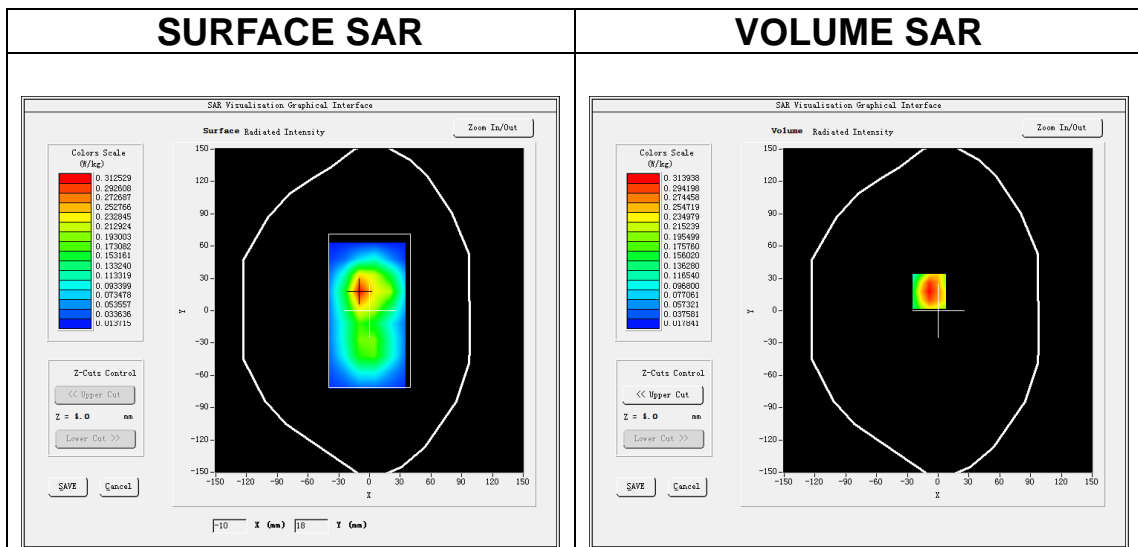

**Maximum location: X=-9.00, Y=18.00**

**SAR Peak: 0.46 W/kg**

<b>SAR 10g (W/Kg)</b>	0.175276
<b>SAR 1g (W/Kg)</b>	0.305922

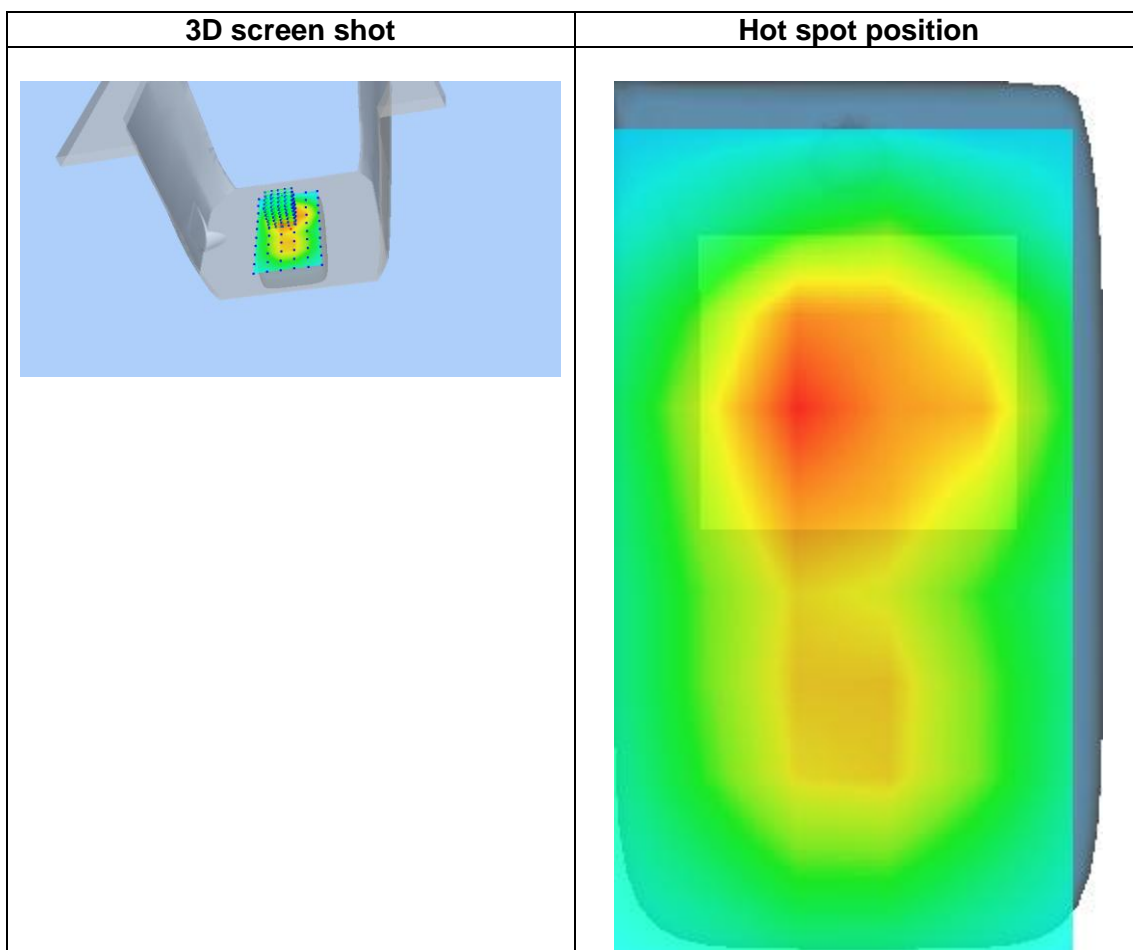
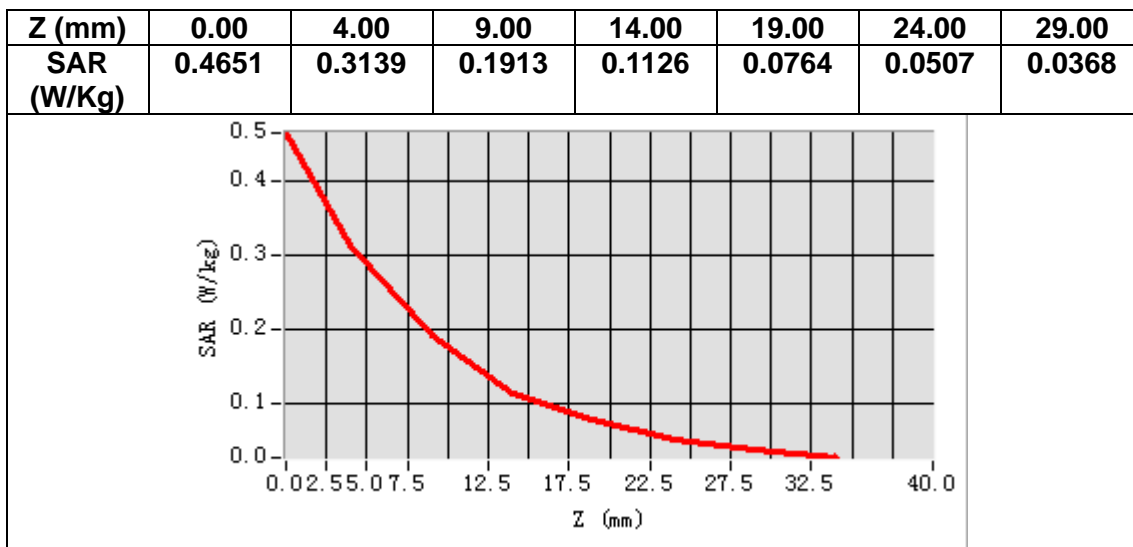

# MEASUREMENT 7

Date of measurement: 25/5/2022

## A. Experimental conditions.

<b>Area Scan</b>	<u>dx=15mm dy=15mm, h= 5.00 mm</u>
<b>ZoomScan</b>	<u>5x5x7,dx=8mm dy=8mm dz=5mm</u>
<b>Phantom</b>	<u>Left head</u>
<b>Device Position</b>	<u>Cheek</u>
<b>Band</b>	<u>Band5_WCDMA850</u>
<b>Channels</b>	<u>Middle</u>
<b>Signal</b>	<u>WCDMA (Crest factor: 1.0)</u>

## B. SAR Measurement Results

<b>Frequency (MHz)</b>	836.400000
<b>Relative permittivity (real part)</b>	41.820316
<b>Relative permittivity (imaginary part)</b>	19.665770
<b>Conductivity (S/m)</b>	0.913803
<b>Variation (%)</b>	3.840000

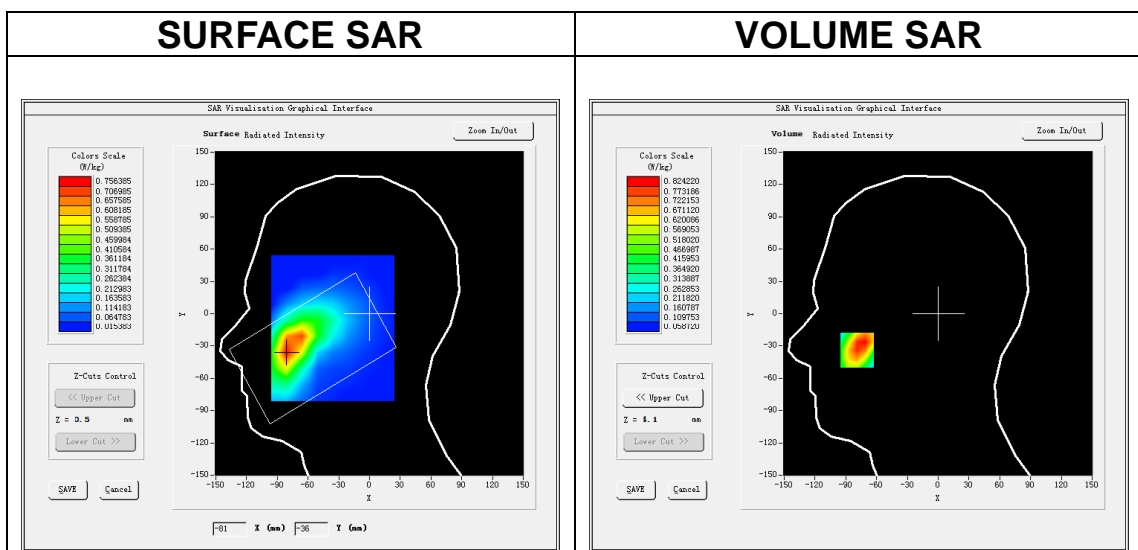

**Maximum location: X=-79.00, Y=-34.00**

**SAR Peak: 1.16 W/kg**

<b>SAR 10g (W/Kg)</b>	0.511432
<b>SAR 1g (W/Kg)</b>	0.797572

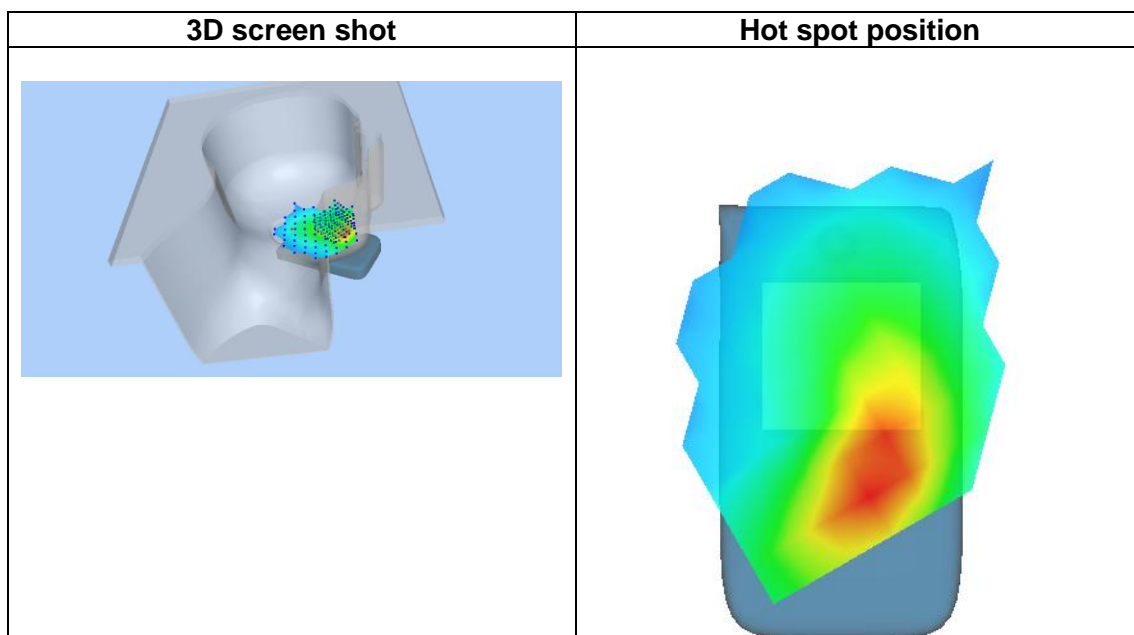
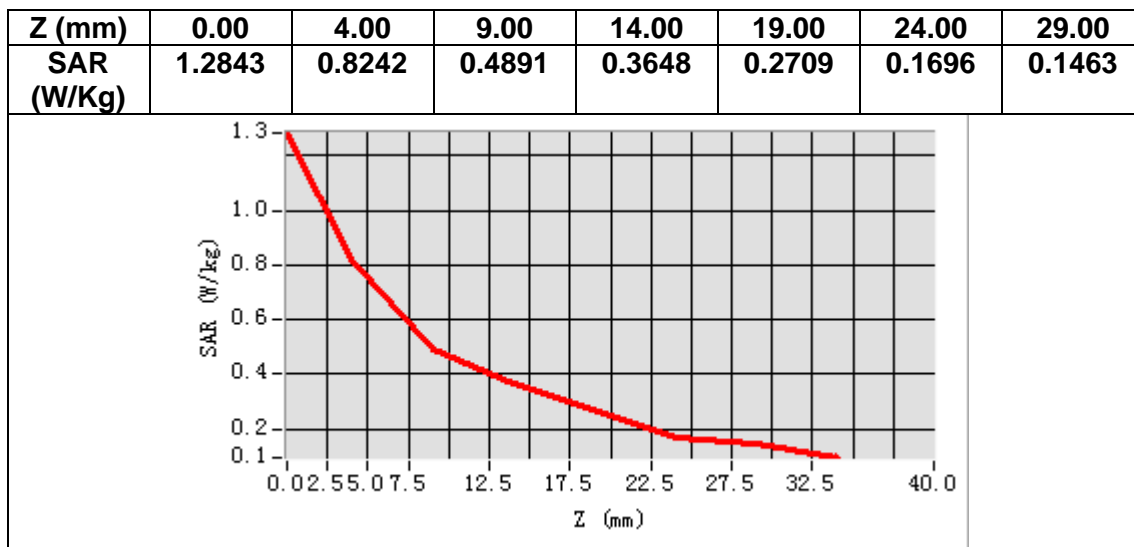

# MEASUREMENT 8

Date of measurement: 25/5/2022

## A. Experimental conditions.

<b>Area Scan</b>	<u>dx=15mm dy=15mm, h= 5.00 mm</u>
<b>ZoomScan</b>	<u>5x5x7, dx=8mm dy=8mm dz=5mm</u>
<b>Phantom</b>	<u>Validation plane</u>
<b>Device Position</b>	<u>Body</u>
<b>Band</b>	<u>Band5_WCDMA850</u>
<b>Channels</b>	<u>Low</u>
<b>Signal</b>	<u>WCDMA (Crest factor: 1.0)</u>

## B. SAR Measurement Results

<b>Frequency (MHz)</b>	826.400000
<b>Relative permittivity (real part)</b>	41.998276
<b>Relative permittivity (imaginary part)</b>	19.663050
<b>Conductivity (S/m)</b>	0.902752
<b>Variation (%)</b>	0.300000

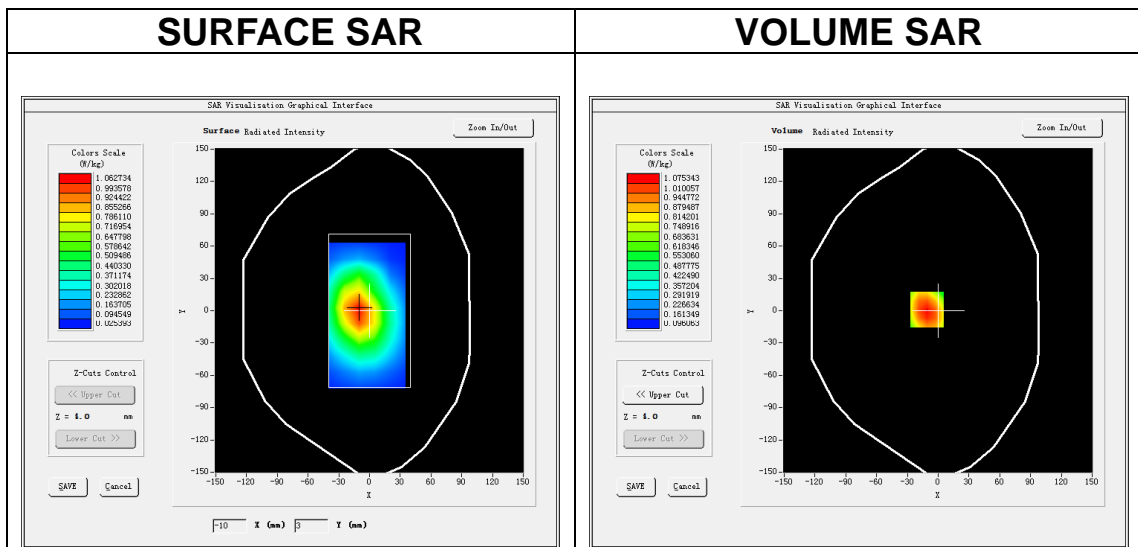

**Maximum location: X=-11.00, Y=1.00**

**SAR Peak: 1.42 W/kg**

<b>SAR 10g (W/Kg)</b>	0.698363
<b>SAR 1g (W/Kg)</b>	1.034110

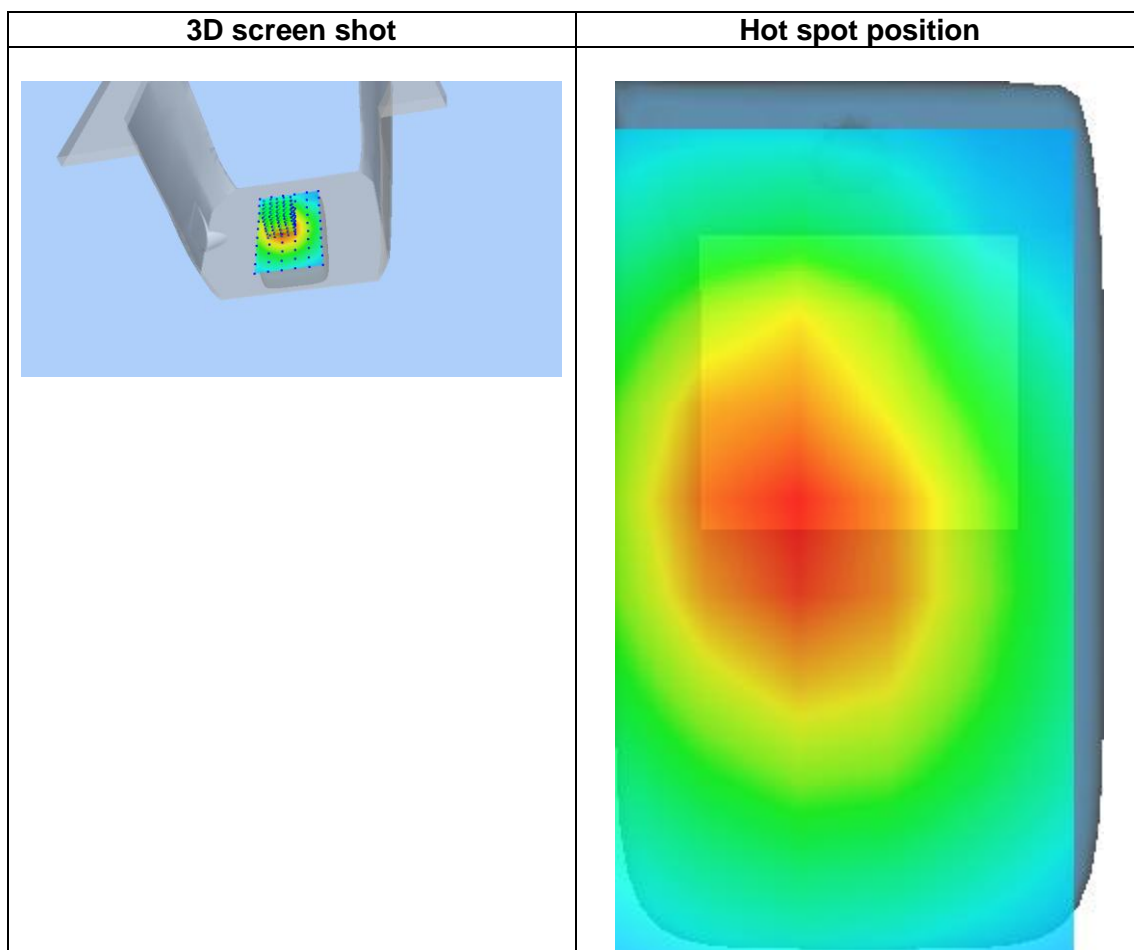
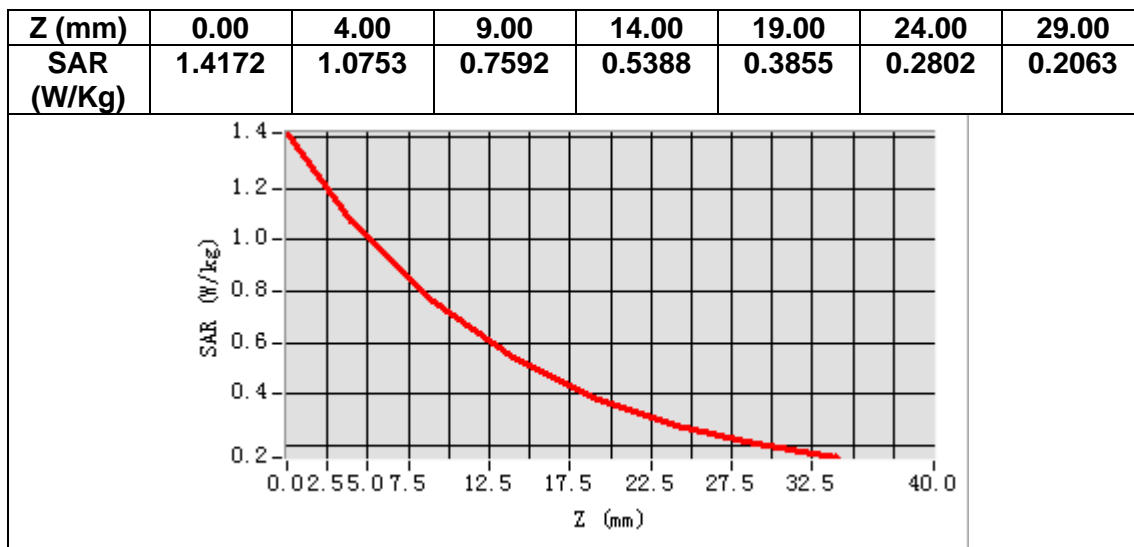

# MEASUREMENT 23

Date of measurement: 6/6/2022

## A. Experimental conditions.

<b>Area Scan</b>	<u>dx=12mm dy=12mm, h= 5.00 mm</u>
<b>ZoomScan</b>	<u>7x7x7,dx=5mm dy=5mm dz=5mm</u>
<b>Phantom</b>	<u>Left head</u>
<b>Device Position</b>	<u>Cheek</u>
<b>Band</b>	<u>IEEE 802.11b ISM</u>
<b>Channels</b>	<u>Middle</u>
<b>Signal</b>	<u>IEEE802.11b (Crest factor: 1.0)</u>

## B. SAR Measurement Results

<b>Frequency (MHz)</b>	2437.000000
<b>Relative permittivity (real part)</b>	38.332344
<b>Relative permittivity (imaginary part)</b>	12.986813
<b>Conductivity (S/m)</b>	1.758270
<b>Variation (%)</b>	-1.780000

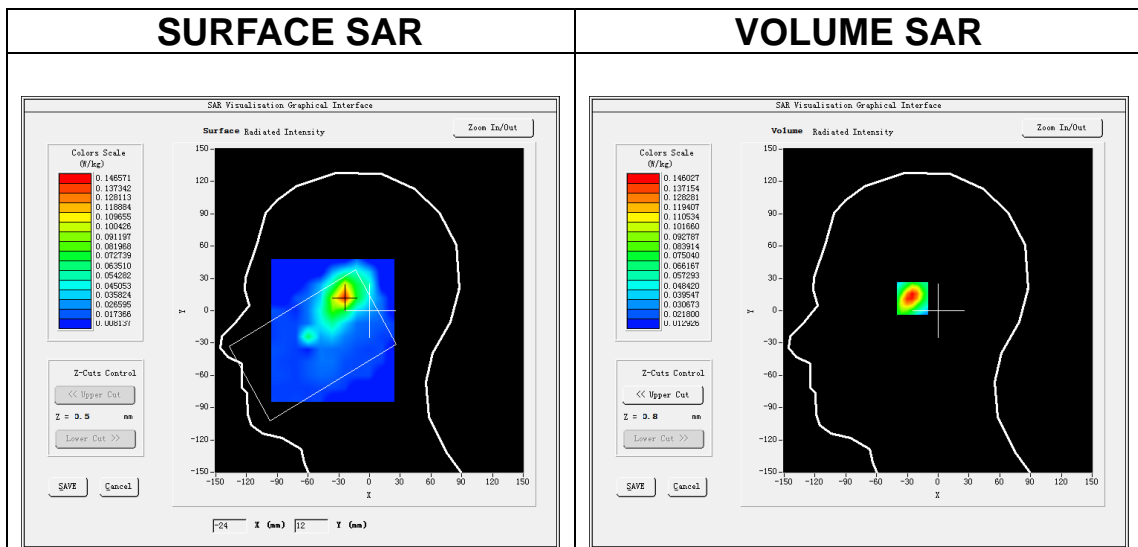

**Maximum location: X=-24.00, Y=13.00**

**SAR Peak: 0.24 W/kg**

<b>SAR 10g (W/Kg)</b>	0.070754
<b>SAR 1g (W/Kg)</b>	0.136358

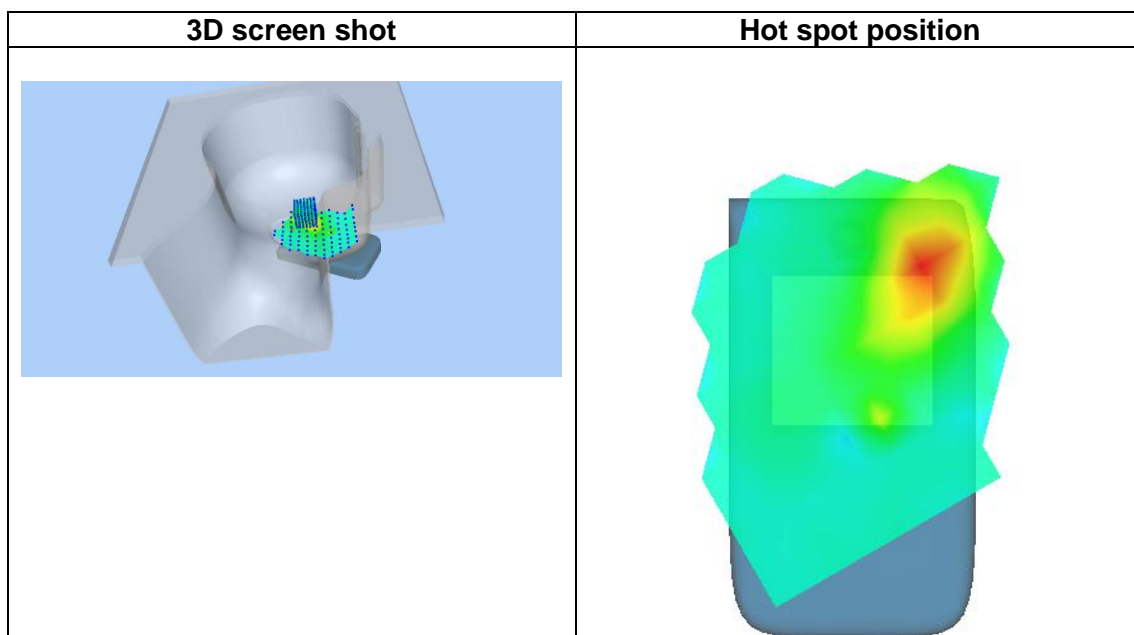
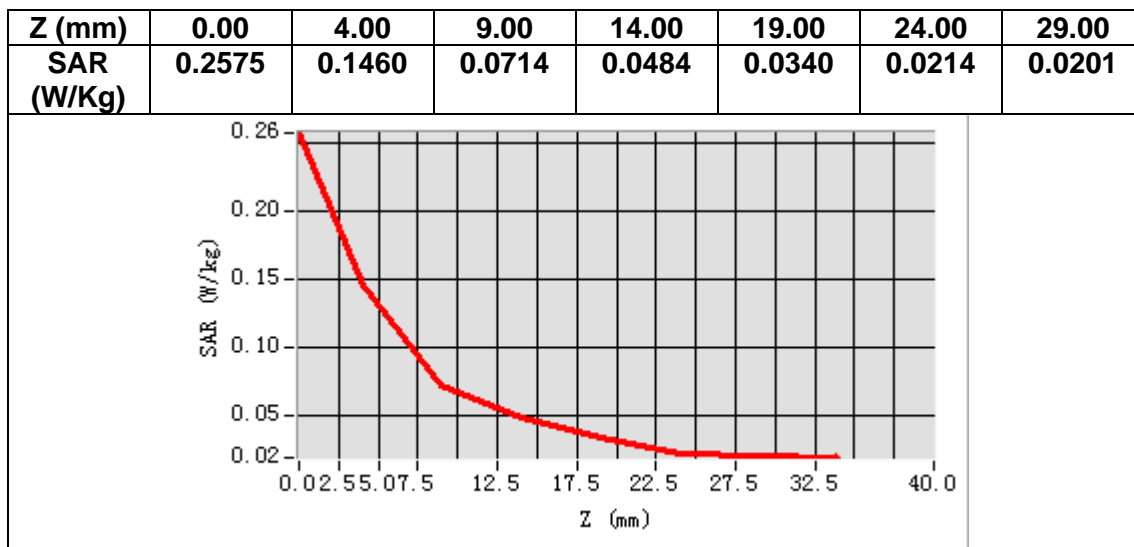



# MEASUREMENT 24

Date of measurement: 6/6/2022

## A. Experimental conditions.

<b>Area Scan</b>	<u>dx=12mm dy=12mm, h= 5.00 mm</u>
<b>ZoomScan</b>	<u>7x7x7, dx=5mm dy=5mm dz=5mm</u>
<b>Phantom</b>	<u>Validation plane</u>
<b>Device Position</b>	<u>Body</u>
<b>Band</b>	<u>IEEE 802.11b ISM</u>
<b>Channels</b>	<u>Middle</u>
<b>Signal</b>	<u>IEEE802.11b (Crest factor: 1.0)</u>

## B. SAR Measurement Results

<b>Frequency (MHz)</b>	2437.000000
<b>Relative permittivity (real part)</b>	38.332344
<b>Relative permittivity (imaginary part)</b>	12.986813
<b>Conductivity (S/m)</b>	1.758270
<b>Variation (%)</b>	-0.780000

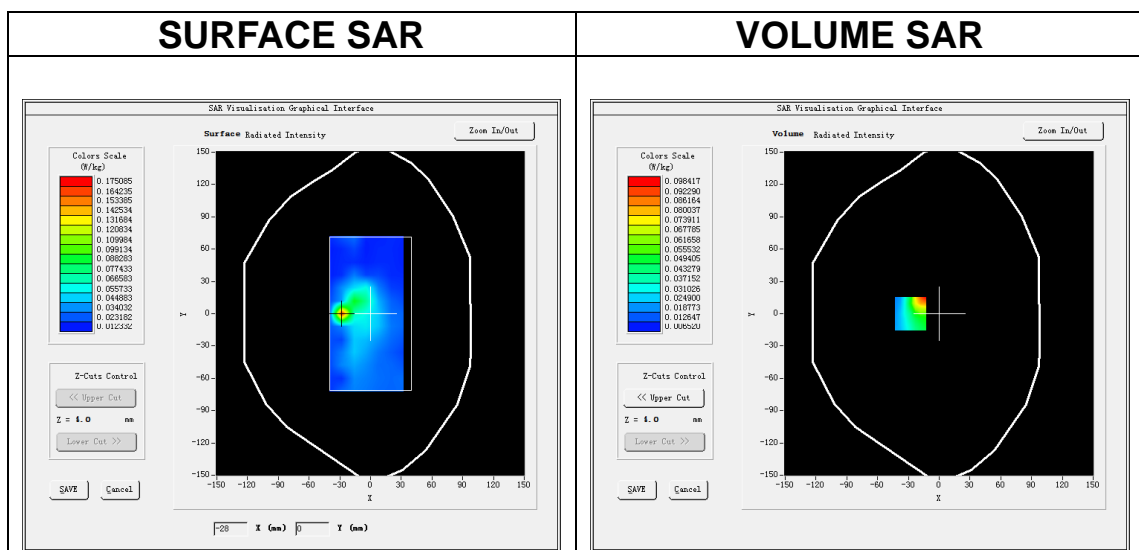

**Maximum location: X=-28.00, Y=0.00**

**SAR Peak: 0.16 W/kg**

<b>SAR 10g (W/Kg)</b>	0.039077
<b>SAR 1g (W/Kg)</b>	0.077690

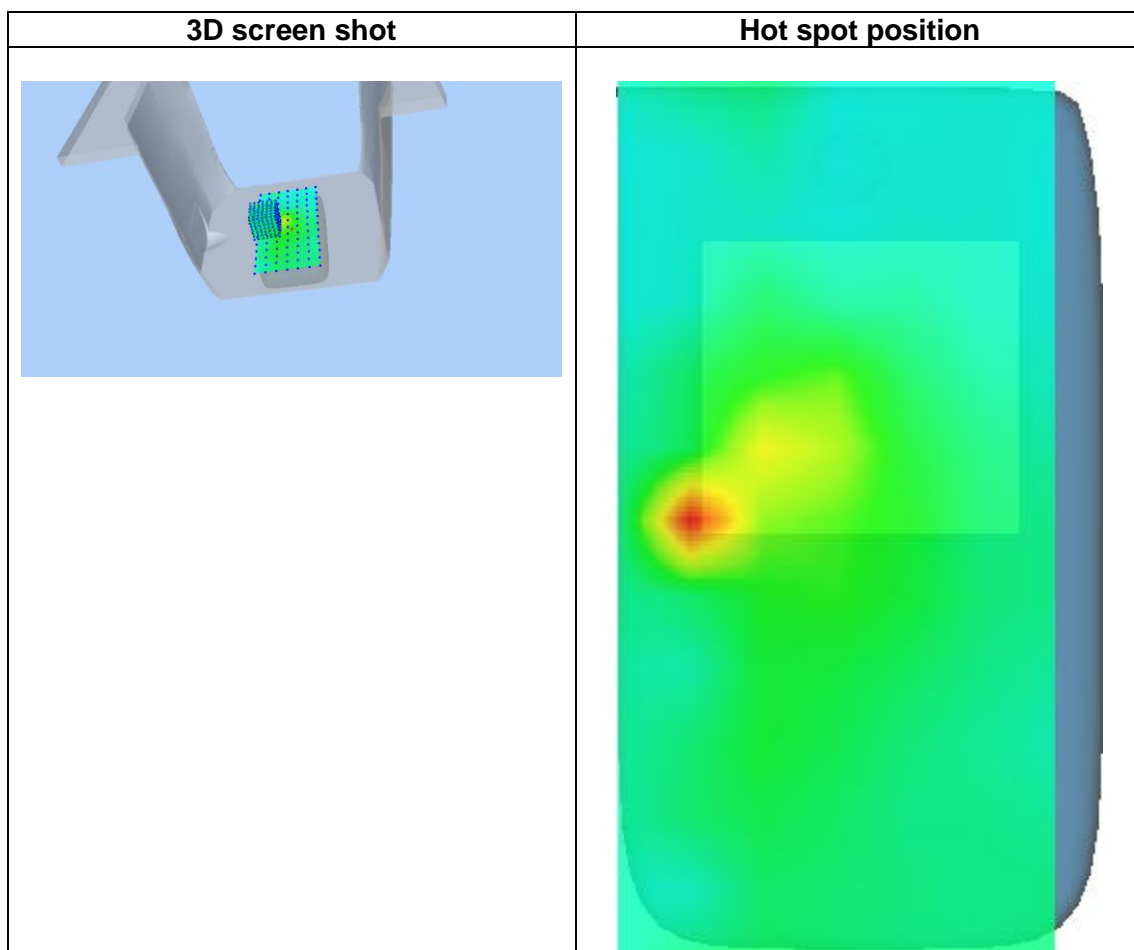
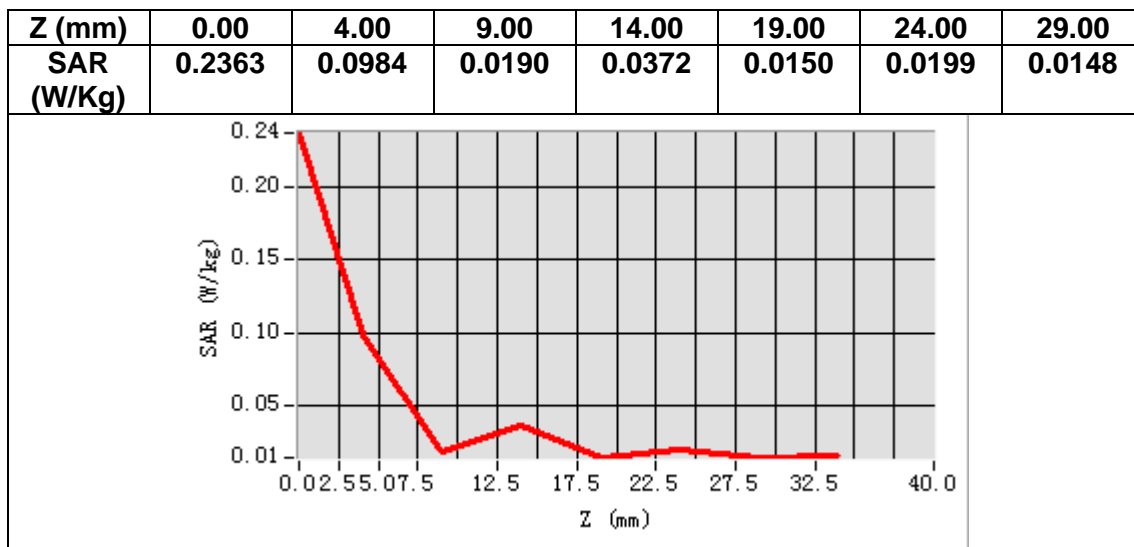

# MEASUREMENT 9

Date of measurement: 24/5/2022

## A. Experimental conditions.

<b>Area Scan</b>	<u>dx=15mm dy=15mm, h= 5.00 mm</u>
<b>ZoomScan</b>	<u>5x5x7,dx=8mm dy=8mm dz=5mm</u>
<b>Phantom</b>	<u>Left head</u>
<b>Device Position</b>	<u>Cheek</u>
<b>Band</b>	<u>LTE band 2</u>
<b>Channels</b>	<u>Middle</u>
<b>Signal</b>	<u>LTE (Crest factor: 1.0)</u>

## B. SAR Measurement Results

<b>Frequency (MHz)</b>	1880.000000
<b>Relative permittivity (real part)</b>	38.267174
<b>Relative permittivity (imaginary part)</b>	13.897697
<b>Conductivity (S/m)</b>	1.451537
<b>Variation (%)</b>	-1.000000

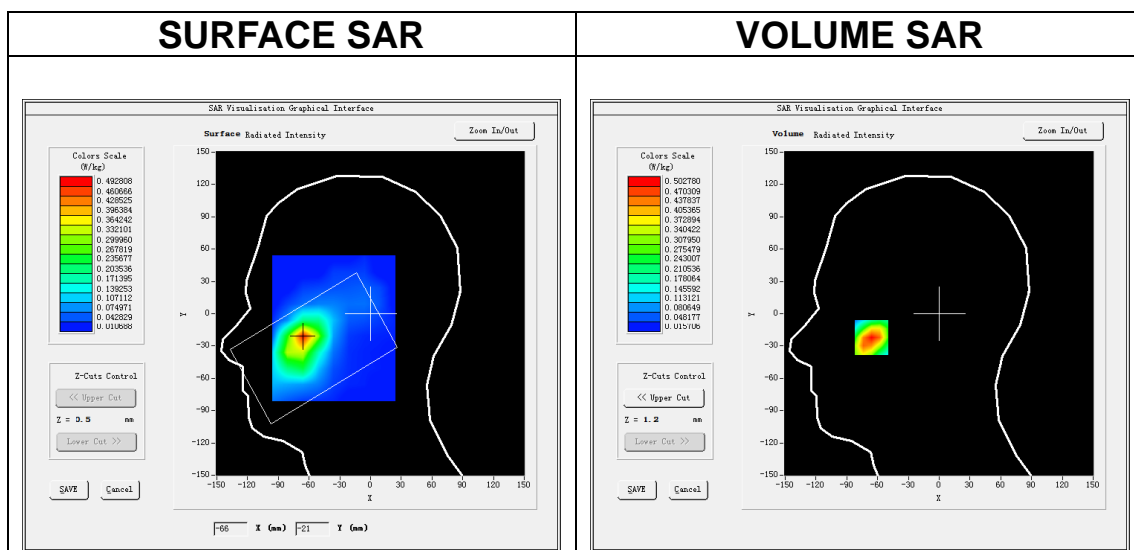

**Maximum location: X=-66.00, Y=-22.00**  
**SAR Peak: 0.74 W/kg**

<b>SAR 10g (W/Kg)</b>	0.267600
<b>SAR 1g (W/Kg)</b>	0.485891

Z (mm)	0.00	4.00	9.00	14.00	19.00	24.00	29.00
SAR (W/Kg)	0.7465	0.5028	0.3071	0.1930	0.1242	0.0825	0.0536

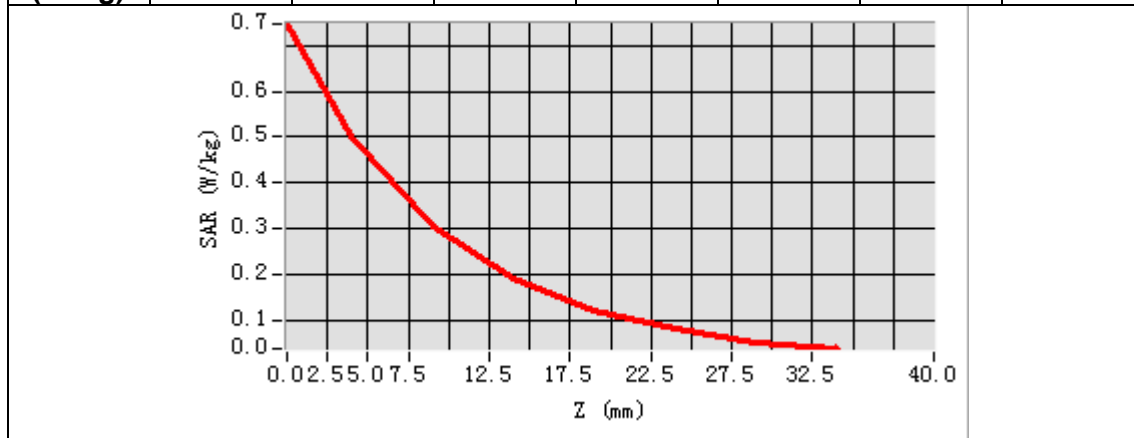

3D screen shot	Hot spot position
<p>A 3D rendering of a human head model. A grid of small colored spheres (blue, green, yellow, red) is overlaid on the face, representing the spatial distribution of SAR values. The highest values (red) are concentrated in the center of the forehead.</p>	<p>A 3D visualization of the hot spot position. It shows a color gradient map overlaid on a head model. The colors range from blue (low SAR) to red (high SAR), with the highest intensity (red) located in the center of the forehead, matching the hot spot in the 3D screen shot.</p>

# MEASUREMENT 10

Date of measurement: 24/5/2022

## A. Experimental conditions.

<b>Area Scan</b>	<u>dx=15mm dy=15mm, h= 5.00 mm</u>
<b>ZoomScan</b>	<u>5x5x7, dx=8mm dy=8mm dz=5mm</u>
<b>Phantom</b>	<u>Validation plane</u>
<b>Device Position</b>	<u>Body</u>
<b>Band</b>	<u>LTE band 2</u>
<b>Channels</b>	<u>Middle</u>
<b>Signal</b>	<u>LTE (Crest factor: 1.0)</u>

## B. SAR Measurement Results

<b>Frequency (MHz)</b>	1880.000000
<b>Relative permittivity (real part)</b>	38.267174
<b>Relative permittivity (imaginary part)</b>	13.897697
<b>Conductivity (S/m)</b>	1.451537
<b>Variation (%)</b>	0.110000

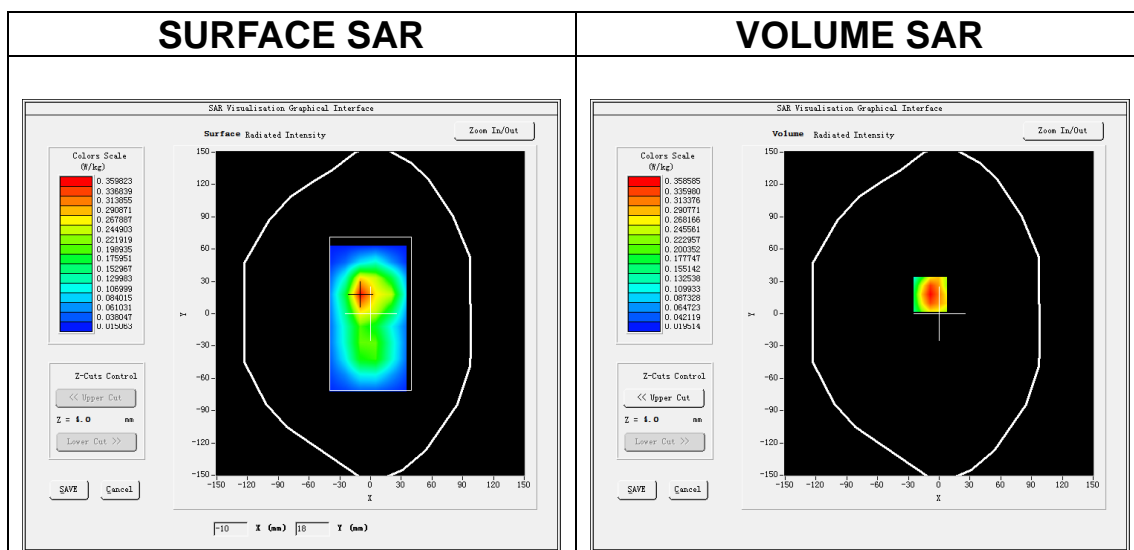

**Maximum location: X=-9.00, Y=18.00**

**SAR Peak: 0.53 W/kg**

<b>SAR 10g (W/Kg)</b>	0.200608
<b>SAR 1g (W/Kg)</b>	0.350326

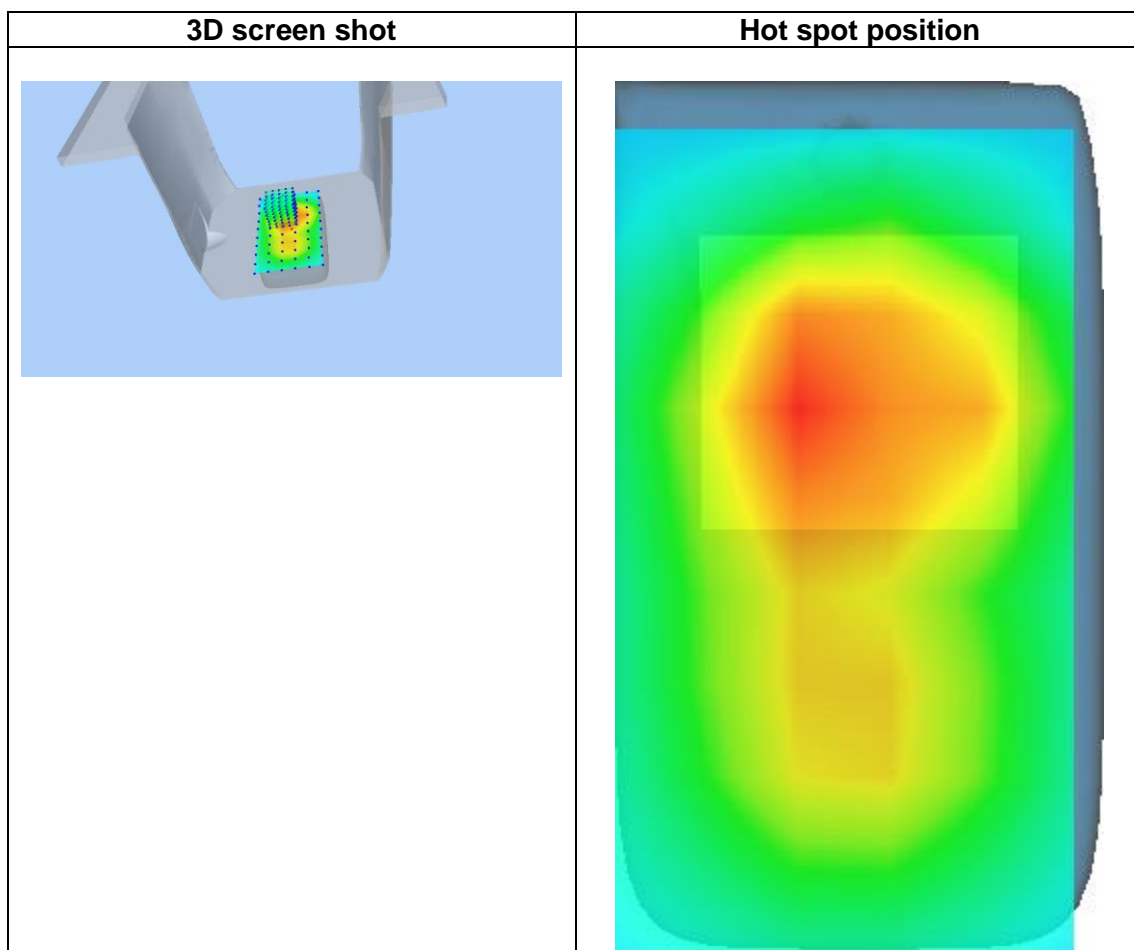
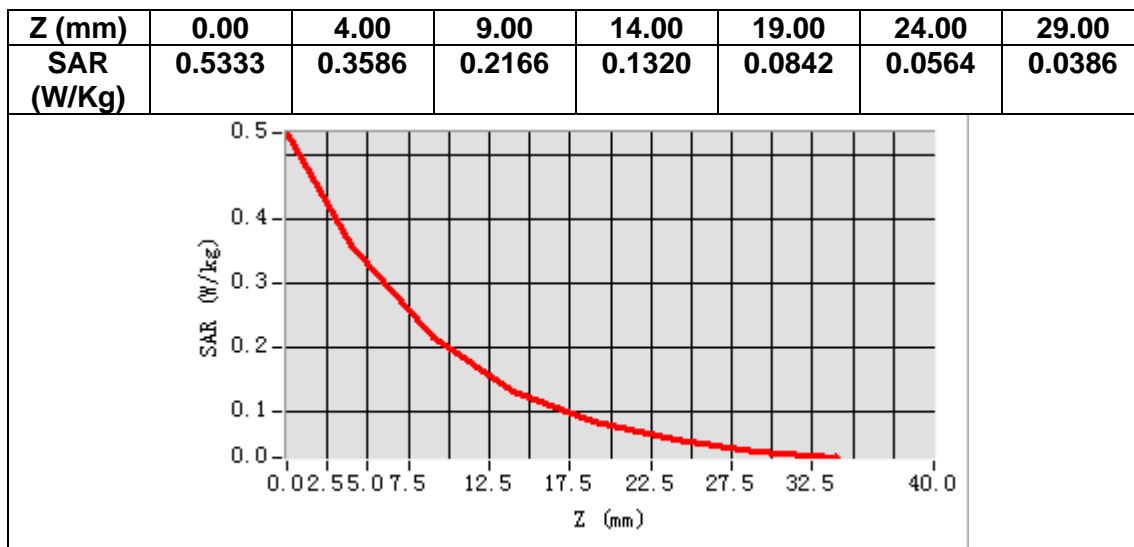

# MEASUREMENT 11

Date of measurement: 20/5/2022

## A. Experimental conditions.

<b>Area Scan</b>	<u>dx=15mm dy=15mm, h= 5.00 mm</u>
<b>ZoomScan</b>	<u>5x5x7,dx=8mm dy=8mm dz=5mm</u>
<b>Phantom</b>	<u>Left head</u>
<b>Device Position</b>	<u>Cheek</u>
<b>Band</b>	<u>LTE band 4</u>
<b>Channels</b>	<u>Middle</u>
<b>Signal</b>	<u>LTE (Crest factor: 1.0)</u>

## B. SAR Measurement Results

<b>Frequency (MHz)</b>	1732.500000
<b>Relative permittivity (real part)</b>	39.095963
<b>Relative permittivity (imaginary part)</b>	13.687687
<b>Conductivity (S/m)</b>	1.317440
<b>Variation (%)</b>	1.790000

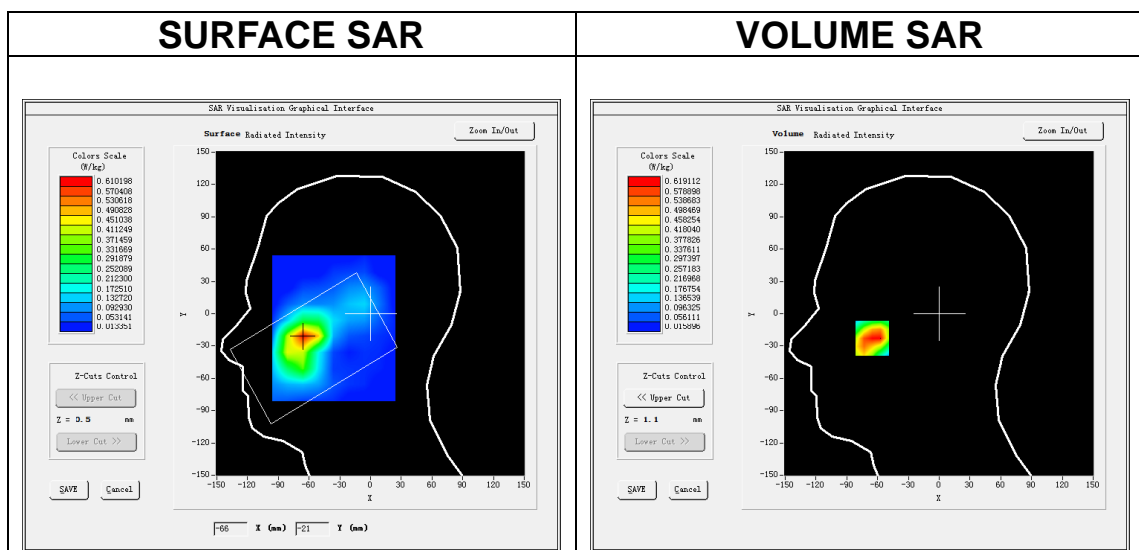

**Maximum location: X=-65.00, Y=-22.00**

**SAR Peak: 0.90 W/kg**

<b>SAR 10g (W/Kg)</b>	0.338863
<b>SAR 1g (W/Kg)</b>	0.592698

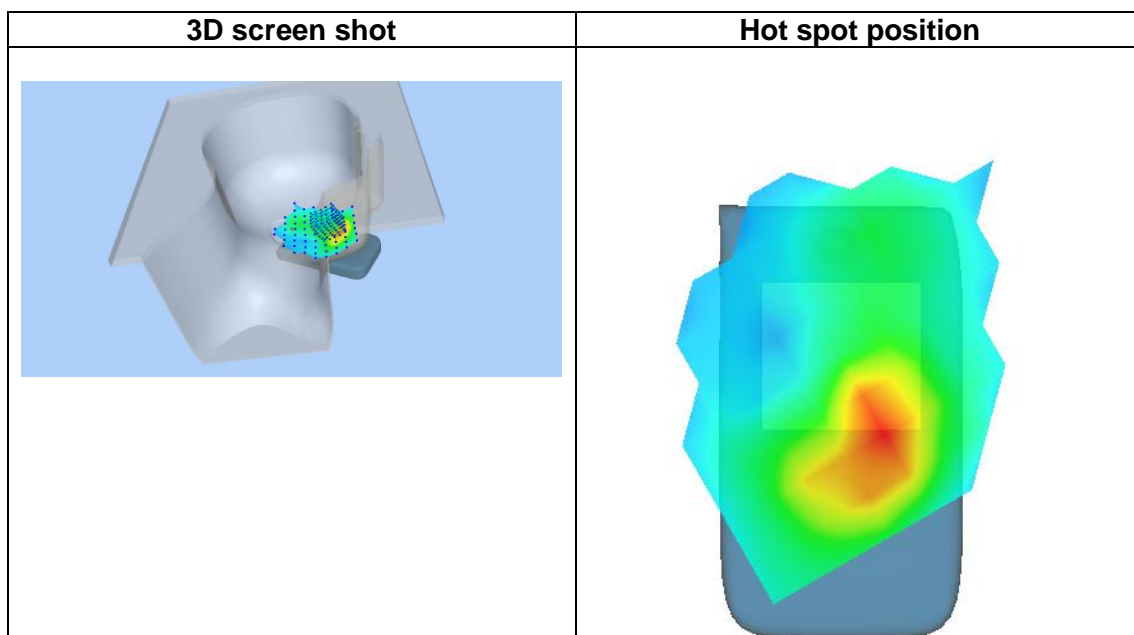
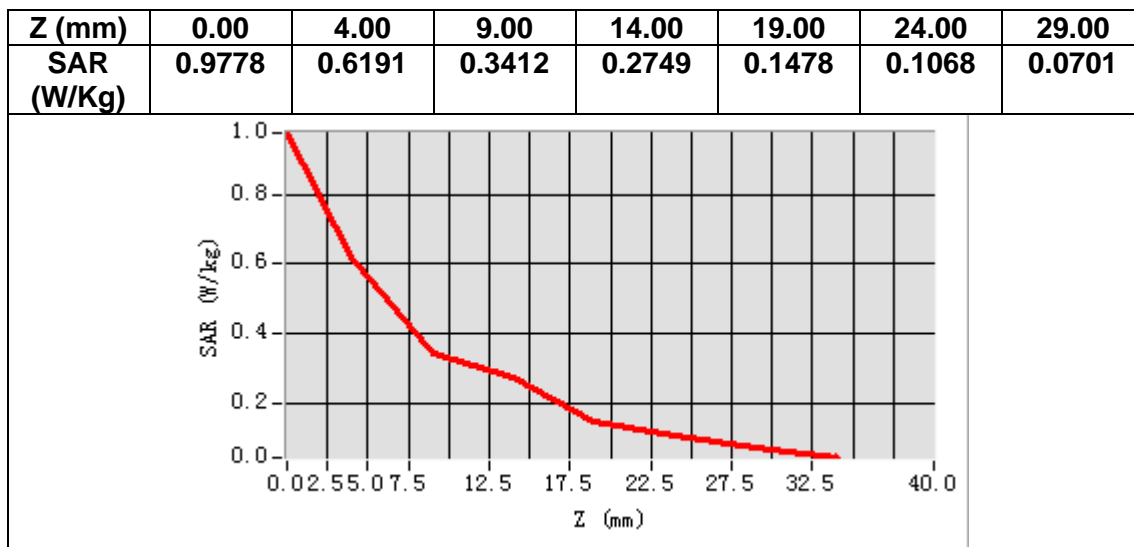



# MEASUREMENT 12

Date of measurement: 20/5/2022

## A. Experimental conditions.

<b>Area Scan</b>	<u>dx=15mm dy=15mm, h= 5.00 mm</u>
<b>ZoomScan</b>	<u>5x5x7, dx=8mm dy=8mm dz=5mm</u>
<b>Phantom</b>	<u>Validation plane</u>
<b>Device Position</b>	<u>Body</u>
<b>Band</b>	<u>LTE band 4</u>
<b>Channels</b>	<u>Middle</u>
<b>Signal</b>	<u>LTE (Crest factor: 1.0)</u>

## B. SAR Measurement Results

<b>Frequency (MHz)</b>	1732.500000
<b>Relative permittivity (real part)</b>	39.095963
<b>Relative permittivity (imaginary part)</b>	13.687687
<b>Conductivity (S/m)</b>	1.317440
<b>Variation (%)</b>	-1.450000

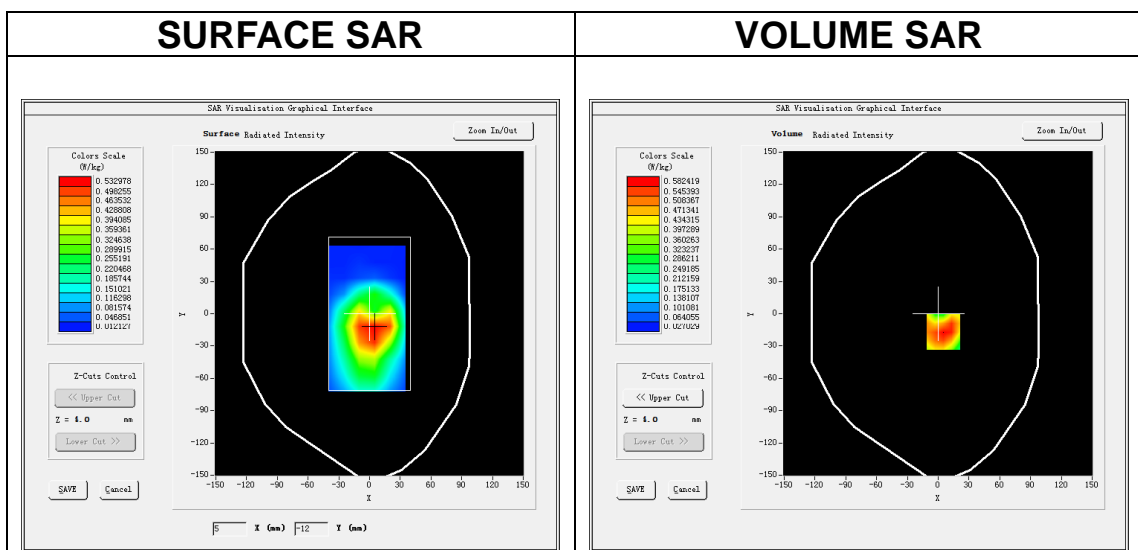

**Maximum location: X=5.00, Y=-17.00**

**SAR Peak: 0.89 W/kg**

<b>SAR 10g (W/Kg)</b>	0.330420
<b>SAR 1g (W/Kg)</b>	0.559663

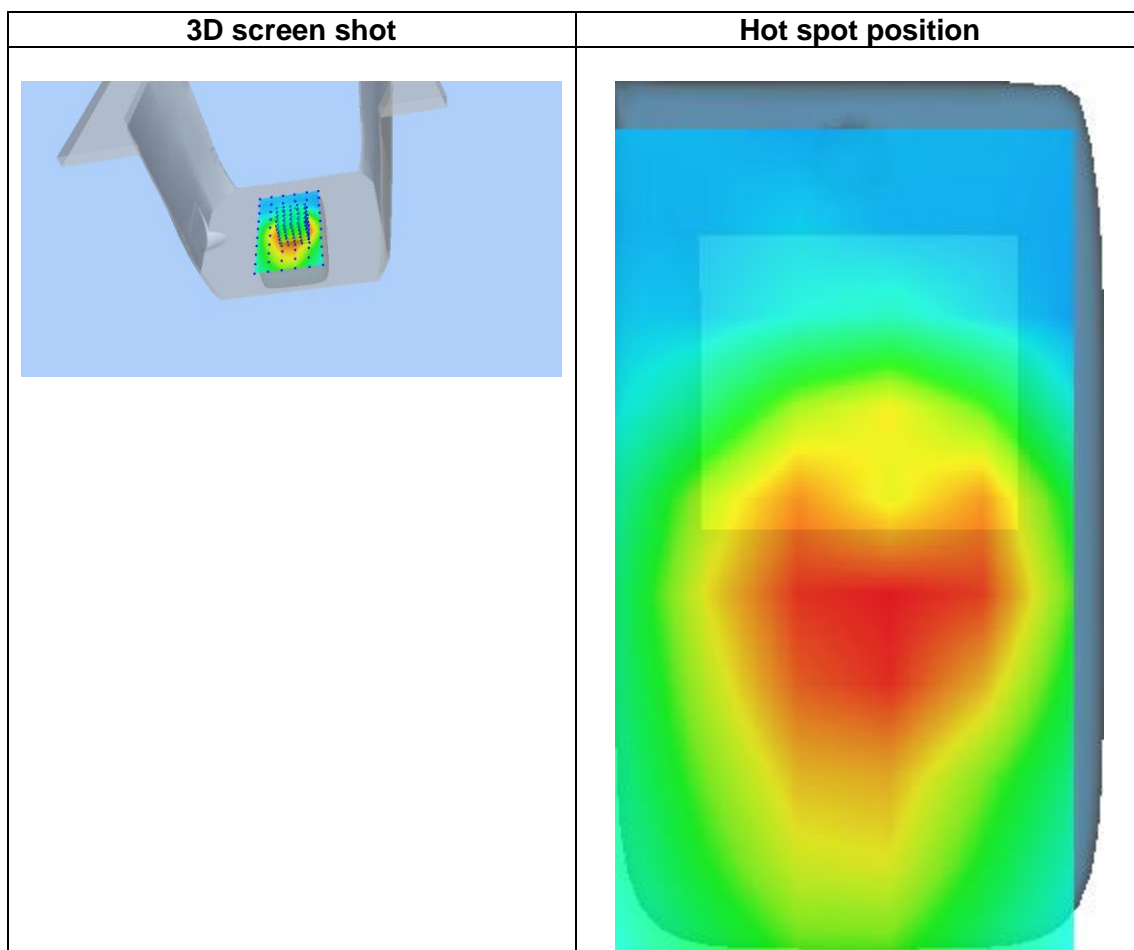
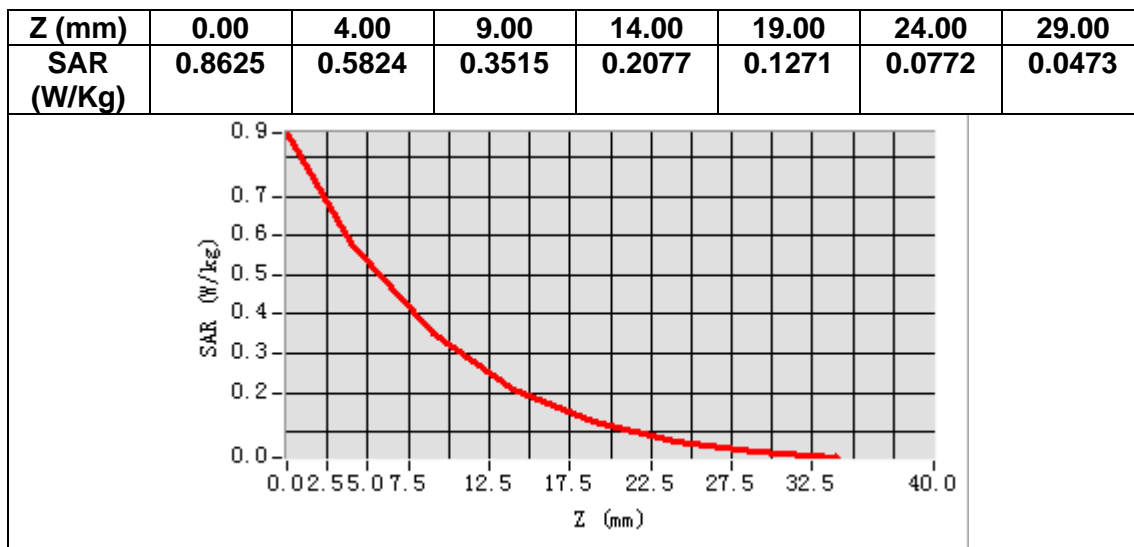

### 13. Appendix D. Calibration Certificate

Table of contents
E Field Probe - SN 08/16 EPGO287
835 MHz Dipole - SN 03/15 DIP 0G835-347
1800 MHz Dipole - SN 03/15 DIP 1G800-349
1900 MHz Dipole - SN 03/15 DIP 1G900-350
2450 MHz Dipole - SN 03/15 DIP 2G450-352



## COMOSAR E-Field Probe Calibration Report

Ref : ACR.60.1.21.MVGB.A

**SHENZHEN NTEK TESTING TECHNOLOGY  
CO., LTD.**

**BUILDING E, FENDA SCIENCE PARK, SANWEI  
COMMUNITY, XIXIANG STREET,  
BAO'AN DISTRICT, SHENZHEN GUANGDONG, CHINA  
MVG COMOSAR DOSIMETRIC E-FIELD PROBE  
SERIAL NO.: SN 08/16 EPGO287**

**Calibrated at MVG**

**Z.I. de la pointe du diable**

**Technopôle Brest Iroise – 295 avenue Alexis de Rochon  
29280 PLOUZANE - FRANCE**

**Calibration date: 02/01/2022**



Accreditations #2-6789 and #2-6814  
Scope available on [www.cofrac.fr](http://www.cofrac.fr)

*Summary:*

This document presents the method and results from an accredited COMOSAR E-Field Probe calibration performed at MVG, using the CALIPROBE test bench, for use with a MVG COMOSAR system only. The test results covered by accreditation are traceable to the International System of Units (SI).



COMOSAR E-FIELD PROBE CALIBRATION REPORT

Ref: ACR.60.1.21.MVGB.A

	Name	Function	Date	Signature
Prepared by :	Jérôme Luc	Technical Manager	2/1/2022	<i>JS</i>
Checked by :	Jérôme Luc	Technical Manager	2/1/2022	<i>JS</i>
Approved by :	Yann Toutain	Laboratory Director	2/1/2022	<i>Yann Toutain</i>

Mode d'emploi  
2022.02.0  
1 10:07:13  
+01'00'

PHILIPS

	Customer Name
Distribution :	SHENZHEN NTEK TESTING TECHNOLOGY CO., LTD.

Issue	Name	Date	Modifications
A	Jérôme Luc	2/1/2022	Initial release



COMOSAR E-FIELD PROBE CALIBRATION REPORT

Ref. ACR.60.1.21.MVGB.A

TABLE OF CONTENTS

1	Device Under Test .....	4
2	Product Description .....	4
2.1	General Information .....	4
3	Measurement Method .....	4
3.1	Linearity .....	4
3.2	Sensitivity .....	5
3.3	Lower Detection Limit .....	5
3.4	Isotropy .....	5
3.1	Boundary Effect .....	5
4	Measurement Uncertainty .....	6
5	Calibration Measurement Results .....	6
5.1	Sensitivity in air .....	6
5.2	Linearity .....	7
5.3	Sensitivity in liquid .....	8
5.4	Isotropy .....	9
6	List of Equipment .....	10



**COMOSAR E-FIELD PROBE CALIBRATION REPORT**

Ref: ACR.60.1.21.MVGB.A

**1 DEVICE UNDER TEST**

Device Under Test	
Device Type	COMOSAR DOSIMETRIC E FIELD PROBE
Manufacturer	MVG
Model	SSE2
Serial Number	SN 08/16 EPGO287
Product Condition (new / used)	Used
Frequency Range of Probe	0.15 GHz-6GHz
Resistance of Three Dipoles at Connector	Dipole 1: R1=0.211 MΩ Dipole 2: R2=0.199 MΩ Dipole 3: R3=0.199 MΩ

**2 PRODUCT DESCRIPTION**

**2.1 GENERAL INFORMATION**

MVG’s COMOSAR E field Probes are built in accordance to the IEEE 1528, FCC KDB865664 D01, CENELEC EN62209 and CEI/IEC 62209 standards.



**Figure 1 – MVG COMOSAR Dosimetric E field Dipole**

Probe Length	330 mm
Length of Individual Dipoles	2 mm
Maximum external diameter	8 mm
Probe Tip External Diameter	2.5 mm
Distance between dipoles / probe extremity	1 mm

**3 MEASUREMENT METHOD**

The IEEE 1528, FCC KDB865664 D01, CENELEC EN62209 and CEI/IEC 62209 standards provide recommended practices for the probe calibrations, including the performance characteristics of interest and methods by which to assess their affect. All calibrations / measurements performed meet the fore mentioned standards.

**3.1 LINEARITY**

The evaluation of the linearity was done in free space using the waveguide, performing a power sweep to cover the SAR range 0.01W/kg to 100W/kg.



COMOSAR E-FIELD PROBE CALIBRATION REPORT

Ref: ACR.60.1.21.MVGB.A

3.2 SENSITIVITY

The sensitivity factors of the three dipoles were determined using a two step calibration method (air and tissue simulating liquid) using waveguides as outlined in the standards.

3.3 LOWER DETECTION LIMIT

The lower detection limit was assessed using the same measurement set up as used for the linearity measurement. The required lower detection limit is 10 mW/kg.

3.4 ISOTROPY

The axial isotropy was evaluated by exposing the probe to a reference wave from a standard dipole with the dipole mounted under the flat phantom in the test configuration suggested for system validations and checks. The probe was rotated along its main axis from 0 to 360 degrees in 15-degree steps. The hemispherical isotropy is determined by inserting the probe in a thin plastic box filled with tissue-equivalent liquid, with the plastic box illuminated with the fields from a half wave dipole. The dipole is rotated about its axis (0°–180°) in 15° increments. At each step the probe is rotated about its axis (0°–360°).

3.1 BOUNDARY EFFECT

The boundary effect is defined as the deviation between the SAR measured data and the expected exponential decay in the liquid when the probe is oriented normal to the interface. To evaluate this effect, the liquid filled flat phantom is exposed to fields from either a reference dipole or waveguide. With the probe normal to the phantom surface, the peak spatial average SAR is measured and compared to the analytical value at the surface.

The boundary effect uncertainty can be estimated according to the following uncertainty approximation formula based on linear and exponential extrapolations between the surface and  $d_{be} + d_{step}$  along lines that are approximately normal to the surface:

$$SAR_{uncertainty} [\%] = \Delta SAR_{be} \frac{(d_{be} + d_{step})^2}{2d_{step}} \frac{(e^{-d_{be}/\delta})}{\delta/2} \text{ for } (d_{be} + d_{step}) < 10 \text{ mm}$$

where

- $SAR_{uncertainty}$  is the uncertainty in percent of the probe boundary effect
- $d_{be}$  is the distance between the surface and the closest *zoom-scan* measurement point, in millimetre
- $\Delta_{step}$  is the separation distance between the first and second measurement points that are closest to the phantom surface, in millimetre, assuming the boundary effect at the second location is negligible
- $\delta$  is the minimum penetration depth in millimetres of the head tissue-equivalent liquids defined in this standard, i.e.,  $\delta \approx 14$  mm at 3 GHz;
- $\Delta SAR_{be}$  in percent of SAR is the deviation between the measured SAR value, at the distance  $d_{be}$  from the boundary, and the analytical SAR value.





**COMOSAR E-FIELD PROBE CALIBRATION REPORT**

Ref: ACR.60.1.21.MVGB.A

The measured worst case boundary effect SARuncertainty[%] for scanning distances larger than 4mm is 1.0% Limit ,2%).

**4 MEASUREMENT UNCERTAINTY**

The guidelines outlined in the IEEE 1528, OET 65 Bulletin C, CENELEC EN50361 and CEI/IEC 62209 standards were followed to generate the measurement uncertainty associated with an E-field probe calibration using the waveguide technique. All uncertainties listed below represent an expanded uncertainty expressed at approximately the 95% confidence level using a coverage factor of k=2, traceable to the Internationally Accepted Guides to Measurement Uncertainty.

Uncertainty analysis of the probe calibration in waveguide					
ERROR SOURCES	Uncertainty value (%)	Probability Distribution	Divisor	ci	Standard Uncertainty (%)
Expanded uncertainty 95 % confidence level k = 2					14 %

**5 CALIBRATION MEASUREMENT RESULTS**

Calibration Parameters	
Liquid Temperature	20 +/- 1 °C
Lab Temperature	20 +/- 1 °C
Lab Humidity	30-70 %

**5.1 SENSITIVITY IN AIR**

Normx dipole 1 (µV/(V/m) <sup>2</sup> )	Normy dipole 2 (µV/(V/m) <sup>2</sup> )	Normz dipole 3 (µV/(V/m) <sup>2</sup> )
0.72	0.66	0.77

DCP dipole 1 (mV)	DCP dipole 2 (mV)	DCP dipole 3 (mV)
107	110	110

Calibration curves ei=f(V) (i=1,2,3) allow to obtain E-field value using the formula:

$$E = \sqrt{E_1^2 + E_2^2 + E_3^2}$$



COMOSAR E-FIELD PROBE CALIBRATION REPORT

Ref: ACR.60.1.21.MVGB.A

Calibration curves

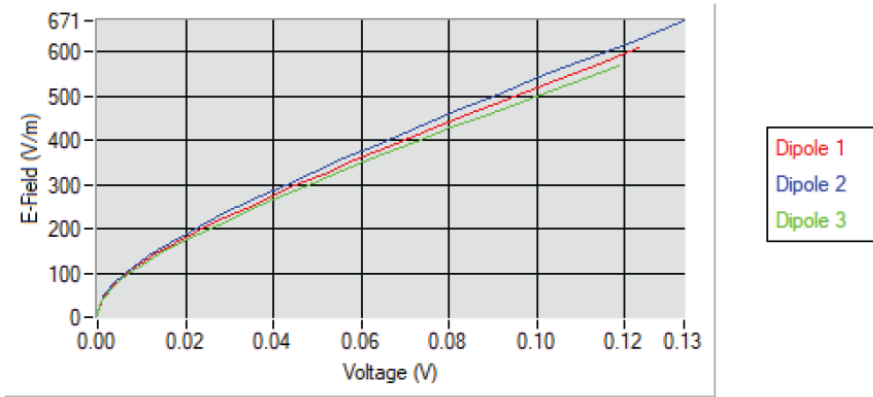

5.2 LINEARITY

Linearity

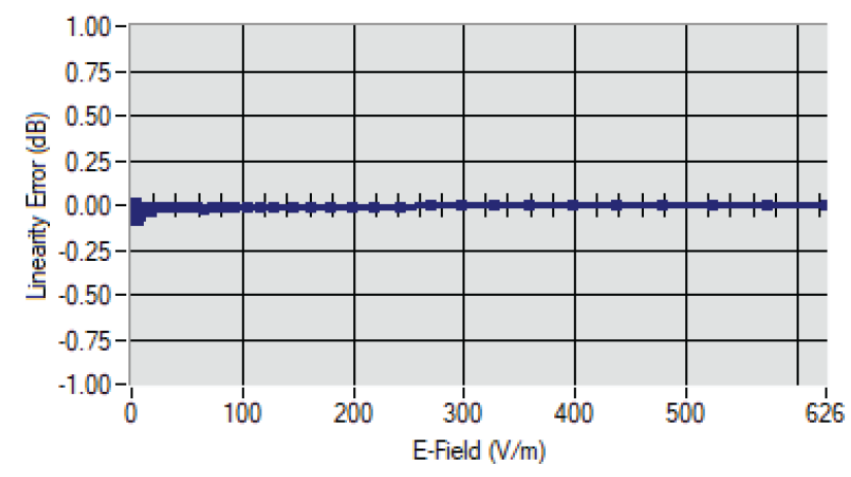

Linearity: +/-1.90% (+/-0.08dB)



COMOSAR E-FIELD PROBE CALIBRATION REPORT

Ref: ACR.60.1.21.MVGB.A

5.3 SENSITIVITY IN LIQUID

Liquid	Frequency (MHz +/- 100MHz)	ConvF
HL750	750	1.49
HL850	835	1.50
HL900	900	1.61
HL1800	1800	1.73
HL1900	1900	1.91
HL2000	2000	1.97
HL2300	2300	1.92
HL2450	2450	1.98
HL2600	2600	1.87
HL3300	3300	1.79
HL3500	3500	1.85
HL3700	3700	1.79
HL3900	3900	2.07
HL4200	4200	2.21
HL4600	4600	2.25
HL4900	4900	2.05
HL5200	5200	1.80
HL5400	5400	2.05
HL5600	5600	2.16
HL5800	5800	2.07

LOWER DETECTION LIMIT: 8mW/kg



COMOSAR E-FIELD PROBE CALIBRATION REPORT

Ref: ACR.60.1.21.MVGB.A

5.4 ISOTROPY

HL1800 MHz

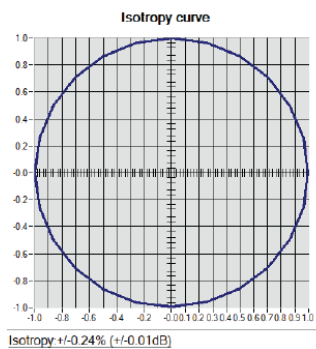



COMOSAR E-FIELD PROBE CALIBRATION REPORT

Ref: ACR.60.1.21.MVGB.A

6 LIST OF EQUIPMENT

Equipment Summary Sheet				
Equipment Description	Manufacturer / Model	Identification No.	Current Calibration Date	Next Calibration Date
Flat Phantom	MVG	SN-20/09-SAM71	Validated. No cal required.	Validated. No cal required.
COMOSAR Test Bench	Version 3	NA	Validated. No cal required.	Validated. No cal required.
Network Analyzer	Rohde & Schwarz ZVM	100203	05/2019	05/2022
Network Analyzer – Calibration kit	Rohde & Schwarz ZV-Z235	101223	05/2019	05/2022
Multimeter	Keithley 2000	1160271	02/2020	02/2023
Signal Generator	Rohde & Schwarz SMB	106589	04/2019	04/2022
Amplifier	Aethercomm	SN 046	Characterized prior to test. No cal required.	Characterized prior to test. No cal required.
Power Meter	NI-USB 5680	170100013	05/2019	05/2022
Directional Coupler	Narda 4216-20	01386	Characterized prior to test. No cal required.	Characterized prior to test. No cal required.
Waveguide	Mega Industries	069Y7-158-13-712	Validated. No cal required.	Validated. No cal required.
Waveguide Transition	Mega Industries	069Y7-158-13-701	Validated. No cal required.	Validated. No cal required.
Waveguide Termination	Mega Industries	069Y7-158-13-701	Validated. No cal required.	Validated. No cal required.
Temperature / Humidity Sensor	Testo 184 H1	44220687	05/2020	05/2023



## SAR Reference Dipole Calibration Report

Ref : ACR.60.3.21.MVGB.A

### SHENZHEN NTEK TESTING TECHNOLOGY CO., LTD.

BUILDING E, FENDA SCIENCE PARK, SANWEI  
COMMUNITY, XIXIANG STREET,  
BAO'AN DISTRICT, SHENZHEN GUANGDONG, CHINA  
MVG COMOSAR REFERENCE DIPOLE

FREQUENCY: 835 MHZ

SERIAL NO.: SN 03/15 DIP0G835-347

#### Calibrated at MVG

Z.I. de la pointe du diable

Technopôle Brest Iroise – 295 avenue Alexis de Rochon

29280 PLOUZANE - FRANCE

Calibration date: 03/01/2021



Accreditations #2-6789 and #2-6814  
Scope available on [www.cofrac.fr](http://www.cofrac.fr)

#### *Summary:*

This document presents the method and results from an accredited SAR reference dipole calibration performed at MVG, using the COMOSAR test bench. The test results covered by accreditation are traceable to the International System of Units (SI).



SAR REFERENCE DIPOLE CALIBRATION REPORT

Ref: ACR.60.3.21.MVGB.A

	Name	Function	Date	Signature
Prepared by :	Jérôme Luc	Technical Manager	3/1/2021	<i>JLS</i>
Checked by :	Jérôme Luc	Technical Manager	3/1/2021	<i>JLS</i>
Approved by :	Yann Toutain	Laboratory Director	3/1/2021	<i>Yann Toutain</i>

Mode d'emploi 2021.03.0  
1 13:09:12  
+01'00'

PHILIPS

	Customer Name
Distribution :	SHENZHEN NTEK TESTING TECHNOLOGY CO., LTD.

Issue	Name	Date	Modifications
A	Jérôme Luc	3/1/2021	Initial release



**SAR REFERENCE DIPOLE CALIBRATION REPORT**

Ref. ACR.60.3.21.MVGB.A

**TABLE OF CONTENTS**

1	Introduction.....	4
2	Device Under Test .....	4
3	Product Description .....	4
3.1	General Information .....	4
4	Measurement Method .....	5
4.1	Return Loss Requirements .....	5
4.2	Mechanical Requirements .....	5
5	Measurement Uncertainty.....	5
5.1	Return Loss .....	5
5.2	Dimension Measurement .....	5
5.3	Validation Measurement .....	5
6	Calibration Measurement Results.....	6
6.1	Return Loss and Impedance .....	6
6.2	Mechanical Dimensions .....	6
7	Validation measurement .....	7
7.1	Measurement Condition .....	7
7.2	Head Liquid Measurement .....	7
7.3	Measurement Result .....	8
8	List of Equipment .....	10





**SAR REFERENCE DIPOLE CALIBRATION REPORT**

Ref: ACR.60.3.21.MVGB.A

**1 INTRODUCTION**

This document contains a summary of the requirements set forth by the IEEE 1528, FCC KDBs and CEI/IEC 62209 standards for reference dipoles used for SAR measurement system validations and the measurements that were performed to verify that the product complies with the fore mentioned standards.

**2 DEVICE UNDER TEST**

Device Under Test	
Device Type	COMOSAR 835 MHz REFERENCE DIPOLE
Manufacturer	MVG
Model	SID835
Serial Number	SN 03/15 DIP0G835-347
Product Condition (new / used)	Used

**3 PRODUCT DESCRIPTION**

**3.1 GENERAL INFORMATION**

MVG’s COMOSAR Validation Dipoles are built in accordance to the IEEE 1528, FCC KDBs and CEI/IEC 62209 standards. The product is designed for use with the COMOSAR test bench only.



**Figure 1 – MVG COMOSAR Validation Dipole**



**SAR REFERENCE DIPOLE CALIBRATION REPORT**

Ref: ACR.60.3.21.MVGB.A

**4 MEASUREMENT METHOD**

The IEEE 1528, FCC KDBs and CEI/IEC 62209 standards provide requirements for reference dipoles used for system validation measurements. The following measurements were performed to verify that the product complies with the fore mentioned standards.

**4.1 RETURN LOSS REQUIREMENTS**

The dipole used for SAR system validation measurements and checks must have a return loss of -20 dB or better. The return loss measurement shall be performed against a liquid filled phantom, with the phantom constructed as outlined in the fore mentioned standards. A direct method is used with a network analyser and its calibration kit, both with a valid ISO17025 calibration.

**4.2 MECHANICAL REQUIREMENTS**

The IEEE Std. 1528 and CEI/IEC 62209 standards specify the mechanical components and dimensions of the validation dipoles, with the dimension's frequency and phantom shell thickness dependent. The COMOSAR test bench employs a 2 mm phantom shell thickness therefore the dipoles sold for use with the COMOSAR test bench comply with the requirements set forth for a 2 mm phantom shell thickness. A direct method is used with a ISO17025 calibrated caliper.

**5 MEASUREMENT UNCERTAINTY**

All uncertainties listed below represent an expanded uncertainty expressed at approximately the 95% confidence level using a coverage factor of k=2, traceable to the Internationally Accepted Guides to Measurement Uncertainty.

**5.1 RETURN LOSS**

The following uncertainties apply to the return loss measurement:

Frequency band	Expanded Uncertainty on Return Loss
400-6000MHz	0.08 LIN

**5.2 DIMENSION MEASUREMENT**

The following uncertainties apply to the dimension measurements:

Length (mm)	Expanded Uncertainty on Length
0 - 300	0.20 mm
300 - 450	0.44 mm

**5.3 VALIDATION MEASUREMENT**

The guidelines outlined in the IEEE 1528, FCC KDBs, CENELEC EN50361 and CEI/IEC 62209 standards were followed to generate the measurement uncertainty for validation measurements.

Scan Volume	Expanded Uncertainty



**SAR REFERENCE DIPOLE CALIBRATION REPORT**

Ref. ACR.60.3.21.MVGB.A

1 g	19 % (SAR)
10 g	19 % (SAR)

**6 CALIBRATION MEASUREMENT RESULTS**

**6.1 RETURN LOSS AND IMPEDANCE**

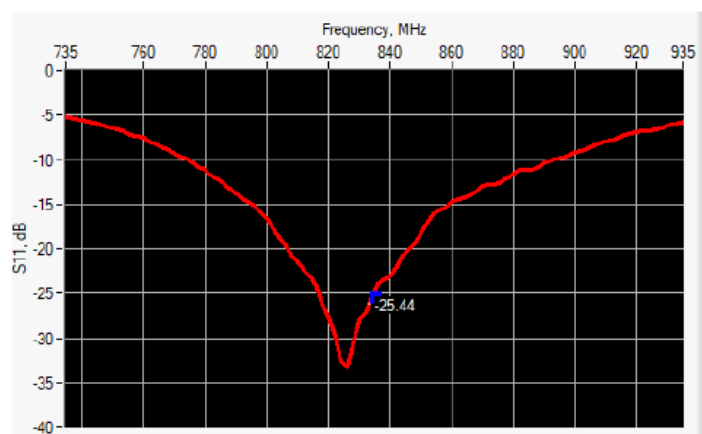

Frequency (MHz)	Return Loss (dB)	Requirement (dB)	Impedance
835	-25.44	-20	54.4 Ω - 2.9 jΩ

**6.2 MECHANICAL DIMENSIONS**

Frequency MHz	L mm		h mm		d mm	
	required	measured	required	measured	required	measured
300	420.0 ±1 %		250.0 ±1 %		6.35 ±1 %	
450	290.0 ±1 %		166.7 ±1 %		6.35 ±1 %	
750	176.0 ±1 %		100.0 ±1 %		6.35 ±1 %	
835	161.0 ±1 %	-	89.8 ±1 %	-	3.6 ±1 %	-
900	149.0 ±1 %		83.3 ±1 %		3.6 ±1 %	
1450	89.1 ±1 %		51.7 ±1 %		3.6 ±1 %	
1500	80.5 ±1 %		50.0 ±1 %		3.6 ±1 %	
1640	79.0 ±1 %		45.7 ±1 %		3.6 ±1 %	
1750	75.2 ±1 %		42.9 ±1 %		3.6 ±1 %	
1800	72.0 ±1 %		41.7 ±1 %		3.6 ±1 %	
1900	68.0 ±1 %		39.5 ±1 %		3.6 ±1 %	
1950	66.3 ±1 %		38.5 ±1 %		3.6 ±1 %	
2000	64.5 ±1 %		37.5 ±1 %		3.6 ±1 %	
2100	61.0 ±1 %		35.7 ±1 %		3.6 ±1 %	
2300	55.5 ±1 %		32.6 ±1 %		3.6 ±1 %	
2450	51.5 ±1 %		30.4 ±1 %		3.6 ±1 %	



**SAR REFERENCE DIPOLE CALIBRATION REPORT**

Ref: ACR.60.3.21.MVGB.A

2600	48.5 ±1 %.		28.8 ±1 %.		3.6 ±1 %.	
3000	41.5 ±1 %.		25.0 ±1 %.		3.6 ±1 %.	
3500	37.0±1 %.		26.4 ±1 %.		3.6 ±1 %.	
3700	34.7±1 %.		26.4 ±1 %.		3.6 ±1 %.	

**7 VALIDATION MEASUREMENT**

The IEEE Std. 1528, FCC KDBs and CEI/IEC 62209 standards state that the system validation measurements must be performed using a reference dipole meeting the fore mentioned return loss and mechanical dimension requirements. The validation measurement must be performed against a liquid filled flat phantom, with the phantom constructed as outlined in the fore mentioned standards. Per the standards, the dipole shall be positioned below the bottom of the phantom, with the dipole length centered and parallel to the longest dimension of the flat phantom, with the top surface of the dipole at the described distance from the bottom surface of the phantom.

**7.1 MEASUREMENT CONDITION**

Software	OPENSAR V5
Phantom	SN 13/09 SAM68
Probe	SN 41/18 EPG0333
Liquid	Head Liquid Values: eps' : 40.6 sigma : 0.89
Distance between dipole center and liquid	15.0 mm
Area scan resolution	dx=8mm/dy=8mm
Zoon Scan Resolution	dx=8mm/dy=8mm/dz=5mm
Frequency	835835 MHz
Input power	20 dBm
Liquid Temperature	20 +/- 1 °C
Lab Temperature	20 +/- 1 °C
Lab Humidity	30-70 %

**7.2 HEAD LIQUID MEASUREMENT**

Frequency MHz	Relative permittivity (ε <sub>r</sub> )		Conductivity (σ) S/m	
	required	measured	required	measured
300	45.3 ±10 %		0.87 ±10 %	
450	43.5 ±10 %		0.87 ±10 %	
750	41.9 ±10 %		0.89 ±10 %	
835	41.5 ±10 %	40.6	0.90 ±10 %	0.89
900	41.5 ±10 %		0.97 ±10 %	
1450	40.5 ±10 %		1.20 ±10 %	
1500	40.4 ±10 %		1.23 ±10 %	
1640	40.2 ±10 %		1.31 ±10 %	
1750	40.1 ±10 %		1.37 ±10 %	
1800	40.0 ±10 %		1.40 ±10 %	
1900	40.0 ±10 %		1.40 ±10 %	
1950	40.0 ±10 %		1.40 ±10 %	
2000	40.0 ±10 %		1.40 ±10 %	