

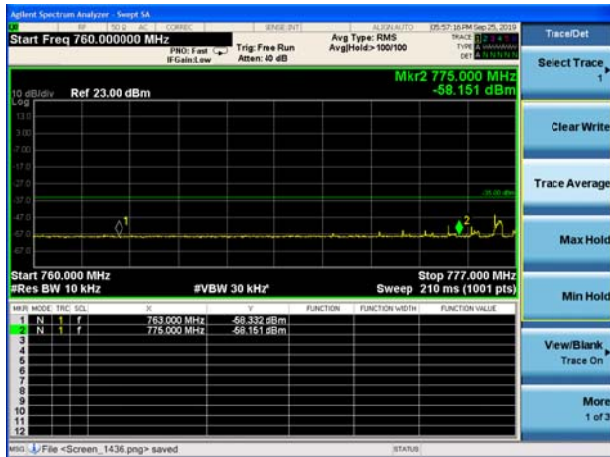

LTE Band 13 QPSK 10MHz CH-Low, 100%RB (763MHz ~775MHz)

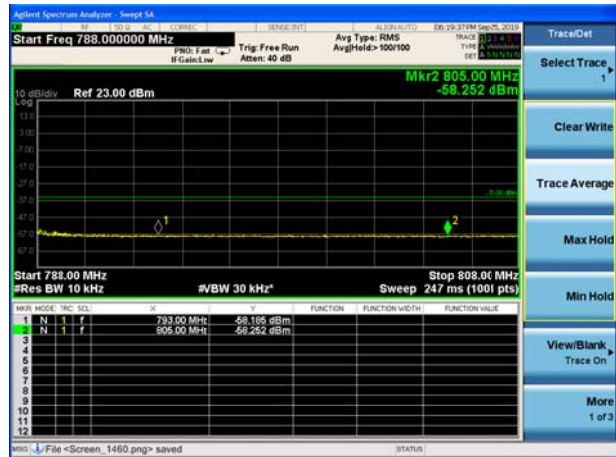

LTE Band 13 QPSK 10MHz CH-Low, 100%RB (793MHz ~805MHz)



LTE Band 13 16QAM 5MHz CH-Low, 1 RB (763MHz ~775MHz)

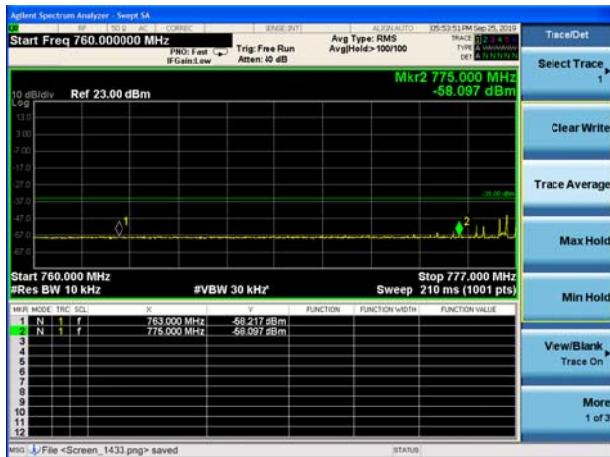

LTE Band 13 16QAM 5MHz CH-Low, 1 RB (793MHz ~805MHz)

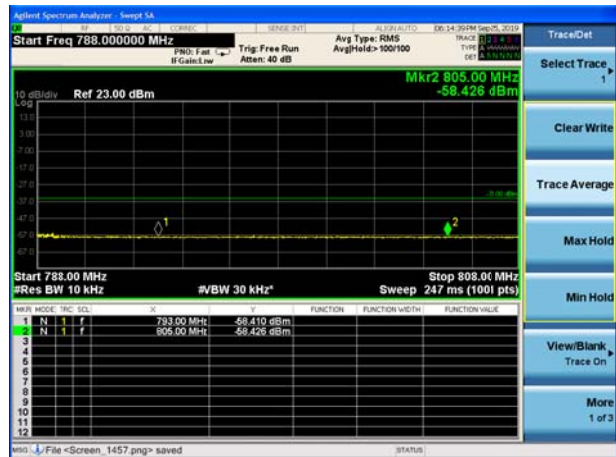

LTE Band 13 16QAM 5MHz CH-Low, 100%RB (763MHz ~775MHz)

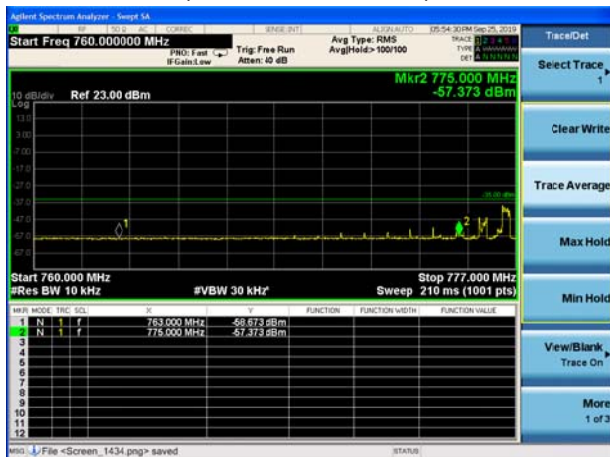

LTE Band 13 16QAM 5MHz CH-Low, 100%RB (793MHz ~805MHz)

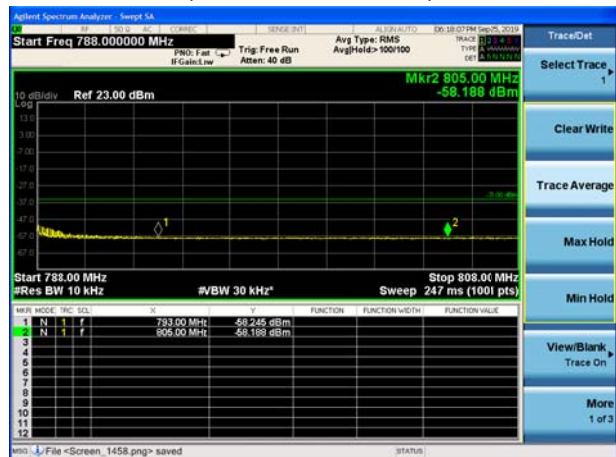



LTE Band 13 16QAM 10MHz CH-Low, 1 RB (763MHz ~775MHz)



LTE Band 13 16QAM 10MHz CH-Low, 1 RB (793MHz ~805MHz)



LTE Band 13 16QAM 10MHz CH-Low, 100%RB (763MHz ~775MHz)



LTE Band 13 16QAM 10MHz CH-Low, 100%RB (793MHz ~805MHz)





LTE Band 66 QPSK 1.4MHz CH-Low, 1 RB

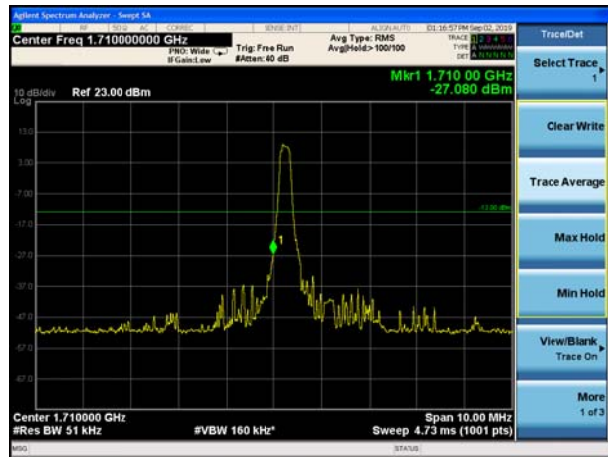

LTE Band 66 QPSK 1.4MHz CH-High, 1 RB

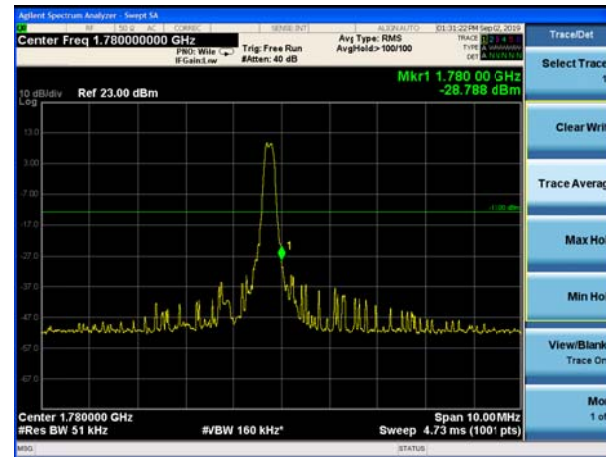

LTE Band 66 QPSK 1.4MHz CH-Low, 100%RB

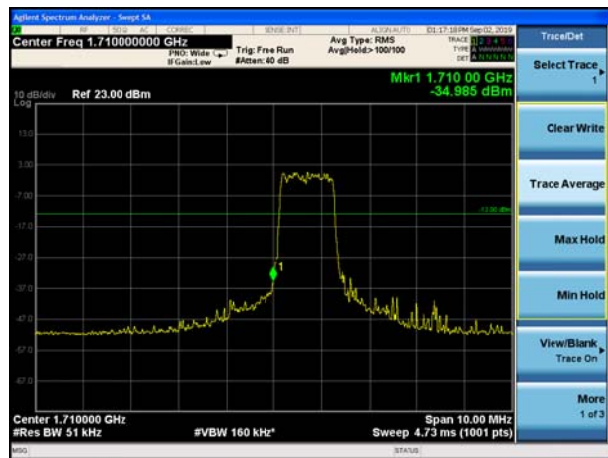

LTE Band 66 QPSK 1.4MHz CH-High, 100%RB

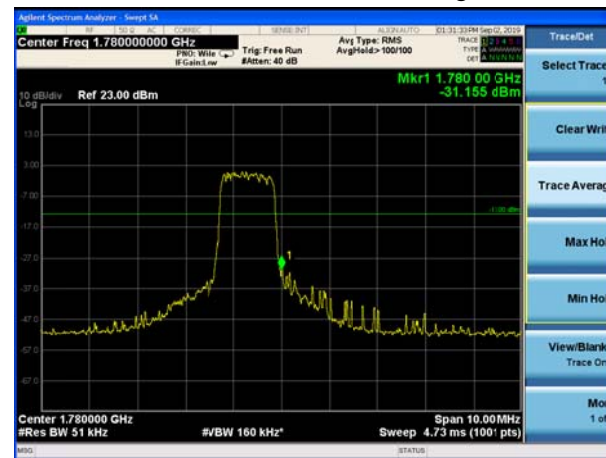

LTE Band 66 QPSK 3MHz CH-Low, 1 RB

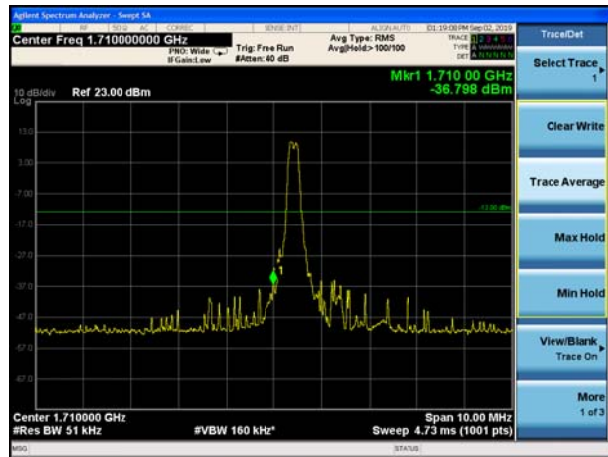

LTE Band 66 QPSK 3MHz CH-High, 1 RB

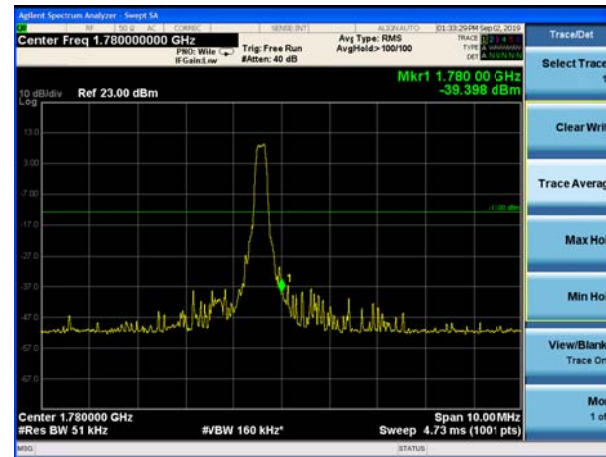



LTE Band 66 QPSK 3MHz CH-Low, 100%RB

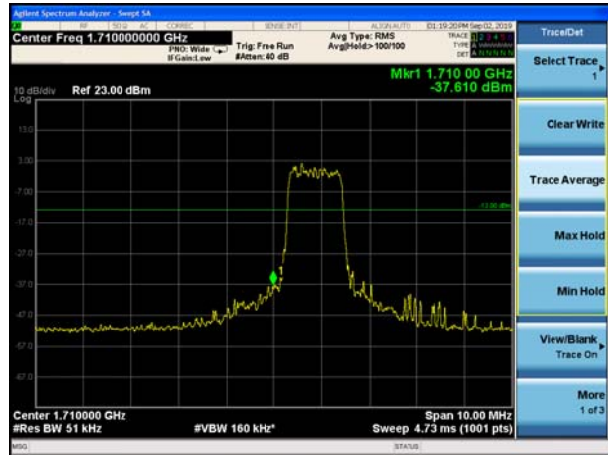

LTE Band 66 QPSK 3MHz CH-High, 100%RB

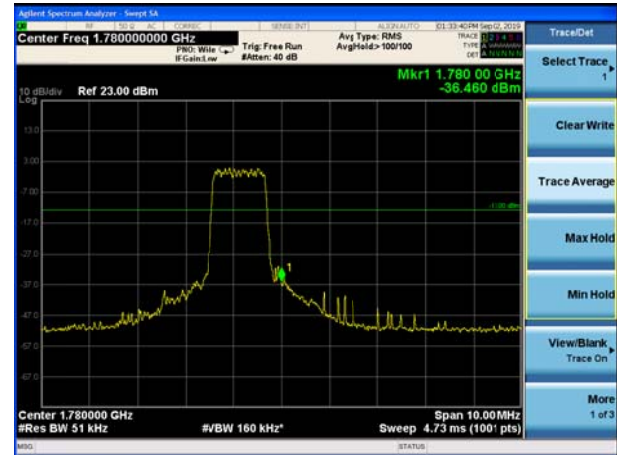

LTE Band 66 QPSK 5MHz CH-Low, 1 RB

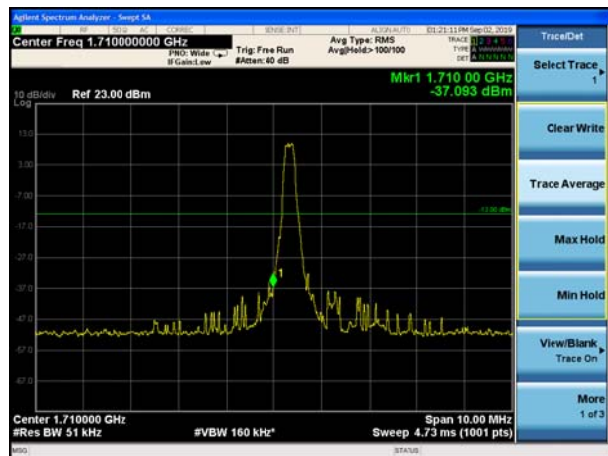

LTE Band 66 QPSK 5MHz CH-High, 1 RB

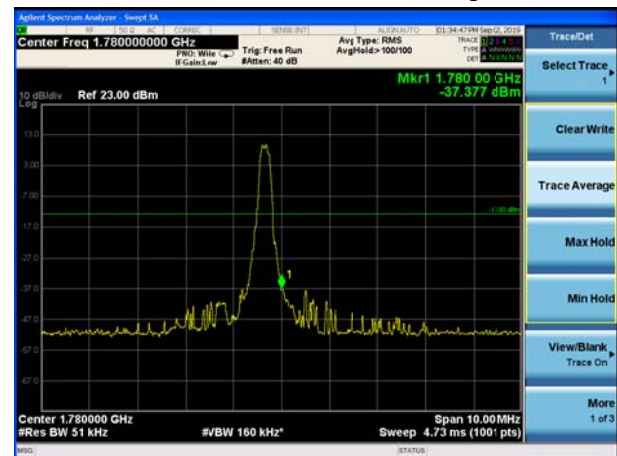

LTE Band 66 QPSK 5MHz CH-Low, 100%RB

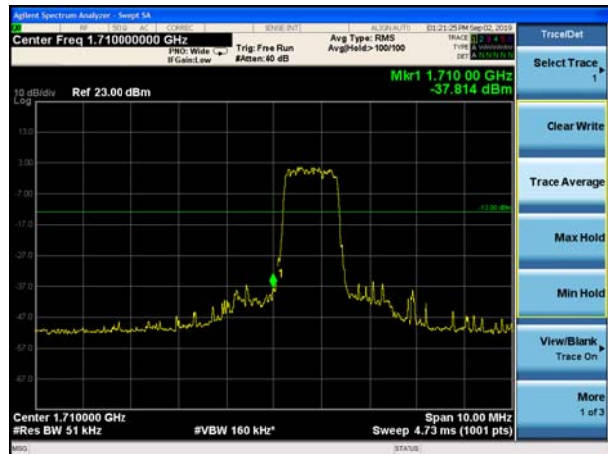

LTE Band 66 QPSK 5MHz CH-High, 100%RB

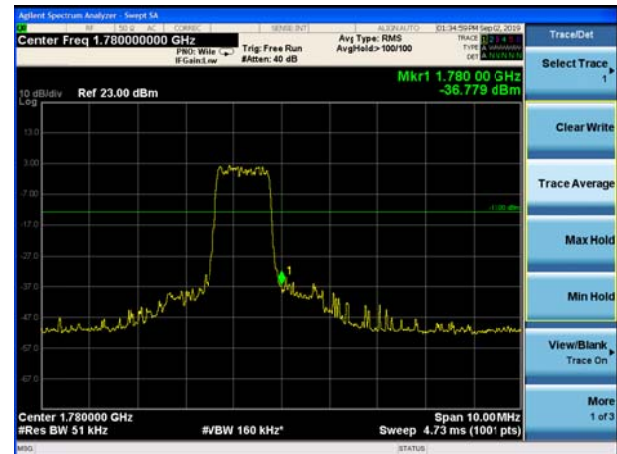



LTE Band 66 QPSK 10MHz CH-Low, 1 RB

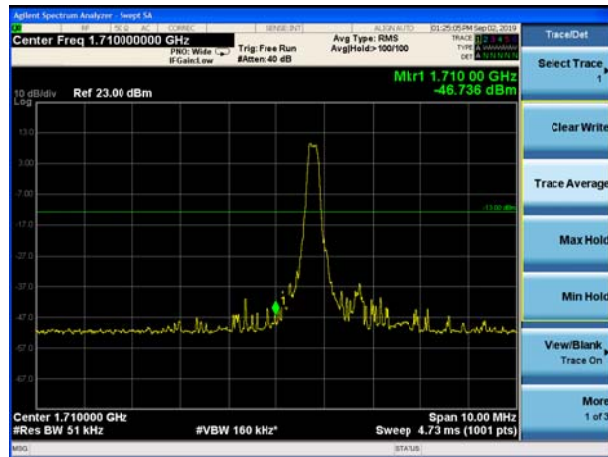

LTE Band 66 QPSK 10MHz CH-High, 1 RB

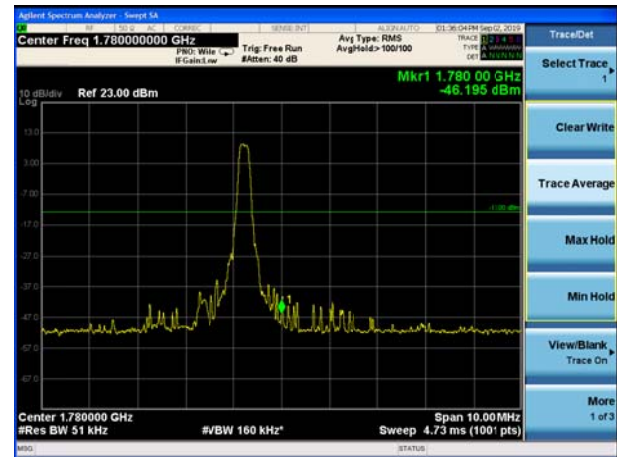

LTE Band 66 QPSK 10MHz CH-Low, 100%RB

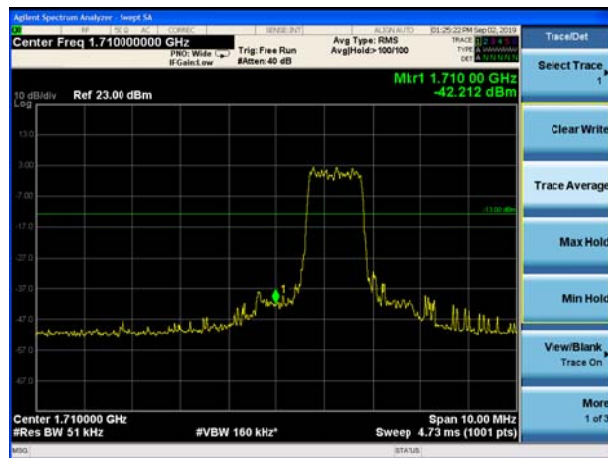

LTE Band 66 QPSK 10MHz CH-High, 100%RB

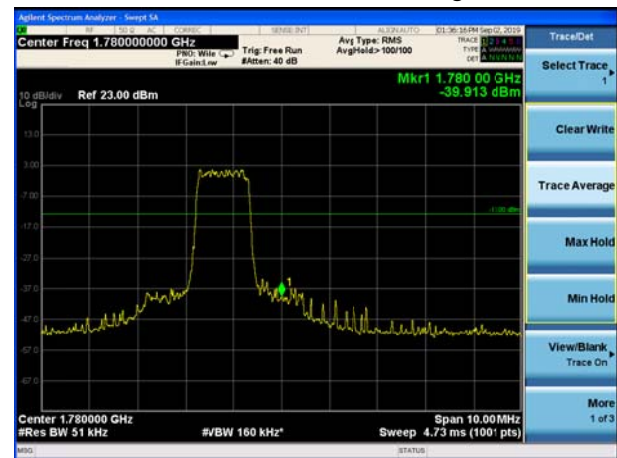

LTE Band 66 QPSK 15MHz CH-Low, 1 RB

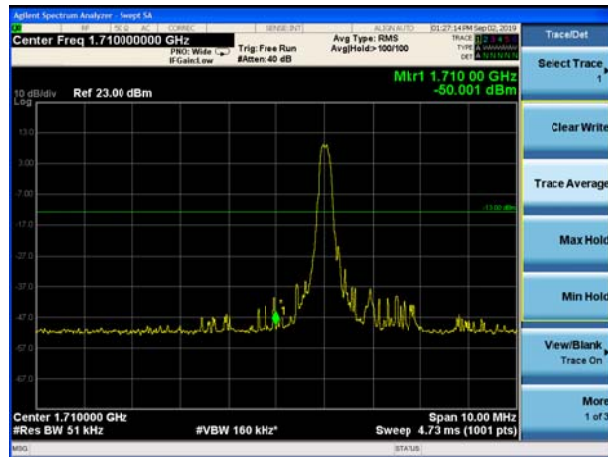

LTE Band 66 QPSK 15MHz CH-High, 1 RB



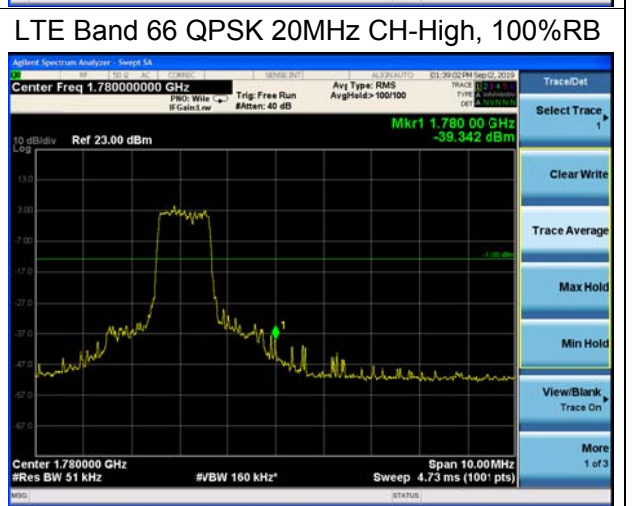
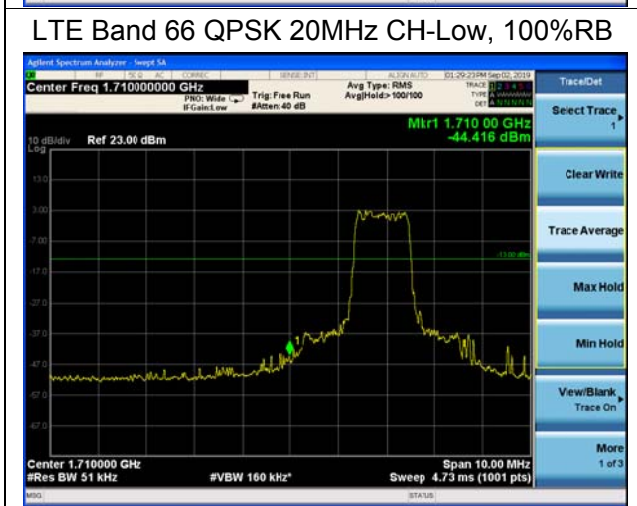
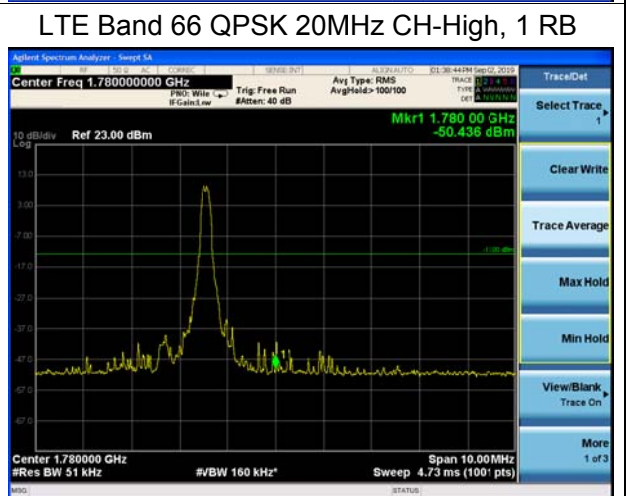
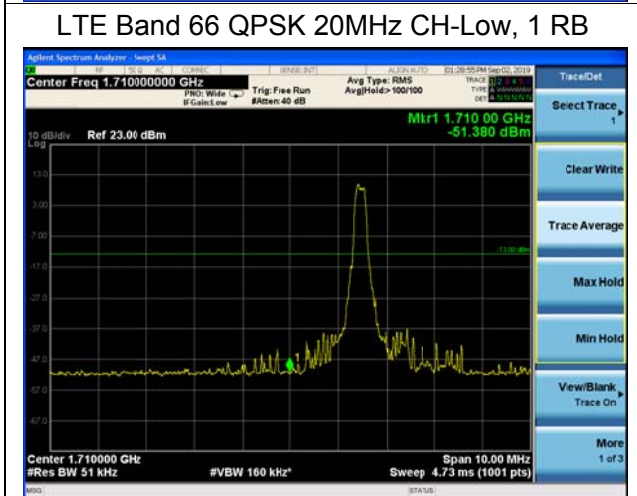
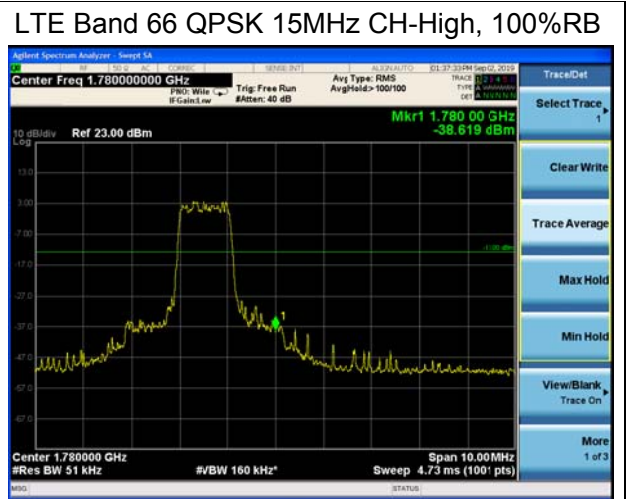
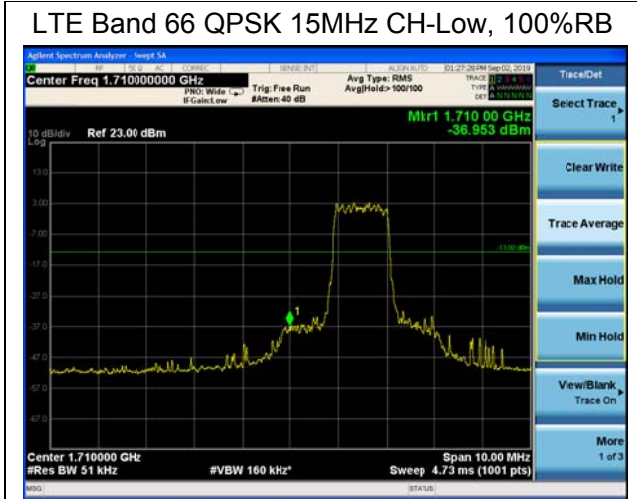



LTE Band 66 16QAM 1.4MHz CH-Low, 1 RB

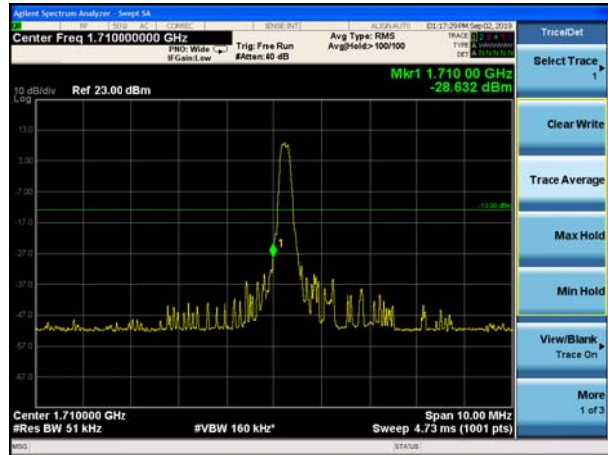

LTE Band 66 16QAM 1.4MHz CH-High, 1 RB

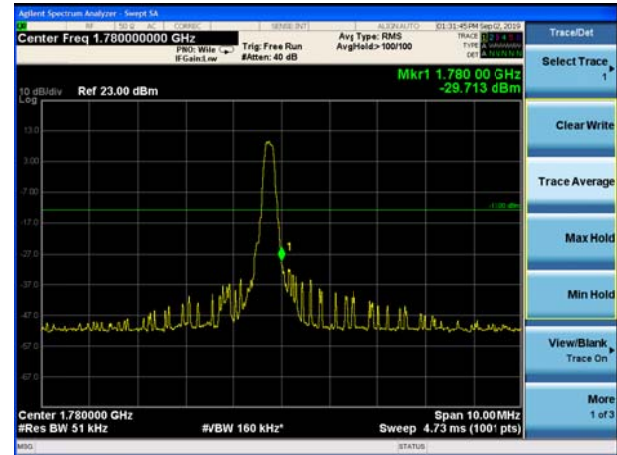

LTE Band 66 16QAM 1.4MHz CH-Low, 100%RB

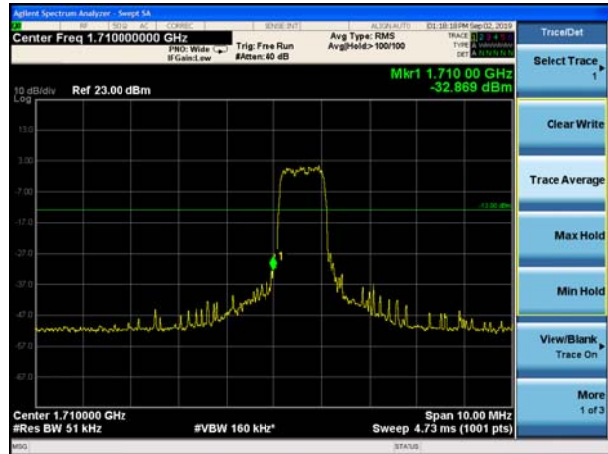

LTE Band 66 16QAM 1.4MHz CH-High, 100%

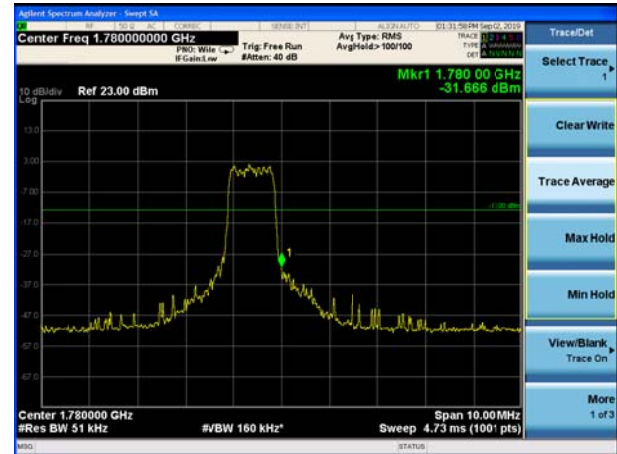

LTE Band 66 16QAM 3MHz CH-Low, 1 RB

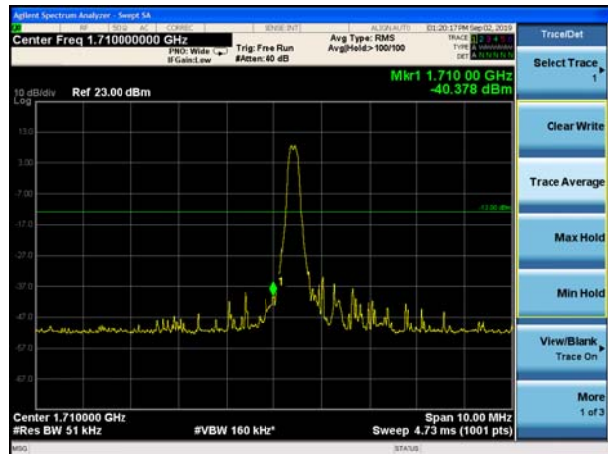

LTE Band 66 16QAM 3MHz CH-High, 1 RB

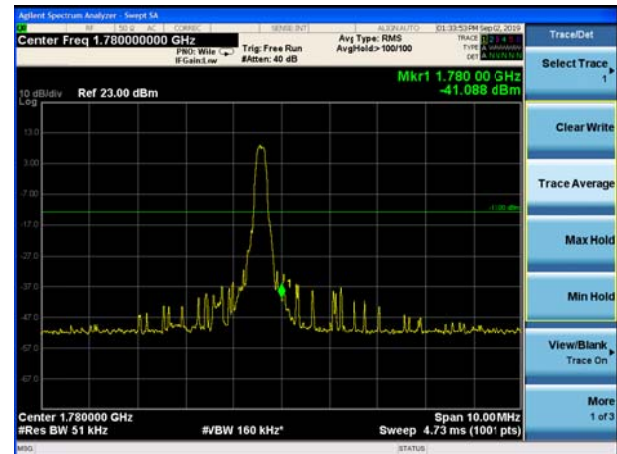



LTE Band 66 16QAM 3MHz CH-Low, 100%RB

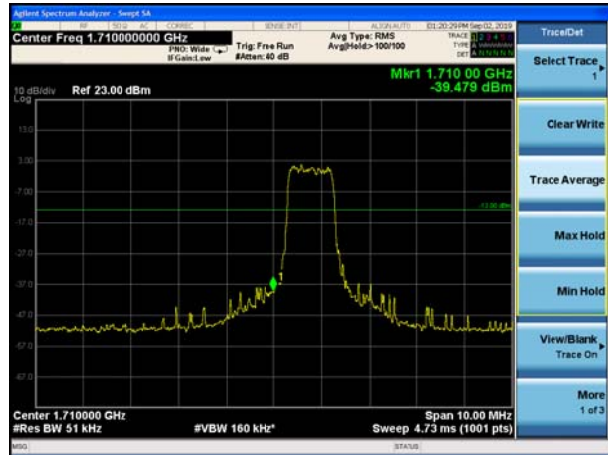

LTE Band 66 16QAM 3MHz CH-High, 100%RB

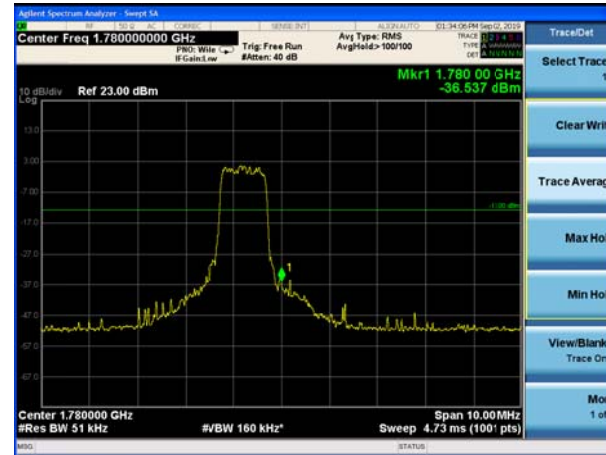

LTE Band 66 16QAM 5MHz CH-Low, 1 RB

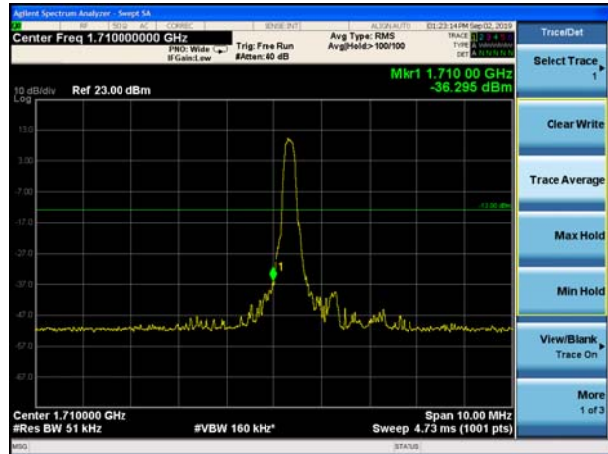

LTE Band 66 16QAM 5MHz CH-High, 1 RB

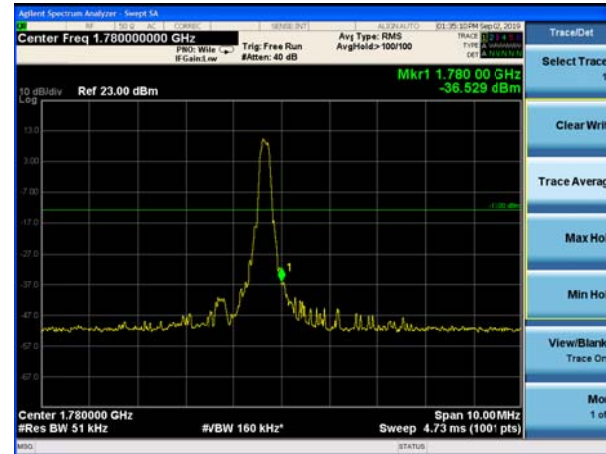

LTE Band 66 16QAM 5MHz CH-Low, 100%RB

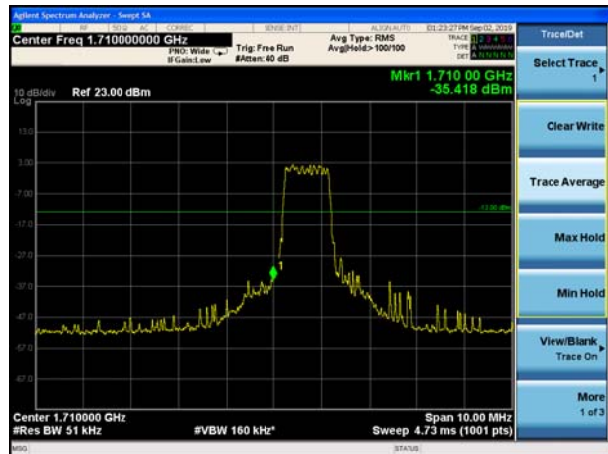

LTE Band 66 16QAM 5MHz CH-High, 100%RB

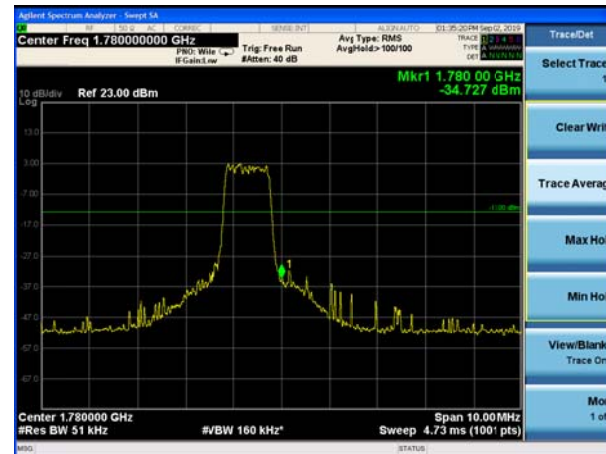



LTE Band 66 16QAM 10MHz CH-Low, 1 RB

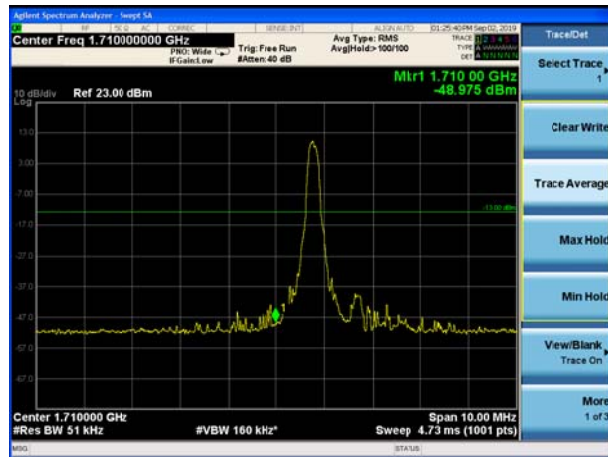

LTE Band 66 16QAM 10MHz CH-High, 1 RB

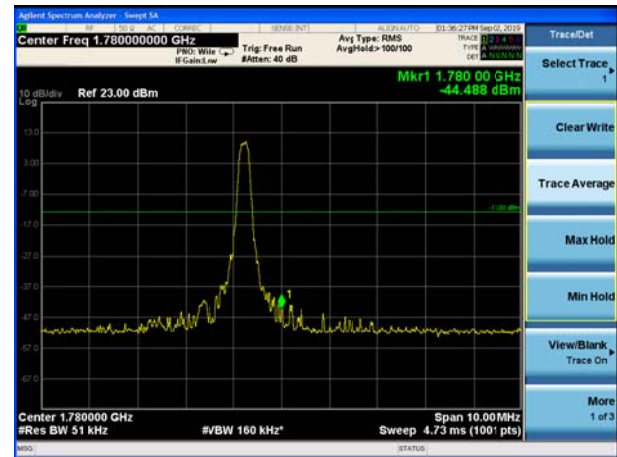

LTE Band 66 16QAM 10MHz CH-Low, 100%RB



LTE Band 66 16QAM 10MHz CH-High, 100%RB

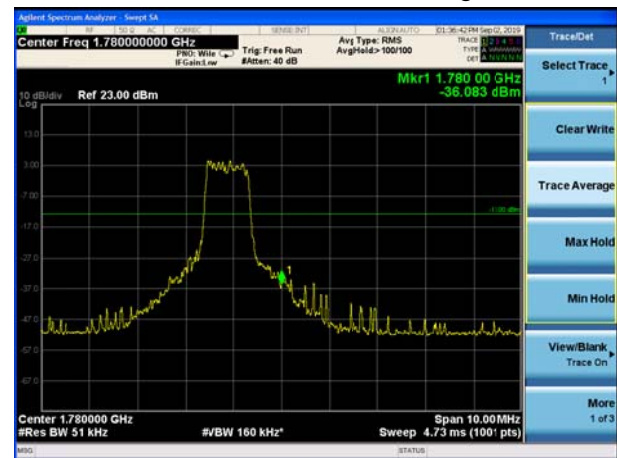

LTE Band 66 16QAM 15MHz CH-Low, 1 RB

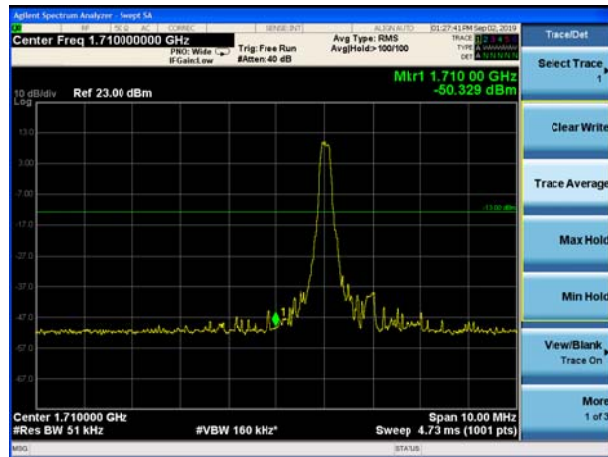

LTE Band 66 16QAM 15MHz CH-High, 1 RB

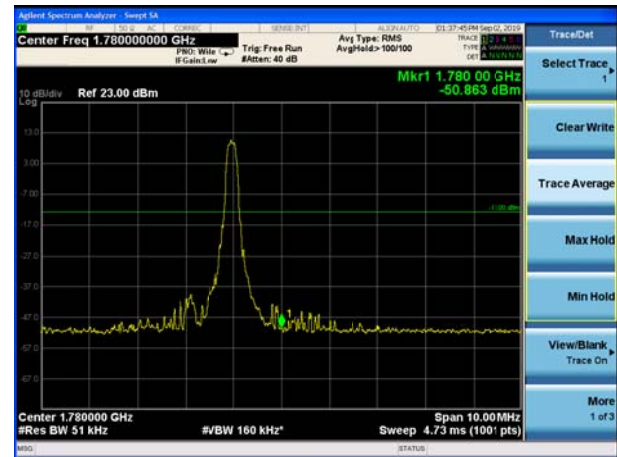



LTE Band 66 16QAM 15MHz CH-Low, 100%RB

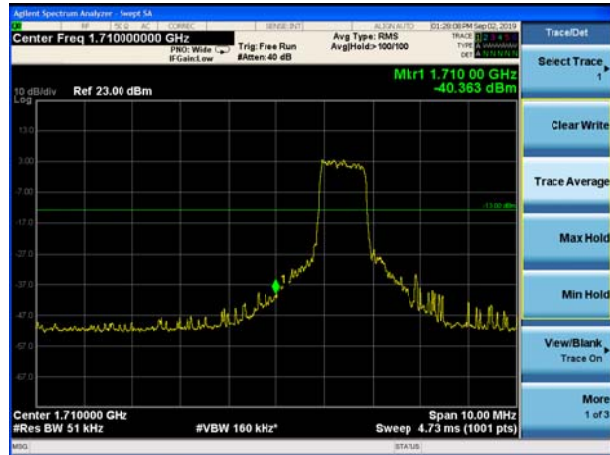

LTE Band 66 16QAM 15MHz CH-High, 100%RB

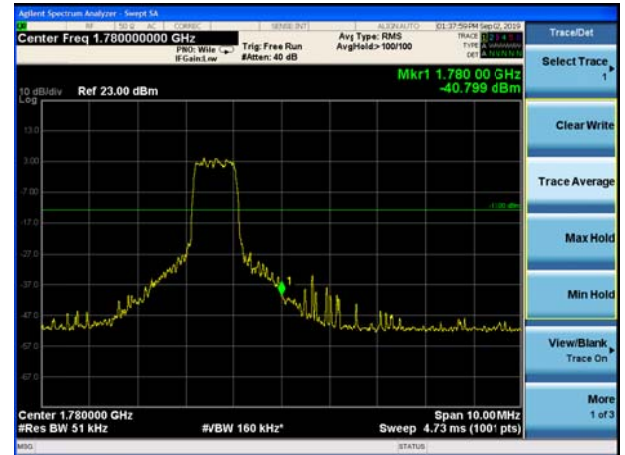

LTE Band 66 16QAM 20MHz CH-Low, 1 RB

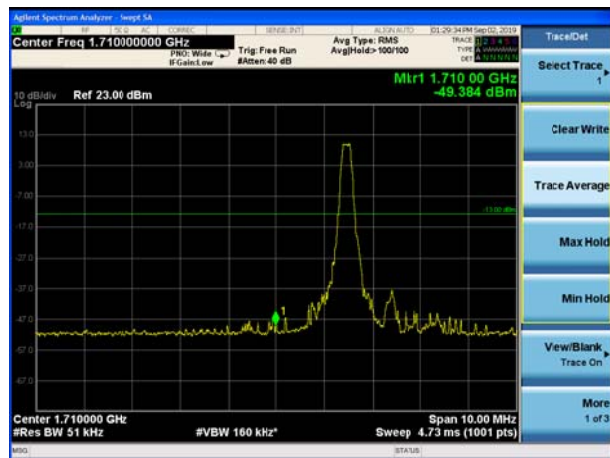

LTE Band 66 16QAM 20MHz CH-High, 1 RB

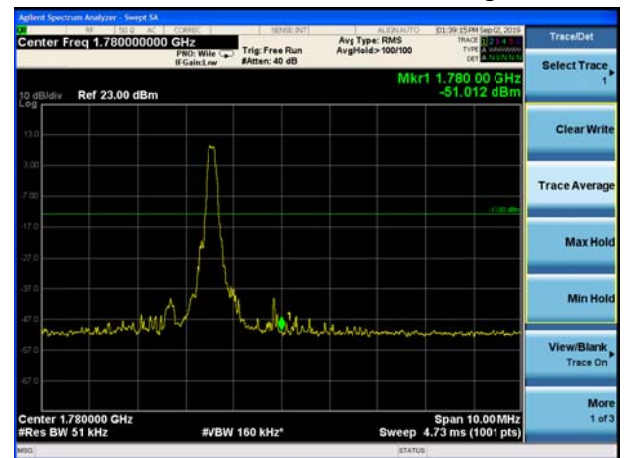

LTE Band 66 16QAM 20MHz CH-Low, 100%RB

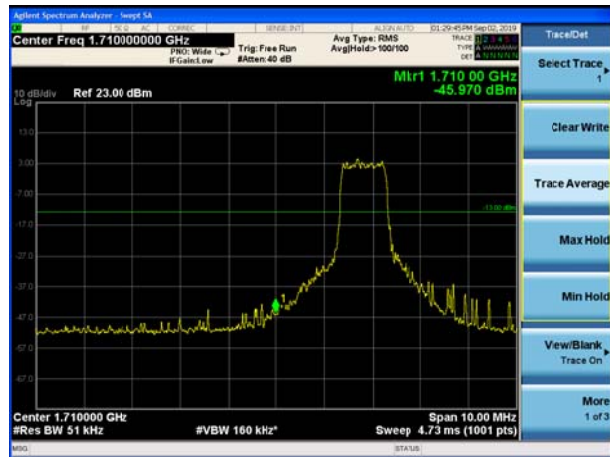

LTE Band 66 16QAM 20MHz CH-High, 100%RB





LTE Band 85 QPSK 5MHz CH-Low, 1 RB

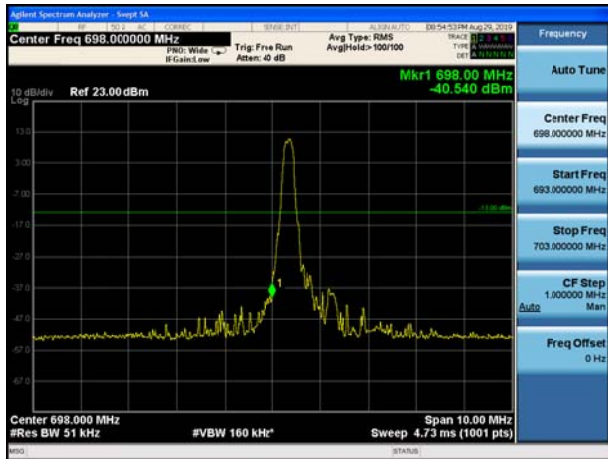

LTE Band 85 QPSK 5MHz CH-High, 1 RB

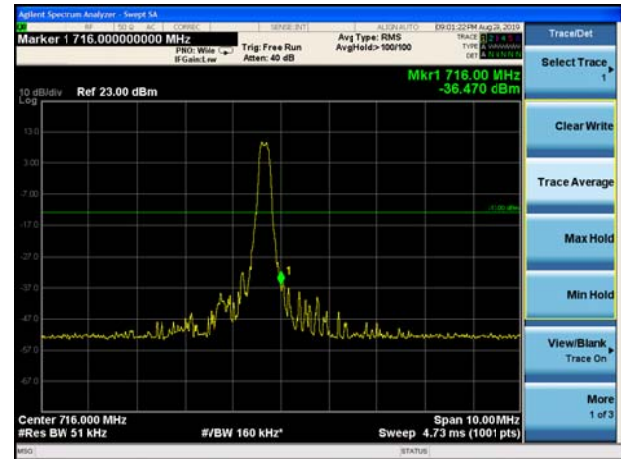

LTE Band 85 QPSK 5MHz CH-Low, 100%RB

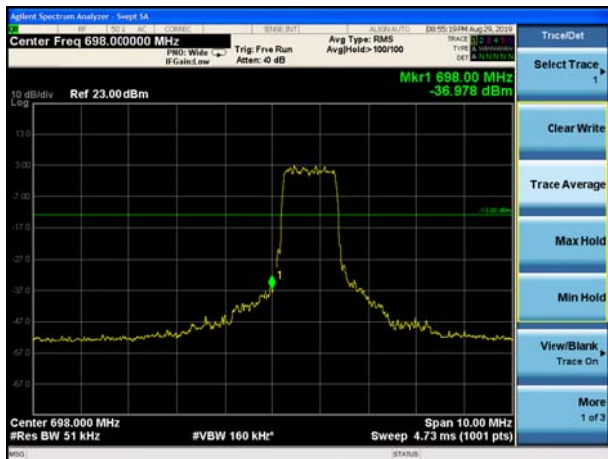

LTE Band 85 QPSK 5MHz CH-High, 100%RB

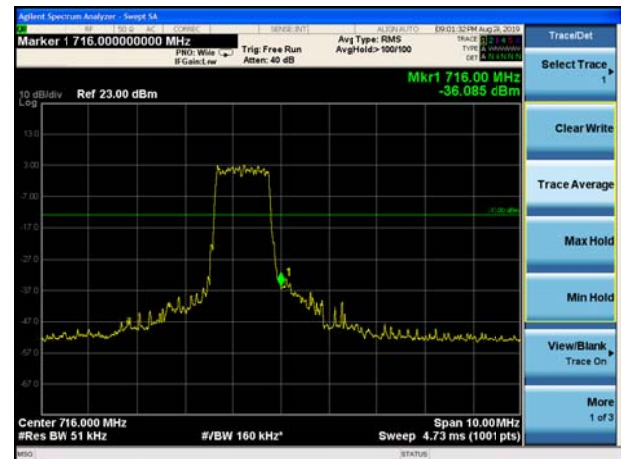

LTE Band 85 QPSK 10MHz CH-Low, 1 RB

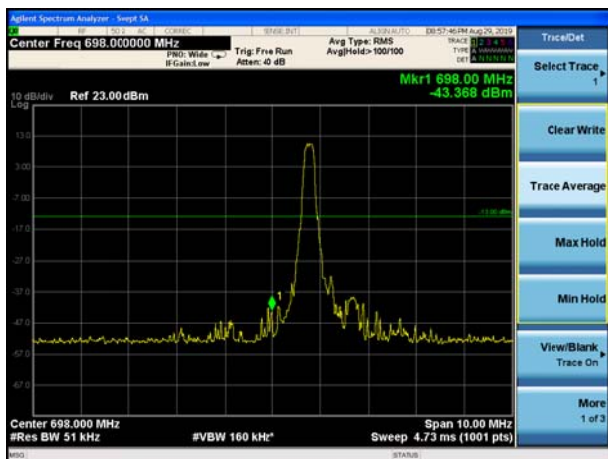

LTE Band 85 QPSK 10MHz CH-High, 1 RB

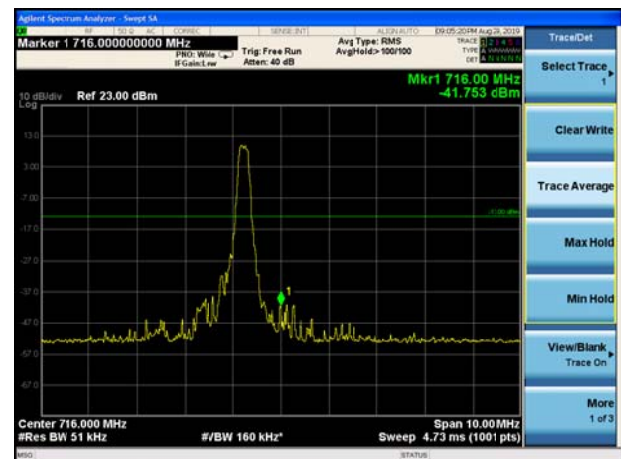



LTE Band 85 QPSK 10MHz CH-Low, 100%RB



LTE Band 85 QPSK 10MHz CH-High, 100%RB

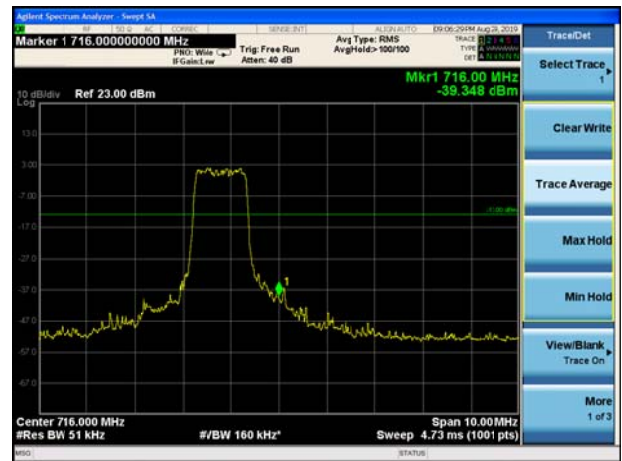

LTE Band 85 16QAM 5MHz CH-Low, 1 RB

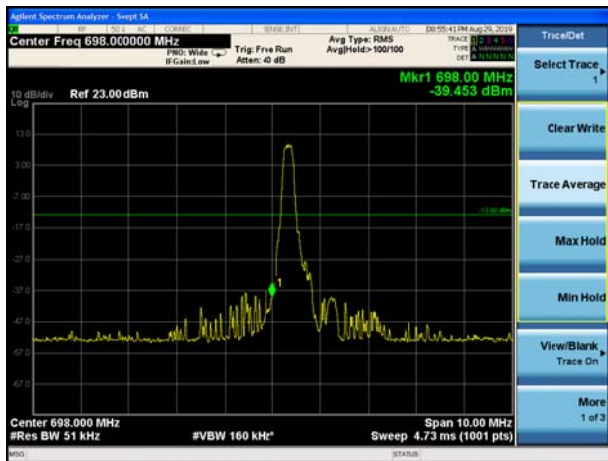

LTE Band 85 16QAM 5MHz CH-High, 1 RB

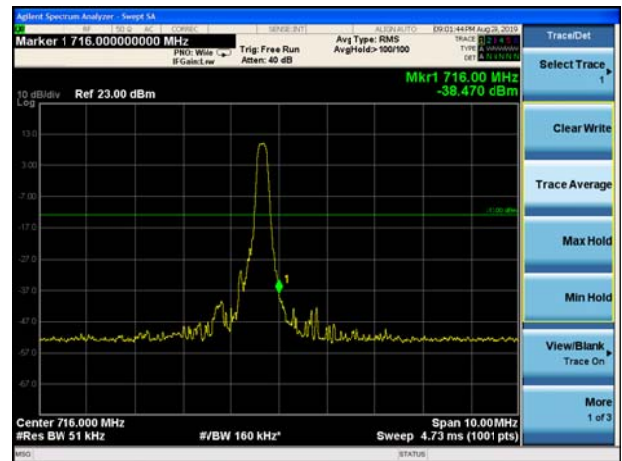

LTE Band 85 16QAM 5MHz CH-Low, 100%RB

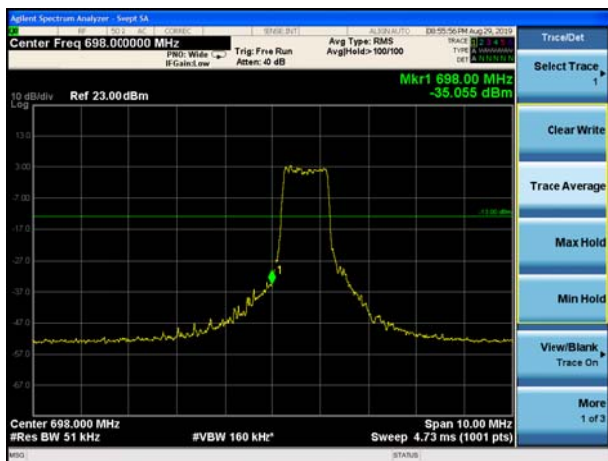

LTE Band 85 16QAM 5MHz CH-High, 100%RB

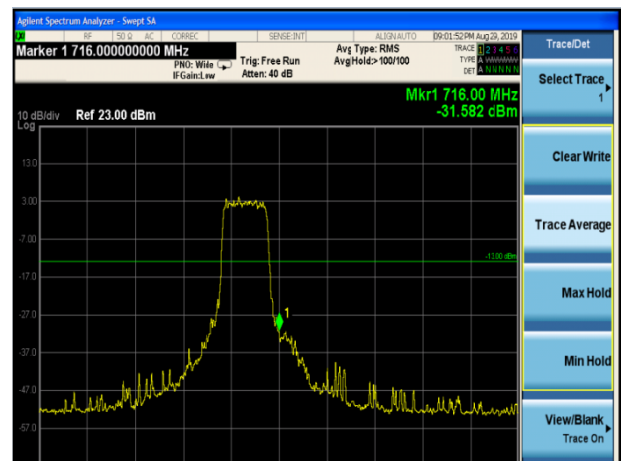



LTE Band 85 16QAM 10MHz CH-Low, 1 RB

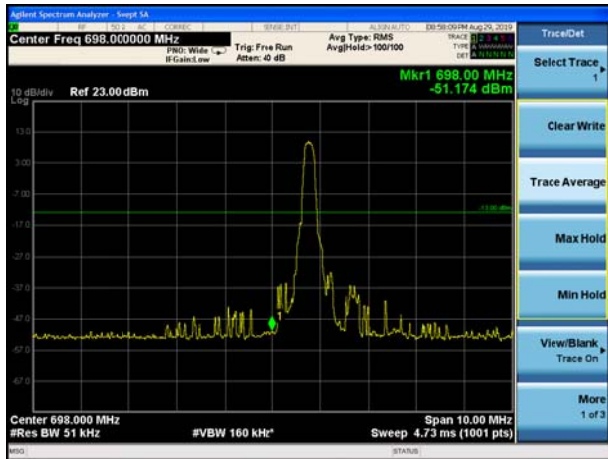

LTE Band 85 16QAM 10MHz CH-High, 1 RB

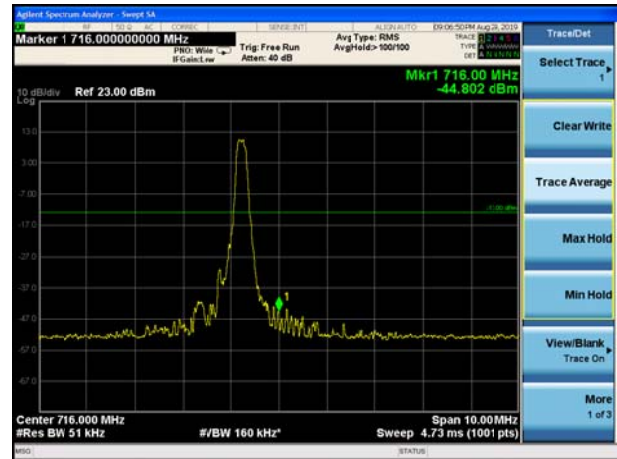

LTE Band 85 16QAM 10MHz CH-Low, 100%RB

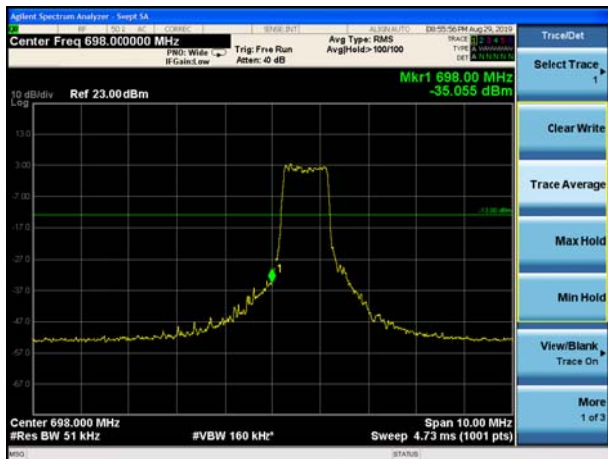

LTE Band 85 16QAM 10MHz CH-High, 100%RB

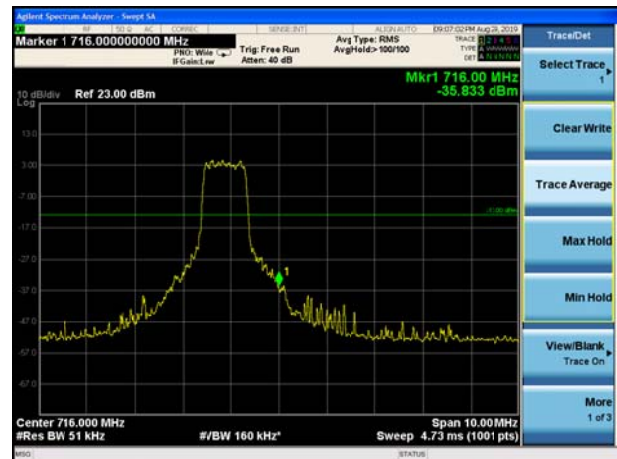

5.5 Peak-to-Average Power Ratio (PAPR)

Ambient condition

Temperature	Relative humidity	Pressure
23°C ~25°C	45%~50%	101.5kPa

Methods of Measurement

Measure the total peak power and record as Ppk. And measure the total average power and record as PAvg. Both the peak and average power levels must be expressed in the same logarithmic units (e.g., dBm). Determine the PAPR from:

$$PAPR (dB) = Ppk (dBm) - PAvg (dBm).$$

Test Setup

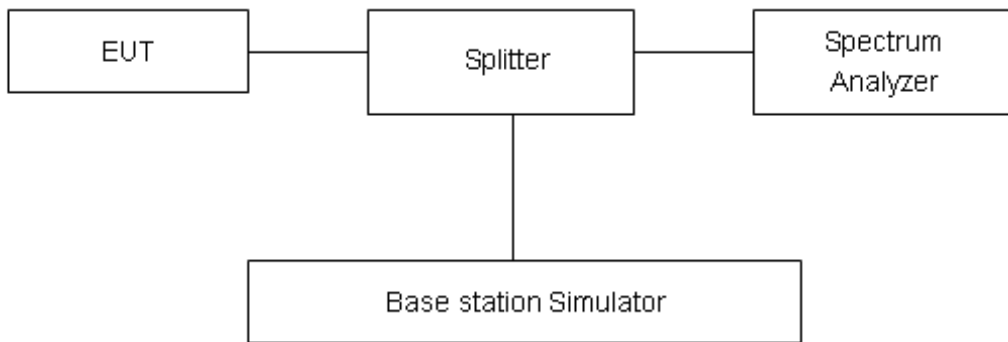

Limits

Rule Part 27.50(d)(5) Equipment employed must be authorized in accordance with the provisions of 24.51. Power measurements for transmissions by stations authorized under this section may be made either in accordance with a Commission-approved average power technique or in compliance with paragraph (d)(6) of this section. In measuring transmissions in this band using an average power technique, the peak-to-average ratio (PAR) of the transmission may not exceed 13 dB.

Measurement Uncertainty

The assessed measurement uncertainty to ensure 95% confidence level for the normal distribution is with the coverage factor $k = 2$, $U = 0.4$ dB.



Test Results

Mode	Bandwidth	Modulation	Channel/ Frequency(MHz)	Peak-to-Average Power Ratio (PAPR)		
				Peak(dBm)	Avg(dBm)	PAPR(dB)
LTE Band4	1.4MHz	QPSK	20175/1732.5	23.22	13.32	9.90
		16QAM	20175/1732.5	23.47	12.67	10.80
	3MHz	QPSK	20175/1732.5	22.80	12.53	10.27
		16QAM	20175/1732.5	23.43	13.07	10.36
	5MHz	QPSK	20175/1732.5	23.48	14.13	9.35
		16QAM	20175/1732.5	24.03	13.91	10.12
	10MHz	QPSK	20175/1732.5	23.46	13.97	9.49
		16QAM	20175/1732.5	24.56	15.80	8.76
	15MHz	QPSK	20175/1732.5	24.22	14.44	9.78
		16QAM	20175/1732.5	24.68	14.70	9.98
20MHz	QPSK	20175/1732.5	24.24	15.38	8.86	
	16QAM	20175/1732.5	24.66	14.76	9.90	

Mode	Bandwidth	Modulation	Channel/ Frequency(MHz)	Peak-to-Average Power Ratio (PAPR)		
				Peak(dBm)	Avg(dBm)	PAPR(dB)
LTE Band12	1.4MHz	QPSK	23095/707.5	25.21	15.65	9.56
		16QAM	23095/707.5	25.62	15.96	9.66
	3MHz	QPSK	23095/707.5	24.77	13.41	11.36
		16QAM	23095/707.5	25.52	13.97	11.55
	5MHz	QPSK	23095/707.5	25.71	17.64	8.07
		16QAM	23095/707.5	26.02	17.84	8.18
	10MHz	QPSK	23095/707.5	25.56	16.28	9.28
		16QAM	23095/707.5	26.07	17.73	8.34

Mode	Bandwidth	Modulation	Channel/ Frequency(MHz)	Peak-to-Average Power Ratio (PAPR)		
				Peak(dBm)	Avg(dBm)	PAPR(dB)
LTE Band13	5MHz	QPSK	23230/782	24.95	15.84	9.11
		16QAM	23230/782	25.48	16.28	9.20
	10MHz	QPSK	23230/782	24.68	15.70	8.98
		16QAM	23230/782	25.47	15.90	9.57



Mode	Bandwidth	Modulation	Channel/ Frequency(MHz)	Peak-to-Average Power Ratio (PAPR)		
				Peak(dBm)	Avg(dBm)	PAPR(dB)
LTE Ban66	1.4MHz	QPSK	132322/1745	23.17	13.49	9.68
		16QAM	132322/1745	23.69	12.90	10.79
	3MHz	QPSK	132322/1745	22.91	12.01	10.90
		16QAM	132322/1745	23.79	12.34	11.45
	5MHz	QPSK	132322/1745	23.79	14.45	9.34
		16QAM	132322/1745	24.31	14.55	9.76
	10MHz	QPSK	132322/1745	23.68	13.97	9.71
		16QAM	132322/1745	24.74	15.53	9.21
	15MHz	QPSK	132322/1745	24.31	15.20	9.11
		16QAM	132322/1745	24.76	15.00	9.76
	20MHz	QPSK	132322/1745	24.29	15.57	8.72
		16QAM	132322/1745	24.69	14.92	9.77

Mode	Bandwidth	Modulation	Channel/ Frequency(MHz)	Peak-to-Average Power Ratio (PAPR)		
				Peak(dBm)	Avg(dBm)	PAPR(dB)
LTE Band85	5MHz	QPSK	134092/707	24.06	14.07	9.99
		16QAM	134092/707	24.68	14.89	9.79
	10MHz	QPSK	134092/707	24.02	14.72	9.30
		16QAM	134092/707	25.11	15.61	9.50

5.6 Frequency Stability

Ambient condition

Temperature	Relative humidity	Pressure
23°C ~25°C	45%~50%	101.5kPa

Method of Measurement

Frequency Stability (Temperature Variation)

The temperature inside the climate chamber is varied from -40°C to +85°C in 10°C step size.

(1) With all power removed, the temperature was decreased to -10°C and permitted to stabilize for three hours.

(2) Measure the carrier frequency with the test equipment in a “call mode”. These measurements should be made within 1 minute of powering up the mobile station, to prevent significant self warming.

(3) Repeat the above measurements at 10°C increments from -40°C to +85°C. Allow at least 1.5 hours at each temperature, un-powered, before making measurements.

Frequency Stability (Voltage Variation)

The frequency stability shall be measured with variation of primary supply voltage as follows:

(1) Vary primary supply voltage from 85 to 115 percent of the nominal value for other than hand carried battery equipment.

(2) For hand carried, battery powered equipment, reduce primary supply voltage to the battery-operating end point which shall be specified by the manufacturer.

This transceiver is specified to operate with an input voltage of between 3.3 V and 4.3V, with a nominal voltage of 3.8V.

Test setup

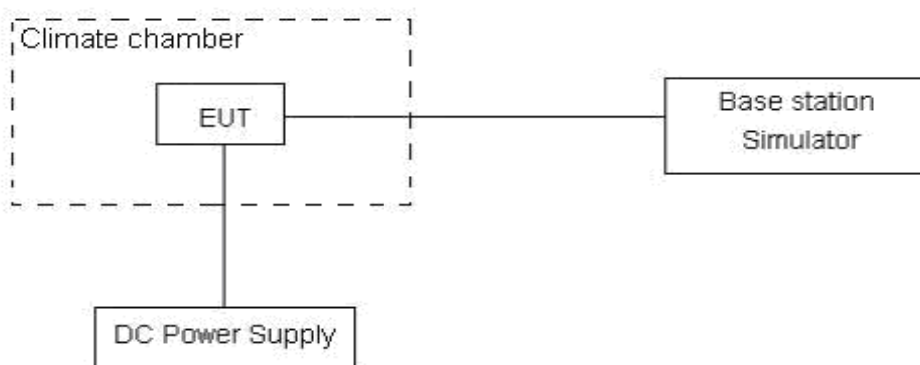

Limits

The frequency stability shall be sufficient to ensure that the fundamental emissions stay within the authorized bands of operation.

Measurement Uncertainty

The assessed measurement uncertainty to ensure 99.75% confidence level for the normal distribution is with the coverage factor $k = 3, U = 0.01\text{ppm}$.



Test Result

LTE Band 4						
Condition		Freq.Error (Hz)	Freq.Error (Hz)	Frequency Stability (ppm)	Frequency Stability (ppm)	Verdict
BANDWIDTH	20MHz					
Temperature	Voltage	16QAM	QPSK	16QAM	QPSK	
Normal (25°C)	Normal	3.90	13.54	0.00208	0.00720	PASS
Extreme (85°C)		14.71	15.79	0.00782	0.00840	PASS
Extreme (80°C)		16.56	3.95	0.00881	0.00210	PASS
Extreme (70°C)		4.47	12.80	0.00238	0.00681	PASS
Extreme (60°C)		16.41	6.69	0.00873	0.00356	PASS
Extreme (50°C)		7.32	7.93	0.00389	0.00422	PASS
Extreme (40°C)		12.49	16.52	0.00664	0.00878	PASS
Extreme (30°C)		7.28	10.17	0.00387	0.00541	PASS
Extreme (20°C)		11.06	15.25	0.00588	0.00811	PASS
Extreme (10°C)		9.23	2.16	0.00491	0.00115	PASS
Extreme (0°C)		8.59	8.78	0.00457	0.00467	PASS
Extreme (-10°C)		8.39	1.68	0.00446	0.00089	PASS
Extreme (-20°C)		12.58	1.30	0.00669	0.00069	PASS
Extreme (-30°C)		16.51	10.71	0.00878	0.00570	PASS
Extreme (-40°C)		3.82	17.50	0.00203	0.00931	PASS
25°C	LV	11.81	11.04	0.00628	0.00587	PASS
	HV	11.62	17.54	0.00618	0.00933	PASS

LTE Band 12						
Condition		Freq.Error (Hz)	Freq.Error (Hz)	Frequency Stability (ppm)	Frequency Stability (ppm)	Verdict
BANDWIDTH	10MHz					
Temperature	Voltage	16QAM	QPSK	16QAM	QPSK	
Normal (25°C)	Normal	12.53	3.48	0.00666	0.00185	PASS
Extreme (85°C)		15.97	14.78	0.00850	0.00786	PASS
Extreme (80°C)		11.46	14.56	0.00610	0.00775	PASS
Extreme (70°C)		8.85	12.25	0.00471	0.00651	PASS
Extreme (60°C)		3.72	4.83	0.00198	0.00257	PASS
Extreme (50°C)		10.61	11.45	0.00564	0.00609	PASS
Extreme (40°C)		12.43	17.60	0.00661	0.00936	PASS
Extreme (30°C)		17.92	13.78	0.00953	0.00733	PASS
Extreme (20°C)		9.49	17.11	0.00505	0.00910	PASS
Extreme (10°C)		16.01	14.10	0.00851	0.00750	PASS
Extreme (0°C)		5.81	17.62	0.00309	0.00937	PASS
Extreme (-10°C)		11.24	5.08	0.00598	0.00270	PASS



Extreme (-20°C)		5.65	14.52	0.00300	0.00772	PASS
Extreme (-30°C)		13.44	1.57	0.00715	0.00083	PASS
Extreme (-40°C)		7.68	12.06	0.00409	0.00641	PASS
25°C	LV	7.56	11.96	0.00402	0.00636	PASS
	HV	13.32	10.72	0.00708	0.00570	PASS

LTE Band 13						
Condition		Freq.Error (Hz)	Freq.Error (Hz)	Frequency Stability (ppm)	Frequency Stability (ppm)	Verdict
BANDWIDTH	10MHz					
Temperature	Voltage	16QAM	QPSK	16QAM	QPSK	
Normal (25°C)	Normal	9.59	10.61	0.00510	0.00564	PASS
Extreme (85°C)		15.19	9.19	0.00808	0.00489	PASS
Extreme (80°C)		14.51	15.91	0.00772	0.00846	PASS
Extreme (70°C)		2.05	15.82	0.00109	0.00842	PASS
Extreme (60°C)		7.80	1.21	0.00415	0.00064	PASS
Extreme (50°C)		15.19	1.88	0.00808	0.00100	PASS
Extreme (40°C)		9.17	5.92	0.00488	0.00315	PASS
Extreme (30°C)		16.67	2.13	0.00887	0.00113	PASS
Extreme (20°C)		5.98	9.38	0.00318	0.00499	PASS
Extreme (10°C)		9.85	4.71	0.00524	0.00251	PASS
Extreme (0°C)		16.17	6.49	0.00860	0.00345	PASS
Extreme (-10°C)		13.07	11.84	0.00695	0.00630	PASS
Extreme (-20°C)		8.10	4.05	0.00431	0.00215	PASS
Extreme (-30°C)		7.22	5.82	0.00384	0.00310	PASS
Extreme (-40°C)		2.55	9.06	0.00136	0.00482	PASS
25°C	LV	9.26	15.99	0.00492	0.00851	PASS
	HV	16.68	4.48	0.00887	0.00238	PASS

LTE Band 66						
Condition		Freq.Error (Hz)	Freq.Error (Hz)	Frequency Stability (ppm)	Frequency Stability (ppm)	Verdict
BANDWIDTH	20MHz					
Temperature	Voltage	16QAM	QPSK	16QAM	QPSK	
Normal (25°C)	Normal	8.81	15.15	0.00468	0.00806	PASS
Extreme (85°C)		11.40	10.69	0.00606	0.00568	PASS
Extreme (80°C)		6.99	12.72	0.00372	0.00677	PASS
Extreme (70°C)		13.80	2.04	0.00734	0.00108	PASS
Extreme (60°C)		17.20	12.07	0.00915	0.00642	PASS
Extreme (50°C)		2.48	7.22	0.00132	0.00384	PASS



Extreme (40°C)		11.24	13.31	0.00598	0.00708	PASS
Extreme (30°C)		2.20	11.13	0.00117	0.00592	PASS
Extreme (20°C)		16.10	2.50	0.00857	0.00133	PASS
Extreme (10°C)		11.67	14.50	0.00621	0.00771	PASS
Extreme (0°C)		5.12	7.92	0.00273	0.00421	PASS
Extreme (-10°C)		7.88	15.75	0.00419	0.00838	PASS
Extreme (-20°C)		6.76	7.56	0.00359	0.00402	PASS
Extreme (-30°C)		10.89	17.33	0.00579	0.00922	PASS
Extreme (-40°C)		7.35	1.39	0.00391	0.00074	PASS
25°C		LV	8.35	14.29	0.00444	0.00760
	HV	8.54	8.14	0.00455	0.00433	PASS

LTE Band 85						
Condition		Freq.Error (Hz)	Freq.Error (Hz)	Frequency Stability (ppm)	Frequency Stability (ppm)	Verdict
BANDWIDTH	10MHz	16QAM	QPSK	16QAM	QPSK	
Temperature	Voltage					
Normal (25°C)	Normal	6.96	13.47	0.00370	0.00716	PASS
Extreme (85°C)		3.82	6.71	0.00203	0.00357	PASS
Extreme (80°C)		1.72	16.56	0.00091	0.00881	PASS
Extreme (70°C)		5.37	14.33	0.00285	0.00762	PASS
Extreme (60°C)		8.12	8.69	0.00432	0.00462	PASS
Extreme (50°C)		13.03	6.05	0.00693	0.00322	PASS
Extreme (40°C)		17.13	6.46	0.00911	0.00344	PASS
Extreme (30°C)		9.52	16.08	0.00506	0.00855	PASS
Extreme (20°C)		5.36	6.23	0.00285	0.00331	PASS
Extreme (10°C)		9.51	11.62	0.00506	0.00618	PASS
Extreme (0°C)		13.57	9.79	0.00722	0.00520	PASS
Extreme (-10°C)		13.20	11.04	0.00702	0.00587	PASS
Extreme (-20°C)		3.14	5.92	0.00167	0.00315	PASS
Extreme (-30°C)		10.57	8.73	0.00562	0.00464	PASS
Extreme (-40°C)		14.43	13.99	0.00768	0.00744	PASS
25°C	LV	6.80	9.82	0.00362	0.00522	PASS
	HV	10.54	13.13	0.00561	0.00699	PASS

5.7 Spurious Emissions at Antenna Terminals

Ambient condition

Temperature	Relative humidity	Pressure
23°C ~25°C	45%~50%	101.5kPa

Method of Measurement

The EUT was connected to Spectrum Analyzer and Base Station Simulator via power Splitter. The measurement is carried out using a spectrum analyzer. The spectrum analyzer scans from 9kHz to the 10th harmonic of the carrier. The peak detector is used.

RBW is set to 100kHz, VBW is set to 300kHz for 30MHz~1GHz

RBW is set to 1MHz, VBW is set to 3MHz for above 1GHz, Sweep is set to ATUO.

Of those disturbances below (limit – 20 dB), the mark is not required for the EUT.

The modulation mode and RB allocation refer to section 5.1, using the maximum output power configuration.

Test setup

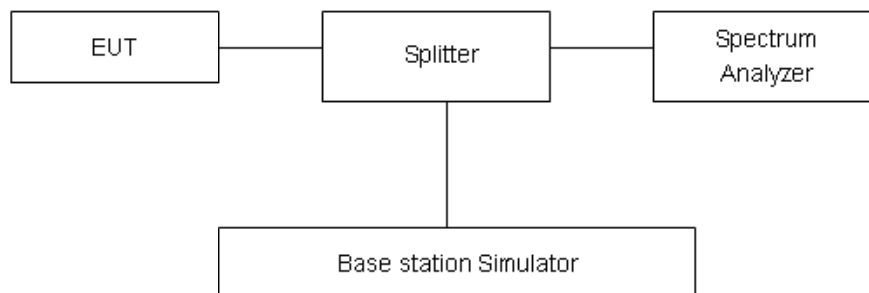

Limits

Rule Part 27.53(h) specifies that “for operations in the 1695-1710 MHz, 1710-1755 MHz, 1755-1780 MHz, 1915-1920 MHz, 1995-2000 MHz, 2000-2020 MHz, 2110-2155 MHz, 2155-2180 MHz, and 2180-2200 bands, the power of any emission outside a licensee's frequency block shall be attenuated below the transmitter power (P) in watts by at least $43 + 10 \log_{10} (P)$ dB..”

Rule Part 27.53 (g) For operations in the 600 MHz band and the 698-746 MHz band, the power of any emission outside a licensee's frequency band(s) of operation shall be attenuated below the transmitter power (P) within the licensed band(s) of operation, measured in watts, by at least $43 + 10 \log (P)$ dB. Compliance with this provision is based on the use of measurement instrumentation employing a resolution bandwidth of 100 kilohertz or greater. However, in the 100 kilohertz bands immediately outside and adjacent to a licensee's frequency block, a resolution bandwidth of at least 30 kHz may be employed.

Rule Part 27.53(f) For operations in the 746-758 MHz, 775-788 MHz, and 805-806 MHz bands, emissions in the band 1559-1610 MHz shall be limited to -70 dBW/MHz equivalent isotropically



radiated power (EIRP) for wideband signals, and -80 dBW EIRP for discrete emissions of less than 700 Hz bandwidth. For the purpose of equipment authorization, a transmitter shall be tested with an antenna that is representative of the type that will be used with the equipment in normal operation.

Rule Part 27.53(a)(4)(i) By a factor of not less than $43 + 10 \log (P)$ dB on all frequencies between 2305 and 2320 MHz.

Part 27.53 (c) For operations in the 746-758 MHz band and the 776-788 MHz band, the power of any emission outside the licensee's frequency band(s) of operation shall be attenuated below the transmitter power (P) within the licensed band(s) of operation, measured in watts, in accordance with the following:

- (1) On any frequency outside the 746-758 MHz band, the power of any emission shall be attenuated outside the band below the transmitter power (P) by at least $43 + 10 \log (P)$ dB;
- (2) On any frequency outside the 776-788 MHz band, the power of any emission shall be attenuated outside the band below the transmitter power (P) by at least $43 + 10 \log (P)$ dB;
- (3) On all frequencies between 763-775 MHz and 793-805 MHz, by a factor not less than $76 + 10 \log (P)$ dB in a 6.25 kHz band segment, for base and fixed stations;
- (4) On all frequencies between 763-775 MHz and 793-805 MHz, by a factor not less than $65 + 10 \log (P)$ dB in a 6.25 kHz band segment, for mobile and portable stations;
- (5) Compliance with the provisions of paragraphs (c)(1) and (c)(2) of this section is based on the use of measurement instrumentation employing a resolution bandwidth of 100 kHz or greater. However, in the 100 kHz bands immediately outside and adjacent to the frequency block, a resolution bandwidth of at least 30 kHz may be employed;

Part 27.53(a)/(h)/(g) Limit		-13 dBm
Part 27.53(f) Limit	Limit out of the band 1559-1610 MHz	-13 dBm
	Limit in the band 1559-1610 MHz	-40 dBm

Measurement Uncertainty

The assessed measurement uncertainty to ensure 99.75% confidence level for the normal distribution is with the coverage factor $k = 1.96$.

Frequency	Uncertainty
9kHz-1GHz	0.684 dB
1GHz-27GHz	1.407 dB



Test Result

Sweep the whole frequency band through the range from 9kHz to the 10th harmonic of the carrier, the emissions more than 20 dB below the limit are not reported.

The signal beyond the limit is carrier.

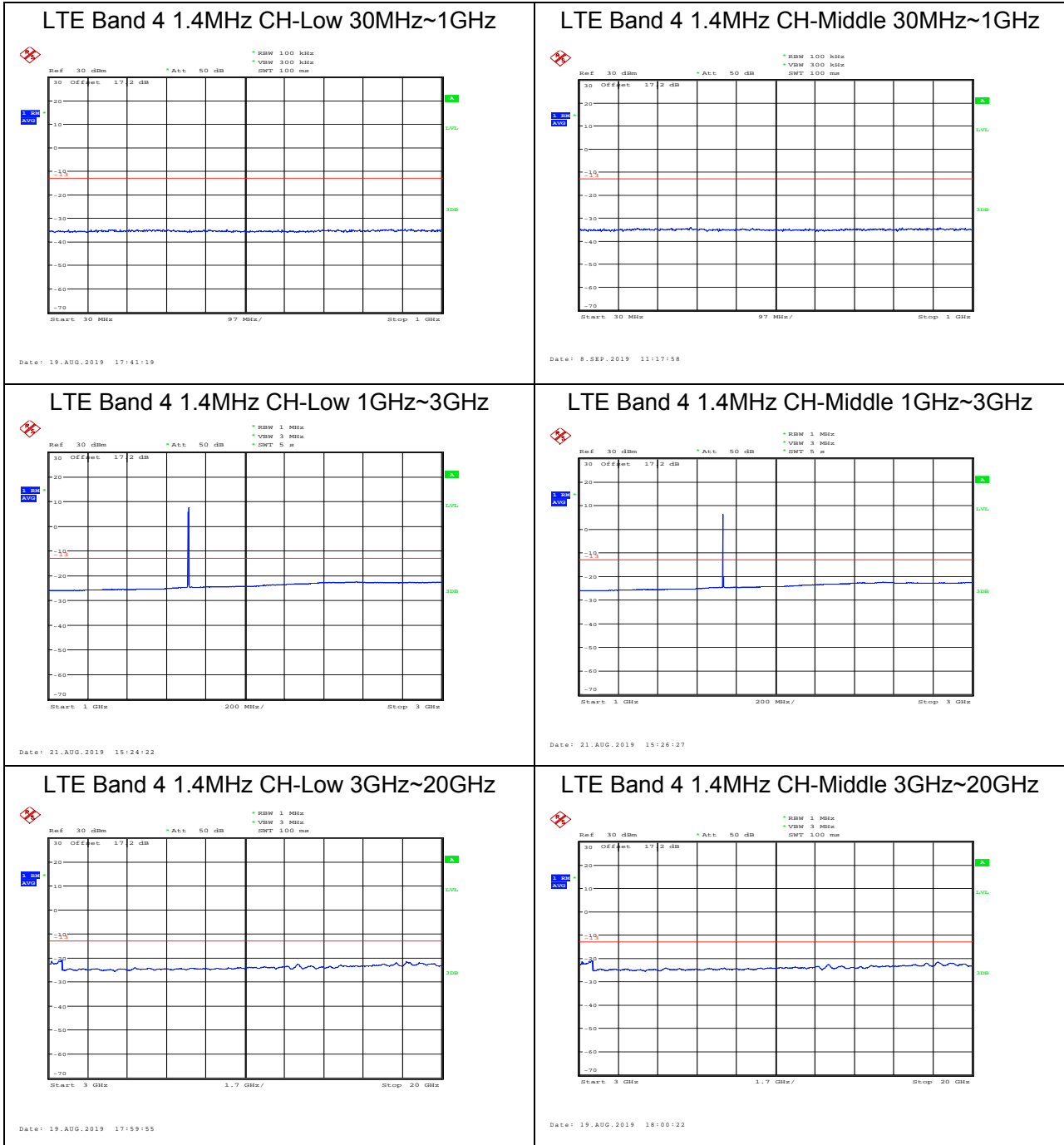



LTE Band 4 1.4MHz CH-High 30MHz~1GHz

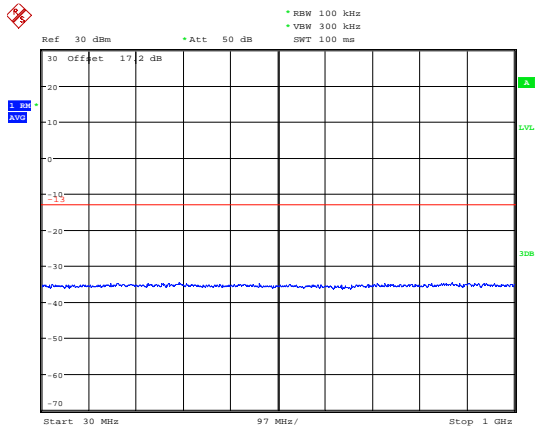

Date: 19.AUG.2019 17:45:27

LTE Band 4 3MHz CH-Low 30MHz~1GHz

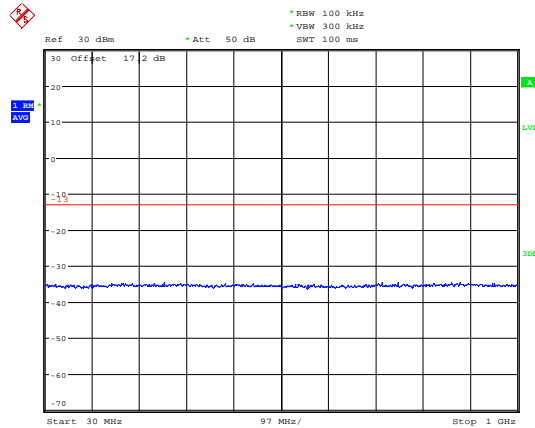

Date: 19.AUG.2019 17:46:25

LTE Band 4 1.4MHz CH-High 1GHz~3GHz

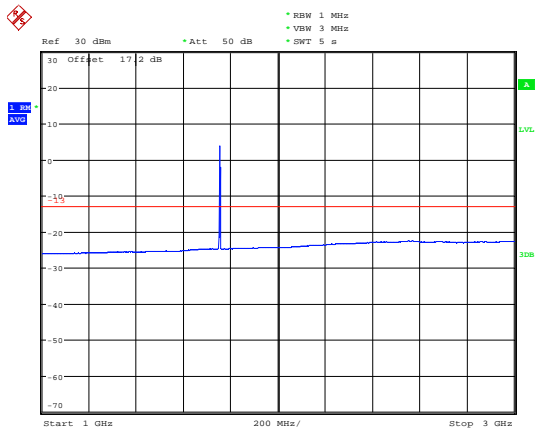

Date: 21.AUG.2019 15:28:28

LTE Band 4 3MHz CH-Low 1GHz~3GHz

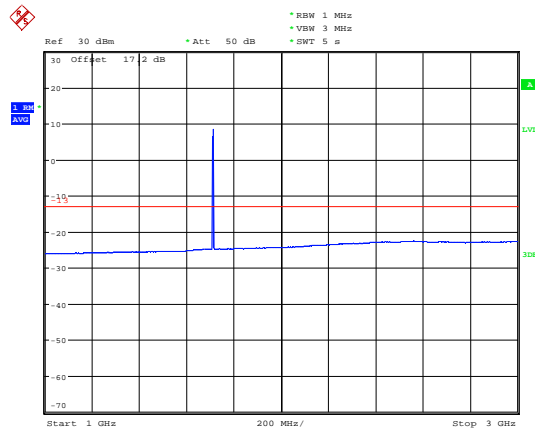

Date: 21.AUG.2019 15:30:34

LTE Band 4 1.4MHz CH-High 3GHz~20GHz

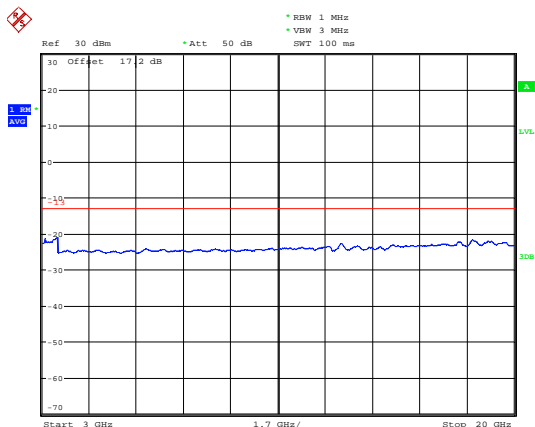

Date: 19.AUG.2019 18:00:41

LTE Band 4 3MHz CH-Low 3GHz~20GHz

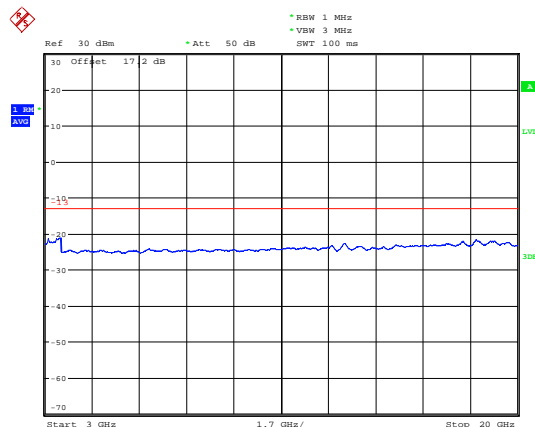

Date: 19.AUG.2019 18:07:17



LTE Band 4 3MHz CH-Middle 30MHz~1GHz

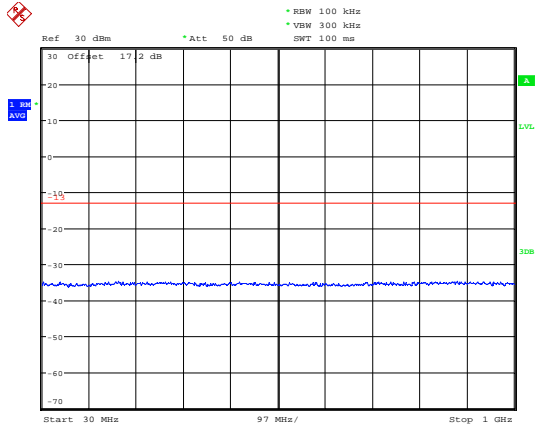

Date: 19.AUG.2019 17:47:11

LTE Band 4 3MHz CH-High 30MHz~1GHz

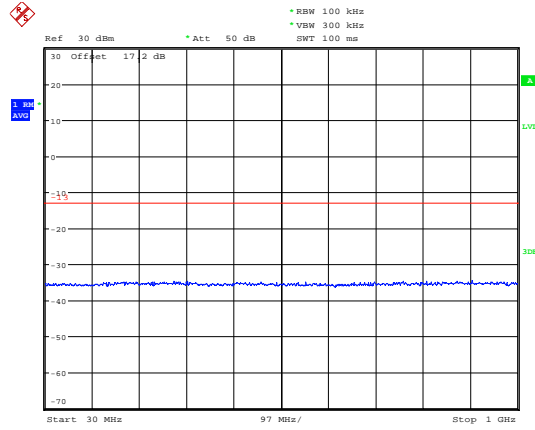

Date: 19.AUG.2019 17:49:57

LTE Band 4 3MHz CH-Middle 1GHz~3GHz

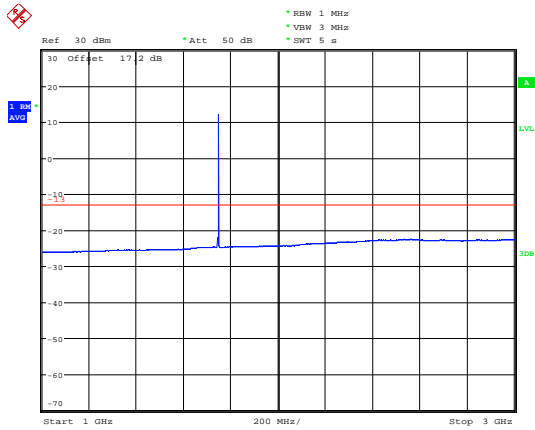

Date: 21.AUG.2019 15:32:11

LTE Band 4 3MHz CH-High 1GHz~3GHz

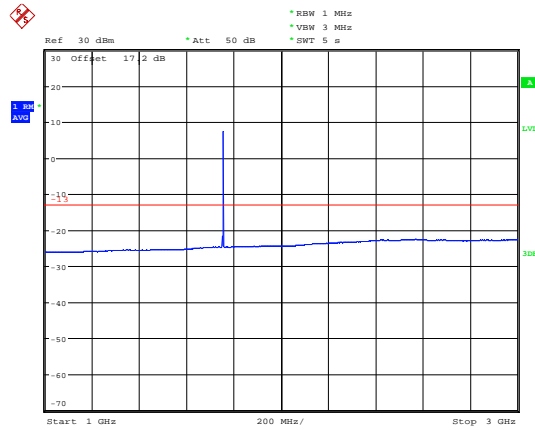

Date: 21.AUG.2019 15:33:15

LTE Band 4 3MHz CH-Middle 3GHz~20GHz

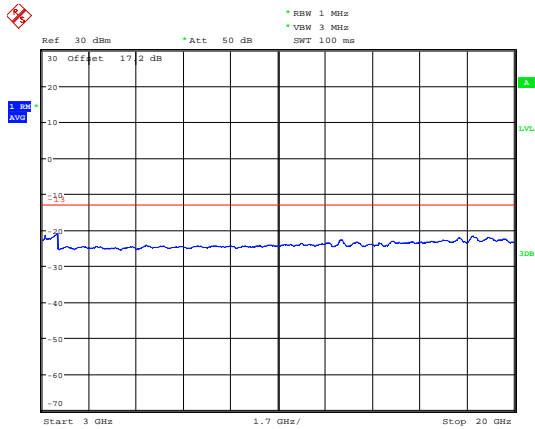

Date: 19.AUG.2019 18:08:00

LTE Band 4 3MHz CH-High 3GHz~20GHz

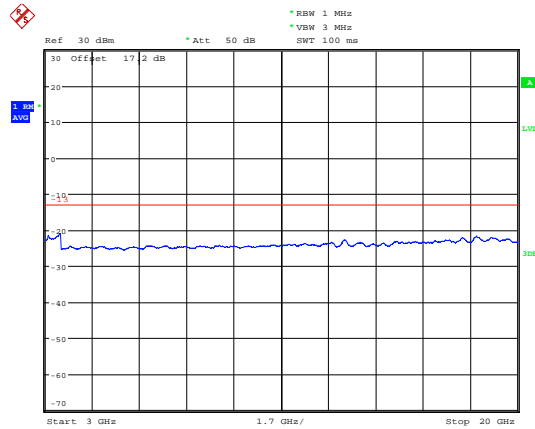

Date: 19.AUG.2019 18:09:18



LTE Band 4 5MHz CH-Low 30MHz~1GHz

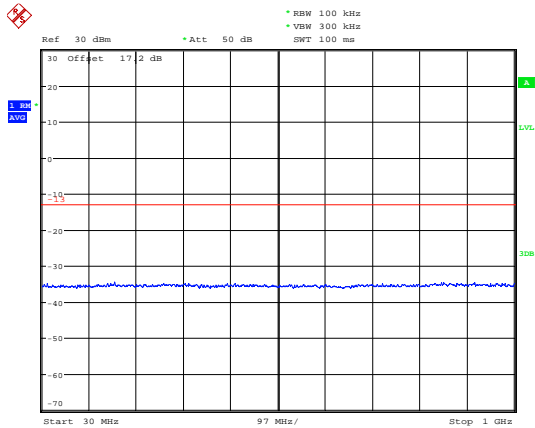

Date: 19.AUG.2019 17:50:14

LTE Band 4 5MHz CH-Middle 30MHz~1GHz

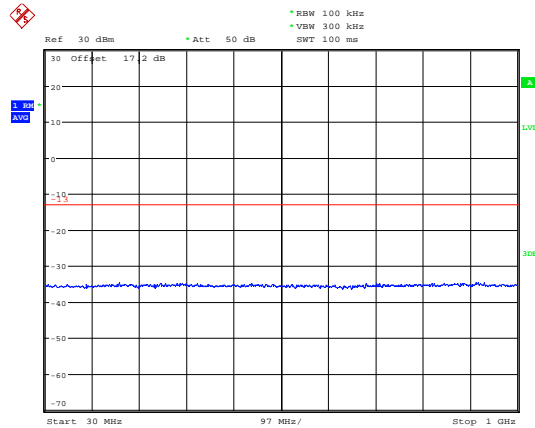

Date: 19.AUG.2019 17:50:36

LTE Band 4 5MHz CH-Low 1GHz~3GHz

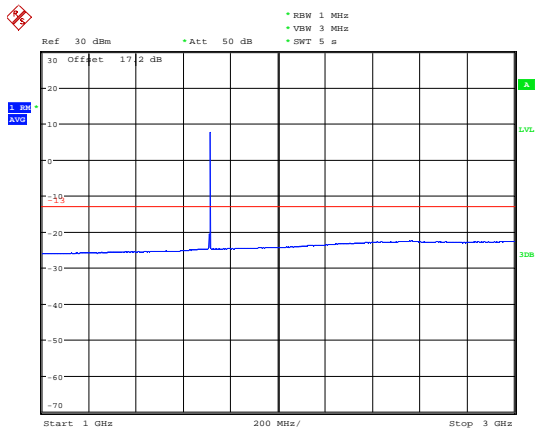

Date: 21.AUG.2019 15:34:44

LTE Band 4 5MHz CH-Middle 1GHz~3GHz

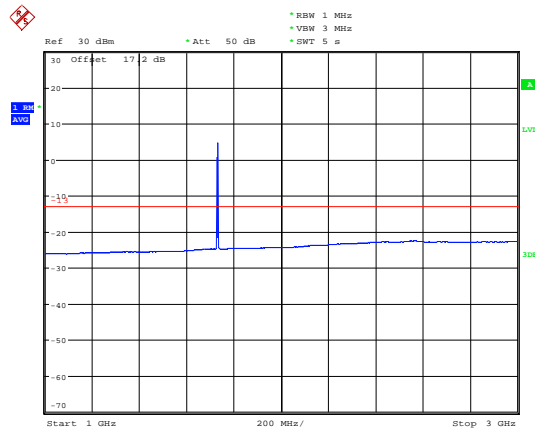

Date: 21.AUG.2019 15:38:21

LTE Band 4 5MHz CH-Low 3GHz~20GHz

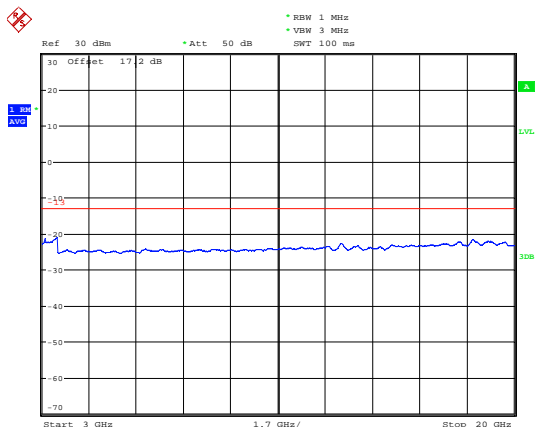

Date: 19.AUG.2019 18:10:07

LTE Band 4 5MHz CH-Middle 3GHz~20GHz

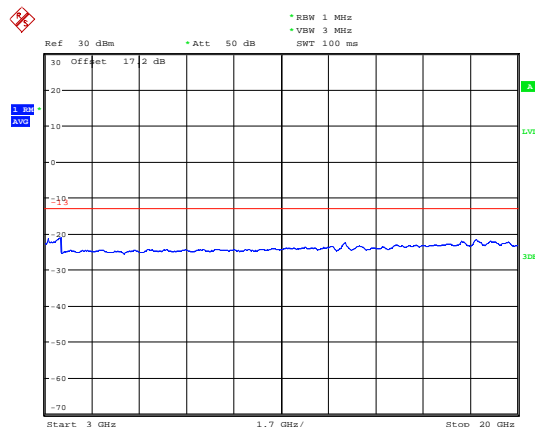

Date: 19.AUG.2019 18:14:22



LTE Band 4 5MHz CH-High 30MHz~1GHz

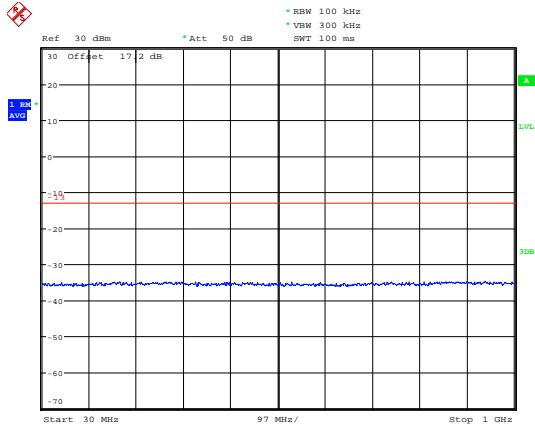

Date: 19.AUG.2019 17:51:11

LTE Band 4 10MHz CH-Low 30MHz~1GHz

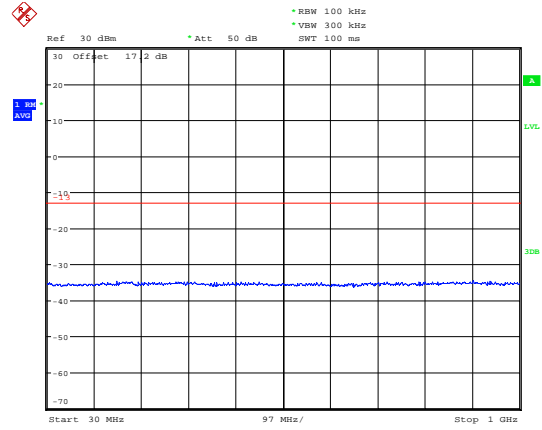

Date: 19.AUG.2019 17:51:30

LTE Band 4 5MHz CH-High 1GHz~3GHz

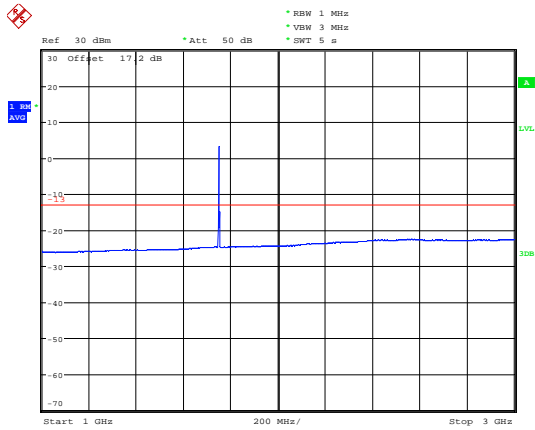

Date: 21.AUG.2019 15:40:03

LTE Band 4 10MHz CH-Low 1GHz~3GHz

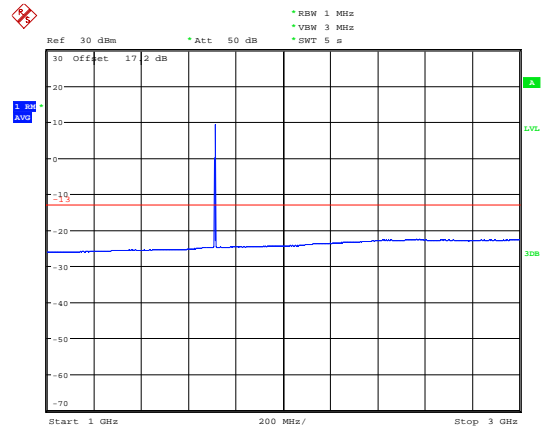

Date: 21.AUG.2019 15:41:28

LTE Band 4 5MHz CH-High 3GHz~20GHz

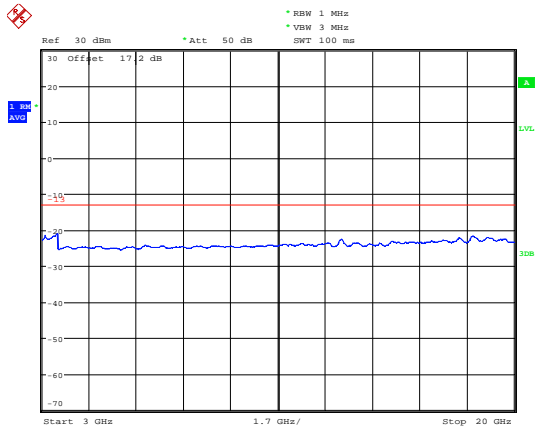

Date: 19.AUG.2019 18:24:33

LTE Band 4 10MHz CH-Low 3GHz~20GHz

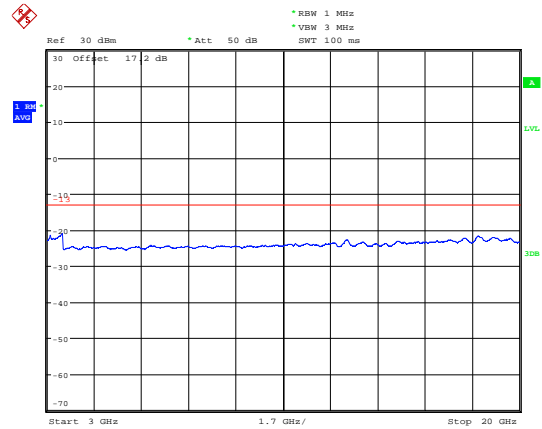

Date: 19.AUG.2019 18:24:43



LTE Band 4 10MHz CH-Middle 30MHz~1GHz

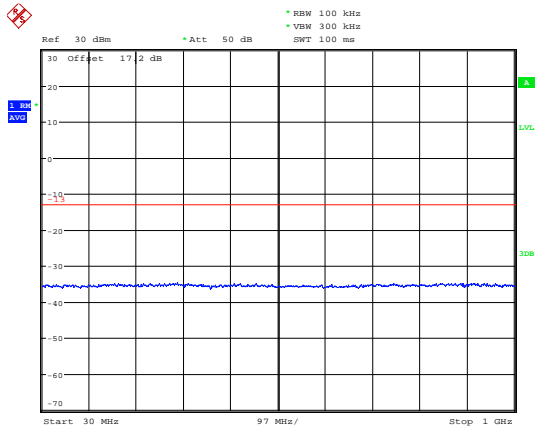

Date: 19.AUG.2019 17:51:48

LTE Band 4 10MHz CH-High 30MHz~1GHz

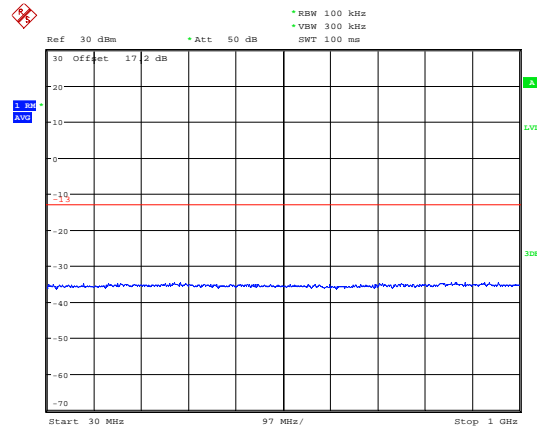

Date: 19.AUG.2019 17:52:00

LTE Band 4 10MHz CH-Middle 1GHz~3GHz

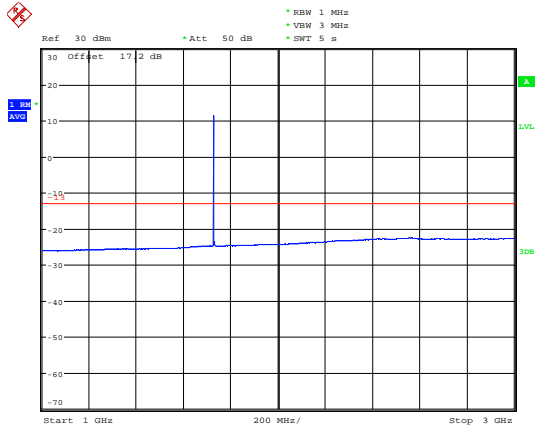

Date: 21.AUG.2019 15:42:57

LTE Band 4 10MHz CH-High 1GHz~3GHz

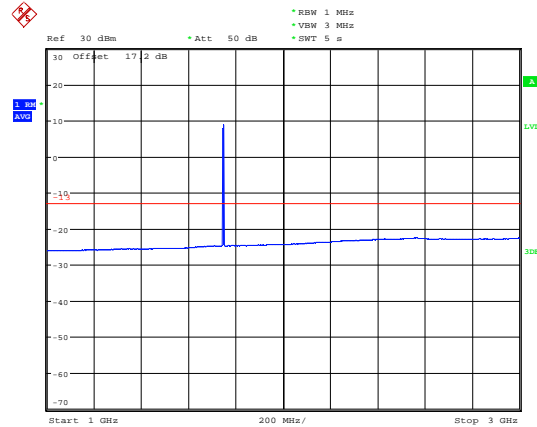

Date: 21.AUG.2019 16:20:46

LTE Band 4 10MHz CH-Middle 3GHz~20GHz

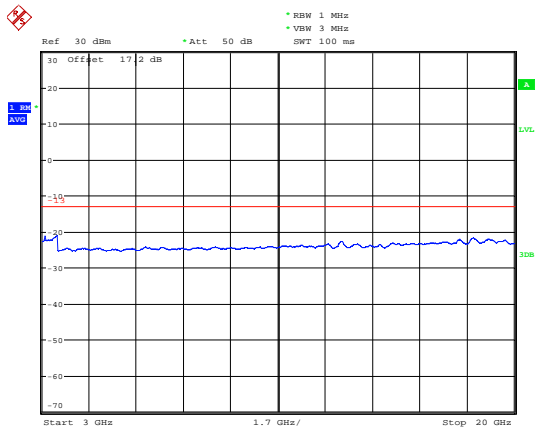

Date: 19.AUG.2019 18:27:08

LTE Band 4 10MHz CH-High 3GHz~20GHz

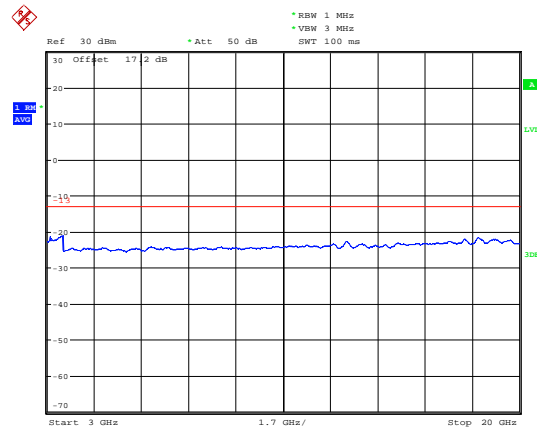

Date: 19.AUG.2019 18:28:40



LTE Band 4 15MHz CH-Low 30MHz~1GHz

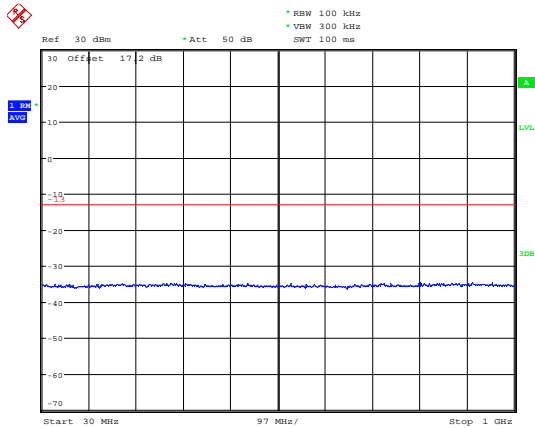

Date: 19.AUG.2019 17:52:46

LTE Band 4 15MHz CH-Middle 30MHz~1GHz

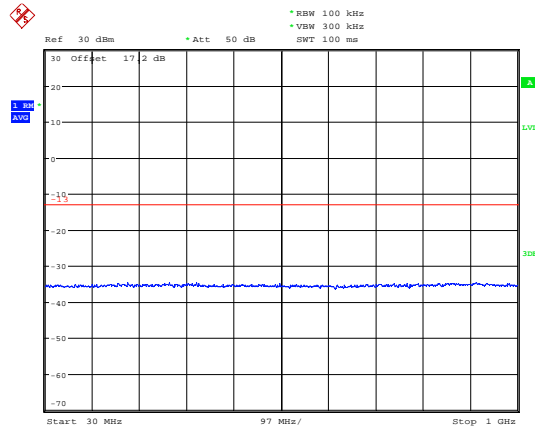

Date: 19.AUG.2019 17:53:23

LTE Band 4 15MHz CH-Low 1GHz~3GHz

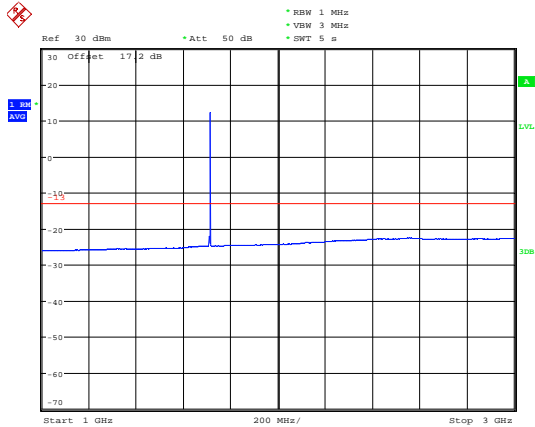

Date: 21.AUG.2019 16:22:54

LTE Band 4 15MHz CH-Middle 1GHz~3GHz

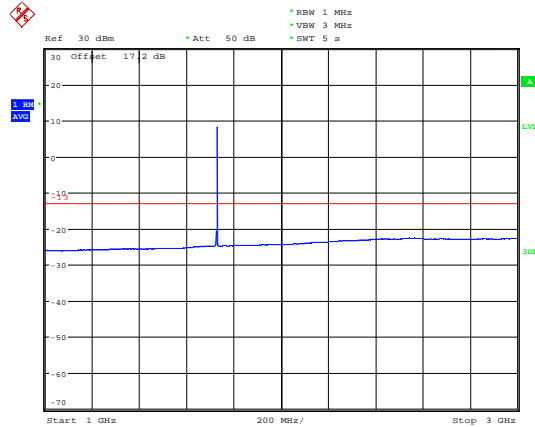

Date: 21.AUG.2019 16:27:09

LTE Band 4 15MHz CH-Low 3GHz~20GHz

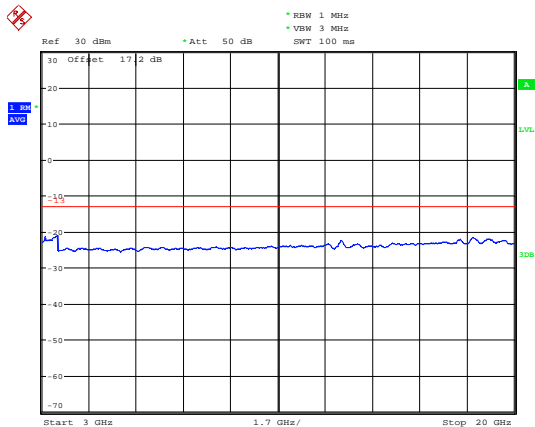

Date: 19.AUG.2019 18:31:36

LTE Band 4 15MHz CH-Middle 3GHz~20GHz

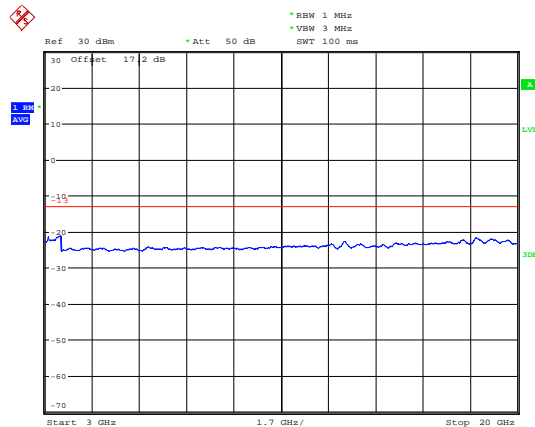

Date: 19.AUG.2019 18:34:49



LTE Band 4 15MHz CH-High 30MHz~1GHz

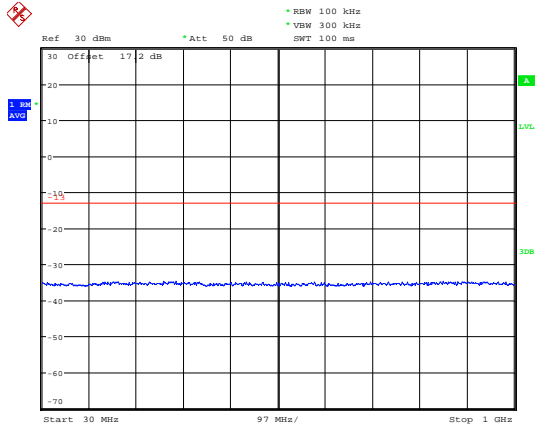

Date: 19.AUG.2019 17:53:43

LTE Band 4 20MHz CH-Low 30MHz~1GHz

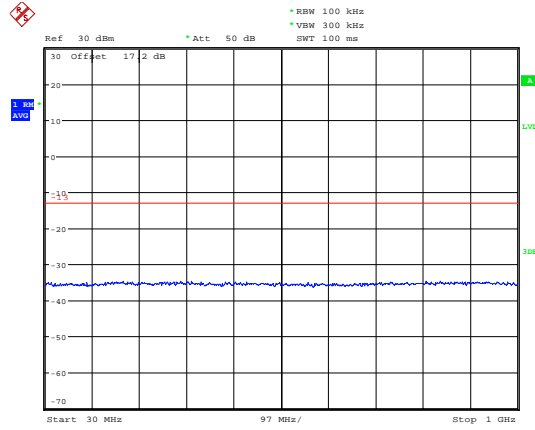

Date: 19.AUG.2019 17:54:25

LTE Band 4 15MHz CH-High 1GHz~3GHz

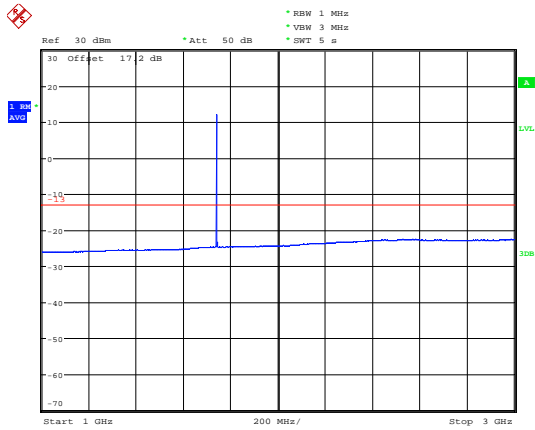

Date: 21.AUG.2019 16:24:37

LTE Band 4 20MHz CH-Low 1GHz~3GHz

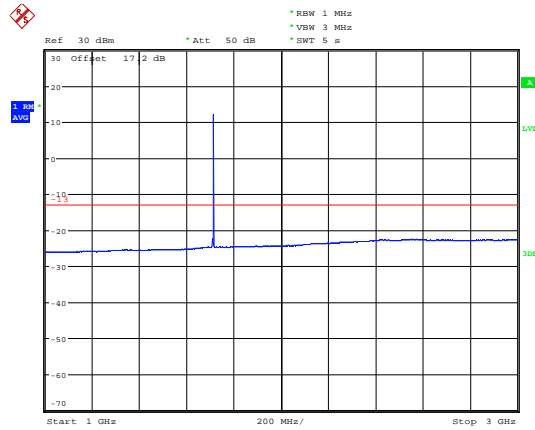

Date: 21.AUG.2019 16:31:17

LTE Band 4 15MHz CH-High 3GHz~20GHz

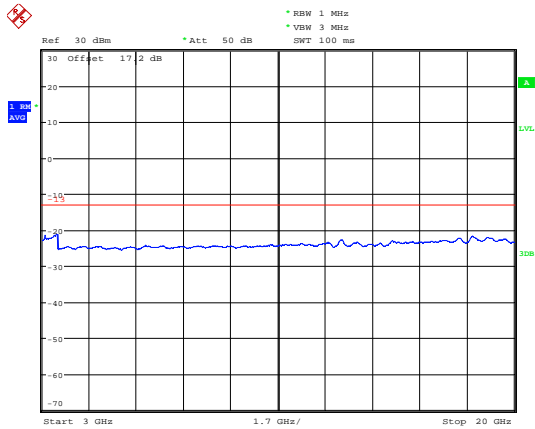

Date: 19.AUG.2019 18:35:55

LTE Band 4 20MHz CH-Low 3GHz~20GHz

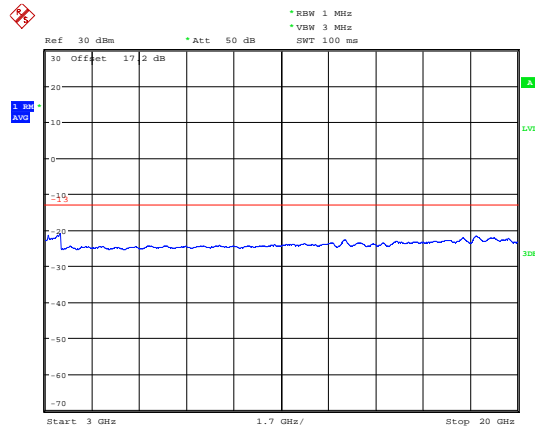

Date: 19.AUG.2019 18:36:43



LTE Band 4 20MHz CH-Middle 30MHz~1GHz

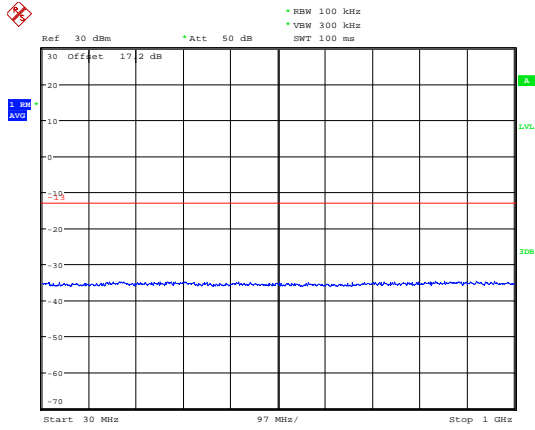

Date: 19.AUG.2019 17:54:47

LTE Band 4 20MHz CH-High 30MHz~1GHz

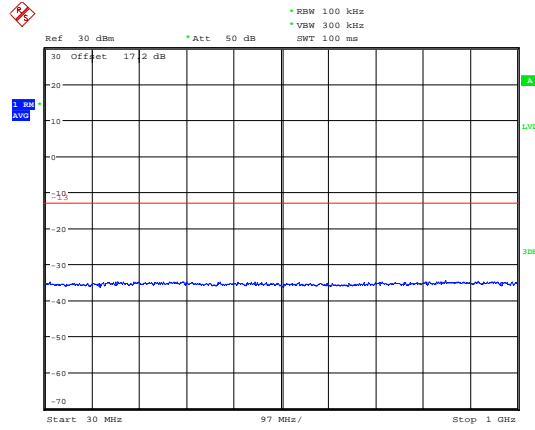

Date: 19.AUG.2019 17:55:16

LTE Band 4 20MHz CH-Middle 1GHz~3GHz

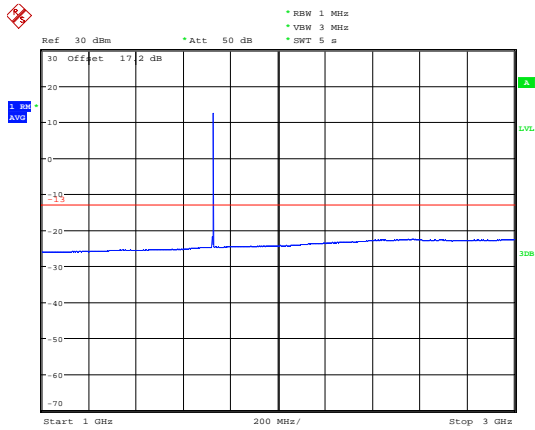

Date: 21.AUG.2019 16:32:52

LTE Band 4 20MHz CH-High 1GHz~3GHz

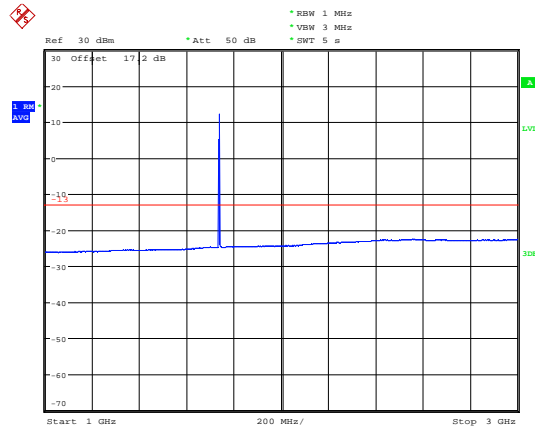

Date: 21.AUG.2019 16:34:38

LTE Band 4 20MHz CH-Middle 3GHz~20GHz

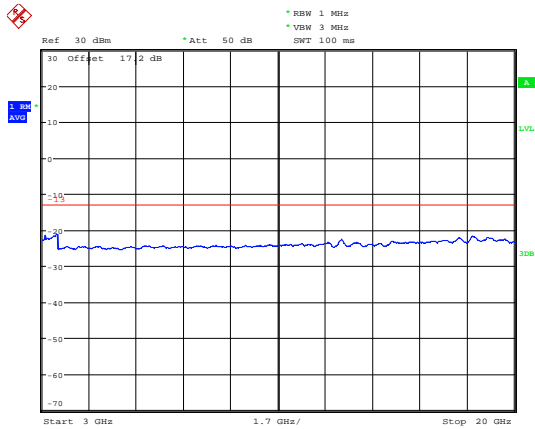

Date: 19.AUG.2019 18:37:53

LTE Band 4 20MHz CH-High 3GHz~20GHz

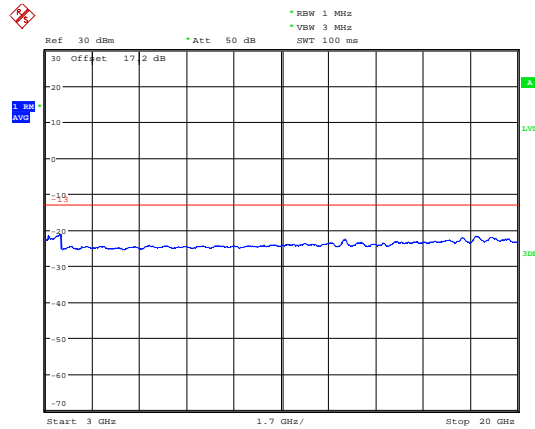

Date: 19.AUG.2019 18:38:14



LTE Band 12 1.4MHz CH-Low 30MHz~1GHz

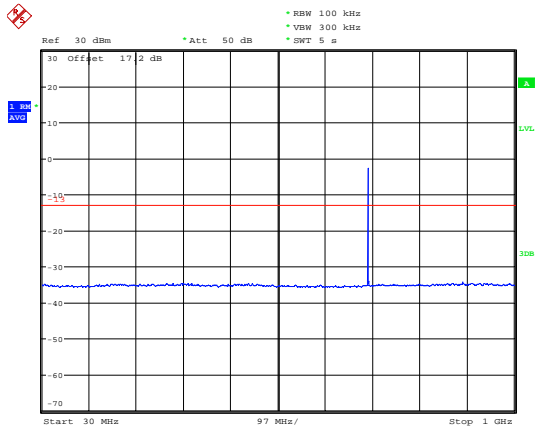

Date: 21.AUG.2019 17:16:42

LTE Band 12 1.4MHz CH-Low 1GHz~9GHz

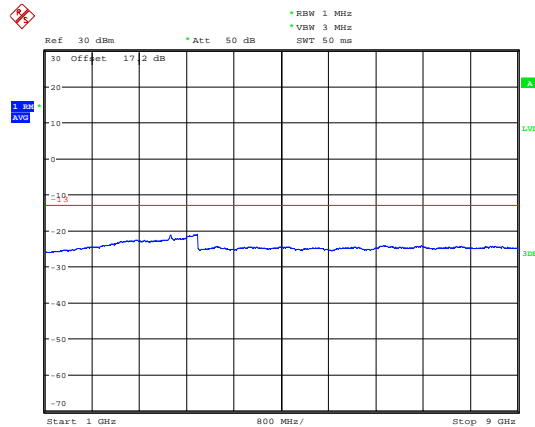

Date: 19.AUG.2019 20:14:28

LTE Band 12 1.4MHz CH- Middle 30MHz~1GHz

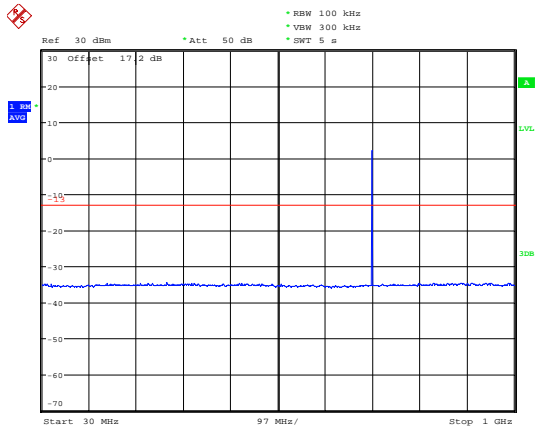

Date: 21.AUG.2019 17:18:16

LTE Band 12 1.4MHz CH- Middle 1GHz~9GHz

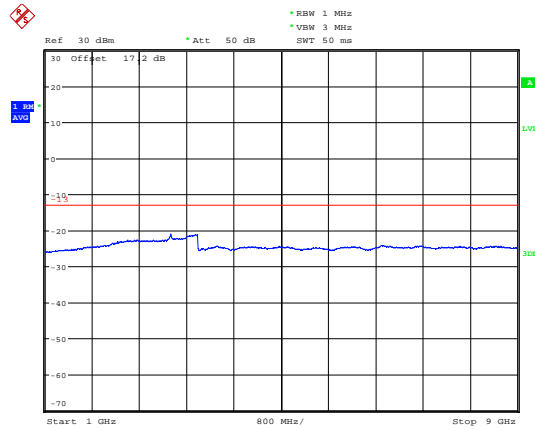

Date: 19.AUG.2019 20:15:09

LTE Band 12 1.4MHz CH-High 30MHz~1GHz

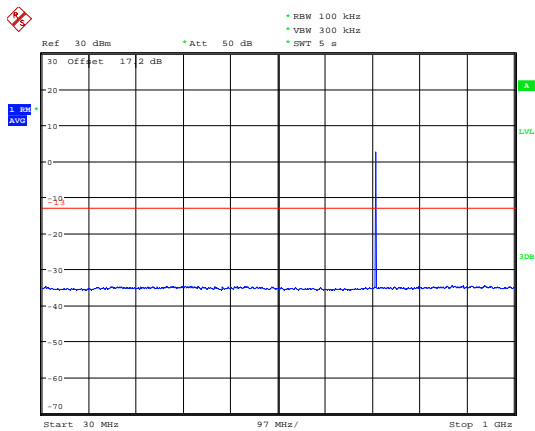

Date: 21.AUG.2019 17:19:50

LTE Band 12 1.4MHz CH-High 1GHz~9GHz

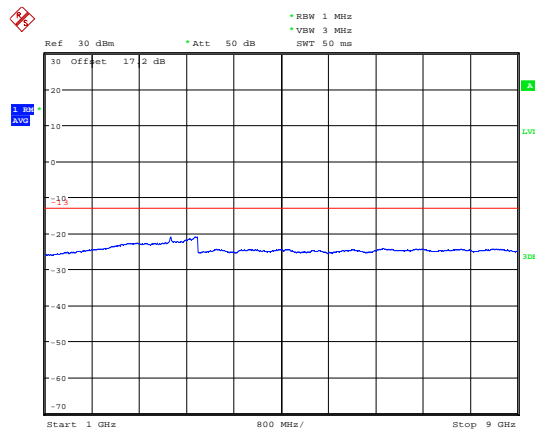

Date: 19.AUG.2019 20:16:08



LTE Band 12 3MHz CH-Low 30MHz~1GHz

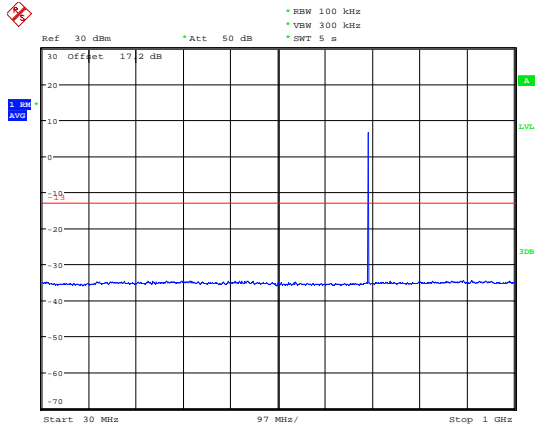

Date: 21.AUG.2019 17:21:24

LTE Band 12 3MHz CH-Low 1GHz~9GHz

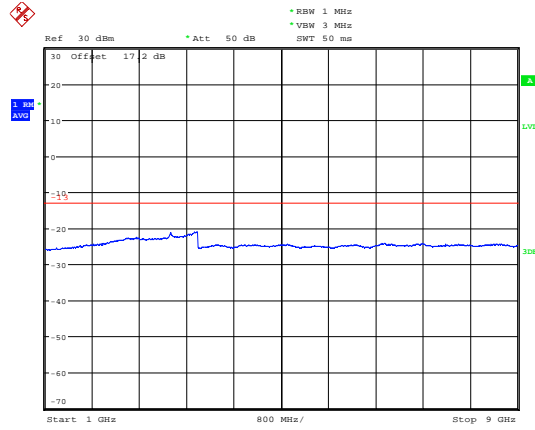

Date: 19.AUG.2019 20:16:20

LTE Band 12 3MHz CH- Middle 30MHz~1GHz

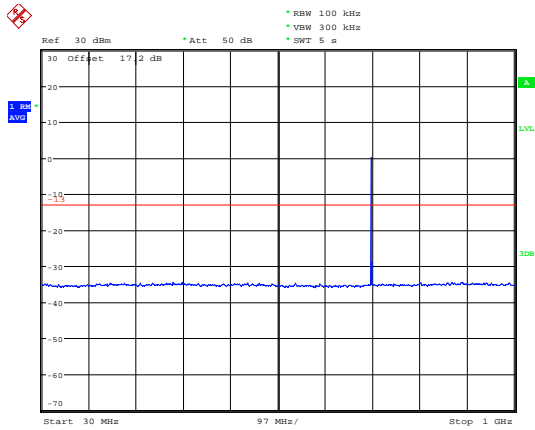

Date: 21.AUG.2019 17:23:35

LTE Band 12 3MHz CH- Middle 1GHz~9GHz

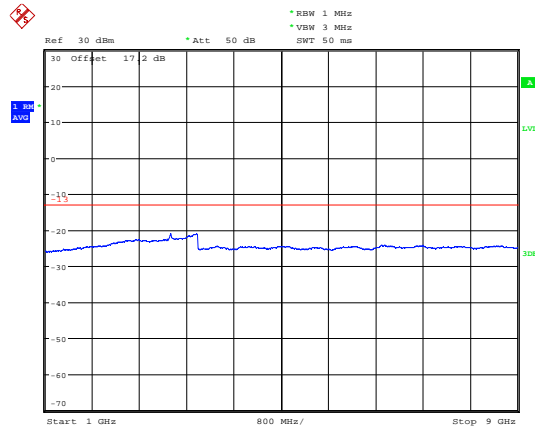

Date: 19.AUG.2019 20:16:59

LTE Band 12 3MHz CH-High 30MHz~1GHz

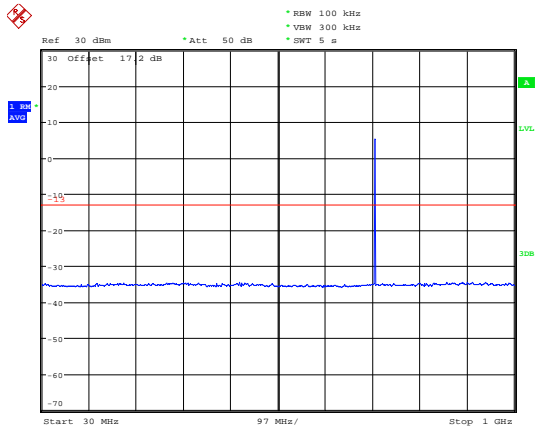

Date: 21.AUG.2019 17:25:47

LTE Band 12 3MHz CH-High 1GHz~9GHz

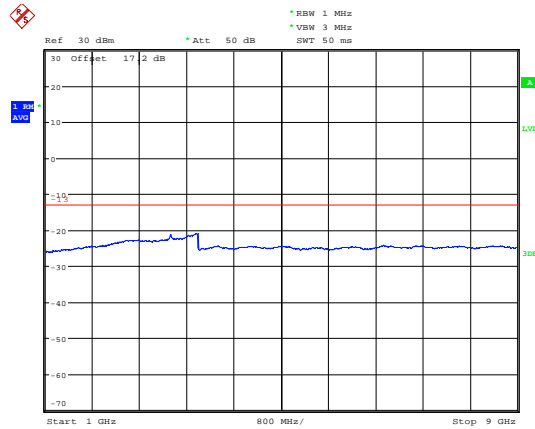

Date: 19.AUG.2019 20:17:34



LTE Band 12 5MHz CH-Low 30MHz~1GHz

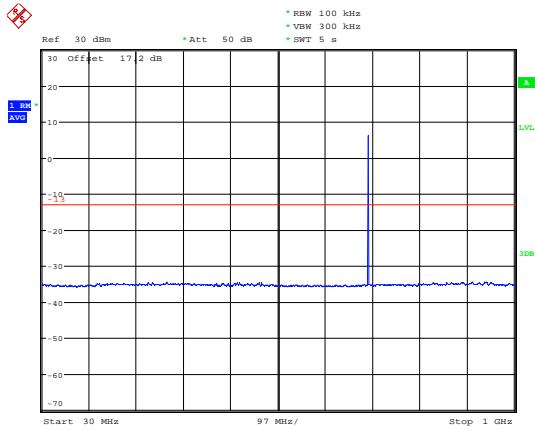

Date: 21.AUG.2019 17:27:12

LTE Band 12 5MHz CH-Low 1GHz~9GHz

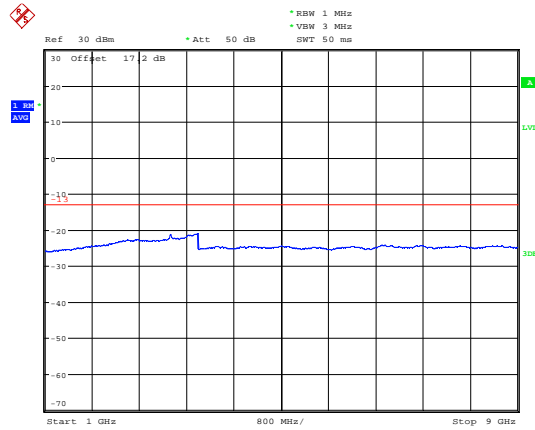

Date: 19.AUG.2019 20:17:49

LTE Band 12 5MHz CH- Middle 30MHz~1GHz

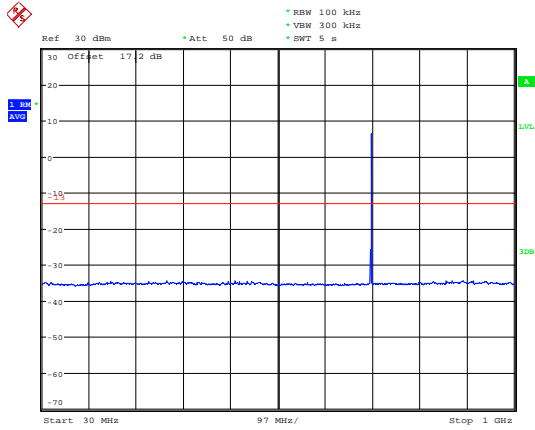

Date: 21.AUG.2019 17:28:31

LTE Band 12 5MHz CH- Middle 1GHz~9GHz

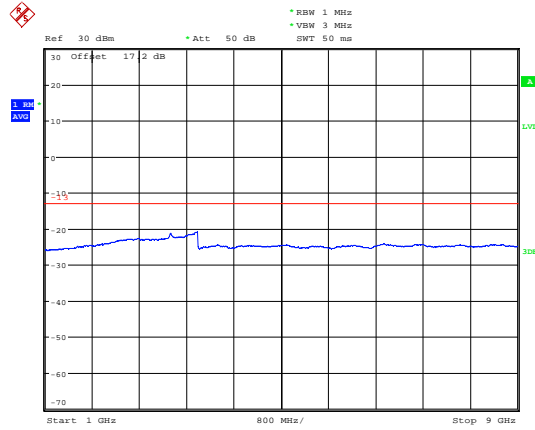

Date: 19.AUG.2019 20:18:30

LTE Band 12 5MHz CH-High 30MHz~1GHz

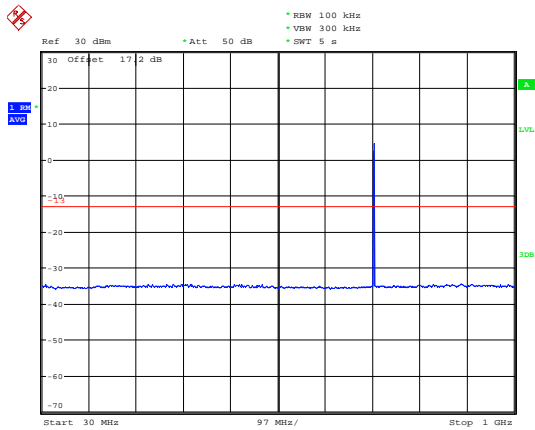

Date: 21.AUG.2019 17:30:08

LTE Band 12 5MHz CH-High 1GHz~9GHz

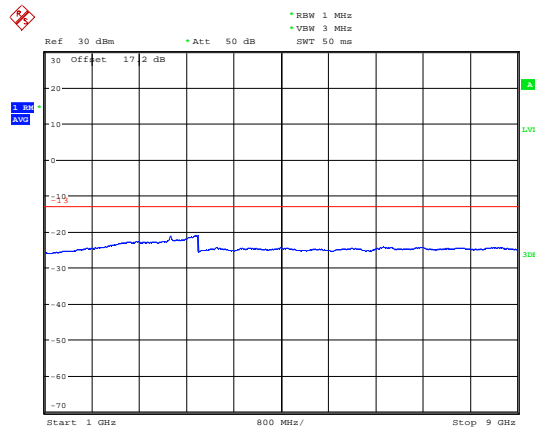

Date: 19.AUG.2019 20:18:49



LTE Band 12 10MHz CH-Low 30MHz~1GHz

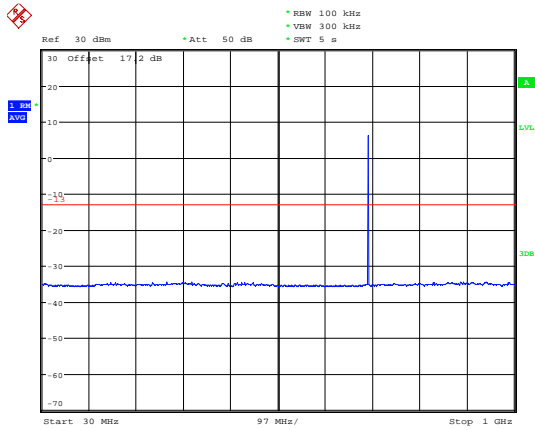

Date: 21.AUG.2019 17:31:47

LTE Band 12 10MHz CH-Low 1GHz~9GHz

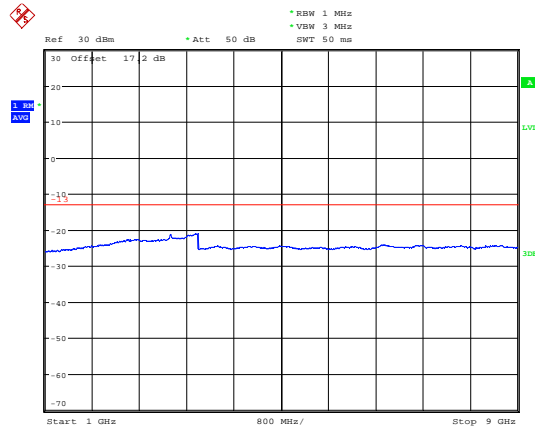

Date: 19.AUG.2019 20:19:06

LTE Band 12 10MHz CH- Middle 30MHz~1GHz

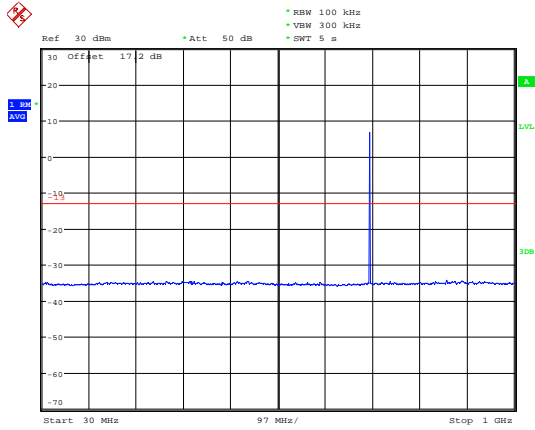

Date: 21.AUG.2019 17:33:29

LTE Band 12 10MHz CH- Middle 1GHz~9GHz

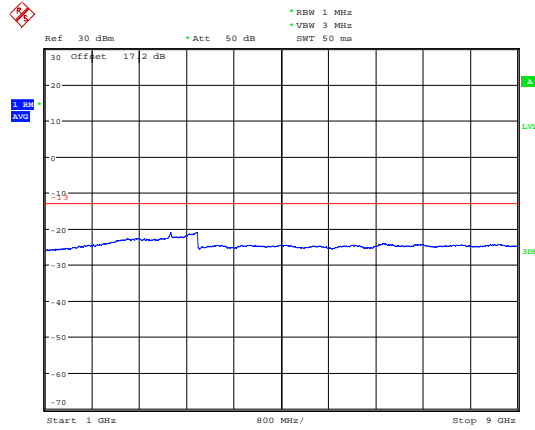

Date: 19.AUG.2019 20:19:25

LTE Band 12 10MHz CH-High 30MHz~1GHz

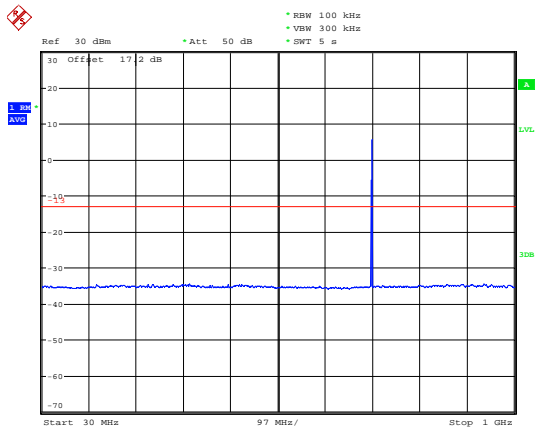

Date: 21.AUG.2019 17:35:08

LTE Band 12 10MHz CH-High 1GHz~9GHz

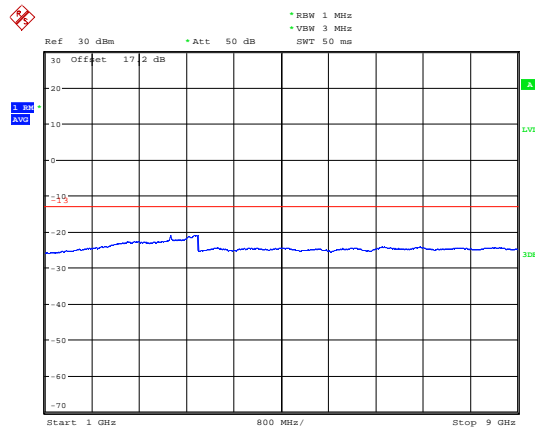

Date: 19.AUG.2019 20:19:39



LTE Band 13 5MHz CH-Low 30MHz~1GHz

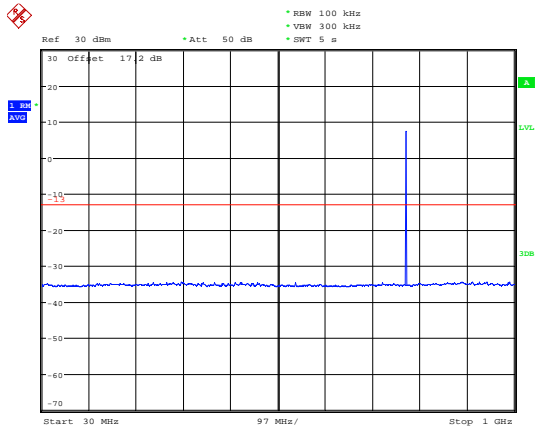

Date: 21.AUG.2019 17:37:07

LTE Band 13 5MHz CH-Low 1GHz~9GHz

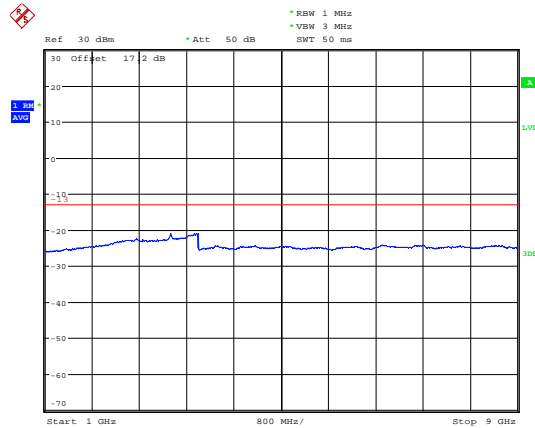

Date: 19.AUG.2019 20:25:02

LTE Band 13 5MHz CH-Middle 30MHz~1GHz

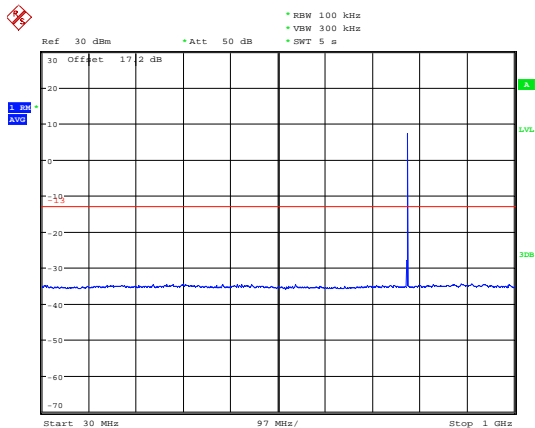

Date: 21.AUG.2019 17:38:41

LTE Band 13 5MHz CH-Middle 1GHz~9GHz

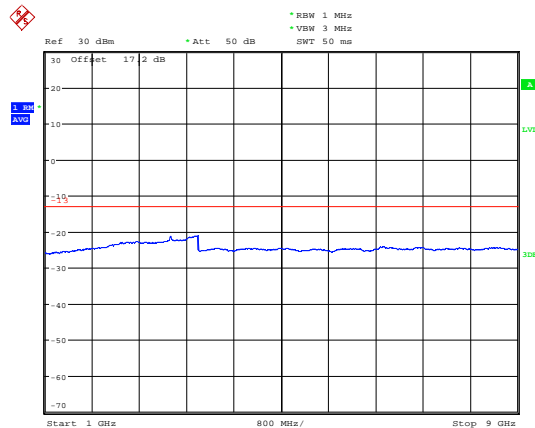

Date: 19.AUG.2019 20:25:30

LTE Band 13 5MHz CH-High 30MHz~1GHz

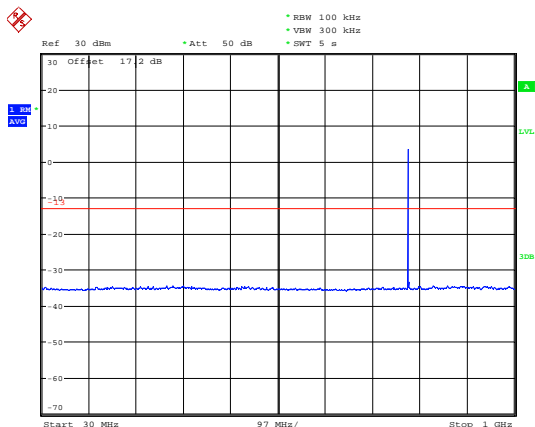

Date: 21.AUG.2019 17:40:10

LTE Band 13 5MHz CH-High 1GHz~9GHz

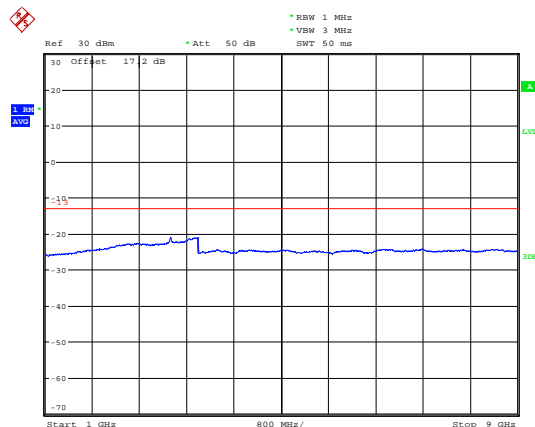

Date: 19.AUG.2019 20:26:58



LTE Band 13 10MHz CH-Middle 30MHz~1GHz

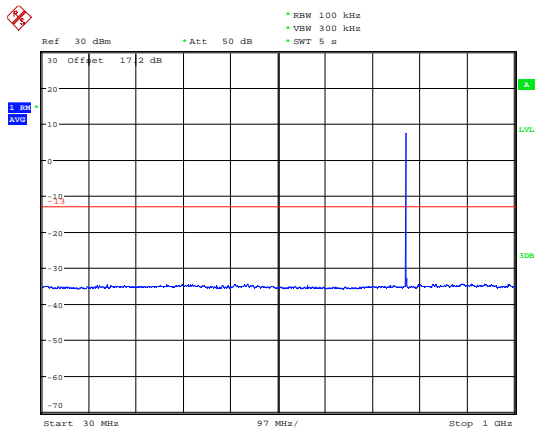

Date: 21.AUG.2019 17:41:46

LTE Band 13 10MHz CH-Middle 1GHz~9GHz

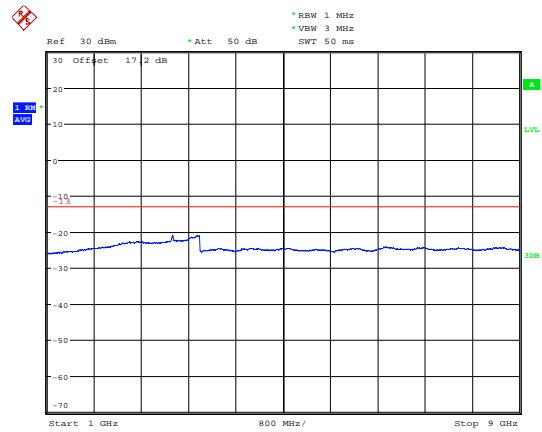

Date: 19.AUG.2019 20:28:36



LTE Band 14 10MHz CH-Middle 30MHz~1GHz

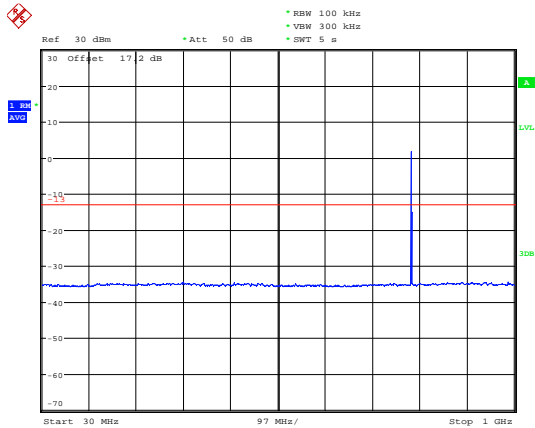

Date: 21.AUG.2019 17:48:54

LTE Band 14 10MHz CH-Middle 1GHz~9GHz

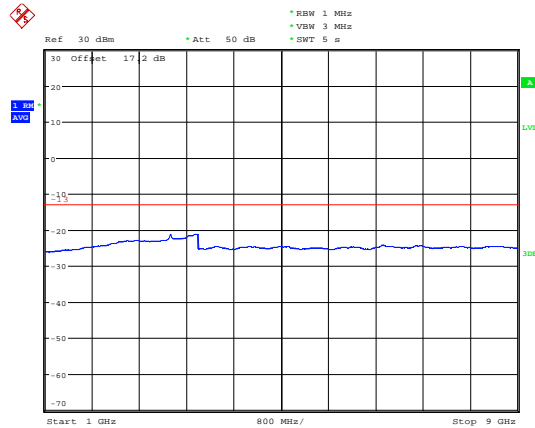

Date: 26.AUG.2019 11:07:11

LTE Band 66 1.4MHz CH-Low 30MHz~1GHz

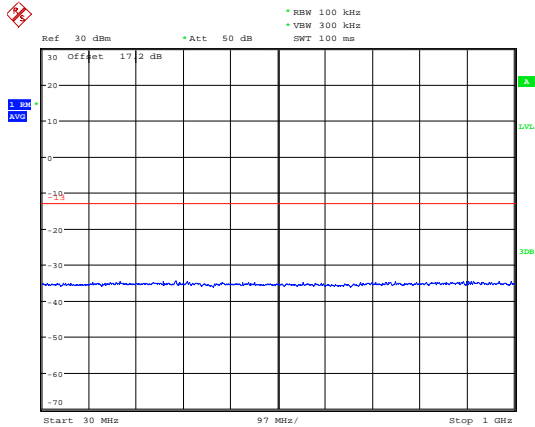

Date: 20.AUG.2019 20:13:59

LTE Band 66 1.4MHz CH-Middle 30MHz~1GHz

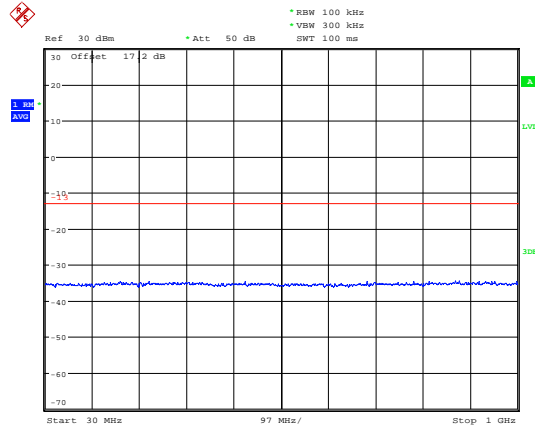

Date: 20.AUG.2019 20:14:20

LTE Band 66 1.4MHz CH-Low 1GHz~3GHz

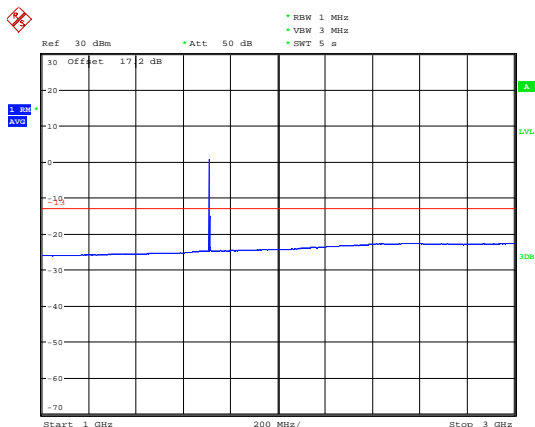

Date: 21.AUG.2019 20:06:39

LTE Band 66 1.4MHz CH-Middle 1GHz~3GHz

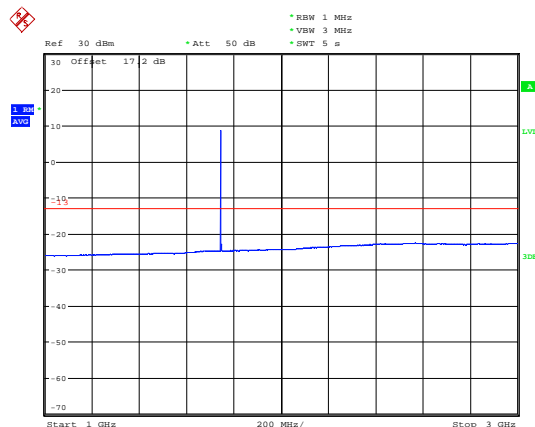

Date: 21.AUG.2019 20:08:42



LTE Band 66 1.4MHz CH-Low 3GHz~20GHz

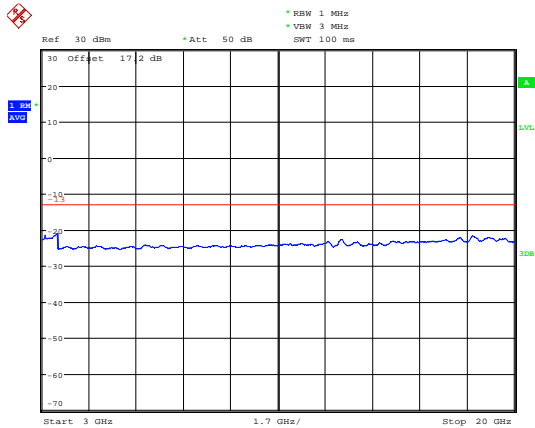

Date: 20.AUG.2019 20:26:55

LTE Band 66 1.4MHz CH-Middle 3GHz~20GHz

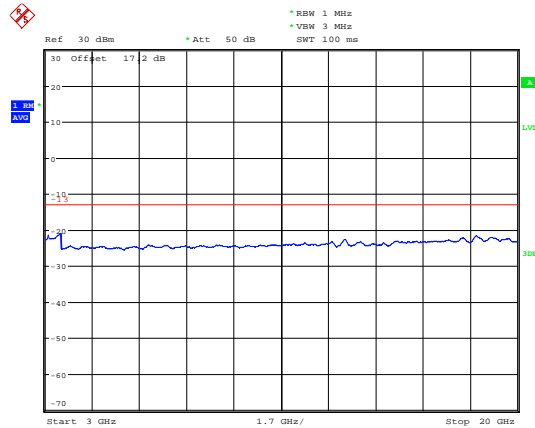

Date: 20.AUG.2019 20:27:06

LTE Band 66 1.4MHz CH-High 30MHz~1GHz

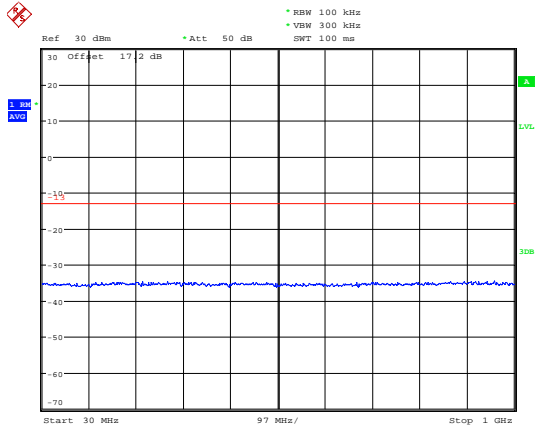

Date: 20.AUG.2019 20:14:23

LTE Band 66 3MHz CH-Low 30MHz~1GHz

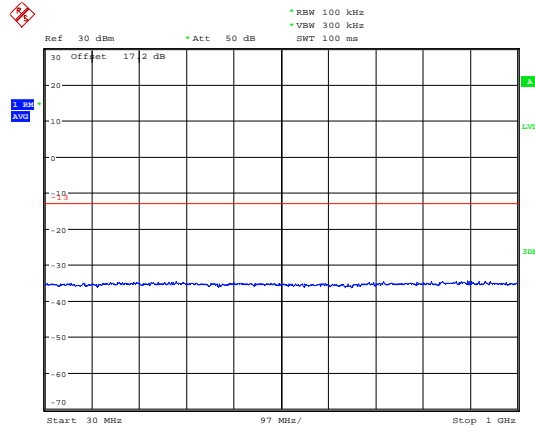

Date: 20.AUG.2019 20:14:37

LTE Band 66 1.4MHz CH-High 1GHz~3GHz

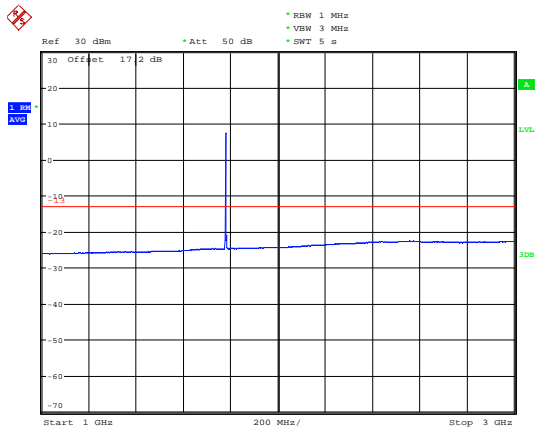

Date: 21.AUG.2019 20:11:39

LTE Band 66 3MHz CH-Low 1GHz~3GHz

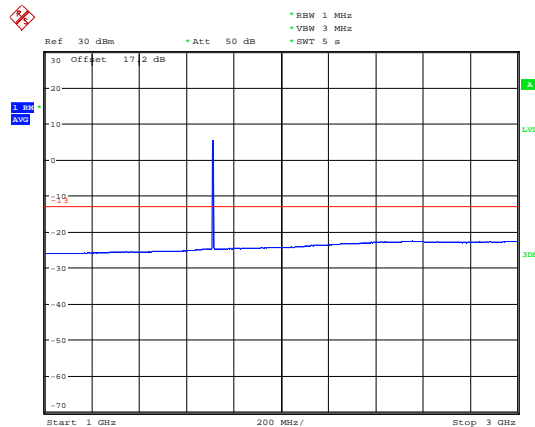

Date: 21.AUG.2019 20:12:57



LTE Band 66 1.4MHz CH-High 3GHz~20GHz

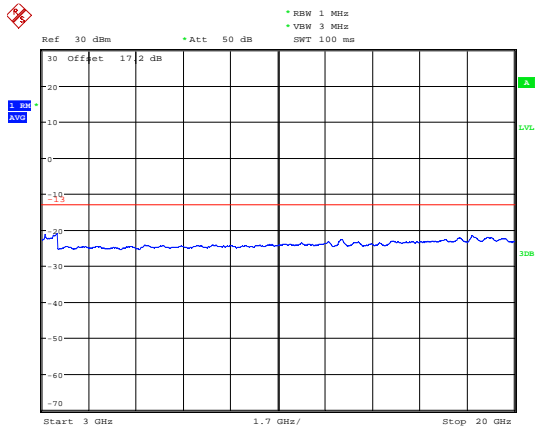

Date: 20.AUG.2019 20:27:18

LTE Band 66 3MHz CH-Low 3GHz~20GHz

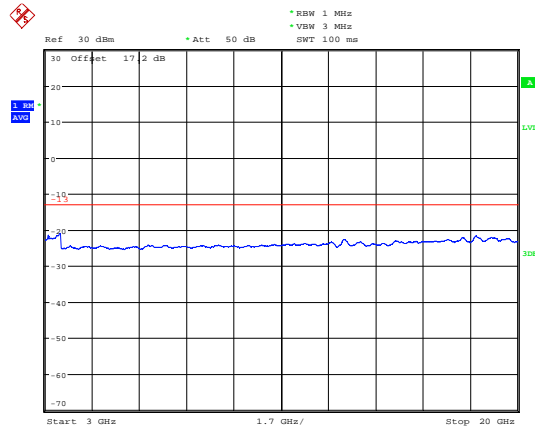

Date: 20.AUG.2019 20:27:39

LTE Band 66 3MHz CH-Middle 30MHz~1GHz

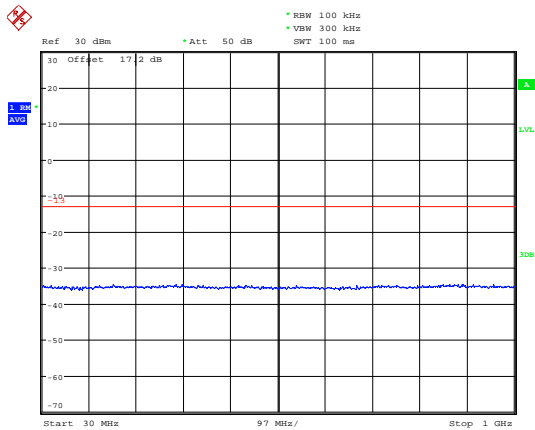

Date: 20.AUG.2019 20:14:52

LTE Band 66 3MHz CH-High 30MHz~1GHz

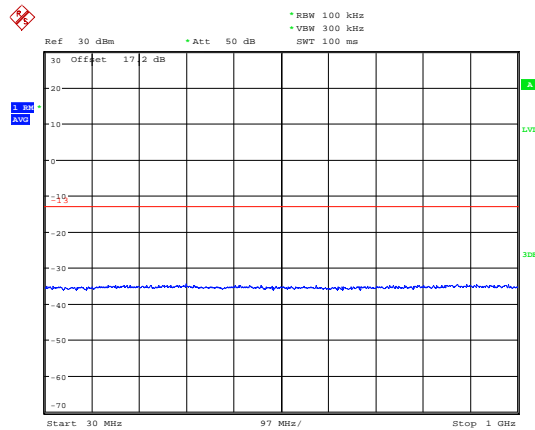

Date: 20.AUG.2019 20:15:11

LTE Band 66 3MHz CH-Middle 1GHz~3GHz

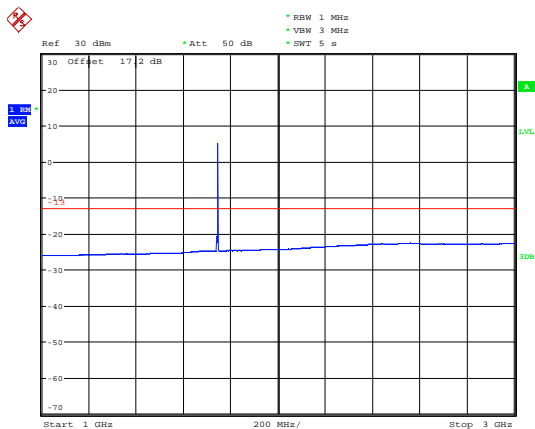

Date: 21.AUG.2019 20:15:03

LTE Band 66 3MHz CH-High 1GHz~3GHz

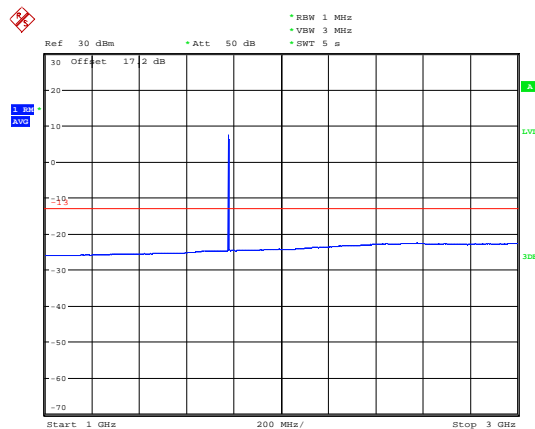

Date: 21.AUG.2019 20:16:32



LTE Band 66 3MHz CH-Middle 3GHz~20GHz

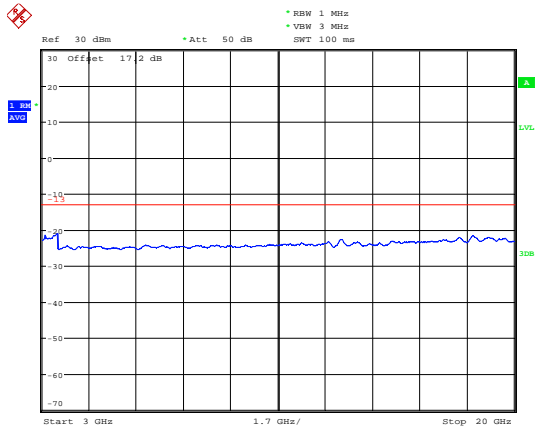

Date: 20.AUG.2019 20:28:10

LTE Band 66 3MHz CH-High 3GHz~20GHz

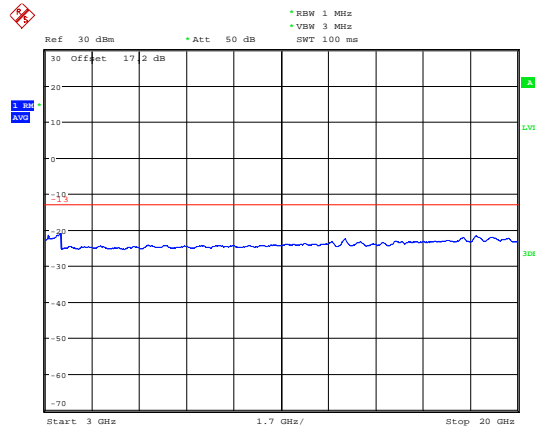

Date: 20.AUG.2019 20:28:28

LTE Band 66 5MHz CH-Low 30MHz~1GHz

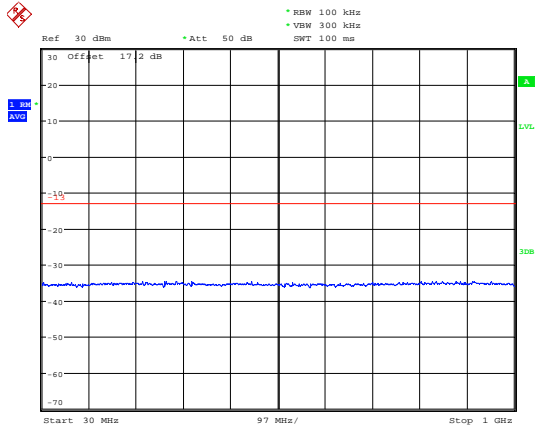

Date: 20.AUG.2019 20:15:33

LTE Band 66 5MHz CH-Middle 30MHz~1GHz

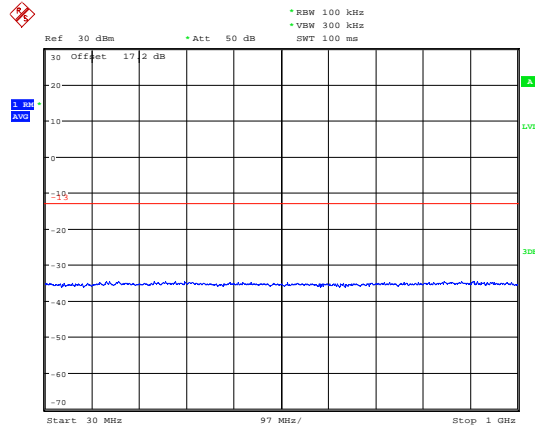

Date: 20.AUG.2019 20:15:59

LTE Band 66 5MHz CH-Low 1GHz~3GHz

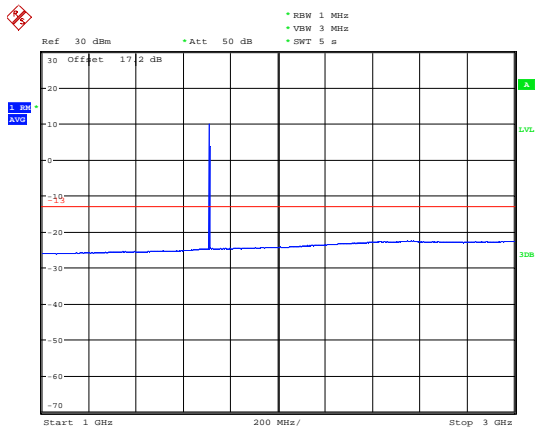

Date: 21.AUG.2019 20:18:11

LTE Band 66 5MHz CH-Middle 1GHz~3GHz

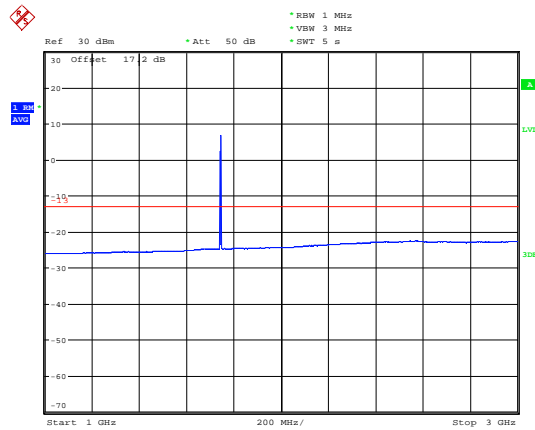

Date: 21.AUG.2019 20:19:52



LTE Band 66 5MHz CH-Low 3GHz~20GHz

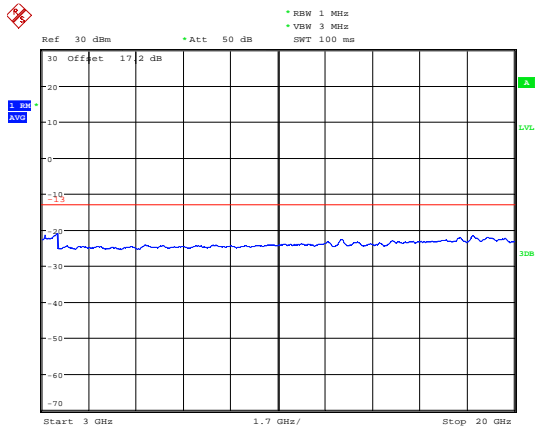

Date: 20.AUG.2019 20:28:44

LTE Band 66 5MHz CH-Middle 3GHz~20GHz

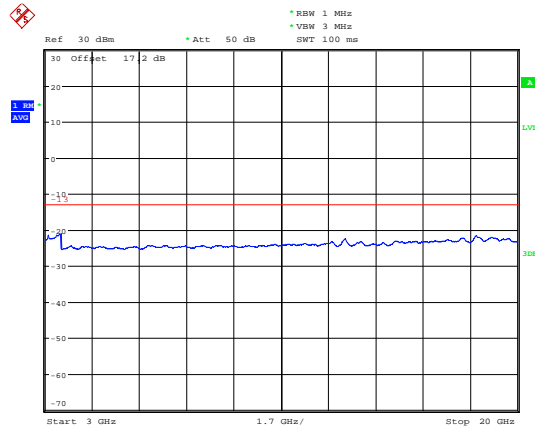

Date: 20.AUG.2019 20:28:56

LTE Band 66 5MHz CH-High 30MHz~1GHz

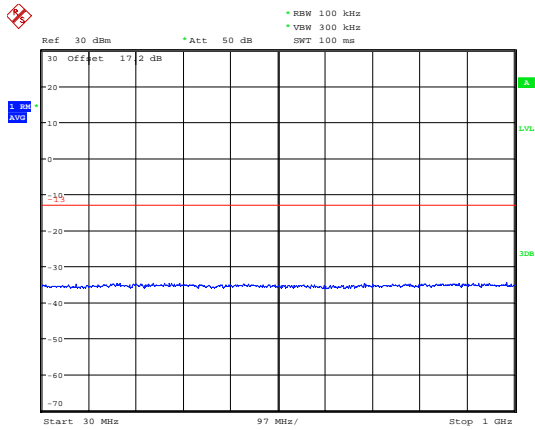

Date: 20.AUG.2019 20:16:41

LTE Band 66 10MHz CH-Low 30MHz~1GHz

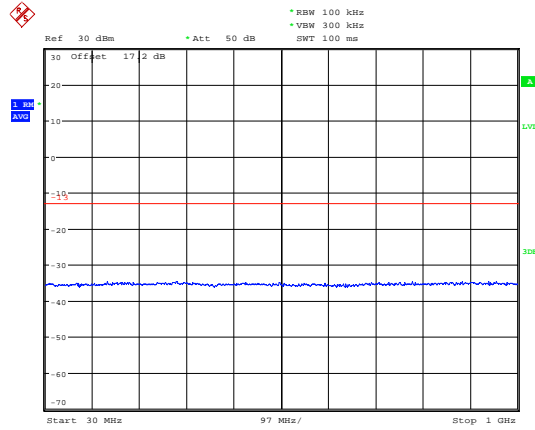

Date: 20.AUG.2019 20:17:02

LTE Band 66 5MHz CH-High 1GHz~3GHz

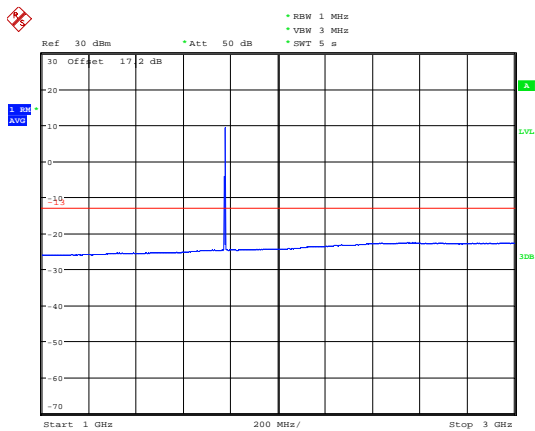

Date: 21.AUG.2019 20:21:30

LTE Band 66 10MHz CH-Low 1GHz~3GHz

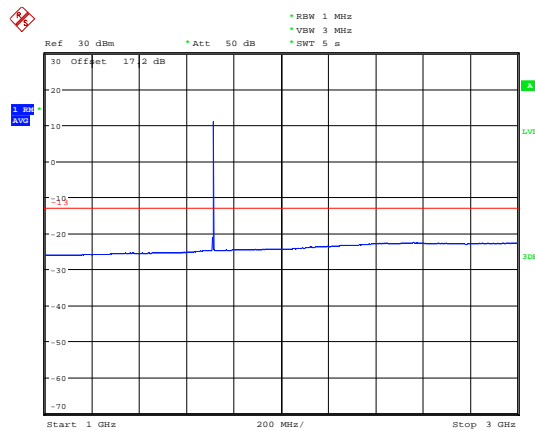

Date: 21.AUG.2019 20:23:02



LTE Band 66 5MHz CH-High 3GHz~20GHz

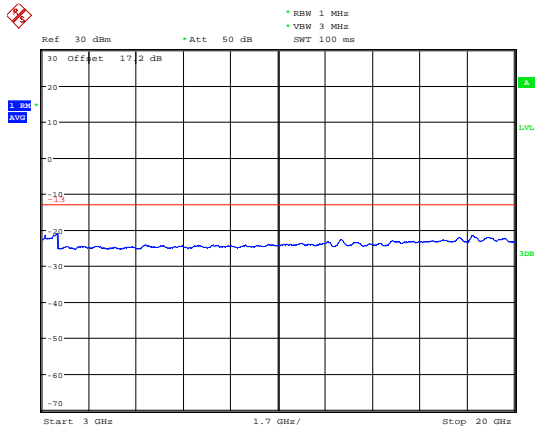

Date: 20.AUG.2019 20:29:10

LTE Band 66 10MHz CH-Low 3GHz~20GHz

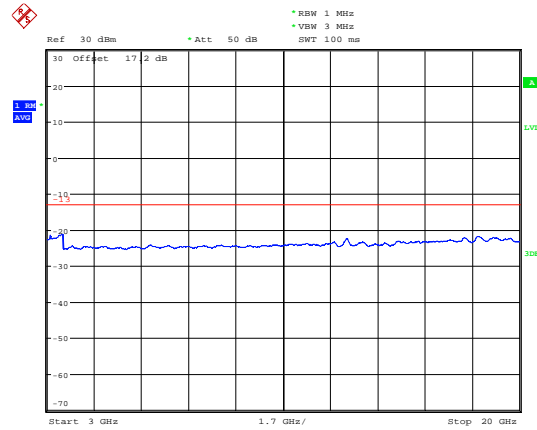

Date: 20.AUG.2019 20:29:37

LTE Band 66 10MHz CH-Middle 30MHz~1GHz

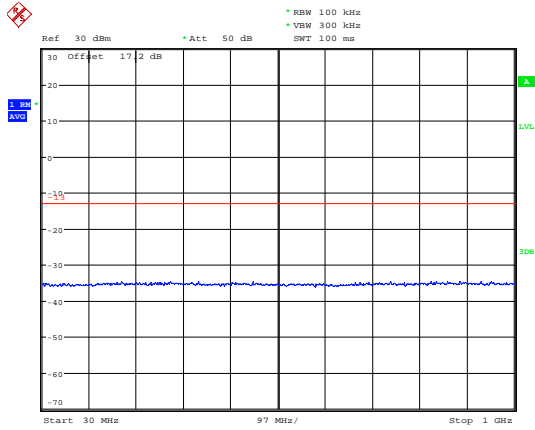

Date: 20.AUG.2019 20:17:32

LTE Band 66 10MHz CH-High 30MHz~1GHz

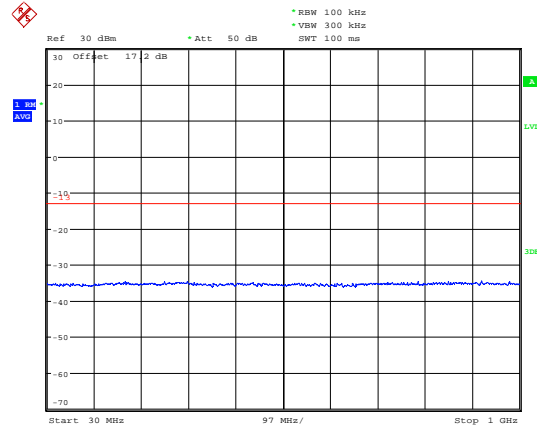

Date: 20.AUG.2019 20:18:41

LTE Band 66 10MHz CH-Middle 1GHz~3GHz

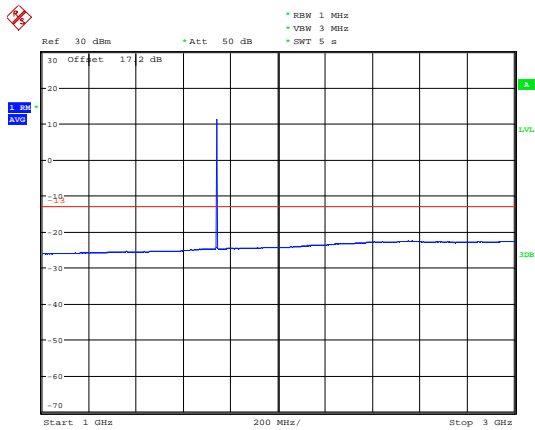

Date: 21.AUG.2019 20:24:30

LTE Band 66 10MHz CH-High 1GHz~3GHz

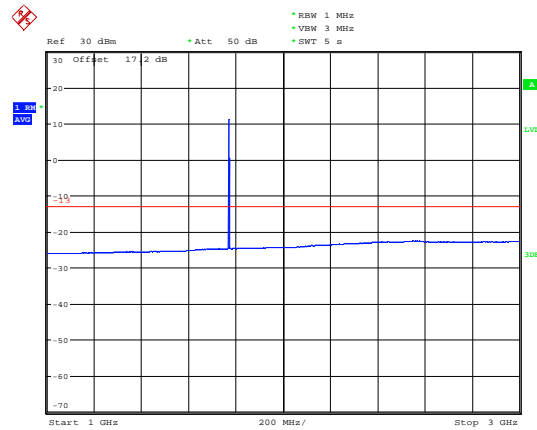

Date: 21.AUG.2019 20:25:11



LTE Band 66 10MHz CH-Middle 3GHz~20GHz

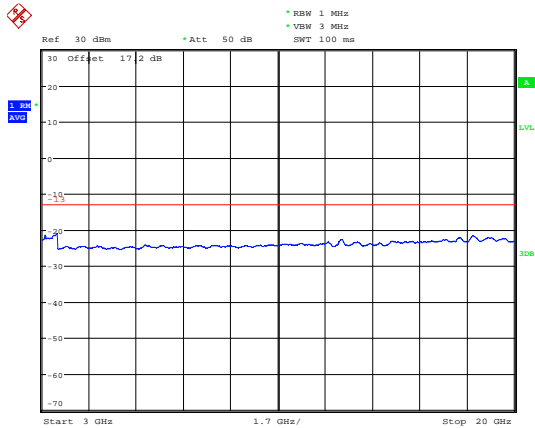

Date: 20.AUG.2019 20:29:58

LTE Band 66 10MHz CH-High 3GHz~20GHz

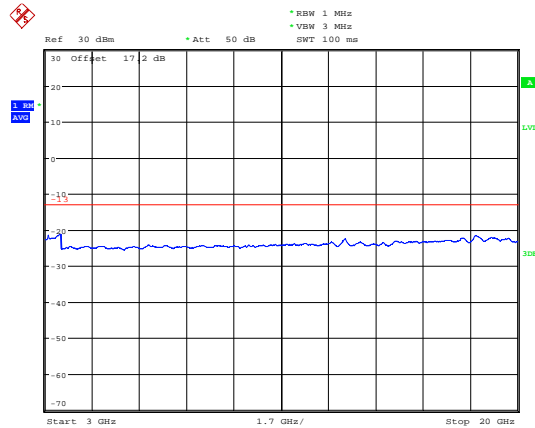

Date: 20.AUG.2019 20:30:16

LTE Band 66 15MHz CH-Low 30MHz~1GHz

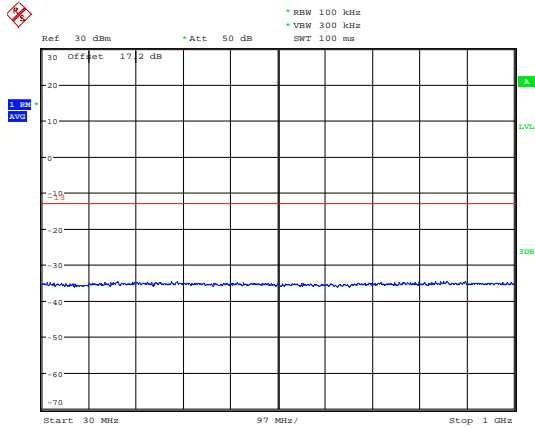

Date: 20.AUG.2019 20:20:19

LTE Band 66 15MHz CH-Middle 30MHz~1GHz

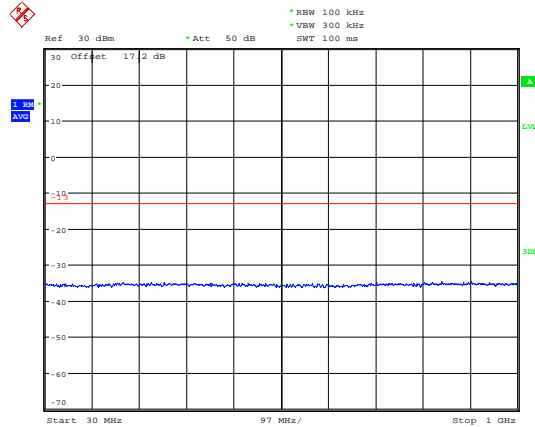

Date: 26.AUG.2019 11:02:56

LTE Band 66 15MHz CH-Low 1GHz~3GHz

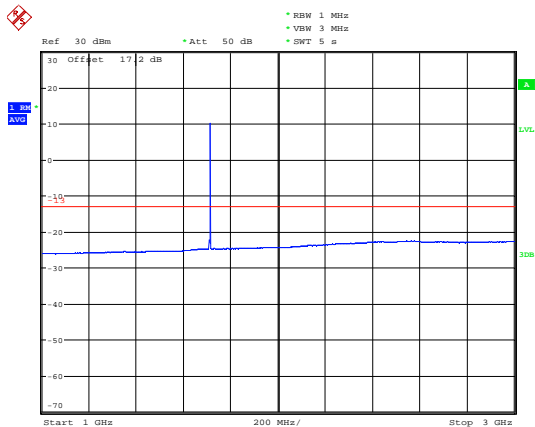

Date: 21.AUG.2019 20:25:54

LTE Band 66 15MHz CH-Middle 1GHz~3GHz

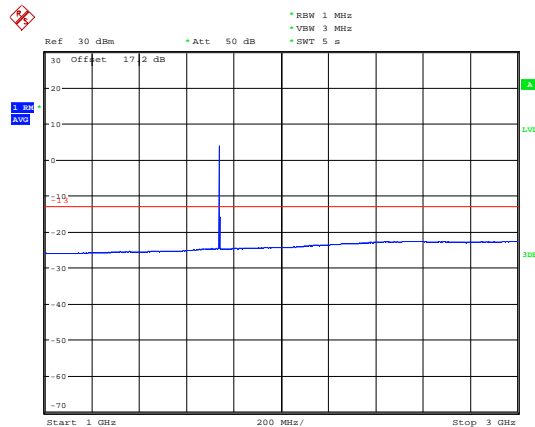

Date: 21.AUG.2019 20:26:48



LTE Band 66 15MHz CH-Low 3GHz~20GHz

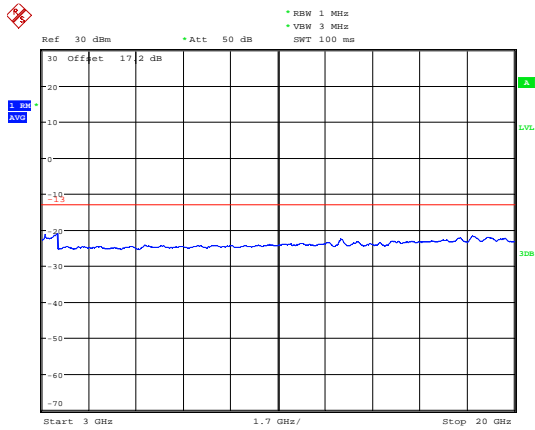

Date: 20.AUG.2019 20:30:36

LTE Band 66 15MHz CH-Middle 3GHz~20GHz

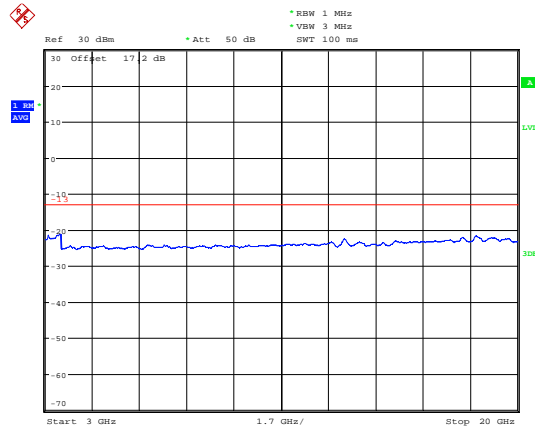

Date: 20.AUG.2019 20:30:57

LTE Band 66 15MHz CH-High 30MHz~1GHz

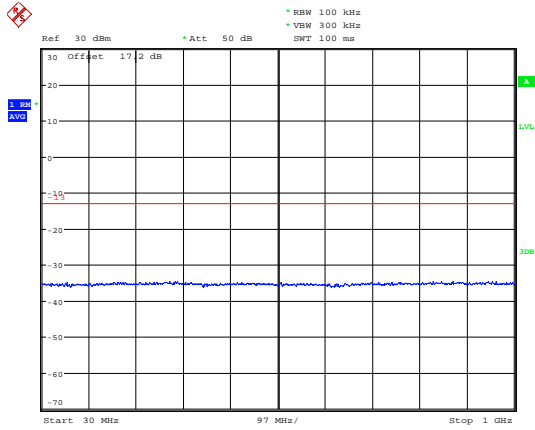

Date: 20.AUG.2019 20:22:29

LTE Band 66 20MHz CH-Low 30MHz~1GHz

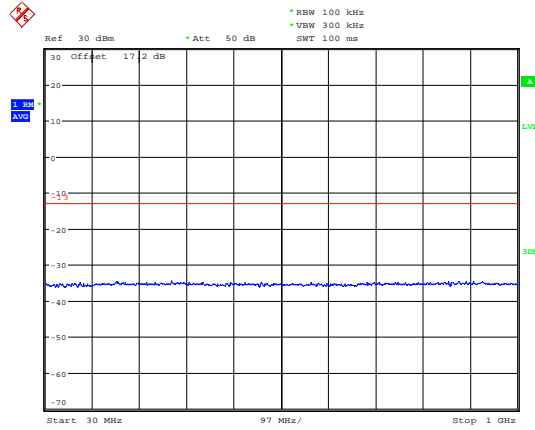

Date: 20.AUG.2019 20:22:57

LTE Band 66 15MHz CH-High 1GHz~3GHz

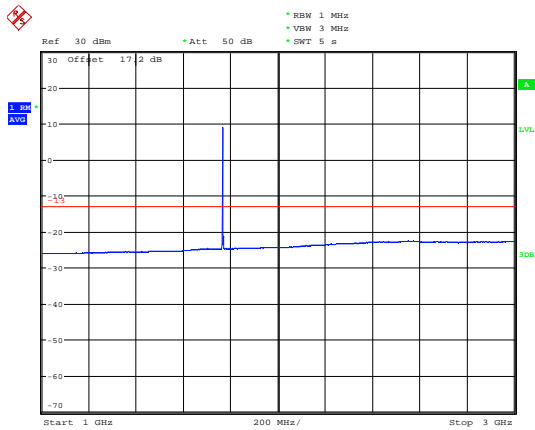

Date: 21.AUG.2019 20:27:21

LTE Band 66 20MHz CH-Low 1GHz~3GHz

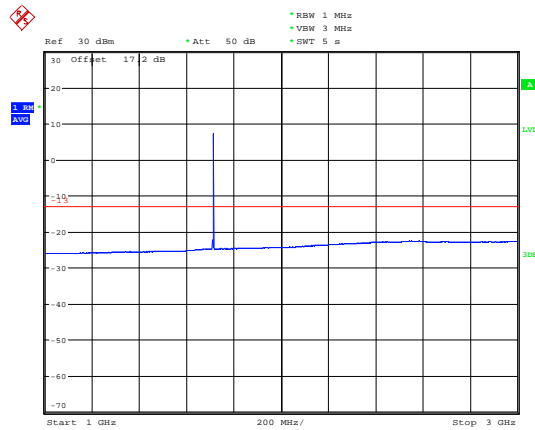

Date: 21.AUG.2019 20:28:00



LTE Band 66 15MHz CH-High 3GHz~20GHz

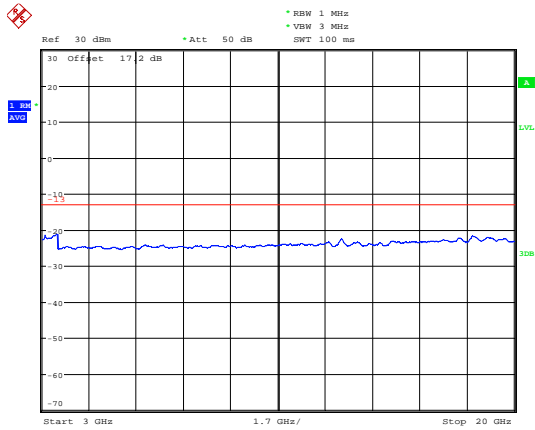

Date: 20.AUG.2019 20:31:12

LTE Band 66 20MHz CH-Low 3GHz~20GHz

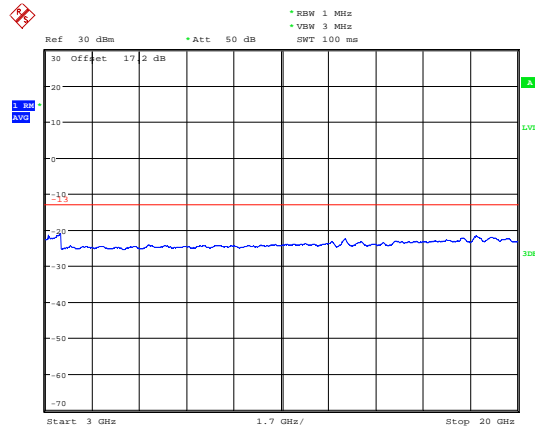

Date: 20.AUG.2019 20:31:32

LTE Band 66 20MHz CH-Middle 30MHz~1GHz

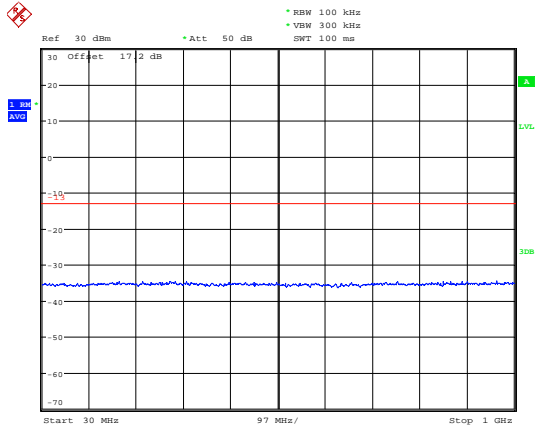

Date: 20.AUG.2019 20:23:32

LTE Band 66 20MHz CH-High 30MHz~1GHz

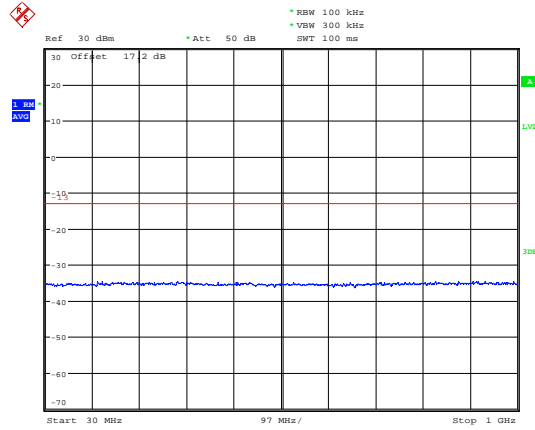

Date: 20.AUG.2019 20:24:17

LTE Band 66 20MHz CH-Middle 1GHz~3GHz

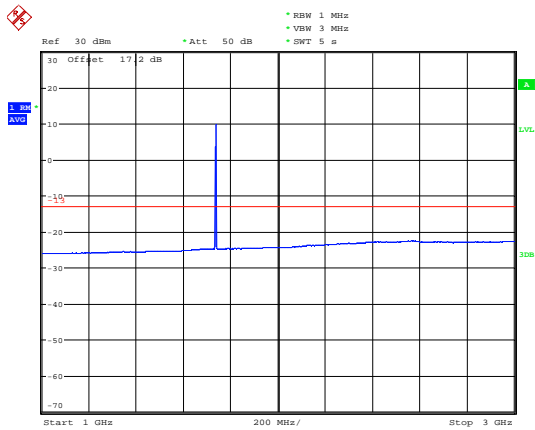

Date: 21.AUG.2019 20:28:30

LTE Band 66 20MHz CH-High 1GHz~3GHz

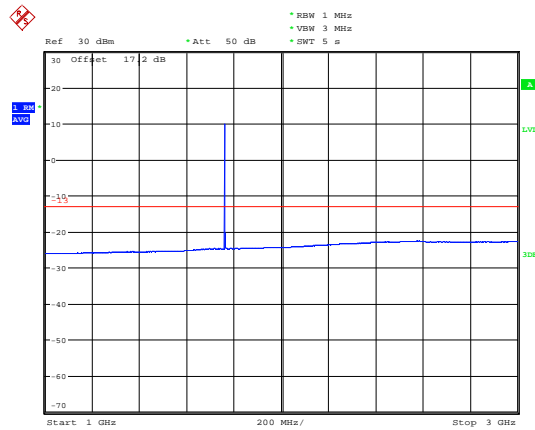

Date: 21.AUG.2019 20:29:01



LTE Band 66 20MHz CH-Middle 3GHz~20GHz

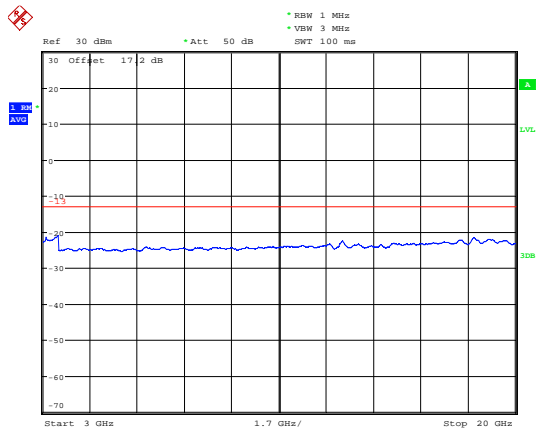

Date: 20.AUG.2019 20:31:54

LTE Band 66 20MHz CH-High 3GHz~20GHz

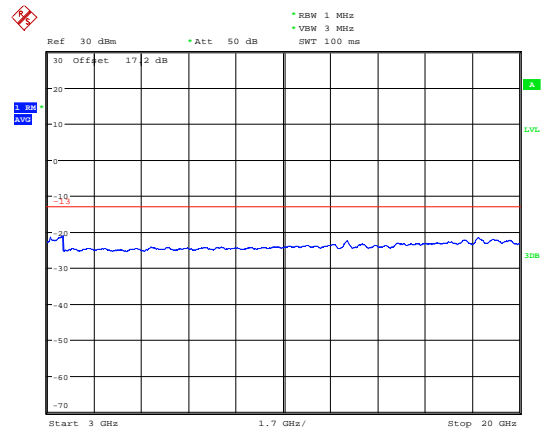

Date: 20.AUG.2019 20:32:04



LTE Band 85 5MHz CH-Low 30MHz~1GHz

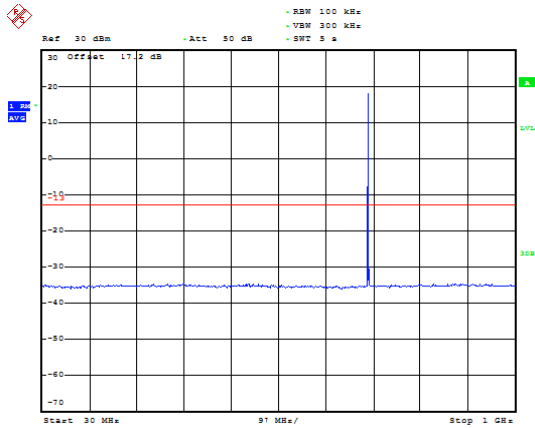

Date: 26.AUG.2019 20:27:58

LTE Band 85 5MHz CH-Low 1GHz~9GHz

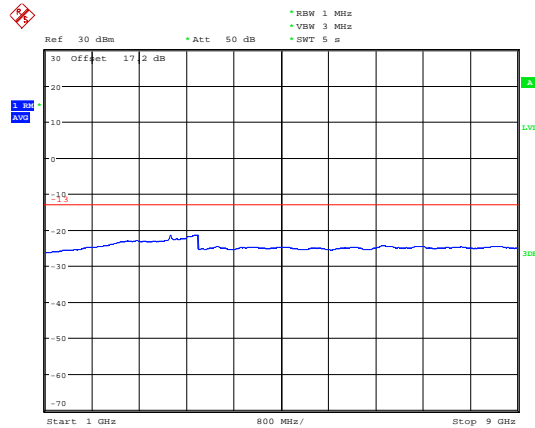

Date: 26.AUG.2019 20:35:15

LTE Band 85 5MHz CH-Middle 30MHz~1GHz

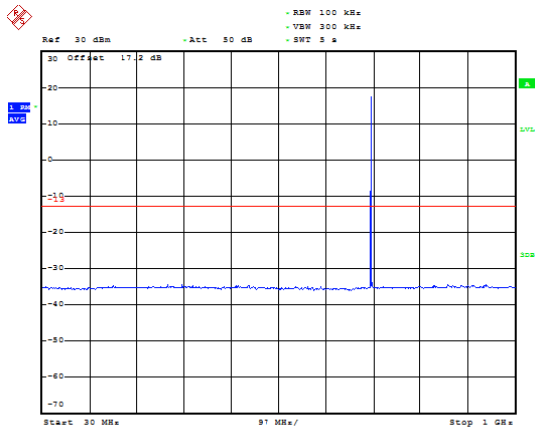

Date: 26.AUG.2019 20:29:10

LTE Band 85 5MHz CH-Middle 1GHz~9GHz

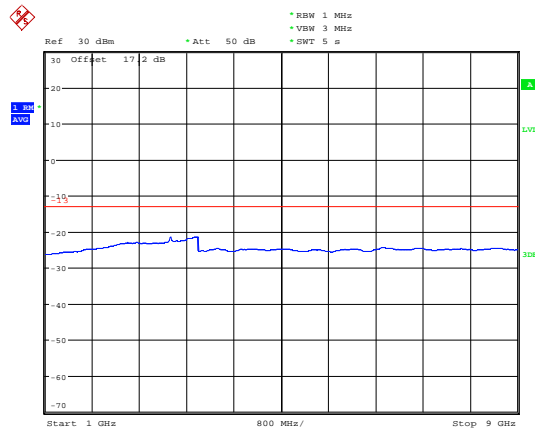

Date: 26.AUG.2019 20:35:30

LTE Band 85 5MHz CH-High 30MHz~1GHz

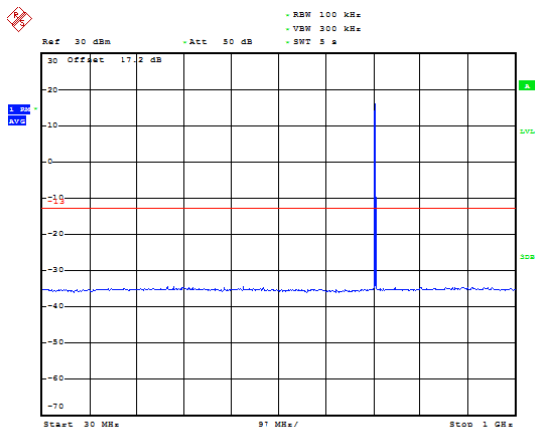

Date: 26.AUG.2019 20:29:51

LTE Band 85 5MHz CH-High 1GHz~9GHz

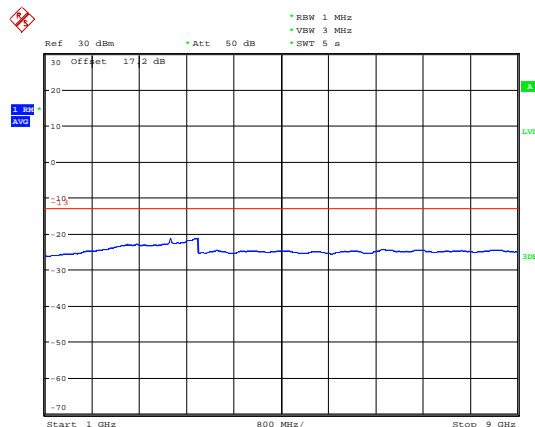

Date: 26.AUG.2019 20:35:58



LTE Band 85 10MHz CH- Low 30MHz~1GHz

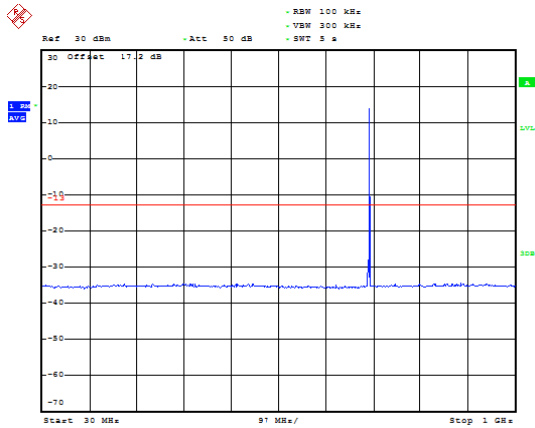

Date: 26.AUG.2019 20:31:55

LTE Band 85 10MHz CH- Low 1GHz~9GHz

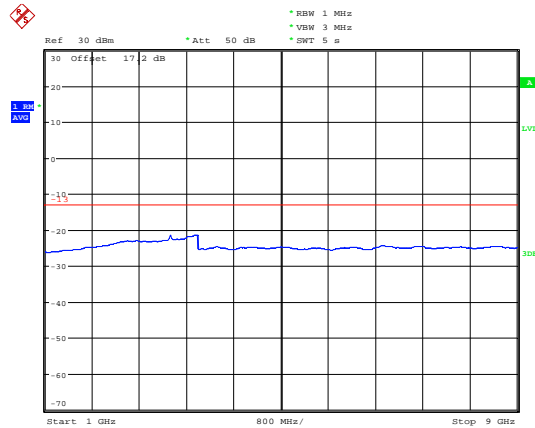

Date: 26.AUG.2019 20:36:21

LTE Band 85 10MHz CH-Middle 30MHz~1GHz

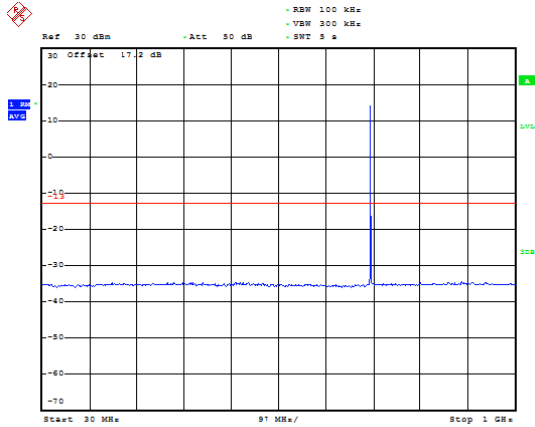

Date: 26.AUG.2019 20:32:40

LTE Band 85 10MHz CH-Middle 1GHz~9GHz

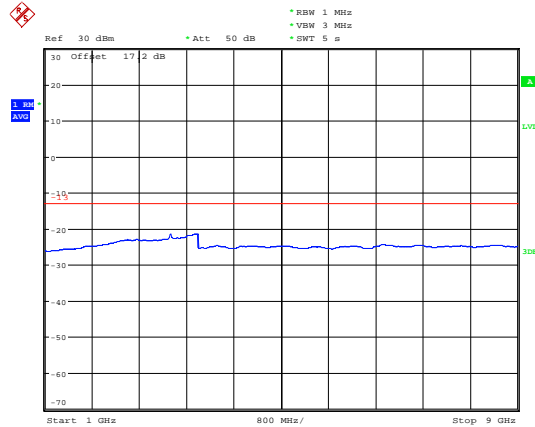

Date: 26.AUG.2019 20:36:43

LTE Band 85 10MHz CH- High 30MHz~1GHz

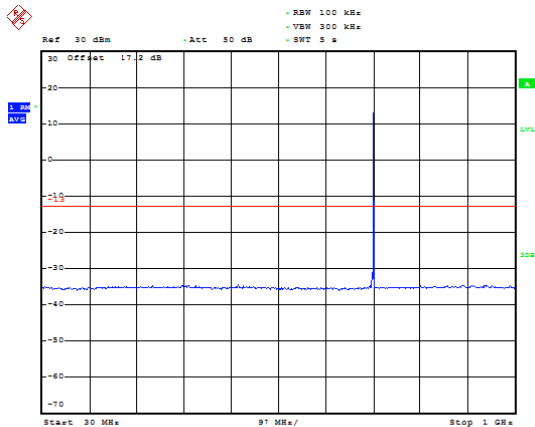

Date: 26.AUG.2019 20:33:29

LTE Band 85 10MHz CH- High 1GHz~9GHz

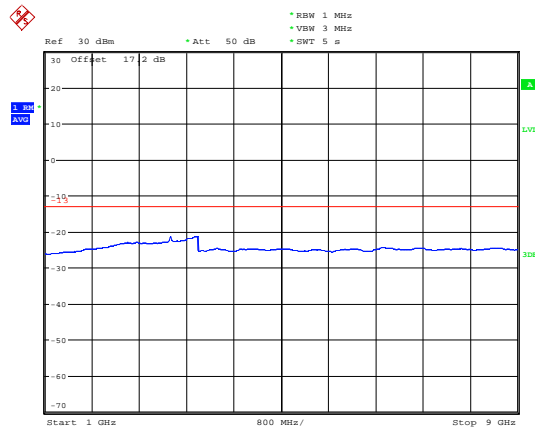

Date: 26.AUG.2019 20:37:07

5.8 Radiates Spurious Emission

Ambient condition

Temperature	Relative humidity	Pressure
23°C ~25°C	45%~50%	101.5kPa

Method of Measurement

1. The testing follows FCC KDB 971168 D01 v03r01 Section 5.8 and ANSI C63.26 (2015).
2. Below 1GHz: The EUT is placed on a turntable 0.8 meters above the ground in the chamber, 3 meter away from the antenna. The maximal emission value is acquired by adjusting the antenna height, polarisation and turntable azimuth. Normally, the height range of antenna is 1 m to 4 m, the azimuth range of turntable is 0° to 360°, and the receive antenna has two polarizations Vertical (V) and Horizontal (H). Above 1GHz: (Note: the FCC's permission to use 1.5m as an alternative per TCBC Conf call of Dec. 2, 2014.) The EUT is placed on a turntable 1.5 meters above the ground in the chamber, 3 meter away from the antenna. The maximal emission value is acquired by adjusting the antenna height, polarisation and turntable azimuth. Normally, the height range of antenna is 1 m to 4 m, the azimuth range of turntable is 0° to 360°, and the receive antenna has two polarizations Vertical (V) and Horizontal (H).
3. A loop antenna, A log-periodic antenna or horn antenna shall be substituted in place of the EUT. The log-periodic antenna will be driven by a signal generator and the level will be adjusted till the same power value on the spectrum analyzer or receiver. The level of the spurious emissions can be calculated through the level of the signal generator, cable loss, the gain of the substitution antenna and the reading of the spectrum analyzer or receiver.
4. The EUT is then put into continuously transmitting mode at its maximum power level during the test. Set Test Receiver or Spectrum RBW=200Hz,VBW=600Hz for 9kHz150kHz , RBW=10kHz, VBW=30kHz 150kHz-30MHz ,RBW=100kHz,VBW=300kHz for 30MHz to 1GHz and RBW=1MHz, VBW=3MHz for above 1GHz And the maximum value of the receiver should be recorded as (Pr).
5. The EUT shall be replaced by a substitution antenna. In the chamber, an substitution antenna for the frequency band of interest is placed at the reference point of the chamber. An RF Signal source for the frequency band of interest is connected to the substitution antenna with a cable that has been constructed to not interfere with the radiation pattern of the antenna. A power (PMea) is applied to the input of the substitution antenna, and adjust the level of the signal generator output until the value of the receiver reach the previously recorded (Pr). The power of signal source (PMea) is recorded. The test should be performed by rotating the test item and adjusting the receiving antenna polarization.
6. A amplifier should be connected to the Signal Source output port. And the cable should be connect between the Amplifier and the Substitution Antenna. The cable loss (Pcl) ,the Substitution Antenna Gain (Ga) and the Amplifier Gain (PAg) should be recorded after test.
7. The measurement results are obtained as described below:
Power(EIRP)=PMea- PAg - Pcl + Ga
The measurement results are amend as described below:
Power(EIRP)=PMea- Pcl + Ga
8. This value is EIRP since the measurement is calibrated using an antenna of known gain (2.15 dBi) and known input power. ERP can be calculated from EIRP by subtracting the gain of the dipole, ERP

= EIRP-2.15dBi.

The modulation mode and RB allocation refer to section 5.1, using the maximum output power configuration.

Test setup

9KHz ~ 30MHz

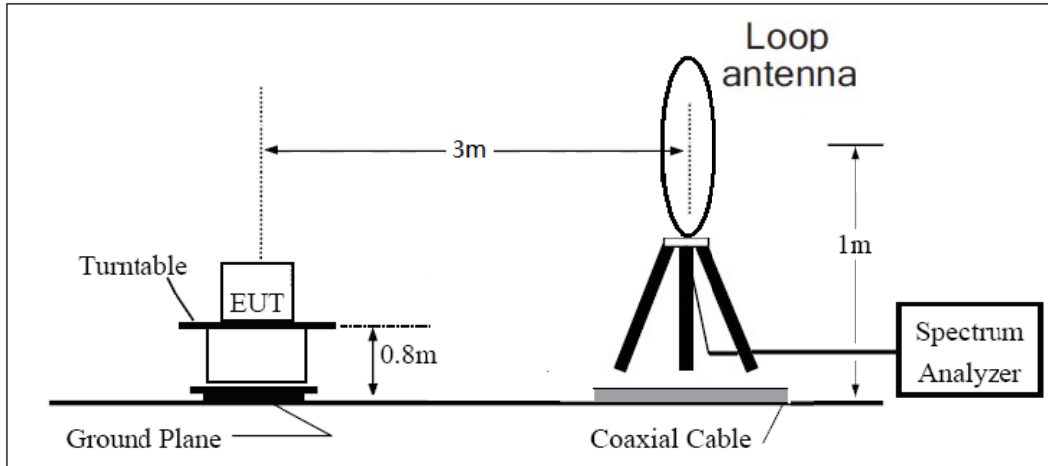

30MHz ~ 1GHz

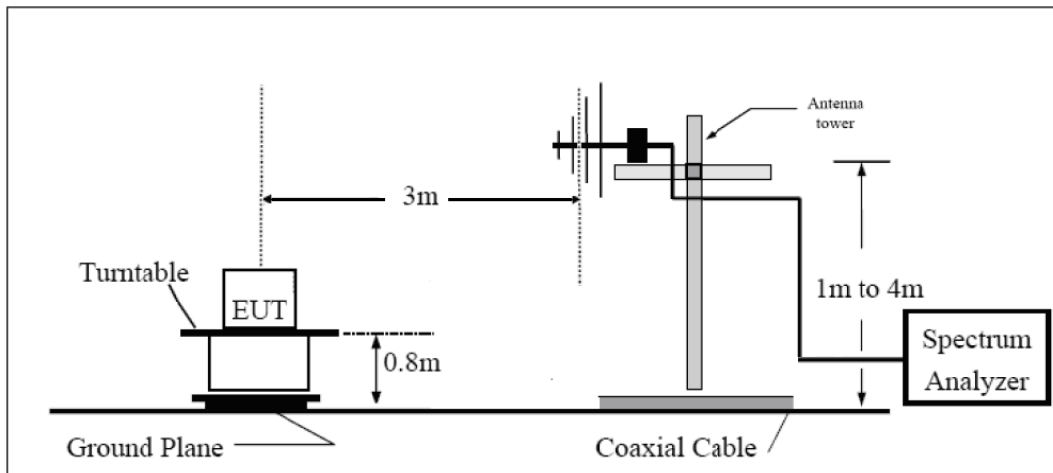

Above 1GHz

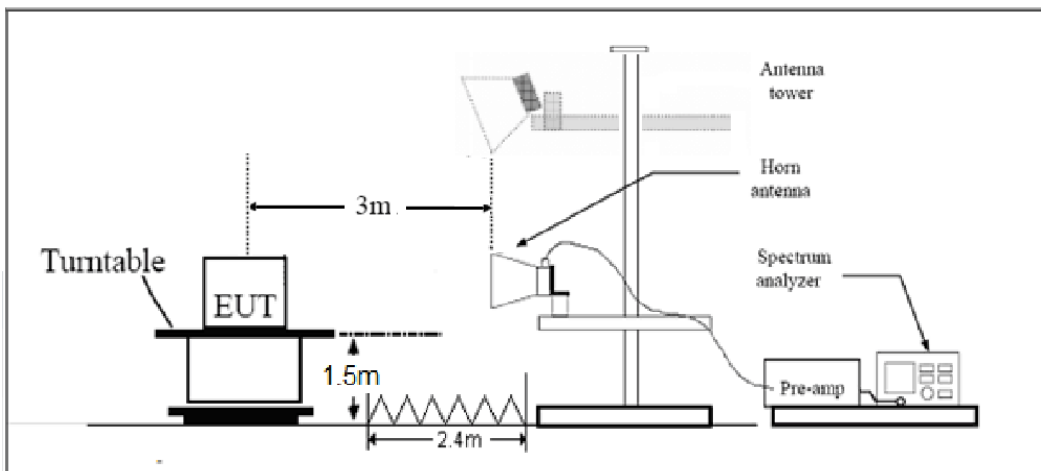

Note: Area side:2.4mX3.6m

**Limits**

Rule Part 27.53(h) specifies that “for operations in the 1695-1710 MHz, 1710-1755 MHz, 1755-1780 MHz, 1915-1920 MHz, 1995-2000 MHz, 2000-2020 MHz, 2110-2155 MHz, 2155-2180 MHz, and 2180-2200 bands, the power of any emission outside a licensee's frequency block shall be attenuated below the transmitter power (P) in watts by at least $43 + 10 \log_{10} (P)$ dB.”

Rule Part 27.53 (g) For operations in the 600 MHz band and the 698-746 MHz band, the power of any emission outside a licensee's frequency band(s) of operation shall be attenuated below the transmitter power (P) within the licensed band(s) of operation, measured in watts, by at least $43 + 10 \log (P)$ dB. Compliance with this provision is based on the use of measurement instrumentation employing a resolution bandwidth of 100 kilohertz or greater. However, in the 100 kilohertz bands immediately outside and adjacent to a licensee's frequency block, a resolution bandwidth of at least 30 kHz may be employed.

Rule Part 27.53(f) For operations in the 746-758 MHz, 775-788 MHz, and 805-806 MHz bands, emissions in the band 1559-1610 MHz shall be limited to -70 dBW/MHz equivalent isotropically radiated power (EIRP) for wideband signals, and -80 dBW EIRP for discrete emissions of less than 700 Hz bandwidth. For the purpose of equipment authorization, a transmitter shall be tested with an antenna that is representative of the type that will be used with the equipment in normal operation.

Part 27.53 (c) For operations in the 746-758 MHz band and the 776-788 MHz band, the power of any emission outside the licensee's frequency band(s) of operation shall be attenuated below the transmitter power (P) within the licensed band(s) of operation, measured in watts, in accordance with the following:

- (1) On any frequency outside the 746-758 MHz band, the power of any emission shall be attenuated outside the band below the transmitter power (P) by at least $43 + 10 \log (P)$ dB;
- (2) On any frequency outside the 776-788 MHz band, the power of any emission shall be attenuated outside the band below the transmitter power (P) by at least $43 + 10 \log (P)$ dB;
- (3) On all frequencies between 763-775 MHz and 793-805 MHz, by a factor not less than $76 + 10 \log (P)$ dB in a 6.25 kHz band segment, for base and fixed stations;
- (4) On all frequencies between 763-775 MHz and 793-805 MHz, by a factor not less than $65 + 10 \log (P)$ dB in a 6.25 kHz band segment, for mobile and portable stations;
- (5) Compliance with the provisions of paragraphs (c)(1) and (c)(2) of this section is based on the use of measurement instrumentation employing a resolution bandwidth of 100 kHz or greater. However, in the 100 kHz bands immediately outside and adjacent to the frequency block, a resolution bandwidth of at least 30 kHz may be employed;

Part 27.53(a)/(h)/(g) Limit		-13 dBm
Part 27.53(f) Limit	Limit out of the band 1559-1610 MHz	-13 dBm
	Limit in the band 1559-1610 MHz	-40 dBm

Measurement Uncertainty

The assessed measurement uncertainty to ensure 95% confidence level for the normal distribution is with the coverage factor $k = \pm 1.96$, $U = \pm 3.55$ dB.

**Test Result**

Sweep the whole frequency band through the range from 9kHz to the 10th harmonic of the carrier, the emissions below the noise floor will not be recorded in the report.

LTE Band 4 QPSK 1.4MHz CH-Middle, RB 1

Harmonic	Frequency (MHz)	SG (dBm)	Cable Loss (dB)	Gain (dBi)	Antenna Polarization	EIRP Level (dBm)	Limit (dBm)	Margin (dB)	Azimuth (deg)
2	3464.3	-51.29	2.6	10.75	Horizontal	-43.14	-13.00	30.14	45
3	5197.5	-56.01	2.4	11.05	Horizontal	-47.36	-13.00	34.36	0
4	6930.0	-53.79	4.5	11.15	Horizontal	-47.14	-13.00	34.14	135
5	8662.5	-48.57	5.1	11.35	Horizontal	-42.32	-13.00	29.32	225
6	10395.0	-49.90	5.3	11.95	Horizontal	-43.25	-13.00	30.25	135
7	12127.5	-49.38	5.5	13.55	Horizontal	-41.33	-13.00	28.33	90
8	13860.0	-52.81	6.3	13.75	Horizontal	-45.36	-13.00	32.36	45
9	15592.5	-46.15	6.7	13.85	Horizontal	-39.00	-13.00	26.00	90
10	17325.0	-46.40	6.8	14.25	Horizontal	-38.95	-13.00	25.95	180

Note: 1.The other Spurious RF Radiated emissions level is no more than noise floor.

2. The worst emission was found in the antenna is Horizontal position.

LTE Band 4 QPSK 5MHz CH-Middle, RB 1

Harmonic	Frequency (MHz)	SG (dBm)	Cable Loss (dB)	Gain (dBi)	Antenna Polarization	EIRP Level (dBm)	Limit (dBm)	Margin (dB)	Azimuth (deg)
2	3460.5	-50.97	2.6	10.75	Horizontal	-42.82	-13.00	29.82	180
3	5191.5	-58.55	2.4	11.05	Horizontal	-49.90	-13.00	36.90	45
4	6930.0	-56.85	4.5	11.15	Horizontal	-50.20	-13.00	37.20	90
5	8662.5	-51.65	5.1	11.35	Horizontal	-45.40	-13.00	32.40	135
6	10395.0	-49.15	5.3	11.95	Horizontal	-42.50	-13.00	29.50	315
7	12127.5	-50.25	5.5	13.55	Horizontal	-42.20	-13.00	29.20	225
8	13860.0	-49.45	6.3	13.75	Horizontal	-42.00	-13.00	29.00	180
9	15592.5	-47.55	6.7	13.85	Horizontal	-40.40	-13.00	27.40	45
10	17325.0	-45.95	6.8	14.25	Horizontal	-38.50	-13.00	25.50	90

Note: 1.The other Spurious RF Radiated emissions level is no more than noise floor.

2. The worst emission was found in the antenna is Horizontal position.



LTE Band 4 QPSK 20MHz CH-Middle, RB 1

Harmonic	Frequency (MHz)	SG (dBm)	Cable Loss (dB)	Gain (dBi)	Antenna Polarization	EIRP Level (dBm)	Limit (dBm)	Margin (dB)	Azimuth (deg)
2	3447.0	-51.16	2.6	10.75	Horizontal	-43.01	-13.00	30.01	45
3	5170.5	-57.55	2.4	11.05	Horizontal	-48.90	-13.00	35.90	90
4	6930.0	-56.75	4.5	11.15	Horizontal	-50.10	-13.00	37.10	180
5	8662.5	-51.55	5.1	11.35	Horizontal	-45.30	-13.00	32.30	0
6	10395.0	-48.80	5.3	11.95	Horizontal	-42.15	-13.00	29.15	0
7	12127.5	-50.15	5.5	13.55	Horizontal	-42.10	-13.00	29.10	135
8	13860.0	-48.37	6.3	13.75	Horizontal	-40.92	-13.00	27.92	45
9	15592.5	-45.05	6.7	13.85	Horizontal	-37.90	-13.00	24.90	90
10	17325.0	-45.35	6.8	14.25	Horizontal	-37.90	-13.00	24.90	180

Note: 1.The other Spurious RF Radiated emissions level is no more than noise floor.
2. The worst emission was found in the antenna is Horizontal position.

LTE Band 12 QPSK 1.4MHz CH-Middle, RB 1

Harmonic	Frequency (MHz)	SG (dBm)	Cable Loss (dB)	Gain (dBi)	Antenna Polarization	ERP Level (dBm)	Limit (dBm)	Margin (dB)	Azimuth (deg)
2	1415.00	-41.05	2.00	10.75	Horizontal	-34.45	-13.00	21.45	45
3	2122.50	-54.99	2.51	11.05	Horizontal	-48.60	-13.00	35.60	90
4	2830.00	-56.68	4.20	11.15	Horizontal	-51.88	-13.00	38.88	45
5	3537.50	-55.37	5.20	11.15	Horizontal	-51.57	-13.00	38.57	90
6	4245.00	-54.55	5.50	11.95	Horizontal	-50.25	-13.00	37.25	180
7	4952.50	-54.34	5.70	13.55	Horizontal	-48.64	-13.00	35.64	0
8	5660.00	-54.91	6.30	13.75	Horizontal	-49.61	-13.00	36.61	45
9	6367.50	-55.30	6.80	13.85	Horizontal	-50.40	-13.00	37.40	90
10	7075.00	-55.50	6.90	14.25	Horizontal	-50.30	-13.00	37.30	0

Note: 1.The other Spurious RF Radiated emissions level is no more than noise floor.
2. The worst emission was found in the antenna is Horizontal position.



LTE Band 12 QPSK 5MHz CH-Middle, RB 1

Harmonic	Frequency (MHz)	SG (dBm)	Cable Loss (dB)	Gain (dBi)	Antenna Polarization	ERP Level (dBm)	Limit (dBm)	Margin (dB)	Azimuth (deg)
2	1415.00	-40.15	2.00	10.75	Horizontal	-33.55	-13.00	20.55	90
3	2122.50	-54.55	2.51	11.05	Horizontal	-48.16	-13.00	35.16	135
4	2830.00	-56.58	4.20	11.15	Horizontal	-51.78	-13.00	38.78	90
5	3537.50	-54.92	5.20	11.15	Horizontal	-51.12	-13.00	38.12	135
6	4245.00	-54.07	5.50	11.95	Horizontal	-49.77	-13.00	36.77	45
7	4952.50	-54.30	5.70	13.55	Horizontal	-48.60	-13.00	35.60	225
8	5660.00	-54.20	6.30	13.75	Horizontal	-48.90	-13.00	35.90	135
9	6367.50	-55.00	6.80	13.85	Horizontal	-50.10	-13.00	37.10	90
10	7075.00	-54.40	6.90	14.25	Horizontal	-49.20	-13.00	36.20	180

Note: 1. The other Spurious RF Radiated emissions level is no more than noise floor.
2. The worst emission was found in the antenna is Horizontal position.

LTE Band 12 QPSK 10MHz CH-Middle, RB 1

Harmonic	Frequency (MHz)	SG (dBm)	Cable Loss (dB)	Gain (dBi)	Antenna Polarization	ERP Level (dBm)	Limit (dBm)	Margin (dB)	Azimuth (deg)
2	1415.00	-39.54	2.00	10.75	Horizontal	-32.94	-13.00	19.94	315
3	2122.50	-54.77	2.51	11.05	Horizontal	-48.38	-13.00	35.38	45
4	2830.00	-56.13	4.20	11.15	Horizontal	-51.33	-13.00	38.33	135
5	3537.50	-56.53	5.20	11.15	Horizontal	-52.73	-13.00	39.73	315
6	4245.00	-53.50	5.50	11.95	Horizontal	-49.20	-13.00	36.20	225
7	4952.50	-55.20	5.70	13.55	Horizontal	-49.50	-13.00	36.50	90
8	5660.00	-53.50	6.30	13.75	Horizontal	-48.20	-13.00	35.20	45
9	6367.50	-55.00	6.80	13.85	Horizontal	-50.10	-13.00	37.10	315
10	7075.00	-55.50	6.90	14.25	Horizontal	-50.30	-13.00	37.30	225

Note: 1. The other Spurious RF Radiated emissions level is no more than noise floor.
2. The worst emission was found in the antenna is Horizontal position.



LTE Band 13 QPSK 5MHz CH-Middle, RB 1

Harmonic	Frequency (MHz)	SG (dBm)	Cable Loss (dB)	Gain (dBi)	Antenna Polarization	ERP Level (dBm)	Limit (dBm)	Margin (dB)	Azimuth (deg)
3	1564.0	-58.81	2.51	11.05	Horizontal	-52.42	-13.00	39.42	45
4	2346.0	-44.51	4.20	11.15	Horizontal	-39.71	-13.00	26.71	90
5	3128.0	-55.89	5.20	11.15	Horizontal	-52.09	-13.00	39.09	0
6	3910.0	-54.48	5.50	11.95	Horizontal	-50.18	-13.00	37.18	90
7	4692.0	-56.07	5.70	13.55	Horizontal	-50.37	-13.00	37.37	45
8	5474.0	-54.92	6.30	13.75	Horizontal	-49.62	-13.00	36.62	225
9	6256.0	-55.02	6.80	13.85	Horizontal	-50.12	-13.00	37.12	91
10	7038.0	-54.40	6.90	14.25	Horizontal	-49.20	-13.00	36.20	135

Note: 1.The other Spurious RF Radiated emissions level is no more than noise floor.

2. The worst emission was found in the antenna is Horizontal position.

LTE Band 13 QPSK 10MHz CH-Middle, RB 1

Harmonic	Frequency (MHz)	SG (dBm)	Cable Loss (dB)	Gain (dBi)	Antenna Polarization	ERP Level (dBm)	Limit (dBm)	Margin (dB)	Azimuth (deg)
2	1555.3	-62.90	2.00	10.75	Horizontal	-52.09	-13.00	39.09	135
3	2346.0	-57.29	2.51	11.05	Horizontal	-40.63	-13.00	27.63	135
4	3128.0	-56.00	4.20	11.15	Horizontal	-51.99	-13.00	38.99	45
5	3910.0	-54.10	5.20	11.15	Horizontal	-50.10	-13.00	37.10	90
6	4692.0	-53.40	5.50	11.95	Horizontal	-50.60	-13.00	37.60	0
7	5474.0	-54.00	5.70	13.55	Horizontal	-49.50	-13.00	36.50	0
8	6256.0	-51.50	6.30	13.75	Horizontal	-47.25	-13.00	34.25	45
9	7038.0	-47.70	6.80	13.85	Horizontal	-49.30	-13.00	36.30	90
10	7820.0	-47.70	6.90	14.25	Horizontal	-47.90	-13.00	34.90	315

Note: 1.The other Spurious RF Radiated emissions level is no more than noise floor.

2. The worst emission was found in the antenna is Horizontal position.

LTE Band 66 QPSK 1.4MHz CH-Middle, RB 1

Harmonic	Frequency (MHz)	SG (dBm)	Cable Loss (dB)	Gain (dBi)	Antenna Polarization	EIRP Level (dBm)	Limit (dBm)	Margin (dB)	Azimuth (deg)
2	3472.1	-53.47	2.6	10.75	Horizontal	-45.32	-13.00	32.32	45
3	5208.4	-56.39	2.4	11.05	Horizontal	-47.74	-13.00	34.74	135
4	6980	-57.68	4.5	11.15	Horizontal	-51.03	-13.00	38.03	270
5	8725	-51.78	5.1	11.35	Horizontal	-45.53	-13.00	32.53	90
6	10470	-49.88	5.3	11.95	Horizontal	-43.23	-13.00	30.23	45
7	12215	-49.27	5.5	13.55	Horizontal	-41.22	-13.00	28.22	0
8	13960	-48.59	6.3	13.75	Horizontal	-41.14	-13.00	28.14	45
9	15705	-49.18	6.7	13.85	Horizontal	-42.03	-13.00	29.03	225
10	17450	-47.85	6.8	14.25	Horizontal	-40.40	-13.00	27.40	90

Note: 1.The other Spurious RF Radiated emissions level is no more than noise floor.
2. The worst emission was found in the antenna is Horizontal position.

LTE Band 66 QPSK 5MHz CH-Middle, RB 1

Harmonic	Frequency (MHz)	SG (dBm)	Cable Loss (dB)	Gain (dBi)	Antenna Polarization	EIRP Level (dBm)	Limit (dBm)	Margin (dB)	Azimuth (deg)
2	3472.1	-53.11	2.6	10.75	Horizontal	-44.96	-13.00	31.96	0
3	5208.4	-55.65	2.4	11.05	Horizontal	-47.00	-13.00	34.00	315
4	6980	-58.15	4.5	11.15	Horizontal	-51.50	-13.00	38.50	135
5	8725	-51.75	5.1	11.35	Horizontal	-45.50	-13.00	32.50	90
6	10470	-49.75	5.3	11.95	Horizontal	-43.10	-13.00	30.10	315
7	12215	-49.15	5.5	13.55	Horizontal	-41.10	-13.00	28.10	135
8	13960	-48.95	6.3	13.75	Horizontal	-41.50	-13.00	28.50	270
9	15705	-50.05	6.7	13.85	Horizontal	-42.90	-13.00	29.90	0
10	17450	-47.81	6.8	14.25	Horizontal	-40.36	-13.00	27.36	90

Note: 1.The other Spurious RF Radiated emissions level is no more than noise floor.
2. The worst emission was found in the antenna is Horizontal position.



LTE Band 66 QPSK 20MHz CH-Middle, RB 1

Harmonic	Frequency (MHz)	SG (dBm)	Cable Loss (dB)	Gain (dBi)	Antenna Polarization	EIRP Level (dBm)	Limit (dBm)	Margin (dB)	Azimuth (deg)
2	3472.1	-51.67	2.6	10.75	Horizontal	-43.52	-13.00	30.52	90
3	5208.4	-55.85	2.4	11.05	Horizontal	-47.20	-13.00	34.20	45
4	6980	-58.45	4.5	11.15	Horizontal	-51.80	-13.00	38.80	315
5	8725	-51.85	5.1	11.35	Horizontal	-45.60	-13.00	32.60	135
6	10470	-50.45	5.3	11.95	Horizontal	-43.80	-13.00	30.80	0
7	12215	-49.05	5.5	13.55	Horizontal	-41.00	-13.00	28.00	315
8	13960	-48.75	6.3	13.75	Horizontal	-41.30	-13.00	28.30	270
9	15705	-49.15	6.7	13.85	Horizontal	-42.00	-13.00	29.00	225
10	17450	-47.55	6.8	14.25	Horizontal	-40.10	-13.00	27.10	0

Note: 1.The other Spurious RF Radiated emissions level is no more than noise floor.
2. The worst emission was found in the antenna is Horizontal position.

LTE Band 85 QPSK 5MHz CH-Middle, RB 1

Harmonic	Frequency (MHz)	SG (dBm)	Cable Loss (dB)	Gain (dBi)	Antenna Polarization	ERP Level (dBm)	Limit (dBm)	Margin (dB)	Azimuth (deg)
2	1414.0	-35.42	2.00	10.75	Horizontal	-28.82	-13.00	15.82	45
3	2121.0	-49.85	2.51	11.05	Horizontal	-43.46	-13.00	30.46	90
4	3535.0	-58.31	4.20	11.15	Horizontal	-53.51	-13.00	40.51	135
5	4242.0	-51.97	5.20	11.15	Horizontal	-48.17	-13.00	35.17	90
6	4949.0	-58.97	5.50	11.95	Horizontal	-54.67	-13.00	41.67	135
7	5656.0	-58.81	5.70	13.55	Horizontal	-53.11	-13.00	40.11	180
8	6363.0	-60.13	6.30	13.75	Horizontal	-54.83	-13.00	41.83	0
9	7070.0	-58.51	6.80	13.85	Horizontal	-53.61	-13.00	40.61	45
10	3535.0	-55.17	6.90	14.25	Horizontal	-49.97	-13.00	36.97	135

Note: 1.The other Spurious RF Radiated emissions level is no more than noise floor.
2. The worst emission was found in the antenna is Horizontal position.



LTE Band 85 QPSK 10MHz CH-Middle, RB 1

Harmonic	Frequency (MHz)	SG (dBm)	Cable Loss (dB)	Gain (dBi)	Antenna Polarization	ERP Level (dBm)	Limit (dBm)	Margin (dB)	Azimuth (deg)
2	1414.0	-40.57	2.00	10.75	Horizontal	-33.97	-13.00	20.97	90
3	2121.0	-49.85	2.51	11.05	Horizontal	-43.46	-13.00	30.46	315
4	3535.0	-55.42	4.20	11.15	Horizontal	-50.62	-13.00	37.62	225
5	4242.0	-52.39	5.20	11.15	Horizontal	-48.59	-13.00	35.59	90
6	4949.0	-59.75	5.50	11.95	Horizontal	-55.45	-13.00	42.45	135
7	5656.0	-61.25	5.70	13.55	Horizontal	-55.55	-13.00	42.55	45
8	6363.0	-60.21	6.30	13.75	Horizontal	-54.91	-13.00	41.91	315
9	7070.0	-57.80	6.80	13.85	Horizontal	-52.90	-13.00	39.90	225
10	3535.0	-54.80	6.90	14.25	Horizontal	-49.60	-13.00	36.60	45

Note: 1. The other Spurious RF Radiated emissions level is no more than noise floor.

2. The worst emission was found in the antenna is Horizontal position.



6 Main Test Instruments

Name	Manufacturer	Type	Serial Number	Calibration Date	Expiration Date
Base Station Simulator	R&S	CMW500	113824	2019-05-19	2020-05-18
Power Splitter	Hua Xiang	SHX-GF2-2-13	10120101	/	/
Spectrum Analyzer	Key sight	N9010A	MY50210259	2019-05-19	2020-05-18
Signal Analyzer	R&S	FSV30	100815	2018-12-16	2019-12-15
Loop Antenna	SCHWARZBECK	FMZB1519	1519-047	2017-09-26	2019-09-25
Trilog Antenna	SCHWARZBECK	VUBL 9163	9163-201	2017-11-18	2019-11-17
Horn Antenna	R&S	HF907	100126	2018-07-07	2020-07-06
Horn Antenna	ETS-Lindgren	3160-09	00102643	2018-06-20	2020-06-19
Signal generator	R&S	SMB 100A	102594	2019-05-19	2020-05-18
Climatic Chamber	ESPEC	SU-242	93000506	2017-12-17	2020-12-16
Preamplifier	R&S	SCU18	102327	2019-05-19	2020-05-18
MOB COMMS DC SUPPLY	Keysight	66319D	MY43004105	2019-05-19	2020-05-18
RF Cable	Agilent	SMA 15cm	0001	2019-06-14	2019-09-13
Software	R&S	EMC32	9.26.0	/	/

*****END OF REPORT *****