

TEST REPORT

Applicant: DTEN Inc
Address of Applicant: 97 E. Brokaw Road, Suite 180, San Jose, CA 95112, United States
Manufacturer/Factory: DTEN Inc
Address of Manufacturer/Factory: 97 E. Brokaw Road, Suite 180, San Jose, CA 95112, United States
Equipment Under Test (EUT)
Product Name: DTEN Mate
Model No.: DBA13310
Trade Mark: DTEN
FCC ID: 2AQ7Q-DBA13310
Applicable standards: FCC CFR Title 47 Part 15 Subpart C Section 15.247
Date of sample receipt: Dec. 04, 2020
Date of Test: Dec. 04, 2020~Mar. 11, 2021
Date of report issued: Mar. 12, 2021
Test Result : PASS *

* In the configuration tested, the EUT complied with the standards specified above.

Authorized Signature:



Robinson Lo

Laboratory Manager

This results shown in this test report refer only to the sample(s) tested, this test report cannot be reproduced, except in full, without prior written permission of the company. The report would be invalid without specific stamp of test institute and the signatures of compiler and approver.

2 Version

Version No.	Date	Description
00	Mar. 12, 2021	Original

Prepared By:



Date:

Mar. 12, 2021

Tested/Project Engineer

Check By:



Reviewer

Date:

Mar. 12, 2021

3 Contents

	Page
1 COVER PAGE.....	1
2 VERSION.....	2
3 CONTENTS.....	3
4 TEST SUMMARY.....	4
5 GENERAL INFORMATION.....	5
5.1 GENERAL DESCRIPTION OF EUT.....	5
5.2 TEST MODE.....	6
5.3 DESCRIPTION OF SUPPORT UNITS.....	6
5.4 DEVIATION FROM STANDARDS.....	6
5.5 ABNORMALITIES FROM STANDARD CONDITIONS.....	6
5.6 TEST FACILITY.....	6
5.7 TEST LOCATION.....	6
5.8 ADDITIONAL INSTRUCTIONS.....	6
6 TEST INSTRUMENTS LIST.....	7
7 TEST RESULTS AND MEASUREMENT DATA.....	9
7.1 ANTENNA REQUIREMENT.....	9
7.2 CONDUCTED EMISSIONS.....	10
7.3 CONDUCTED PEAK OUTPUT POWER.....	13
7.4 CHANNEL BANDWIDTH.....	14
7.5 POWER SPECTRAL DENSITY.....	17
7.6 BAND EDGES.....	20
7.6.1 Conducted Emission Method.....	20
7.6.2 Radiated Emission Method.....	23
7.7 SPURIOUS EMISSION.....	28
7.7.1 Conducted Emission Method.....	28
7.7.2 Radiated Emission Method.....	31
8 TEST SETUP PHOTO.....	48
9 EUT CONSTRUCTIONAL DETAILS.....	48

4 Test Summary

Test Item	Section	Result
Antenna requirement	FCC part 15.203/15.247 (c)	Pass
AC Power Line Conducted Emission	FCC part 15.207	Pass
Conducted Peak Output Power	FCC part 15.247 (b)(3)	Pass
Channel Bandwidth & 99% OCB	FCC part 15.247 (a)(2)	Pass
Power Spectral Density	FCC part 15.247 (e)	Pass
Conducted Unwanted emissions and Bandedge	FCC part 15.247(d)	Pass
Radiated Emission and Restrict Bands	FCC part 15.205/15.209	Pass

Remark: Test according to ANSI C63.10:2013 and RSS-Gen

Pass: The EUT complies with the essential requirements in the standard.

Measurement Uncertainty

Test Item	Frequency Range	Measurement Uncertainty	Notes
Radiated Emission	0.009MHz-30MHz	3.1dB	(1)
Radiated Emission	30MHz-200MHz	3.8039dB	(1)
Radiated Emission	200MHz-1GHz	3.9679dB	(1)
Radiated Emission	1GHz-18GHz	4.29dB	(1)
Radiated Emission	18GHz-40GHz	3.30dB	(1)
AC Power Line Conducted Emission	0.15MHz ~ 30MHz	3.44dB	(1)

Note (1): The measurement uncertainty is for coverage factor of k=2 and a level of confidence of 95%.

5 General Information

5.1 General Description of EUT

Product Name:	DTEN Mate
Model No.:	DBA13310
Serial No.:	N/A
Hardware version:	K-MATE-V1.0
Software version:	20200930
Test sample(s) ID:	GTSL202103000144-01
Sample(s) Status	Engineer sample
Channel numbers:	802.11b/802.11g /802.11n(HT20): 11 802.11n(HT40):7
Channel separation:	5MHz
Modulation technology:	802.11b: Direct Sequence Spread Spectrum (DSSS) 802.11g/802.11n(HT20)/802.11n(HT40): Orthogonal Frequency Division Multiplexing (OFDM)
Antenna Type:	FPCB antenna
Antenna gain:	3.21dBi
Power supply:	FJ-SW2120502400U INPUT: 100-240V~ 50/60Hz 0.4A OUTPUT: DC 5V 2.4A

Operation Frequency each of channel							
Channel	Frequency	Channel	Frequency	Channel	Frequency	Channel	Frequency
1	2412MHz	4	2427MHz	7	2442MHz	10	2457MHz
2	2417MHz	5	2432MHz	8	2447MHz	11	2462MHz
3	2422MHz	6	2437MHz	9	2452MHz	X	

Note:

In section 15.31(m), regards to the operating frequency range over 10 MHz, the Lowest frequency, the middle frequency, and the highest frequency of channel were selected to perform the test, and the selected channel see below:

Test channel	Frequency (MHz)	
	802.11b/802.11g/802.11n(HT20)	802.11n(HT40)
Lowest channel	2412MHz	2422MHz
Middle channel	2437MHz	2437MHz
Highest channel	2462MHz	2452MHz

5.2 Test mode

Transmitting mode	Keep the EUT in continuously transmitting mode
<i>Remark: During the test, the dutycycle >98%, the test voltage was tuned from 85% to 115% of the nominal rated supply voltage, and found that the worst case was under the nominal rated supply condition. So the report just shows that condition's data. New battery is used during all test.</i>	

We have verified the construction and function in typical operation. All the test modes were carried out with the EUT in transmitting operation, which was shown in this test report and defined as follows:				
Pre-scan all kind of data rate in lowest channel, and found the follow list which it was worst case.				
Mode	802.11b	802.11g	802.11n(HT20)	802.11n(HT40)
Data rate	1Mbps	6Mbps	6.5Mbps	13Mbps

5.3 Description of Support Units

Manufacturer	Description	Model	Serial Number
/	/	/	/

5.4 Deviation from Standards

None.

5.5 Abnormalities from Standard Conditions

None.

5.6 Test Facility

<p>The test facility is recognized, certified, or accredited by the following organizations:</p> <ul style="list-style-type: none"> ● FCC —Registration No.: 381383 Global United Technology Services Co., Ltd., Shenzhen EMC Laboratory has been registered and fully described in a report filed with the (FCC) Federal Communications Commission. The acceptance letter from the FCC is maintained in files. Registration 381383. Designation Number: CN5029 ● IC —Registration No.: 9079A The 3m Semi-anechoic chamber of Global United Technology Services Co., Ltd. has been registered by Certification and Engineering Bureau of Industry Canada for radio equipment testing with Registration No.: 9079A ● NVLAP (LAB CODE:600179-0) Global United Technology Services Co., Ltd., is accredited by the National Voluntary Laboratory Accreditation Program (NVLAP). LAB CODE:600179-0
--

5.7 Test Location

All tests were performed at:
<p>Global United Technology Services Co., Ltd. Address: No. 123-128, Tower A, Jinyuan Business Building, No.2, Laodong Industrial Zone, Xixiang Road, Baoan District, Shenzhen, Guangdong, China 518102 Tel: 0755-27798480 Fax: 0755-27798960</p>

5.8 Additional Instructions

Test Software	Special test command provided by manufacturer
Power level setup	Default

6 Test Instruments list

Radiated Emission:						
Item	Test Equipment	Manufacturer	Model No.	Inventory No.	Cal.Date (mm-dd-yy)	Cal.Due date (mm-dd-yy)
1	3m Semi- Anechoic Chamber	ZhongYu Electron	9.2(L)*6.2(W)* 6.4(H)	GTS250	July. 02 2020	July. 01 2025
2	Control Room	ZhongYu Electron	6.2(L)*2.5(W)* 2.4(H)	GTS251	N/A	N/A
3	EMI Test Receiver	Rohde & Schwarz	ESU26	GTS203	June. 25 2020	June. 24 2021
4	BiConiLog Antenna	SCHWARZBECK MESS-ELEKTRONIK	VULB9163	GTS214	June. 25 2020	June. 24 2021
5	Double -ridged waveguide horn	SCHWARZBECK MESS-ELEKTRONIK	BBHA 9120 D	GTS208	June. 25 2020	June. 24 2021
6	Horn Antenna	ETS-LINDGREN	3160	GTS217	June. 25 2020	June. 24 2021
7	EMI Test Software	AUDIX	E3	N/A	N/A	N/A
8	Coaxial Cable	GTS	N/A	GTS213	June. 25 2020	June. 24 2021
9	Coaxial Cable	GTS	N/A	GTS211	June. 25 2020	June. 24 2021
10	Coaxial cable	GTS	N/A	GTS210	June. 25 2020	June. 24 2021
11	Coaxial Cable	GTS	N/A	GTS212	June. 25 2020	June. 24 2021
12	Amplifier(100kHz-3GHz)	HP	8347A	GTS204	June. 25 2020	June. 24 2021
13	Amplifier(2GHz-20GHz)	HP	84722A	GTS206	June. 25 2020	June. 24 2021
14	Amplifier (18-26GHz)	Rohde & Schwarz	AFS33-18002 650-30-8P-44	GTS218	June. 25 2020	June. 24 2021
15	Band filter	Amindeon	82346	GTS219	June. 25 2020	June. 24 2021
16	Power Meter	Anritsu	ML2495A	GTS540	June. 25 2020	June. 24 2021
17	Power Sensor	Anritsu	MA2411B	GTS541	June. 25 2020	June. 24 2021
18	Wideband Radio Communication Tester	Rohde & Schwarz	CMW500	GTS575	June. 25 2020	June. 24 2021
19	Splitter	Agilent	11636B	GTS237	June. 25 2020	June. 24 2021
20	Loop Antenna	ZHINAN	ZN30900A	GTS534	June. 25 2020	June. 24 2021
21	Breitband hornantenne	SCHWARZBECK	BBHA 9170	GTS579	Oct. 19 2020	Oct. 18 2021
22	Amplifier	TDK	PA-02-02	GTS574	Oct. 19 2020	Oct. 18 2021
23	Amplifier	TDK	PA-02-03	GTS576	Oct. 19 2020	Oct. 18 2021
24	PSA Series Spectrum Analyzer	Rohde & Schwarz	FSP	GTS578	June. 25 2020	June. 24 2021

Conducted Emission						
Item	Test Equipment	Manufacturer	Model No.	Inventory No.	Cal.Date (mm-dd-yy)	Cal.Due date (mm-dd-yy)
1	Shielding Room	ZhongYu Electron	7.3(L)x3.1(W)x2.9(H)	GTS252	May.15 2019	May.14 2022
2	EMI Test Receiver	R&S	ESCI 7	GTS552	June. 25 2020	June. 24 2021
3	Coaxial Switch	ANRITSU CORP	MP59B	GTS225	June. 25 2020	June. 24 2021
4	ENV216 2-L-V-NETZNACHB.DE	ROHDE&SCHWARZ	ENV216	GTS226	June. 25 2020	June. 24 2021
5	Coaxial Cable	GTS	N/A	GTS227	N/A	N/A
6	EMI Test Software	AUDIX	E3	N/A	N/A	N/A
7	Thermo meter	KTJ	TA328	GTS233	June. 25 2020	June. 24 2021
8	Absorbing clamp	Elektronik-Feinmechanik	MDS21	GTS229	June. 25 2020	June. 24 2021
9	ISN	SCHWARZBECK	NTFM 8158	GTD565	June. 25 2020	June. 24 2021

RF Conducted Test:						
Item	Test Equipment	Manufacturer	Model No.	Serial No.	Cal.Date (mm-dd-yy)	Cal.Due date (mm-dd-yy)
1	MXA Signal Analyzer	Agilent	N9020A	GTS566	June. 25 2020	June. 24 2021
2	EMI Test Receiver	R&S	ESCI 7	GTS552	June. 25 2020	June. 24 2021
3	Spectrum Analyzer	Agilent	E4440A	GTS533	June. 25 2020	June. 24 2021
4	MXG vector Signal Generator	Agilent	N5182A	GTS567	June. 25 2020	June. 24 2021
5	ESG Analog Signal Generator	Agilent	E4428C	GTS568	June. 25 2020	June. 24 2021
6	USB RF Power Sensor	DARE	RPR3006W	GTS569	June. 25 2020	June. 24 2021
7	RF Switch Box	Shongyi	RFSW3003328	GTS571	June. 25 2020	June. 24 2021
8	Programmable Constant Temp & Humi Test Chamber	WEWON	WHTH-150L-40-880	GTS572	June. 25 2020	June. 24 2021

General used equipment:						
Item	Test Equipment	Manufacturer	Model No.	Inventory No.	Cal.Date (mm-dd-yy)	Cal.Due date (mm-dd-yy)
1	Humidity/ Temperature Indicator	KTJ	TA328	GTS243	June. 25 2020	June. 24 2021
2	Barometer	ChangChun	DYM3	GTS255	June. 25 2020	June. 24 2021

7 Test results and Measurement Data

7.1 Antenna requirement

Standard requirement:	FCC Part15 C Section 15.203 /247(c)
<p>15.203 requirement:</p> <p>An intentional radiator shall be designed to ensure that no antenna other than that furnished by the responsible party shall be used with the device. The use of a permanently attached antenna or of an antenna that uses a unique coupling to the intentional radiator, the manufacturer may design the unit so that a broken antenna can be replaced by the user, but the use of a standard antenna jack or electrical connector is prohibited.</p> <p>15.247(c) (1)(i) requirement:</p> <p>(i) Systems operating in the 2400-2483.5 MHz band that is used exclusively for fixed. Point-to-point operations may employ transmitting antennas with directional gain greater than 6dBi provided the maximum conducted output power of the intentional radiator is reduced by 1 dB for every 3 dB that the directional gain of the antenna exceeds 6dBi.</p>	
EUT Antenna:	
<p><i>The antenna is FPC antenna, the best case gain of the antenna is 3.21dBi, reference to the appendix II for details</i></p>	

7.2 Conducted Emissions

Test Requirement:	FCC Part15 C Section 15.207					
Test Method:	ANSI C63.10:2013					
Test Frequency Range:	150KHz to 30MHz					
Receiver setup:	RBW=9KHz, VBW=30KHz, Sweep time=auto					
Limit:	Frequency range (MHz)		Limit (dBuV)			
			Quasi-peak		Average	
	0.15-0.5		66 to 56*		56 to 46*	
	0.5-5		56		46	
	5-30		60		50	
* Decreases with the logarithm of the frequency.						
Test setup:	<p>Remark E.U.T: Equipment Under Test LISN: Line Impedance Stabilization Network Test table height=0.8m</p>					
Test procedure:	<ol style="list-style-type: none"> 1. The E.U.T and simulators are connected to the main power through a line impedance stabilization network (L.I.S.N.). This provides a 50ohm/50uH coupling impedance for the measuring equipment. 2. The peripheral devices are also connected to the main power through a LISN that provides a 50ohm/50uH coupling impedance with 50ohm termination. (Please refer to the block diagram of the test setup and photographs). 3. Both sides of A.C. line are checked for maximum conducted interference. In order to find the maximum emission, the relative positions of equipment and all of the interface cables must be changed according to ANSI C63.10:2013 on conducted measurement. 					
Test Instruments:	Refer to section 6.0 for details					
Test mode:	Refer to section 5.2 for details					
Test environment:	Temp.:	25 °C	Humid.:	52%	Press.:	1012mbar
Test voltage:	AC 120V					
Test results:	Pass					

Measurement data

Line:

100.0 dBuV

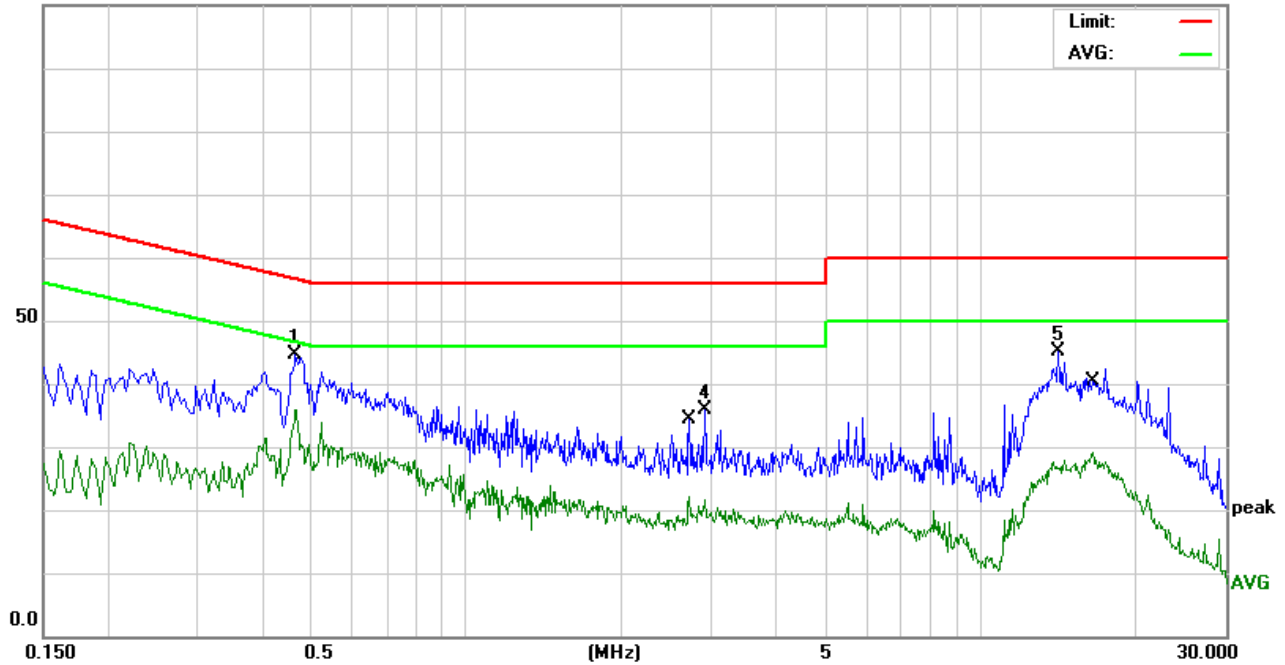

No.	Mk.	Freq. MHz	Reading Level dBuV	Correct Factor dB	Measure- ment dBuV	Limit dBuV	Over dB	Detector
1		0.4660	34.68	10.05	44.73	56.58	-11.85	peak
2	*	0.4660	25.94	10.05	35.99	46.58	-10.59	AVG
3		2.7100	11.99	10.03	22.02	46.00	-23.98	AVG
4		2.9060	25.74	10.03	35.77	56.00	-20.23	peak
5		14.1580	34.74	10.39	45.13	60.00	-14.87	peak
6		16.4860	18.43	10.62	29.05	50.00	-20.95	AVG

Neutral:

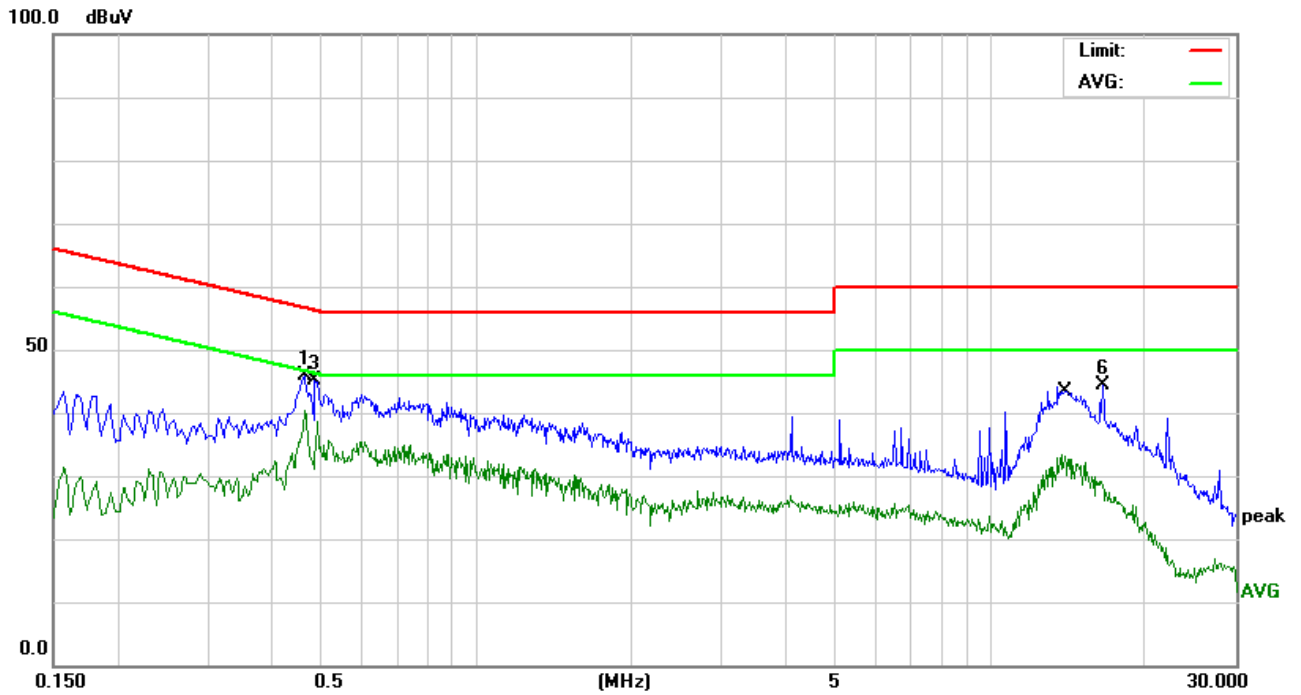

No.	Mk.	Freq. MHz	Reading Level dBuV	Correct Factor dB	Measure- ment dBuV	Limit dBuV	Over dB	Detector
1		0.4620	35.72	10.05	45.77	56.66	-10.89	peak
2	*	0.4620	30.25	10.05	40.30	46.66	-6.36	AVG
3		0.4860	35.03	10.03	45.06	56.24	-11.18	peak
4		0.4900	28.48	10.02	38.50	46.17	-7.67	AVG
5		13.7180	23.06	10.38	33.44	50.00	-16.56	AVG
6		16.5419	33.67	10.63	44.30	60.00	-15.70	peak

Notes:

1. An initial pre-scan was performed on the line and neutral lines with peak detector.
2. Quasi-Peak and Average measurement were performed at the frequencies with maximized peak emission.
3. Final Level =Receiver Read level + LISN Factor + Cable Loss
4. *If the average limit is met when using a quasi-peak detector receiver, the EUT shall be deemed to meet both limits and measurement with the average detector receiver is unnecessary.*

7.3 Conducted Peak Output Power

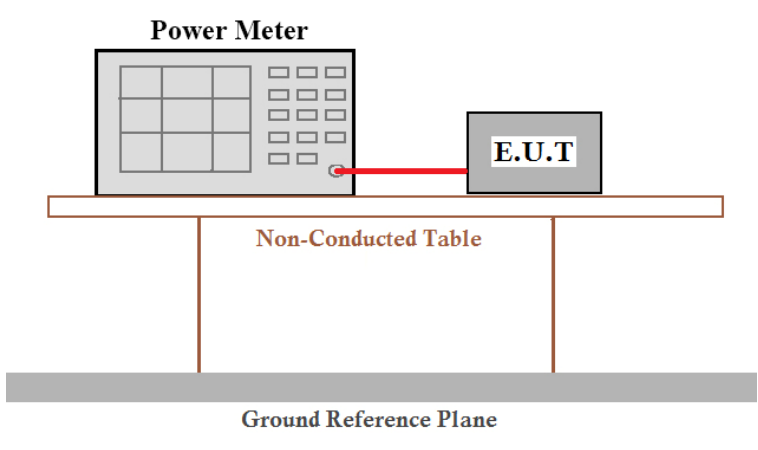
Test Requirement :	FCC Part15 C Section 15.247 (b)(3)
Test Method :	KDB558074 D01 DTS Meas Guidance v05r02 ANSI C63.10:2013 and RSS-Gen
Limit:	30dBm 36dBm(4W for e.i.r.p)
Test setup:	
Test Instruments:	Refer to section 6.0 for details
Test mode:	Refer to section 5.2 for details
Test results:	Pass

Measurement Data

Test CH	Peak Output Power (dBm)				Limit(dBm)	Result
	802.11b	802.11g	802.11n(HT20)	802.11n(HT40)		
Lowest	6.21	8.42	8.53	7.65	30.00	Pass
Middle	6.21	8.36	8.61	8.09		
Highest	6.59	8.48	8.71	8.32		

Test CH	e.i.r.p (dBm)				Limit(dBm)	Result
	802.11b	802.11g	802.11n(HT20)	802.11n(HT40)		
Lowest	6.46	8.67	8.78	7.9	36	Pass
Middle	6.46	8.61	8.86	8.34		
Highest	6.84	8.73	8.96	8.57		

7.4 Channel Bandwidth

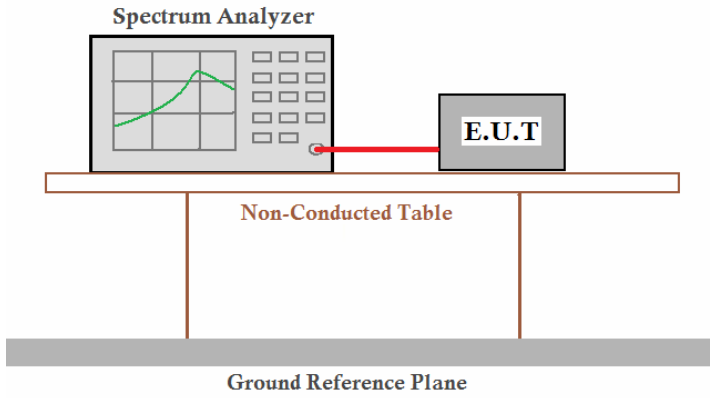
Test Requirement :	FCC Part15 C Section 15.247 (a)(2)
Test Method :	KDB558074 D01 DTS Meas Guidance v05r02 ANSI C63.10:2013 and RSS-Gen
Limit:	>500KHz
Test setup:	 <p>The diagram illustrates the test setup. A Spectrum Analyzer is connected to an E.U.T. (Equipment Under Test) via a red cable. Both are placed on a Non-Conducted Table, which is supported by a Ground Reference Plane.</p>
Test Instruments:	Refer to section 6.0 for details
Test mode:	Refer to section 5.2 for details
Test results:	Pass

Measurement Data

Test CH	Channel Bandwidth (MHz)				Limit(KHz)	Result
	802.11b	802.11g	802.11n(HT20)	802.11n(HT40)		
Lowest	9.0125	16.3088	16.9375	35.4825	>500	Pass
Middle	9.0200	16.2900	17.0438	35.6850		
Highest	9.0288	16.3063	16.8700	35.7975		

Test plot as follows:

-6dB BW:

Test mode:	802.11b	Test mode:	802.11g
------------	---------	------------	---------

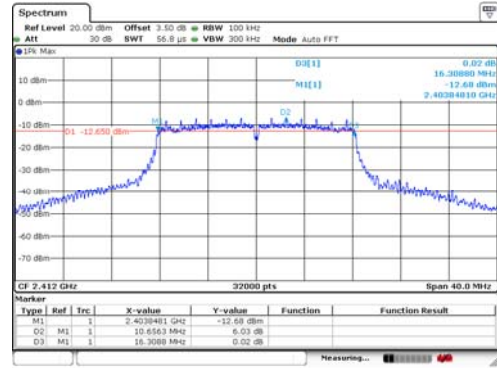
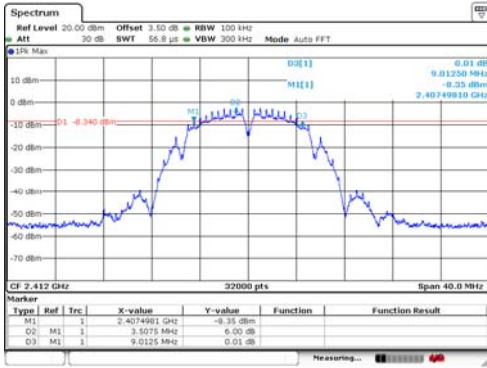

Lowest channel

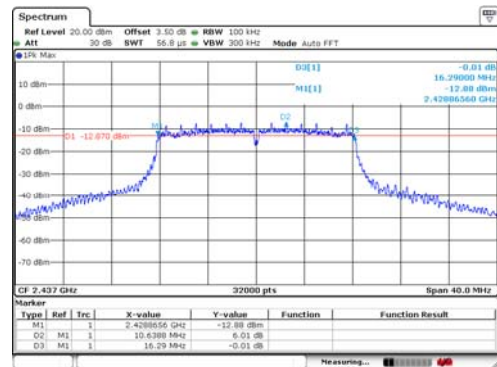
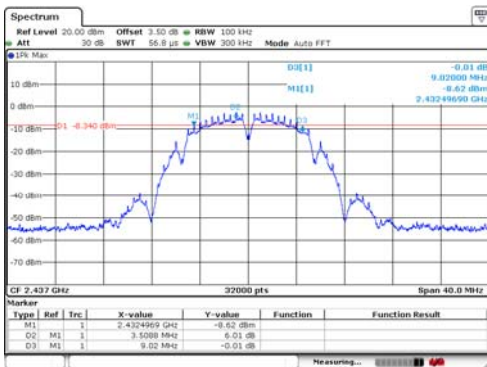

Middle channel

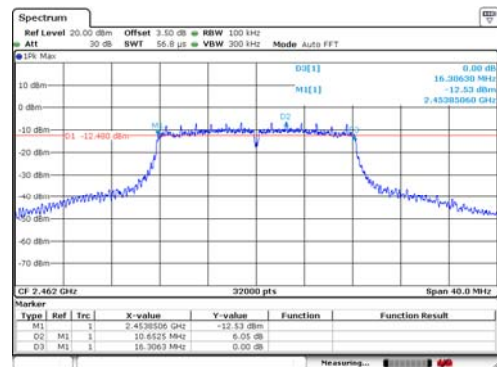
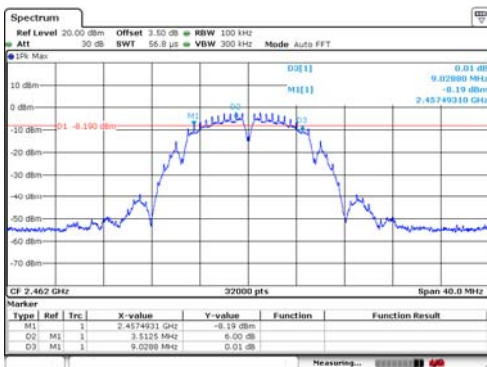

Highest channel

Test mode:	802.11n(HT20)	Test mode:	802.11n(HT40)
------------	---------------	------------	---------------

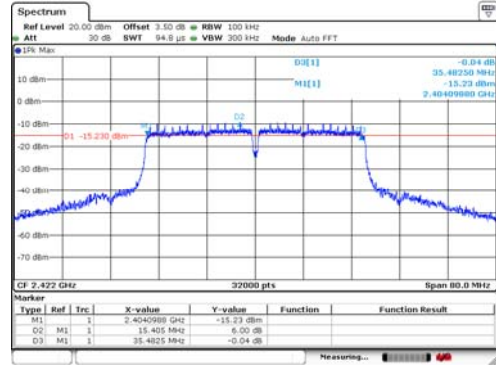
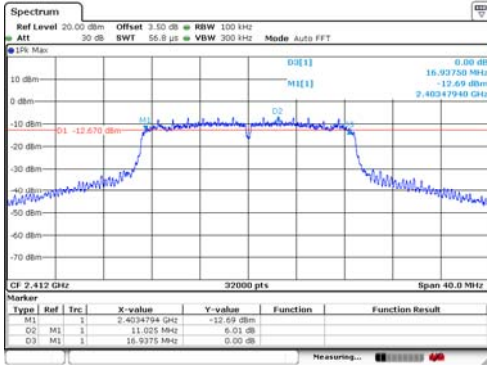

Lowest channel

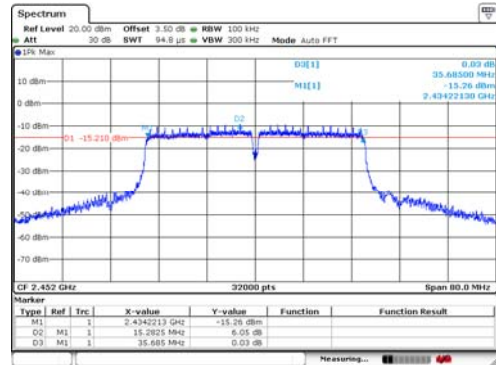
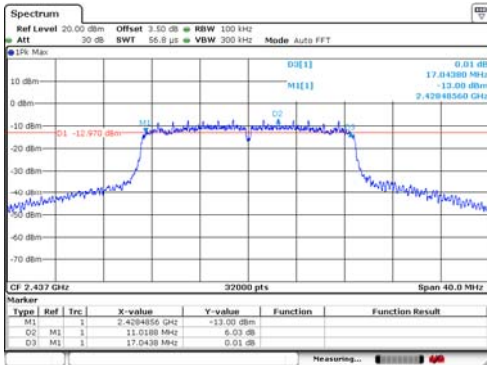

Middle channel

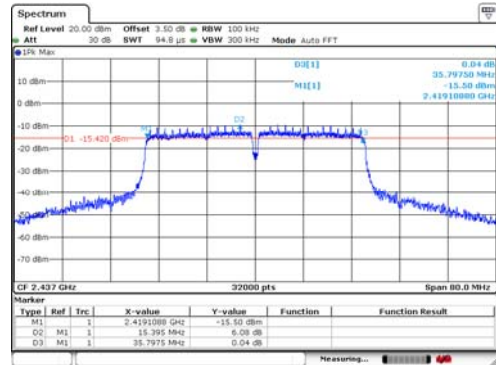
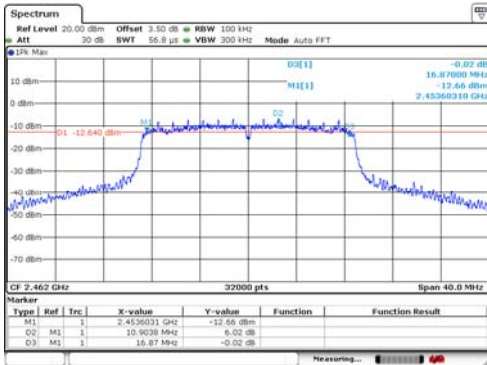

Highest channel

7.5 Power Spectral Density

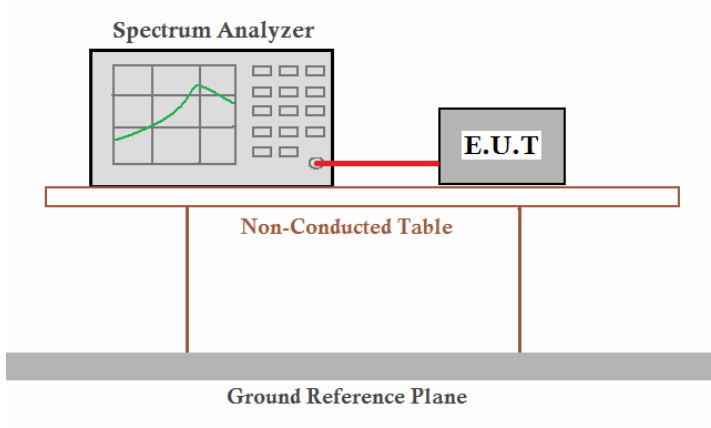
Test Requirement:	FCC Part15 C Section 15.247 (e)
Test Method:	KDB558074 D01 DTS Meas Guidance v05r02 ANSI C63.10:2013 and RSS-Gen
Limit:	8dBm/3kHz
Test setup:	 <p>The diagram illustrates the test setup. A Spectrum Analyzer is connected to an E.U.T. (Equipment Under Test) via a red cable. Both are placed on a Non-Conducted Table, which is supported by a Ground Reference Plane.</p>
Test Instruments:	Refer to section 6.0 for details
Test mode:	Refer to section 5.2 for details
Test results:	Pass

Measurement Data

Test CH	Power Spectral Density (dBm/3kHz)				Limit (dBm/3kHz)	Result
	802.11b	802.11g	802.11n(HT20)	802.11n(HT40)		
Lowest	-13.40	-21.21	-20.58	-24.12	8.00	Pass
Middle	-13.67	-21.29	-20.69	-22.07		
Highest	-13.24	-20.81	-20.31	-23.31		

Test plot as follows:

Test mode:	802.11b	Test mode:	802.11g
------------	---------	------------	---------

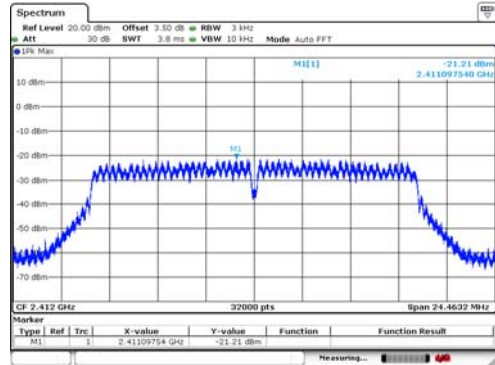
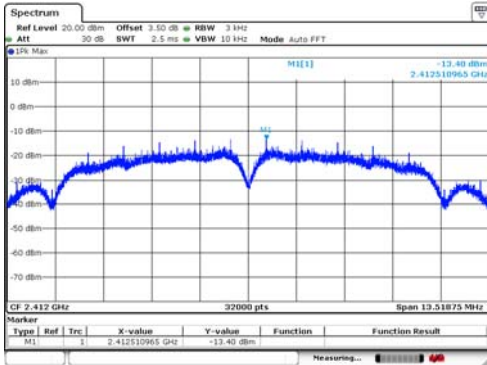

Lowest channel

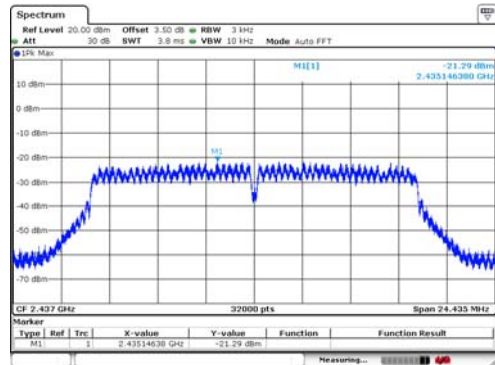
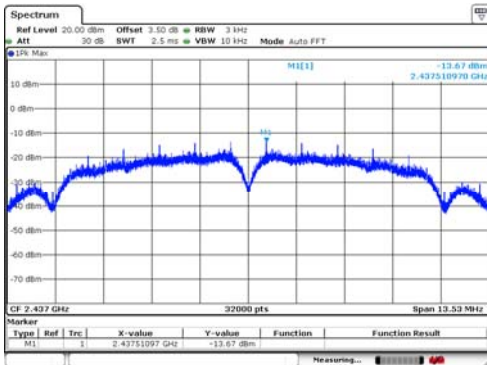

Middle channel

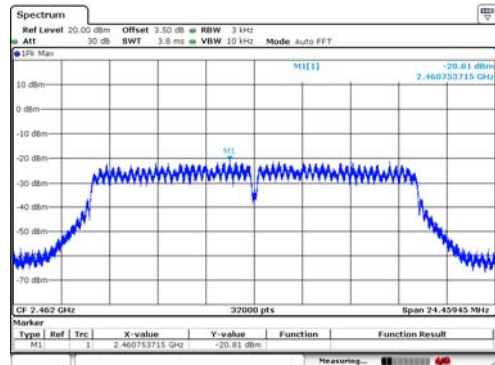
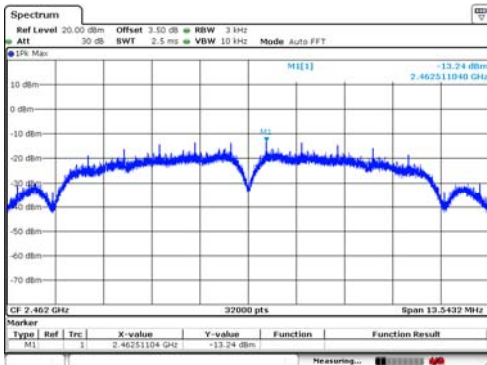

Highest channel

Test mode:	802.11n(HT20)	Test mode:	802.11n(HT40)
------------	---------------	------------	---------------

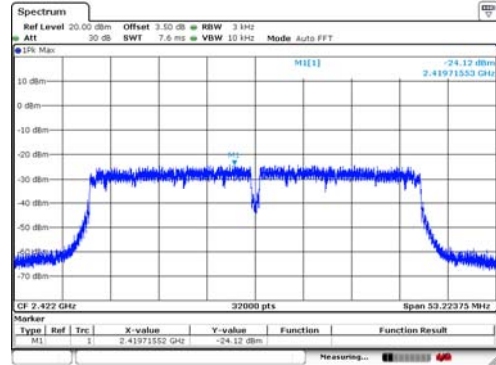
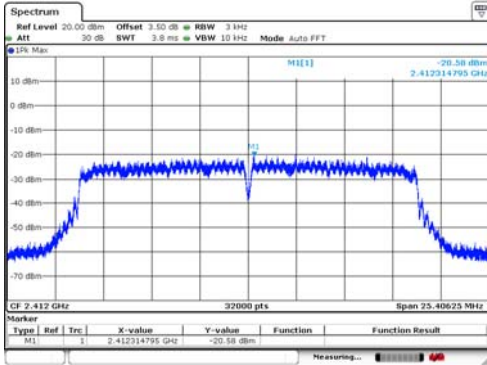

Lowest channel

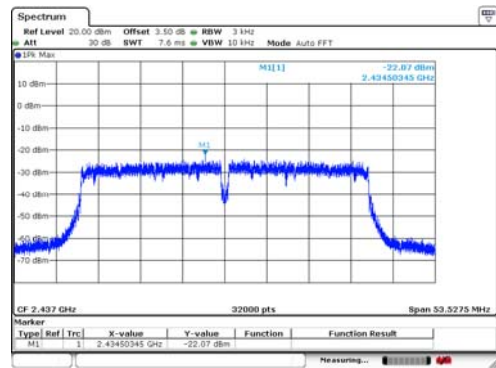
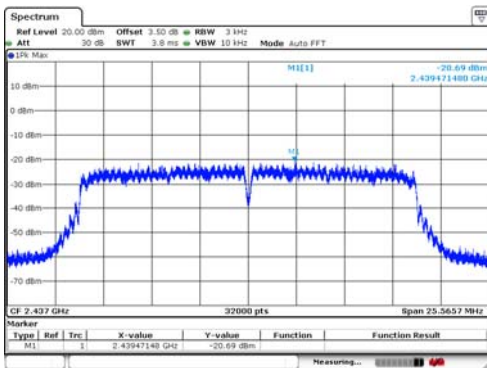

Middle channel

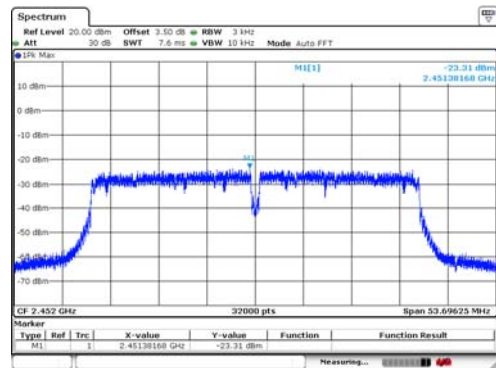
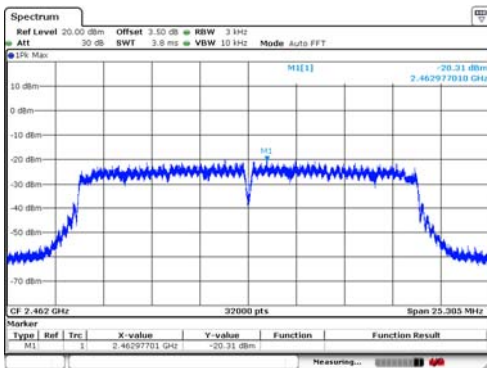

Highest channel

7.6 Band edges

7.6.1 Conducted Emission Method

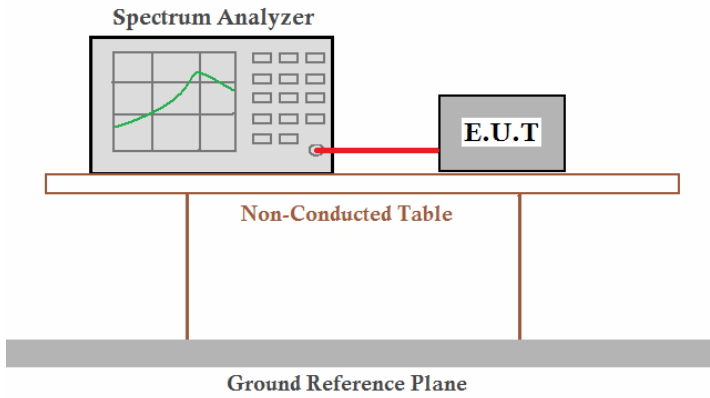
Test Requirement:	FCC Part15 C Section 15.247 (d)
Test Method:	KDB558074 D01 DTS Meas Guidance v05r02 ANSI C63.10:2013
Limit:	In any 100 kHz bandwidth outside the frequency band in which the spread spectrum intentional radiator is operating, the radio frequency power that is produced by the intentional radiator shall be at least 20 dB below that in the 100 kHz bandwidth within the band that contains the highest level of the desired power, based on either an RF conducted or a radiated measurement.
Test setup:	 <p>The diagram illustrates the test setup. A Spectrum Analyzer is connected to an E.U.T. (Equipment Under Test) via a red cable. Both are placed on a Non-Conducted Table, which is supported by a Ground Reference Plane.</p>
Test Instruments:	Refer to section 6.0 for details
Test mode:	Refer to section 5.2 for details
Test results:	Pass

Test plot as follows:

Test mode: 802.11b

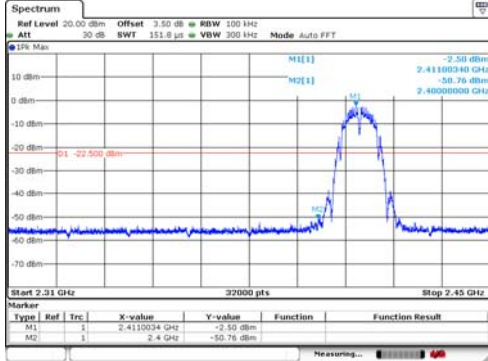

Lowest channel

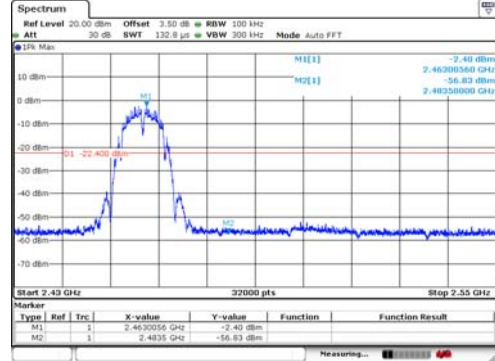

Highest channel

Test mode: 802.11g

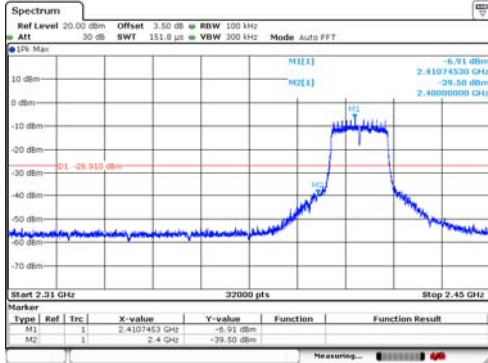

Lowest channel

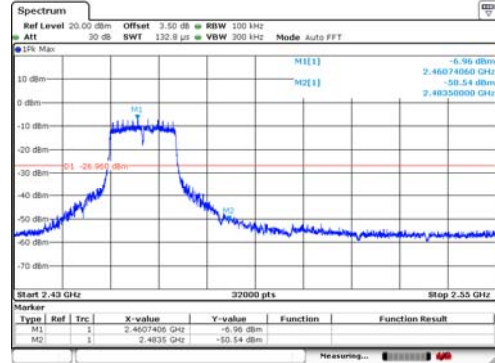

Highest channel

Test mode: 802.11n(HT20)

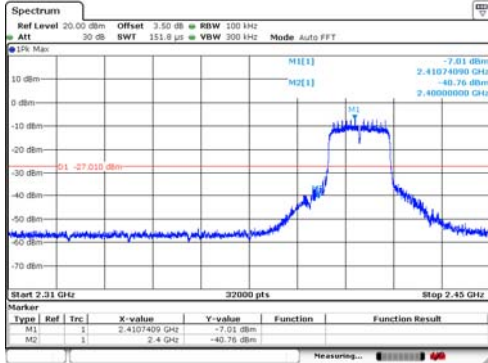

Lowest channel

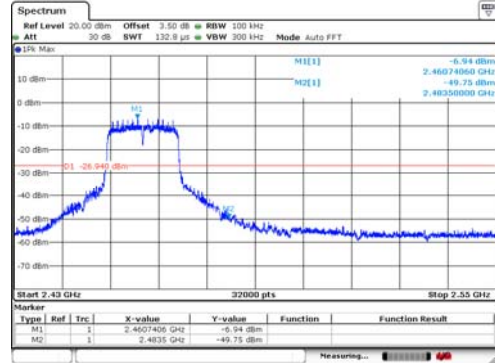

Highest channel

Test mode: 802.11n(HT40)

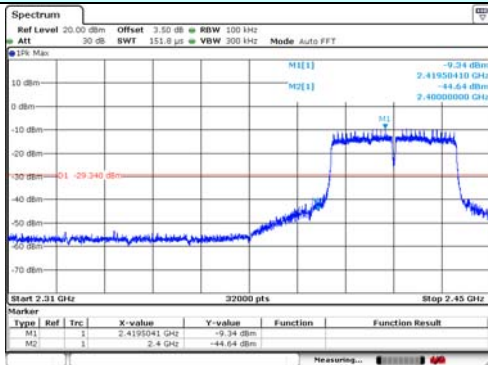

Lowest channel

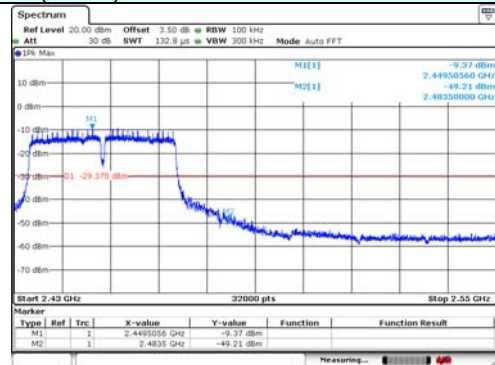

Highest channel

7.6.2 Radiated Emission Method

Test Requirement:	FCC Part15 C Section 15.209 and 15.205			
Test Method:	ANSI C63.10: 2013			
Test Frequency Range:	All of the restrict bands were tested, only the worst band's (2310MHz to 2500MHz) data was showed.			
Test site:	Measurement Distance: 3m			
Receiver setup:	Frequency	Detector	RBW	VBW
	Above 1GHz	Peak	1MHz	3MHz
		Average	1MHz	3MHz
Limit:	Frequency	Limit (dBuV/m @3m)		Value
	Above 1GHz	54.00		Average
		74.00		Peak
Test setup:				
Test Procedure:	<ol style="list-style-type: none"> 1. The EUT was placed on the top of a rotating table 1.5 meters above the ground at a 3 meter camber. The table was rotated 360 degrees to determine the position of the highest radiation. 2. The EUT was set 3 meters away from the interference-receiving antenna, which was mounted on the top of a variable-height antenna tower. 3. The antenna height is varied from one meter to four meters above the ground to determine the maximum value of the field strength. Both horizontal and vertical polarizations of the antenna are set to make the measurement. 4. For each suspected emission, the EUT was arranged to its worst case and then the antenna was tuned to heights from 1 meter to 4 meters and the rota table was turned from 0 degrees to 360 degrees to find the maximum reading. 5. The test-receiver system was set to Peak Detect Function and Specified Bandwidth with Maximum Hold Mode. 6. If the emission level of the EUT in peak mode was 10dB lower than the limit specified, then testing could be stopped and the peak values of the EUT would be reported. Otherwise the emissions that did not have 10dB margin would be re-tested one by one using peak, quasi-peak or average method as specified and then reported in a data sheet. 7. The radiation measurements are performed in X, Y, Z axis positioning. And found the Y axis positioning which it is worse case, only the test worst case mode is recorded in the report. 			
Test Instruments:	Refer to section 6.0 for details			
Test mode:	Refer to section 5.2 for details			
Test results:	Pass			

Measurement data:

Test mode:	802.11b	Test channel:	Lowest
------------	---------	---------------	--------

Vertical:

Frequency	Meter Reading	Factor	Emission Level	Limits	Margin	Detector Type
(MHz)	(dBμV)	(dB)	(dBμV/m)	(dBμV/m)	(dB)	
2400.000	32.47	-5.70	26.77	74.00	-47.23	peak
2400.000	20.16	-5.70	14.46	54.00	-39.54	AVG

Horizontal:

Frequency	Meter Reading	Factor	Emission Level	Limits	Margin	Detector Type
(MHz)	(dBμV)	(dB)	(dBμV/m)	(dBμV/m)	(dB)	
2400.000	37.42	-5.70	31.72	74.00	-42.28	peak
2400.000	20.66	-5.70	14.96	54.00	-39.04	AVG

Test mode:	802.11b	Test channel:	Highest
------------	---------	---------------	---------

Vertical:

Frequency	Meter Reading	Factor	Emission Level	Limits	Margin	Detector Type
(MHz)	(dBμV)	(dB)	(dBμV/m)	(dBμV/m)	(dB)	
2483.500	29.43	-4.98	24.45	74.00	-49.55	peak
2483.500	20.05	-4.98	15.07	54.00	-38.93	AVG

Horizontal:

Frequency	Meter Reading	Factor	Emission Level	Limits	Margin	Detector Type
(MHz)	(dBμV)	(dB)	(dBμV/m)	(dBμV/m)	(dB)	
2483.500	30.16	-4.98	25.18	74.00	-48.82	peak
2483.500	20.87	-4.98	15.89	54.00	-38.11	AVG

Test mode:	802.11g	Test channel:	Lowest
------------	---------	---------------	--------

Vertical:

Frequency (MHz)	Meter Reading (dBμV)	Factor (dB)	Emission Level (dBμV/m)	Limits (dBμV/m)	Margin (dB)	Detector Type
2400.000	35.42	-5.70	29.72	74.00	-44.28	peak
2400.000	20.39	-5.70	14.69	54.00	-39.31	AVG

Horizontal:

Frequency (MHz)	Meter Reading (dBμV)	Factor (dB)	Emission Level (dBμV/m)	Limits (dBμV/m)	Margin (dB)	Detector Type
2400.000	37.21	-5.70	31.51	74.00	-42.49	peak
2400.000	21.06	-5.70	15.36	54.00	-38.64	AVG

Test mode:	802.11g	Test channel:	Highest
------------	---------	---------------	---------

Vertical:

Frequency (MHz)	Meter Reading (dBμV)	Factor (dB)	Emission Level (dBμV/m)	Limits (dBμV/m)	Margin (dB)	Detector Type
2483.500	30.43	-4.98	25.45	74.00	-48.55	peak
2483.500	20.04	-4.98	15.06	54.00	-38.94	AVG

Horizontal:

Frequency (MHz)	Meter Reading (dBμV)	Factor (dB)	Emission Level (dBμV/m)	Limits (dBμV/m)	Margin (dB)	Detector Type
2483.500	31.47	-4.98	26.49	74.00	-47.51	peak
2483.500	20.29	-4.98	15.31	54.00	-38.69	AVG

Test mode:	802.11n(HT20)	Test channel:	Lowest
------------	---------------	---------------	--------

Vertical:

Frequency	Meter Reading	Factor	Emission Level	Limits	Margin	Detector Type
(MHz)	(dB μ V)	(dB)	(dB μ V/m)	(dB μ V/m)	(dB)	
2400.000	34.24	-5.70	28.54	74.00	-45.46	peak
2400.000	20.83	-5.70	15.13	54.00	-38.87	AVG

Horizontal:

Frequency	Meter Reading	Factor	Emission Level	Limits	Margin	Detector Type
(MHz)	(dB μ V)	(dB)	(dB μ V/m)	(dB μ V/m)	(dB)	
2400.000	38.55	-5.70	32.85	74.00	-41.15	peak
2400.000	21.63	-5.70	15.93	54.00	-38.07	AVG

Test mode:	802.11n(HT20)	Test channel:	Highest
------------	---------------	---------------	---------

Vertical:

Frequency	Meter Reading	Factor	Emission Level	Limits	Margin	Detector Type
(MHz)	(dB μ V)	(dB)	(dB μ V/m)	(dB μ V/m)	(dB)	
2483.500	30.47	-4.98	25.49	74.00	-48.51	peak
2483.500	19.86	-4.98	14.88	54.00	-39.12	AVG

Horizontal:

Frequency	Meter Reading	Factor	Emission Level	Limits	Margin	Detector Type
(MHz)	(dB μ V)	(dB)	(dB μ V/m)	(dB μ V/m)	(dB)	
2483.500	31.21	-4.98	26.23	74.00	-47.77	peak
2483.500	20.84	-4.98	15.86	54.00	-38.14	AVG

Test mode:	802.11n(HT40)	Test channel:	Lowest
------------	---------------	---------------	--------

Vertical:

Frequency	Meter Reading	Factor	Emission Level	Limits	Margin	Detector Type
(MHz)	(dBμV)	(dB)	(dBμV/m)	(dBμV/m)	(dB)	
2400.000	32.47	-5.70	26.77	74.00	-47.23	peak
2400.000	20.69	-5.70	14.99	54.00	-39.01	AVG

Horizontal:

Frequency	Meter Reading	Factor	Emission Level	Limits	Margin	Detector Type
(MHz)	(dBμV)	(dB)	(dBμV/m)	(dBμV/m)	(dB)	
2400.000	39.28	-5.70	33.58	74.00	-40.42	peak
2400.000	20.67	-5.70	14.97	54.00	-39.03	AVG

Test mode:	802.11n(HT40)	Test channel:	Highest
------------	---------------	---------------	---------

Vertical:

Frequency	Meter Reading	Factor	Emission Level	Limits	Margin	Detector Type
(MHz)	(dBμV)	(dB)	(dBμV/m)	(dBμV/m)	(dB)	
2483.500	30.27	-4.98	25.29	74.00	-48.71	peak
2483.565	19.85	-4.98	14.87	54.00	-39.13	AVG

Horizontal:

Frequency	Meter Reading	Factor	Emission Level	Limits	Margin	Detector Type
(MHz)	(dBμV)	(dB)	(dBμV/m)	(dBμV/m)	(dB)	
2483.500	30.96	-4.98	25.98	74.00	-48.02	peak
2483.500	21.33	-4.98	16.35	54.00	-37.65	AVG

Remarks:

1. Only the worst case Main Antenna test data.
2. The pre-test were performed on lowest, middle and highest frequencies, only the worst case's (lowest and highest frequencies) data was showed.
3. Final Level = Receiver Read level + Antenna Factor + Cable Loss – Preamplifier Factor
4. The emission levels of other frequencies are very lower than the limit and not show in test report.

7.7 Spurious Emission

7.7.1 Conducted Emission Method

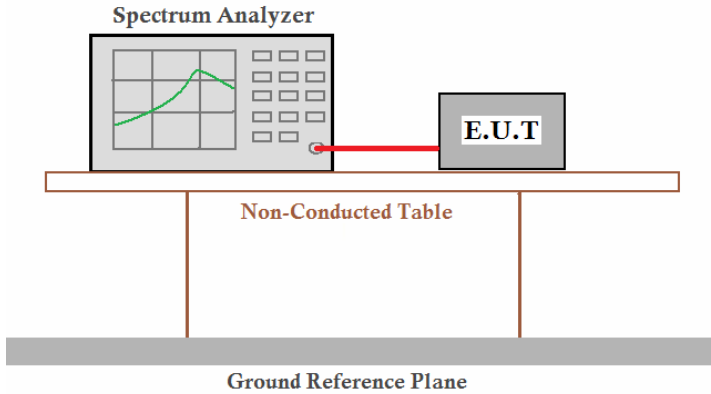
Test Requirement:	FCC Part15 C Section 15.247 (d)
Test Method:	KDB558074 D01 DTS Meas Guidance v05r02 ANSI C63.10:2013
Limit:	In any 100 kHz bandwidth outside the frequency band in which the spread spectrum intentional radiator is operating, the radio frequency power that is produced by the intentional radiator shall be at least 20 dB below that in the 100 kHz bandwidth within the band that contains the highest level of the desired power, based on either an RF conducted or a radiated measurement.
Test setup:	 <p>The diagram illustrates the test setup. A Spectrum Analyzer is connected to an E.U.T. (Equipment Under Test) via a red cable. Both the Spectrum Analyzer and the E.U.T. are placed on a Non-Conducted Table. The table is supported by two legs and sits on a Ground Reference Plane.</p>
Test Instruments:	Refer to section 6.0 for details
Test mode:	Refer to section 5.2 for details
Test results:	Pass

Test plot as follows:

Test mode:	802.11b	Test mode:	802.11g
------------	---------	------------	---------

Lowest channel

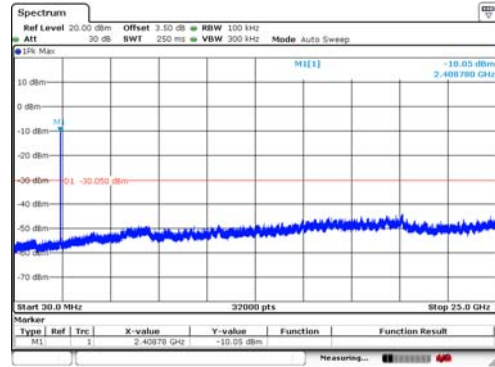
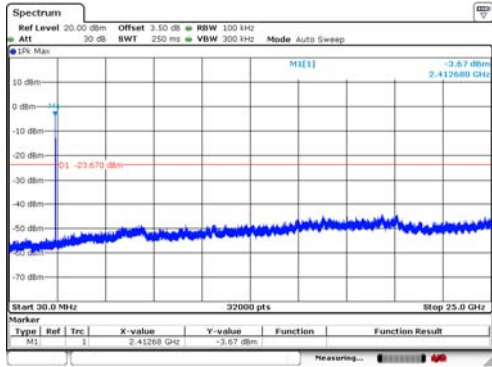

30MHz~25GHz

Middle channel

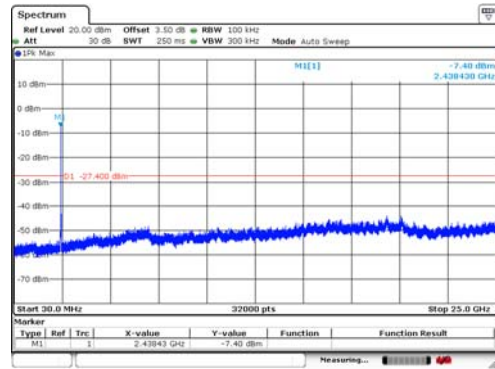
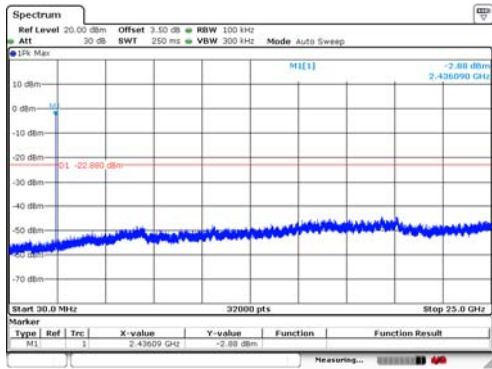

30MHz~25GHz

Highest channel

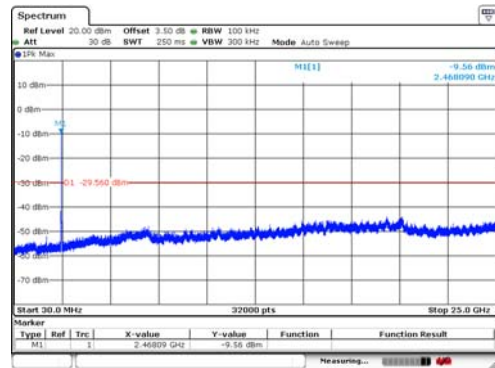
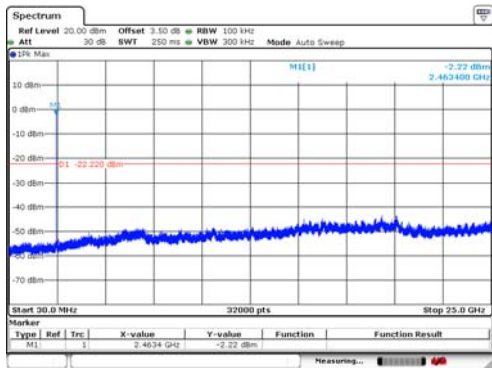

30MHz~25GHz

Test mode:	802.11n(HT20)	Test mode:	802.11n(HT40)
------------	---------------	------------	---------------

Lowest channel

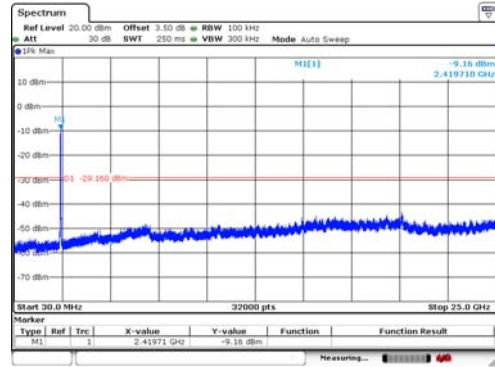
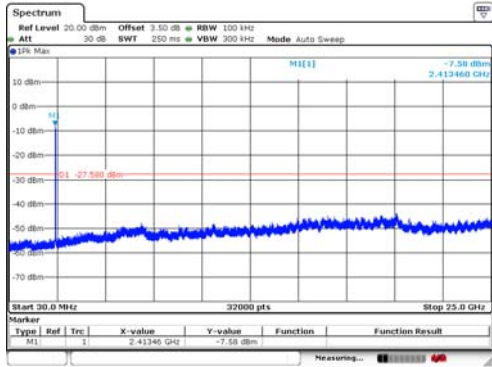

30MHz~25GHz

Middle channel

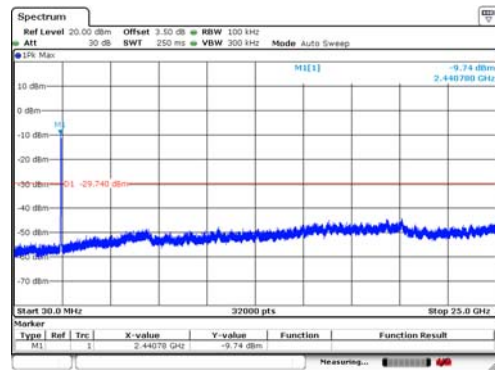
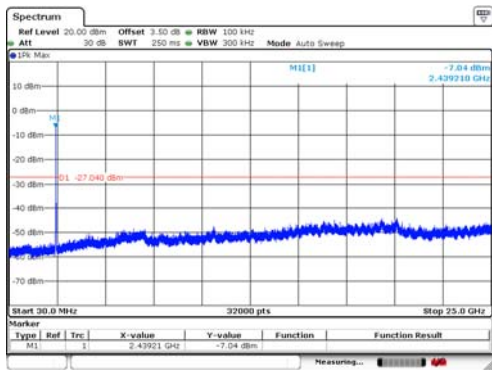

30MHz~25GHz

Highest channel

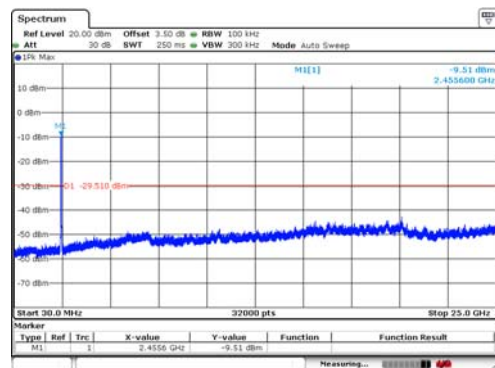
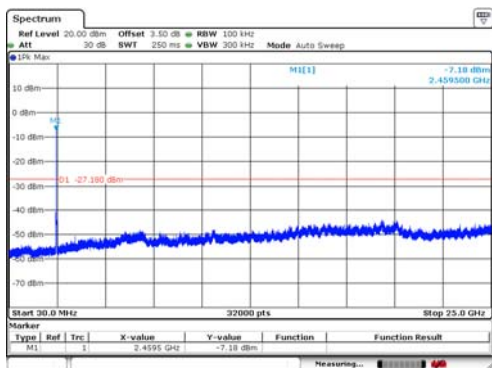

30MHz~25GHz

7.7.2 Radiated Emission Method

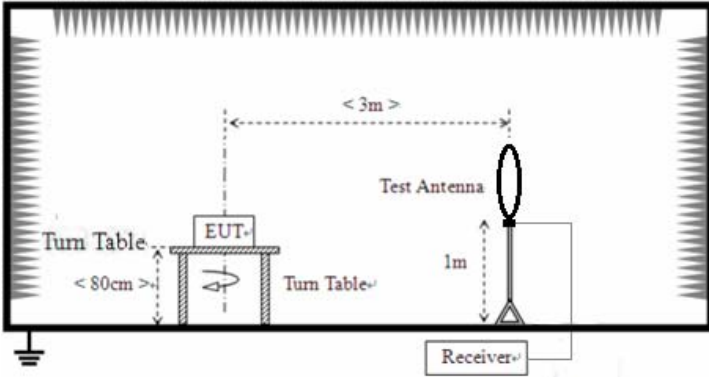
Test Requirement:	FCC Part15 C Section 15.209				
Test Method:	ANSI C63.10: 2013				
Test Frequency Range:	9kHz to 25GHz				
Test site:	Measurement Distance: 3m				
Receiver setup:	Frequency	Detector	RBW	VBW	Value
	9KHz-150KHz	Quasi-peak	200Hz	600Hz	Quasi-peak
	150KHz-30MHz	Quasi-peak	9KHz	30KHz	Quasi-peak
	30MHz-1GHz	Quasi-peak	100KHz	300KHz	Quasi-peak
	Above 1GHz	Peak	1MHz	3MHz	Peak
Peak		1MHz	10Hz	Average	
Limit:	Frequency	Limit (uV/m)	Value	Measurement Distance	
	0.009MHz-0.490MHz	2400/F(KHz)	QP	300m	
	0.490MHz-1.705MHz	24000/F(KHz)	QP	300m	
	1.705MHz-30MHz	30	QP	30m	
	30MHz-88MHz	100	QP	3m	
	88MHz-216MHz	150	QP		
	216MHz-960MHz	200	QP		
	960MHz-1GHz	500	QP		
	Above 1GHz	500	Average		
		5000	Peak		
Test setup:	For radiated emissions from 9kHz to 30MHz				
	 <p>The diagram illustrates the test setup for radiated emissions from 9kHz to 30MHz. It shows an Equipment Under Test (EUT) placed on a turn table. A test antenna is positioned on another turn table, connected to a receiver. The distance between the EUT and the test antenna is indicated as 3m. The test antenna is 1m high. The turn table for the EUT is less than 80cm high. The receiver is connected to the test antenna.</p>				
For radiated emissions from 30MHz to 1GHz					

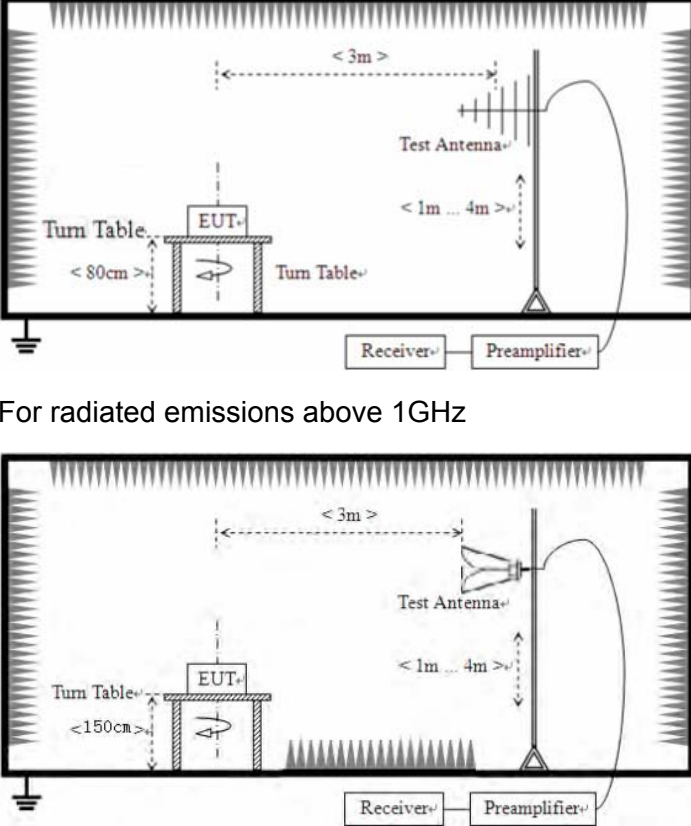
	 <p>For radiated emissions above 1GHz</p>
<p>Test Procedure:</p>	<ol style="list-style-type: none"> 1. The EUT was placed on the top of a rotating table (0.8m for below 1G and 1.5m for above 1G) above the ground at a 3 meter camber. The table was rotated 360 degrees to determine the position of the highest radiation. 2. The EUT was set 3 meters away from the interference-receiving antenna, which was mounted on the top of a variable-height antenna tower. 3. The antenna height is varied from one meter to four meters above the ground to determine the maximum value of the field strength. Both horizontal and vertical polarizations of the antenna are set to make the measurement. 4. For each suspected emission, the EUT was arranged to its worst case and then the antenna was tuned to heights from 1 meter to 4 meters and the rota table was turned from 0 degrees to 360 degrees to find the maximum reading. 5. The test-receiver system was set to Peak Detect Function and Specified Bandwidth with Maximum Hold Mode. 6. If the emission level of the EUT in peak mode was 10dB lower than the limit specified, then testing could be stopped and the peak values of the EUT would be reported. Otherwise the emissions that did not have 10dB margin would be re-tested one by one using peak, quasi-peak or average method as specified and then reported in a data sheet.
<p>Test Instruments:</p>	<p>Refer to section 6.0 for details</p>

Test mode:	Refer to section 5.2 for details					
Test voltage:	AC120V 60Hz					
Test environment:	Temp.:	25 °C	Humid.:	52%	Press.:	1012mbar
Test voltage:	AC 120V, 60Hz					
Test results:	Pass					

Remarks:

1. *Only the worst case Main Antenna test data.*
2. *Pre-scan all kind of the place mode (X-axis, Y-axis, Z-axis), and found the Y-axis which it is worse case.*

Measurement data:

■ **9kHz~30MHz**

The emission from 9 kHz to 30MHz was pre-tested and found the result was 20dB lower than the limit, and according to 15.31(o) & RSS-Gen 6.13, the test result no need to reported.

■ Below 1GHz

Pre-scan all test modes, found worst case at 802.11b 2462MHz, and so only show the test result of 802.11b 2462MHz

Horizontal:

80.0 dBuV/m

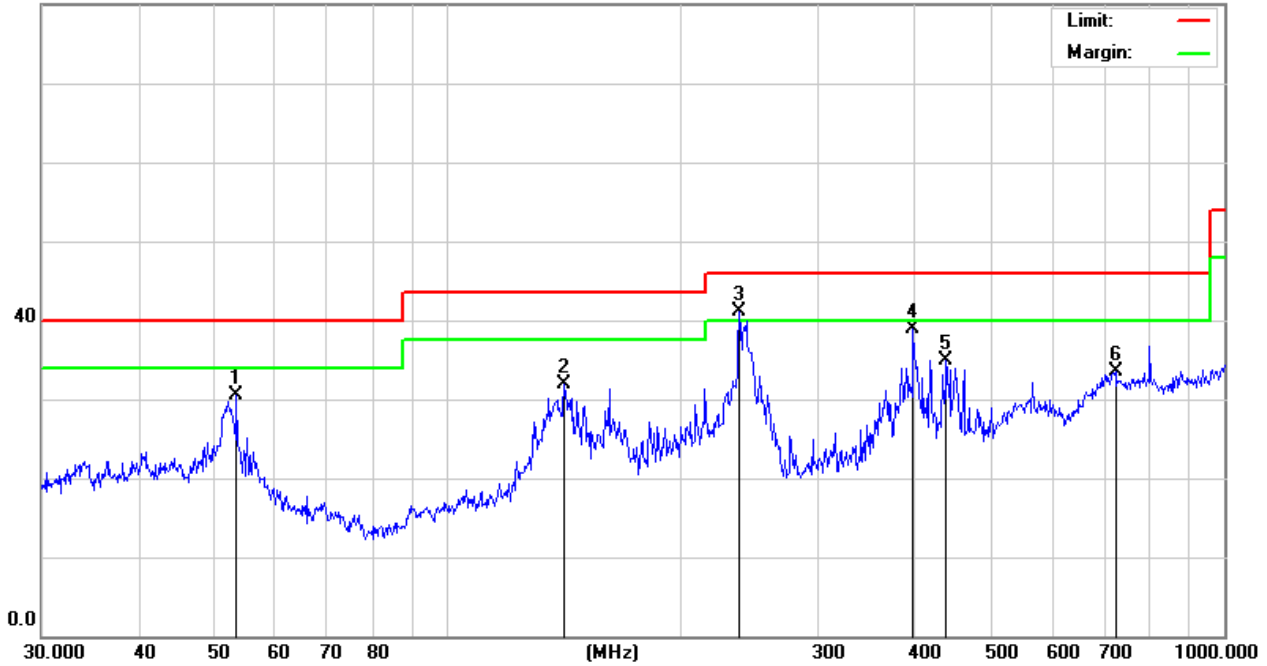

No.	Mk.	Freq. MHz	Reading Level dBuV	Correct Factor dB	Measure- ment dBuV/m	Limit dBuV/m	Over dB	Detector
1		53.5052	34.61	-4.03	30.58	40.00	-9.42	peak
2		141.3298	38.93	-6.94	31.99	43.50	-11.51	peak
3	*	237.4760	47.90	-6.74	41.16	46.00	-4.84	peak
4		397.6334	41.89	-3.03	38.86	46.00	-7.14	peak
5		438.6554	35.67	-0.75	34.92	46.00	-11.08	peak
6		724.2611	26.13	7.29	33.42	46.00	-12.58	peak

Vertical:

80.0 dBuV/m

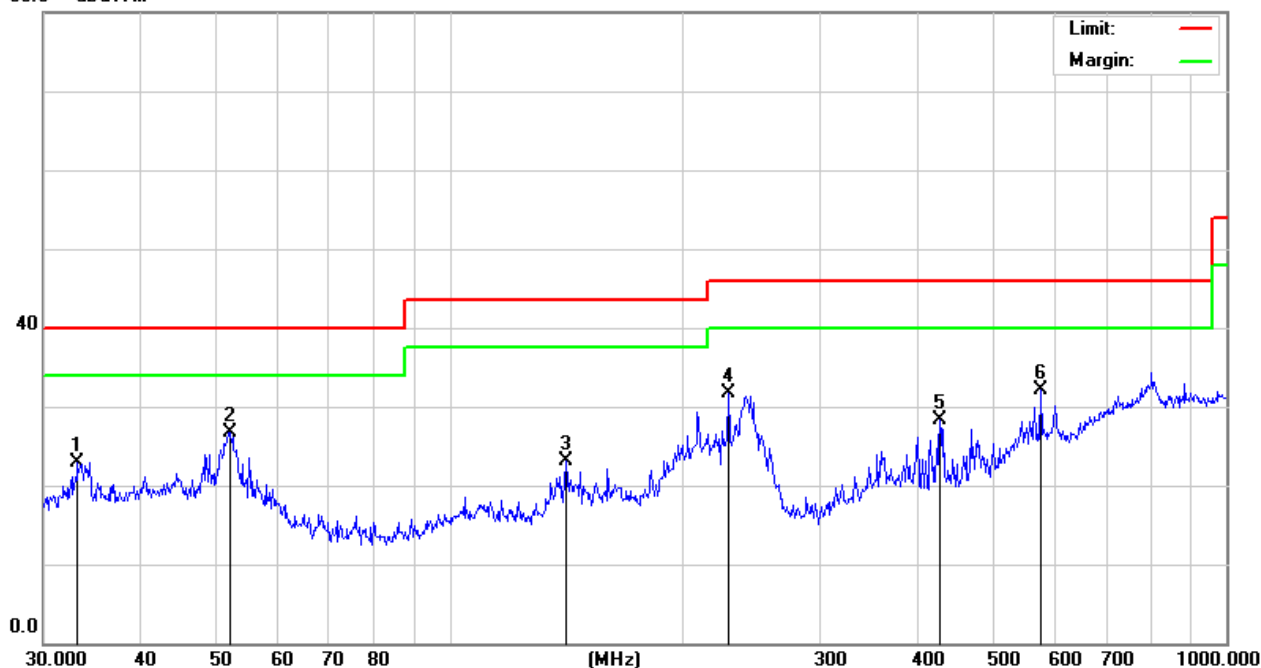

No.	Mk.	Freq. MHz	Reading Level dBuV	Correct Factor dB	Measure- ment dBuV/m	Limit dBuV/m	Over dB	Detector
1		33.2112	28.01	-5.04	22.97	40.00	-17.03	peak
2	*	52.2079	32.93	-6.29	26.64	40.00	-13.36	peak
3		141.3298	30.56	-7.48	23.08	43.50	-20.42	peak
4		228.4904	39.07	-7.40	31.67	46.00	-14.33	peak
5		428.0193	31.96	-3.74	28.22	46.00	-17.78	peak
6		576.6443	29.98	2.04	32.02	46.00	-13.98	peak

■ Above 1GHz

Test mode:	802.11b	Test channel:	Lowest
------------	---------	---------------	--------

H

Frequency (MHz)	Meter Reading (dBμV)	Factor (dB)	Emission Level (dBμV/m)	Limits (dBμV/m)	Margin (dB)	Detector Type
4824.000	43.57	5.08	48.65	74.00	-25.35	PEAK
4824.000	29.64	5.08	34.72	54.00	-19.28	AVG
7326.000	40.25	7.55	47.80	74.00	-26.20	PEAK
7326.000	27.36	7.55	34.91	54.00	-19.09	AVG

V

Frequency (MHz)	Meter Reading (dBμV)	Factor (dB)	Emission Level (dBμV/m)	Limits (dBμV/m)	Margin (dB)	Detector Type
4824.000	43.58	5.08	48.66	74.00	-25.34	PEAK
4824.000	30.67	5.08	35.75	54.00	-18.25	AVG
7236.000	41.59	7.55	49.14	74.00	-24.86	PEAK
7236.000	29.43	7.55	36.98	54.00	-17.02	AVG

Test mode:	802.11b	Test channel:	Middle
------------	---------	---------------	--------

H

Frequency (MHz)	Meter Reading (dB μ V)	Factor (dB)	Emission Level (dB μ V/m)	Limits (dB μ V/m)	Margin (dB)	Detector Type
4874.000	43.88	5.13	49.01	74.00	-24.99	PEAK
4874.000	29.43	5.13	34.56	54.00	-19.44	AVG
7311.000	41.05	7.49	48.54	74.00	-25.46	PEAK
7311.000	26.97	7.49	34.46	54.00	-19.54	AVG

V

Frequency (MHz)	Meter Reading (dB μ V)	Factor (dB)	Emission Level (dB μ V/m)	Limits (dB μ V/m)	Margin (dB)	Detector Type
4874.000	42.39	5.13	47.52	74.00	-26.48	PEAK
4874.000	30.45	5.13	35.58	54.00	-18.42	AVG
7311.000	40.24	7.49	47.73	74.00	-26.27	PEAK
7311.000	27.43	7.49	34.92	54.00	-19.08	AVG

Test mode:	802.11b	Test channel:	Highest
------------	---------	---------------	---------

H

Frequency (MHz)	Meter Reading (dB μ V)	Factor (dB)	Emission Level (dB μ V/m)	Limits (dB μ V/m)	Margin (dB)	Detector Type
4924.000	42.84	5.18	48.02	74.00	-25.98	PEAK
4924.000	30.16	5.18	35.34	54.00	-18.66	AVG
7386.000	40.75	7.82	48.57	74.00	-25.43	PEAK
7386.000	29.33	7.82	37.15	54.00	-16.85	AVG

V

Frequency (MHz)	Meter Reading (dB μ V)	Factor (dB)	Emission Level (dB μ V/m)	Limits (dB μ V/m)	Margin (dB)	Detector Type
4924.000	44.43	5.18	49.61	74.00	-24.39	PEAK
4924.000	31.28	5.18	36.46	54.00	-17.54	AVG
7386.000	41.36	7.82	49.18	74.00	-24.82	PEAK
7386.000	28.05	7.82	35.87	54.00	-18.13	AVG

Test mode:	802.11g	Test channel:	lowest
------------	---------	---------------	--------

H

Frequency (MHz)	Meter Reading (dB μ V)	Factor (dB)	Emission Level (dB μ V/m)	Limits (dB μ V/m)	Margin (dB)	Detector Type
4824.000	42.87	5.08	47.95	74.00	-26.05	PEAK
4824.000	30.24	5.08	35.32	54.00	-18.68	AVG
7326.000	40.45	7.55	48.00	74.00	-26.00	PEAK
7326.000	27.14	7.55	34.69	54.00	-19.31	AVG

V

Frequency (MHz)	Meter Reading (dB μ V)	Factor (dB)	Emission Level (dB μ V/m)	Limits (dB μ V/m)	Margin (dB)	Detector Type
4824.000	43.16	5.08	48.24	74.00	-25.76	PEAK
4824.000	29.89	5.08	34.97	54.00	-19.03	AVG
7236.000	40.46	7.16	47.62	74.00	-26.38	PEAK
7236.000	27.15	7.16	34.31	54.00	-19.69	AVG

Test mode:	802.11g	Test channel:	Middle
------------	---------	---------------	--------

H

Frequency (MHz)	Meter Reading (dB μ V)	Factor (dB)	Emission Level (dB μ V/m)	Limits (dB μ V/m)	Margin (dB)	Detector Type
4874.000	42.54	5.13	47.67	74.00	-26.33	PEAK
4874.000	28.93	5.13	34.06	54.00	-19.94	AVG
7311.000	39.46	7.49	46.95	74.00	-27.05	PEAK
7311.000	26.88	7.49	34.37	54.00	-19.63	AVG

V

Frequency (MHz)	Meter Reading (dB μ V)	Factor (dB)	Emission Level (dB μ V/m)	Limits (dB μ V/m)	Margin (dB)	Detector Type
4874.000	42.71	5.13	47.84	74.00	-26.16	PEAK
4874.000	28.69	5.13	33.82	54.00	-20.18	AVG
7311.000	39.24	7.49	46.73	74.00	-27.27	PEAK
7311.000	26.93	7.49	34.42	54.00	-19.58	AVG

Test mode:	802.11g	Test channel:	Highest
------------	---------	---------------	---------

H

Frequency (MHz)	Meter Reading (dB μ V)	Factor (Db)	Emission Level (dB μ V/m)	Limits (dB μ V/m)	Margin (Db)	Detector Type
4924.000	42.68	5.18	47.86	74.00	-26.14	PEAK
4924.000	30.04	5.18	35.22	54.00	-18.78	AVG
7386.000	39.76	7.82	47.58	74.00	-26.42	PEAK
7386.000	26.82	7.82	34.64	54.00	-19.36	AVG

V

Frequency (MHz)	Meter Reading (dB μ V)	Factor (dB)	Emission Level (dB μ V/m)	Limits (dB μ V/m)	Margin (dB)	Detector Type
4924.000	42.52	5.18	47.70	74.00	-26.30	PEAK
4924.000	30.19	5.18	35.37	54.00	-18.63	AVG
7386.000	40.05	7.82	47.87	74.00	-26.13	PEAK
7386.000	27.14	7.82	34.96	54.00	-19.04	AVG

Test mode:	802.11n(HT20)	Test channel:	Lowest
------------	---------------	---------------	--------

H

Frequency (MHz)	Meter Reading (dB μ V)	Factor (dB)	Emission Level (dB μ V/m)	Limits (dB μ V/m)	Margin (dB)	Detector Type
4824.000	42.58	5.08	47.66	74.00	-26.34	PEAK
4824.000	30.04	5.08	35.12	54.00	-18.88	AVG
7326.000	40.03	7.55	47.58	74.00	-26.42	PEAK
7326.000	27.49	7.55	35.04	54.00	-18.96	AVG

V

Frequency (MHz)	Meter Reading (dB μ V)	Factor (dB)	Emission Level (dB μ V/m)	Limits (dB μ V/m)	Margin (dB)	Detector Type
4824.000	42.19	5.08	47.27	74.00	-26.73	PEAK
4824.000	29.73	5.08	34.81	54.00	-19.19	AVG
7236.000	40.56	7.16	47.72	74.00	-26.28	PEAK
7236.000	27.14	7.16	34.30	54.00	-19.70	AVG

Test mode:	802.11n(HT20)	Test channel:	Middle
------------	---------------	---------------	--------

H

Frequency (MHz)	Meter Reading (dB μ V)	Factor (dB)	Emission Level (dB μ V/m)	Limits (dB μ V/m)	Margin (dB)	Detector Type
4874.000	41.63	5.13	46.76	74.00	-27.24	PEAK
4874.000	28.75	5.13	33.88	54.00	-20.12	AVG
7311.000	40.01	7.49	47.50	74.00	-26.50	PEAK
7311.000	26.78	7.49	34.27	54.00	-19.73	AVG

V

Frequency (MHz)	Meter Reading (dB μ V)	Factor (dB)	Emission Level (dB μ V/m)	Limits (dB μ V/m)	Margin (dB)	Detector Type
4874.000	42.84	5.13	47.97	74.00	-26.03	PEAK
4874.000	29.33	5.13	34.46	54.00	-19.54	AVG
7311.000	39.25	7.49	46.74	74.00	-27.26	PEAK
7311.000	26.93	7.49	34.42	54.00	-19.58	AVG

Test mode:	802.11n(HT20)	Test channel:	Highest
------------	---------------	---------------	---------

H

Frequency (MHz)	Meter Reading (dB μ V)	Factor (dB)	Emission Level (dB μ V/m)	Limits (dB μ V/m)	Margin (dB)	Detector Type
4924.000	42.61	5.18	47.79	74.00	-26.21	PEAK
4924.000	29.75	5.18	34.93	54.00	-19.07	AVG
7386.000	40.03	7.82	47.85	74.00	-26.15	PEAK
7386.000	26.95	7.82	34.77	54.00	-19.23	AVG

V

Frequency (MHz)	Meter Reading (dB μ V)	Factor (dB)	Emission Level (dB μ V/m)	Limits (dB μ V/m)	Margin (dB)	Detector Type
4924.000	42.69	5.18	47.87	74.00	-26.13	PEAK
4924.000	29.43	5.18	34.61	54.00	-19.39	AVG
7386.000	40.36	7.82	48.18	74.00	-25.82	PEAK
7386.000	27.14	7.82	34.96	54.00	-19.04	AVG

Test mode:	802.11n(HT40)	Test channel:	Lowest
------------	---------------	---------------	--------

H

Frequency (MHz)	Meter Reading (dB μ V)	Factor (dB)	Emission Level (dB μ V/m)	Limits (dB μ V/m)	Margin (dB)	Detector Type
4844.000	42.89	5.11	48.00	74.00	-26.00	PEAK
4844.000	29.56	5.11	34.67	54.00	-19.33	AVG
7266.000	40.14	7.29	47.43	74.00	-26.57	PEAK
7266.000	27.32	7.29	34.61	54.00	-19.39	AVG

V

Frequency (MHz)	Meter Reading (dB μ V)	Factor (dB)	Emission Level (dB μ V/m)	Limits (dB μ V/m)	Margin (dB)	Detector Type
4844.000	43.15	5.11	48.26	74.00	-25.74	PEAK
4844.000	28.46	5.11	33.57	54.00	-20.43	AVG
7266.000	40.05	7.29	47.34	74.00	-26.66	PEAK
7266.000	27.22	7.29	34.51	54.00	-19.49	AVG

Test mode:	802.11n(HT40)	Test channel:	Middle
------------	---------------	---------------	--------

H

Frequency (MHz)	Meter Reading (dB μ V)	Factor (dB)	Emission Level (dB μ V/m)	Limits (dB μ V/m)	Margin (dB)	Detector Type
4874.000	42.91	5.13	48.04	74.00	-25.96	PEAK
4874.000	30.04	5.13	35.17	54.00	-18.83	AVG
7311.000	40.24	7.49	47.73	74.00	-26.27	PEAK
7311.000	26.78	7.49	34.27	54.00	-19.73	AVG

V

Frequency (MHz)	Meter Reading (dB μ V)	Factor (dB)	Emission Level (dB μ V/m)	Limits (dB μ V/m)	Margin (dB)	Detector Type
4874.000	42.82	5.13	47.95	74.00	-26.05	PEAK
4874.000	29.63	5.13	34.76	54.00	-19.24	AVG
7311.000	40.14	7.49	47.63	74.00	-26.37	PEAK
7311.000	27.56	7.49	35.05	54.00	-18.95	AVG

Test mode:	802.11n(HT40)	Test channel:	Highest
------------	---------------	---------------	---------

H

Frequency (MHz)	Meter Reading (dBμV)	Factor (dB)	Emission Level (dBμV/m)	Limits (dBμV/m)	Margin (dB)	Detector Type
4904.000	43.15	5.16	48.31	74.00	-25.69	peak
4904.000	30.39	5.16	35.55	54.00	-18.45	AVG
7356.000	40.45	7.69	48.14	74.00	-25.86	peak
7356.000	27.36	7.69	35.05	54.00	-18.95	AVG

V

Frequency (MHz)	Meter Reading (dBμV)	Factor (dB)	Emission Level (dBμV/m)	Limits (dBμV/m)	Margin (dB)	Detector Type
4904.000	42.75	5.16	47.91	74.00	-26.09	peak
4904.000	30.14	5.16	35.30	54.00	-18.70	AVG
7356.000	40.01	7.69	47.70	74.00	-26.30	peak
7356.000	27.89	7.69	35.58	54.00	-18.42	AVG

Remark:

- 1 Final Level = Receiver Read level + Antenna Factor + Cable Loss – Preamplifier Factor
- 2 “**”, means this data is the too weak instrument of signal is unable to test.
3. The emission levels of other frequencies are very lower than the limit and not show in test report.

8 Test Setup Photo

Reference to the **appendix I** for details.

9 EUT Constructional Details

Reference to the **appendix II** for details.

-----End-----