



RADIO TEST REPORT

Report No.: STS2009272W04

Issued for

DTEN Inc

97 E Brokaw Road suite 180 San Jose CA 95112

Product Name:	DTEN ME
Brand Name:	DTEN
Model Name:	DBA0027
Series Model:	N/A
FCC ID:	2AQ7Q-DBA0027
Test Standard:	FCC Part 15.407

Any reproduction of this document must be done in full. No single part of this document may be reproduced without permission from STS, all test data presented in this report is only applicable to presented test sample.

Shenzhen STS Test Services Co., Ltd.
A 1/F, Building B, Zhuoke Science Park, No.190 Chongqing Road, HepingShequ,
Fuyong Sub-District, Bao'an District, Shenzhen, Guang Dong, China
TEL: +86-755 3688 6288 FAX: +86-755 3688 6277 E-mail: sts@stsapp.com





TEST RESULT CERTIFICATION

Applicant's Name..... : DTEN Inc
 Address : 97 E Brokaw Road suite 180 San Jose CA 95112
Manufacturer's Name : DTEN Inc
 Address : 97 E Brokaw Road suite 180 San Jose CA 95112

Product Description

Product Name..... : DTEN ME
 Brand Name : DTEN
 Model Name : DBA0027
 Series Model..... : N/A

Test Standards : FCC Part15.407

Test Procedure..... ANSI C63.10-2013

This device described above has been tested by STS, the test results show that the equipment under test (EUT) is in compliance with the FCC requirements. And it is applicable only to the tested sample identified in the report.

This report shall not be reproduced except in full, without the written approval of STS, this document only be altered or revised by STS, personal only, and shall be noted in the revision of the document.

Date of Test..... :
 Date of receipt of test item : 23 Sept. 2020
 Date (s) of performance of tests : 23 Sept. 2020 ~ 30 Oct. 2020
 Date of Issue..... : 30 Oct. 2020
 Test Result..... : **Pass**

Testing Engineer : 

 (Chris Chen)

Technical Manager : 

 (Sean she)

Authorized Signatory : 

 (Vita Li)





Table of Contents	Page
1 . SUMMARY OF TEST RESULTS	6
1.1 TEST FACTORY	7
1.2 MEASUREMENT UNCERTAINTY	7
2 . GENERAL INFORMATION	8
2.1 GENERAL DESCRIPTION OF THE EUT	8
2.2 DESCRIPTION OF TEST MODES	12
2.3 TEST SOFTWARE AND POWER LEVEL	13
2.4 BLOCK DIAGRAM SHOWING THE CONFIGURATION OF SYSTEM TESTED	14
2.5 DESCRIPTION OF NECESSARY ACCESSORIES AND SUPPORT UNITS	15
2.6 EQUIPMENTS LIST FOR ALL TEST ITEMS	16
3 . EMC EMISSION TEST	18
3.1 CONDUCTED EMISSION MEASUREMENT	18
3.2 RADIATED EMISSION AND (BANDEDGE) MEASUREMENT	22
4. POWER SPECTRAL DENSITY TEST	61
4.1 LIMIT	61
4.2 TEST PROCEDURE	61
4.3 DEVIATION FROM STANDARD	62
4.4 TEST SETUP	62
4.5 EUT OPERATION CONDITIONS	62
4.6 TEST RESULTS	62
5. BANDWIDTH MEASUREMENT	66
5.1 EMISSION BANDWIDTH (EBW) 26 BANDWID PROCEDURES / LIMIT	66
5.2 OCCUPIED BANDWIDTH (99%) TEST APPLIED PROCEDURES / LIMIT	69
5.3 MINIMUM EMISSION BANDWIDTH(6 DB) PROCEDURES / LIMIT	72
6. MAXIMUM CONDUCTED OUTPUT POWER	74
6.1 LIMIT	74
6.2 TEST PROCEDURE	74
6.3 DEVIATION FROM STANDARD	74
6.4 TEST SETUP	74
6.5 EUT OPERATION CONDITIONS	74
6.6 TEST RESULTS	75
7. AUTOMATICALLY DISCONTINUE TRANSMISSION	86
7.1 LIMIT OF AUTOMATICALLY DISCONTINUE TRANSMISSION	86
7.2 TEST RESULT OF AUTOMATICALLY DISCONTINUE TRANSMISSION	86



Table of Contents	Page
8. ANTENNA REQUIREMENT	87
8.1 STANDARD REQUIREMENT	87
8.2 EUT ANTENNA	87
APPENDIX - PHOTOS OF TEST SETUP	88





Revision History

Rev.	Issue Date	Report NO.	Effect Page	Contents
00	30 Oct. 2020	STS2009272W04	ALL	Initial Issue





1. SUMMARY OF TEST RESULTS

Test procedures according to the technical standards:

§ 15.407, KDB 789033 D02 General U-NII Test Procedures New Rules v02r01

FCC Part 15.407		
FCC standard	Test Item	Results
15.207	AC Conducted Emission	PASS
15.407 (a) /15.407 (e)	26dB/6dB &99% Bandwidth	PASS
15.407(a)	Maximum Conducted Output Power	PASS
15.407(b)/15.205/15.209	Radiated Emission And (bandedge Emissions) Measurement	PASS
15.407(a)	Power Spectral Density	PASS
15.407(c)	Automatically Discontinue Transmission	PASS
15.203/15.204	Antenna Requirement	PASS

NOTE:

- (1) 'N/A' denotes test is not applicable in this Test Report.
- (2) All tests are according to ANSI C63.10-2013.



1.1 TEST FACTORY

SHENZHEN STS TEST SERVICES CO., LTD

Add. : A 1/F, Building B, Zhuoke Science Park, No.190 Chongqing Road, HepingShequ, Fuyong Sub-District, Bao'an District, Shenzhen, Guang Dong, China

FCC test Firm Registration Number: 625569

IC test Firm Registration Number: 12108A

A2LA Certificate No.: 4338.01

1.2 MEASUREMENT UNCERTAINTY

The reported uncertainty of measurement $y \pm U$, where expanded uncertainty U is based on a standard uncertainty multiplied by a coverage factor of $k=2$, providing a level of confidence of approximately **95 %**.

No.	Item	Uncertainty
1	RF output power, conducted	$\pm 0.68\text{dB}$
2	Unwanted Emissions, conducted	$\pm 2.988\text{dB}$
3	All emissions, radiated 30-1GHz	$\pm 5.6\text{dB}$
4	All emissions, radiated 1G-6GHz	$\pm 5.5\text{dB}$
5	All emissions, radiated >6G	$\pm 5.8\text{dB}$
6	Conducted Emission (9KHz-150KHz)	$\pm 3.37\text{dB}$
7	Conducted Emission (150KHz-30MHz)	$\pm 3.83\text{dB}$



2. GENERAL INFORMATION

2.1 GENERAL DESCRIPTION OF THE EUT

Product Name	DTEN ME	
Trade Name	DTEN	
Model Name	DBA0027	
Series Model	N/A	
Model Difference	N/A	
Product Description	The EUT is a DTEN ME	
	Operation Frequency:	IEEE 802.11a/ n(HT20)/ac(VHT20): 5.180GHz-5.240GHz IEEE 802.11n(HT40)/ac(VHT40): 5.190GHz-5.230GHz IEEE 802.11ac(VHT80): 5.210GHz
		IEEE 802.11a/ n(HT20)/ac(VHT20): 5.260GHz-5.320GHz IEEE 802.11 n(HT40)/ac(VHT40): 5.270GHz-5.310GHz IEEE 802.11ac(VHT80): 5.290GHz
		IEEE 802.11a/ n(HT20)/ac(VHT20): 5.500GHz-5.700GHz IEEE 802.11 n(HT40)/ac(VHT40): 5.510GHz-5.670GHz IEEE 802.11ac(VHT80): 5.530GHz-5.610GHz
		IEEE 802.11a/ n(HT20)/ac(VHT20): 5.745GHz-5.825GHz IEEE 802.11a/ n(HT40)/ac(VHT40): 5.755GHz-5.795GHz IEEE 802.11ac(VHT80): 5.775GHz
	Modulation Type:	802.11a(OFDM): BPSK,QPSK,16-QAM,64-QAM 802.11n(OFDM): BPSK,QPSK,16-QAM,64-QAM 802.11ac(OFDM): BPSK,QPSK,16-QAM,64-QAM,256-QAM
	Antenna Designation:	Please refer to the Note 3.
	Max.Output Power(Conducted):	10.78 dBm
		More details of EUT technical specification, please refer to the User Manual.
	Test Channel	Please refer to the Note 2.
Adapter	Input: AC 100-240V 50/60Hz 2.5A Output: 19V---4.73A	
Hardware version number	DBO0427-OPS-A311D-MAIN Rev P4	
Software version number	S1a_A311D_dten_s27_S1-004-0.2.0.0-20200702	
Connecting I/O Port(s)	Please refer to the Note 1.	



Note

1. For a more detailed features description, please refer to the manufacturer's specifications or the User Manual.

2.

Operation Frequency of channel			
5.180GHz-5.240GHz		5.500GHz-5.720GHz	
Channel	Frequency	Channel	Frequency
36	5180	100	5500
38	5190	102	5510
40	5200	104	5520
42	5210	106	5530
44	5220	108	5540
46	5230	110	5550
48	5240	112	5560
		116	5580
		118	5590
5.260GHz-5.320GHz		120	5600
Channel	Frequency	122	5610
52	5260	124	5620
54	5270	126	5630
56	5280	128	5640
58	5290	132	5660
60	5300	134	5670
62	5310	136	5680
64	5320	140	5700
5.745GHz-5.825GHz			
Channel	Frequency		
149	5745		
151	5755		
153	5765		
157	5785		
159	5795		
161	5805		
165	5825		

Note:

In section 15.31(m), regards to the operating frequency range over 10 MHz, the Lowest frequency, the middle frequency, and the highest frequency of channel were selected to perform the test, and the selected channel see below:

Carrier Frequency Channel

5GHz:

For 802.11a/n(HT20)/ac(VHT20)			
Channel	Freq.(MHz)	Channel	Freq.(MHz)
36	5180	52	5260
40	5200	60	5300
48	5240	64	5320



For 802.11a/n(HT20)/ac(VHT20)			
Channel	Freq.(MHz)	Channel	Freq.(MHz)
100	5500	149	5745
116	5580	157	5785
140	5700	165	5825

For 802.11 n(HT40)/ac(VHT40)			
Channel	Freq.(MHz)	Channel	Freq.(MHz)
38	5190	54	5270
46	5230	62	5310

For 802.11 n(HT40)/ac(VHT40)			
Channel	Freq.(MHz)	Channel	Freq.(MHz)
102	5510	151	5755
110	5550	159	5795
134	5670		

For 802.11ac (VHT80)			
Channel	Freq.(MHz)	Channel	Freq.(MHz)
42	5210	58	5290

For 802.11ac (VHT80)			
Channel	Freq.(MHz)	Channel	Freq.(MHz)
106	5530	155	5775
122	5610		

3. Emissions Testing of Transmitters with Multiple Outputs in the Same Band.

For devices having two outputs driving a cross-polarized pair of antennas, see Attachment 662911 D02 of this publication for additional guidance.

d) *Unequal antenna gains, with equal transmit powers.* For antenna gains given by G1, G2, ..., GN dBi

(i) If transmit signals are *correlated*, then Directional gain = $10 \log[(10^{G1/20} + 10^{G2/20} + \dots + 10^{GN/20})^2 / \text{NANT}]$ dBi [Note the "20"s in the denominator of each exponent and the square of the sum of terms; the object is to combine the signal levels coherently.]

(ii) If all transmit signals are *completely uncorrelated*, then Directional gain = $10 \log[(10^{G1/10} + 10^{G2/10} + \dots + 10^{GN/10}) / \text{NANT}]$ dBi

Note: If transmit signals are *correlated*, then Directional gain.



Band 1:

ANT-A=5.47 dBi

ANT-B=5.96 dBi

Total gain=10 log $[(10^{G^1/20} + 10^{G^2/20} + \dots + 10^{G^N/20})^2 / NANT]$ dBi

10*LOG10((10^(5.47/20))+(10^(5.96/20))^2/2)=8.73

Band 2:

ANT-A=5.83 dBi

ANT-B=6.32 dBi

Total gain=10 log $[(10^{G^1/20} + 10^{G^2/20} + \dots + 10^{G^N/20})^2 / NANT]$ dBi

10*LOG10((10^(5.83/20))+(10^(6.32/20))^2/2)=9.09

Band 3:

ANT-A=5.80 dBi

ANT-B=7.02 dBi

Total gain=10 log $[(10^{G^1/20} + 10^{G^2/20} + \dots + 10^{G^N/20})^2 / NANT]$ dBi

10*LOG10((10^(5.80/20))+(10^(7.02/20))^2/2)=9.44

Band 4:

ANT-A=6.2 dBi

ANT-B=6.6 dBi

Total gain=10 log $[(10^{G^1/20} + 10^{G^2/20} + \dots + 10^{G^N/20})^2 / NANT]$ dBi

10*LOG10((10^(6.2/20))+(10^(6.6/20))^2/2)=9.41

Ant	Brand	Model Name	Ant Type	Connector	Gain (dBi)	NOTE
A	DTEN	DBA0027	PIFA Antenna	N/A	Band 1:Ant A: 5.47 Ant B: 5.96 MIMO: 8.73 Band 2: Ant A: 5.83 Ant B: 6.32 MIMO: 9.09 Band 3: Ant A: 5.80 Ant B: 7.02 MIMO: 9.44 Band 4: Ant A: 6.2 Ant B: 6.6 MIMO: 9.41	WLAN Ant



2.2 DESCRIPTION OF TEST MODES

To investigate the maximum EMI emission characteristics generates from EUT, the test system was pre-scanning tested base on the consideration of following EUT operation mode or test configuration mode which possible have effect on EMI emission level. Each of these EUT operation mode(s) or test configuration mode(s) mentioned above was evaluated respectively.

Worst Mode	Description	Data Rate
Mode 1	TX IEEE 802.11a HT20 CH36&CH40&CH48	6 Mbps
Mode 2	TX IEEE 802.11a HT20 CH52&CH60&CH64	6 Mbps
Mode 3	TX IEEE 802.11a HT20 CH100&CH116&CH140	6 Mbps
Mode 4	TX IEEE 802.11a HT20 CH149&CH157&CH165	6 Mbps
Mode 5	TX IEEE 802.11n HT20 CH36&CH40&CH48	MCS 0
Mode 6	TX IEEE 802.11ac HT20 CH36&CH40&CH48	NSS1 MCS0
Mode 7	TX IEEE 802.11n HT20 CH52&CH60&CH64	MCS 0
Mode 8	TX IEEE 802.11ac HT20 CH52&CH60&CH64	NSS1 MCS0
Mode 9	TX IEEE 802.11n HT20 CH100&CH116&CH140	MCS 0
Mode 10	TX IEEE 802.11ac HT20 CH100&CH116&CH140	NSS1 MCS0
Mode 11	TX IEEE 802.11n HT20 CH149&CH157&CH165	MCS 0
Mode 12	TX IEEE 802.11ac HT20 CH149&CH157&CH165	NSS1 MCS0
Mode 13	TX IEEE 802.11n HT40 CH38&CH46	MCS 0
Mode 14	TX IEEE 802.11ac HT40 CH38&CH46	NSS1 MCS0
Mode 15	TX IEEE 802.11n HT40 CH54 &CH62	MCS 0
Mode 16	TX IEEE 802.11ac HT40 CH54 &CH62	NSS1 MCS0
Mode 17	TX IEEE 802.11n HT40 CH102&CH110&CH134	MCS 0
Mode 18	TX IEEE 802.11ac HT40 CH102&CH110&CH134	NSS1 MCS0
Mode 19	TX IEEE 802.11n HT40 CH151&CH159	MCS 0
Mode 20	TX IEEE 802.11ac HT40 CH151&CH159	NSS1 MCS0
Mode 21	TX IEEE 802.11ac HT80 CH42	NSS1 MCS0
Mode 22	TX IEEE 802.11ac HT80 CH58	NSS1 MCS0
Mode 23	TX IEEE 802.11ac HT80 CH106&122	NSS1 MCS0
Mode 24	TX IEEE 802.11ac HT80 CH155	NSS1 MCS0

- Note: (1) The measurements are performed at the highest, middle, lowest available channels.
 (2) The measurements are performed at all Bit Rate of Transmitter, the worst data was reported.
 (3) We have be tested for all avaiable U.S. voltage and frequencies(For 120V,50/60Hz and 240V, 50/60Hz) for which the device is capable of operation.
 (4) The battery is fully-charged during the radited and RF conducted test.



AC Conducted Emission

Test Case	
AC Conducted Emission	Mode 25: Keeping TX + WLAN Link

2.3 TEST SOFTWARE AND POWER LEVEL

During testing channel & power controlling software provided by the customer was used to control the operating channel as well as the output power level.

RF Function	Type	Mode Or Modulation type	Ant Gain(dBi)	Ant_A Power Class	Ant_B Power Class	Software For Testing
WIFI(5G)	5G WIFI Band1 (5150MHz-5250MHz)	802.11a	Ant A: 5.47 Ant B: 5.96 MIMO: 8.73	8	8	adb command
		802.11n(HT20)		6	6	
		802.11n(HT40)		6	6	
		802.11ac(VHT20)		6	6	
		802.11ac(VHT40)		6	6	
		802.11ac(VHT80)		6	6	
WIFI(5G)	5G WIFI Band2 (5250MHz-5350MHz)	802.11a	Ant A: 5.83 Ant B: 6.32 MIMO: 9.09	7	7	adb command
		802.11n(HT20)		6	6	
		802.11n(HT40)		6	6	
		802.11ac(VHT20)		6	6	
		802.11ac(VHT40)		6	6	
		802.11ac(VHT80)		6	6	
WIFI(5G)	5G WIFI Band3 (5470MHz-5725MHz)	802.11a	Ant A: 5.80 Ant B: 7.02 MIMO: 9.44	10	10	adb command
		802.11n(HT20)		10	10	
		802.11n(HT40)		10	10	
		802.11ac(VHT20)		10	10	
		802.11ac(VHT40)		10	10	
		802.11ac(VHT80)		10	10	

RF Function	Type	Mode Or Modulation type	Ant Gain(dBi)	Ant_A Power Class	Ant_B Power Class	Software For Testing
WIFI(5G)	5G WIFI Band4 (5725MHz-5875MHz)	802.11a	Ant A: 6.2 Ant B: 6.6 MIMO: 9.41	6	6	adb command
		802.11n(HT20)		6	6	
		802.11n(HT40)		6	6	
		802.11ac(VHT20)		6	6	
		802.11ac(VHT40)		6	6	
		802.11ac(VHT80)		6	6	

2.4 BLOCK DIAGRAM SHOWING THE CONFIGURATION OF SYSTEM TESTED

Radiated Spurious Emission Test

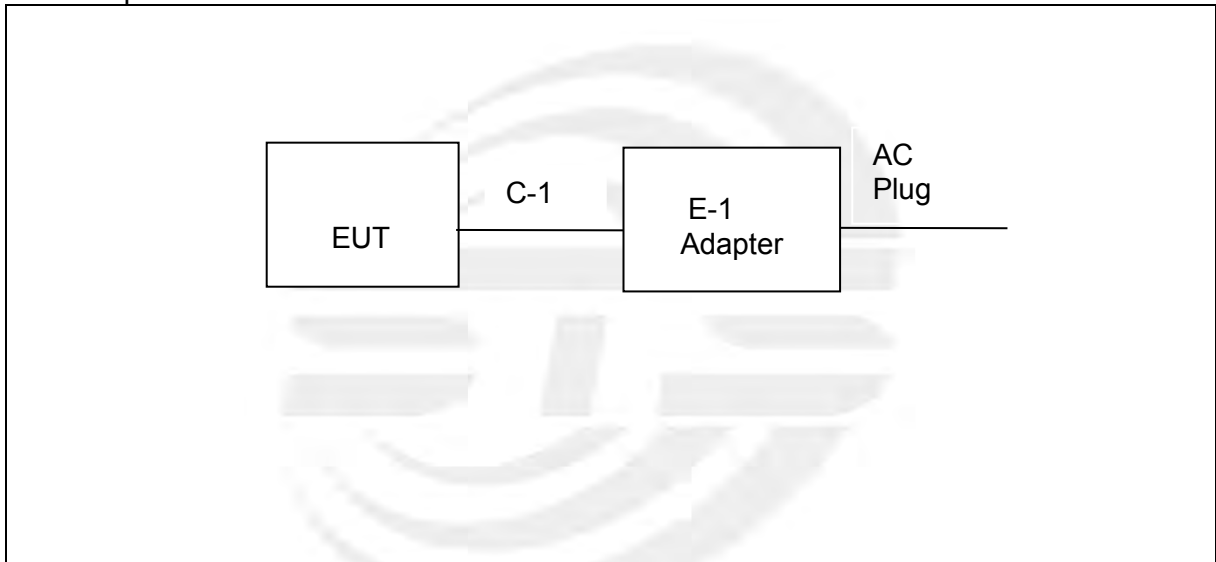

Conducted Emission Test

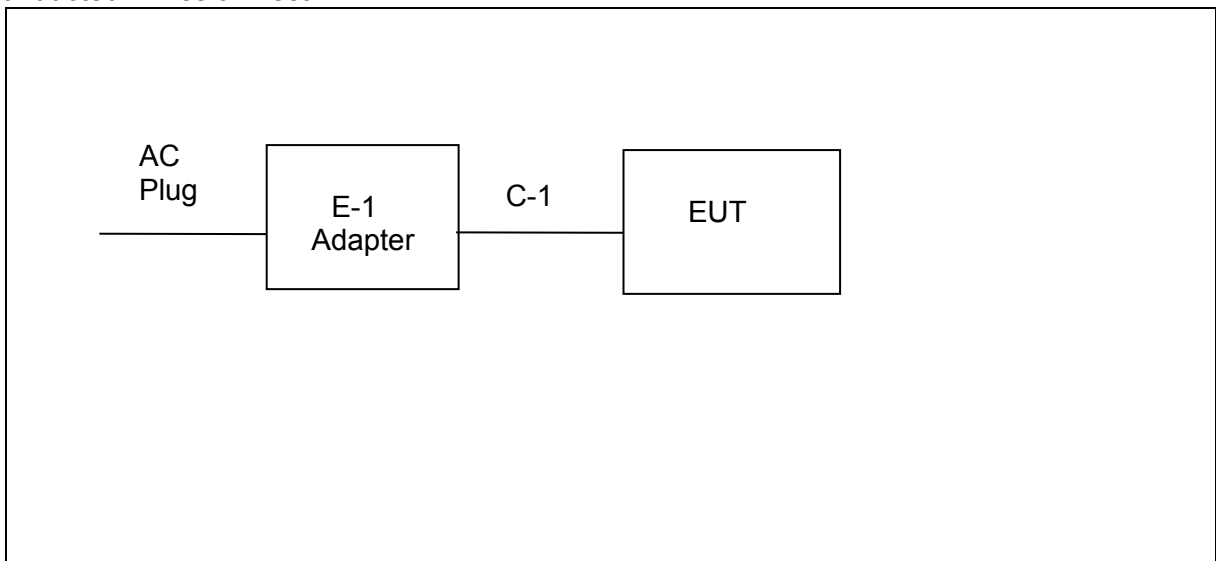



2.5 DESCRIPTION OF NECESSARY ACCESSORIES AND SUPPORT UNITS

The EUT has been tested as an independent unit together with other necessary accessories or support units. The following support units or accessories were used to form a representative test configuration during the tests.

Necessary accessories

Item	Equipment	Mfr/Brand	Model/Type No.	Length	Note
E-1	Adapter	DTEN	DAP01	N/A	N/A
C-1	Power Cord	N/A	N/A	200cm	N/A

Support units

Item	Equipment	Mfr/Brand	Model/Type No.	Length	Note
N/A	N/A	N/A	N/A	N/A	N/A

Note:

- (1) For detachable type I/O cable should be specified the length in cm in 『Length』 column.

**2.6 EQUIPMENTS LIST FOR ALL TEST ITEMS**

Radiation Test equipment

Kind of Equipment	Manufacturer	Type No.	Serial No.	Last calibration	Calibrated until
Test Receiver	R&S	ESCI	101427	2020.10.12	2022.10.11
Signal Analyzer	R&S	FSV 40-N	101823	2020.10.10	2021.10.09
Active loop Antenna	ZHINAN	ZN30900C	16035	2019.07.11	2021.07.10
Bilog Antenna	TESEQ	CBL6111D	34678	2020.10.12	2022.10.11
Horn Antenna	SCHWARZBECK	BBHA 9120D	02014	2019.10.15	2021.10.14
SHF-EHF Horn Antenna (18G-40GHz)	A-INFO	LB-180400-KF	J211020657	2020.10.12	2022.10.11
Pre-Amplifier (0.1M-3GHz)	EM	EM330	060665	2020.10.12	2021.10.11
Pre-Amplifier (1G-18GHz)	SKET	LNPA-01018G-45	SK2018080901	2020.10.12	2021.10.11
Pre-Amplifier (18G-40GHz)	SKET	LNPA-1840-50	SK2018101801	2020.10.10	2021.10.09
Temperature & Humidity	HH660	Mieo	N/A	2020.10.13	2021.10.12
Turn table	EM	SC100_1	60531	N/A	N/A
Antenna mast	EM	SC100	N/A	N/A	N/A
Test SW	FARAD	EZ-EMC(Ver.STSLAB-03A1 RE)			

Conduction Test equipment

Kind of Equipment	Manufacturer	Type No.	Serial No.	Last calibration	Calibrated until
Test Receiver	R&S	ESCI	101427	2020.10.12	2022.10.11
LISN	R&S	ENV216	101242	2020.10.12	2022.10.11
LISN	EMCO	3810/2NM	23625	2020.10.12	2022.10.11
Temperature & Humidity	HH660	Mieo	N/A	2020.10.13	2021.10.12
Test SW	FARAD	EZ-EMC(Ver.STSLAB-03A1 CE)			



RF Connected Test

Kind of Equipment	Manufacturer	Type No.	Serial No.	Last calibration	Calibrated until
MIMO Power measurement test Set	Keysight	U2021XA	MY55520005	2020.10.10	2021.10.09
			MY55520006	2020.10.10	2021.10.09
			MY56120038	2020.10.10	2021.10.09
			MY56280002	2020.10.10	2021.10.09
Signal Analyzer	Agilent	N9020A	MY51110105	2020.03.05	2021.03.04
Temperature & Humidity	HH660	Mieo	N/A	2020.10.13	2021.10.12
Test SW	FARAD	LZ-RF /LzRf-3A3			





3. EMC EMISSION TEST

3.1 CONDUCTED EMISSION MEASUREMENT

3.1.1 POWER LINE CONDUCTED EMISSION Limits (Frequency Range 150KHz-30MHz)

FREQUENCY (MHz)	Class B (dBuV)		Standard
	Quasi-peak	Average	
0.15 -0.5	66 - 56 *	56 - 46 *	CISPR
0.50 -5.0	56.00	46.00	CISPR
5.0 -30.0	60.00	50.00	CISPR

0.15 -0.5	66 - 56 *	56 - 46 *	FCC
0.50 -5.0	56.00	46.00	FCC
5.0 -30.0	60.00	50.00	FCC

Note:

- (1) The tighter limit applies at the band edges.
- (2) The limit of “ * ” marked band means the limitation decreases linearly with the logarithm of the frequency in the range.

The following table is the setting of the receiver

Receiver Parameters	Setting
Attenuation	10 dB
Start Frequency	0.15 MHz
Stop Frequency	30 MHz
IF Bandwidth	9 kHz

3.1.2 TEST PROCEDURE

- a. The EUT is 0.8 m from the horizontal ground plane and 0.4 m from the vertical ground plane with EUT being connected to the power mains through a line impedance stabilization network (LISN). All other support equipments are powered from additional LISN(s). The LISN provides 50 Ohm/ 50uH of coupling impedance for the measuring instrument.
- b. Interconnecting cables that hang closer than 40 cm to the ground plane shall be folded back and forth in the center forming a bundle 30 to 40 cm long.
- c. I/O cables that are not connected to a peripheral shall be bundled in the center. The end of the cable may be terminated, if required, using the correct terminating impedance. The overall length shall not exceed 1 m.
- d. LISN is at least 80 cm from the nearest part of EUT chassis.
- e. For the actual test configuration, please refer to the related Item –EUT Test Photos.

3.1.3 DEVIATION FROM TEST STANDARD

No deviation

3.1.4 TEST SETUP

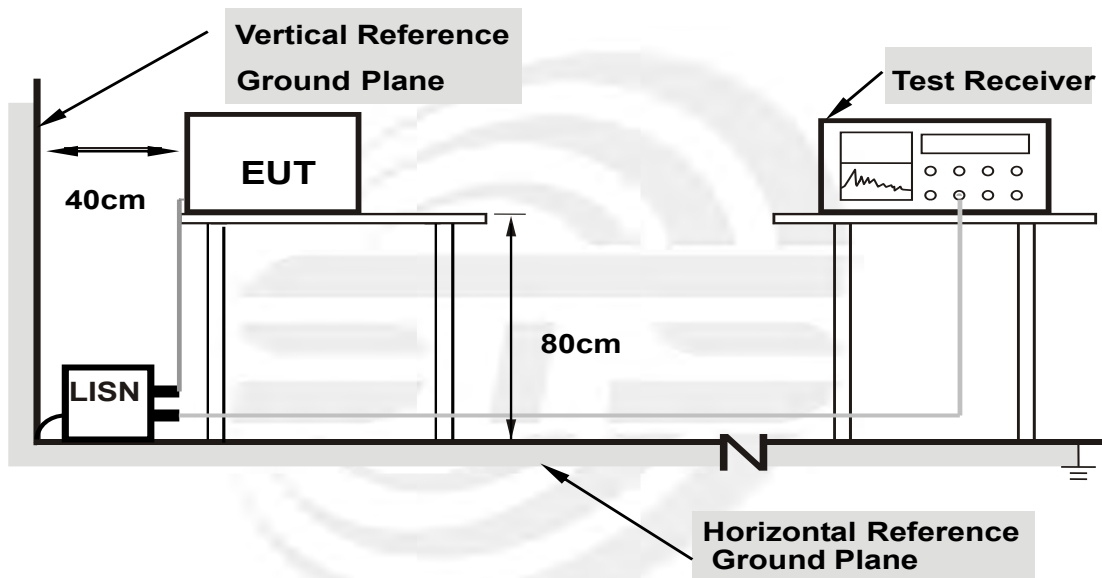

- Note: 1. Support units were connected to second LISN.**
2. Both of LISNs (AMN) are 80 cm from EUT and at least 80 cm from other units and other metal planes support units.

3.1.5 EUT OPERATING CONDITIONS

The EUT was configured for testing in a typical fashion (as a customer would normally use it). The EUT has been programmed to continuously transmit during test. This operating condition was tested and used to collect the included data.



3.1.6 TEST RESULTS

Temperature:	27.5(C)	Relative Humidity:	69%RH
Test Voltage:	AC 120V/60Hz	Phase:	L
Test Mode :	Mode 25		

No.	Frequency (MHz)	Reading (dBuV)	Correct Factor(dB)	Result (dBuV)	Limit (dBuV)	Margin (dB)	Remark
1	0.1660	29.57	20.23	49.80	65.16	-15.36	QP
2	0.1660	13.02	20.23	33.25	55.16	-21.91	AVG
3	0.4700	25.19	20.48	45.67	56.51	-10.84	QP
4	0.4700	17.85	20.48	38.33	46.51	-8.18	AVG
5	0.9820	22.98	20.16	43.14	56.00	-12.86	QP
6	0.9820	19.38	20.16	39.54	46.00	-6.46	AVG
7	1.9620	22.11	20.06	42.17	56.00	-13.83	QP
8	1.9620	15.42	20.06	35.48	46.00	-10.52	AVG
9	7.1900	19.56	19.92	39.48	60.00	-20.52	QP
10	7.1900	5.97	19.92	25.89	50.00	-24.11	AVG
11	20.3180	18.04	20.63	38.67	60.00	-21.33	QP
12	20.3180	15.45	20.63	36.08	50.00	-13.92	AVG

Remark:

1. All readings are Quasi-Peak and Average values
2. Margin = Result (Result = Reading + Factor) – Limit
3. Factor=LISN factor+Cable loss+Limiter (10dB)

100.0 dBuV

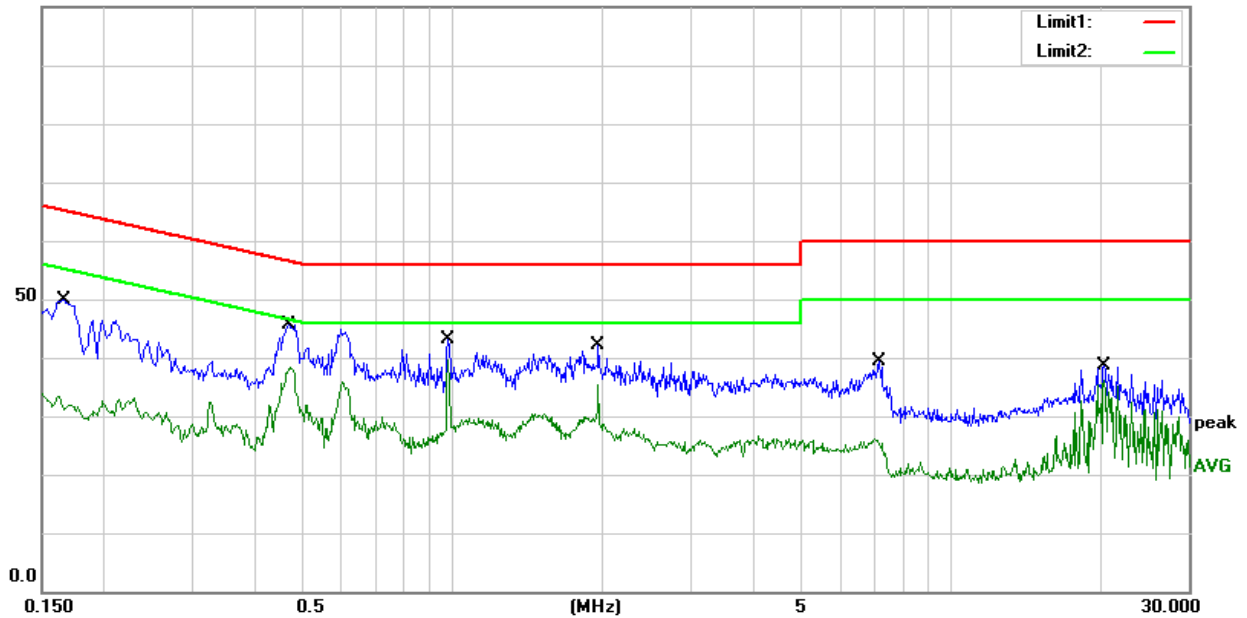



Temperature:	27.5(C)	Relative Humidity:	69%RH
Test Voltage	AC 120V/60Hz	Phase:	N
Test Mode	Mode 25		

No.	Frequency (MHz)	Reading (dBuV)	Correct Factor(dB)	Result (dBuV)	Limit (dBuV)	Margin (dB)	Remark
1	0.1700	29.85	20.23	50.08	64.96	-14.88	QP
2	0.1700	10.73	20.23	30.96	54.96	-24.00	AVG
3	0.4780	25.75	20.48	46.23	56.37	-10.14	QP
4	0.4780	18.68	20.48	39.16	46.37	-7.21	AVG
5	0.9820	23.08	20.16	43.24	56.00	-12.76	QP
6	0.9820	18.67	20.16	38.83	46.00	-7.17	AVG
7	1.9620	18.84	20.06	38.90	56.00	-17.10	QP
8	1.9620	13.01	20.06	33.07	46.00	-12.93	AVG
9	7.3340	19.42	19.93	39.35	60.00	-20.65	QP
10	7.3340	8.23	19.93	28.16	50.00	-21.84	AVG
11	20.2580	19.16	20.63	39.79	60.00	-20.21	QP
12	20.2580	16.88	20.63	37.51	50.00	-12.49	AVG

Remark:

1. All readings are Quasi-Peak and Average values
2. Margin = Result (Result =Reading + Factor) –Limit
3. Factor=LISN factor+Cable loss+Limiter (10dB)

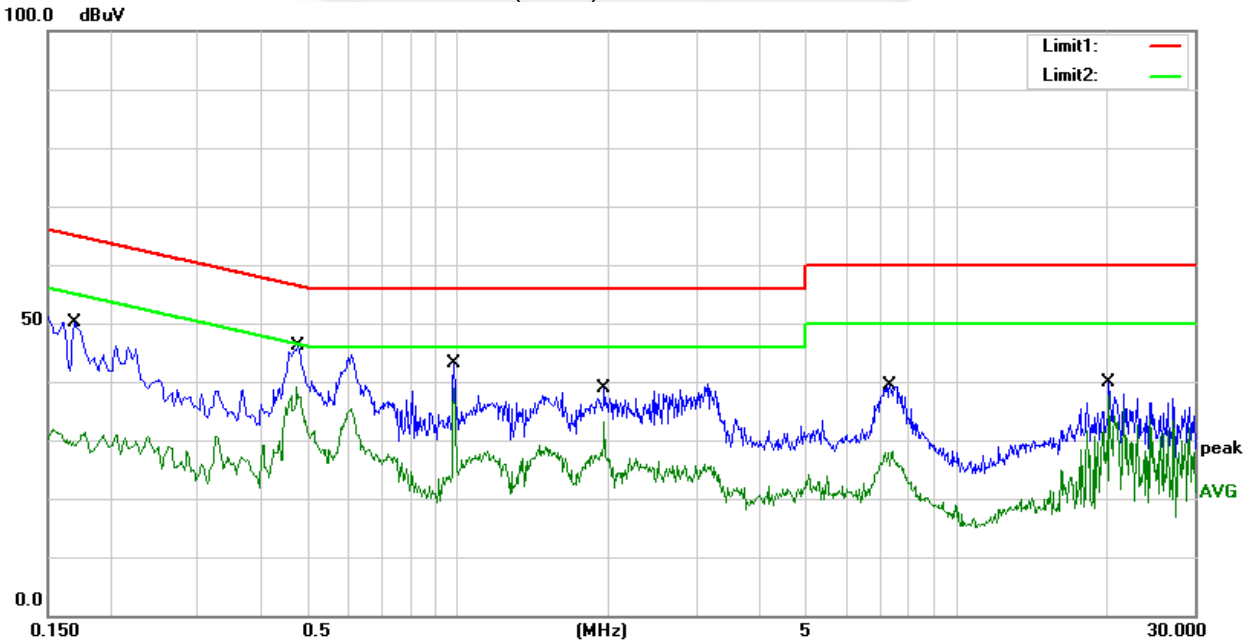



3.2 RADIATED EMISSION AND (BANDEGE) MEASUREMENT

3.2.1 RADIATED EMISSION LIMITS (Frequency Range 9kHz-1000MHz)

In case the emission fall within the restricted band specified on 15.407(b)7&15.205/209(a), then the limit in the table below has to be followed.

Frequencies (MHz)	Field Strength (microrvolts/meter)	Measurement Distance (meters)
0.009~0.490	2400/F(KHz)	300
0.490~1.705	24000/F(KHz)	30
1.705~30.0	30	30
30~88	100	3
88~216	150	3
216~960	200	3
Above 960	500	3

LIMITS OF RADIATED EMISSION MEASUREMENT (Above 1000MHz)

FREQUENCY (MHz)	Class B (dBuV/m) (at 3M)	
	PEAK	AVERAGE
Above 1000	68.2	54

Notes:

- (1) The limit for radiated test was performed according to FCC PART 15E.
- (2) The tighter limit applies at the band edges.
- (3) Emission level (dBuV/m)=20log Emission level (uV/m).

LIMITS OF RESTRICTED FREQUENCY BANDS

FREQUENCY (MHz)	FREQUENCY (MHz)	FREQUENCY (MHz)	FREQUENCY (GHz)
0.090-0.110	16.42-16.423	399.9-410	4.5-5.15
0.495-0.505	16.69475-16.69525	608-614	5.35-5.46
2.1735-2.1905	16.80425-16.80475	960-1240	7.25-7.75
4.125-4.128	25.5-25.67	1300-1427	8.025-8.5
4.17725-4.17775	37.5-38.25	1435-1626.5	9.0-9.2
4.20725-4.20775	73-74.6	1645.5-1646.5	9.3-9.5
6.215-6.218	74.8-75.2	1660-1710	10.6-12.7
6.26775-6.26825	108-121.94	1718.8-1722.2	13.25-13.4
6.31175-6.31225	123-138	2200-2300	14.47-14.5
8.291-8.294	149.9-150.05	2310-2390	15.35-16.2
8.362-8.366	156.52475-156.52525	2483.5-2500	17.7-21.4
8.37625-8.38675	156.7-156.9	2690-2900	22.01-23.12
8.41425-8.41475	162.0125-167.17	3260-3267	23.6-24.0
12.29-12.293	167.72-173.2	3332-3339	31.2-31.8
12.51975-12.52025	240-285	3345.8-3358	36.43-36.5
12.57675-12.57725	322-335.4	3600-4400	Above 38.6
13.36-13.41			

Note: In case the emission radiated emission above 1000MHz fall within the restricted band the restricted frequency bands, the peak limit is 74 dBuV/m.

**LIMITS OF EMISSIONS OUTSIDE OF THE FREQUENCY BANDS**

Undesirable emission limits. Except as shown in paragraph (b)(7) of this section, the maximum emissions outside of the frequency bands of operation shall be attenuated in accordance with the following limits:

- (1) For transmitters operating in the 5.15-5.25 GHz band: All emissions outside of the 5.15-5.35 GHz band shall not exceed an e.i.r.p. of -27 dBm/MHz.
- (2) For transmitters operating in the 5.25-5.35 GHz band: All emissions outside of the 5.15-5.35 GHz band shall not exceed an e.i.r.p. of -27 dBm/MHz.
- (3) For transmitters operating in the 5.47-5.725 GHz band: All emissions outside of the 5.47-5.725 GHz band shall not exceed an e.i.r.p. of -27 dBm/MHz.
- (4) For transmitters operating in the 5.725-5.85 GHz band:
 - (i) All emissions shall be limited to a level of -27 dBm/MHz at 75 MHz or more above or below the band edge increasing linearly to 10 dBm/MHz at 25 MHz above or below the band edge, and from 25 MHz above or below the band edge increasing linearly to a level of 15.6 dBm/MHz at 5 MHz above or below the band edge, and from 5 MHz above or below the band edge increasing linearly to a level of 27 dBm/MHz at the band edge.

Note: dBuV/m(at 3M) = EIRP(dBm) + 95.3.

Peak Limit = -27dBm/MHz + 95.3 = 68.3 dBuV/m.

Spectrum Parameter	Setting
Attenuation	Auto
Detector	Peak
Start Frequency	1000 MHz(Peak/AV)
Stop Frequency	10th carrier harmonic (Peak/AV)
RB / VB (emission in restricted band)	1 MHz / 1 MHz, AV=1 MHz /3 MHz

For Band edge

Spectrum Parameter	Setting
Detector	Peak
RB / VB (emission in restricted band)	1 MHz / 1 MHz, AV=1 MHz /3 MHz

Receiver Parameter	Setting
Attenuation	Auto
Start ~ Stop Frequency	9kHz~90kHz / RB 200Hz for PK & AV
Start ~ Stop Frequency	90kHz~110kHz / RB 200Hz for QP
Start ~ Stop Frequency	110kHz~490kHz / RB 200Hz for PK & AV
Start ~ Stop Frequency	490kHz~30MHz / RB 9kHz for QP
Start ~ Stop Frequency	30MHz~1000MHz / RB 120kHz for QP



3.2.2 TEST PROCEDURE

- a. The measuring distance at 3 m shall be used for measurements at frequency 0.009MHz up to 1GHz, and above 1GHz.
- b. The EUT was placed on the top of a rotating table 0.8 m (above 1GHz is 1.5 m) above the ground at a 3 m anechoic chamber test site. The table was rotated 360 degree to determine the position of the highest radiation.
- c. The height of the equipment shall be 0.8 m (above 1GHz is 1.5 m); the height of the test antenna shall vary between 1 m to 4 m. Horizontal and vertical polarization of the antenna are set to make the measurement.
- d. The initial step in collecting conducted emission data is a spectrum analyzer peak detector mode pre-scanning the measurement frequency range. Significant peaks are then marked and QuasiPeak detector mode will be re-measured.
- e. If the Peak Mode measured value is compliance with and lower than Quasi Peak Mode Limit, the EUT shall be deemed to meet QP Limits and no additional QP Mode measurement was performed.
- f. For the actual test configuration, please refer to the related Item –EUT Test Photos.

Note:

Both horizontal and vertical antenna polarities were tested and performed pretest to three orthogonal axis. The worst case emissions were reported.

3.2.2 DEVIATION FROM TEST STANDARD

No deviation

3.2.3 TEST SETUP

(A) Radiated Emission Test-Up Frequency Below 30MHz

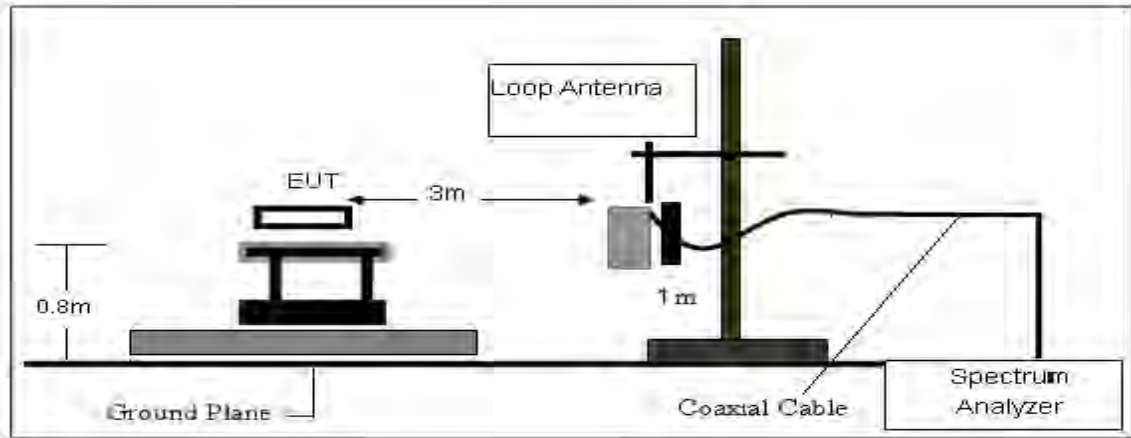

(B) Radiated Emission Test-Up Frequency 30MHz~1GHz

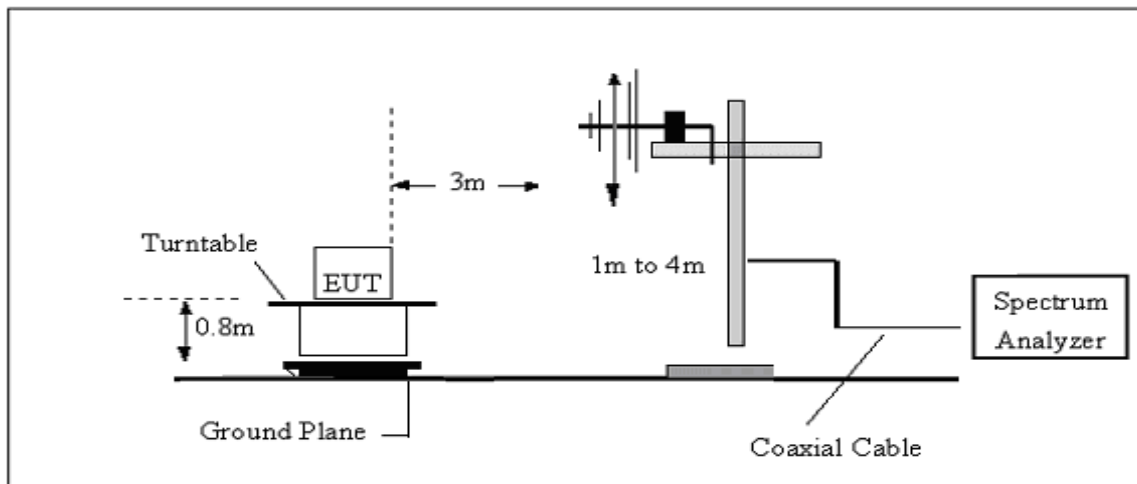

(C) Radiated Emission Test-Up Frequency Above 1GHz

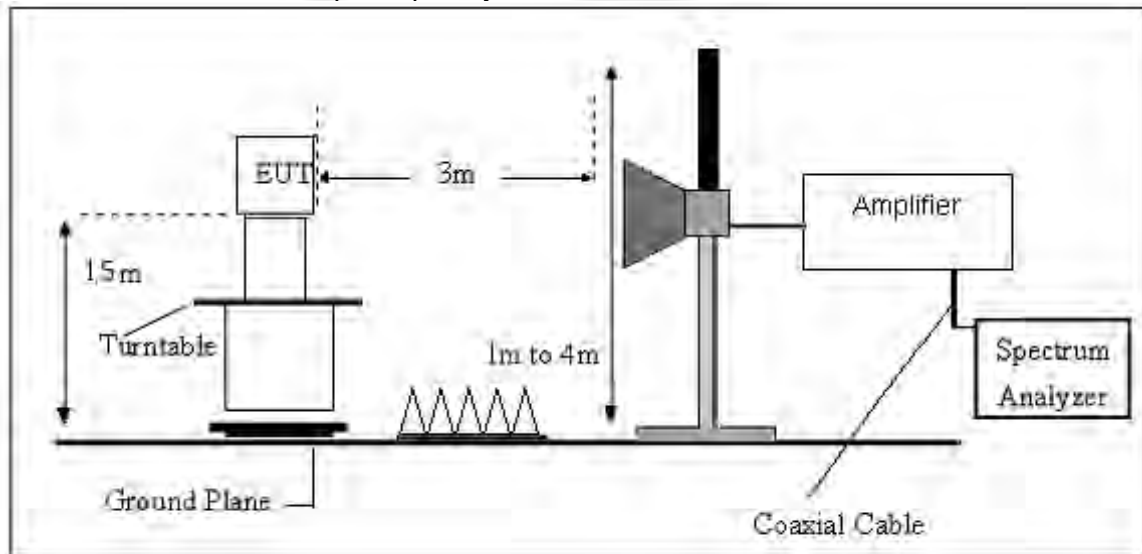



3.2.4 EUT OPERATING CONDITIONS

The EUT tested system was configured as the statements of 2.4 Unless otherwise a special operating condition is specified in the follows during the testing.

3.2.5 FIELD STRENGTH CALCULATION

The field strength is calculated by adding the Antenna Factor and Cable Factor and subtracting the Amplifier Gain and Duty Cycle Correction Factor (if any) from the measured reading. The basic equation with a sample calculation is as follows:

$$FS = RA + AF + CL - AG$$

Where

FS = Field Strength

CL = Cable Attenuation Factor (Cable Loss)

RA = Reading Amplitude

AG = Amplifier Gain

AF = Antenna Factor

For example

Frequency (MHz)	FS (dB μ V/m)	RA (dB μ V/m)	AF (dB)	CL (dB)	AG (dB)	Factor (dB)
300	40	58.1	12.2	1.6	31.9	-18.1

$$\text{Factor} = \text{AF} + \text{CL} - \text{AG}$$

**3.2.6 TEST RESULTS (Between 9KHz – 30 MHz)**

Temperature:	23.1(C)	Relative Humidity:	60%RH
Test Voltage:	AC 120V/60Hz	Polarization :	--
Test Mode:	TX Mode		

Freq.	Reading	Limit	Margin	State
(MHz)	(dBuV/m)	(dBuV/m)	(dB)	P/F
--	--	--	--	PASS
--	--	--	--	PASS

Note:

The amplitude of spurious emissions which are attenuated by more than 20dB below the permissible value has no need to be reported.

Distance extrapolation factor = $40 \log(\text{specific distance}/\text{test distance})$ (dB);

Limit line = specific limits(dBuv) + distance extrapolation factor.

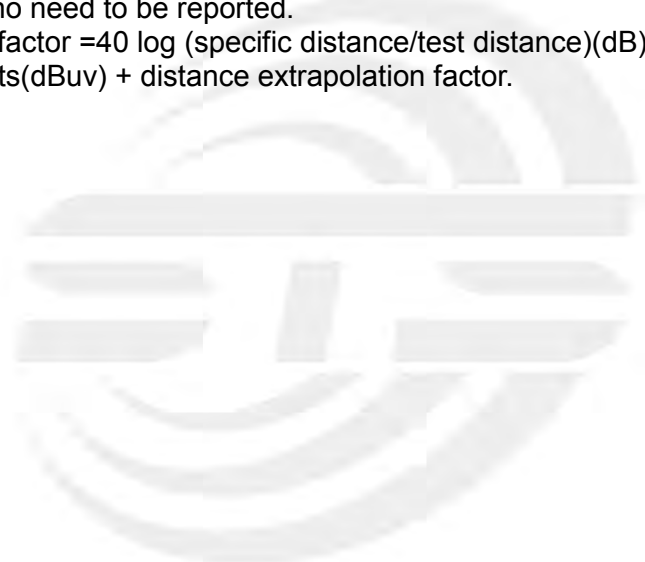



3.2.7 TEST RESULTS (Between 30MHz – 1GHz)

Temperature	23.1(C)	Relative Humidity:	60%RH
Test Voltage	AC 120V/60Hz	Polarization:	Horizontal
Test Mode	Mode 1~24(Mode 9 worst mode)		

No.	Frequency (MHz)	Reading (dBuV)	Correct Factor(dB/m)	Result (dBuV/m)	Limit (dBuV/m)	Margin (dB)	Remark
1	62.9800	49.24	-25.70	23.54	40.00	-16.46	QP
2	144.4600	40.21	-18.29	21.92	43.50	-21.58	QP
3	479.1100	29.38	-8.68	20.70	46.00	-25.30	QP
4	683.7800	31.45	-4.31	27.14	46.00	-18.86	QP
5	733.2500	31.50	-2.35	29.15	46.00	-16.85	QP
6	947.6200	27.90	1.55	29.45	46.00	-16.55	QP

Remark:

- Margin = Result (Result =Reading + Factor)–Limit
- Factor= Antenna factor+Cable attenuation factor(cable loss)-Amplifier gain

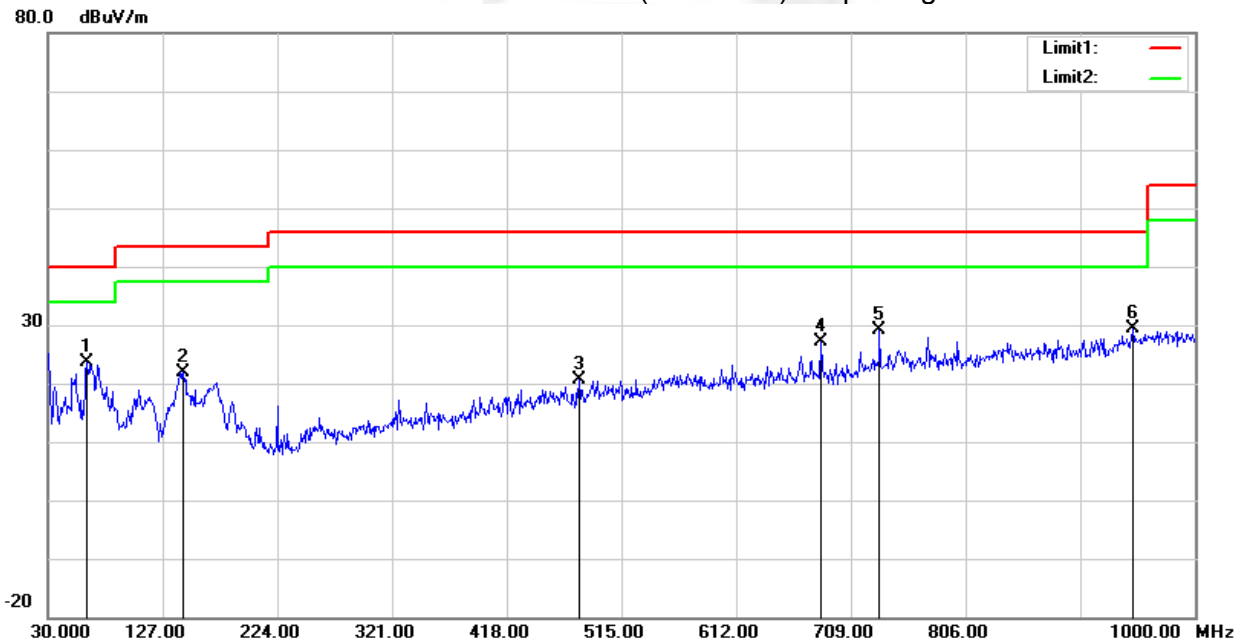



Temperature	23.1(C)	Relative Humidity:	60%RH
Test Voltage	AC 120V/60Hz	Polarization:	Vertical
Test Mode	Mode 1~24(Mode 9 worst mode)		

No.	Frequency (MHz)	Reading (dBuV)	Correct Factor(dB/m)	Result (dBuV/m)	Limit (dBuV/m)	Margin (dB)	Remark
1	69.7700	54.86	-24.91	29.95	40.00	-10.05	QP
2	146.4000	43.95	-18.38	25.57	43.50	-17.93	QP
3	405.3900	34.45	-10.83	23.62	46.00	-22.38	QP
4	602.3000	30.31	-5.77	24.54	46.00	-21.46	QP
5	773.9900	36.48	-2.29	34.19	46.00	-11.81	QP
6	987.3900	30.13	2.21	32.34	54.00	-21.66	QP

Remark:

- Margin = Result (Result =Reading + Factor)-Limit
- Factor= Antenna factor+Cable attenuation factor(cable loss)-Amplifier gain

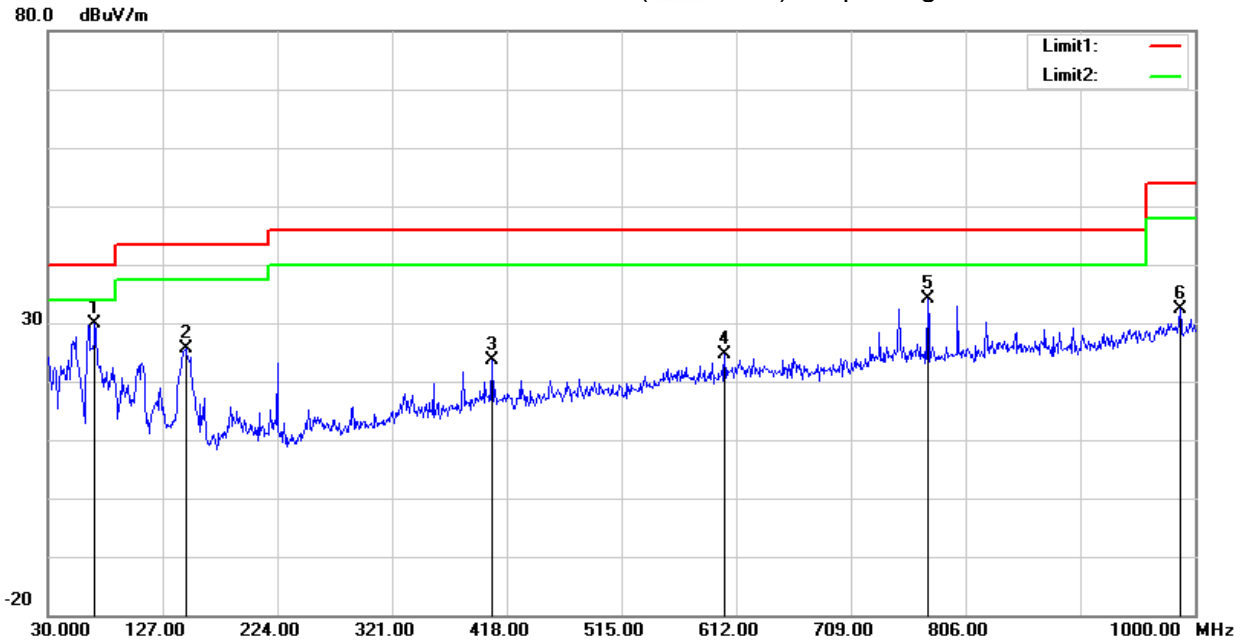



3.2.8 TEST RESULTS (Above 1000 MHz)

Band I 5150-5250MHz

Frequency (MHz)	Reading (dBuV)	Amplifier (dB)	Loss (dB)	Antenna Factor (dB/m)	Orrected Factor (dB)	Emission Level (dBuV/m)	Limit (dBuV/m)	Margin (dB)	Detector	Comment
Low Channel (802.11ac20/ 5180 MHz)										
3261.21	44.84	44.70	6.70	28.20	-9.80	35.04	68.20	-33.16	Pk	Vertical
3261.21	41.38	44.70	6.70	28.20	-9.80	31.58	54.00	-22.42	AV	Vertical
3250.78	43.77	44.70	6.70	28.20	-9.80	33.97	68.20	-34.23	Pk	Horizontal
3250.78	42.22	44.70	6.70	28.20	-9.80	32.42	54.00	-21.58	AV	Horizontal
3993.64	39.28	44.20	7.90	29.70	-6.60	32.68	68.20	-35.52	Pk	Vertical
3993.64	36.02	44.20	7.90	29.70	-6.60	29.42	54.00	-24.58	AV	Vertical
3991.23	39.40	44.20	7.90	29.70	-6.60	32.80	68.20	-35.40	Pk	Horizontal
3991.23	36.15	44.20	7.90	29.70	-6.60	29.55	54.00	-24.45	AV	Horizontal
7232.43	37.45	43.50	11.40	35.50	3.40	40.85	68.20	-27.35	Pk	Vertical
7232.43	33.81	43.50	11.40	35.50	3.40	37.21	54.00	-16.79	AV	Vertical
7224.53	37.71	43.50	11.40	35.50	3.40	41.11	68.20	-27.09	Pk	Horizontal
7224.53	33.70	43.50	11.40	35.50	3.40	37.10	54.00	-16.90	AV	Horizontal
10360.22	38.86	44.50	13.80	38.80	8.10	46.96	68.20	-21.24	Pk	Vertical
10360.22	36.53	44.50	13.80	38.80	8.10	44.63	54.00	-9.37	AV	Vertical
10360.01	38.79	44.50	13.80	38.80	8.10	46.89	68.20	-21.31	Pk	Horizontal
10360.01	36.68	44.50	13.80	38.80	8.10	44.78	54.00	-9.22	AV	Horizontal
11024.54	33.14	43.60	14.30	39.50	10.20	43.34	68.20	-24.86	Pk	Vertical
11024.54	30.06	43.60	14.30	39.50	10.20	40.26	54.00	-13.74	AV	Vertical
11031.01	33.21	43.60	14.30	39.50	10.20	43.41	68.20	-24.79	Pk	Horizontal
11031.01	30.72	43.60	14.30	39.50	10.20	40.92	54.00	-13.08	AV	Horizontal
13288.91	32.12	42.60	15.90	38.90	12.20	44.32	68.20	-23.88	Pk	Vertical
13288.91	29.78	42.60	15.90	38.90	12.20	41.98	54.00	-12.02	AV	Vertical
13281.52	32.62	42.60	15.90	38.90	12.20	44.82	68.20	-23.38	Pk	Horizontal
13281.52	29.54	42.60	15.90	38.90	12.20	41.74	54.00	-12.26	AV	Horizontal
Mid Channel (802.11ac20/ 5200 MHz)										
3246.49	44.02	44.70	6.70	28.20	-9.80	34.22	68.20	-33.98	Pk	Vertical
3246.49	40.90	44.70	6.70	28.20	-9.80	31.10	54.00	-22.90	AV	Vertical
3245.30	44.20	44.70	6.70	28.20	-9.80	34.40	68.20	-33.80	Pk	Horizontal
3245.30	40.94	44.70	6.70	28.20	-9.80	31.14	54.00	-22.86	AV	Horizontal
3985.52	39.35	44.20	7.90	29.70	-6.60	32.75	68.20	-35.45	Pk	Vertical
3985.52	36.98	44.20	7.90	29.70	-6.60	30.38	54.00	-23.62	AV	Vertical
3989.77	39.94	44.20	7.90	29.70	-6.60	33.34	68.20	-34.86	Pk	Horizontal
3989.77	36.74	44.20	7.90	29.70	-6.60	30.14	54.00	-23.86	AV	Horizontal
7224.27	37.58	43.50	11.40	35.50	3.40	40.98	68.20	-27.22	Pk	Vertical
7224.27	33.87	43.50	11.40	35.50	3.40	37.27	54.00	-16.73	AV	Vertical
7232.51	37.67	43.50	11.40	35.50	3.40	41.07	68.20	-27.13	Pk	Horizontal
7232.51	33.65	43.50	11.40	35.50	3.40	37.05	54.00	-16.95	AV	Horizontal
10400.04	39.36	44.50	13.80	38.80	8.10	47.46	68.20	-20.74	Pk	Vertical
10400.04	37.10	44.50	13.80	38.80	8.10	45.20	54.00	-8.80	AV	Vertical
10400.05	39.70	44.50	13.80	38.80	8.10	47.80	68.20	-20.40	Pk	Horizontal
10400.05	35.98	44.50	13.80	38.80	8.10	44.08	54.00	-9.92	AV	Horizontal
11034.83	33.95	43.60	14.30	39.50	10.20	44.15	68.20	-24.05	Pk	Vertical
11034.83	29.86	43.60	14.30	39.50	10.20	40.06	54.00	-13.94	AV	Vertical
11030.86	33.62	43.60	14.30	39.50	10.20	43.82	68.20	-24.38	Pk	Horizontal
11030.86	30.16	43.60	14.30	39.50	10.20	40.36	54.00	-13.64	AV	Horizontal
13287.05	31.82	42.60	15.90	38.90	12.20	44.02	68.20	-24.18	Pk	Vertical
13287.05	29.81	42.60	15.90	38.90	12.20	42.01	54.00	-11.99	AV	Vertical
13293.09	32.75	42.60	15.90	38.90	12.20	44.95	68.20	-23.25	Pk	Horizontal
13293.09	29.29	42.60	15.90	38.90	12.20	41.49	54.00	-12.51	AV	Horizontal



High Channel (802.11ac20/ 5240 MHz)										
3261.07	44.45	44.70	6.70	28.20	-9.80	34.65	68.20	-33.55	Pk	Vertical
3261.07	41.40	44.70	6.70	28.20	-9.80	31.60	54.00	-22.40	AV	Vertical
3250.49	44.37	44.70	6.70	28.20	-9.80	34.57	68.20	-33.63	Pk	Horizontal
3250.49	41.62	44.70	6.70	28.20	-9.80	31.82	54.00	-22.18	AV	Horizontal
3991.47	39.48	44.20	7.90	29.70	-6.60	32.88	68.20	-35.32	Pk	Vertical
3991.47	36.60	44.20	7.90	29.70	-6.60	30.00	54.00	-24.00	AV	Vertical
3999.09	39.60	44.20	7.90	29.70	-6.60	33.00	68.20	-35.20	Pk	Horizontal
3999.09	35.89	44.20	7.90	29.70	-6.60	29.29	54.00	-24.71	AV	Horizontal
7227.60	37.45	43.50	11.40	35.50	3.40	40.85	68.20	-27.35	Pk	Vertical
7227.60	34.25	43.50	11.40	35.50	3.40	37.65	54.00	-16.35	AV	Vertical
7231.63	36.49	43.50	11.40	35.50	3.40	39.89	68.20	-28.31	Pk	Horizontal
7231.63	34.55	43.50	11.40	35.50	3.40	37.95	54.00	-16.05	AV	Horizontal
10480.41	39.89	44.50	13.80	38.80	8.10	47.99	68.20	-20.21	Pk	Vertical
10480.41	36.73	44.50	13.80	38.80	8.10	44.83	54.00	-9.17	AV	Vertical
10480.06	39.04	44.50	13.80	38.80	8.10	47.14	68.20	-21.06	Pk	Horizontal
10480.06	36.68	44.50	13.80	38.80	8.10	44.78	54.00	-9.22	AV	Horizontal
11023.68	33.19	43.60	14.30	39.50	10.20	43.39	68.20	-24.81	Pk	Vertical
11023.68	30.33	43.60	14.30	39.50	10.20	40.53	54.00	-13.47	AV	Vertical
11022.06	33.41	43.60	14.30	39.50	10.20	43.61	68.20	-24.59	Pk	Horizontal
11022.06	29.70	43.60	14.30	39.50	10.20	39.90	54.00	-14.10	AV	Horizontal
13291.82	31.57	42.60	15.90	38.90	12.20	43.77	68.20	-24.43	Pk	Vertical
13291.82	29.32	42.60	15.90	38.90	12.20	41.52	54.00	-12.48	AV	Vertical
13286.20	32.01	42.60	15.90	38.90	12.20	44.21	68.20	-23.99	Pk	Horizontal
13286.20	28.81	42.60	15.90	38.90	12.20	41.01	54.00	-12.99	AV	Horizontal

Remark:

1. Factor = Antenna Factor + Cable Loss – Pre-amplifier.
2. Scan with 802.11a, 802.11n (HT-20), 802.11n (HT-40), 802.11ac (VHT-20), 802.11ac (VHT-40), 802.11ac (VHT-80) the worst case is 802.11ac (VHT-20).
3. The frequency emission of peak points that did not show above the forms are at least 20dB below the limit, the frequency emission is mainly from the environment noise.
4. Pre-scan both the SISO and MIMO mode, only the worst-case results were reported.



Band II 5250-5350MHz

Frequency (MHz)	Reading	Amplifier	Loss	Antenna Factor	Orrected Factor	Emission Level	Limit (dBuV/m)	Margin	Detector	Comment
	(dBuV)	(dB)	(dB)	(dB/m)	(dB)	(dBuV/m)		(dB)		
Low Channel (802.11n20/ 5260 MHz)										
3252.21	44.20	44.70	6.70	28.20	-9.80	34.40	68.20	-33.80	Pk	Vertical
3252.21	41.91	44.70	6.70	28.20	-9.80	32.11	54.00	-21.89	AV	Vertical
3252.15	45.15	44.70	6.70	28.20	-9.80	35.35	68.20	-32.85	Pk	Horizontal
3252.15	42.22	44.70	6.70	28.20	-9.80	32.42	54.00	-21.58	AV	Horizontal
3985.34	39.30	44.20	7.90	29.70	-6.60	32.70	68.20	-35.50	Pk	Vertical
3985.34	36.37	44.20	7.90	29.70	-6.60	29.77	54.00	-24.23	AV	Vertical
3994.01	40.07	44.20	7.90	29.70	-6.60	33.47	68.20	-34.73	Pk	Horizontal
3994.01	35.70	44.20	7.90	29.70	-6.60	29.10	54.00	-24.90	AV	Horizontal
7221.82	37.16	43.50	11.40	35.50	3.40	40.56	68.20	-27.64	Pk	Vertical
7221.82	33.48	43.50	11.40	35.50	3.40	36.88	54.00	-17.12	AV	Vertical
7226.19	36.74	43.50	11.40	35.50	3.40	40.14	68.20	-28.06	Pk	Horizontal
7226.19	34.46	43.50	11.40	35.50	3.40	37.86	54.00	-16.14	AV	Horizontal
10359.99	39.73	44.50	13.80	38.80	8.10	47.83	68.20	-20.37	Pk	Vertical
10359.99	36.47	44.50	13.80	38.80	8.10	44.57	54.00	-9.43	AV	Vertical
10360.15	39.01	44.50	13.80	38.80	8.10	47.11	68.20	-21.09	Pk	Horizontal
10360.15	35.92	44.50	13.80	38.80	8.10	44.02	54.00	-9.98	AV	Horizontal
11018.02	33.76	43.60	14.30	39.50	10.20	43.96	68.20	-24.24	Pk	Vertical
11018.02	30.42	43.60	14.30	39.50	10.20	40.62	54.00	-13.38	AV	Vertical
11029.28	32.87	43.60	14.30	39.50	10.20	43.07	68.20	-25.13	Pk	Horizontal
11029.28	31.16	43.60	14.30	39.50	10.20	41.36	54.00	-12.64	AV	Horizontal
13287.48	32.41	42.60	15.90	38.90	12.20	44.61	68.20	-23.59	Pk	Vertical
13287.48	28.75	42.60	15.90	38.90	12.20	40.95	54.00	-13.05	AV	Vertical
13280.10	31.62	42.60	15.90	38.90	12.20	43.82	68.20	-24.38	Pk	Horizontal
13280.10	28.75	42.60	15.90	38.90	12.20	40.95	54.00	-13.05	AV	Horizontal
Mid Channel (802.11n20/ 5300 MHz)										
3260.16	43.96	44.70	6.70	28.20	-9.80	34.16	68.20	-34.04	Pk	Vertical
3260.16	41.68	44.70	6.70	28.20	-9.80	31.88	54.00	-22.12	AV	Vertical
3253.61	43.83	44.70	6.70	28.20	-9.80	34.03	68.20	-34.17	Pk	Horizontal
3253.61	40.83	44.70	6.70	28.20	-9.80	31.03	54.00	-22.97	AV	Horizontal
3983.71	39.88	44.20	7.90	29.70	-6.60	33.28	68.20	-34.92	Pk	Vertical
3983.71	37.00	44.20	7.90	29.70	-6.60	30.40	54.00	-23.60	AV	Vertical
3995.17	39.95	44.20	7.90	29.70	-6.60	33.35	68.20	-34.85	Pk	Horizontal
3995.17	36.30	44.20	7.90	29.70	-6.60	29.70	54.00	-24.30	AV	Horizontal
7217.45	36.48	43.50	11.40	35.50	3.40	39.88	68.20	-28.32	Pk	Vertical
7217.45	34.82	43.50	11.40	35.50	3.40	38.22	54.00	-15.78	AV	Vertical
7222.75	37.51	43.50	11.40	35.50	3.40	40.91	68.20	-27.29	Pk	Horizontal
7222.75	34.60	43.50	11.40	35.50	3.40	38.00	54.00	-16.00	AV	Horizontal
10400.11	39.93	44.50	13.80	38.80	8.10	48.03	68.20	-20.17	Pk	Vertical
10400.11	35.87	44.50	13.80	38.80	8.10	43.97	54.00	-10.03	AV	Vertical
10400.02	39.44	44.50	13.80	38.80	8.10	47.54	68.20	-20.66	Pk	Horizontal
10400.02	36.03	44.50	13.80	38.80	8.10	44.13	54.00	-9.87	AV	Horizontal
11025.83	33.30	43.60	14.30	39.50	10.20	43.50	68.20	-24.70	Pk	Vertical
11025.83	30.49	43.60	14.30	39.50	10.20	40.69	54.00	-13.31	AV	Vertical
11024.47	34.05	43.60	14.30	39.50	10.20	44.25	68.20	-23.95	Pk	Horizontal
11024.47	30.43	43.60	14.30	39.50	10.20	40.63	54.00	-13.37	AV	Horizontal
13297.49	31.82	42.60	15.90	38.90	12.20	44.02	68.20	-24.18	Pk	Vertical
13297.49	28.87	42.60	15.90	38.90	12.20	41.07	54.00	-12.93	AV	Vertical
13293.43	31.58	42.60	15.90	38.90	12.20	43.78	68.20	-24.42	Pk	Horizontal
13293.43	29.39	42.60	15.90	38.90	12.20	41.59	54.00	-12.41	AV	Horizontal



High Channel (802.11n20/ 5320 MHz)										
3253.03	43.95	44.70	6.70	28.20	-9.80	34.15	68.20	-34.05	Pk	Vertical
3253.03	41.19	44.70	6.70	28.20	-9.80	31.39	54.00	-22.61	AV	Vertical
3262.35	44.23	44.70	6.70	28.20	-9.80	34.43	68.20	-33.77	Pk	Horizontal
3262.35	41.17	44.70	6.70	28.20	-9.80	31.37	54.00	-22.63	AV	Horizontal
3982.21	38.90	44.20	7.90	29.70	-6.60	32.30	68.20	-35.90	Pk	Vertical
3982.21	36.52	44.20	7.90	29.70	-6.60	29.92	54.00	-24.08	AV	Vertical
3997.69	39.87	44.20	7.90	29.70	-6.60	33.27	68.20	-34.93	Pk	Horizontal
3997.69	37.06	44.20	7.90	29.70	-6.60	30.46	54.00	-23.54	AV	Horizontal
7219.96	36.68	43.50	11.40	35.50	3.40	40.08	68.20	-28.12	Pk	Vertical
7219.96	33.60	43.50	11.40	35.50	3.40	37.00	54.00	-17.00	AV	Vertical
7233.66	37.46	43.50	11.40	35.50	3.40	40.86	68.20	-27.34	Pk	Horizontal
7233.66	34.92	43.50	11.40	35.50	3.40	38.32	54.00	-15.68	AV	Horizontal
10480.10	39.04	44.50	13.80	38.80	8.10	47.14	68.20	-21.06	Pk	Vertical
10480.10	36.69	44.50	13.80	38.80	8.10	44.79	54.00	-9.21	AV	Vertical
10480.06	38.78	44.50	13.80	38.80	8.10	46.88	68.20	-21.32	Pk	Horizontal
10480.06	36.99	44.50	13.80	38.80	8.10	45.09	54.00	-8.91	AV	Horizontal
11028.10	33.98	43.60	14.30	39.50	10.20	44.18	68.20	-24.02	Pk	Vertical
11028.10	30.20	43.60	14.30	39.50	10.20	40.40	54.00	-13.60	AV	Vertical
11018.70	32.82	43.60	14.30	39.50	10.20	43.02	68.20	-25.18	Pk	Horizontal
11018.70	29.82	43.60	14.30	39.50	10.20	40.02	54.00	-13.98	AV	Horizontal
13285.90	31.85	42.60	15.90	38.90	12.20	44.05	68.20	-24.15	Pk	Vertical
13285.90	29.70	42.60	15.90	38.90	12.20	41.90	54.00	-12.10	AV	Vertical
13280.86	32.35	42.60	15.90	38.90	12.20	44.55	68.20	-23.65	Pk	Horizontal
13280.86	29.24	42.60	15.90	38.90	12.20	41.44	54.00	-12.56	AV	Horizontal

Remark:

1. Factor = Antenna Factor + Cable Loss – Pre-amplifier.
2. Scan with 802.11a, 802.11n (HT-20), 802.11n (HT-40), 802.11ac (VHT-20), 802.11ac (VHT-40), 802.11ac (VHT-80) the worst case is 802.11n (HT-20).
3. The frequency emission of peak points that did not show above the forms are at least 20dB below the limit, the frequency emission is mainly from the environment noise.
4. Pre-scan both the SISO and MIMO mode, only the worst-case results were reported.



Band III 5470-5725MHz

Frequency (MHz)	Reading	Amplifier	Loss	Antenna Factor	Orrected Factor	Emission Level	Limit (dBuV/m)	Margin	Detector	Comment
	(dBuV)	(dB)	(dB)	(dB/m)	(dB)	(dBuV/m)		(dB)		
Low Channel (802.11n20/ 5500 MHz)										
3251.58	44.76	44.70	6.70	28.20	-9.80	34.96	68.20	-33.24	Pk	Vertical
3251.58	41.43	44.70	6.70	28.20	-9.80	31.63	54.00	-22.37	AV	Vertical
3246.48	43.93	44.70	6.70	28.20	-9.80	34.13	68.20	-34.07	Pk	Horizontal
3246.48	41.25	44.70	6.70	28.20	-9.80	31.45	54.00	-22.55	AV	Horizontal
3994.42	39.93	44.20	7.90	29.70	-6.60	33.33	68.20	-34.87	Pk	Vertical
3994.42	36.95	44.20	7.90	29.70	-6.60	30.35	54.00	-23.65	AV	Vertical
3993.53	39.26	44.20	7.90	29.70	-6.60	32.66	68.20	-35.54	Pk	Horizontal
3993.53	36.84	44.20	7.90	29.70	-6.60	30.24	54.00	-23.76	AV	Horizontal
7226.88	36.53	43.50	11.40	35.50	3.40	39.93	68.20	-28.27	Pk	Vertical
7226.88	34.12	43.50	11.40	35.50	3.40	37.52	54.00	-16.48	AV	Vertical
7227.55	37.47	43.50	11.40	35.50	3.40	40.87	68.20	-27.33	Pk	Horizontal
7227.55	34.82	43.50	11.40	35.50	3.40	38.22	54.00	-15.78	AV	Horizontal
10360.07	38.83	44.50	13.80	38.80	8.10	46.93	68.20	-21.27	Pk	Vertical
10360.07	36.00	44.50	13.80	38.80	8.10	44.10	54.00	-9.90	AV	Vertical
10360.37	39.49	44.50	13.80	38.80	8.10	47.59	68.20	-20.61	Pk	Horizontal
10360.37	36.33	44.50	13.80	38.80	8.10	44.43	54.00	-9.57	AV	Horizontal
11019.91	32.89	43.60	14.30	39.50	10.20	43.09	68.20	-25.11	Pk	Vertical
11019.91	30.02	43.60	14.30	39.50	10.20	40.22	54.00	-13.78	AV	Vertical
11032.05	33.59	43.60	14.30	39.50	10.20	43.79	68.20	-24.41	Pk	Horizontal
11032.05	30.39	43.60	14.30	39.50	10.20	40.59	54.00	-13.41	AV	Horizontal
13297.11	32.20	42.60	15.90	38.90	12.20	44.40	68.20	-23.80	Pk	Vertical
13297.11	29.28	42.60	15.90	38.90	12.20	41.48	54.00	-12.52	AV	Vertical
13288.01	32.81	42.60	15.90	38.90	12.20	45.01	68.20	-23.19	Pk	Horizontal
13288.01	29.18	42.60	15.90	38.90	12.20	41.38	54.00	-12.62	AV	Horizontal
Mid Channel (802.11n20/ 5580 MHz)										
3258.04	44.12	44.70	6.70	28.20	-9.80	34.32	68.20	-33.88	Pk	Vertical
3258.04	40.86	44.70	6.70	28.20	-9.80	31.06	54.00	-22.94	AV	Vertical
3257.23	43.82	44.70	6.70	28.20	-9.80	34.02	68.20	-34.18	Pk	Horizontal
3257.23	42.16	44.70	6.70	28.20	-9.80	32.36	54.00	-21.64	AV	Horizontal
3980.36	39.69	44.20	7.90	29.70	-6.60	33.09	68.20	-35.11	Pk	Vertical
3980.36	36.92	44.20	7.90	29.70	-6.60	30.32	54.00	-23.68	AV	Vertical
3988.31	39.53	44.20	7.90	29.70	-6.60	32.93	68.20	-35.27	Pk	Horizontal
3988.31	35.89	44.20	7.90	29.70	-6.60	29.29	54.00	-24.71	AV	Horizontal
7219.96	36.96	43.50	11.40	35.50	3.40	40.36	68.20	-27.84	Pk	Vertical
7219.96	34.77	43.50	11.40	35.50	3.40	38.17	54.00	-15.83	AV	Vertical
7229.52	37.69	43.50	11.40	35.50	3.40	41.09	68.20	-27.11	Pk	Horizontal
7229.52	34.48	43.50	11.40	35.50	3.40	37.88	54.00	-16.12	AV	Horizontal
10400.10	40.08	44.50	13.80	38.80	8.10	48.18	68.20	-20.02	Pk	Vertical
10400.10	36.33	44.50	13.80	38.80	8.10	44.43	54.00	-9.57	AV	Vertical
10400.03	39.28	44.50	13.80	38.80	8.10	47.38	68.20	-20.82	Pk	Horizontal
10400.03	36.67	44.50	13.80	38.80	8.10	44.77	54.00	-9.23	AV	Horizontal
11028.41	33.27	43.60	14.30	39.50	10.20	43.47	68.20	-24.73	Pk	Vertical
11028.41	30.95	43.60	14.30	39.50	10.20	41.15	54.00	-12.85	AV	Vertical
11029.69	33.47	43.60	14.30	39.50	10.20	43.67	68.20	-24.53	Pk	Horizontal
11029.69	30.69	43.60	14.30	39.50	10.20	40.89	54.00	-13.11	AV	Horizontal
13281.51	32.81	42.60	15.90	38.90	12.20	45.01	68.20	-23.19	Pk	Vertical
13281.51	28.85	42.60	15.90	38.90	12.20	41.05	54.00	-12.95	AV	Vertical
13285.29	31.56	42.60	15.90	38.90	12.20	43.76	68.20	-24.44	Pk	Horizontal
13285.29	29.81	42.60	15.90	38.90	12.20	42.01	54.00	-11.99	AV	Horizontal



High Channel (802.11n20/ 5700 MHz)										
3261.34	44.90	44.70	6.70	28.20	-9.80	35.10	68.20	-33.10	Pk	Vertical
3261.34	40.80	44.70	6.70	28.20	-9.80	31.00	54.00	-23.00	AV	Vertical
3262.55	45.04	44.70	6.70	28.20	-9.80	35.24	68.20	-32.96	Pk	Horizontal
3262.55	41.40	44.70	6.70	28.20	-9.80	31.60	54.00	-22.40	AV	Horizontal
3981.87	40.09	44.20	7.90	29.70	-6.60	33.49	68.20	-34.71	Pk	Vertical
3981.87	36.56	44.20	7.90	29.70	-6.60	29.96	54.00	-24.04	AV	Vertical
3987.88	39.38	44.20	7.90	29.70	-6.60	32.78	68.20	-35.42	Pk	Horizontal
3987.88	36.50	44.20	7.90	29.70	-6.60	29.90	54.00	-24.10	AV	Horizontal
7222.72	37.89	43.50	11.40	35.50	3.40	41.29	68.20	-26.91	Pk	Vertical
7222.72	34.15	43.50	11.40	35.50	3.40	37.55	54.00	-16.45	AV	Vertical
7226.66	36.82	43.50	11.40	35.50	3.40	40.22	68.20	-27.98	Pk	Horizontal
7226.66	33.47	43.50	11.40	35.50	3.40	36.87	54.00	-17.13	AV	Horizontal
10480.18	39.69	44.50	13.80	38.80	8.10	47.79	68.20	-20.41	Pk	Vertical
10480.18	36.94	44.50	13.80	38.80	8.10	45.04	54.00	-8.96	AV	Vertical
10480.15	39.65	44.50	13.80	38.80	8.10	47.75	68.20	-20.45	Pk	Horizontal
10480.15	36.99	44.50	13.80	38.80	8.10	45.09	54.00	-8.91	AV	Horizontal
11021.46	33.86	43.60	14.30	39.50	10.20	44.06	68.20	-24.14	Pk	Vertical
11021.46	29.99	43.60	14.30	39.50	10.20	40.19	54.00	-13.81	AV	Vertical
11022.68	34.15	43.60	14.30	39.50	10.20	44.35	68.20	-23.85	Pk	Horizontal
11022.68	29.79	43.60	14.30	39.50	10.20	39.99	54.00	-14.01	AV	Horizontal
13294.93	31.88	42.60	15.90	38.90	12.20	44.08	68.20	-24.12	Pk	Vertical
13294.93	28.94	42.60	15.90	38.90	12.20	41.14	54.00	-12.86	AV	Vertical
13287.92	32.08	42.60	15.90	38.90	12.20	44.28	68.20	-23.92	Pk	Horizontal
13287.92	28.73	42.60	15.90	38.90	12.20	40.93	54.00	-13.07	AV	Horizontal

Remark:

- Factor = Antenna Factor + Cable Loss – Pre-amplifier.
- Scan with 802.11a,802.11n (HT-20),802.11n (HT-40), 802.11ac (VHT-20),802.11ac (VHT-40), 802.11ac (VHT-80) the worst case is 802.11n (HT-20).
- The frequency emission of peak points that did not show above the forms are at least 20dB below the limit, the frequency emission is mainly from the environment noise.
- Pre-scan both the SISO and MIMO mode, only the worst-case results were reported.



Band IV(5.725-5.850) GHz

Frequency (MHz)	Reading	Amplifier	Loss	Antenna Factor	Orrected Factor	Emission Level	Limit (dBuV/m)	Margin	Detector	Comment
	(dBuV)	(dB)	(dB)	(dB/m)	(dB)	(dBuV/m)		(dB)		
Low Channel (802.11ac20/ 5745 MHz)										
3251.08	44.75	44.70	6.70	28.20	-9.80	34.95	68.20	-33.25	Pk	Vertical
3251.08	41.32	44.70	6.70	28.20	-9.80	31.52	54.00	-22.48	AV	Vertical
3263.22	44.33	44.70	6.70	28.20	-9.80	34.53	68.20	-33.67	Pk	Horizontal
3263.22	41.77	44.70	6.70	28.20	-9.80	31.97	54.00	-22.03	AV	Horizontal
3993.93	38.83	44.20	7.90	29.70	-6.60	32.23	68.20	-35.97	Pk	Vertical
3993.93	36.45	44.20	7.90	29.70	-6.60	29.85	54.00	-24.15	AV	Vertical
3996.09	38.77	44.20	7.90	29.70	-6.60	32.17	68.20	-36.03	Pk	Horizontal
3996.09	37.04	44.20	7.90	29.70	-6.60	30.44	54.00	-23.56	AV	Horizontal
7222.99	37.62	43.50	11.40	35.50	3.40	41.02	68.20	-27.18	Pk	Vertical
7222.99	34.04	43.50	11.40	35.50	3.40	37.44	54.00	-16.56	AV	Vertical
7234.49	37.91	43.50	11.40	35.50	3.40	41.31	68.20	-26.89	Pk	Horizontal
7234.49	34.10	43.50	11.40	35.50	3.40	37.50	54.00	-16.50	AV	Horizontal
10359.95	40.19	44.50	13.80	38.80	8.10	48.29	68.20	-19.91	Pk	Vertical
10359.95	37.06	44.50	13.80	38.80	8.10	45.16	54.00	-8.84	AV	Vertical
10360.29	38.80	44.50	13.80	38.80	8.10	46.90	68.20	-21.30	Pk	Horizontal
10360.29	36.31	44.50	13.80	38.80	8.10	44.41	54.00	-9.59	AV	Horizontal
11033.99	33.09	43.60	14.30	39.50	10.20	43.29	68.20	-24.91	Pk	Vertical
11033.99	30.31	43.60	14.30	39.50	10.20	40.51	54.00	-13.49	AV	Vertical
11018.29	33.07	43.60	14.30	39.50	10.20	43.27	68.20	-24.93	Pk	Horizontal
11018.29	30.44	43.60	14.30	39.50	10.20	40.64	54.00	-13.36	AV	Horizontal
13289.84	32.39	42.60	15.90	38.90	12.20	44.59	68.20	-23.61	Pk	Vertical
13289.84	28.57	42.60	15.90	38.90	12.20	40.77	54.00	-13.23	AV	Vertical
13290.22	32.82	42.60	15.90	38.90	12.20	45.02	68.20	-23.18	Pk	Horizontal
13290.22	28.65	42.60	15.90	38.90	12.20	40.85	54.00	-13.15	AV	Horizontal
Mid Channel (802.11ac20/ 5785MHz)										
3257.85	43.77	44.70	6.70	28.20	-9.80	33.97	68.20	-34.23	Pk	Vertical
3257.85	41.46	44.70	6.70	28.20	-9.80	31.66	54.00	-22.34	AV	Vertical
3251.49	43.99	44.70	6.70	28.20	-9.80	34.19	68.20	-34.01	Pk	Horizontal
3251.49	41.93	44.70	6.70	28.20	-9.80	32.13	54.00	-21.87	AV	Horizontal
4000.12	39.59	44.20	7.90	29.70	-6.60	32.99	68.20	-35.21	Pk	Vertical
4000.12	37.03	44.20	7.90	29.70	-6.60	30.43	54.00	-23.57	AV	Vertical
3990.27	38.89	44.20	7.90	29.70	-6.60	32.29	68.20	-35.91	Pk	Horizontal
3990.27	35.80	44.20	7.90	29.70	-6.60	29.20	54.00	-24.80	AV	Horizontal
7231.28	37.75	43.50	11.40	35.50	3.40	41.15	68.20	-27.05	Pk	Vertical
7231.28	34.90	43.50	11.40	35.50	3.40	38.30	54.00	-15.70	AV	Vertical
7234.54	37.14	43.50	11.40	35.50	3.40	40.54	68.20	-27.66	Pk	Horizontal
7234.54	33.95	43.50	11.40	35.50	3.40	37.35	54.00	-16.65	AV	Horizontal
10400.25	39.43	44.50	13.80	38.80	8.10	47.53	68.20	-20.67	Pk	Vertical
10400.25	35.75	44.50	13.80	38.80	8.10	43.85	54.00	-10.15	AV	Vertical
10400.36	39.05	44.50	13.80	38.80	8.10	47.15	68.20	-21.05	Pk	Horizontal
10400.36	37.03	44.50	13.80	38.80	8.10	45.13	54.00	-8.87	AV	Horizontal
11028.75	33.21	43.60	14.30	39.50	10.20	43.41	68.20	-24.79	Pk	Vertical
11028.75	31.07	43.60	14.30	39.50	10.20	41.27	54.00	-12.73	AV	Vertical
11036.20	32.86	43.60	14.30	39.50	10.20	43.06	68.20	-25.14	Pk	Horizontal
11036.20	30.06	43.60	14.30	39.50	10.20	40.26	54.00	-13.74	AV	Horizontal
13299.93	32.47	42.60	15.90	38.90	12.20	44.67	68.20	-23.53	Pk	Vertical
13299.93	29.83	42.60	15.90	38.90	12.20	42.03	54.00	-11.97	AV	Vertical
13293.65	32.59	42.60	15.90	38.90	12.20	44.79	68.20	-23.41	Pk	Horizontal
13293.65	28.95	42.60	15.90	38.90	12.20	41.15	54.00	-12.85	AV	Horizontal



High Channel (802.11ac20/ 5825 MHz)										
3260.11	44.48	44.70	6.70	28.20	-9.80	34.68	68.20	-33.52	Pk	Vertical
3260.11	41.22	44.70	6.70	28.20	-9.80	31.42	54.00	-22.58	AV	Vertical
3246.00	44.19	44.70	6.70	28.20	-9.80	34.39	68.20	-33.81	Pk	Horizontal
3246.00	40.84	44.70	6.70	28.20	-9.80	31.04	54.00	-22.96	AV	Horizontal
3989.53	39.68	44.20	7.90	29.70	-6.60	33.08	68.20	-35.12	Pk	Vertical
3989.53	36.96	44.20	7.90	29.70	-6.60	30.36	54.00	-23.64	AV	Vertical
3990.25	39.61	44.20	7.90	29.70	-6.60	33.01	68.20	-35.19	Pk	Horizontal
3990.25	36.73	44.20	7.90	29.70	-6.60	30.13	54.00	-23.87	AV	Horizontal
7229.94	36.54	43.50	11.40	35.50	3.40	39.94	68.20	-28.26	Pk	Vertical
7229.94	34.15	43.50	11.40	35.50	3.40	37.55	54.00	-16.45	AV	Vertical
7223.01	37.11	43.50	11.40	35.50	3.40	40.51	68.20	-27.69	Pk	Horizontal
7223.01	34.51	43.50	11.40	35.50	3.40	37.91	54.00	-16.09	AV	Horizontal
10479.95	38.91	44.50	13.80	38.80	8.10	47.01	68.20	-21.19	Pk	Vertical
10479.95	37.09	44.50	13.80	38.80	8.10	45.19	54.00	-8.81	AV	Vertical
10480.03	39.54	44.50	13.80	38.80	8.10	47.64	68.20	-20.56	Pk	Horizontal
10480.03	35.89	44.50	13.80	38.80	8.10	43.99	54.00	-10.01	AV	Horizontal
11026.49	33.75	43.60	14.30	39.50	10.20	43.95	68.20	-24.25	Pk	Vertical
11026.49	30.64	43.60	14.30	39.50	10.20	40.84	54.00	-13.16	AV	Vertical
11036.42	32.97	43.60	14.30	39.50	10.20	43.17	68.20	-25.03	Pk	Horizontal
11036.42	30.12	43.60	14.30	39.50	10.20	40.32	54.00	-13.68	AV	Horizontal
13298.33	31.85	42.60	15.90	38.90	12.20	44.05	68.20	-24.15	Pk	Vertical
13298.33	29.43	42.60	15.90	38.90	12.20	41.63	54.00	-12.37	AV	Vertical
13289.43	31.90	42.60	15.90	38.90	12.20	44.10	68.20	-24.10	Pk	Horizontal
13289.43	28.73	42.60	15.90	38.90	12.20	40.93	54.00	-13.07	AV	Horizontal

Remark:

1. Factor = Antenna Factor + Cable Loss – Pre-amplifier.
2. Scan with 802.11a, 802.11n (HT-20), 802.11n (HT-40), 802.11ac (VHT-20), 802.11ac (VHT-40), 802.11ac (VHT-80) the worst case is 802.11ac (VHT-20).
3. The frequency emission of peak points that did not show above the forms are at least 20dB below the limit, the frequency emission is mainly from the environment noise.
4. Pre-scan both the SISO and MIMO mode, only the worst-case results were reported.

3.2.9 RESTRICTED FREQUENCY BANDS AND BAND EDGE

Band I 5150-5250MHz

802.11ac20-L-H

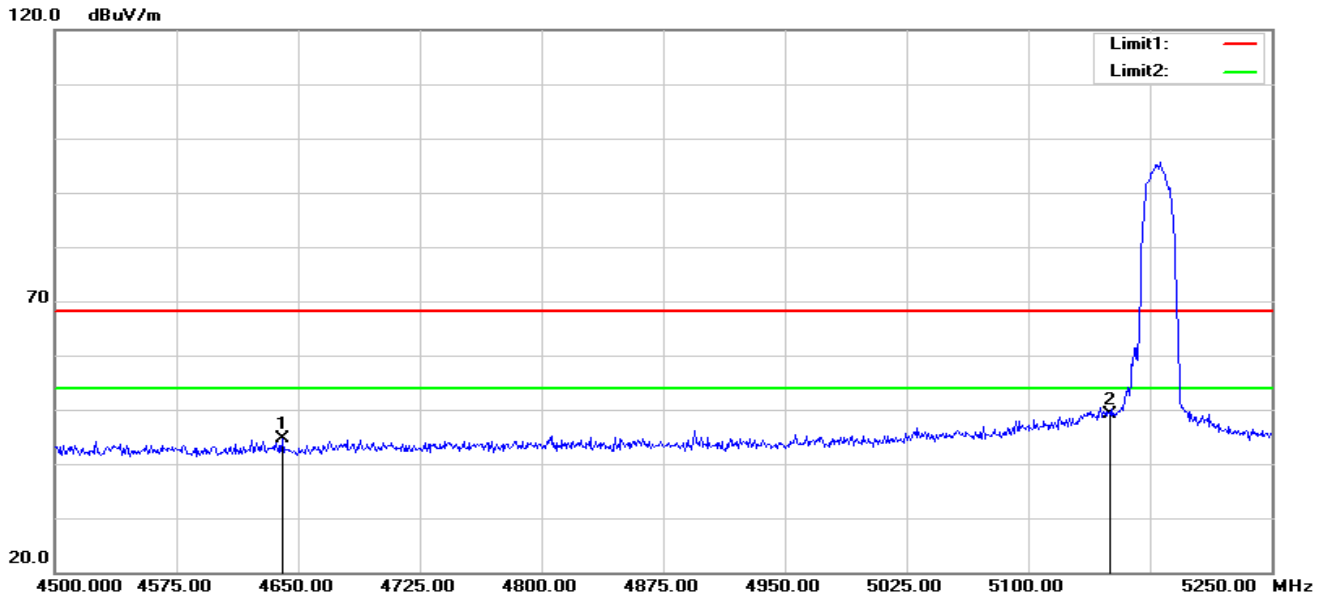

No.	Frequency (MHz)	Reading (dBuV)	Correct Factor(dB/m)	Result (dBuV/m)	Limit (dBuV/m)	Margin (dB)	Remark
1	4640.250	52.22	-7.67	44.55	68.20	-23.65	peak
2	5150.000	54.88	-5.73	49.15	68.20	-19.05	peak

802.11ac20-L-V

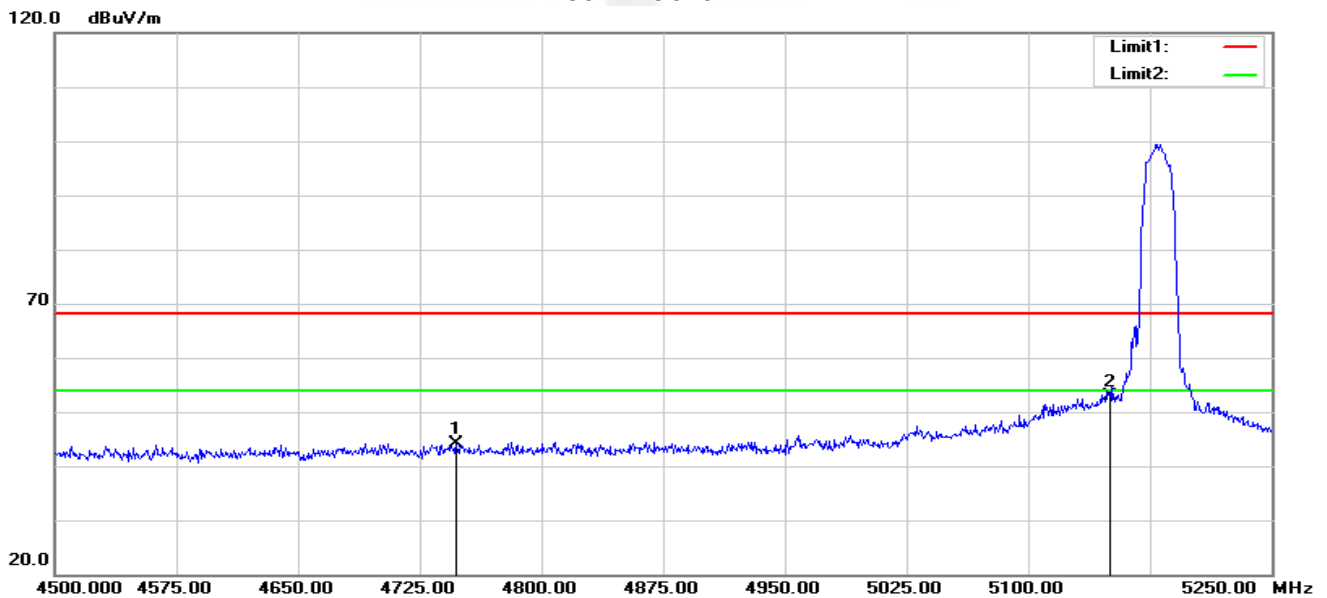

No.	Frequency (MHz)	Reading (dBuV)	Correct Factor(dB/m)	Result (dBuV/m)	Limit (dBuV/m)	Margin (dB)	Remark
1	4747.500	51.54	-7.29	44.25	68.20	-23.95	peak
2	5150.000	58.70	-5.73	52.97	68.20	-15.23	peak



802.11ac20-H-H

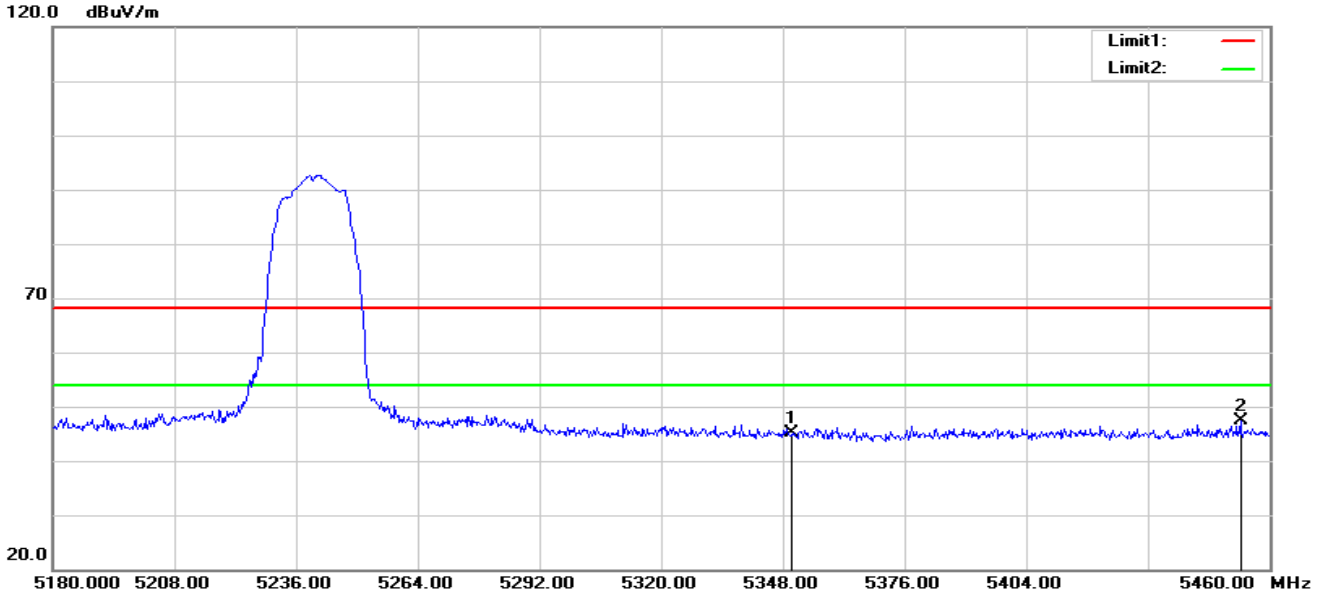

No.	Frequency (MHz)	Reading (dBuV)	Correct Factor(dB/m)	Result (dBuV/m)	Limit (dBuV/m)	Margin (dB)	Remark
1	5350.000	50.25	-5.23	45.02	68.20	-23.18	peak
2	5453.280	52.43	-5.13	47.30	68.20	-20.90	peak

802.11ac20-H-V

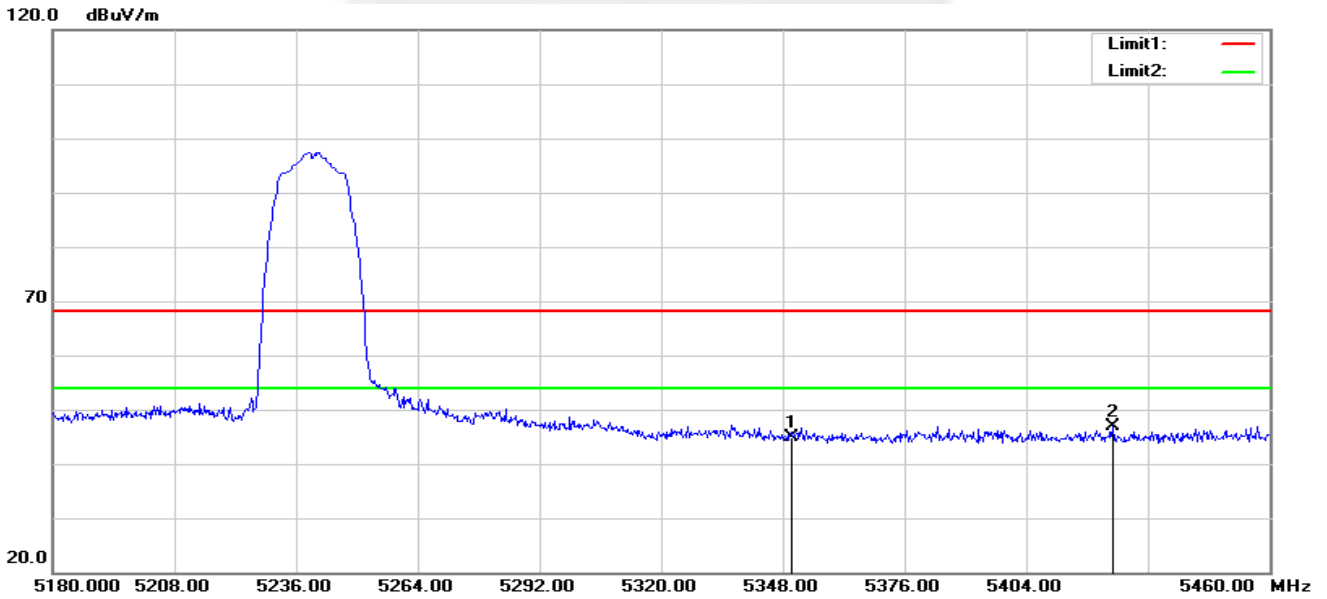

No.	Frequency (MHz)	Reading (dBuV)	Correct Factor(dB/m)	Result (dBuV/m)	Limit (dBuV/m)	Margin (dB)	Remark
1	5350.000	50.03	-5.23	44.80	68.20	-23.40	peak
2	5423.880	52.03	-5.19	46.84	68.20	-21.36	peak



802.11ac40-L-H

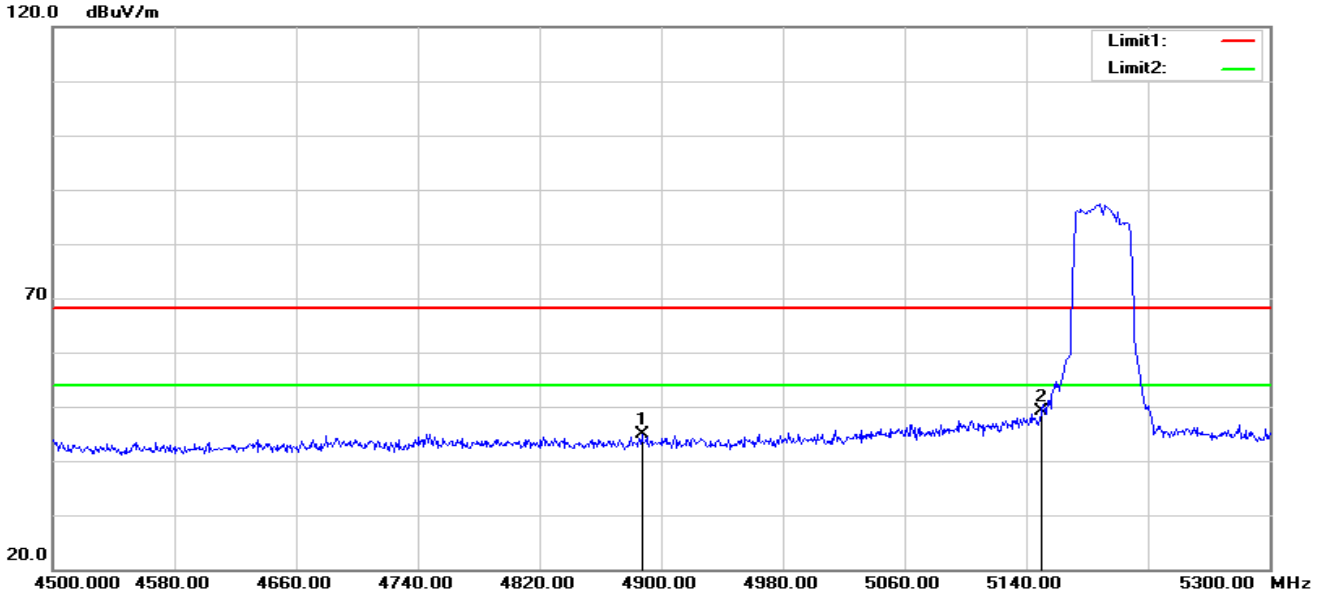

No.	Frequency (MHz)	Reading (dBuV)	Correct Factor(dB/m)	Result (dBuV/m)	Limit (dBuV/m)	Margin (dB)	Remark
1	4887.200	51.81	-6.89	44.92	68.20	-23.28	peak
2	5150.000	54.98	-5.73	49.25	68.20	-18.95	peak

802.11ac40-L-V

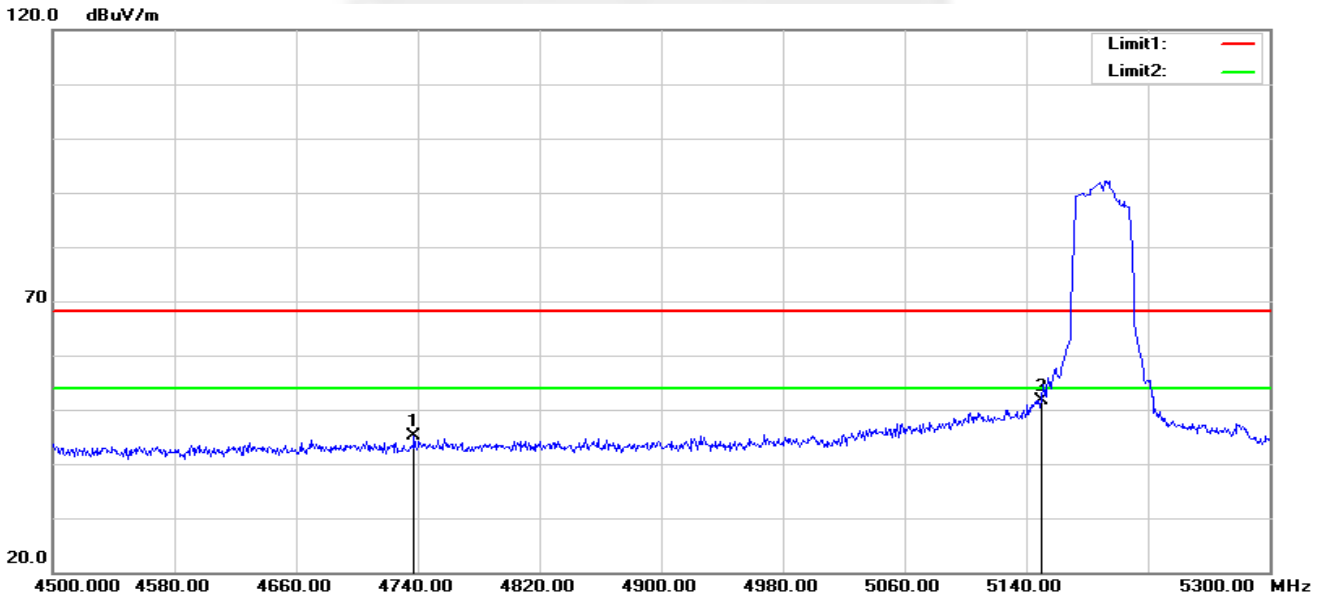

No.	Frequency (MHz)	Reading (dBuV)	Correct Factor(dB/m)	Result (dBuV/m)	Limit (dBuV/m)	Margin (dB)	Remark
1	4737.600	52.35	-7.30	45.05	68.20	-23.15	peak
2	5150.000	57.40	-5.73	51.67	68.20	-16.53	peak



802.11ac40-H-H

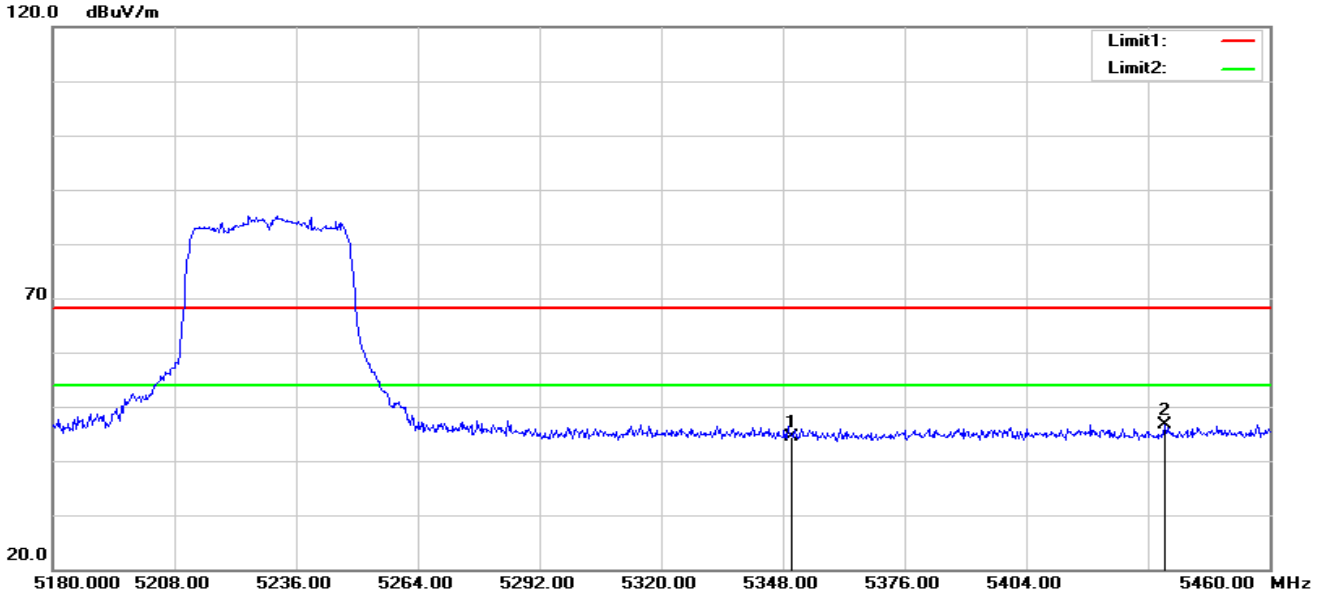

No.	Frequency (MHz)	Reading (dBuV)	Correct Factor(dB/m)	Result (dBuV/m)	Limit (dBuV/m)	Margin (dB)	Remark
1	5350.000	49.67	-5.23	44.44	68.20	-23.76	peak
2	5435.920	51.88	-5.17	46.71	68.20	-21.49	peak

802.11ac40-H-V

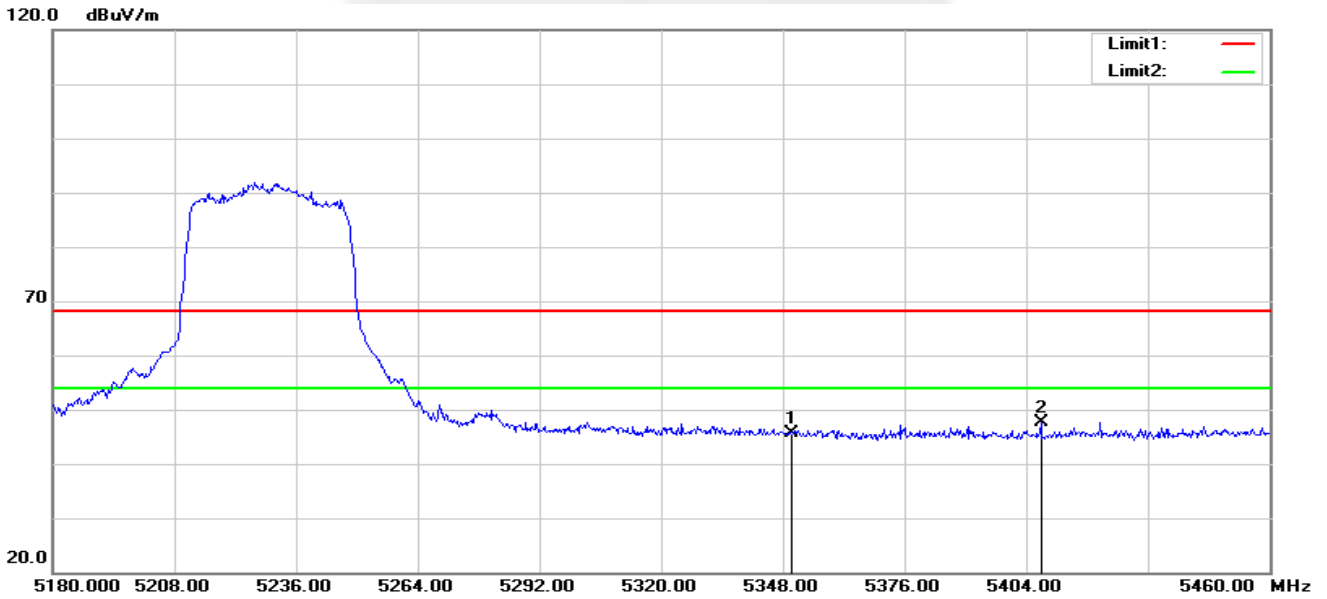

No.	Frequency (MHz)	Reading (dBuV)	Correct Factor(dB/m)	Result (dBuV/m)	Limit (dBuV/m)	Margin (dB)	Remark
1	5350.000	50.93	-5.23	45.70	68.20	-22.50	peak
2	5407.360	52.79	-5.23	47.56	68.20	-20.64	peak



802.11ac80-L-H

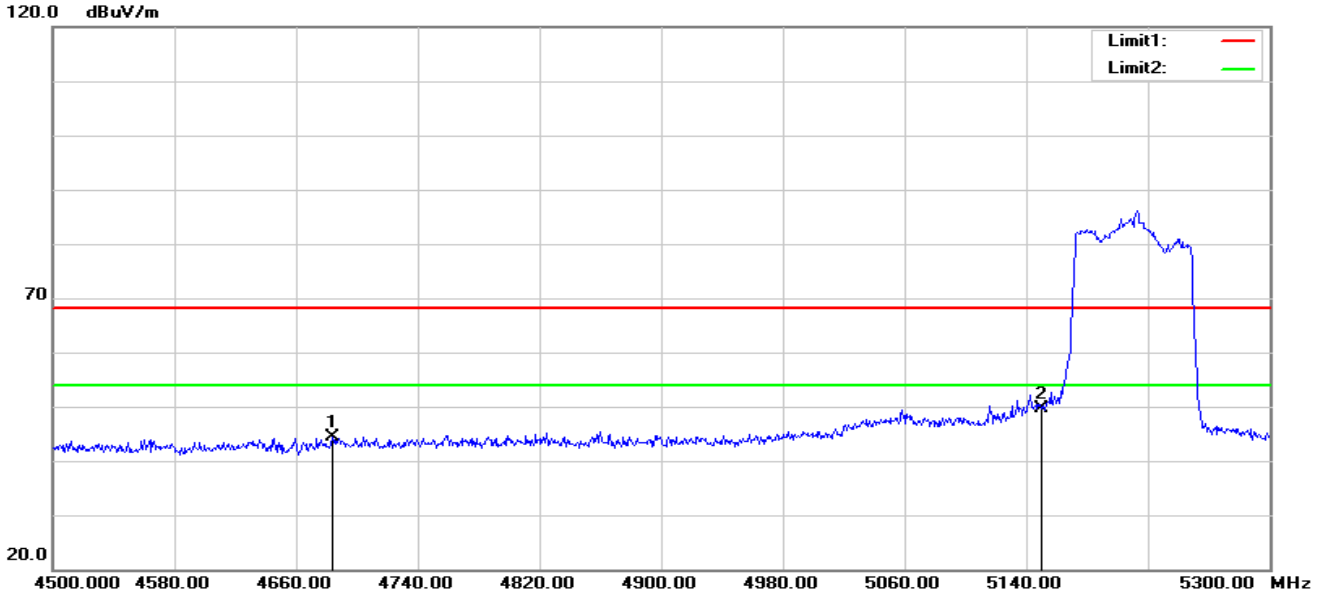

No.	Frequency (MHz)	Reading (dBuV)	Correct Factor(dB/m)	Result (dBuV/m)	Limit (dBuV/m)	Margin (dB)	Remark
1	4684.000	51.79	-7.44	44.35	68.20	-23.85	peak
2	5150.000	55.43	-5.73	49.70	68.20	-18.50	peak

802.11ac80-L-V

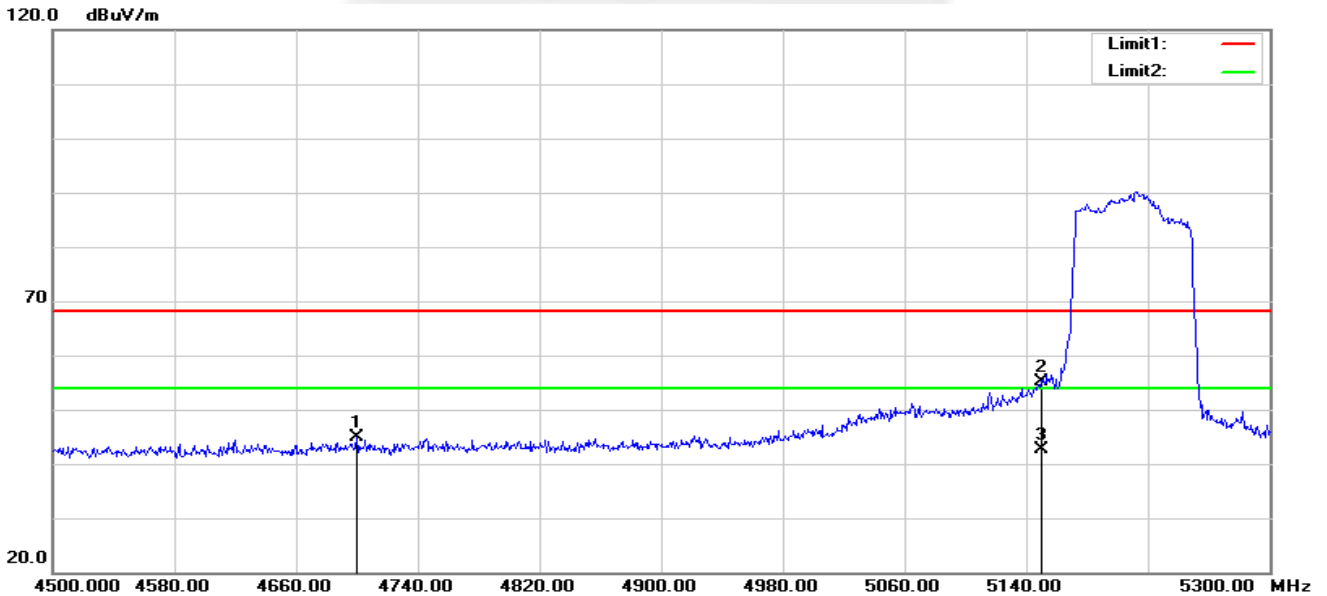

No.	Frequency (MHz)	Reading (dBuV)	Correct Factor(dB/m)	Result (dBuV/m)	Limit (dBuV/m)	Margin (dB)	Remark
1	4700.000	52.25	-7.36	44.89	68.20	-23.31	peak
2	5150.000	60.79	-5.73	55.06	68.20	-13.14	peak
3	5150.000	48.32	-5.73	42.59	54.00	-11.41	AVG



802.11ac80-H-H

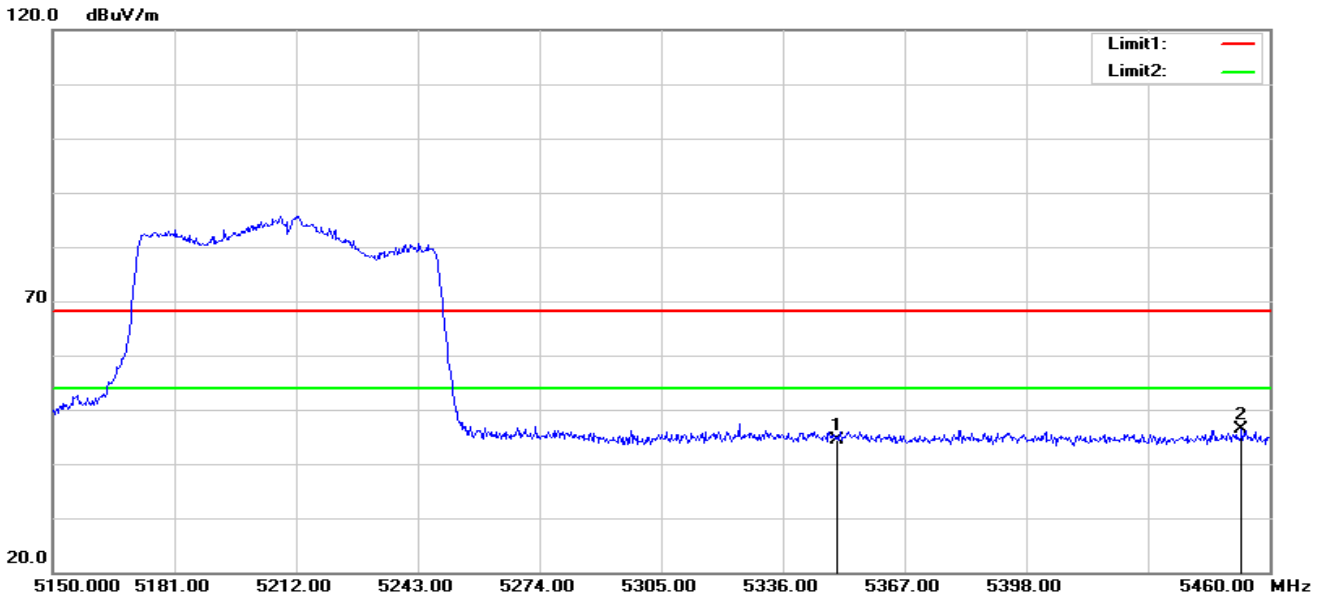

No.	Frequency (MHz)	Reading (dBuV)	Correct Factor(dB/m)	Result (dBuV/m)	Limit (dBuV/m)	Margin (dB)	Remark
1	5350.000	49.53	-5.23	44.30	68.20	-23.90	peak
2	5452.870	51.55	-5.13	46.42	68.20	-21.78	peak

802.11ac80-H-V

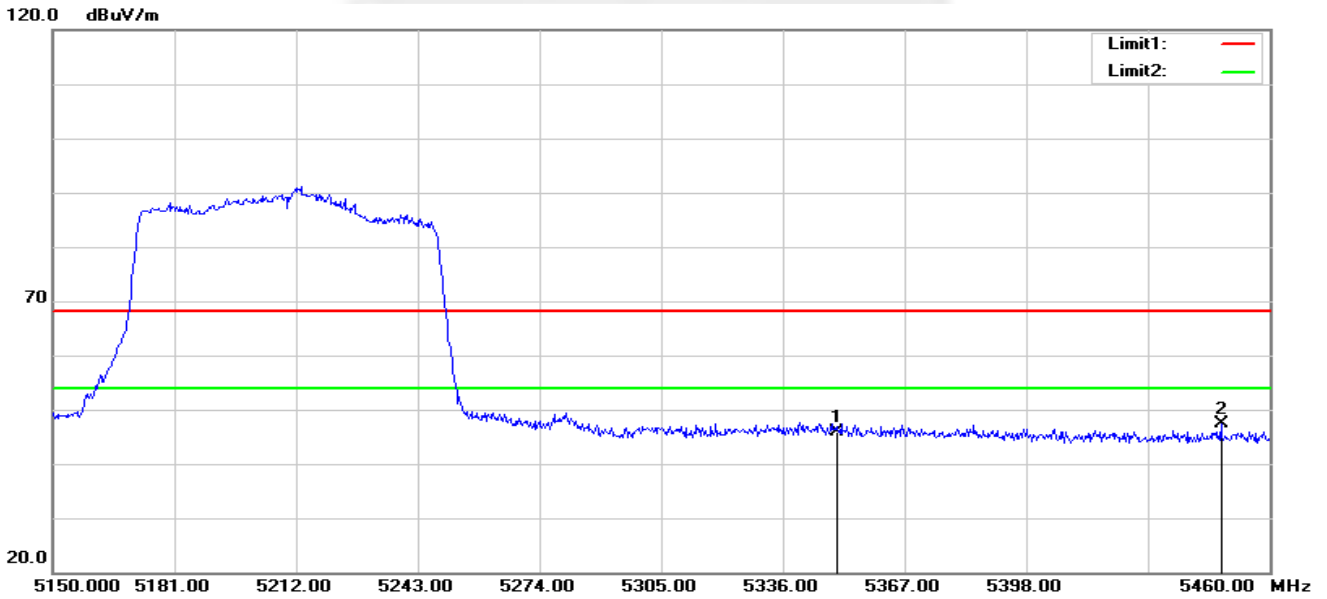

No.	Frequency (MHz)	Reading (dBuV)	Correct Factor(dB/m)	Result (dBuV/m)	Limit (dBuV/m)	Margin (dB)	Remark
1	5350.000	51.15	-5.23	45.92	68.20	-22.28	peak
2	5447.600	52.51	-5.14	47.37	68.20	-20.83	peak

Note: All modes have been tested. Only the worst mode shown in the report.



Band II 5250-5350MHz

802.11n20-L-H

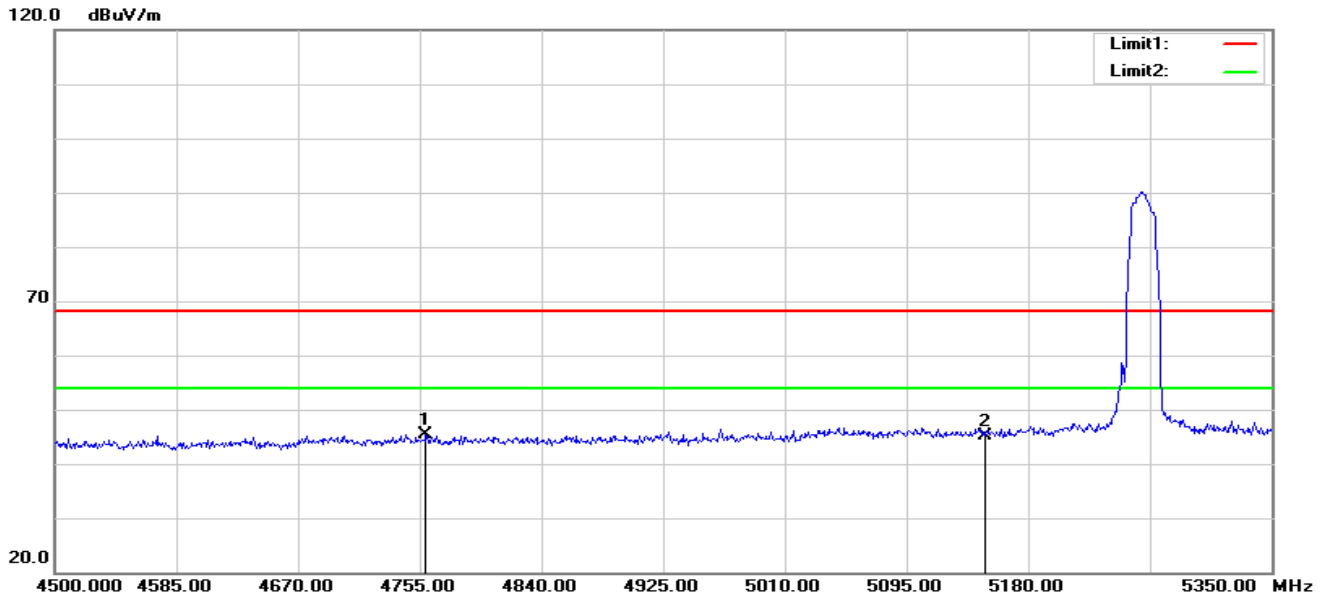

No.	Frequency (MHz)	Reading (dBuV)	Correct Factor(dB/m)	Result (dBuV/m)	Limit (dBuV/m)	Margin (dB)	Remark
1	4759.250	52.65	-7.28	45.37	68.20	-22.83	peak
2	5150.000	50.76	-5.73	45.03	68.20	-23.17	peak

802.11n20-L-V

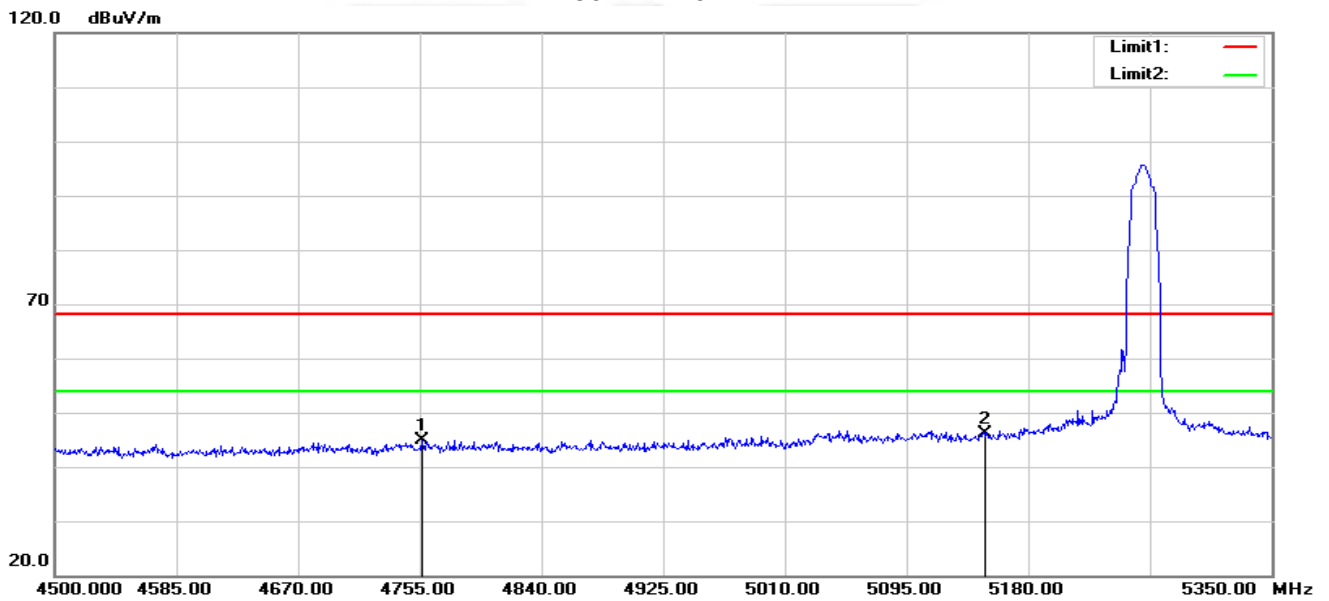

No.	Frequency (MHz)	Reading (dBuV)	Correct Factor(dB/m)	Result (dBuV/m)	Limit (dBuV/m)	Margin (dB)	Remark
1	4756.700	52.25	-7.28	44.97	68.20	-23.23	peak
2	5150.000	51.79	-5.73	46.06	68.20	-22.14	peak



802.11n20-H-H

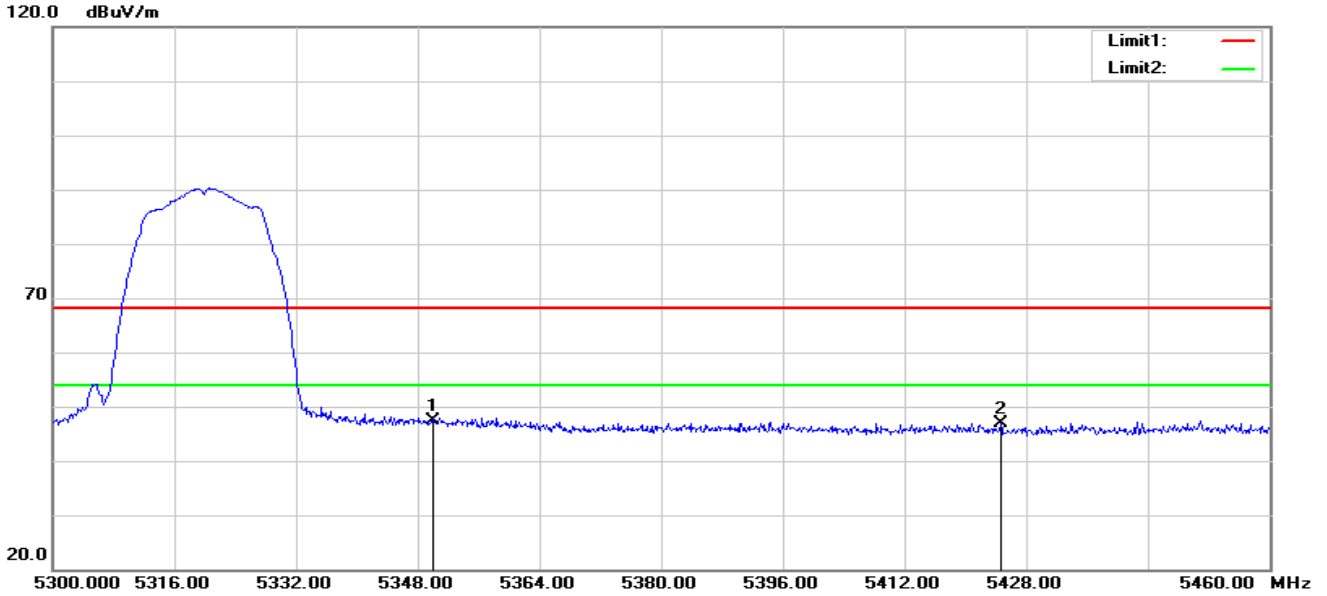

No.	Frequency (MHz)	Reading (dBuV)	Correct Factor(dB/m)	Result (dBuV/m)	Limit (dBuV/m)	Margin (dB)	Remark
1	5350.000	52.53	-5.23	47.30	68.20	-20.90	peak
2	5424.640	52.16	-5.19	46.97	68.20	-21.23	peak

802.11n20-H-V

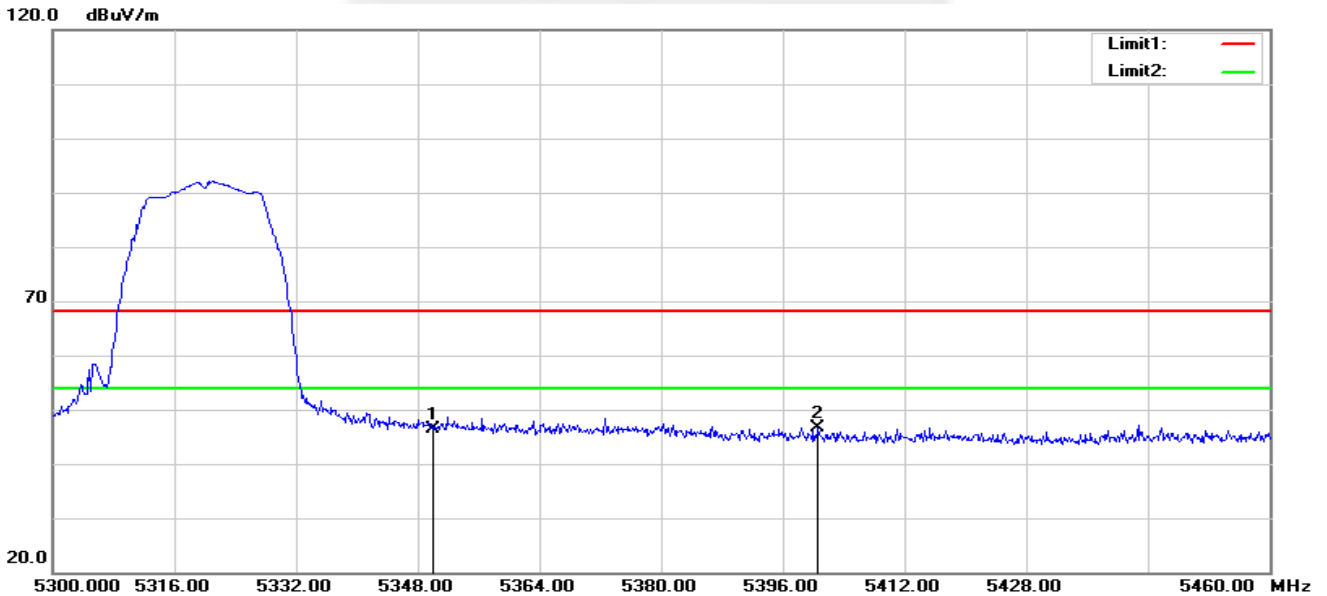

No.	Frequency (MHz)	Reading (dBuV)	Correct Factor(dB/m)	Result (dBuV/m)	Limit (dBuV/m)	Margin (dB)	Remark
1	5350.000	51.51	-5.23	46.28	68.20	-21.92	peak
2	5400.640	52.00	-5.25	46.75	68.20	-21.45	peak



802.11ac40-L-H

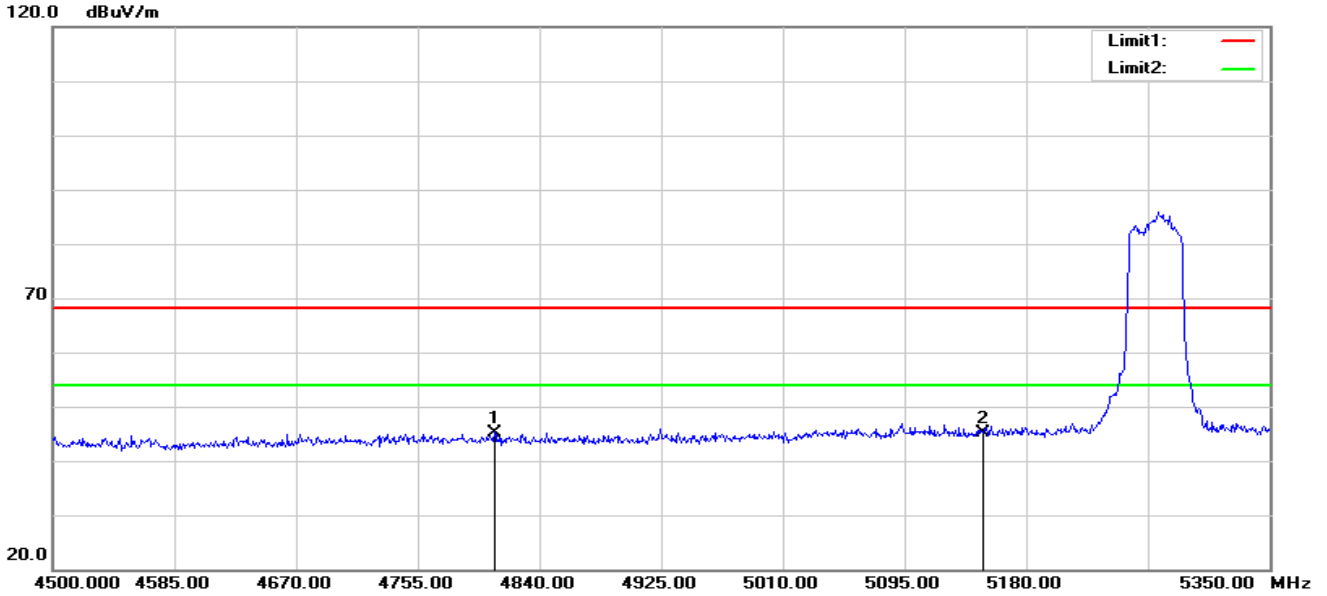

No.	Frequency (MHz)	Reading (dBuV)	Correct Factor(dB/m)	Result (dBuV/m)	Limit (dBuV/m)	Margin (dB)	Remark
1	4808.550	52.43	-7.18	45.25	68.20	-22.95	peak
2	5150.000	50.79	-5.73	45.06	68.20	-23.14	peak

802.11ac40-L-V

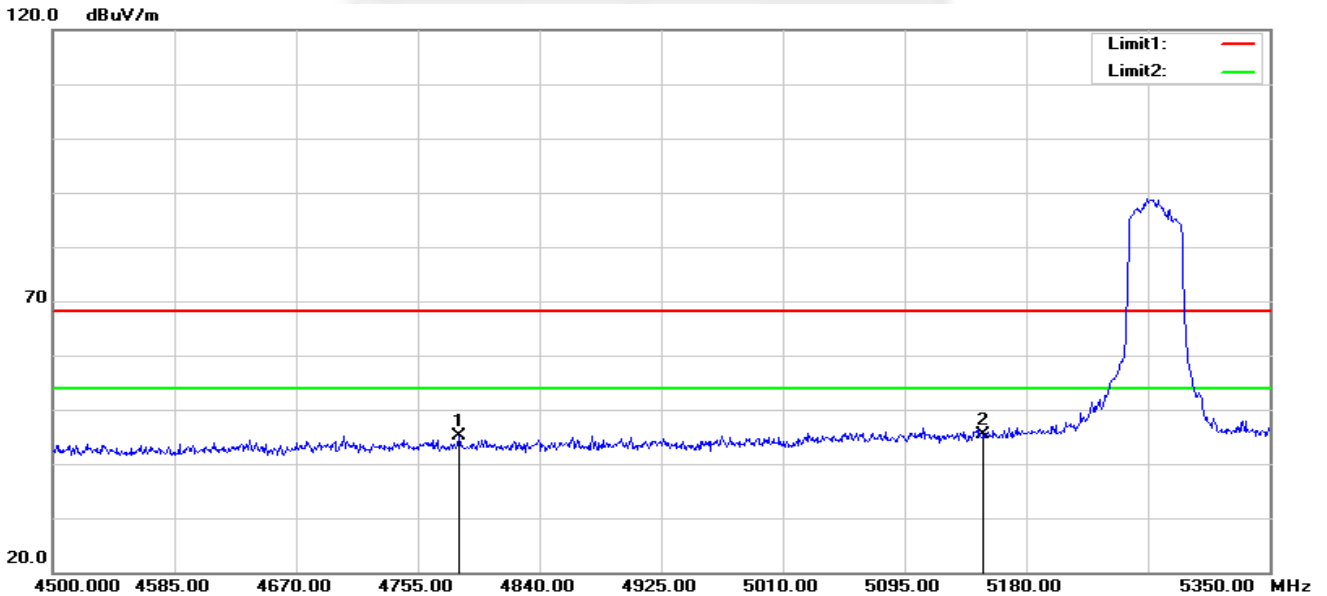

No.	Frequency (MHz)	Reading (dBuV)	Correct Factor(dB/m)	Result (dBuV/m)	Limit (dBuV/m)	Margin (dB)	Remark
1	4783.900	52.38	-7.24	45.14	68.20	-23.06	peak
2	5150.000	51.07	-5.73	45.34	68.20	-22.86	peak



802.11ac40-H-H

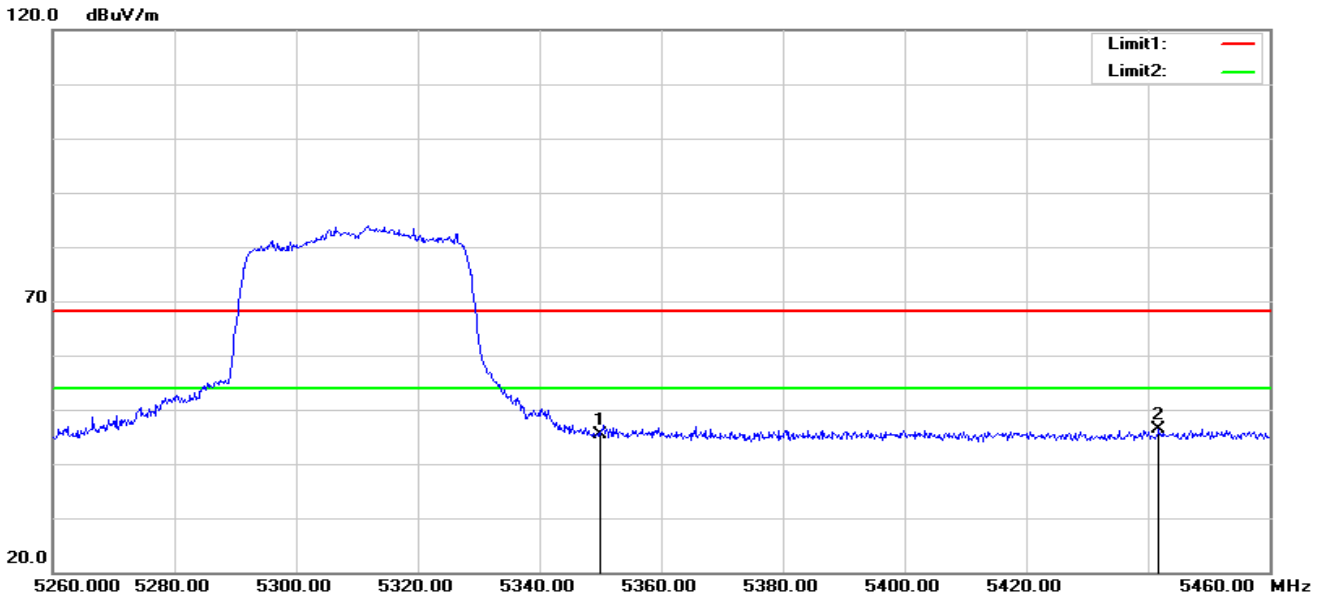

No.	Frequency (MHz)	Reading (dBuV)	Correct Factor(dB/m)	Result (dBuV/m)	Limit (dBuV/m)	Margin (dB)	Remark
1	5350.000	50.57	-5.23	45.34	68.20	-22.86	peak
2	5441.800	51.43	-5.16	46.27	68.20	-21.93	peak

802.11ac40-H-V

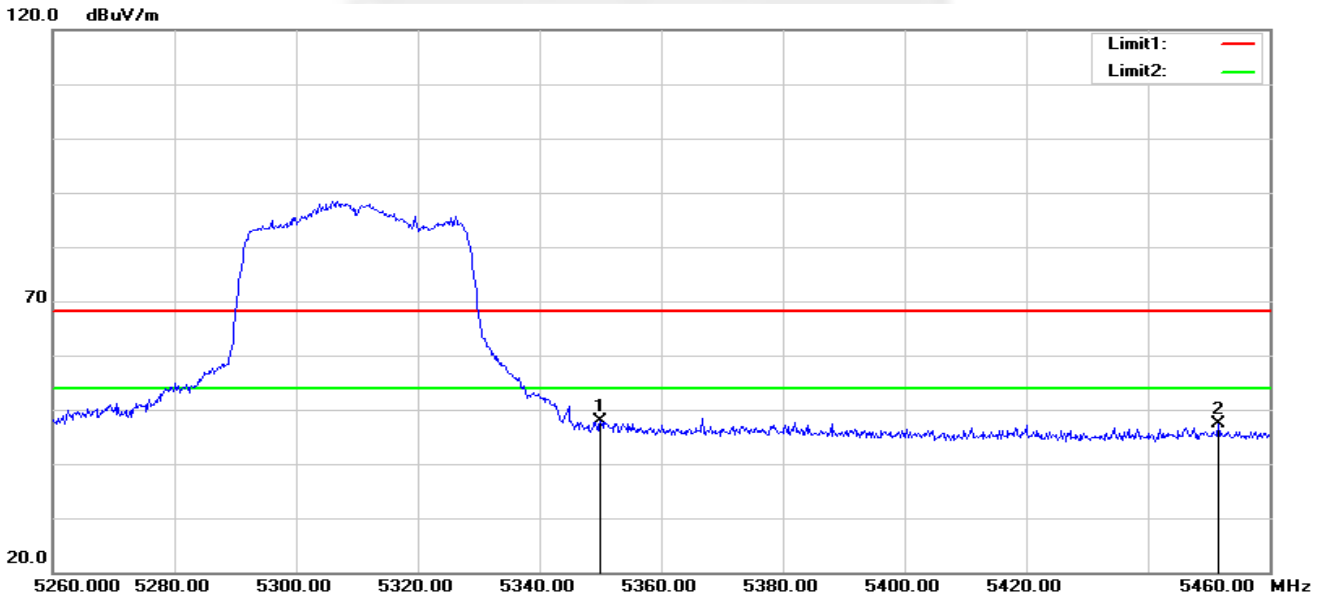

No.	Frequency (MHz)	Reading (dBuV)	Correct Factor(dB/m)	Result (dBuV/m)	Limit (dBuV/m)	Margin (dB)	Remark
1	5350.000	53.14	-5.23	47.91	68.20	-20.29	peak
2	5451.600	52.43	-5.13	47.30	68.20	-20.90	peak



802.11ac80-L-H

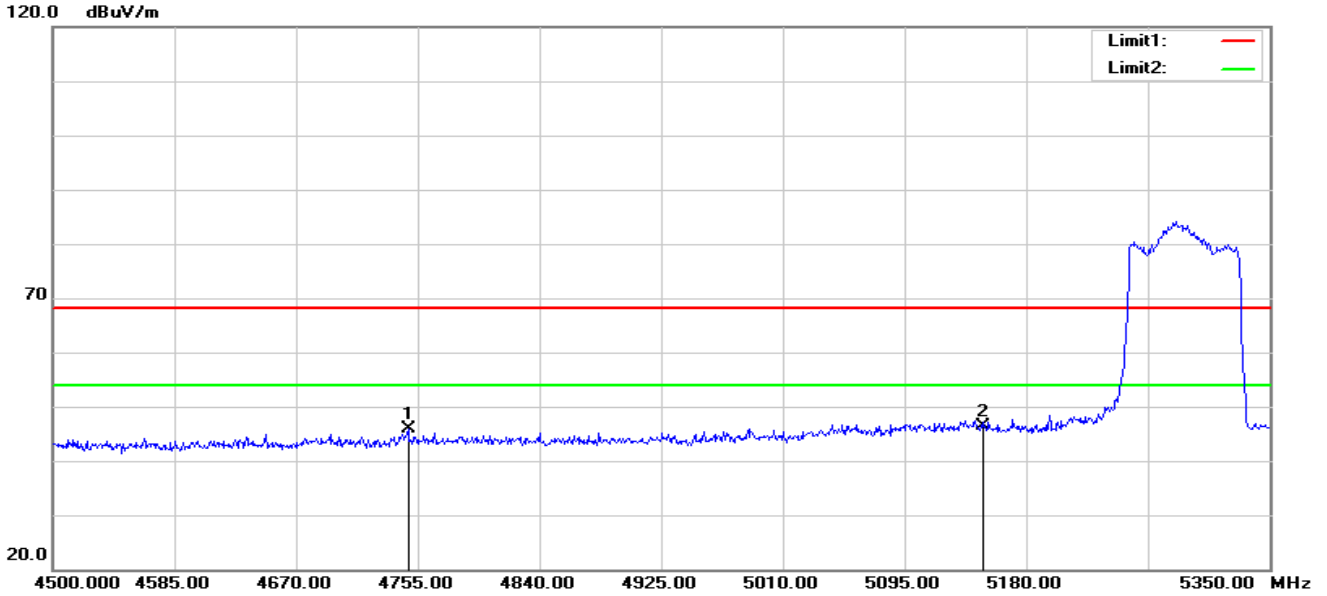

No.	Frequency (MHz)	Reading (dBuV)	Correct Factor(dB/m)	Result (dBuV/m)	Limit (dBuV/m)	Margin (dB)	Remark
1	4748.200	53.09	-7.29	45.80	68.20	-22.40	peak
2	5150.000	52.23	-5.73	46.50	68.20	-21.70	peak

802.11ac80-L-V

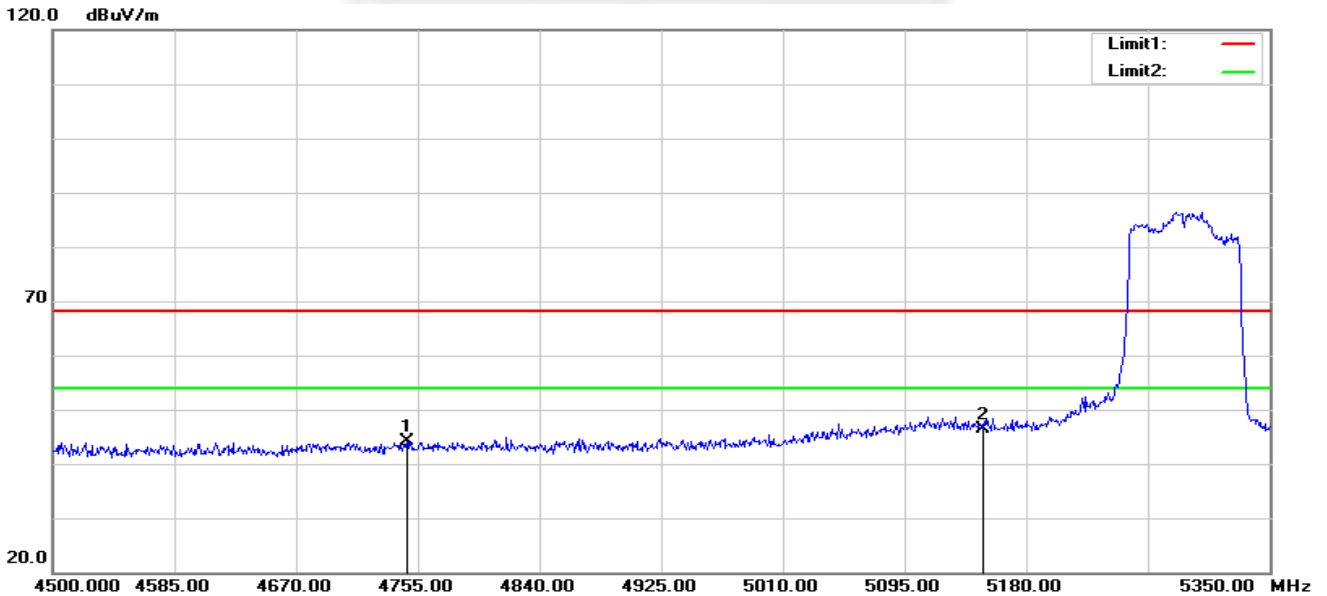

No.	Frequency (MHz)	Reading (dBuV)	Correct Factor(dB/m)	Result (dBuV/m)	Limit (dBuV/m)	Margin (dB)	Remark
1	4747.350	51.31	-7.30	44.01	68.20	-24.19	peak
2	5150.000	52.16	-5.73	46.43	68.20	-21.77	peak



802.11ac80-H-H

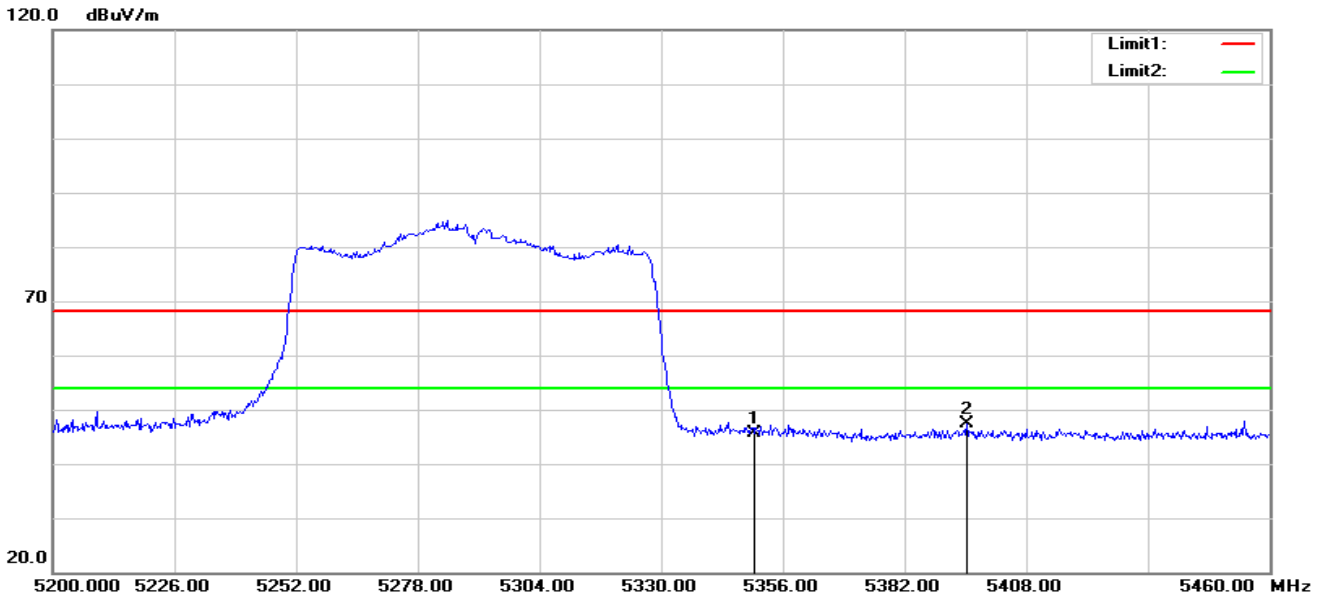

No.	Frequency (MHz)	Reading (dBuV)	Correct Factor(dB/m)	Result (dBuV/m)	Limit (dBuV/m)	Margin (dB)	Remark
1	5350.000	50.83	-5.23	45.60	68.20	-22.60	peak
2	5395.260	52.50	-5.24	47.26	68.20	-20.94	peak

802.11ac80-H-V

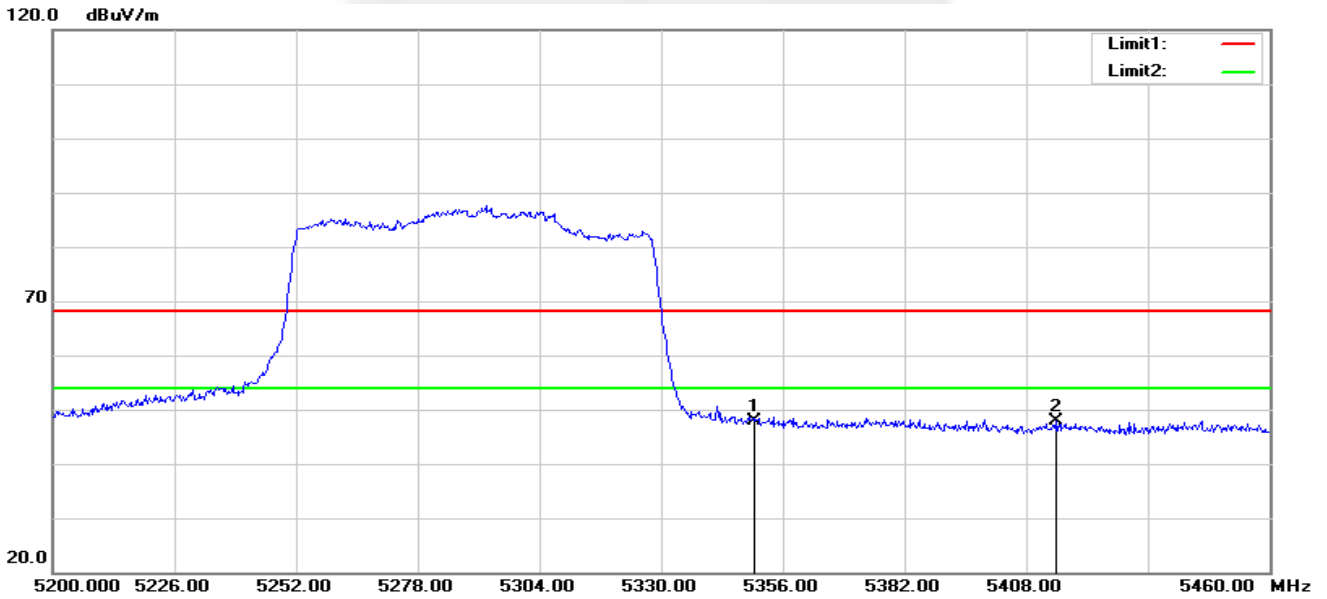

No.	Frequency (MHz)	Reading (dBuV)	Correct Factor(dB/m)	Result (dBuV/m)	Limit (dBuV/m)	Margin (dB)	Remark
1	5350.000	52.99	-5.23	47.76	68.20	-20.44	peak
2	5414.500	53.18	-5.22	47.96	68.20	-20.24	peak

Note: All modes have been tested. Only the worst mode shown in the report.



Band III 5470-5725MHz

802.11n20-L-H

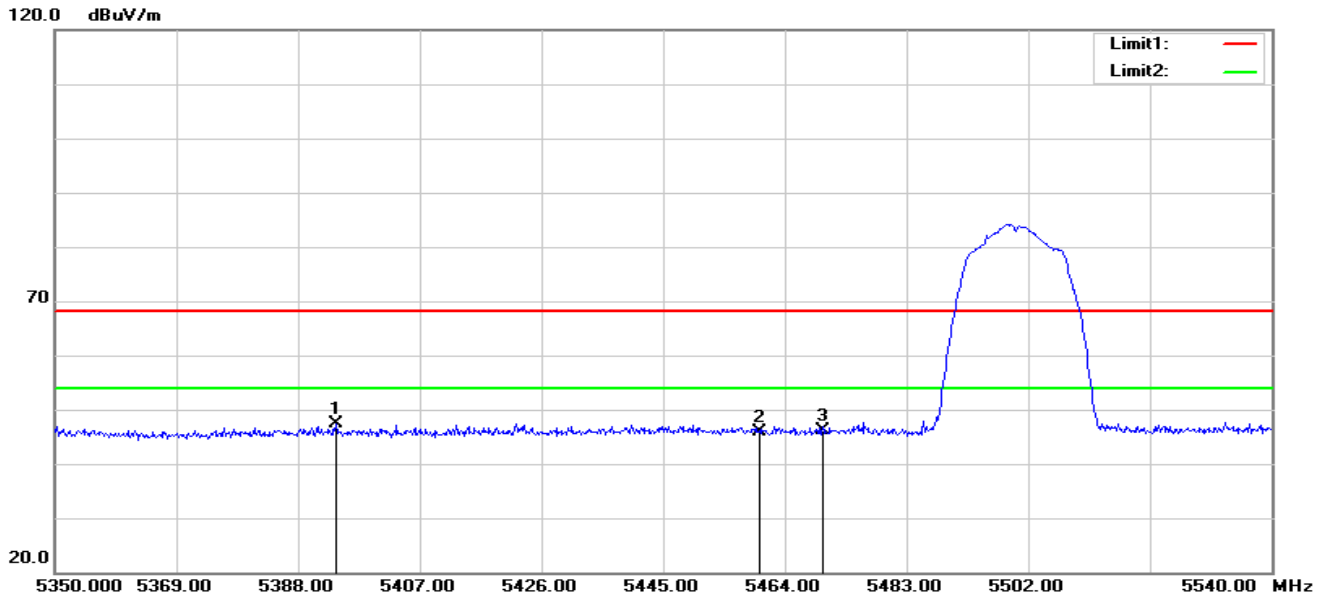

No.	Frequency (MHz)	Reading (dBuV)	Correct Factor(dB/m)	Result (dBuV/m)	Limit (dBuV/m)	Margin (dB)	Remark
1	5393.890	52.68	-5.24	47.44	68.20	-20.76	peak
2	5460.000	50.91	-5.11	45.80	68.20	-22.40	peak
3	5470.000	51.14	-5.09	46.05	68.20	-22.15	peak

802.11n20-L-V

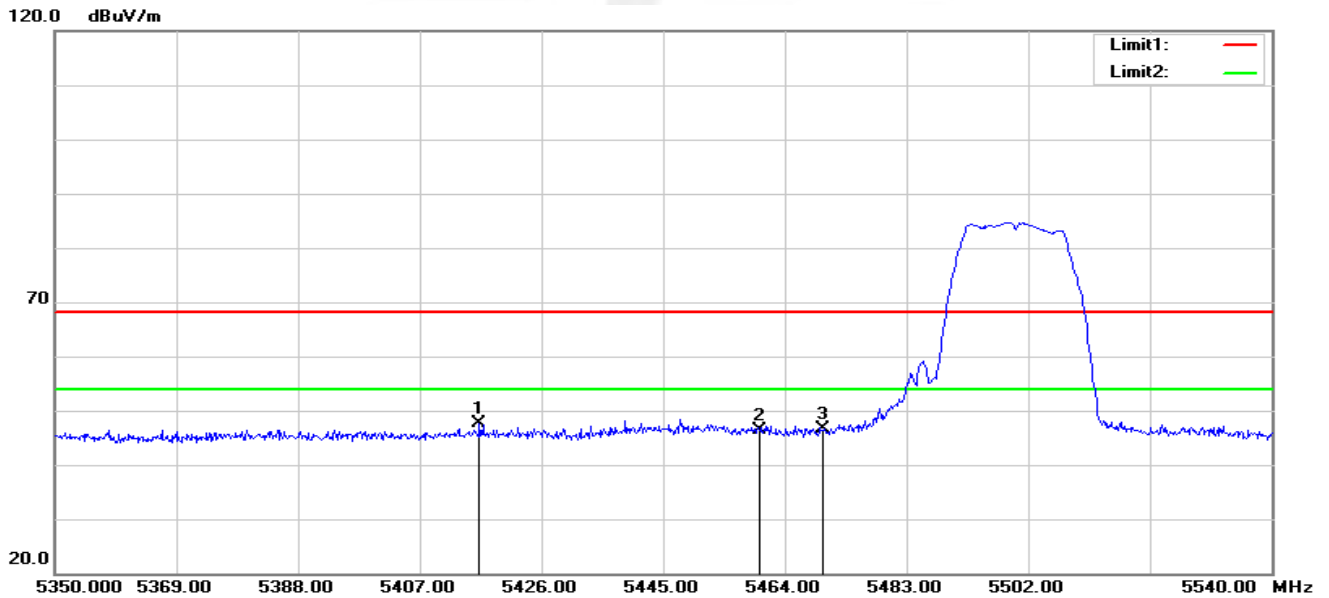

No.	Frequency (MHz)	Reading (dBuV)	Correct Factor(dB/m)	Result (dBuV/m)	Limit (dBuV/m)	Margin (dB)	Remark
1	5416.310	52.78	-5.22	47.56	68.20	-20.64	peak
2	5460.000	51.51	-5.11	46.40	68.20	-21.80	peak
3	5470.000	51.84	-5.09	46.75	68.20	-21.45	peak



802.11n20-H-H

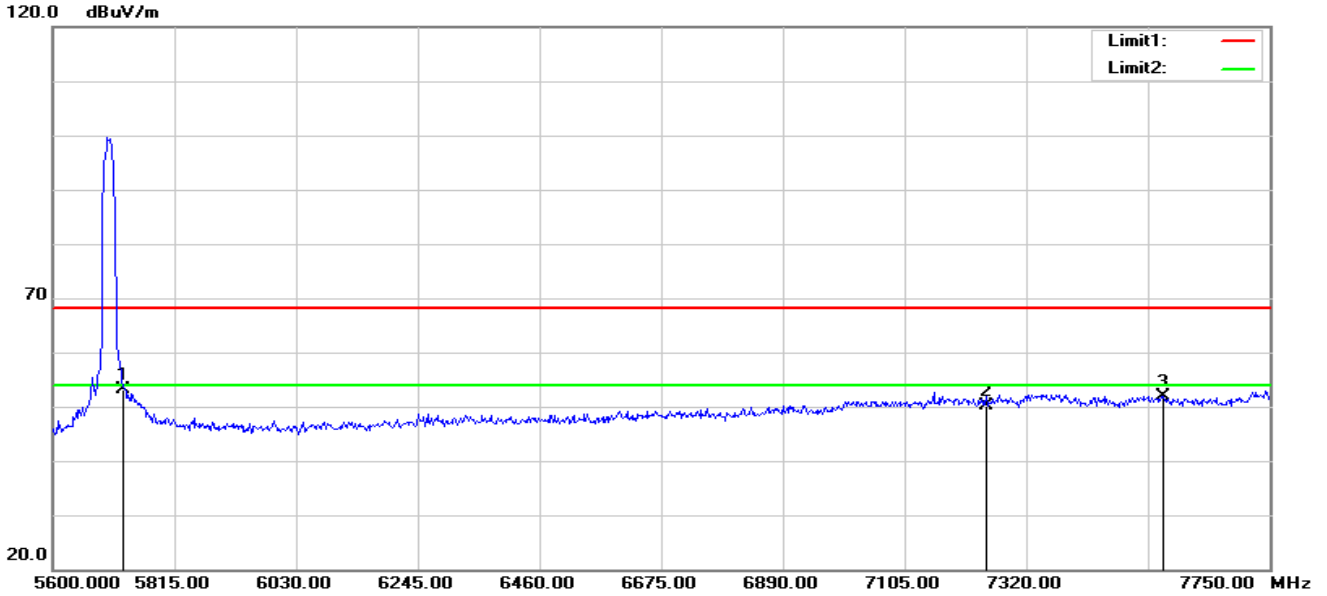

No.	Frequency (MHz)	Reading (dBuV)	Correct Factor(dB/m)	Result (dBuV/m)	Limit (dBuV/m)	Margin (dB)	Remark
1	5725.000	57.66	-4.57	53.09	68.20	-15.11	peak
2	7250.000	49.50	0.72	50.22	68.20	-17.98	peak
3	7560.800	50.25	1.69	51.94	68.20	-16.26	peak

802.11n20-H-V

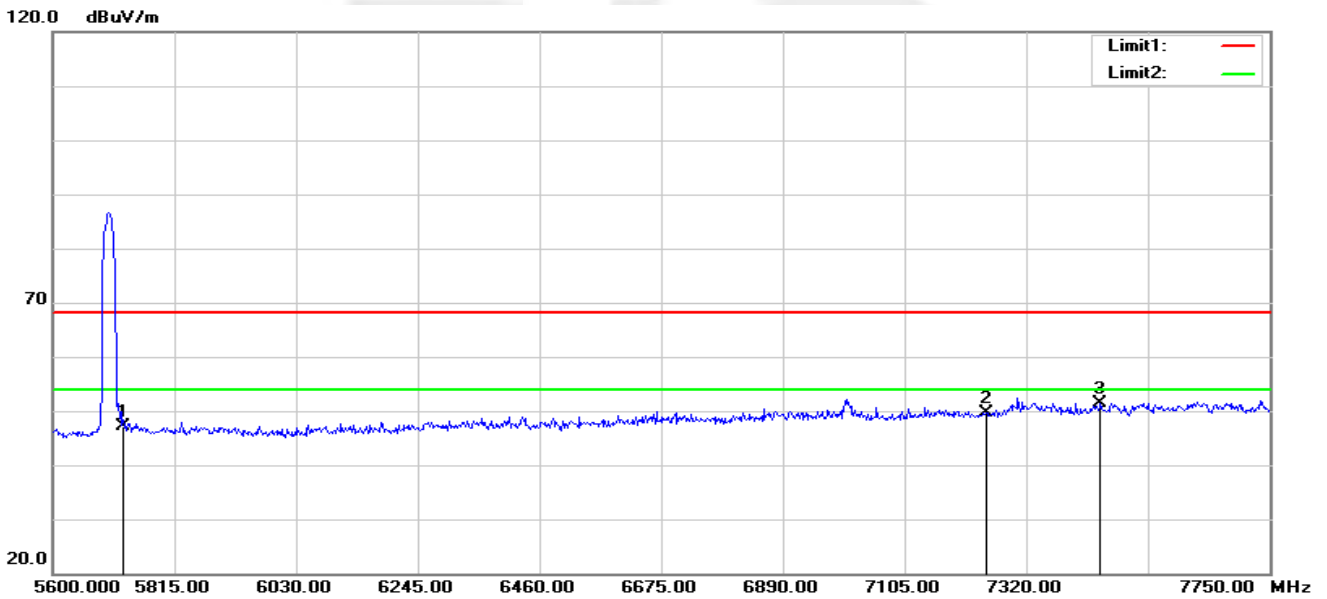

No.	Frequency (MHz)	Reading (dBuV)	Correct Factor(dB/m)	Result (dBuV/m)	Limit (dBuV/m)	Margin (dB)	Remark
1	5725.000	51.74	-4.57	47.17	68.20	-21.03	peak
2	7250.000	48.86	0.72	49.58	68.20	-18.62	peak
3	7451.150	50.03	1.45	51.48	68.20	-16.72	peak



802.11ac40-L-H

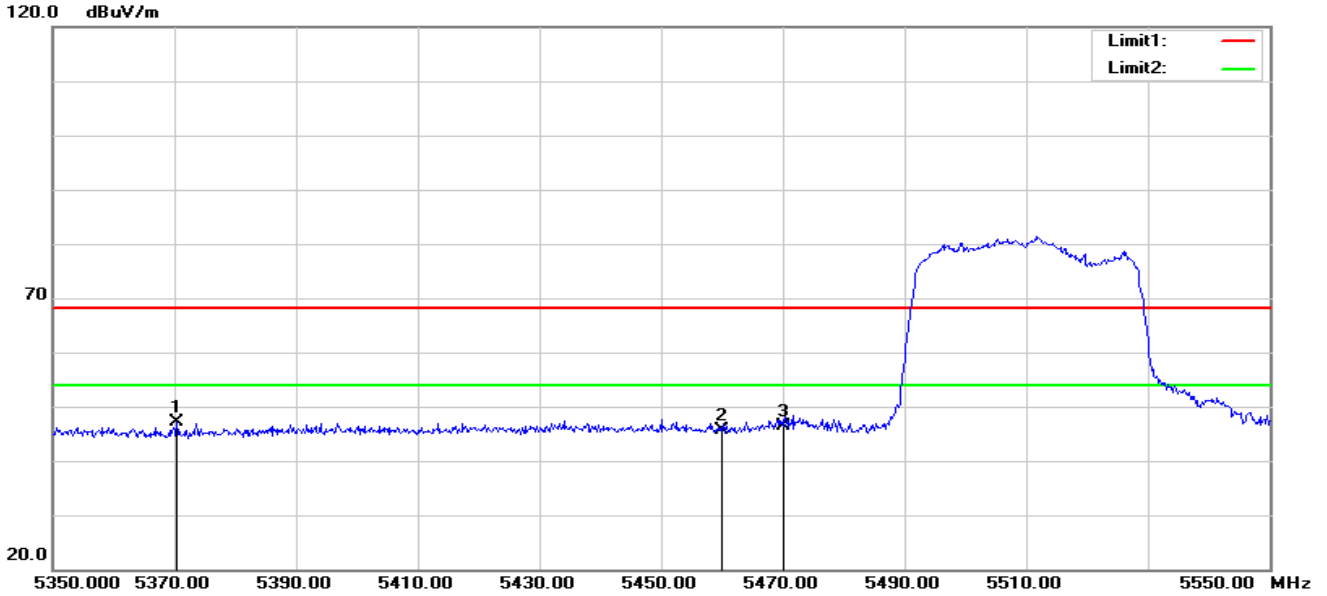

No.	Frequency (MHz)	Reading (dBuV)	Correct Factor(dB/m)	Result (dBuV/m)	Limit (dBuV/m)	Margin (dB)	Remark
1	5370.400	52.27	-5.23	47.04	68.20	-21.16	peak
2	5460.000	50.75	-5.11	45.64	68.20	-22.56	peak
3	5470.000	51.52	-5.09	46.43	68.20	-21.77	peak

802.11ac40-L-V

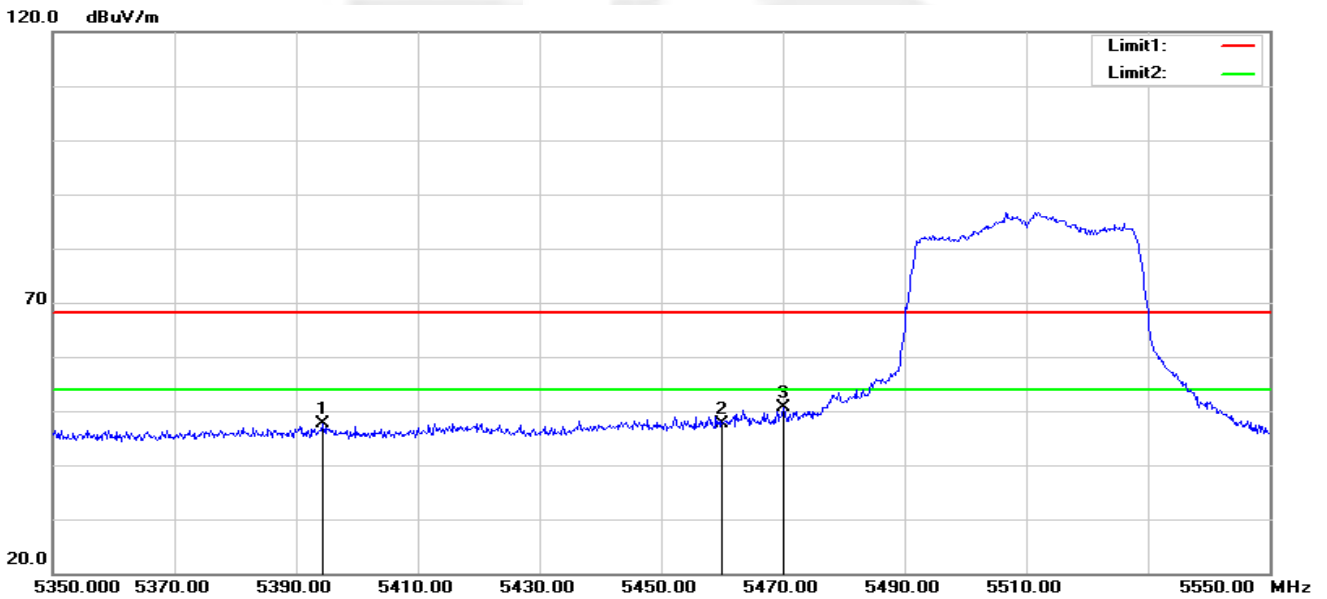

No.	Frequency (MHz)	Reading (dBuV)	Correct Factor(dB/m)	Result (dBuV/m)	Limit (dBuV/m)	Margin (dB)	Remark
1	5394.400	52.79	-5.24	47.55	68.20	-20.65	peak
2	5460.000	52.65	-5.11	47.54	68.20	-20.66	peak
3	5470.000	55.82	-5.09	50.73	68.20	-17.47	peak



802.11ac40-H-H

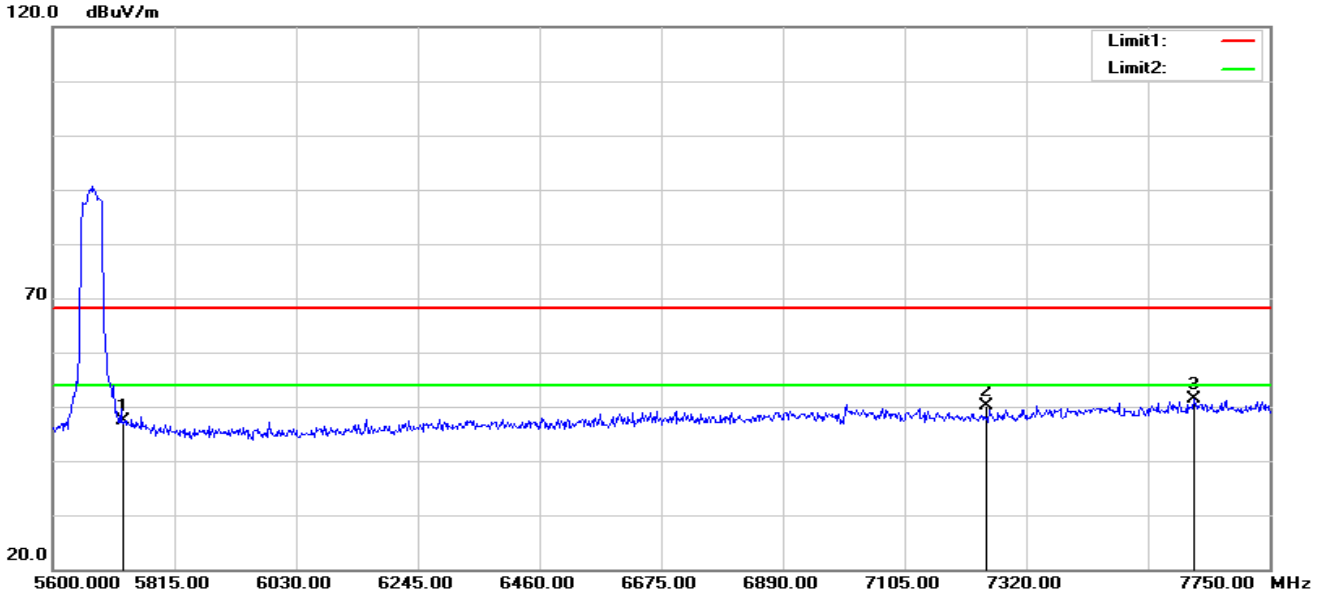

No.	Frequency (MHz)	Reading (dBuV)	Correct Factor(dB/m)	Result (dBuV/m)	Limit (dBuV/m)	Margin (dB)	Remark
1	5725.000	52.04	-4.57	47.47	68.20	-20.73	peak
2	7250.000	49.38	0.72	50.10	68.20	-18.10	peak
3	7616.700	49.55	1.76	51.31	68.20	-16.89	peak

802.11ac40-H-V

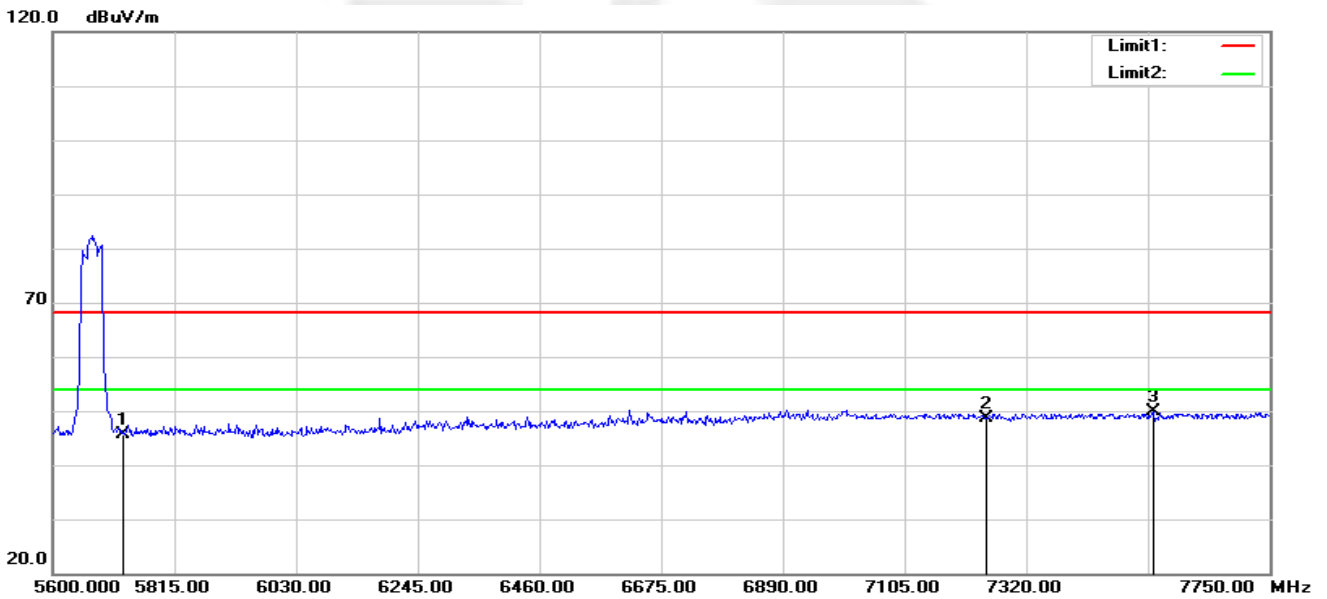

No.	Frequency (MHz)	Reading (dBuV)	Correct Factor(dB/m)	Result (dBuV/m)	Limit (dBuV/m)	Margin (dB)	Remark
1	5725.000	50.21	-4.57	45.64	68.20	-22.56	peak
2	7250.000	47.83	0.72	48.55	68.20	-19.65	peak
3	7543.600	48.13	1.68	49.81	68.20	-18.39	peak



802.11ac80-L-H

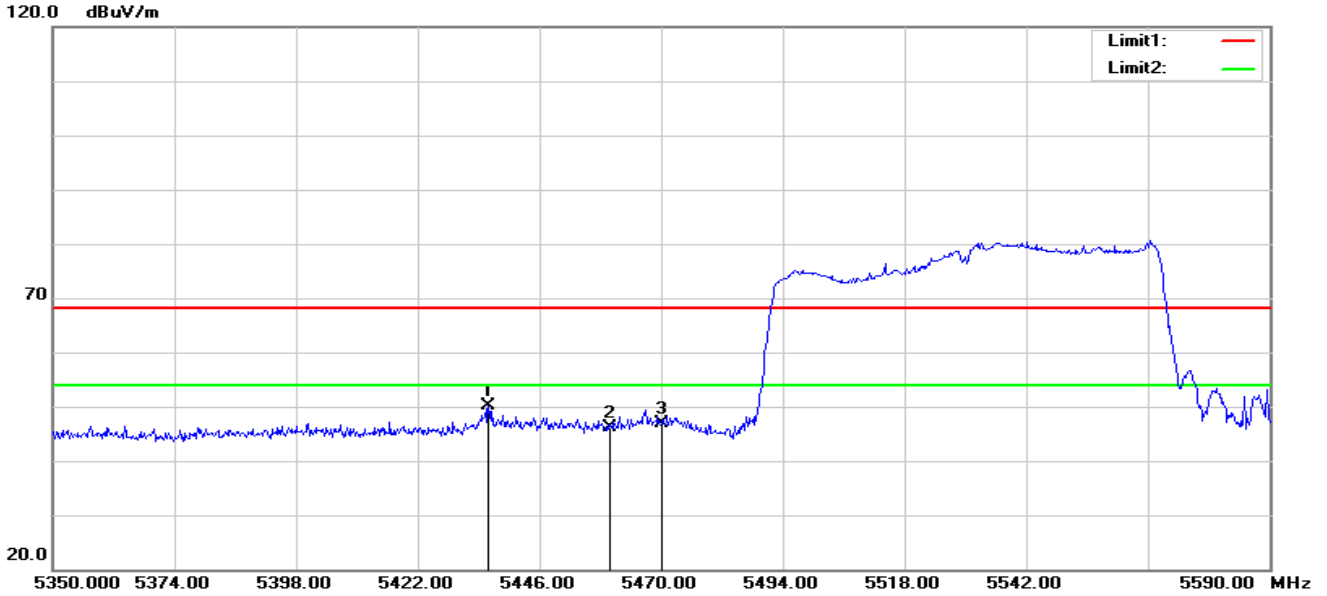

No.	Frequency (MHz)	Reading (dBuV)	Correct Factor(dB/m)	Result (dBuV/m)	Limit (dBuV/m)	Margin (dB)	Remark
1	5435.920	55.35	-5.17	50.18	68.20	-18.02	peak
2	5460.000	51.33	-5.11	46.22	68.20	-21.98	peak
3	5470.000	51.96	-5.09	46.87	68.20	-21.33	peak

802.11ac80-L-V

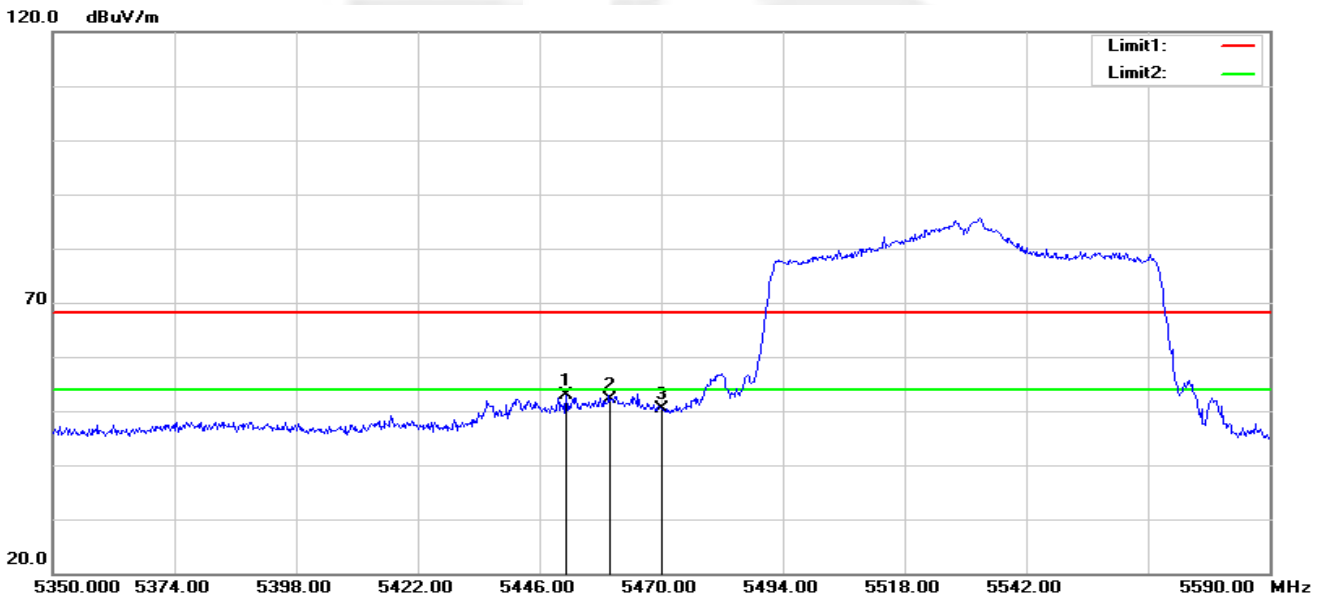

No.	Frequency (MHz)	Reading (dBuV)	Correct Factor(dB/m)	Result (dBuV/m)	Limit (dBuV/m)	Margin (dB)	Remark
1	5451.280	57.97	-5.13	52.84	68.20	-15.36	peak
2	5460.000	57.23	-5.11	52.12	68.20	-16.08	peak
3	5470.000	55.45	-5.09	50.36	68.20	-17.84	peak



802.11ac80-H-H

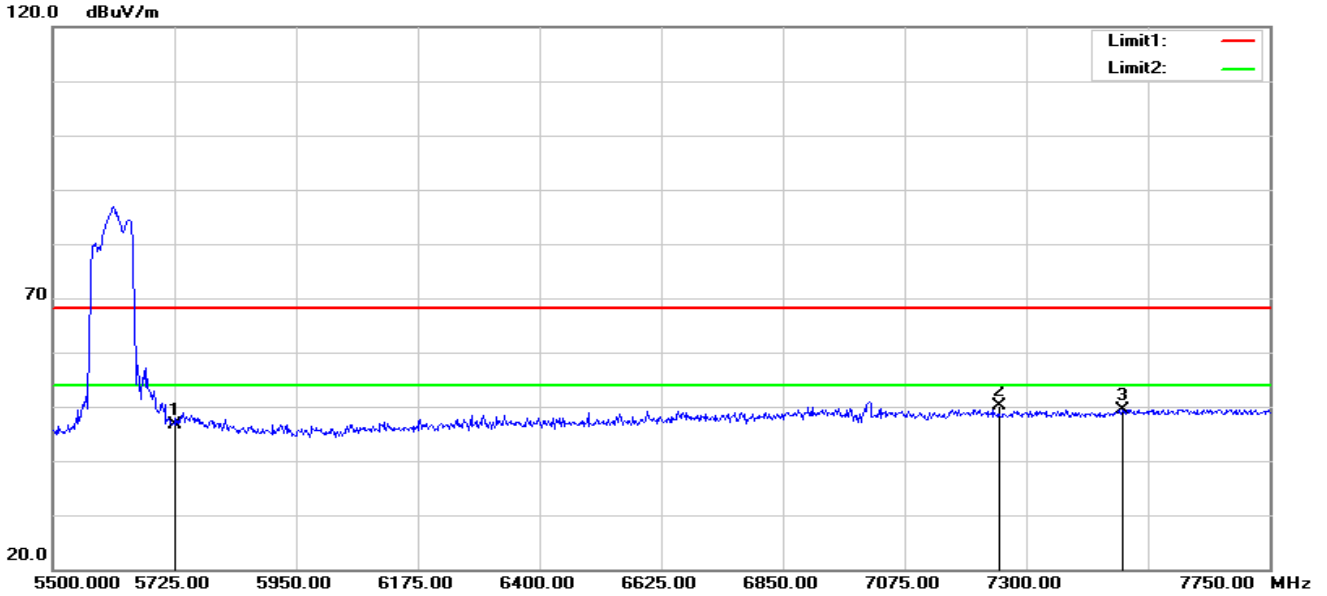

No.	Frequency (MHz)	Reading (dBuV)	Correct Factor(dB/m)	Result (dBuV/m)	Limit (dBuV/m)	Margin (dB)	Remark
1	5725.000	51.27	-4.57	46.70	68.20	-21.50	peak
2	7250.000	49.47	0.72	50.19	68.20	-18.01	peak
3	7477.750	47.95	1.55	49.50	68.20	-18.70	peak

802.11ac80-H-V

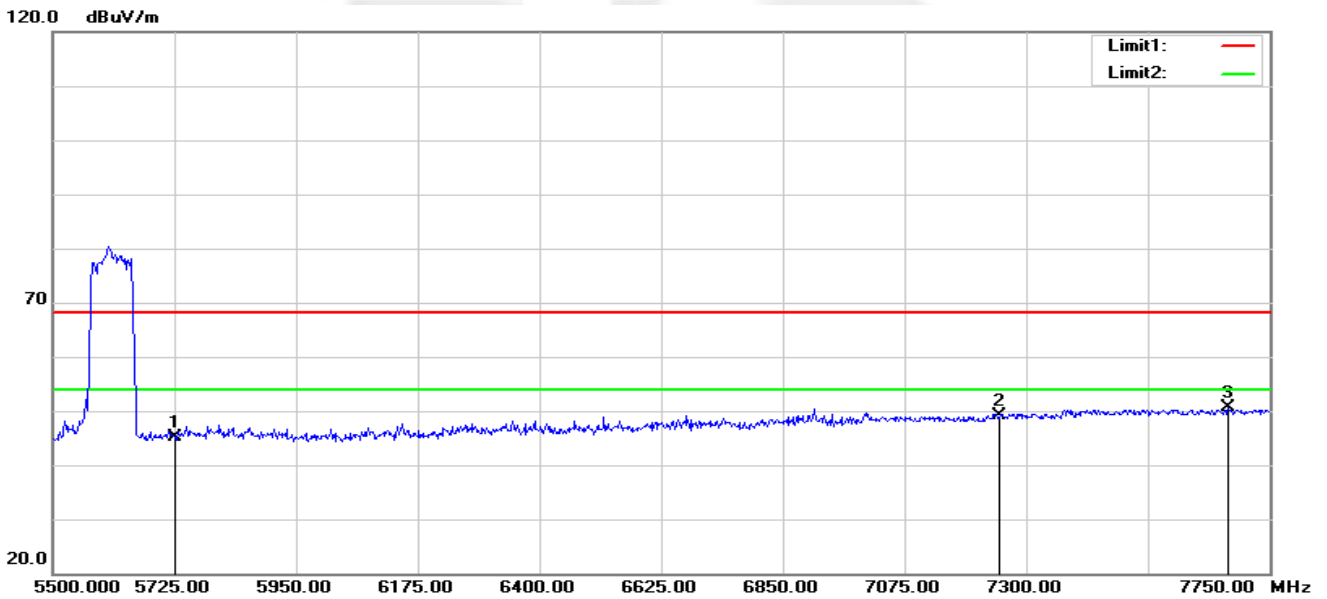

No.	Frequency (MHz)	Reading (dBuV)	Correct Factor(dB/m)	Result (dBuV/m)	Limit (dBuV/m)	Margin (dB)	Remark
1	5725.000	49.65	-4.57	45.08	68.20	-23.12	peak
2	7250.000	48.50	0.72	49.22	68.20	-18.98	peak
3	7673.500	48.76	1.82	50.58	68.20	-17.62	peak

Note: All modes have been tested. Only the worst mode shown in the report.



Band IV(5.725-5.85 GHz)

802.11ac20-L-H

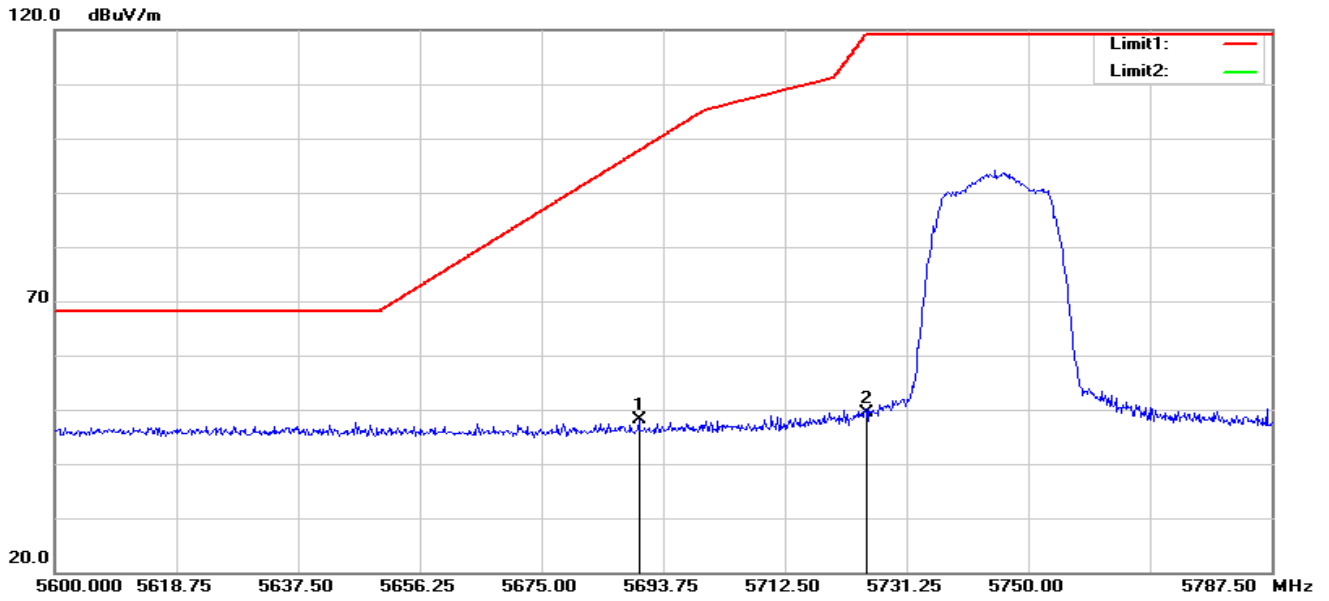

No.	Frequency (MHz)	Reading (dBuV)	Correct Factor(dB/m)	Result (dBuV/m)	Limit (dBuV/m)	Margin (dB)	Remark
1	5690.000	52.78	-4.67	48.11	97.80	-49.69	peak
2	5725.000	53.90	-4.57	49.33	119.20	-69.87	peak

802.11ac20-L-V

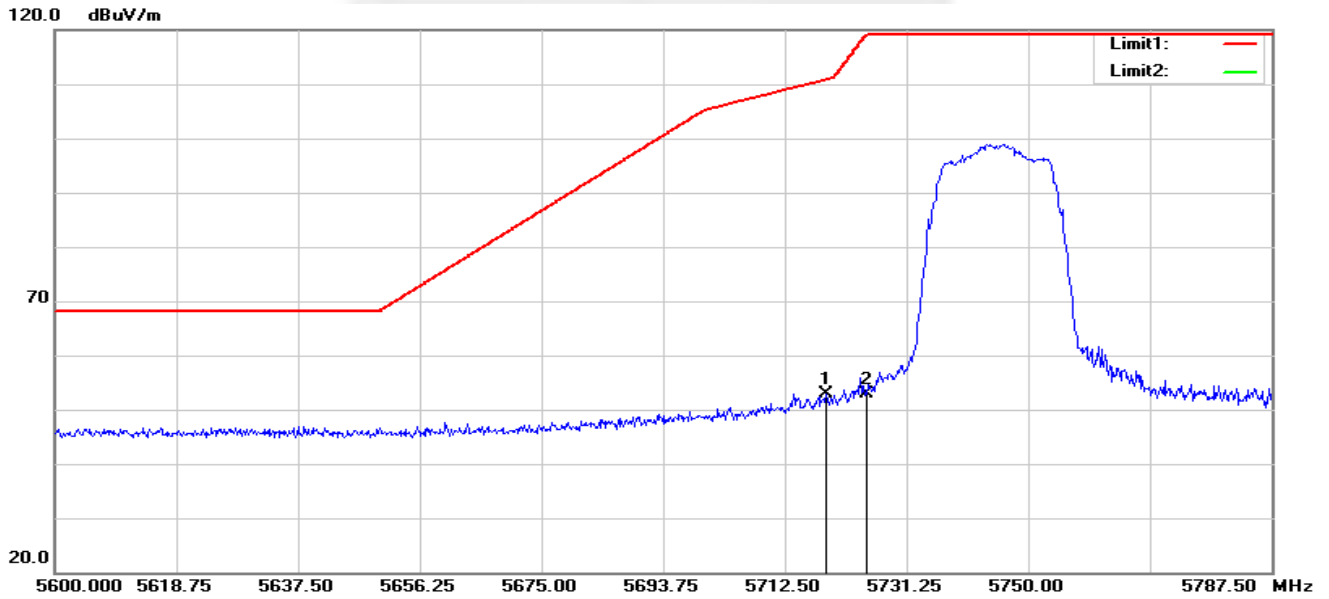

No.	Frequency (MHz)	Reading (dBuV)	Correct Factor(dB/m)	Result (dBuV/m)	Limit (dBuV/m)	Margin (dB)	Remark
1	5718.875	57.43	-4.60	52.83	110.86	-58.03	peak
2	5725.000	57.57	-4.57	53.00	119.20	-66.20	peak



802.11ac20-H-H

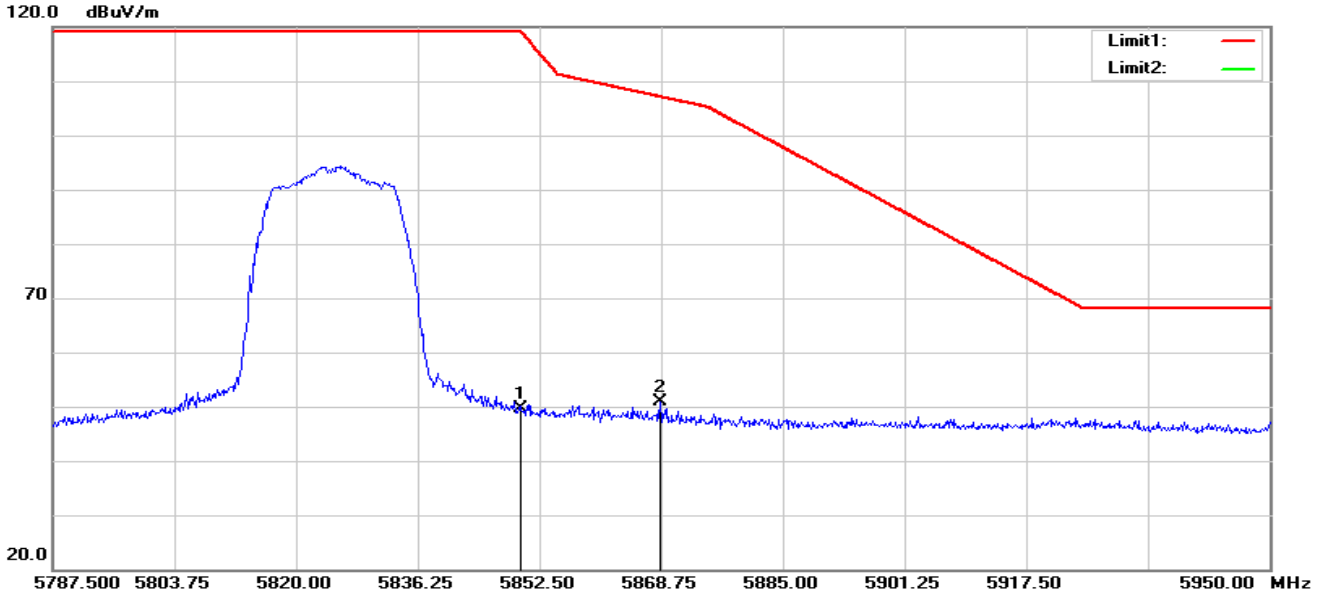

No.	Frequency (MHz)	Reading (dBuV)	Correct Factor(dB/m)	Result (dBuV/m)	Limit (dBuV/m)	Margin (dB)	Remark
1	5850.000	53.69	-4.10	49.59	119.20	-69.61	peak
2	5868.587	54.85	-4.02	50.83	107.12	-56.29	peak

802.11ac20-H-V

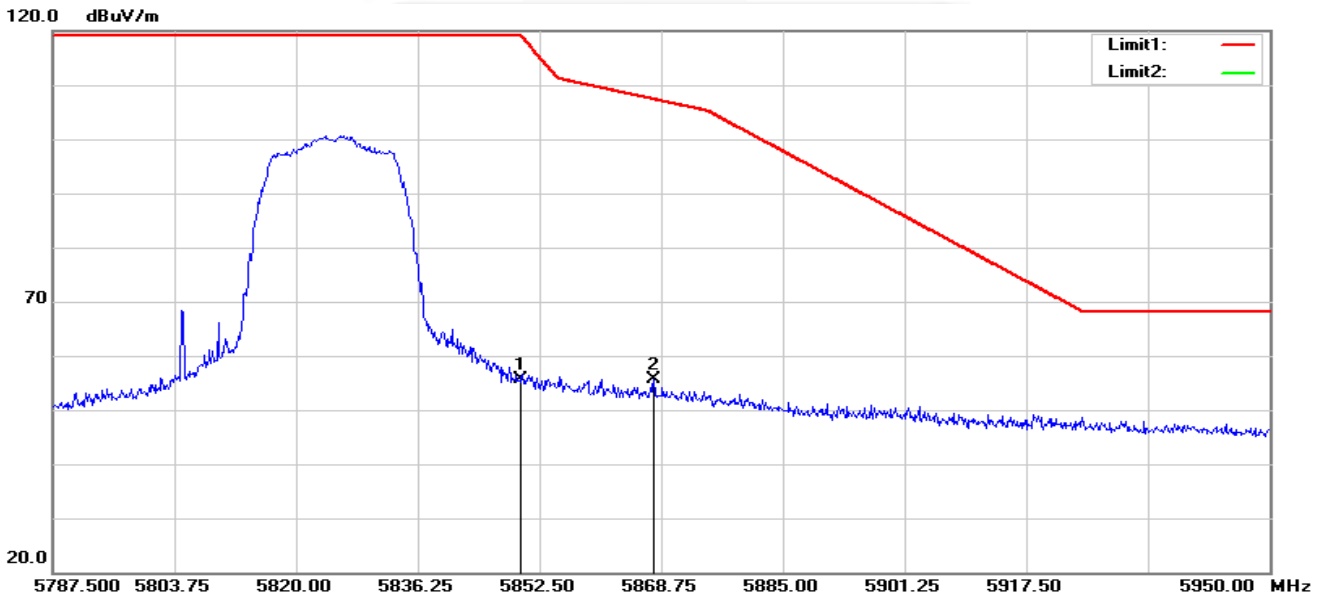

No.	Frequency (MHz)	Reading (dBuV)	Correct Factor(dB/m)	Result (dBuV/m)	Limit (dBuV/m)	Margin (dB)	Remark
1	5850.000	59.67	-4.10	55.57	119.20	-63.63	peak
2	5867.775	59.55	-4.02	55.53	107.37	-51.84	peak



802.11ac40-L-H

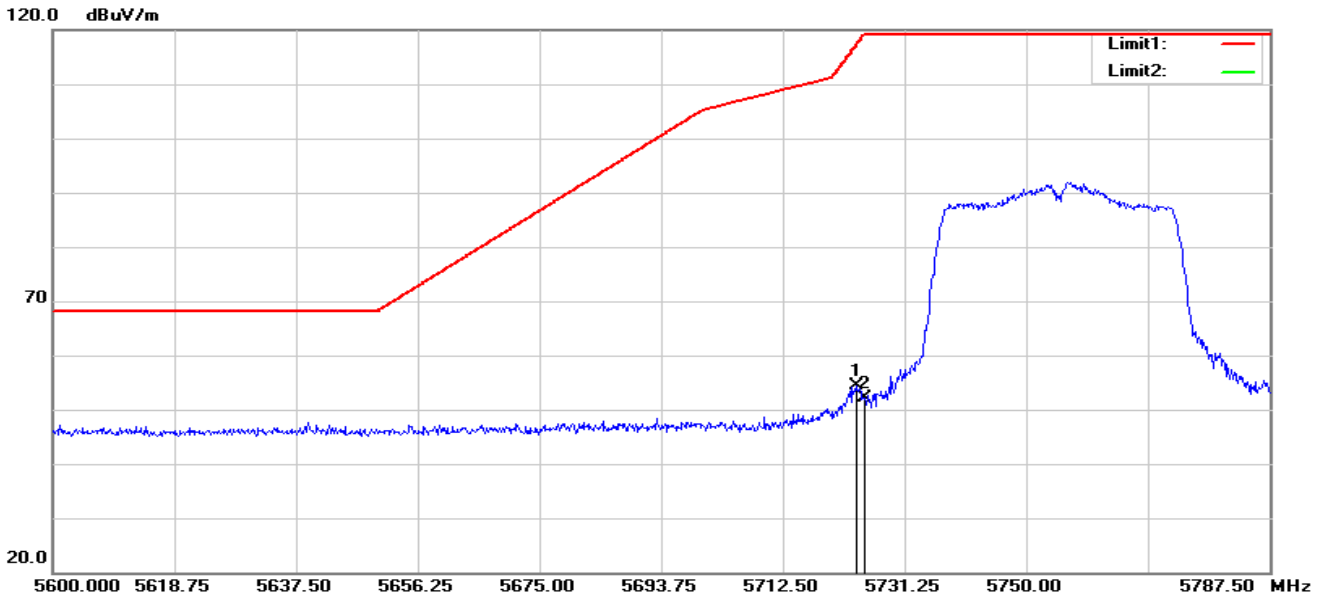

No.	Frequency (MHz)	Reading (dBuV)	Correct Factor(dB/m)	Result (dBuV/m)	Limit (dBuV/m)	Margin (dB)	Remark
1	5723.750	58.88	-4.58	54.30	117.20	-62.90	peak
2	5725.000	56.61	-4.57	52.04	119.20	-67.16	peak

802.11ac40-L-V

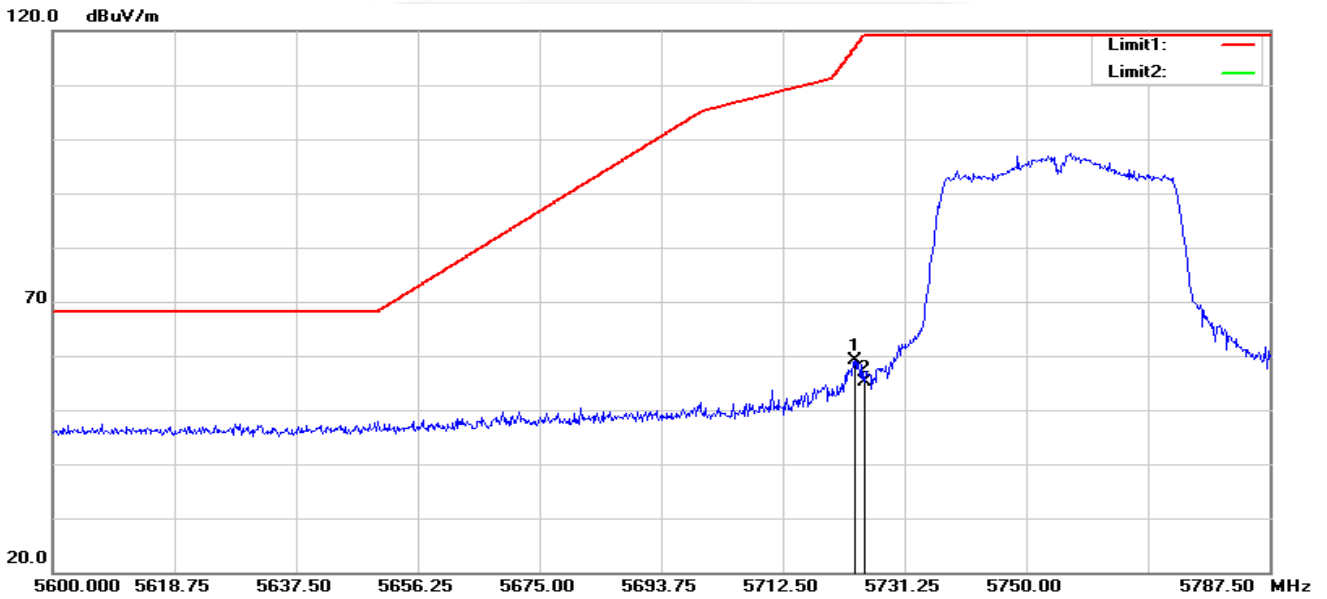

No.	Frequency (MHz)	Reading (dBuV)	Correct Factor(dB/m)	Result (dBuV/m)	Limit (dBuV/m)	Margin (dB)	Remark
1	5723.563	63.60	-4.58	59.02	116.90	-57.88	peak
2	5725.000	59.75	-4.57	55.18	119.20	-64.02	peak



802.11ac40-H-H

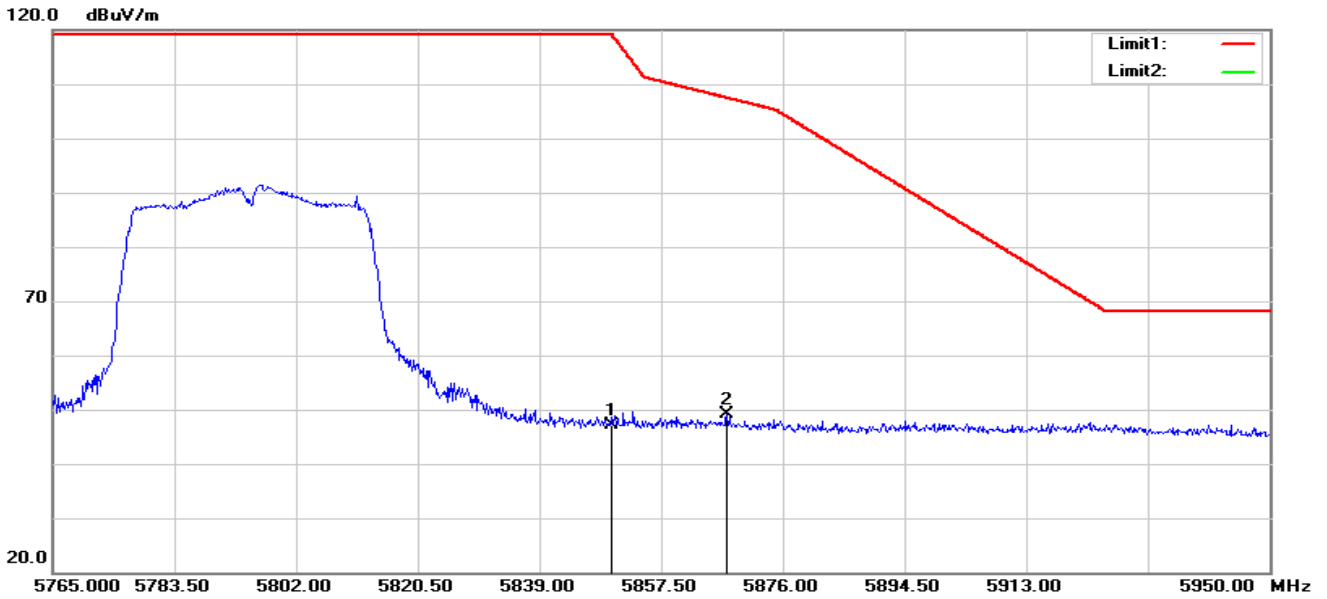

No.	Frequency (MHz)	Reading (dBuV)	Correct Factor(dB/m)	Result (dBuV/m)	Limit (dBuV/m)	Margin (dB)	Remark
1	5850.000	51.28	-4.10	47.18	119.20	-72.02	peak
2	5867.490	53.27	-4.02	49.25	107.45	-58.20	peak

802.11ac40-H-V

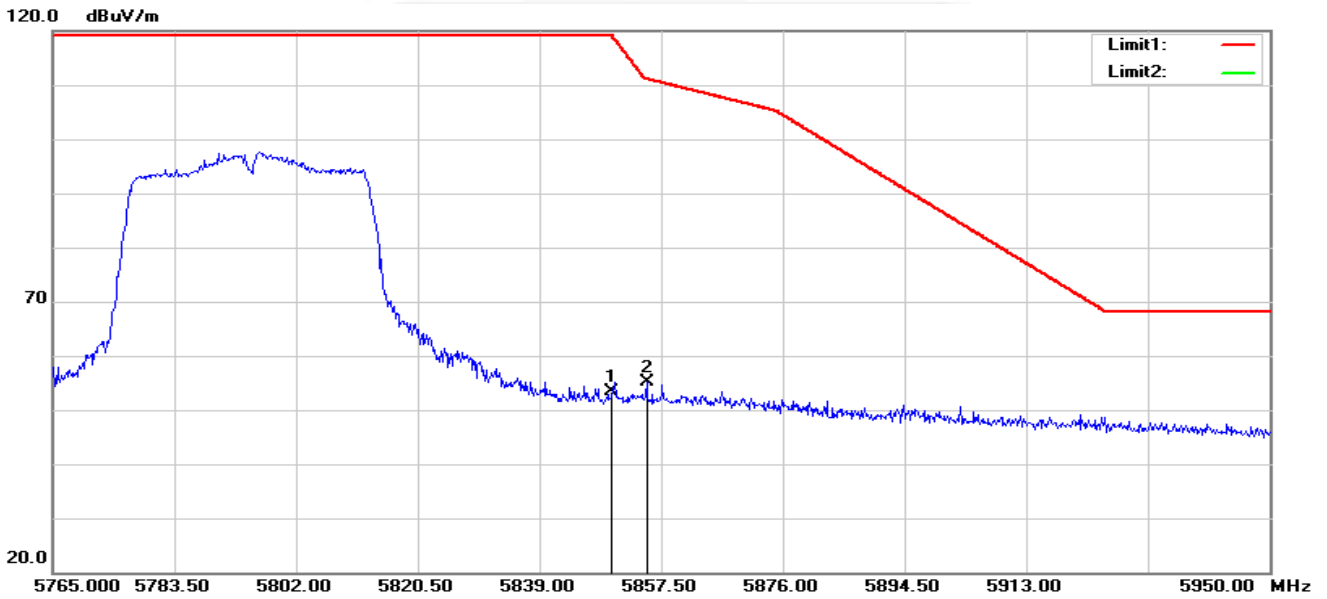

No.	Frequency (MHz)	Reading (dBuV)	Correct Factor(dB/m)	Result (dBuV/m)	Limit (dBuV/m)	Margin (dB)	Remark
1	5850.000	57.55	-4.10	53.45	119.20	-65.75	peak
2	5855.280	59.09	-4.08	55.01	111.12	-56.11	peak



802.11ac80-H

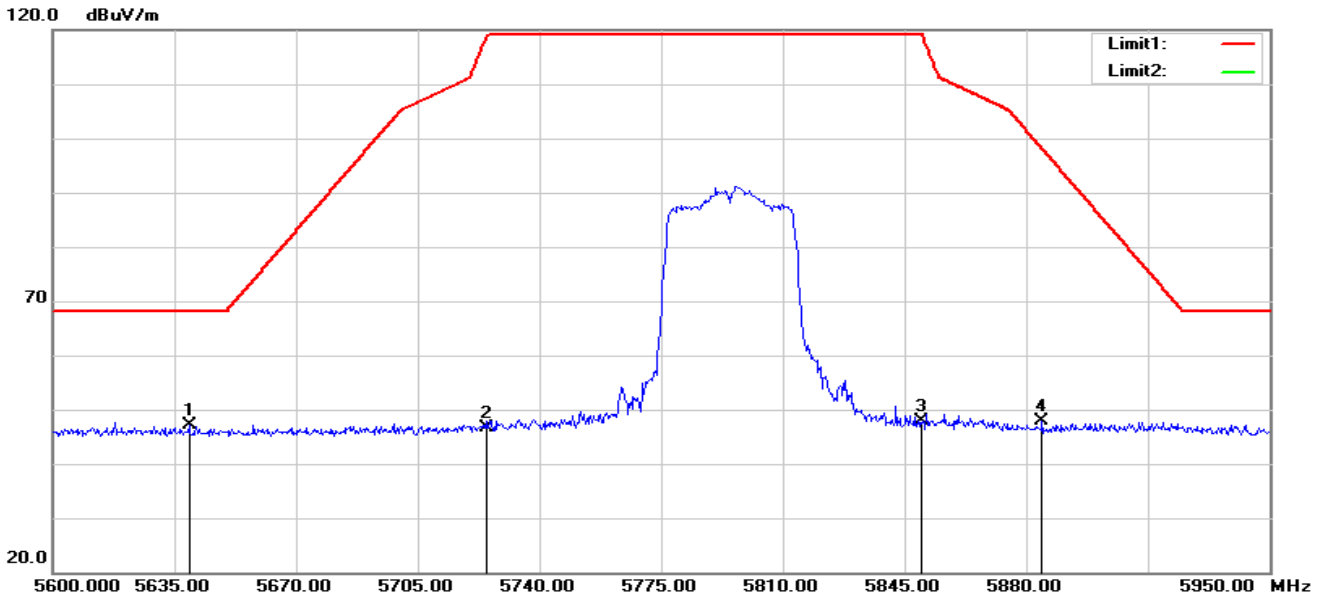

No.	Frequency (MHz)	Reading (dBuV)	Correct Factor(dB/m)	Result (dBuV/m)	Limit (dBuV/m)	Margin (dB)	Remark
1	5639.200	51.92	-4.69	47.23	68.20	-20.97	peak
2	5725.000	51.28	-4.57	46.71	119.20	-72.49	peak
3	5850.000	51.97	-4.10	47.87	119.20	-71.33	peak
4	5884.550	51.89	-3.94	47.95	98.13	-50.18	peak

802.11ac80-V

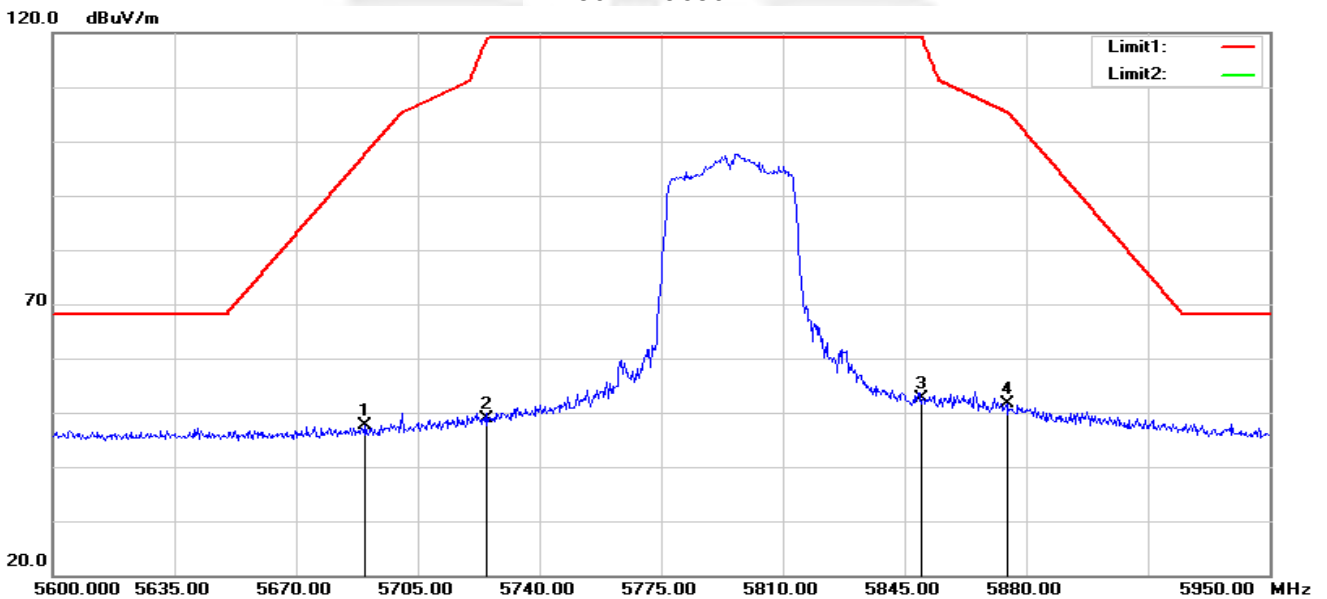

No.	Frequency (MHz)	Reading (dBuV)	Correct Factor(dB/m)	Result (dBuV/m)	Limit (dBuV/m)	Margin (dB)	Remark
1	5689.950	52.28	-4.67	47.61	97.76	-50.15	peak
2	5725.000	53.44	-4.57	48.87	119.20	-70.33	peak
3	5850.000	56.84	-4.10	52.74	119.20	-66.46	peak
4	5874.400	55.72	-3.99	51.73	105.38	-53.65	peak

Note: All modes have been tested. Only the worst mode shown in the report.



4. POWER SPECTRAL DENSITY TEST

4.1 LIMIT

1. For mobile and portable client devices in the 5.15-5.25 GHz band, the maximum power spectral density shall not exceed 11 dBm in any 1 megahertz band. If transmitting antennas of directional gain greater than 6 dBi are used, both the maximum conducted output power and the maximum power spectral density shall be reduced by the amount in dB that the directional gain of the antenna exceeds 6 dBi.
2. For the 5.25-5.35 GHz and 5.47-5.725 GHz bands, the maximum power spectral density shall not exceed 11 dBm in any 1 megahertz band. If transmitting antennas of directional gain greater than 6 dBi are used, both the maximum conducted output power and the maximum power spectral density shall be reduced by the amount in dB that the directional gain of the antenna exceeds 6 dBi.
3. For the band 5.725-5.850 GHz, the peak power spectral density shall not exceed 30 dBm in any 500KHz band. If transmitting antenna directional gain is greater than 6 dBi, both the maximum conducted output power and the peak power spectral density shall be reduced by the amount in dB that the directional gain of the antenna exceeds 6 dBi.

4.2 TEST PROCEDURE

1. The setting follows Method SA-1 of FCC KDB 789033 D02 General U-NII Test Procedures New Rules v02r01.

For devices operating in the band, the rules specify a measurement bandwidth of 500 kHz.

Many spectrum analyzers do not have 500 kHz RBW, thus a narrower RBW may need to be used.

The rules permit the use of a RBWs less than 1 MHz, or 500 kHz, "provided that the measured power is integrated over the full reference bandwidth" to show the total power over the specified measurement bandwidth (*i.e.*, 1 MHz, or 500 kHz). If measurements are performed using a reduced resolution bandwidth (< 1 MHz, or < 500 kHz) and integrated over 1 MHz, or 500 KHz bandwidth, the following adjustments to the procedures apply:

- a) Set $RBW \geq 1/T$, where T is defined in section II.B.1.a).
- b) Set $VBW \geq 3 RBW$.
- c) If measurement bandwidth of Maximum PSD is specified in 500 kHz, add $10 \log (500\text{kHz}/RBW)$ to the measured result, whereas $RBW (< 500 \text{ kHz})$ is the reduced resolution bandwidth of the spectrum analyzer set during measurement.
- d) If measurement bandwidth of Maximum PSD is specified in 1 MHz, add $10 \log (1\text{MHz}/RBW)$ to the measured result, whereas $RBW (< 1 \text{ MHz})$ is the reduced resolution bandwidth of spectrum analyzer set during measurement.
- e) Care must be taken to ensure that the measurements are performed during a period of continuous transmission or are corrected upward for duty cycle.

Note: As a practical matter, it is recommended to use reduced RBW of 100 kHz for the sections 5.c) and 5.d) above, since $RBW=100 \text{ KHZ}$ is available on nearly all spectrum analyzers.

4.3 DEVIATION FROM STANDARD

No deviation.

4.4 TEST SETUP



4.5 EUT OPERATION CONDITIONS

The EUT tested system was configured as the statements of 2.1 Unless otherwise a special operating condition is specified in the follows during the testing.

4.6 TEST RESULTS

5150-5250MHz								
Frequency	Direct measurement Ant_A Power Density (dBm)	Direct measurement Ant_B Power Density (dBm)	Duty cycle factor	Final Ant_A Power Density (dBm)	Final Ant_B Power Density (dBm)	Power Density Total (dBm)	Limit (dBm)	Result
802.11a								
5180	-2.215	-4.151	0.049	-2.166	-4.102	--	11	PASS
5200	-2.463	-4.200	0.049	-2.414	-4.151	--	11	PASS
5240	-2.877	-4.516	0.049	-2.828	-4.467	--	11	PASS
802.11n20								
5180	-5.478	-7.995	0.078	-5.400	-7.601	-3.352	8.27	PASS
5200	-5.553	-7.837	0.078	-5.475	-7.541	-3.376	8.27	PASS
5240	-5.832	-7.990	0.078	-5.754	-7.618	-3.576	8.27	PASS
802.11n40								
5190	-9.437	-11.449	0.174	-9.263	-11.275	-7.143	8.27	PASS
5230	-9.661	-11.773	0.174	-9.487	-11.599	-7.405	8.27	PASS
802.11ac20								
5180	-5.555	-7.679	0.104	-5.451	-7.575	-3.374	8.27	PASS
5200	-5.530	-7.619	0.104	-5.426	-7.515	-3.336	8.27	PASS
5240	-5.532	-7.696	0.104	-5.428	-7.592	-3.367	8.27	PASS
802.11ac40								
5190	-9.281	-11.228	0.172	-9.109	-11.056	-6.964	8.27	PASS
5230	-9.516	-11.426	0.172	-9.344	-11.254	-7.185	8.27	PASS
802.11ac80								
5210	-11.677	-14.115	0.423	-11.254	-13.692	-9.293	8.27	PASS



5250-5350MHz								
Frequency	Direct measurement Ant_A Power Density (dBm)	Direct measurement Ant_B Power Density (dBm)	Duty cycle factor	Final Ant_A Power Density (dBm)	Final Ant_B Power Density (dBm)	Power Density Total (dBm)	Limit (dBm)	Result
802.11a								
5260	-4.455	-5.987	0.092	-4.363	-5.895	--	11	PASS
5300	-4.145	-5.598	0.092	-4.053	-5.506	--	11	PASS
5320	-3.887	-5.620	0.092	-3.795	-5.528	--	11	PASS
802.11n20								
5260	-5.817	-7.919	0.061	-5.756	-7.858	-3.671	7.91	PASS
5300	-6.084	-7.767	0.061	-6.023	-7.706	-3.773	7.91	PASS
5320	-5.996	-5.564	0.061	-5.935	-5.503	-2.703	7.91	PASS
802.11n40								
5270	-9.798	-11.876	0.174	-9.624	-11.702	-7.529	7.91	PASS
5310	-9.648	-12.098	0.174	-9.474	-11.924	-7.518	7.91	PASS
802.11ac20								
5260	-5.927	-7.995	0.081	-5.846	-7.914	-3.748	7.91	PASS
5300	-6.011	-8.159	0.081	-5.930	-8.078	-3.862	7.91	PASS
5320	-5.847	-8.123	0.081	-5.766	-8.042	-3.746	7.91	PASS
802.11ac40								
5270	-9.774	-11.902	0.213	-9.561	-11.689	-7.486	7.91	PASS
5310	-10.417	-12.463	0.213	-10.204	-12.250	-8.097	7.91	PASS
802.11ac80								
5290	-12.172	-13.935	0.371	-11.801	-13.564	-9.583	7.91	PASS



5470-5725MHz								
Frequency	Direct measurement Ant_A Power Density (dBm)	Direct measurement Ant_B Power Density (dBm)	Duty cycle factor	Final Ant_A Power Density (dBm)	Final Ant_B Power Density (dBm)	Power Density Total (dBm)	Limit (dBm)	Result
802.11a								
5500	-1.568	-2.905	0.091	-1.477	-2.814	--	11	PASS
5580	-1.623	-2.549	0.091	-1.532	-2.458	--	11	PASS
5700	-1.045	-2.937	0.091	-0.954	-2.846	--	11	PASS
802.11n20								
5500	-2.087	-3.092	0.081	-2.006	-3.011	0.531	7.56	PASS
5580	-6.703	-3.271	0.081	-6.622	-3.190	-1.565	7.56	PASS
5700	-1.737	-3.040	0.081	-1.656	-2.959	0.752	7.56	PASS
802.11n40								
5510	-5.086	-5.563	0.174	-4.912	-5.389	-2.134	7.56	PASS
5550	-4.291	-6.023	0.174	-4.117	-5.849	-1.887	7.56	PASS
5670	-5.019	-6.248	0.174	-4.845	-6.074	-2.406	7.56	PASS
802.11ac20								
5500	-1.924	-3.201	0.081	-1.843	-3.120	0.575	7.56	PASS
5580	-1.534	-3.610	0.081	-1.453	-3.529	0.642	7.56	PASS
5700	-1.438	-3.209	0.081	-1.357	-3.128	0.857	7.56	PASS
802.11ac40								
5510	-5.267	-5.952	0.193	-5.074	-5.759	-2.393	7.56	PASS
5550	-4.485	-5.979	0.193	-4.292	-5.786	-1.965	7.56	PASS
5670	-5.012	-6.385	0.193	-4.819	-6.192	-2.441	7.56	PASS
802.11ac80								
5530	-7.169	-8.775	0.404	-6.765	-8.371	-4.484	7.56	PASS
5610	-7.942	-9.099	0.404	-7.538	-8.695	-5.067	7.56	PASS



5725-5850MHz										
Frequency	Use RBW 510KHz direct measurement Ant_A Power Density (dBm)	Use RBW 510KHz direct measurement Ant_B Power Density (dBm)	Convert to RBW 500KHz direct measurement Ant_A Power Density (dBm)	Convert to RBW 500KHz direct measurement Ant_B Power Density (dBm)	Duty cycle factor (dB)	Final Ant_A Power Density (dBm)	Final Ant_B Power Density (dBm)	Power Density Total (dBm)	Limit (dBm)	Result
802.11a										
5745	-9.846	-13.241	-9.932	-13.327	0.076	-9.856	-13.251	--	30	PASS
5785	-10.491	-14.271	-10.577	-14.357	0.076	-10.501	-14.281	--	30	PASS
5825	-10.329	-13.601	-10.415	-13.687	0.076	-10.339	-13.611	--	30	PASS
802.11n20										
5745	-9.773	-13.496	-9.859	-13.582	0.065	-9.794	-13.517	-8.258	26.59	PASS
5785	-10.367	-14.441	-10.453	-14.527	0.065	-10.388	-14.462	-8.954	26.59	PASS
5825	-10.488	-13.806	-10.574	-13.892	0.065	-10.509	-13.827	-8.848	26.59	PASS
802.11n40										
5755	-13.463	-17.035	-13.549	-17.121	0.193	-13.356	-16.928	-11.774	26.59	PASS
5795	-14.127	-17.349	-14.213	-17.435	0.193	-14.020	-17.242	-12.328	26.59	PASS
802.11ac20										
5745	-10.023	-13.334	-10.109	-13.420	0.081	-10.028	-13.339	-8.365	26.59	PASS
5785	-10.178	-13.969	-10.264	-14.055	0.081	-10.183	-13.974	-8.667	26.59	PASS
5825	-10.907	-14.178	-10.993	-14.264	0.081	-10.912	-14.183	-9.236	26.59	PASS
802.11ac40										
5755	-13.315	-16.926	-13.401	-17.012	0.213	-13.188	-16.799	-11.618	26.59	PASS
5795	-13.713	-16.786	-13.799	-16.872	0.213	-13.586	-16.659	-11.846	26.59	PASS
802.11ac80										
5775	-14.736	-18.094	-14.822	-18.180	0.374	-14.448	-17.806	-12.800	26.59	PASS

Note: 1. RB conversion formula: $10 \cdot \text{LOG}(500\text{KHz}/\text{RBW})$
 2. Test plots see Attachment A.
 3. Band 1 MIMO antenna gain is 8.73dBi, Band 2 MIMO antenna gain is 9.09dBi, Band 3 MIMO antenna gain is 9.44dBi, Band 4 MIMO antenna gain is 9.41dBi, both are greater than 6dBi, the Band 1 MIMO mode limit will be reduced by 2.73dBi, the Band 2 MIMO mode limit will be reduced by 3.09dBi, the Band 3 MIMO mode limit will be reduced by 3.44dBi, the Band 4 MIMO mode limit will be reduced by 3.41dBi.

5. BANDWIDTH MEASUREMENT

5.1 EMISSION BANDWIDTH (EBW) 26 BANDWID PROCEDURES / LIMIT

The following procedure shall be used for measuring 26 bandwidth.

5.1.1 TEST PROCEDURE

1. The testing follows FCC KDB 789033 D02 General UNII Test Procedures New Rules v02r01.
2. Set RBW = approximately 1% of the emission bandwidth.
3. Set the VBW \geq RBW.
4. Detector = Peak.
5. Trace mode = max hold.
6. Measure the maximum width of the emission that is 26 dB down from the peak of the emission. Compare this with the RBW setting of the analyzer. Readjust RBW and repeat measurement as needed until the RBW/EBW ratio is approximately 1%.

5.1.2 DEVIATION FROM STANDARD

No deviation.

5.1.3 TEST SETUP



5.1.4 EUT OPERATION CONDITIONS

The EUT tested system was configured as the statements of 2.4 Unless otherwise a special operating condition is specified in the follows during the testing.

**5.1.5 TEST RESULTS**

Frequency (MHz)	26dB Bandwidth (MHz)	Pass/Fail
802.11a		
5180	20.84	Pass
5200	20.78	Pass
5240	20.99	Pass
802.11n(HT20)		
5180	21.20	Pass
5200	21.12	Pass
5240	21.18	Pass
802.11n(HT40)		
5190	39.44	Pass
5230	39.48	Pass
802.11ac(VHT20)		
5180	20.92	Pass
5200	21.10	Pass
5240	21.32	Pass
802.11ac(VHT40)		
5190	39.49	Pass
5230	39.20	Pass
802.11ac(VHT80)		
5210	80.43	Pass

Frequency (MHz)	26dB Bandwidth (MHz)	Pass/Fail
802.11a		
5260	20.82	Pass
5300	20.90	Pass
5320	20.82	Pass
802.11n(HT20)		
5260	21.24	Pass
5300	21.26	Pass
5320	21.42	Pass
802.11n(HT40)		
5270	39.75	Pass
5310	39.21	Pass
802.11ac(VHT20)		
5260	21.08	Pass
5300	21.25	Pass
5320	21.21	Pass
802.11ac(VHT40)		
5270	39.50	Pass
5310	39.71	Pass
802.11ac(VHT80)		
5290	80.94	Pass



Frequency (MHz)	26dB Bandwidth (MHz)	Pass/Fail
802.11a		
5500	20.82	Pass
5580	20.66	Pass
5700	20.78	Pass
802.11n(HT20)		
5500	21.32	Pass
5580	21.20	Pass
5700	21.22	Pass
802.11n(HT40)		
5510	39.67	Pass
5550	39.26	Pass
5670	39.37	Pass
802.11ac(VHT20)		
5500	21.25	Pass
5580	20.85	Pass
5700	21.06	Pass
802.11ac(VHT40)		
5510	39.36	Pass
5550	39.32	Pass
5670	39.45	Pass
802.11ac(VHT80)		
5530	80.85	Pass
5610	80.04	Pass

Frequency (MHz)	26dB Bandwidth (MHz)	Pass/Fail
802.11a		
5745	20.82	Pass
5785	20.83	Pass
5825	20.72	Pass
802.11n(HT20)		
5745	21.08	Pass
5785	21.15	Pass
5825	21.03	Pass
802.11n(HT40)		
5755	39.40	Pass
5795	39.40	Pass
802.11ac(VHT20)		
5745	21.34	Pass
5785	21.21	Pass
5825	21.29	Pass
802.11ac(VHT40)		
5755	39.31	Pass
5795	39.62	Pass
802.11ac(VHT80)		
5775	80.29	Pass

Note: 1. Test plot see Attachment B

2. Antenna A Power > Antenna B Power, Both antenna A and B have been test, Only show the worst data of Antenna A.

5.2 OCCUPIED BANDWIDTH (99%) TEST APPLIED PROCEDURES / LIMIT

The following procedure shall be used for measuring (99 %) power bandwidth.

5.2.1 TEST PROCEDURE

1. The testing follows FCC KDB 789033 D02 General UNII Test Procedures v02r01.

The following procedure shall be used for measuring (99 %) power bandwidth:

1. Set center frequency to the nominal EUT channel center frequency.
2. Set span = 1.5 times to 5.0 times the OBW.
3. Set RBW = 1 % to 5 % of the OBW
4. Set VBW $\geq 3 \cdot$ RBW
5. Video averaging is not permitted. Where practical, a sample detection and single sweep mode shall be used. Otherwise, peak detection and max hold mode (until the trace stabilizes) shall be used.
6. Use the 99 % power bandwidth function of the instrument (if available).
7. If the instrument does not have a 99 % power bandwidth function, the trace data points are recovered and directly summed in power units. The recovered amplitude data points, beginning at the lowest frequency, are placed in a running sum until 0.5 % of the total is reached; that frequency is recorded as the lower frequency. The process is repeated until 99.5 % of the total is reached; that frequency is recorded as the upper frequency. The 99% occupied bandwidth is the difference between these two frequencies.

5.2.2 DEVIATION FROM STANDARD

No deviation.

5.2.3 TEST SETUP



5.2.4 EUT OPERATION CONDITIONS

The EUT tested system was configured as the statements of 2.4 Unless otherwise a special operating condition is specified in the follows during the testing.

**5.2.5 TEST RESULTS**

Frequency (MHz)	99% Bandwidth (MHz)	Pass/Fail
802.11a		
5180	16.51	Pass
5200	16.50	Pass
5240	16.51	Pass
802.11n(HT20)		
5180	17.68	Pass
5200	17.66	Pass
5240	17.66	Pass
802.11n(HT40)		
5190	36.12	Pass
5230	36.12	Pass
802.11ac(VHT20)		
5180	17.67	Pass
5200	17.67	Pass
5240	17.67	Pass
802.11ac(VHT40)		
5190	36.11	Pass
5230	36.14	Pass
802.11ac(VHT80)		
5210	75.43	Pass

Frequency (MHz)	99% Bandwidth (MHz)	Pass/Fail
802.11a		
5260	16.52	Pass
5300	16.50	Pass
5320	16.53	Pass
802.11n(HT20)		
5260	17.69	Pass
5300	17.68	Pass
5320	17.65	Pass
802.11n(HT40)		
5270	36.11	Pass
5310	36.10	Pass
802.11ac(VHT20)		
5260	17.68	Pass
5300	17.66	Pass
5320	17.67	Pass
802.11ac(VHT40)		
5270	36.14	Pass
5310	36.12	Pass
802.11ac(VHT80)		
5290	75.39	Pass



Frequency (MHz)	99% Bandwidth (MHz)	Pass/Fail
802.11a		
5500	16.50	Pass
5580	16.51	Pass
5700	16.51	Pass
802.11n(HT20)		
5500	17.66	Pass
5580	17.68	Pass
5700	17.68	Pass
802.11n(HT40)		
5510	36.14	Pass
5550	36.10	Pass
5670	36.15	Pass
802.11ac(VHT20)		
5500	17.69	Pass
5580	17.67	Pass
5700	17.67	Pass
802.11ac(VHT40)		
5510	36.13	Pass
5550	36.11	Pass
5670	36.13	Pass
802.11ac(VHT80)		
5530	75.46	Pass
5610	75.42	Pass

Frequency (MHz)	99% Bandwidth (MHz)	Pass/Fail
802.11a		
5745	16.52	Pass
5785	16.50	Pass
5825	16.53	Pass
802.11n(HT20)		
5745	17.68	Pass
5785	17.68	Pass
5825	17.69	Pass
802.11n(HT40)		
5755	36.16	Pass
5795	36.15	Pass
802.11ac(VHT20)		
5745	17.69	Pass
5785	17.67	Pass
5825	17.69	Pass
802.11ac(VHT40)		
5755	36.13	Pass
5795	36.13	Pass
802.11ac(VHT80)		
5775	75.50	Pass

Note: 1. Test plot see Attachment B

2. Antenna A Power > Antenna B Power, Both antenna A and B have been test, Only show the worst data of Antenna A.

5.3 MINIMUM EMISSION BANDWIDTH(6 DB) PROCEDURES / LIMIT

Section 15.407(e) specifies the minimum 6 dB emission bandwidth of at least 500 KHz for the band 5.725-5.85 GHz. The following procedure shall be used for measuring this bandwidth.

5.3.1 TEST PROCEDURE

1. The testing follows FCC KDB 789033 D02 General UNII Test Procedures v02r01.
 - a) Set RBW = 100 kHz.
 - b) Set the video bandwidth (VBW) $\geq 3 \times$ RBW.
 - c) Detector = Peak.
 - d) Trace mode = max hold.
 - e) Sweep = auto couple.
 - f) Allow the trace to stabilize.
 - g) Measure the maximum width of the emission that is constrained by the frequencies associated with the two outermost amplitude points (upper and lower frequencies) that are attenuated by 6 dB relative to the maximum level measured in the fundamental emission.

5.3.2 DEVIATION FROM STANDARD

No deviation.

5.3.3 TEST SETUP



5.3.4 EUT OPERATION CONDITIONS

The EUT tested system was configured as the statements of 2.4 Unless otherwise a special operating condition is specified in the follows during the testing.

**5.3.5 TEST RESULTS**

Frequency (MHz)	6dB Bandwidth (MHz)	Pass/Fail
802.11a		
5745	16.29	Pass
5785	16.29	Pass
5825	16.32	Pass
802.11n(HT20)		
5745	17.26	Pass
5785	17.55	Pass
5825	17.56	Pass
802.11n(HT40)		
5755	36.15	Pass
5795	36.28	Pass
802.11ac(VHT20)		
5745	17.57	Pass
5785	17.27	Pass
5825	17.53	Pass
802.11ac(VHT40)		
5755	36.28	Pass
5795	36.27	Pass
802.11ac(VHT80)		
5775	76.06	Pass

Note: 1. Test plot see Attachment C

2. Antenna A Power > Antenna B Power, Both antenna A and B have been test, Only show the worst data of Antenna A.

6. MAXIMUM CONDUCTED OUTPUT POWER

6.1 LIMIT

For mobile and portable client devices in the 5.15-5.25 GHz band, the maximum conducted output power over the frequency band of operation shall not exceed 250 mW provided the maximum antenna gain does not exceed 6 dBi. If transmitting antennas of directional gain greater than 6 dBi are used, both the maximum conducted output power and the maximum power spectral density shall be reduced by the amount in dB that the directional gain of the antenna exceeds 6 dBi.

For the 5.25-5.35 GHz and 5.47-5.725 GHz bands, the maximum conducted output power over the frequency bands of operation shall not exceed the lesser of 250 mW or 11 dBm + 10 log B, where B is the 26 dB emission bandwidth in megahertz, If transmitting antennas of directional gain greater than 6 dBi are used.

For the band 5.725-5.85 GHz, the maximum conducted output power over the frequency band of operation shall not exceed 1 W. If transmitting antennas of directional gain greater than 6 dBi are used.

FCC Part15 (15.407) , Subpart E				
Section	Test Item	Limit	Frequency Range (MHz)	Result
15.407(a) (1) (iv)	Peak Output Power	0.25 watt	5150-5250	PASS
		The lesser of 250 mW or 11 dBm + 10 log (26 dB emission bandwidth)	5250-5350	
5470-5725				
15.407(a) (3)		1 watt	5725-5825	

6.2 TEST PROCEDURE

The EUT was directly connected to the Power Sensor&PC

6.3 DEVIATION FROM STANDARD

No deviation.

6.4 TEST SETUP

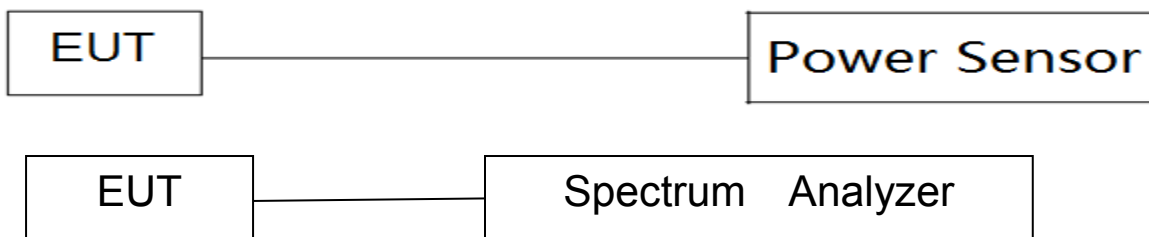

6.5 EUT OPERATION CONDITIONS

The EUT tested system was configured as the statements of 5 Unless otherwise a special operating condition is specified in the follows during the testing.



6.6 TEST RESULTS

Note: Band 1 MIMO antenna gain is 8.73dBi, Band 2 MIMO antenna gain is 9.09dBi, Band 3 MIMO antenna gain is 9.44dBi, Band 4 MIMO antenna gain is 9.41dBi, both are greater than 6dBi, the Band 1 MIMO mode limit will be reduced by 2.73dBi, the Band 2 MIMO mode limit will be reduced by 3.09dBi, the Band 3 MIMO mode limit will be reduced by 3.44dBi, the Band 4 MIMO mode limit will be reduced by 3.41dBi.

Band I (5.15-5.25GHz)								
Test Channel	Frequency (MHz)	Direct measurement Ant_A AV Power (dBm)	Direct measurement Ant_B_AV Power (dBm)	Duty cycle factor (dB)	Final Ant_A AV Power (dBm)	Final Ant_B AV Power (dBm)	AV Power Total (dBm)	LIMIT (dBm)
802.11a								
36	5180	7.23	6.78	0.049	7.28	6.83	--	23.98
40	5200	6.99	6.53	0.049	7.04	6.58	--	23.98
48	5240	6.70	6.29	0.049	6.75	6.34	--	23.98
802.11n(HT20)								
36	5180	4.14	3.87	0.078	4.22	3.95	7.10	21.25
40	5200	4.22	3.96	0.078	4.30	4.04	7.18	21.25
48	5240	4.15	3.76	0.078	4.23	3.84	7.05	21.25
802.11n(HT40)								
38	5190	4.15	3.65	0.174	4.32	3.82	7.09	21.25
46	5230	4.23	3.77	0.174	4.40	3.94	7.19	21.25
802.11ac(VHT20)								
36	5180	4.46	3.89	0.104	4.56	3.99	7.30	21.25
40	5200	4.07	3.65	0.104	4.17	3.75	6.98	21.25
48	5240	3.89	3.23	0.104	3.99	3.33	6.69	21.25
802.11ac(VHT40)								
38	5190	4.25	3.48	0.172	4.42	3.65	7.06	21.25
46	5230	4.28	3.52	0.172	4.45	3.69	7.10	21.25
802.11ac(VHT80)								
42	5210	3.37	1.43	0.423	3.79	1.85	5.94	21.25



Band II(5.25-5.35GHz)								
Test Channel	Frequency (MHz)	Direct measurement Ant_A AV Power (dBm)	Direct measurement Ant B_AV Power (dBm)	Duty cycle factor (dB)	Final Ant_A AV Power (dBm)	Final Ant_B AV Power (dBm)	AV Power Total (dBm)	LIMIT (dBm)
802.11a								
52	5260	5.53	5.23	0.092	5.62	5.32	--	23.98
60	5300	5.26	5.02	0.092	5.35	5.11	--	23.98
64	5320	5.13	4.99	0.092	5.22	5.08	--	23.98
802.11n(HT20)								
52	5260	3.97	3.63	0.061	4.03	3.69	6.87	20.89
60	5300	3.91	3.59	0.061	3.97	3.65	6.82	20.89
64	5320	3.87	3.48	0.061	3.93	3.54	6.75	20.89
802.11n(HT40)								
54	5270	2.09	1.87	0.174	2.26	2.04	5.17	20.89
62	5310	2.41	1.96	0.174	2.58	2.13	5.38	20.89
802.11ac(VHT20)								
52	5260	3.95	3.59	0.081	4.03	3.67	6.87	20.89
60	5300	3.89	3.44	0.081	3.97	3.52	6.76	20.89
64	5320	3.66	3.23	0.081	3.74	3.31	6.54	20.89
802.11ac(VHT40)								
54	5270	2.06	1.78	0.213	2.27	1.99	5.15	20.89
62	5310	3.10	2.09	0.213	3.31	2.30	5.85	20.89
802.11ac(VHT80)								
58	5290	3.05	1.14	0.371	3.42	1.51	5.58	20.89



Band III(5.47-5.725GHz)								
Test Channel	Frequency (MHz)	Direct measurement Ant_A AV Power (dBm)	Direct measurement Ant_B_AV Power (dBm)	Duty cycle factor (dB)	Final Ant_A AV Power (dBm)	Final Ant_B AV Power (dBm)	AV Power Total (dBm)	LIMIT (dBm)
802.11a								
100	5500	8.26	7.39	0.091	8.35	7.48	--	23.98
116	5580	8.07	7.12	0.091	8.16	7.21	--	23.98
140	5700	8.03	6.99	0.091	8.12	7.08	--	23.98
802.11n(HT20)								
100	5500	8.09	7.56	0.081	8.17	7.64	10.92	20.54
116	5580	8.03	7.32	0.081	8.11	7.40	10.78	20.54
140	5700	7.89	6.98	0.081	7.97	7.06	10.55	20.54
802.11n(HT40)								
102	5510	7.89	7.12	0.174	8.06	7.29	10.71	20.54
110	5550	7.79	7.02	0.174	7.96	7.19	10.61	20.54
134	5670	7.63	6.78	0.174	7.80	6.95	10.41	20.54
802.11ac(VHT20)								
100	5500	7.56	6.89	0.081	7.64	6.97	10.33	20.54
116	5580	7.35	6.56	0.081	7.43	6.64	10.06	20.54
140	5700	7.21	6.32	0.081	7.29	6.40	9.88	20.54
802.11ac(VHT40)								
102	5510	7.80	6.98	0.193	7.99	7.17	10.61	20.54
110	5550	7.69	6.87	0.193	7.88	7.06	10.50	20.54
134	5670	7.59	6.64	0.193	7.78	6.83	10.34	20.54
802.11ac(VHT80)								
106	5530	7.54	6.66	0.404	7.94	7.06	10.54	20.54
122	5610	7.41	6.11	0.404	7.81	6.51	10.22	20.54



Band IV (5.725-5.85GHz)								
Test Channel	Frequency (MHz)	Direct measurement Ant_A AV Power (dBm)	Direct measurement Ant_B_AV Power (dBm)	Duty cycle factor (dB)	Final Ant_A AV Power (dBm)	Final Ant_B AV Power (dBm)	AV Power Total (dBm)	LIMIT (dBm)
802.11a								
149	5745	2.30	1.87	0.076	2.38	1.95	--	30.00
157	5785	2.18	1.69	0.076	2.26	1.77	--	30.00
165	5825	2.02	1.57	0.076	2.10	1.65	--	30.00
802.11n(HT20)								
149	5745	1.77	1.02	0.065	1.83	1.08	4.486	26.59
157	5785	2.09	1.28	0.065	2.15	1.34	4.779	26.59
165	5825	2.27	1.38	0.065	2.33	1.44	4.923	26.59
802.11n(HT40)								
151	5755	2.86	2.46	0.193	3.05	2.65	5.868	26.59
159	5795	1.56	1.32	0.193	1.75	1.51	4.645	26.59
802.11ac(VHT20)								
149	5745	3.43	3.08	0.081	3.51	3.16	6.350	26.59
157	5785	3.21	3.11	0.081	3.29	3.19	6.252	26.59
165	5825	3.09	2.78	0.081	3.17	2.86	6.030	26.59
802.11ac(VHT40)								
151	5755	1.81	1.48	0.213	2.02	1.69	4.871	26.59
159	5795	1.66	1.36	0.213	1.87	1.57	4.736	26.59
802.11ac(VHT80)								
155	5775	3.02	-0.12	0.374	3.39	0.25	5.112	26.59



5210MHz_Ant A



5290MHz_Ant A



5530MHz_Ant A



5610MHz_Ant A

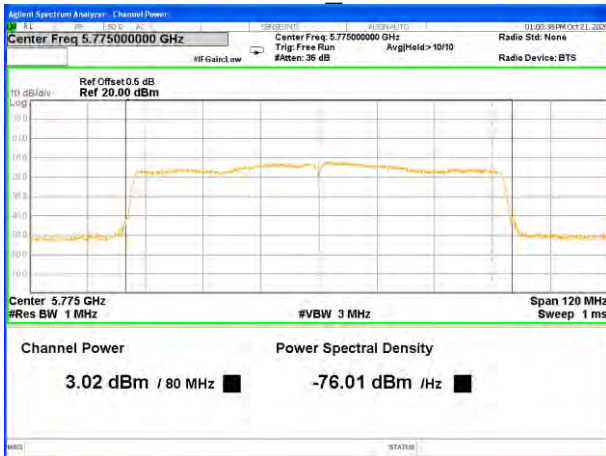

5775MHz_Ant A



5210MHz_Ant B

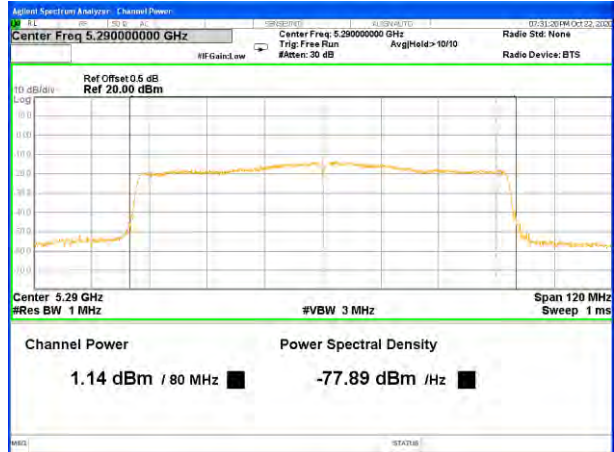

5290MHz_Ant B



5530MHz_Ant B



5610MHz_Ant B



5775MHz_Ant B



Duty cycle

Band1				
Mode	Ton(ms)	Tp(ms)	Duty cycle(%)	Duty factor(dB)
a	1.412	1.428	98.88%	0.049
n20	1.320	1.344	98.21%	0.078
n40	0.660	0.687	96.07%	0.174
ac20	1.324	1.356	97.64%	0.104
ac40	0.669	0.696	96.12%	0.172
ac80	0.332	0.366	90.71%	0.423
Band2				
Mode	Ton(ms)	Tp(ms)	Duty cycle(%)	Duty factor(dB)
a	1.405	1.435	97.91%	0.092
n20	1.415	1.435	98.61%	0.061
n40	0.660	0.687	96.07%	0.174
ac20	1.325	1.350	98.15%	0.081
ac40	0.657	0.690	95.22%	0.213
ac80	0.336	0.366	91.80%	0.371
Band3				
Mode	Ton(ms)	Tp(ms)	Duty cycle(%)	Duty factor(dB)
a	1.410	1.440	97.92%	0.091
n20	1.325	1.350	98.15%	0.081
n40	0.660	0.687	96.07%	0.174
ac20	1.330	1.355	98.15%	0.081
ac40	0.660	0.690	95.65%	0.193
ac80	0.328	0.360	91.11%	0.404
Band4				
Mode	Ton(ms)	Tp(ms)	Duty cycle(%)	Duty factor(dB)
a	1.410	1.435	98.26%	0.076
n20	1.330	1.350	98.52%	0.065
n40	0.660	0.690	95.65%	0.193
ac20	1.320	1.345	98.14%	0.081
ac40	0.657	0.690	95.22%	0.213
ac80	0.334	0.364	91.76%	0.374



Band 1-a20

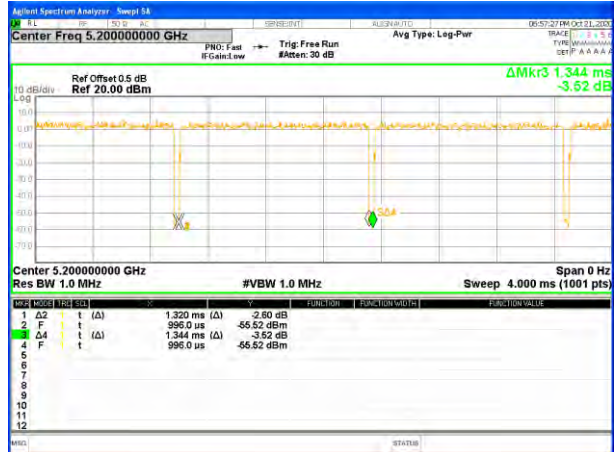

Band 1-n20



Band 1-n40



Band 1-ac20



Band 1-ac40



Band 1-ac80



Band 2-a20



Band 2-n20



Band 2-n40



Band 2-ac20



Band 2-ac40



Band 2-ac80



Band 3-a20



Band 3-n20



Band 3-n40



Band 3-ac20



Band 3-ac40



Band 3-ac80



Band 4-a20



Band 4-n20



Band 4-n40



Band 4-ac20



Band 4-ac40



Band 4-ac80



7. AUTOMATICALLY DISCONTINUE TRANSMISSION

7.1 LIMIT OF AUTOMATICALLY DISCONTINUE TRANSMISSION

The device shall automatically discontinue transmission in case of either absence of information to transmit or operational failure. These provisions are not intended to preclude the transmission of control or signaling information or the use of repetitive codes used by certain digital technologies to complete frame or burst intervals. Applicants shall include in their application for equipment authorization to describe how this requirement is met.

7.2 TEST RESULT OF AUTOMATICALLY DISCONTINUE TRANSMISSION

During no any information transmission, the EUT can automatically discontinue transmission and become standby mode for power saving. The EUT can detect the controlling signal of ACK message transmitting from remote device and verify whether it shall resend or discontinue transmission





8. ANTENNA REQUIREMENT

8.1 STANDARD REQUIREMENT

15.203 requirement: For intentional device, according to 15.203: an intentional radiator shall be designed to ensure that no antenna other than that furnished by the responsible party shall be used with the device.

8.2 EUT ANTENNA

The EUT antenna is PIFA Antenna Antenna. It comply with the standard requirement.





APPENDIX - PHOTOS OF TEST SETUP

Note: See test photos in setup photo document for the actual connections between Product and support equipment.

※※※※END OF THE REPORT※※※※

