



D7 55" Product Guide

Packing List

1. DTEN D7 55" x 1
2. Wall Mount Brackets x 1
* The bracket pieces are stored at the bottom of the box (beneath the foam).
3. Stylus x 1
4. Power Cable (AC 100V-240V) x 1
5. USB-C to USB-C Cable x 1
6. USB-C to USB-A Adapter x 1

⚠ Do not disassemble the D7 without the supervision of a DTEN technician. Improper use may be subject to voiding the warranty.

What's Inside

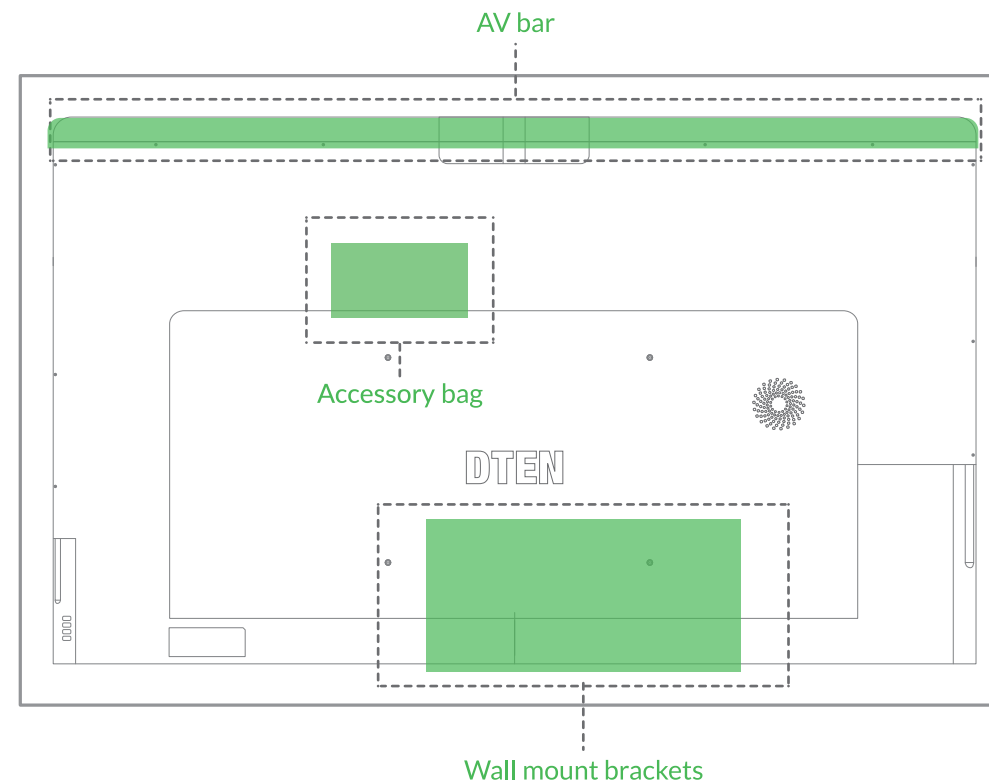

Quick Setup

STEP 1

Install the antennas.

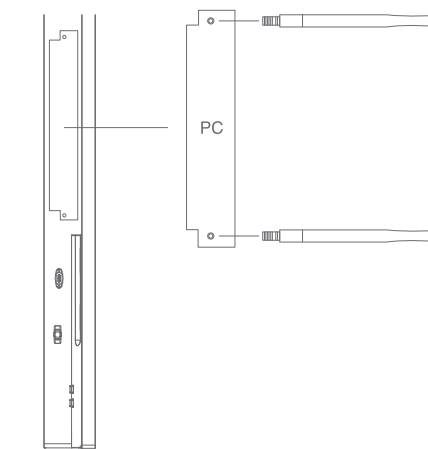

(Side view)

STEP 2

Plug in the power cord to the outlet.
The display will turn on.

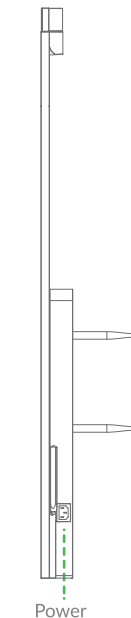

Power

STEP 3

Follow the instructions on-screen to set up the network.
Ethernet connection is preferred.

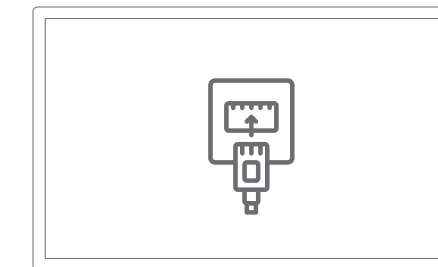

Smart Connect

You can utilize the DTEN D7's touch, speaker, camera and microphone arrays as your computer's peripherals

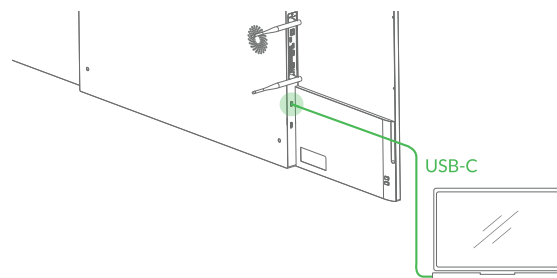

Tips

Zoom Rooms Setup

STEP 1 You need a Zoom Rooms account to sign in.

STEP 2 Select an existing room or create a new room.

* Please go to Zoom Help Center for more info

1. Ethernet connection is preferred for the best meeting experience.
2. To pair with the zoom rooms controller, please visit zoom.us.
3. Please do not disconnect the power without properly shutting down the system.
4. Do not disassemble the DTEN product without the supervision of a DTEN technician.

If you have any questions, feel free to contact us.

✉ SUPPORT@DTEN.COM ☎ +1.866.936.3836

Port Diagram

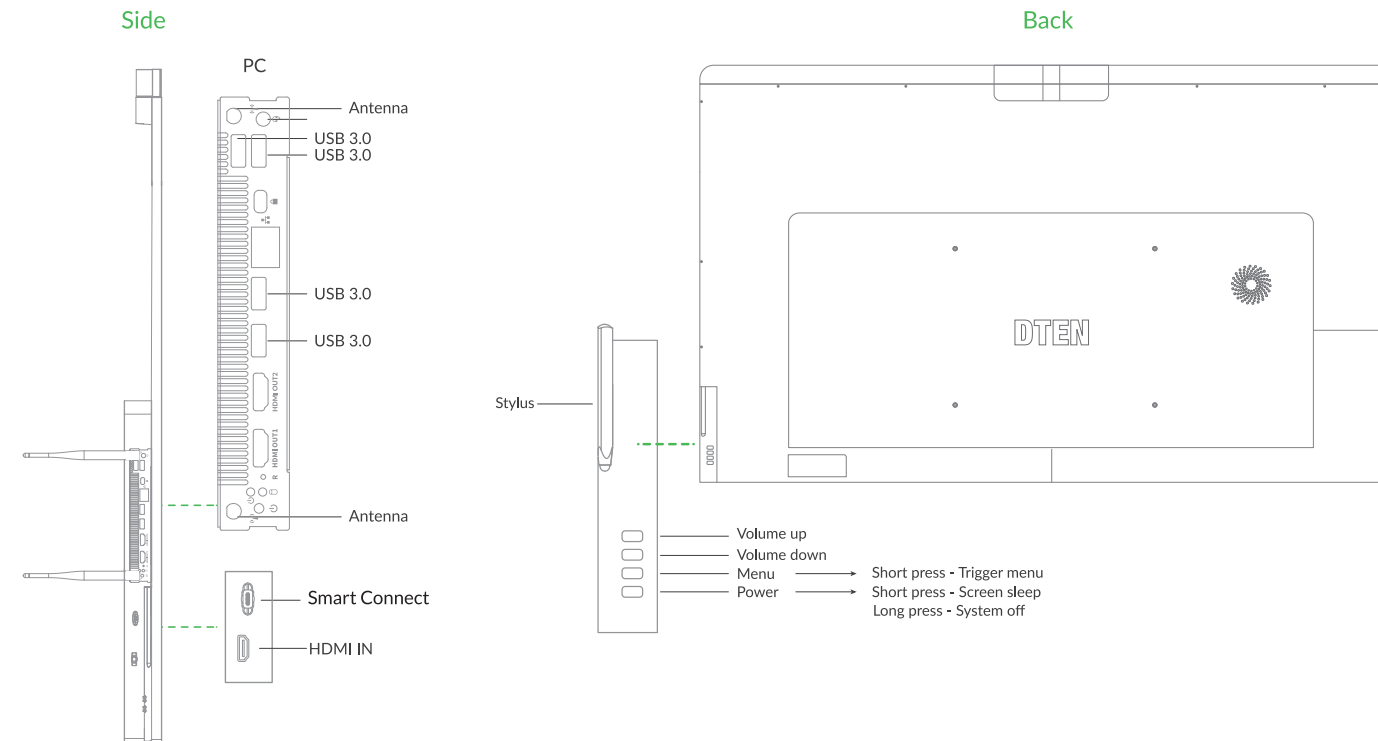

Wall Mount

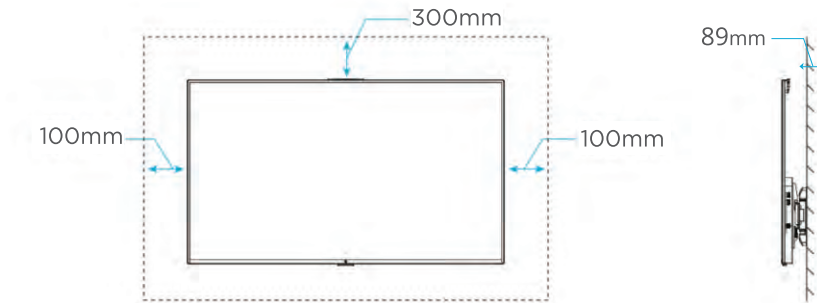

Mounting Hole Pattern: 400 x 300mm

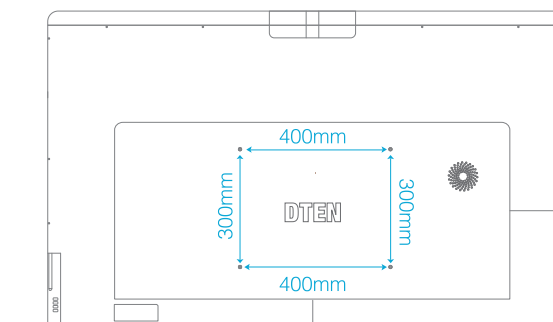

Screws Information

Model	55"
VESA	300 mm x 400 mm
Standard Screw	∅ 6 mm x 12 mm
Number of Screws	4 pcs

▲ Note: Contact a professional for assistance when wall mounting your display. We are not responsible for any damage to the product or injury to yourself. Do not power on the display when performing wall mount installation. It may cause personal injury due to electric shock.