



# RADIO TEST REPORT

Report No.: STS2101021W02

Issued for

DTEN Inc

97 E Brokaw Road suite 180 San Jose CA 95112

<b>Product Name:</b>	DTEN D7
<b>Brand Name:</b>	DTEN
<b>Model Name:</b>	DB50455
<b>Series Model:</b>	N/A
<b>FCC ID:</b>	2AQ7Q-DB50455
<b>Test Standard:</b>	FCC Part 15.407

Any reproduction of this document must be done in full. No single part of this document may be reproduced without permission from STS, All Test Data Presented in this report is only applicable to presented Test sample.

Shenzhen STS Test Services Co., Ltd.  
A 1/F, Building B, Zhuoke Science Park, No.190 Chongqing Road, HepingShequ,  
Fuyong Sub-District, Bao'an District, Shenzhen, Guang Dong, China  
TEL: +86-755 3688 6288 FAX: +86-755 3688 6277 E-mail: sts@stsapp.com





### TEST RESULT CERTIFICATION

**Applicant's Name**..... : DTEN Inc  
 Address ..... : 97 E Brokaw Road suite 180 San Jose CA 95112  
**Manufacturer's Name**..... : DTEN Inc  
 Address ..... : 97 E Brokaw Road suite 180 San Jose CA 95112

**Product Description**

Product Name..... : DTEN D7  
 Brand Name ..... : DTEN  
 Model Name ..... : DB50455  
 Series Model..... : N/A

**Test Standards** ..... : FCC Part15.407

Test Procedure..... ANSI C63.10-2013

This device described above has been tested by STS, the test results show that the equipment under test (EUT) is in compliance with the FCC requirements. And it is applicable only to the tested sample identified in the report.

This report shall not be reproduced except in full, without the written approval of STS, this document only be altered or revised by STS, personal only, and shall be noted in the revision of the document.

**Date of Test**..... :  
 Date of receipt of test item ..... : 03 June 2020  
 Date (s) of performance of tests ..... : 03 June 2020 ~ 14 Jan. 2021  
 Date of Issue..... : 14 Jan. 2021  
 Test Result..... : **Pass**

Testing Engineer :   
 \_\_\_\_\_  
 (Chris Chen)

Technical Manager :   
 \_\_\_\_\_  
 (Sean she)

Authorized Signatory :   
 \_\_\_\_\_  
 (Vita Li)





Table of Contents	Page
<b>1 . SUMMARY OF TEST RESULTS</b>	<b>6</b>
1.1 TEST FACTORY	7
1.2 MEASUREMENT UNCERTAINTY	7
<b>2 . GENERAL INFORMATION</b>	<b>8</b>
2.1 GENERAL DESCRIPTION OF THE EUT	8
2.2 DESCRIPTION OF TEST MODES	11
2.3 TEST SOFTWARE AND POWER LEVEL	12
2.4 BLOCK DIAGRAM SHOWING THE CONFIGURATION OF SYSTEM TESTED	13
2.5 DESCRIPTION OF NECESSARY ACCESSORIES AND SUPPORT UNITS	14
2.6 EQUIPMENTS LIST FOR ALL TEST ITEMS	15
<b>3 . EMC EMISSION TEST</b>	<b>17</b>
3.1 CONDUCTED EMISSION MEASUREMENT	17
3.2 RADIATED EMISSION AND ( BAND EDGE) MEASUREMENT	21
<b>4. POWER SPECTRAL DENSITY TEST</b>	<b>51</b>
4.1 LIMIT	51
4.2 TEST PROCEDURE	51
4.3 DEVIATION FROM STANDARD	52
4.4 TEST SETUP	52
4.5 EUT OPERATION CONDITIONS	52
4.6 TEST RESULTS	52
<b>5. BANDWIDTH MEASUREMENT</b>	<b>56</b>
5.1 EMISSION BANDWIDTH (EBW) 26 BANDWID PROCEDURES / LIMIT	56
5.2 OCCUPIED BANDWIDTH ( 99%) TEST APPLIED PROCEDURES / LIMIT	59
5.3 MINIMUM EMISSION BANDWIDTH(6 DB) PROCEDURES / LIMIT	62
<b>6. MAXIMUM CONDUCTED OUTPUT POWER</b>	<b>64</b>
6.1 LIMIT	64
6.2 TEST PROCEDURE	64
6.3 DEVIATION FROM STANDARD	64
6.4 TEST SETUP	64
6.5 EUT OPERATION CONDITIONS	64
6.6 TEST RESULTS	65
<b>7. AUTOMATICALLY DISCONTINUE TRANSMISSION</b>	<b>75</b>
7.1 LIMIT OF AUTOMATICALLY DISCONTINUE TRANSMISSION	75
7.2 TEST RESULT OF AUTOMATICALLY DISCONTINUE TRANSMISSION	75



<b>Table of Contents</b>	<b>Page</b>
<b>8. ANTENNA REQUIREMENT</b>	<b>76</b>
8.1 STANDARD REQUIREMENT	76
8.2 EUT ANTENNA	76
<b>APPENDIX - PHOTOS OF TEST SETUP</b>	<b>77</b>





**Revision History**

Rev.	Issue Date	Report NO.	Effect Page	Contents
00	23 July 2020	STS2006175W09	ALL	Initial Issue
00	14 Jan. 2021	STS2101021W02	ALL	Added 5.8G WIFI.





## 1. SUMMARY OF TEST RESULTS

Test procedures according to the technical standards:

§ 15.407, KDB 789033 D02 General U-NII Test Procedures New Rules v02r01

FCC Part 15.407		
FCC standard	Test Item	Results
15.207	AC Conducted Emission	PASS
15.407 (a) /15.407 (e)	26dB/6dB &99% Bandwidth	PASS
15.407(a)	Maximum Conducted Output Power	PASS
15.407(b)/15.205/15.209	Radiated Emission And (bandedge Emissions) Measurement	PASS
15.407(a)	Power Spectral Density	PASS
15.407(c)	Automatically Discontinue Transmission	PASS
15.203/15.204	Antenna Requirement	PASS

NOTE:

- (1) "N/A" denotes test is not applicable in this Test Report.
- (2) All tests are according to ANSI C63.10-2013.



## 1.1 TEST FACTORY

SHENZHEN STS TEST SERVICES CO., LTD

Add. : A 1/F, Building B, Zhuoke Science Park, No.190 Chongqing Road, HepingShequ, Fuyong Sub-District, Bao'an District, Shenzhen, Guang Dong, China

FCC test Firm Registration Number: 625569

IC test Firm Registration Number: 12108A

A2LA Certificate No.: 4338.01

## 1.2 MEASUREMENT UNCERTAINTY

The reported uncertainty of measurement  $y \pm U$ , where expanded uncertainty  $U$  is based on a standard uncertainty multiplied by a coverage factor of  $k=2$ , providing a level of confidence of approximately **95 %**.

No.	Item	Uncertainty
1	RF output power, conducted	$\pm 0.68\text{dB}$
2	Unwanted Emissions, conducted	$\pm 2.988\text{dB}$
3	All emissions, radiated 9K-30MHz	$\pm 2.68\text{dB}$
4	All emissions, radiated 30M-1GHz	$\pm 4.39\text{dB}$
5	All emissions, radiated 1G-6GHz	$\pm 5.10\text{dB}$
6	All emissions, radiated >6G	$\pm 5.48\text{dB}$
7	Conducted Emission (9KHz-150KHz)	$\pm 2.79\text{dB}$
8	Conducted Emission (150KHz-30MHz)	$\pm 2.80\text{dB}$



**2. GENERAL INFORMATION**

**2.1 GENERAL DESCRIPTION OF THE EUT**

Product Name	DTEN D7	
Trade Name	DTEN	
Model Name	DB50455	
Series Model	N/A	
Model Difference	N/A	
Product Description	The EUT is a DTEN D7	
	Operation Frequency:	IEEE 802.11a/ n(HT20)/ac(VHT20): 5.180GHz-5.240GHz IEEE 802.11n(HT40)/ac(VHT40): 5.190GHz-5.310GHz IEEE 802.11ac(VHT80): 5.210GHz IEEE 802.11a/ n(HT20)/ac(VHT20): 5.260GHz-5.320GHz IEEE 802.11n(HT40)/ac(VHT40): 5.270GHz-5.310GHz IEEE 802.11ac(VHT80): 5.290GHz IEEE 802.11a/ n(HT20)/ac(VHT20): 5.500GHz-5.700GHz IEEE 802.11n(HT40)/ac(VHT40): 5.510GHz-5.670GHz IEEE 802.11ac(VHT80): 5.530GHz-5.610GHz IEEE 802.11a/ n(HT20)/ac(VHT20): 5.745GHz-5.825GHz IEEE 802.11n(HT40)/ac(VHT40): 5.755GHz-5.795GHz IEEE 802.11ac(VHT80): 5.775GHz
	Modulation Type:	802.11a(OFDM): BPSK,QPSK,16-QAM,64-QAM 802.11n(OFDM): BPSK,QPSK,16-QAM,64-QAM 802.11ac(OFDM): BPSK,QPSK,16-QAM,64-QAM,256-QAM
	Antenna Designation:	Please refer to the Note 3.
	Max.Output Power (Conducted):	14.47 dBm
	More details of EUT technical specification, please refer to the User's Manual.	
	Test Channel	Please refer to the Note 2.
Power Rating	Input: 100-240V~ 50/60Hz 3.0A	
Hardware version number	CV3458H-J	
Software version number	1.1.0.3	
Connecting I/O Port(s)	Please refer to the Note 1.	

Note:

1. For a more detailed features description, please refer to the manufacturer's specifications or the User Manual.





2. Operation Frequency of channel

5.180GHz-5.240GHz		5.500GHz-5.720GHz	
Channel	Frequency	Channel	Frequency
36	5180	100	5500
38	5190	102	5510
40	5200	104	5520
42	5210	106	5530
44	5220	108	5540
46	5230	110	5550
48	5240	112	5560
		116	5580
		118	5590
5.260GHz-5.320GHz			
Channel	Frequency		
52	5260	120	5600
54	5270	124	5620
56	5280	126	5630
58	5290	128	5640
60	5300	132	5660
62	5310	134	5670
64	5320	136	5680
		140	5700
5.745GHz-5.825GHz			
Channel	Frequency		
149	5745		
151	5755		
153	5765		
155	5775		
157	5785		
159	5795		
161	5805		
165	5825		

Note:

In section 15.31(m), regards to the operating frequency range over 10 MHz, the Lowest frequency, the middle frequency, and the highest frequency of channel were selected to perform the test, and the selected channel see below:

Carrier Frequency Channel

5GHz:

For 802.11a/n(HT20) /ac (VHT20)			
Channel	Freq.(MHz)	Channel	Freq.(MHz)
36	5180	52	5260
40	5200	60	5300
48	5240	64	5320

For 802.11a/n(HT20) /ac (VHT20)			
Channel	Freq.(MHz)	Channel	Freq.(MHz)
100	5500	149	5745
116	5580	157	5785
140	5700	165	5825



For 802.11n(HT40) /ac (VHT40)			
Channel	Freq.(MHz)	Channel	Freq.(MHz)
38	5190	54	5270
46	5230	62	5310

For 802.11n(HT40) /ac (VHT40)			
Channel	Freq.(MHz)	Channel	Freq.(MHz)
102	5510	151	5755
110	5550	159	5795
134	5670		

For 802.11ac (VHT80)			
Channel	Freq.(MHz)	Channel	Freq.(MHz)
42	5210	58	5290

For 802.11ac (VHT80)			
Channel	Freq.(MHz)	Channel	Freq.(MHz)
106	5530	155	5775
122	5610		

3. Ant	Brand	Model Name	Ant Type	Connector	Gain (dBi)	NOTE
A	DTEN	DB50455	External	N/A	5.2G:3.76dBi, 5.3G:3.76dBi, 5.6G:3.48dBi, 5.8G:3.95dBi	WLAN Ant

Note: The antenna information refer the manufacturer provide report, applicable only to the tested sample identified in the report.



## 2.2 DESCRIPTION OF TEST MODES

To investigate the maximum EMI emission characteristics generates from EUT, the test system was pre-scanning tested base on the consideration of following EUT operation mode or test configuration mode which possible have effect on EMI emission level. Each of these EUT operation mode(s) or test configuration mode(s) mentioned above was evaluated respectively.

Worst Mode	Description	Data Rate
Mode 1	TX IEEE 802.11a HT20 CH36&CH40&CH48	6 Mbps
Mode 2	TX IEEE 802.11a HT20 CH52&CH60&CH64	6 Mbps
Mode 3	TX IEEE 802.11a HT20 CH100&CH116&CH140	6 Mbps
Mode 4	TX IEEE 802.11a HT20 CH149&CH157&CH165	6 Mbps
Mode 5	TX IEEE 802.11n HT20 CH36&CH40&CH48	MCS 0
Mode 6	TX IEEE 802.11ac HT20 CH36&CH40&CH48	NSS1 MCS0
Mode 7	TX IEEE 802.11n HT20 CH52&CH60&CH64	MCS 0
Mode 8	TX IEEE 802.11ac HT20 CH52&CH60&CH64	NSS1 MCS0
Mode 9	TX IEEE 802.11n HT20 CH100&CH116&CH140	MCS 0
Mode 10	TX IEEE 802.11ac HT20 CH100&CH116&CH140	NSS1 MCS0
Mode 11	TX IEEE 802.11n HT20 CH149&CH157&CH165	MCS 0
Mode 12	TX IEEE 802.11ac HT20 CH149&CH157&CH165	NSS1 MCS0
Mode 13	TX IEEE 802.11n HT40 CH38&CH46	MCS 0
Mode 14	TX IEEE 802.11ac HT40 CH38&CH46	NSS1 MCS0
Mode 15	TX IEEE 802.11n HT40 CH54 &CH62	MCS 0
Mode 16	TX IEEE 802.11ac HT40 CH54 &CH62	NSS1 MCS0
Mode 17	TX IEEE 802.11n HT40 CH102&CH110&CH134	MCS 0
Mode 18	TX IEEE 802.11ac HT40 CH102&CH110&CH134	NSS1 MCS0
Mode 19	TX IEEE 802.11n HT40 CH151&CH159	MCS 0
Mode 20	TX IEEE 802.11ac HT40 CH151&CH159	NSS1 MCS0
Mode 21	TX IEEE 802.11ac HT80 CH42	NSS1 MCS0
Mode 22	TX IEEE 802.11ac HT80 CH58	NSS1 MCS0
Mode 23	TX IEEE 802.11ac HT80 CH106&122	NSS1 MCS0
Mode 24	TX IEEE 802.11ac HT80 CH155	NSS1 MCS0

- Note: (1) The measurements are performed at the highest, middle, lowest available channels.  
 (2) The measurements are performed at all Bit Rate of Transmitter, the worst data was reported.  
 (3) We have be tested for all availiable U.S. voltage and frequencies(For 120V,50/60Hz and 240V, 50/60Hz) for which the device is capable of operation.



AC Conducted Emission

Test Case	
AC Conducted Emission	Mode 25: Keeping TX + WLAN Link

2.3 TEST SOFTWARE AND POWER LEVEL

During testing channel & power controlling software provided by the customer was used to control the operating channel as well as the output power level.

RF Function	Type	Mode Or Modulation type	Ant Gain(dBi)	Power Class	Software For Testing
WIFI(5G)	5G WIFI Band1 (5150MHz-5250MHz)	802.11a	3.76	15	DRTU
		802.11n(HT20)		15	
		802.11n(HT40)		15	
		802.11ac(VHT20)		15	
		802.11ac(VHT40)		15	
		802.11ac(VHT80)		12	
	5G WIFI Band2 (5250MHz-5350MHz)	802.11a	3.76	15	
		802.11n(HT20)		15	
		802.11n(HT40)		15	
		802.11ac(VHT20)		15	
		802.11ac(VHT40)		15	
		802.11ac(VHT80)		12	
	5G WIFI Band3 (5470MHz-5725MHz)	802.11a	3.48	15	
		802.11n(HT20)		15	
		802.11n(HT40)		14	
		802.11ac(VHT20)		15	
		802.11ac(VHT40)		14	
		802.11ac(VHT80)		14	
	5G WIFI Band4 (5725MHz-5875MHz)	802.11a	3.95	10	
		802.11n(HT20)		10	
		802.11n(HT40)		10	
		802.11ac(VHT20)		10	
		802.11ac(VHT40)		10	
		802.11ac(VHT80)		6	

## 2.4 BLOCK DIAGRAM SHOWING THE CONFIGURATION OF SYSTEM TESTED

Radiated Spurious Emission Test

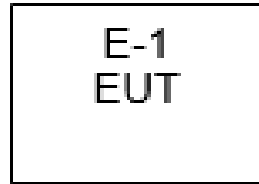

Conducted Emission Test

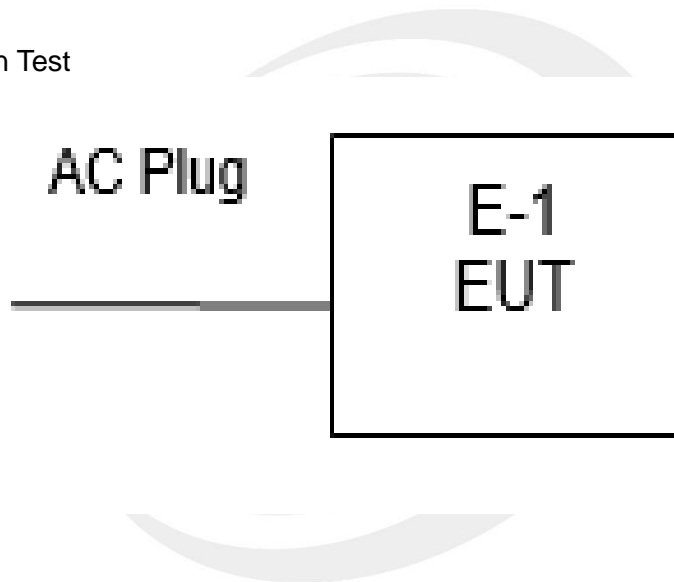



## 2.5 DESCRIPTION OF NECESSARY ACCESSORIES AND SUPPORT UNITS

The EUT has been tested as an independent unit together with other necessary accessories or support units. The following support units or accessories were used to form a representative test configuration during the tests.

### Necessary accessories

Item	Equipment	Mfr/Brand	Model/Type No.	Serial No.	Note
N/A	N/A	N/A	N/A	N/A	N/A

### Support units

Item	Equipment	Mfr/Brand	Model/Type No.	Serial No.	Note
N/A	N/A	N/A	N/A	N/A	N/A

Note:

- (1) The support equipment was authorized by Declaration of Confirmation.
- (2) For detachable type I/O cable should be specified the length in cm in 『Length』 column.



**2.6 EQUIPMENTS LIST FOR ALL TEST ITEMS**

**Radiation Test equipment**

Kind of Equipment	Manufacturer	Type No.	Serial No.	Last calibration	Calibrated until
EMI Test Receiver	R&S	ESCI	101427	2019.07.29	2020.07.28
Signal Analyzer	Agilent	N9020A	MY51110105	2020.03.05	2021.03.04
Active loop Antenna	ZHINAN	ZN30900C	16035	2018.03.11	2021.03.10
Bilog Antenna	TESEQ	CBL6111D	34678	2017.11.02	2020.11.01
Horn Antenna	SCHWARZBECK	BBHA 9120D(1201)	9120D-1343	2018.10.19	2021.10.18
Horn Antenna (18-40GHz)	A-INFO	LB-180400-KF	J211020657	2018.03.11	2021.03.10
Pre-Amplifier (18G-40G)	SKET	LNPA_1840-50	SK2018101801	2019.10.22	2020.10.21
Spectrum Analyzer	R&S	FSV40-N	101823	2019.06.05	2020.06.04
Pre-Amplifier(0.1 M-3GHz)	EM	EM330	060665	2019.10.09	2020.10.08
Pre-Amplifier (1G-18GHz)	SKET	LNPA-01018G-4 5	SK2018080901	2019.10.12	2020.10.11
Temperature & Humidity	HH660	Mieo	N/A	2019.10.12	2020.10.11
Turn table	EM	SC100_1	60531	N/A	N/A
Antenna mast	EM	SC100	N/A	N/A	N/A
Test SW	BULUN	BL410-E/18.905			

**Conduction Test equipment**

Kind of Equipment	Manufacturer	Type No.	Serial No.	Last calibration	Calibrated until
Test Receiver	R&S	ESCI	101427	2019.07.29	2020.07.28
LISN	R&S	ENV216	101242	2019.10.09	2020.10.08
LISN	EMCO	3810/2NM	23625	2019.10.09	2020.10.08
Temperature & Humidity	HH660	Mieo	N/A	2019.10.12	2020.10.11
Test SW	FARAD	EZ-EMC(Ver.STSLAB-03A1 CE)			

**RF Connected Test**

Kind of Equipment	Manufacturer	Type No.	Serial No.	Last calibration	Calibrated until
USB RF power sensor	DARE	RPR3006W	15I00041SNO03	2019.10.09	2020.10.08
Signal Analyzer	Agilent	N9020A	MY49100060	2019.10.09	2020.10.08
Temperature & Humidity	HH660	Mieo	N/A	2019.10.12	2020.10.11
Test SW	FARAD	LZ-RF /LzRf-3A3			



Radiation Test equipment

Kind of Equipment	Manufacturer	Type No.	Serial No.	Last calibration	Calibrated until
Test Receiver	R&S	ESCI	101427	2020.10.12	2021.10.11
Signal Analyzer	R&S	FSV 40-N	101823	2020.10.10	2021.10.09
Active loop Antenna	ZHINAN	ZN30900C	16035	2019.07.11	2021.07.10
Bilog Antenna	TESEQ	CBL6111D	34678	2020.10.12	2022.10.11
Horn Antenna	SCHWARZBECK	BBHA 9120D	02014	2019.10.15	2021.10.14
SHF-EHF Horn Antenna (18G-40GHz)	A-INFO	LB-180400-KF	J211020657	2020.10.12	2022.10.11
Pre-Amplifier (0.1M-3GHz)	EM	EM330	060665	2020.10.12	2021.10.11
Pre-Amplifier (1G-18GHz)	SKET	LNPA-01018G-45	SK2018080901	2020.10.12	2021.10.11
Pre-Amplifier (18G-40GHz)	SKET	LNPA-1840-50	SK2018101801	2020.10.10	2021.10.09
Temperature & Humidity	HH660	Mieo	N/A	2020.10.13	2021.10.12
Turn table	EM	SC100_1	60531	N/A	N/A
Antenna mast	EM	SC100	N/A	N/A	N/A
Test SW	FARAD	EZ-EMC(Ver.STSLAB-03A1 RE)			

Conduction Test equipment

Kind of Equipment	Manufacturer	Type No.	Serial No.	Last calibration	Calibrated until
Test Receiver	R&S	ESCI	101427	2020.10.12	2021.10.11
LISN	R&S	ENV216	101242	2020.10.12	2021.10.11
LISN	EMCO	3810/2NM	23625	2020.10.12	2021.10.11
Temperature & Humidity	HH660	Mieo	N/A	2020.10.13	2021.10.12
Test SW	FARAD	EZ-EMC(Ver.STSLAB-03A1 CE)			

RF Connected Test

Kind of Equipment	Manufacturer	Type No.	Serial No.	Last calibration	Calibrated until
Power Sensor	Keysight	U2021XA	MY55520005	2020.10.10	2021.10.09
			MY55520006	2020.10.10	2021.10.09
			MY56120038	2020.10.10	2021.10.09
			MY56280002	2020.10.10	2021.10.09
Signal Analyzer	Agilent	N9020A	MY51110105	2020.03.05	2021.03.04
Temperature & Humidity	HH660	Mieo	N/A	2020.10.13	2021.10.12
Test SW	FARAD	LZ-RF /LzRf-3A3			





### 3. EMC EMISSION TEST

#### 3.1 CONDUCTED EMISSION MEASUREMENT

##### 3.1.1 POWER LINE CONDUCTED EMISSION Limits (Frequency Range 150KHz-30MHz)

FREQUENCY (MHz)	Class B (dBuV)		Standard
	Quasi-peak	Average	
0.15 -0.5	66 - 56 *	56 - 46 *	CISPR
0.50 -5.0	56.00	46.00	CISPR
5.0 -30.0	60.00	50.00	CISPR

0.15 -0.5	66 - 56 *	56 - 46 *	FCC
0.50 -5.0	56.00	46.00	FCC
5.0 -30.0	60.00	50.00	FCC

Note:

- (1) The tighter limit applies at the band edges.
- (2) The limit of " \* " marked band means the limitation decreases linearly with the logarithm of the frequency in the range.

The following table is the setting of the receiver

Receiver Parameters	Setting
Attenuation	10 dB
Start Frequency	0.15 MHz
Stop Frequency	30 MHz
IF Bandwidth	9 kHz

**3.1.2 TEST PROCEDURE**

- a. The EUT was placed 0.8 meters from the horizontal ground plane with EUT being connected to the power mains through a line impedance stabilization network (LISN). All other support equipments powered from additional LISN(s). The LISN provide 50 Ohm/ 50uH of coupling impedance for the measuring instrument.
- b. Interconnecting cables that hang closer than 40 cm to the ground plane shall be folded back and forth in the center forming a bundle 30 to 40 cm long.
- c. I/O cables that are not connected to a peripheral shall be bundled in the center. The end of the cable may be terminated, if required, using the correct terminating impedance. The overall length shall not exceed 1 m.
- d. LISN at least 80 cm from nearest part of EUT chassis.
- e. For the actual test configuration, please refer to the related Item –EUT Test Photos.

**3.1.3 DEVIATION FROM TEST STANDARD**

No deviation

**3.1.4 TEST SETUP**

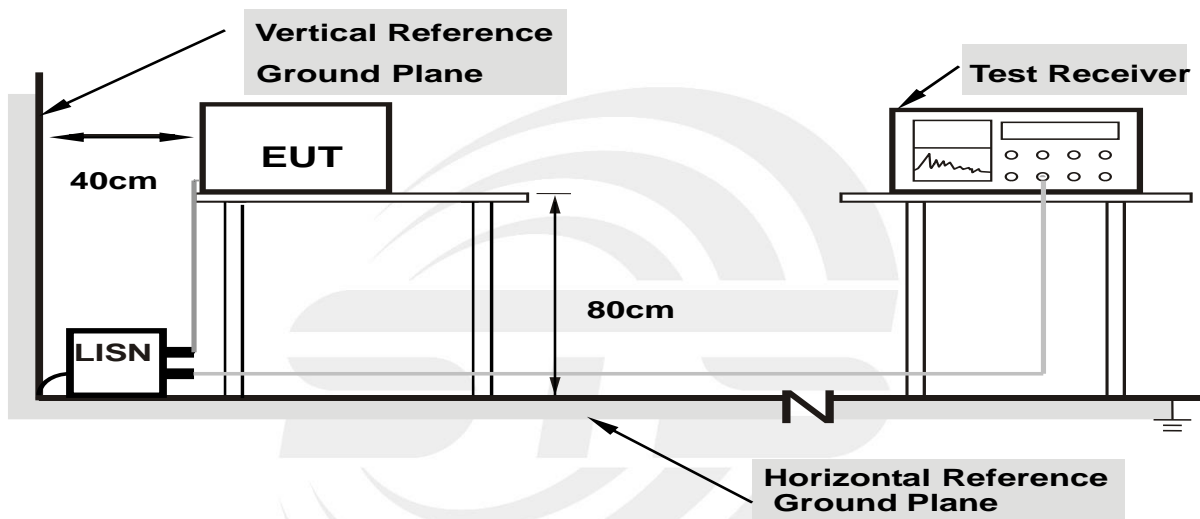

- Note: 1.Support units were connected to second LISN.**  
**2.Both of LISNs (AMN) are 80 cm from EUT and at least 80 from other units and other metal planes**

**3.1.5 EUT OPERATING CONDITIONS**

The EUT was configured for testing in a typical fashion (as a customer would normally use it). The EUT has been programmed to continuously transmit during test. This operating condition was tested and used to collect the included data.



### 3.1.6 TEST RESULTS

Temperature:	25.4(C)	Relative Humidity:	50%RH
Test Voltage:	AC 120V/60Hz	Phase:	L
Test Mode :	Mode 25		

No.	Frequency (MHz)	Reading (dBuV)	Correct Factor(dB)	Result (dBuV)	Limit (dBuV)	Margin (dB)	Remark
1	0.2420	26.34	20.01	46.35	62.03	-15.68	QP
2	0.2420	16.59	20.01	36.60	52.03	-15.43	AVG
3	0.5700	24.35	19.90	44.25	56.00	-11.75	QP
4	0.5700	15.01	19.90	34.91	46.00	-11.09	AVG
5	0.8940	25.00	19.77	44.77	56.00	-11.23	QP
6	0.8940	11.03	19.77	30.80	46.00	-15.20	AVG
7	1.7340	26.01	19.80	45.81	56.00	-10.19	QP
8	1.7340	8.11	19.80	27.91	46.00	-18.09	AVG
9	3.4060	25.02	19.86	44.88	56.00	-11.12	QP
10	3.4060	6.64	19.86	26.50	46.00	-19.50	AVG
11	10.3540	27.93	19.84	47.77	60.00	-12.23	QP
12	10.3540	11.56	19.84	31.40	50.00	-18.60	AVG

Remark:

1. All readings are Quasi-Peak and Average values.
2. Margin = Result (Result = Reading + Factor) – Limit

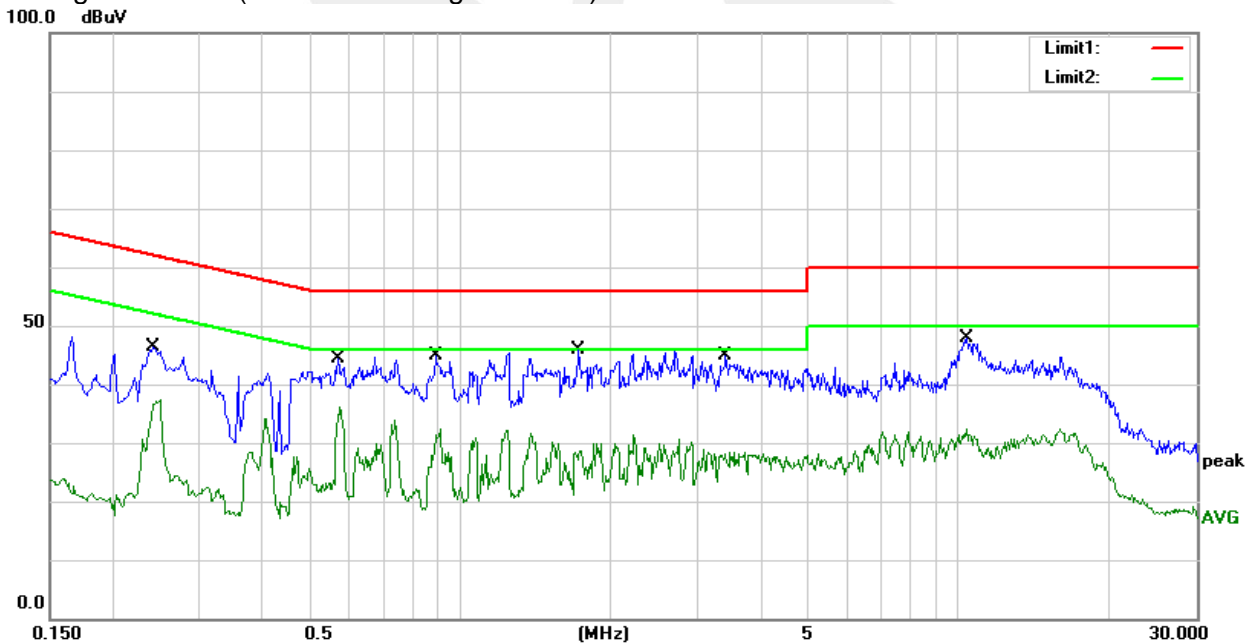



Temperature:	25.4(C)	Relative Humidity:	50%RH
Test Voltage	AC 120V/60Hz	Phase:	N
Test Mode	Mode 25		

No.	Frequency (MHz)	Reading (dBuV)	Correct Factor(dB)	Result (dBuV)	Limit (dBuV)	Margin (dB)	Remark
1	0.2404	27.04	20.00	47.04	62.08	-15.04	QP
2	0.2404	13.05	20.00	33.05	52.08	-19.03	AVG
3	0.4140	23.97	20.01	43.98	57.57	-13.59	QP
4	0.4140	14.51	20.01	34.52	47.57	-13.05	AVG
5	0.9020	24.60	19.77	44.37	56.00	-11.63	QP
6	0.9020	10.98	19.77	30.75	46.00	-15.25	AVG
7	1.8700	25.03	19.81	44.84	56.00	-11.16	QP
8	1.8700	10.00	19.81	29.81	46.00	-16.19	AVG
9	2.9220	26.46	19.85	46.31	56.00	-9.69	QP
10	2.9220	2.34	19.85	22.19	46.00	-23.81	AVG
11	10.5660	28.70	19.84	48.54	60.00	-11.46	QP
12	10.5660	12.64	19.84	32.48	50.00	-17.52	AVG

Remark:

1. All readings are Quasi-Peak and Average values.
2. Margin = Result (Result =Reading + Factor )-Limit

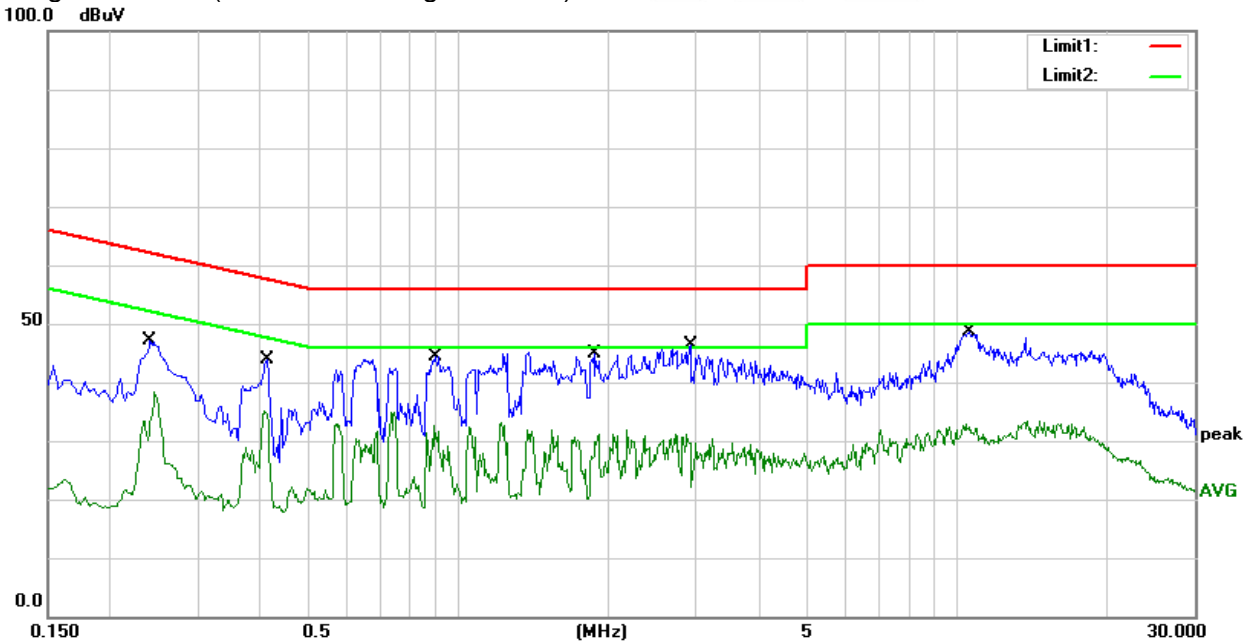



### 3.2 RADIATED EMISSION AND ( BAND EDGE) MEASUREMENT

#### 3.2.1 RADIATED EMISSION LIMITS (Frequency Range 9kHz-1000MHz)

In case the emission fall within the restricted band specified on 15.407(b)7& 15.205/209(a), then the (a); limit in the table below has to be followed.

Frequencies (MHz)	Field Strength (microrvolts/meter)	Measurement Distance (meters)
0.009~0.490	2400/F(KHz)	300
0.490~1.705	24000/F(KHz)	30
1.705~30.0	30	30
30~88	100	3
88~216	150	3
216~960	200	3
Above 960	500	3

#### LIMITS OF RADIATED EMISSION MEASUREMENT (Above 1000MHz)

FREQUENCY (MHz)	Class B (dBuV/m) (at 3M)	
	PEAK	AVERAGE
Above 1000	68.2	54

Notes:

- (1) The limit for radiated test was performed according to FCC PART 15E.
- (2) The tighter limit applies at the band edges.
- (3) Emission level (dBuV/m)=20log Emission level (uV/m).

#### LIMITS OF RESTRICTED FREQUENCY BANDS

FREQUENCY (MHz)	FREQUENCY (MHz)	FREQUENCY (MHz)	FREQUENCY (GHz)
0.090-0.110	16.42-16.423	399.9-410	4.5-5.15
0.495-0.505	16.69475-16.69525	608-614	5.35-5.46
2.1735-2.1905	16.80425-16.80475	960-1240	7.25-7.75
4.125-4.128	25.5-25.67	1300-1427	8.025-8.5
4.17725-4.17775	37.5-38.25	1435-1626.5	9.0-9.2
4.20725-4.20775	73-74.6	1645.5-1646.5	9.3-9.5
6.215-6.218	74.8-75.2	1660-1710	10.6-12.7
6.26775-6.26825	108-121.94	1718.8-1722.2	13.25-13.4
6.31175-6.31225	123-138	2200-2300	14.47-14.5
8.291-8.294	149.9-150.05	2310-2390	15.35-16.2
8.362-8.366	156.52475-156.52525	2483.5-2500	17.7-21.4
8.37625-8.38675	156.7-156.9	2690-2900	22.01-23.12
8.41425-8.41475	162.0125-167.17	3260-3267	23.6-24.0
12.29-12.293	167.72-173.2	3332-3339	31.2-31.8
12.51975-12.52025	240-285	3345.8-3358	36.43-36.5
12.57675-12.57725	322-335.4	3600-4400	Above 38.6
13.36-13.41			

Note: In case the emission radiated emission above 1000MHz fall within the restricted band the restricted frequency bands, the peak limit is 74 dBuV/m.



**LIMITS OF EMISSIONS OUTSIDE OF THE FREQUENCY BANDS**

Undesirable emission limits. Except as shown in paragraph (b)(7) of this section, the maximum emissions outside of the frequency bands of operation shall be attenuated in accordance with the following limits:

- (1) For transmitters operating in the 5.15-5.25 GHz band: All emissions outside of the 5.15-5.35 GHz band shall not exceed an e.i.r.p. of -27 dBm/MHz.
- (2) For transmitters operating in the 5.25-5.35 GHz band: All emissions outside of the 5.15-5.35 GHz band shall not exceed an e.i.r.p. of -27 dBm/MHz.
- (3) For transmitters operating in the 5.47-5.725 GHz band: All emissions outside of the 5.47-5.725 GHz band shall not exceed an e.i.r.p. of -27 dBm/MHz.
- (4) For transmitters operating in the 5.725-5.85 GHz band:
  - (i) All emissions shall be limited to a level of -27 dBm/MHz at 75 MHz or more above or below the band edge increasing linearly to 10 dBm/MHz at 25 MHz above or below the band edge, and from 25 MHz above or below the band edge increasing linearly to a level of 15.6 dBm/MHz at 5 MHz above or below the band edge, and from 5 MHz above or below the band edge increasing linearly to a level of 27 dBm/MHz at the band edge.

Note: dBuV/m(at 3M) = EIRP(dBm) + 95.3.

Peak Limit = -27dBm/MHz + 95.3 = 68.3 dBuV/m.

Spectrum Parameter	Setting
Attenuation	Auto
Detector	Peak
Start Frequency	1000 MHz(Peak/AV)
Stop Frequency	10th carrier harmonic (Peak/AV)
RB / VB (emission in restricted band)	1 MHz / 1 MHz, AV=1 MHz /3 MHz

For Band edge

Spectrum Parameter	Setting
Detector	Peak
RB / VB (emission in restricted band)	1 MHz / 1 MHz, AV=1 MHz /3 MHz

Receiver Parameter	Setting
Attenuation	Auto
Start ~ Stop Frequency	9kHz~90kHz / RB 200Hz for PK & AV
Start ~ Stop Frequency	90kHz~110kHz / RB 200Hz for QP
Start ~ Stop Frequency	110kHz~490kHz / RB 200Hz for PK & AV
Start ~ Stop Frequency	490kHz~30MHz / RB 9kHz for QP
Start ~ Stop Frequency	30MHz~1000MHz / RB 120kHz for QP



### 3.2.2 TEST PROCEDURE

- a. The measuring distance of at 3 m shall be used for measurements at frequency 0.009MHz up to 1GHz. For frequencies above 1GHz, any suitable measuring distance may be used.
- b. The EUT was placed on the top of a rotating table 0.8 meters(above 1GHz is 1.5 m) above the ground at a 3 meter anechoic chamber. The table was rotated 360 degrees to determine the position of the highest radiation.
- c. The height of the equipment shall be 0.8 m(above 1GHz is 1.5 m); the height of the test antenna shall vary between 1 m to 4 m. Horizontal and vertical polarizations of the antenna are set to make the measurement
- d. The initial step in collecting conducted emission data is a spectrum analyzer peak detector mode pre-scanning the measurement frequency range. Significant peaks are then marked and then Quasi Peak detector mode re-measured.
- e. If the Peak Mode measured value compliance with and lower than Quasi Peak Mode Limit, the EUT shall be deemed to meet QP Limits and then no additional QP Mode measurement performed.
- f. For the actual test configuration, please refer to the related Item –EUT Test Photos.

Note:

Both horizontal and vertical antenna polarities were tested and performed test to three orthogonal axis. The worst case emissions were reported

### 3.2.2 DEVIATION FROM TEST STANDARD

No deviation



### 3.2.3 TEST SETUP

(A) Radiated Emission Test-Up Frequency Below 30MHz

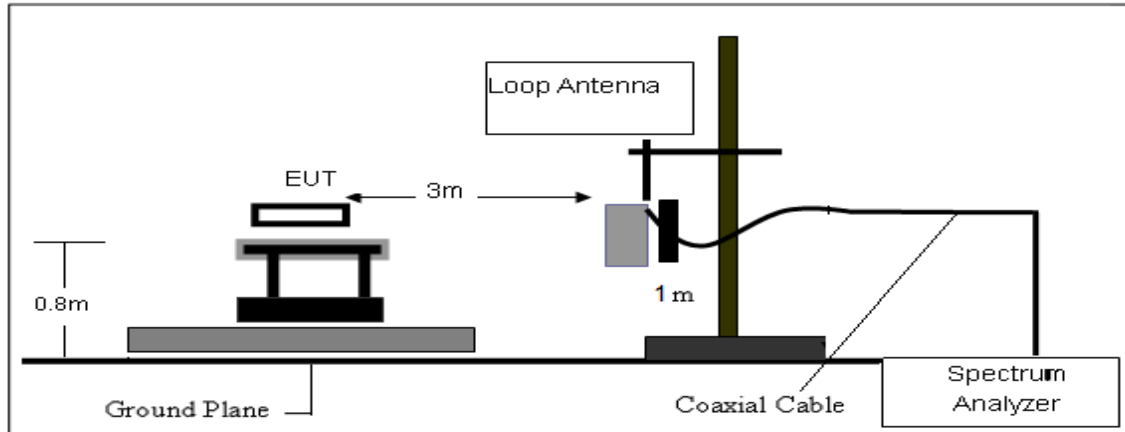

(B) Radiated Emission Test-Up Frequency 30MHz~1GHz

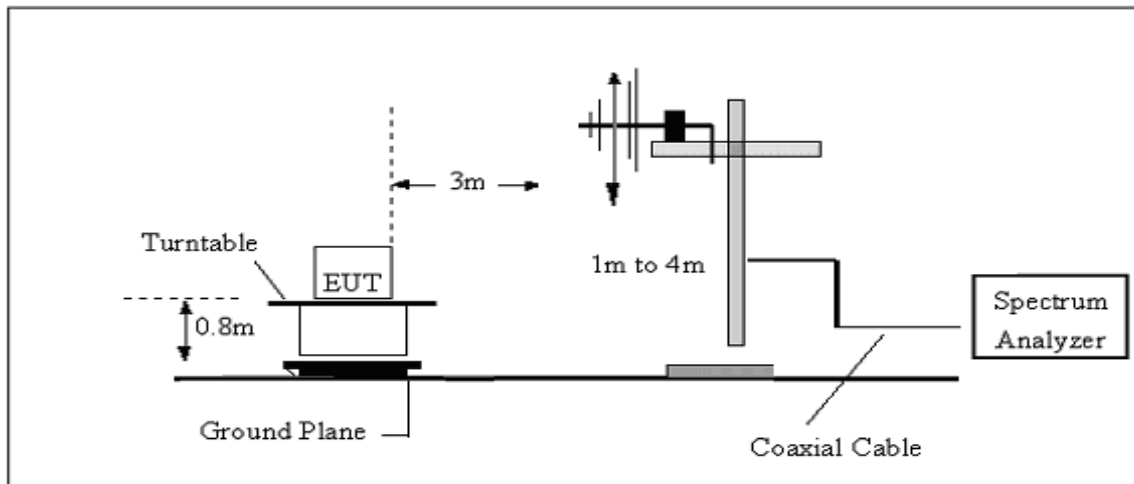

(C) Radiated Emission Test-Up Frequency Above 1GHz

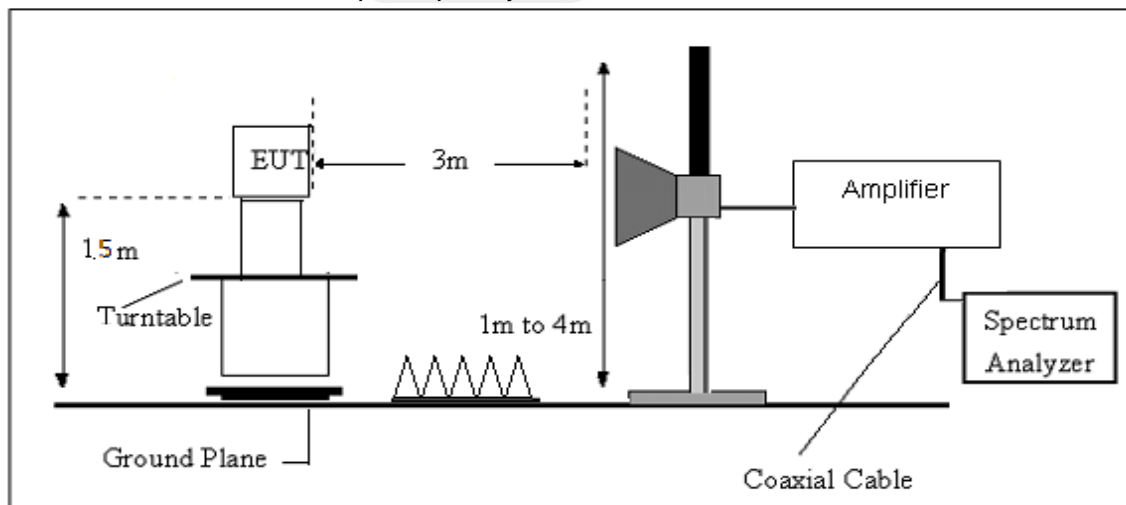





### 3.2.4 EUT OPERATING CONDITIONS

The EUT tested system was configured as the statements of 2.4 Unless otherwise a special operating condition is specified in the follows during the testing.

### 3.2.5 FIELD STRENGTH CALCULATION

The field strength is calculated by adding the Antenna Factor and Cable Factor and subtracting the Amplifier Gain and Duty Cycle Correction Factor (if any) from the measured reading. The basic equation with a sample calculation is as follows:

$$FS = RA + AF + CL - AG$$

Where

FS = Field Strength

CL = Cable Attenuation Factor (Cable Loss)

RA = Reading Amplitude

AG = Amplifier Gain

AF = Antenna Factor

For example

Frequency (MHz)	FS (dB $\mu$ V/m)	RA (dB $\mu$ V/m)	AF (dB)	CL (dB)	AG (dB)	Factor (dB)
300	40	58.1	12.2	1.6	31.9	-18.1

$$\text{Factor} = \text{AF} + \text{CL} - \text{AG}$$

**3.2.6 TEST RESULTS (Between 9KHz – 30 MHz)**

Temperature:	23.4(C)	Relative Humidity:	52%RH
Test Voltage :	AC 120V/60Hz	Polarization :	--
Test Mode :	TX Mode		

Freq.	Reading	Limit	Margin	State
(MHz)	(dBuV/m)	(dBuV/m)	(dB)	P/F
--	--	--	--	PASS
--	--	--	--	PASS

**Note:**

The amplitude of spurious emissions which are attenuated by more than 20dB below the permissible value has no need to be reported.

Distance extrapolation factor =  $40 \log(\text{specific distance}/\text{test distance})$ (dB);

Limit line = specific limits(dBuv) + distance extrapolation factor.

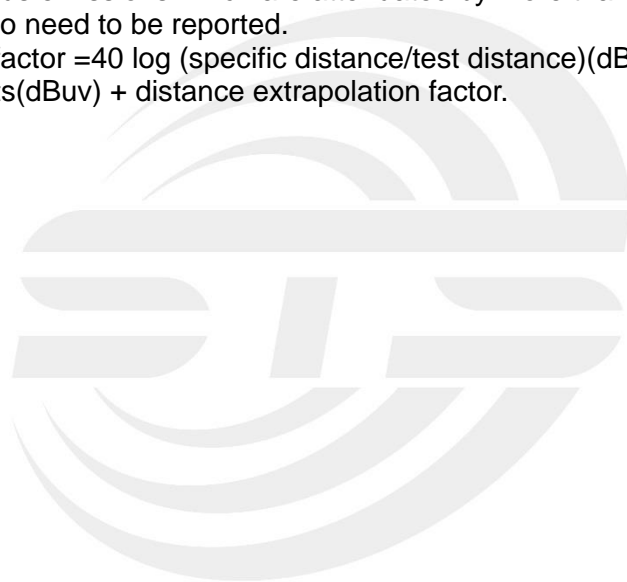



**3.2.7 TEST RESULTS (Between 30MHz – 1GHz)**

Temperature	23.4(C)	Relative Humidity:	52%RH
Test Voltage	AC 120V/60Hz	Polarization:	Horizontal
Test Mode	Mode 1~24(Mode 10 worst mode)		

No.	Frequency (MHz)	Reading (dBuV)	Correct Factor(dB/m)	Result (dBuV/m)	Limit (dBuV/m)	Margin (dB)	Remark
1	143.4900	55.58	-18.23	37.35	43.50	-6.15	QP
2	206.5400	56.06	-20.63	35.43	43.50	-8.07	QP
3	431.5800	45.78	-10.13	35.65	46.00	-10.35	QP
4	623.6400	44.34	-5.33	39.01	46.00	-6.99	QP
5	742.9500	43.86	-2.13	41.73	46.00	-4.27	QP
6	998.0600	40.45	2.04	42.49	54.00	-11.51	QP

Remark:

1. Margin = Result (Result =Reading + Factor )–Limit

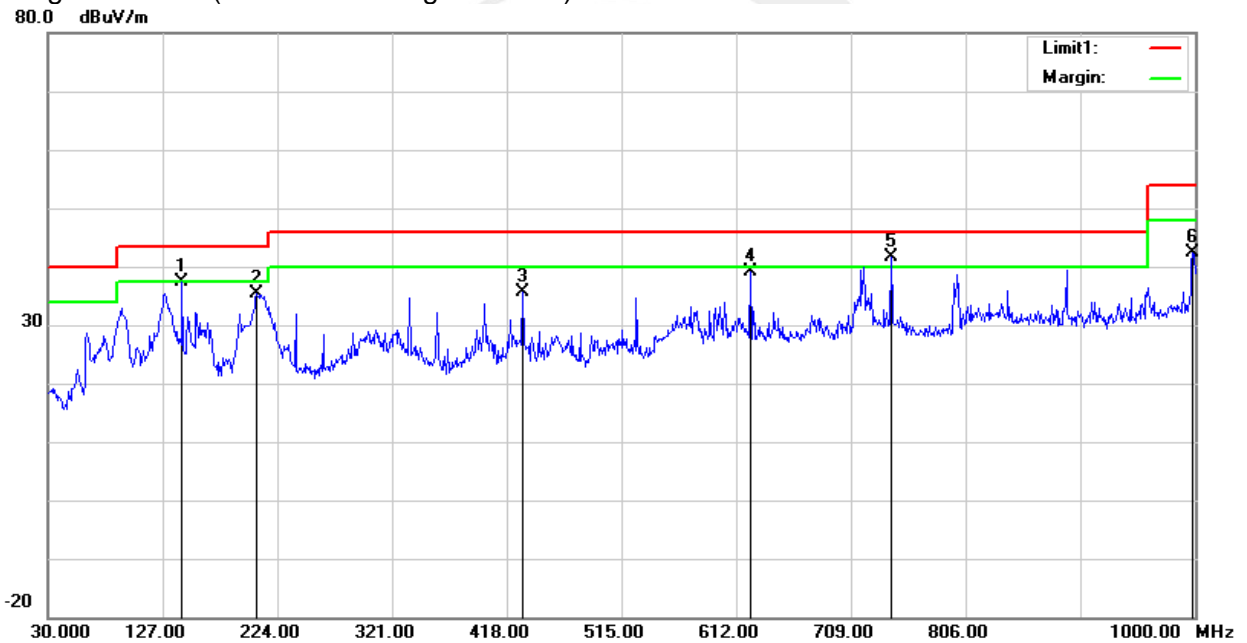



Temperature	23.4(C)	Relative Humidity:	52%RH
Test Voltage	AC 120V/60Hz	Polarization:	Vertical
Test Mode	Mode 1~24 (Mode 10 worst mode)		

No.	Frequency (MHz)	Reading (dBuV)	Correct Factor(dB/m)	Result (dBuV/m)	Limit (dBuV/m)	Margin (dB)	Remark
1	93.0500	57.37	-21.04	36.33	43.50	-7.17	QP
2	239.5200	52.17	-18.10	34.07	46.00	-11.93	QP
3	335.5500	46.38	-13.54	32.84	46.00	-13.16	QP
4	624.6100	40.33	-5.29	35.04	46.00	-10.96	QP
5	797.2700	41.23	-2.03	39.20	46.00	-6.80	QP
6	998.0600	35.63	2.04	37.67	54.00	-16.33	QP

Remark:

1. Margin = Result (Result = Reading + Factor )–Limit

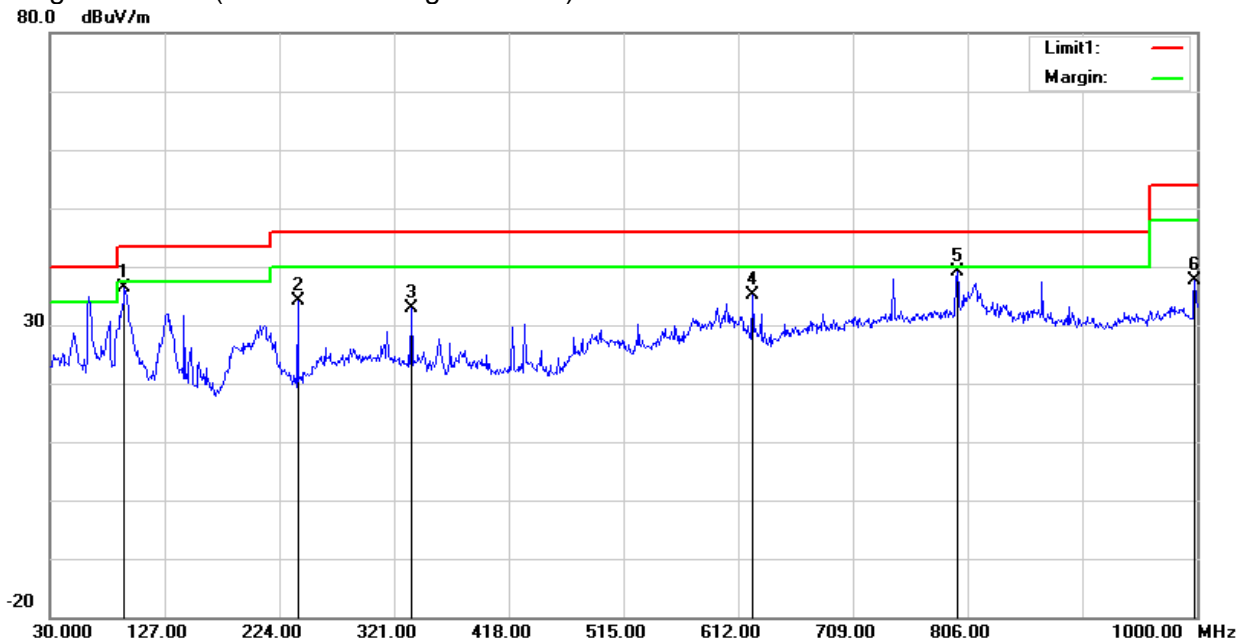



## 3.2.8 TEST RESULTS (Above 1000 MHz)

## Band I 5150-5250MHz

Frequency (MHz)	Reading (dBuV)	Amplifier (dB)	Loss (dB)	Antenna Factor (dB/m)	Corrected Factor (dB)	Emission Level (dBμV/m)	Limit (dBuV/m)	Margin (dB)	Detector	Comment
Low Channel (802.11a/ 5180 MHz)										
3246.18	44.43	44.70	6.70	28.20	-9.80	34.63	68.20	-33.57	Pk	Vertical
3246.18	41.31	44.70	6.70	28.20	-9.80	31.51	54.00	-22.49	AV	Vertical
3253.42	44.94	44.70	6.70	28.20	-9.80	35.14	68.20	-33.06	Pk	Horizontal
3253.42	41.97	44.70	6.70	28.20	-9.80	32.17	54.00	-21.83	AV	Horizontal
3997.21	39.56	44.20	7.90	29.70	-6.60	32.96	68.20	-35.24	Pk	Vertical
3997.21	36.90	44.20	7.90	29.70	-6.60	30.30	54.00	-23.70	AV	Vertical
3981.84	39.54	44.20	7.90	29.70	-6.60	32.94	68.20	-35.26	Pk	Horizontal
3981.84	35.99	44.20	7.90	29.70	-6.60	29.39	54.00	-24.61	AV	Horizontal
7231.16	37.59	43.50	11.40	35.50	3.40	40.99	68.20	-27.21	Pk	Vertical
7231.16	34.78	43.50	11.40	35.50	3.40	38.18	54.00	-15.82	AV	Vertical
7227.59	37.88	43.50	11.40	35.50	3.40	41.28	68.20	-26.92	Pk	Horizontal
7227.59	34.79	43.50	11.40	35.50	3.40	38.19	54.00	-15.81	AV	Horizontal
10360.32	38.76	44.50	13.80	38.80	8.10	46.86	68.20	-21.34	Pk	Vertical
10360.32	36.13	44.50	13.80	38.80	8.10	44.23	54.00	-9.77	AV	Vertical
10360.37	39.98	44.50	13.80	38.80	8.10	48.08	68.20	-20.12	Pk	Horizontal
10360.37	36.57	44.50	13.80	38.80	8.10	44.67	54.00	-9.33	AV	Horizontal
11035.74	32.93	43.60	14.30	39.50	10.20	43.13	68.20	-25.07	Pk	Vertical
11035.74	30.95	43.60	14.30	39.50	10.20	41.15	54.00	-12.85	AV	Vertical
11027.25	33.23	43.60	14.30	39.50	10.20	43.43	68.20	-24.77	Pk	Horizontal
11027.25	30.35	43.60	14.30	39.50	10.20	40.55	54.00	-13.45	AV	Horizontal
13286.10	32.55	42.60	15.90	38.90	12.20	44.75	68.20	-23.45	Pk	Vertical
13286.10	29.29	42.60	15.90	38.90	12.20	41.49	54.00	-12.51	AV	Vertical
13292.93	31.59	42.60	15.90	38.90	12.20	43.79	68.20	-24.41	Pk	Horizontal
13292.93	29.89	42.60	15.90	38.90	12.20	42.09	54.00	-11.91	AV	Horizontal



Mid Channel (802.11a/ 5200 MHz)										
3251.08	44.94	44.70	6.70	28.20	-9.80	35.14	68.20	-33.06	Pk	Vertical
3251.08	41.72	44.70	6.70	28.20	-9.80	31.92	54.00	-22.08	AV	Vertical
3258.70	45.24	44.70	6.70	28.20	-9.80	35.44	68.20	-32.76	Pk	Horizontal
3258.70	41.30	44.70	6.70	28.20	-9.80	31.50	54.00	-22.50	AV	Horizontal
3998.72	39.18	44.20	7.90	29.70	-6.60	32.58	68.20	-35.62	Pk	Vertical
3998.72	36.38	44.20	7.90	29.70	-6.60	29.78	54.00	-24.22	AV	Vertical
3995.89	38.65	44.20	7.90	29.70	-6.60	32.05	68.20	-36.15	Pk	Horizontal
3995.89	35.90	44.20	7.90	29.70	-6.60	29.30	54.00	-24.70	AV	Horizontal
7225.83	37.39	43.50	11.40	35.50	3.40	40.79	68.20	-27.41	Pk	Vertical
7225.83	34.37	43.50	11.40	35.50	3.40	37.77	54.00	-16.23	AV	Vertical
7220.60	36.63	43.50	11.40	35.50	3.40	40.03	68.20	-28.17	Pk	Horizontal
7220.60	34.34	43.50	11.40	35.50	3.40	37.74	54.00	-16.26	AV	Horizontal
10400.32	39.42	44.50	13.80	38.80	8.10	47.52	68.20	-20.68	Pk	Vertical
10400.32	35.78	44.50	13.80	38.80	8.10	43.88	54.00	-10.12	AV	Vertical
10400.07	39.19	44.50	13.80	38.80	8.10	47.29	68.20	-20.91	Pk	Horizontal
10400.07	35.70	44.50	13.80	38.80	8.10	43.80	54.00	-10.20	AV	Horizontal
11021.92	33.06	43.60	14.30	39.50	10.20	43.26	68.20	-24.94	Pk	Vertical
11021.92	31.01	43.60	14.30	39.50	10.20	41.21	54.00	-12.79	AV	Vertical
11032.04	33.75	43.60	14.30	39.50	10.20	43.95	68.20	-24.25	Pk	Horizontal
11032.04	30.25	43.60	14.30	39.50	10.20	40.45	54.00	-13.55	AV	Horizontal
13298.82	32.05	42.60	15.90	38.90	12.20	44.25	68.20	-23.95	Pk	Vertical
13298.82	28.98	42.60	15.90	38.90	12.20	41.18	54.00	-12.82	AV	Vertical
13290.71	31.98	42.60	15.90	38.90	12.20	44.18	68.20	-24.02	Pk	Horizontal
13290.71	29.27	42.60	15.90	38.90	12.20	41.47	54.00	-12.53	AV	Horizontal





High Channel (802.11a/ 5240 MHz)										
3255.58	45.17	44.70	6.70	28.20	-9.80	35.37	68.20	-32.83	Pk	Vertical
3255.58	41.24	44.70	6.70	28.20	-9.80	31.44	54.00	-22.56	AV	Vertical
3252.56	44.41	44.70	6.70	28.20	-9.80	34.61	68.20	-33.59	Pk	Horizontal
3252.56	41.86	44.70	6.70	28.20	-9.80	32.06	54.00	-21.94	AV	Horizontal
3981.84	40.02	44.20	7.90	29.70	-6.60	33.42	68.20	-34.78	Pk	Vertical
3981.84	37.05	44.20	7.90	29.70	-6.60	30.45	54.00	-23.55	AV	Vertical
3989.86	39.82	44.20	7.90	29.70	-6.60	33.22	68.20	-34.98	Pk	Horizontal
3989.86	36.58	44.20	7.90	29.70	-6.60	29.98	54.00	-24.02	AV	Horizontal
7219.33	37.13	43.50	11.40	35.50	3.40	40.53	68.20	-27.67	Pk	Vertical
7219.33	33.53	43.50	11.40	35.50	3.40	36.93	54.00	-17.07	AV	Vertical
7218.48	37.03	43.50	11.40	35.50	3.40	40.43	68.20	-27.77	Pk	Horizontal
7218.48	33.92	43.50	11.40	35.50	3.40	37.32	54.00	-16.68	AV	Horizontal
10479.95	38.89	44.50	13.80	38.80	8.10	46.99	68.20	-21.21	Pk	Vertical
10479.95	37.03	44.50	13.80	38.80	8.10	45.13	54.00	-8.87	AV	Vertical
10480.04	38.69	44.50	13.80	38.80	8.10	46.79	68.20	-21.41	Pk	Horizontal
10480.04	37.01	44.50	13.80	38.80	8.10	45.11	54.00	-8.89	AV	Horizontal
11034.36	32.84	43.60	14.30	39.50	10.20	43.04	68.20	-25.16	Pk	Vertical
11034.36	29.73	43.60	14.30	39.50	10.20	39.93	54.00	-14.07	AV	Vertical
11034.68	33.41	43.60	14.30	39.50	10.20	43.61	68.20	-24.59	Pk	Horizontal
11034.68	30.41	43.60	14.30	39.50	10.20	40.61	54.00	-13.39	AV	Horizontal
13290.70	32.19	42.60	15.90	38.90	12.20	44.39	68.20	-23.81	Pk	Vertical
13290.70	30.01	42.60	15.90	38.90	12.20	42.21	54.00	-11.79	AV	Vertical
13288.81	32.88	42.60	15.90	38.90	12.20	45.08	68.20	-23.12	Pk	Horizontal
13288.81	29.98	42.60	15.90	38.90	12.20	42.18	54.00	-11.82	AV	Horizontal

## Remark:

- Factor = Antenna Factor + Cable Loss – Pre-amplifier.
- Scan with 802.11a,802.11n (HT-20),802.11n (HT-40), 802.11ac (VHT-20),802.11ac (VHT-40), 802.11ac (VHT-80) the worst case is 802.11a.
- The frequency emission of peak points that did not show above the forms are at least 20dB below the limit, the frequency emission is mainly from the environment noise.



## Band II 5250-5350MHz

Frequency (MHz)	Reading	Amplifier	Loss	Antenna Factor	Orrected Factor	Emission Level	Limit (dBuV/m)	Margin	Detector	Comment
	(dBuV)	(dB)	(dB)	(dB/m)	(dB)	(dBuV/m)		(dB)		
Low Channel (802.11a/ 5260 MHz)										
3258.27	44.92	44.70	6.70	28.20	-9.80	35.12	68.20	-33.08	Pk	Vertical
3258.27	41.87	44.70	6.70	28.20	-9.80	32.07	54.00	-21.93	AV	Vertical
3252.28	44.14	44.70	6.70	28.20	-9.80	34.34	68.20	-33.86	Pk	Horizontal
3252.28	41.93	44.70	6.70	28.20	-9.80	32.13	54.00	-21.87	AV	Horizontal
3994.30	39.91	44.20	7.90	29.70	-6.60	33.31	68.20	-34.89	Pk	Vertical
3994.30	36.52	44.20	7.90	29.70	-6.60	29.92	54.00	-24.08	AV	Vertical
3983.29	39.57	44.20	7.90	29.70	-6.60	32.97	68.20	-35.23	Pk	Horizontal
3983.29	36.14	44.20	7.90	29.70	-6.60	29.54	54.00	-24.46	AV	Horizontal
7227.54	36.87	43.50	11.40	35.50	3.40	40.27	68.20	-27.93	Pk	Vertical
7227.54	33.67	43.50	11.40	35.50	3.40	37.07	54.00	-16.93	AV	Vertical
7222.31	37.58	43.50	11.40	35.50	3.40	40.98	68.20	-27.22	Pk	Horizontal
7222.31	33.67	43.50	11.40	35.50	3.40	37.07	54.00	-16.93	AV	Horizontal
10520.29	39.70	44.50	13.90	38.80	8.20	47.90	68.20	-20.30	Pk	Vertical
10520.29	35.95	44.50	13.90	38.80	8.20	44.15	54.00	-9.85	AV	Vertical
10519.98	39.17	44.50	13.90	38.80	8.20	47.37	68.20	-20.83	Pk	Horizontal
10519.98	36.27	44.50	13.90	38.80	8.20	44.47	54.00	-9.53	AV	Horizontal
11023.82	32.89	43.60	14.30	39.50	10.20	43.09	68.20	-25.11	Pk	Vertical
11023.82	30.25	43.60	14.30	39.50	10.20	40.45	54.00	-13.55	AV	Vertical
11029.58	32.82	43.60	14.30	39.50	10.20	43.02	68.20	-25.18	Pk	Horizontal
11029.58	30.58	43.60	14.30	39.50	10.20	40.78	54.00	-13.22	AV	Horizontal
13293.73	31.58	42.60	15.90	38.90	12.20	43.78	68.20	-24.42	Pk	Vertical
13293.73	29.63	42.60	15.90	38.90	12.20	41.83	54.00	-12.17	AV	Vertical
13288.71	32.38	42.60	15.90	38.90	12.20	44.58	68.20	-23.62	Pk	Horizontal
13288.71	29.95	42.60	15.90	38.90	12.20	42.15	54.00	-11.85	AV	Horizontal







Mid Channel (802.11a/ 5300 MHz)										
3257.36	44.18	44.70	6.70	28.20	-9.80	34.38	68.20	-33.82	Pk	Vertical
3257.36	40.93	44.70	6.70	28.20	-9.80	31.13	54.00	-22.87	AV	Vertical
3252.49	44.70	44.70	6.70	28.20	-9.80	34.90	68.20	-33.30	Pk	Horizontal
3252.49	40.84	44.70	6.70	28.20	-9.80	31.04	54.00	-22.96	AV	Horizontal
3981.19	39.18	44.20	7.90	29.70	-6.60	32.58	68.20	-35.62	Pk	Vertical
3981.19	35.89	44.20	7.90	29.70	-6.60	29.29	54.00	-24.71	AV	Vertical
3991.16	39.73	44.20	7.90	29.70	-6.60	33.13	68.20	-35.07	Pk	Horizontal
3991.16	35.78	44.20	7.90	29.70	-6.60	29.18	54.00	-24.82	AV	Horizontal
7216.44	37.54	43.50	11.40	35.50	3.40	40.94	68.20	-27.26	Pk	Vertical
7216.44	34.28	43.50	11.40	35.50	3.40	37.68	54.00	-16.32	AV	Vertical
7233.55	36.53	43.50	11.40	35.50	3.40	39.93	68.20	-28.27	Pk	Horizontal
7233.55	33.76	43.50	11.40	35.50	3.40	37.16	54.00	-16.84	AV	Horizontal
10599.94	39.79	44.50	13.80	38.80	8.10	47.89	68.20	-20.31	Pk	Vertical
10599.94	35.86	44.50	13.80	38.80	8.10	43.96	54.00	-10.04	AV	Vertical
10600.15	40.05	44.50	13.80	38.80	8.10	48.15	68.20	-20.05	Pk	Horizontal
10600.15	37.13	44.50	13.80	38.80	8.10	45.23	54.00	-8.77	AV	Horizontal
11029.03	33.61	43.60	14.30	39.50	10.20	43.81	68.20	-24.39	Pk	Vertical
11029.03	30.67	43.60	14.30	39.50	10.20	40.87	54.00	-13.13	AV	Vertical
11031.33	33.56	43.60	14.30	39.50	10.20	43.76	68.20	-24.44	Pk	Horizontal
11031.33	29.77	43.60	14.30	39.50	10.20	39.97	54.00	-14.03	AV	Horizontal
13289.91	32.40	42.60	15.90	38.90	12.20	44.60	68.20	-23.60	Pk	Vertical
13289.91	28.84	42.60	15.90	38.90	12.20	41.04	54.00	-12.96	AV	Vertical
13297.26	32.95	42.60	15.90	38.90	12.20	45.15	68.20	-23.05	Pk	Horizontal
13297.26	28.89	42.60	15.90	38.90	12.20	41.09	54.00	-12.91	AV	Horizontal





Mid Channel (802.11a/ 5300 MHz)										
3257.36	44.18	44.70	6.70	28.20	-9.80	34.38	68.20	-33.82	Pk	Vertical
3257.36	40.93	44.70	6.70	28.20	-9.80	31.13	54.00	-22.87	AV	Vertical
3252.49	44.70	44.70	6.70	28.20	-9.80	34.90	68.20	-33.30	Pk	Horizontal
3252.49	40.84	44.70	6.70	28.20	-9.80	31.04	54.00	-22.96	AV	Horizontal
3981.19	39.18	44.20	7.90	29.70	-6.60	32.58	68.20	-35.62	Pk	Vertical
3981.19	35.89	44.20	7.90	29.70	-6.60	29.29	54.00	-24.71	AV	Vertical
3991.16	39.73	44.20	7.90	29.70	-6.60	33.13	68.20	-35.07	Pk	Horizontal
3991.16	35.78	44.20	7.90	29.70	-6.60	29.18	54.00	-24.82	AV	Horizontal
7216.44	37.54	43.50	11.40	35.50	3.40	40.94	68.20	-27.26	Pk	Vertical
7216.44	34.28	43.50	11.40	35.50	3.40	37.68	54.00	-16.32	AV	Vertical
7233.55	36.53	43.50	11.40	35.50	3.40	39.93	68.20	-28.27	Pk	Horizontal
7233.55	33.76	43.50	11.40	35.50	3.40	37.16	54.00	-16.84	AV	Horizontal
10599.94	39.79	44.50	13.80	38.80	8.10	47.89	68.20	-20.31	Pk	Vertical
10599.94	35.86	44.50	13.80	38.80	8.10	43.96	54.00	-10.04	AV	Vertical
10600.15	40.05	44.50	13.80	38.80	8.10	48.15	68.20	-20.05	Pk	Horizontal
10600.15	37.13	44.50	13.80	38.80	8.10	45.23	54.00	-8.77	AV	Horizontal
11029.03	33.61	43.60	14.30	39.50	10.20	43.81	68.20	-24.39	Pk	Vertical
11029.03	30.67	43.60	14.30	39.50	10.20	40.87	54.00	-13.13	AV	Vertical
11031.33	33.56	43.60	14.30	39.50	10.20	43.76	68.20	-24.44	Pk	Horizontal
11031.33	29.77	43.60	14.30	39.50	10.20	39.97	54.00	-14.03	AV	Horizontal
13289.91	32.40	42.60	15.90	38.90	12.20	44.60	68.20	-23.60	Pk	Vertical
13289.91	28.84	42.60	15.90	38.90	12.20	41.04	54.00	-12.96	AV	Vertical
13297.26	32.95	42.60	15.90	38.90	12.20	45.15	68.20	-23.05	Pk	Horizontal
13297.26	28.89	42.60	15.90	38.90	12.20	41.09	54.00	-12.91	AV	Horizontal

## Remark:

1. Factor = Antenna Factor + Cable Loss – Pre-amplifier.
2. Scan with 802.11a,802.11n (HT-20),802.11n (HT-40), 802.11ac (VHT-20),802.11ac (VHT-40), 802.11ac (VHT-80) the worst case is 802.11n (HT-20).
3. The frequency emission of peak points that did not show above the forms are at least 20dB below the limit, the frequency emission is mainly from the environment noise.



## Band III 5470-5725MHz

Frequency (MHz)	Reading	Amplifier	Loss	Antenna Factor	Orrected Factor	Emission Level	Limit (dBuV/m)	Margin	Detector	Comment
	(dBuV)	(dB)	(dB)	(dB/m)	(dB)	(dBuV/m)		(dB)		
Low Channel (802.11ac/ 5500 MHz)										
3262.21	44.05	44.70	6.70	28.20	-9.80	34.25	68.20	-33.95	Pk	Vertical
3262.21	41.22	44.70	6.70	28.20	-9.80	31.42	54.00	-22.58	AV	Vertical
3251.05	43.87	44.70	6.70	28.20	-9.80	34.07	68.20	-34.13	Pk	Horizontal
3251.05	42.15	44.70	6.70	28.20	-9.80	32.35	54.00	-21.65	AV	Horizontal
3996.14	39.14	44.20	7.90	29.70	-6.60	32.54	68.20	-35.66	Pk	Vertical
3996.14	36.95	44.20	7.90	29.70	-6.60	30.35	54.00	-23.65	AV	Vertical
3998.95	40.09	44.20	7.90	29.70	-6.60	33.49	68.20	-34.71	Pk	Horizontal
3998.95	36.95	44.20	7.90	29.70	-6.60	30.35	54.00	-23.65	AV	Horizontal
7232.95	36.67	43.50	11.40	35.50	3.40	40.07	68.20	-28.13	Pk	Vertical
7232.95	34.49	43.50	11.40	35.50	3.40	37.89	54.00	-16.11	AV	Vertical
7232.30	37.47	43.50	11.40	35.50	3.40	40.87	68.20	-27.33	Pk	Horizontal
7232.30	33.75	43.50	11.40	35.50	3.40	37.15	54.00	-16.85	AV	Horizontal
10344.72	38.71	44.50	13.80	38.80	8.10	46.81	68.20	-21.39	Pk	Vertical
10344.72	36.79	44.50	13.80	38.80	8.10	44.89	54.00	-9.11	AV	Vertical
10347.80	39.08	44.50	13.80	38.80	8.10	47.18	68.20	-21.02	Pk	Horizontal
10347.80	36.53	44.50	13.80	38.80	8.10	44.63	54.00	-9.37	AV	Horizontal
11000.14	34.08	43.60	14.30	39.50	10.20	44.28	68.20	-23.92	Pk	Vertical
11000.14	30.43	43.60	14.30	39.50	10.20	40.63	54.00	-13.37	AV	Vertical
10999.99	33.63	43.60	14.30	39.50	10.20	43.83	68.20	-24.37	Pk	Horizontal
10999.99	30.73	43.60	14.30	39.50	10.20	40.93	54.00	-13.07	AV	Horizontal
13292.23	32.38	42.60	15.90	38.90	12.20	44.58	68.20	-23.62	Pk	Vertical
13292.23	28.60	42.60	15.90	38.90	12.20	40.80	54.00	-13.20	AV	Vertical
13293.95	31.64	42.60	15.90	38.90	12.20	43.84	68.20	-24.36	Pk	Horizontal
13293.95	29.83	42.60	15.90	38.90	12.20	42.03	54.00	-11.97	AV	Horizontal





Mid Channel (802.11ac/ 5580 MHz)										
3262.33	44.10	44.70	6.70	28.20	-9.80	34.30	68.20	-33.90	Pk	Vertical
3262.33	42.22	44.70	6.70	28.20	-9.80	32.42	54.00	-21.58	AV	Vertical
3251.61	45.07	44.70	6.70	28.20	-9.80	35.27	68.20	-32.93	Pk	Horizontal
3251.61	41.59	44.70	6.70	28.20	-9.80	31.79	54.00	-22.21	AV	Horizontal
3985.96	39.06	44.20	7.90	29.70	-6.60	32.46	68.20	-35.74	Pk	Vertical
3985.96	36.19	44.20	7.90	29.70	-6.60	29.59	54.00	-24.41	AV	Vertical
3984.72	39.81	44.20	7.90	29.70	-6.60	33.21	68.20	-34.99	Pk	Horizontal
3984.72	36.37	44.20	7.90	29.70	-6.60	29.77	54.00	-24.23	AV	Horizontal
7220.64	36.82	43.50	11.40	35.50	3.40	40.22	68.20	-27.98	Pk	Vertical
7220.64	33.86	43.50	11.40	35.50	3.40	37.26	54.00	-16.74	AV	Vertical
7230.54	37.15	43.50	11.40	35.50	3.40	40.55	68.20	-27.65	Pk	Horizontal
7230.54	33.73	43.50	11.40	35.50	3.40	37.13	54.00	-16.87	AV	Horizontal
10395.63	39.53	44.50	13.80	38.80	8.10	47.63	68.20	-20.57	Pk	Vertical
10395.63	35.94	44.50	13.80	38.80	8.10	44.04	54.00	-9.96	AV	Vertical
10393.00	39.40	44.50	13.80	38.80	8.10	47.50	68.20	-20.70	Pk	Horizontal
10393.00	35.95	44.50	13.80	38.80	8.10	44.05	54.00	-9.95	AV	Horizontal
11160.15	32.81	43.60	14.30	39.50	10.20	43.01	68.20	-25.19	Pk	Vertical
11160.15	30.75	43.60	14.30	39.50	10.20	40.95	54.00	-13.05	AV	Vertical
11160.27	33.61	43.60	14.30	39.50	10.20	43.81	68.20	-24.39	Pk	Horizontal
11160.27	30.14	43.60	14.30	39.50	10.20	40.34	54.00	-13.66	AV	Horizontal
13290.36	32.64	42.60	15.90	38.90	12.20	44.84	68.20	-23.36	Pk	Vertical
13290.36	29.33	42.60	15.90	38.90	12.20	41.53	54.00	-12.47	AV	Vertical
13295.70	32.43	42.60	15.90	38.90	12.20	44.63	68.20	-23.57	Pk	Horizontal
13295.70	28.80	42.60	15.90	38.90	12.20	41.00	54.00	-13.00	AV	Horizontal





High Channel (802.11ac/ 5700 MHz)										
3258.47	44.91	44.70	6.70	28.20	-9.80	35.11	68.20	-33.09	Pk	Vertical
3258.47	40.80	44.70	6.70	28.20	-9.80	31.00	54.00	-23.00	AV	Vertical
3254.93	44.61	44.70	6.70	28.20	-9.80	34.81	68.20	-33.39	Pk	Horizontal
3254.93	40.78	44.70	6.70	28.20	-9.80	30.98	54.00	-23.02	AV	Horizontal
3986.57	38.69	44.20	7.90	29.70	-6.60	32.09	68.20	-36.11	Pk	Vertical
3986.57	37.13	44.20	7.90	29.70	-6.60	30.53	54.00	-23.47	AV	Vertical
3995.83	39.80	44.20	7.90	29.70	-6.60	33.20	68.20	-35.00	Pk	Horizontal
3995.83	36.71	44.20	7.90	29.70	-6.60	30.11	54.00	-23.89	AV	Horizontal
7235.03	36.59	43.50	11.40	35.50	3.40	39.99	68.20	-28.21	Pk	Vertical
7235.03	34.58	43.50	11.40	35.50	3.40	37.98	54.00	-16.02	AV	Vertical
7227.91	37.73	43.50	11.40	35.50	3.40	41.13	68.20	-27.07	Pk	Horizontal
7227.91	34.69	43.50	11.40	35.50	3.40	38.09	54.00	-15.91	AV	Horizontal
10477.30	38.71	44.50	13.80	38.80	8.10	46.81	68.20	-21.39	Pk	Vertical
10477.30	35.71	44.50	13.80	38.80	8.10	43.81	54.00	-10.19	AV	Vertical
10473.05	39.96	44.50	13.80	38.80	8.10	48.06	68.20	-20.14	Pk	Horizontal
10473.05	36.04	44.50	13.80	38.80	8.10	44.14	54.00	-9.86	AV	Horizontal
11400.12	34.16	43.60	14.30	39.50	10.20	44.36	68.20	-23.84	Pk	Vertical
11400.12	30.46	43.60	14.30	39.50	10.20	40.66	54.00	-13.34	AV	Vertical
11400.09	33.17	43.60	14.30	39.50	10.20	43.37	68.20	-24.83	Pk	Horizontal
11400.09	30.58	43.60	14.30	39.50	10.20	40.78	54.00	-13.22	AV	Horizontal
13283.96	32.20	42.60	15.90	38.90	12.20	44.40	68.20	-23.80	Pk	Vertical
13283.96	29.76	42.60	15.90	38.90	12.20	41.96	54.00	-12.04	AV	Vertical
13295.32	31.75	42.60	15.90	38.90	12.20	43.95	68.20	-24.25	Pk	Horizontal
13295.32	29.62	42.60	15.90	38.90	12.20	41.82	54.00	-12.18	AV	Horizontal

## Remark:

1. Factor = Antenna Factor + Cable Loss – Pre-amplifier.
2. Scan with 802.11a,802.11n (HT-20),802.11n (HT-40), 802.11ac (VHT-20),802.11ac (VHT-40), 802.11ac (VHT-80) the worst case is 802.11n (HT-20).
3. The frequency emission of peak points that did not show above the forms are at least 20dB below the limit, the frequency emission is mainly from the environment noise.



**Band IV(5.725-5.850) GHz**

Frequency (MHz)	Reading (dBuV)	Amplifier (dB)	Loss (dB)	Antenna Factor (dB/m)	Orrected Factor (dB)	Emission Level (dBμV/m)	Limit (dBuV/m)	Margin (dB)	Detector	Comment
802.11ac80/ 5775 MHz										
3278.72	44.28	44.70	6.70	28.20	-9.80	34.48	68.20	-33.72	Pk	Vertical
3278.72	41.07	44.70	6.70	28.20	-9.80	31.27	54.00	-22.73	AV	Vertical
3281.68	43.91	44.70	6.70	28.20	-9.80	34.11	68.20	-34.09	Pk	Horizontal
3281.68	41.00	44.70	6.70	28.20	-9.80	31.20	54.00	-22.80	AV	Horizontal
4013.65	39.23	44.20	7.90	29.70	-6.60	32.63	68.20	-35.57	Pk	Vertical
4013.65	35.75	44.20	7.90	29.70	-6.60	29.15	54.00	-24.85	AV	Vertical
4020.21	38.98	44.20	7.90	29.70	-6.60	32.38	68.20	-35.82	Pk	Horizontal
4020.21	36.43	44.20	7.90	29.70	-6.60	29.83	54.00	-24.17	AV	Horizontal
7269.22	37.15	43.50	11.40	35.50	3.40	40.55	68.20	-27.65	Pk	Vertical
7269.22	34.75	43.50	11.40	35.50	3.40	38.15	54.00	-15.85	AV	Vertical
7259.07	37.26	43.50	11.40	35.50	3.40	40.66	68.20	-27.54	Pk	Horizontal
7259.07	33.87	43.50	11.40	35.50	3.40	37.27	54.00	-16.73	AV	Horizontal
10559.24	39.62	44.50	13.90	38.80	8.20	47.82	68.20	-20.38	Pk	Vertical
10559.24	36.41	44.50	13.90	38.80	8.20	44.61	54.00	-9.39	AV	Vertical
10565.54	39.93	44.50	13.90	38.80	8.20	48.13	68.20	-20.07	Pk	Horizontal
10565.54	36.93	44.50	13.90	38.80	8.20	45.13	54.00	-8.87	AV	Horizontal
11550.40	33.41	43.60	14.30	39.50	10.20	43.61	68.20	-24.59	Pk	Vertical
11550.40	30.40	43.60	14.30	39.50	10.20	40.60	54.00	-13.40	AV	Vertical
11550.11	33.33	43.60	14.30	39.50	10.20	43.53	68.20	-24.67	Pk	Horizontal
11550.11	29.89	43.60	14.30	39.50	10.20	40.09	54.00	-13.91	AV	Horizontal
13353.59	32.25	42.60	15.90	38.90	12.20	44.45	68.20	-23.75	Pk	Vertical
13353.59	29.75	42.60	15.90	38.90	12.20	41.95	54.00	-12.05	AV	Vertical
13363.38	31.96	42.60	15.90	38.90	12.20	44.16	68.20	-24.04	Pk	Horizontal
13363.38	29.89	42.60	15.90	38.90	12.20	42.09	54.00	-11.91	AV	Horizontal

**Remark:**

- Factor = Antenna Factor + Cable Loss – Pre-amplifier.
- Scan with 802.11a,802.11n (HT-20),802.11n (HT-40), 802.11ac (VHT-20),802.11ac (VHT-40), 802.11ac (VHT-80) the worst case is 802.11ac (VHT-80).
- The frequency emission of peak points that did not show above the forms are at least 20dB below the limit, the frequency emission is mainly from the environment noise.



### 3.2.9 RESTRICTED FREQUENCY BANDS AND BAND EDGE

Band I 5150-5250MHz

802.11ac20 Low  
Horizontal

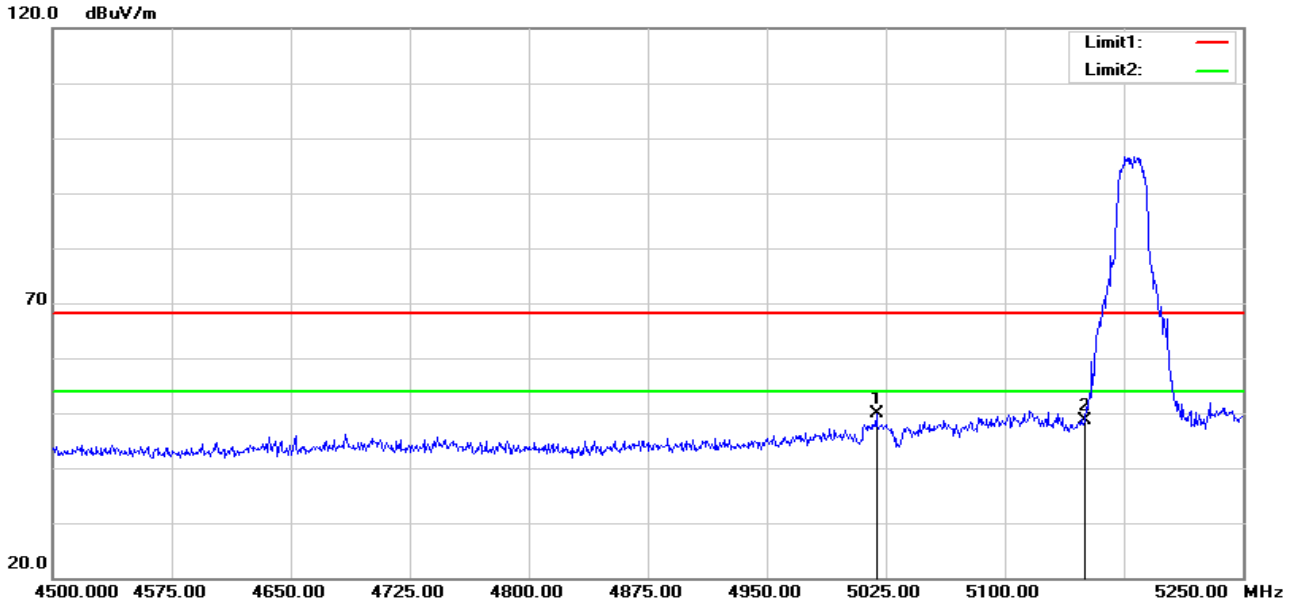

No.	Frequency (MHz)	Reading (dBuV)	Correct Factor(dB/m)	Result (dBuV/m)	Limit (dBuV/m)	Margin (dB)	Remark
1	5019.000	55.94	-6.10	49.84	68.20	-18.36	peak
2	5150.000	54.24	-5.73	48.51	68.20	-19.69	peak

Vertical

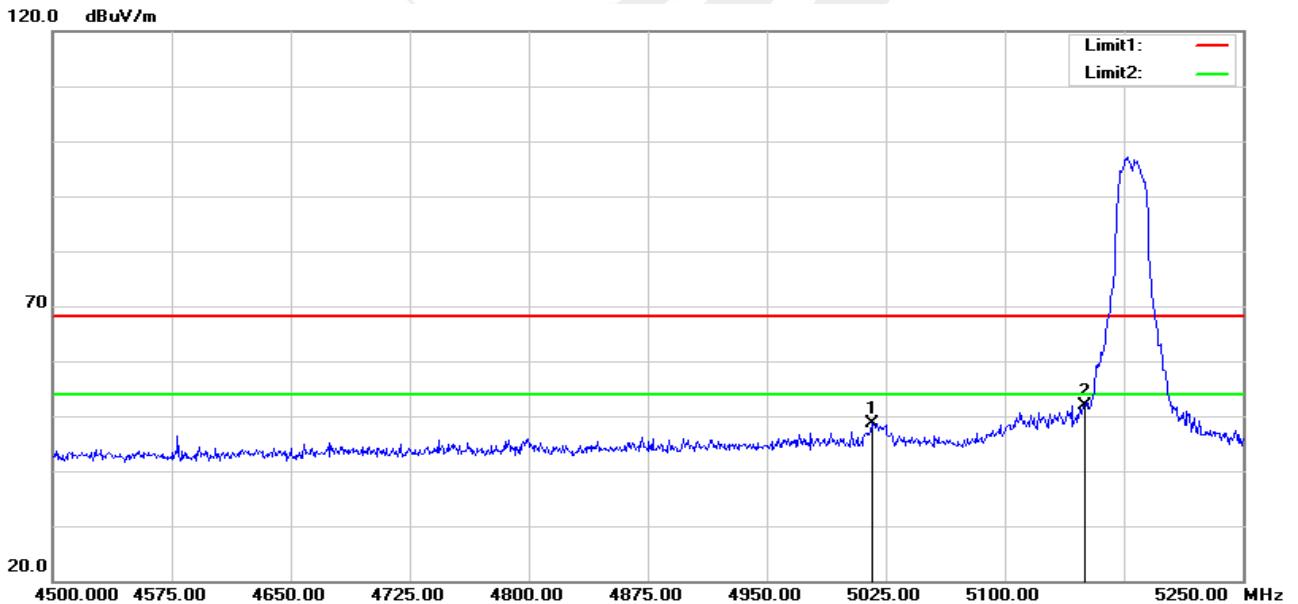

No.	Frequency (MHz)	Reading (dBuV)	Correct Factor(dB/m)	Result (dBuV/m)	Limit (dBuV/m)	Margin (dB)	Remark
1	5016.000	54.69	-6.12	48.57	68.20	-19.63	peak
2	5150.000	57.72	-5.73	51.99	68.20	-16.21	peak



802.11ac20 High  
Horizontal

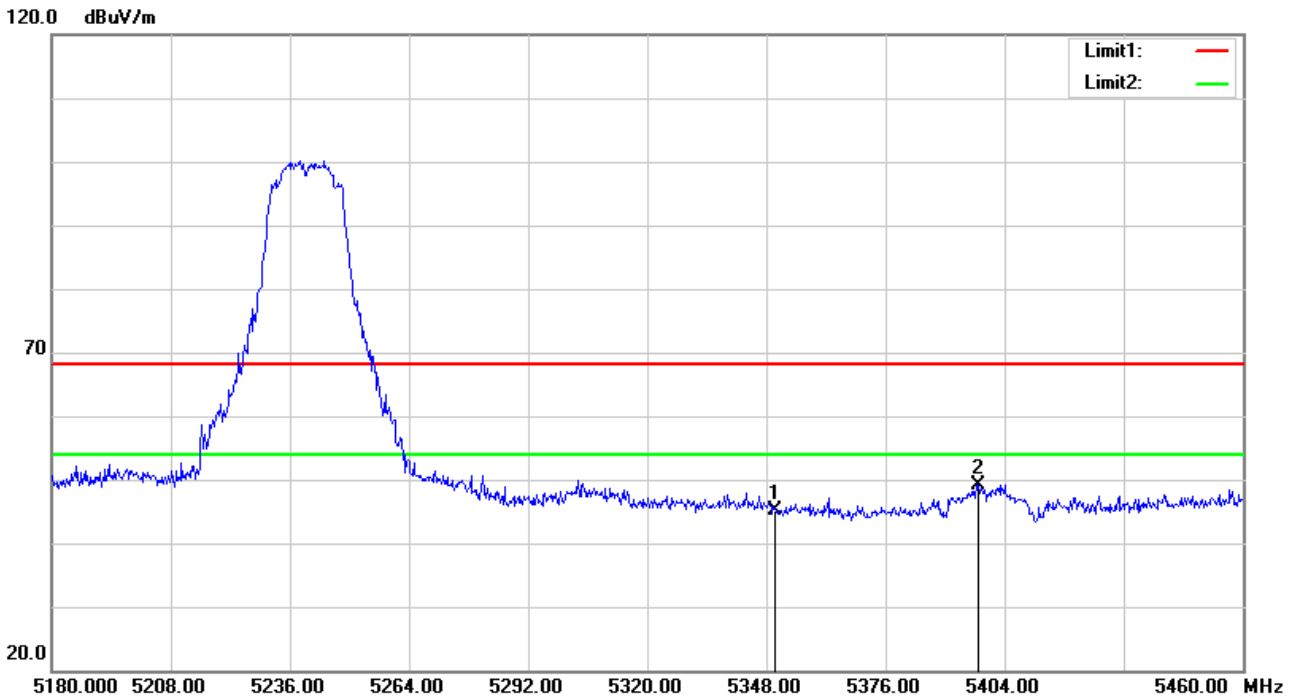

No.	Frequency (MHz)	Reading (dBuV)	Correct Factor(dB/m)	Result (dBuV/m)	Limit (dBuV/m)	Margin (dB)	Remark
1	5350.000	50.27	-5.23	45.04	68.20	-23.16	peak
2	5397.840	54.40	-5.25	49.15	68.20	-19.05	peak

Vertical

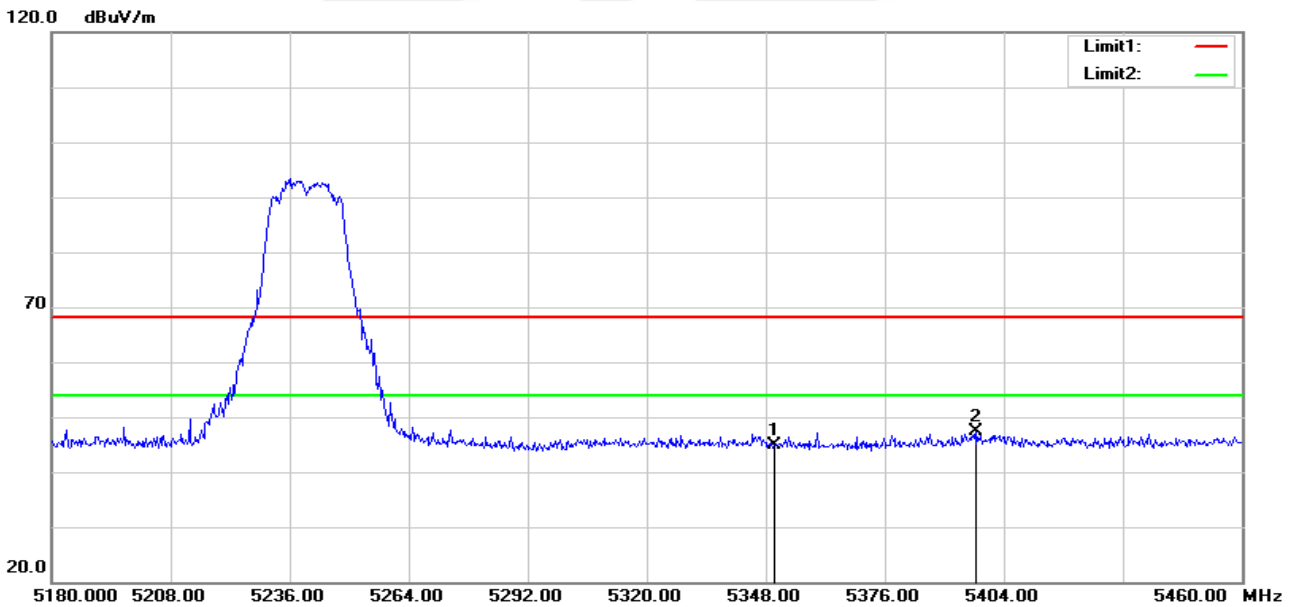

No.	Frequency (MHz)	Reading (dBuV)	Correct Factor(dB/m)	Result (dBuV/m)	Limit (dBuV/m)	Margin (dB)	Remark
1	5350.000	50.23	-5.23	45.00	68.20	-23.20	peak
2	5397.560	52.69	-5.25	47.44	68.20	-20.76	peak

Note: 802.11a,802.11n (HT-20),802.11n (HT-40), 802.11ac (VHT-20),802.11ac (VHT-40), 802.11ac (VHT-80) all has been tested, the worst case is 802.11ac (VHT-20),only shown the worst case.





Band II 5250-5350MHz

802.11a Low  
Horizontal

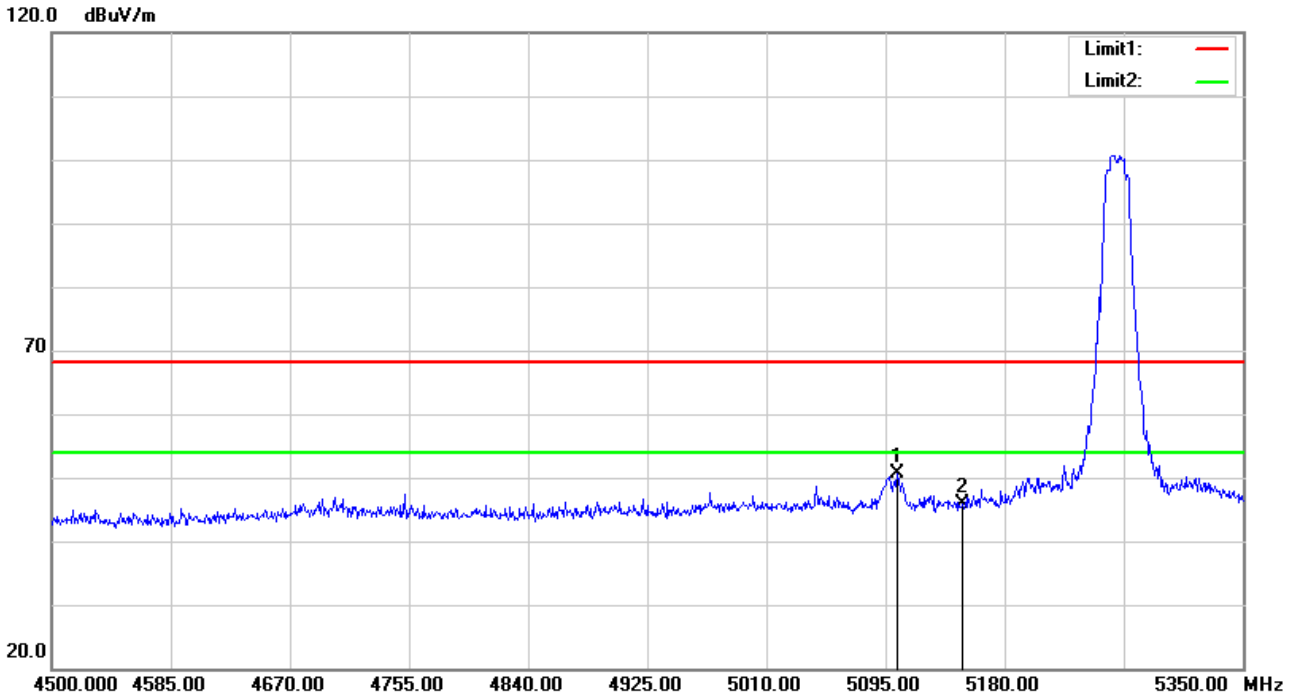

No.	Frequency (MHz)	Reading (dBuV)	Correct Factor(dB/m)	Result (dBuV/m)	Limit (dBuV/m)	Margin (dB)	Remark
1	5103.500	56.32	-5.74	50.58	68.20	-17.62	peak
2	5150.000	51.61	-5.73	45.88	68.20	-22.32	peak

Vertical

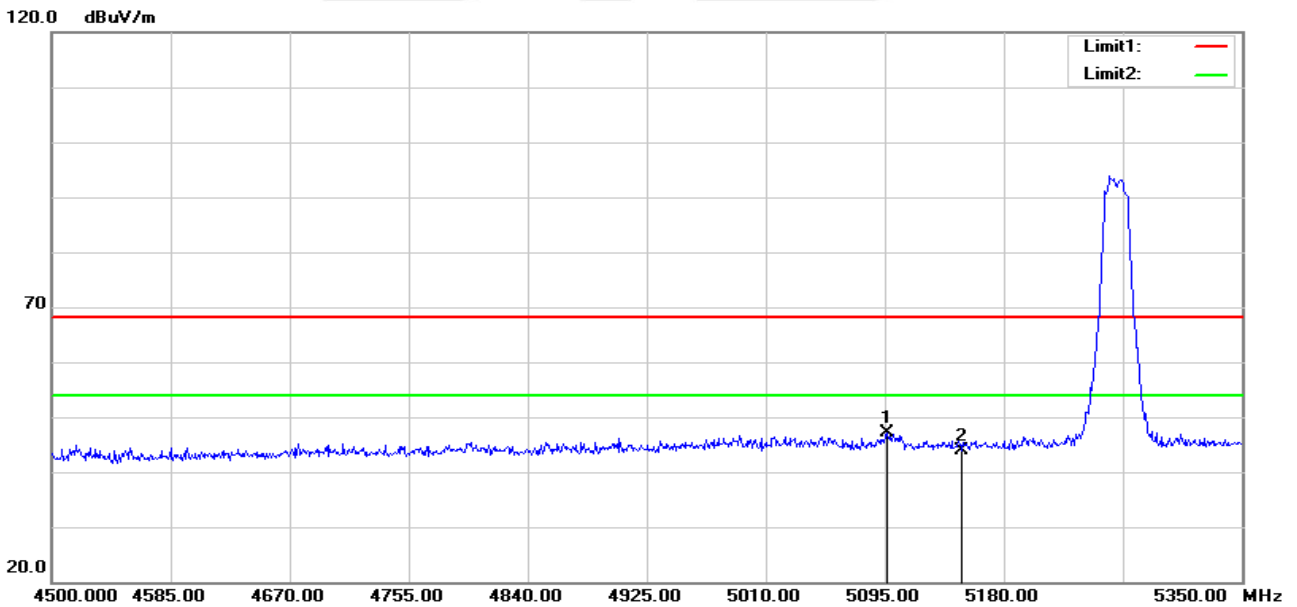

No.	Frequency (MHz)	Reading (dBuV)	Correct Factor(dB/m)	Result (dBuV/m)	Limit (dBuV/m)	Margin (dB)	Remark
1	5096.700	52.92	-5.75	47.17	68.20	-21.03	peak
2	5150.000	49.67	-5.73	43.94	68.20	-24.26	peak



802.11a High  
Horizontal

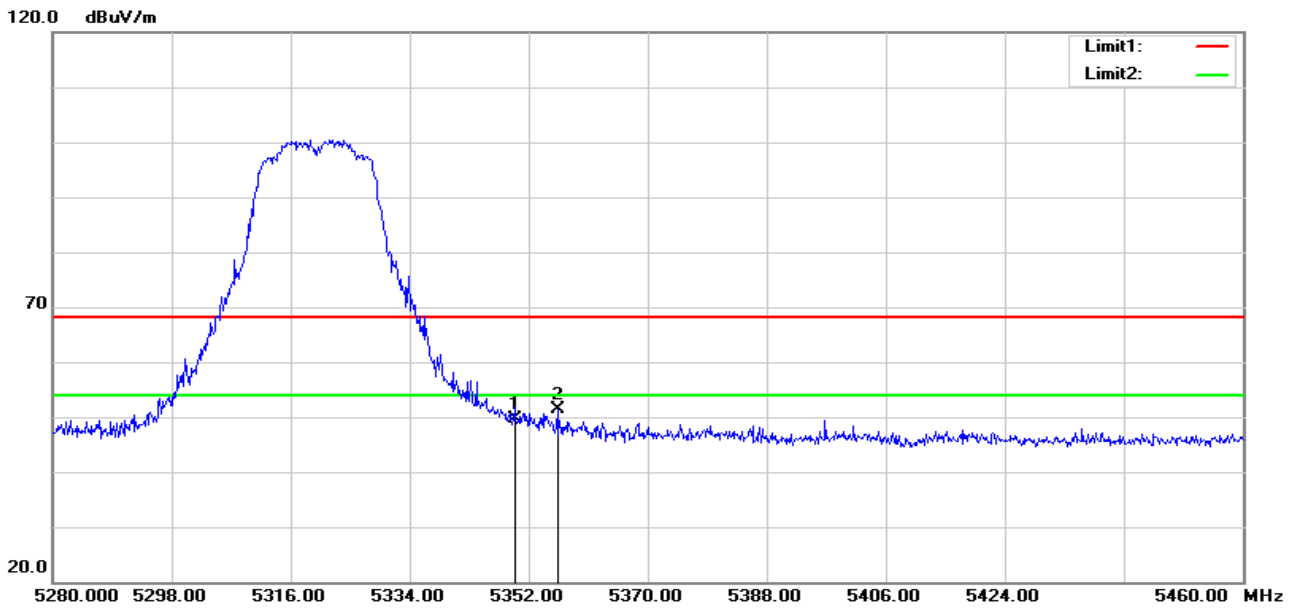

No.	Frequency (MHz)	Reading (dBuV)	Correct Factor(dB/m)	Result (dBuV/m)	Limit (dBuV/m)	Margin (dB)	Remark
1	5350.000	54.89	-5.23	49.66	68.20	-18.54	peak
2	5356.320	56.72	-5.23	51.49	68.20	-16.71	peak

Vertical

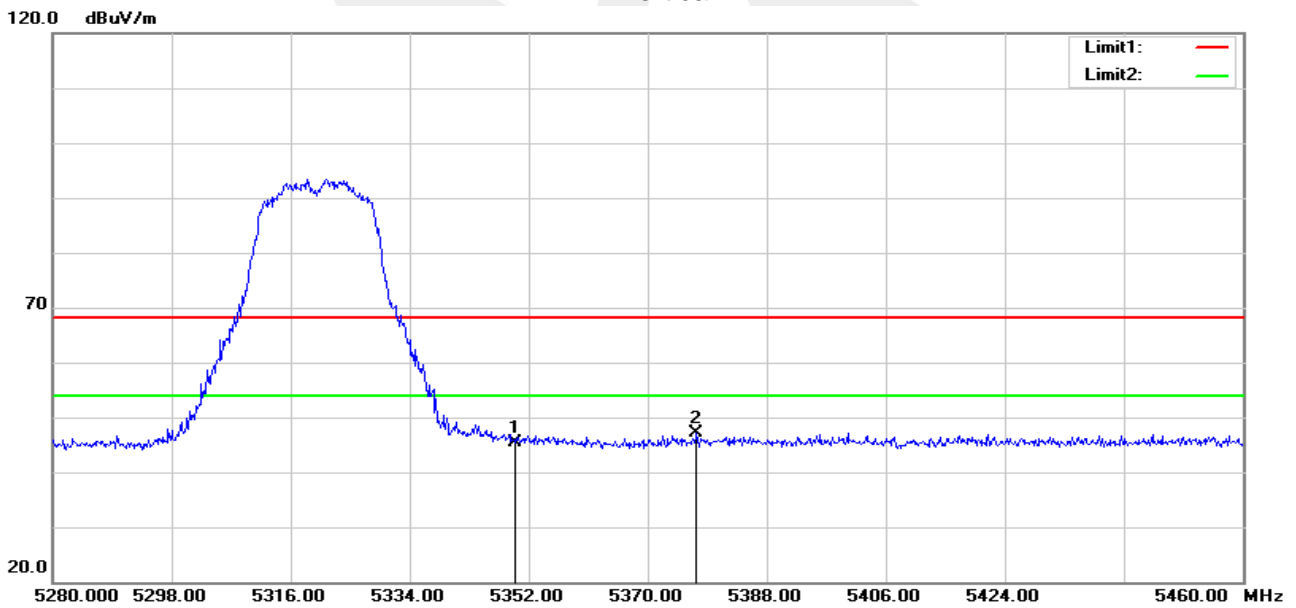

No.	Frequency (MHz)	Reading (dBuV)	Correct Factor(dB/m)	Result (dBuV/m)	Limit (dBuV/m)	Margin (dB)	Remark
1	5350.000	50.69	-5.23	45.46	68.20	-22.74	peak
2	5377.380	52.38	-5.24	47.14	68.20	-21.06	peak

Note: 802.11a,802.11n (HT-20),802.11n (HT-40), 802.11ac (VHT-20),802.11ac (VHT-40), 802.11ac (VHT-80) all has been tested, the worst case is 802.11a,only shown the worst case.



Band III 5470-5725MHz

802.11ac 20 Low  
Horizontal

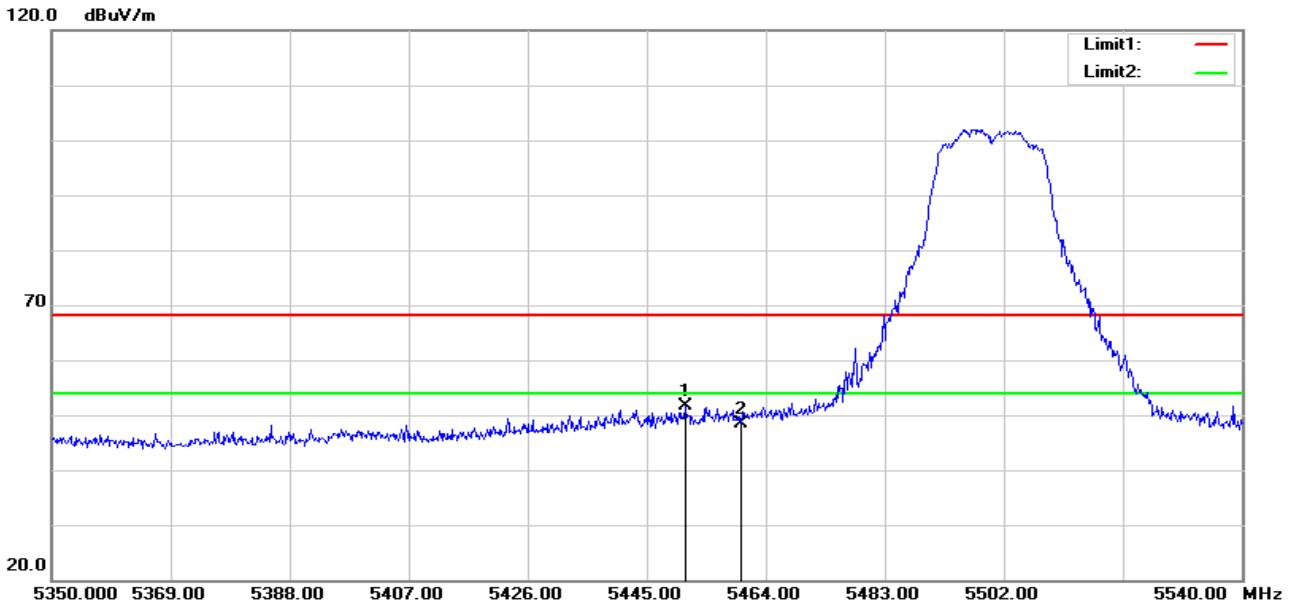

No.	Frequency (MHz)	Reading (dBuV)	Correct Factor(dB/m)	Result (dBuV/m)	Limit (dBuV/m)	Margin (dB)	Remark
1	5451.080	56.80	-5.13	51.67	68.20	-16.53	peak
2	5460.000	53.55	-5.11	48.44	68.20	-19.76	peak

Vertical

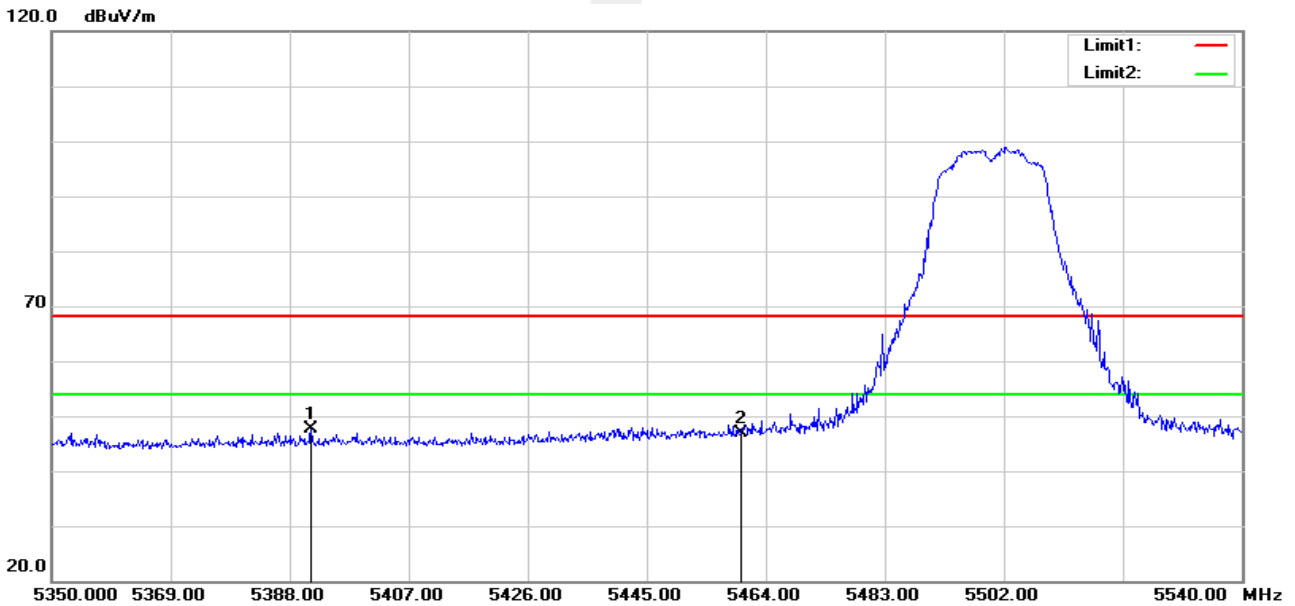

No.	Frequency (MHz)	Reading (dBuV)	Correct Factor(dB/m)	Result (dBuV/m)	Limit (dBuV/m)	Margin (dB)	Remark
1	5391.420	52.93	-5.25	47.68	68.20	-20.52	peak
2	5460.000	52.02	-5.11	46.91	68.20	-21.29	peak



802.11ac 20 High  
Horizontal

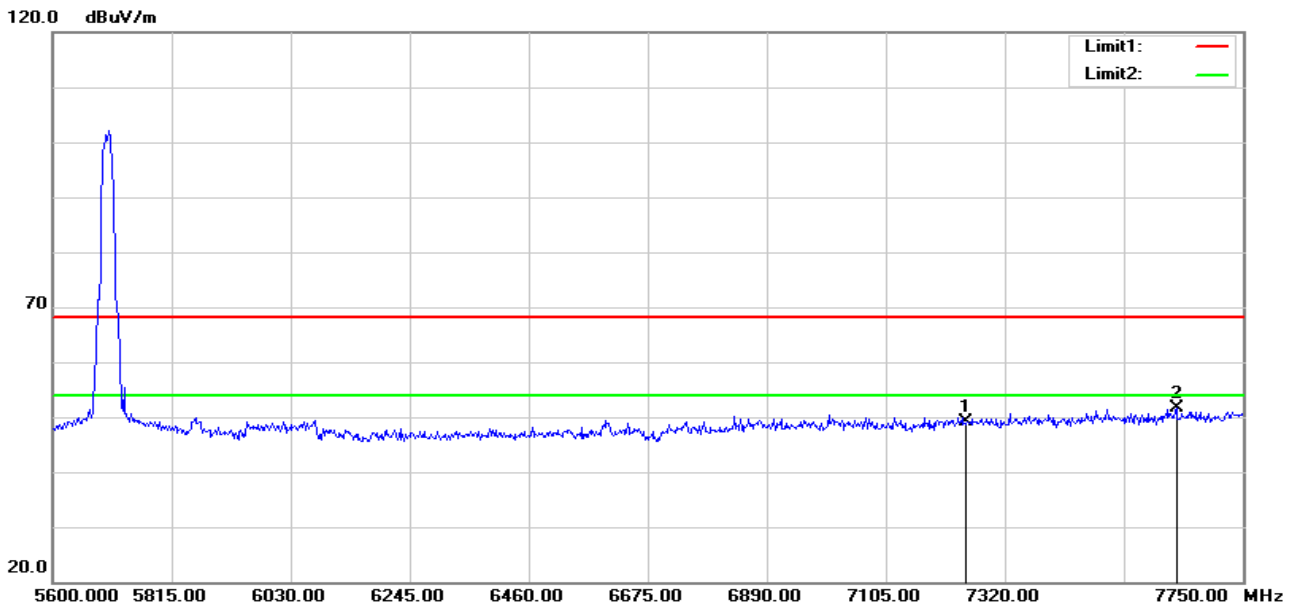

No.	Frequency (MHz)	Reading (dBuV)	Correct Factor(dB/m)	Result (dBuV/m)	Limit (dBuV/m)	Margin (dB)	Remark
1	7250.000	48.33	0.72	49.05	68.20	-19.15	peak
2	7629.600	49.87	1.77	51.64	68.20	-16.56	peak

Vertical

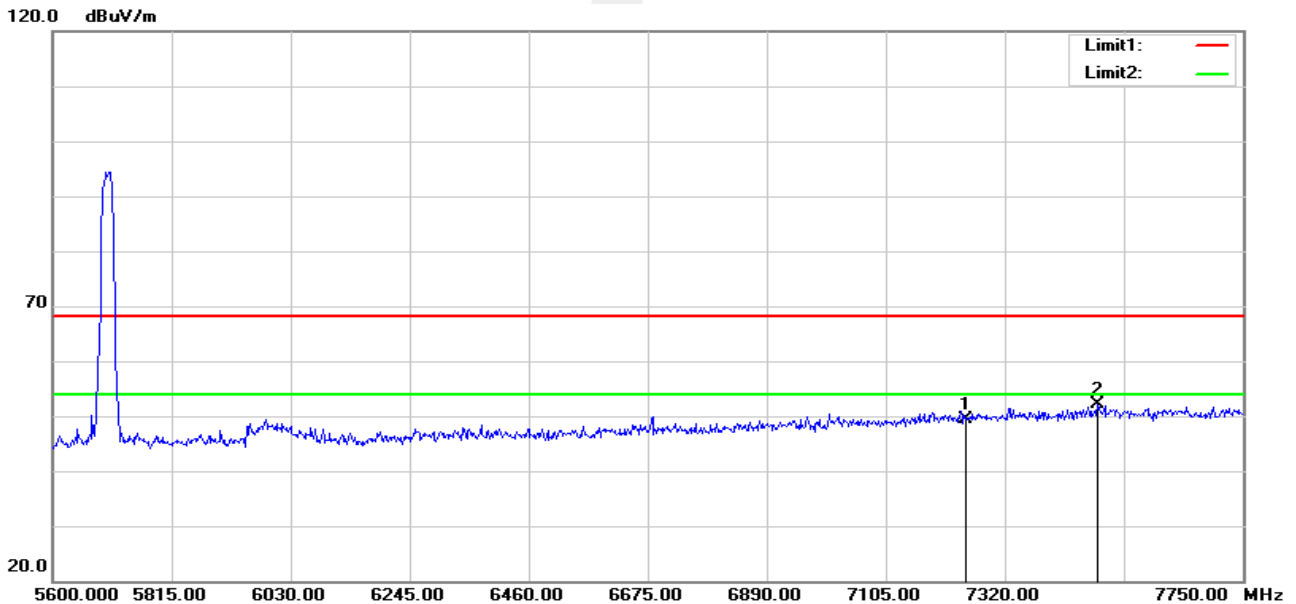

No.	Frequency (MHz)	Reading (dBuV)	Correct Factor(dB/m)	Result (dBuV/m)	Limit (dBuV/m)	Margin (dB)	Remark
1	7250.000	48.60	0.72	49.32	68.20	-18.88	peak
2	7487.700	50.56	1.58	52.14	68.20	-16.06	peak

Note: 802.11a,802.11n (HT-20),802.11n (HT-40), 802.11ac (VHT-20),802.11ac (VHT-40), 802.11ac (VHT-80) all has been tested, the worst case is 802.11ac (VHT-20),only shown the worst case.



Band IV(5.725-5.85 GHz)

802.11a-L-H

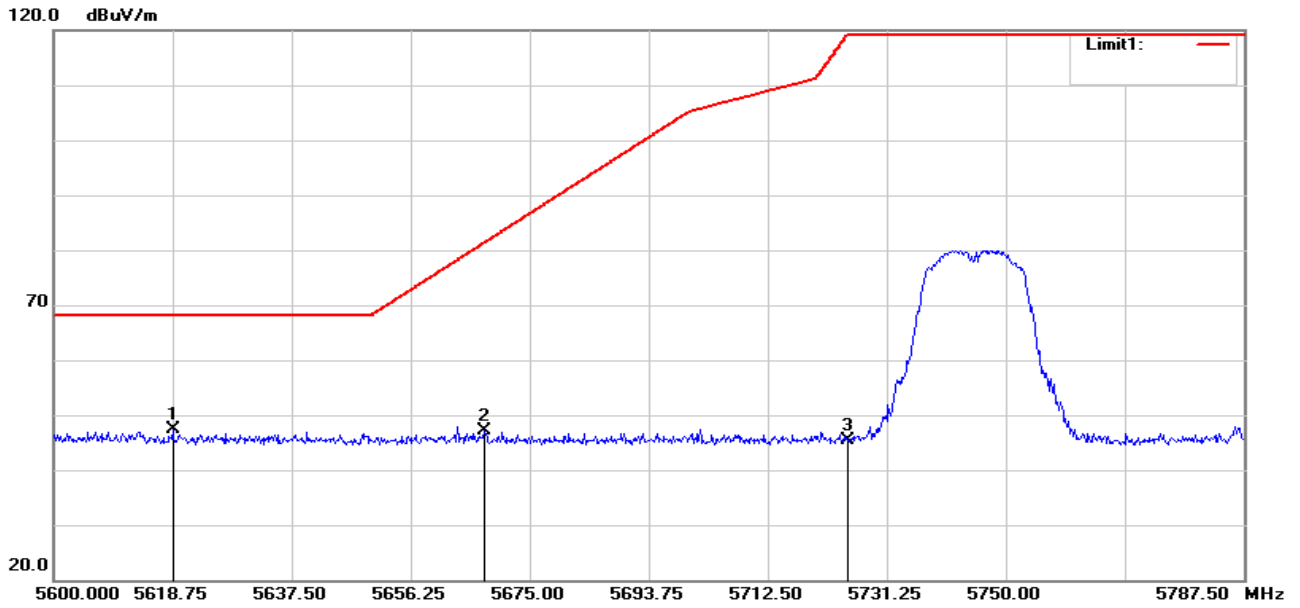

No.	Frequency (MHz)	Reading (dBuV)	Correct Factor(dB/m)	Result (dBuV/m)	Limit (dBuV/m)	Margin (dB)	Remark
1	5618.750	52.05	-4.69	47.36	68.20	-20.84	peak
2	5667.875	51.68	-4.67	47.01	81.43	-34.42	peak
3	5725.000	50.01	-4.57	45.44	119.20	-73.76	peak

802.11a-L-V

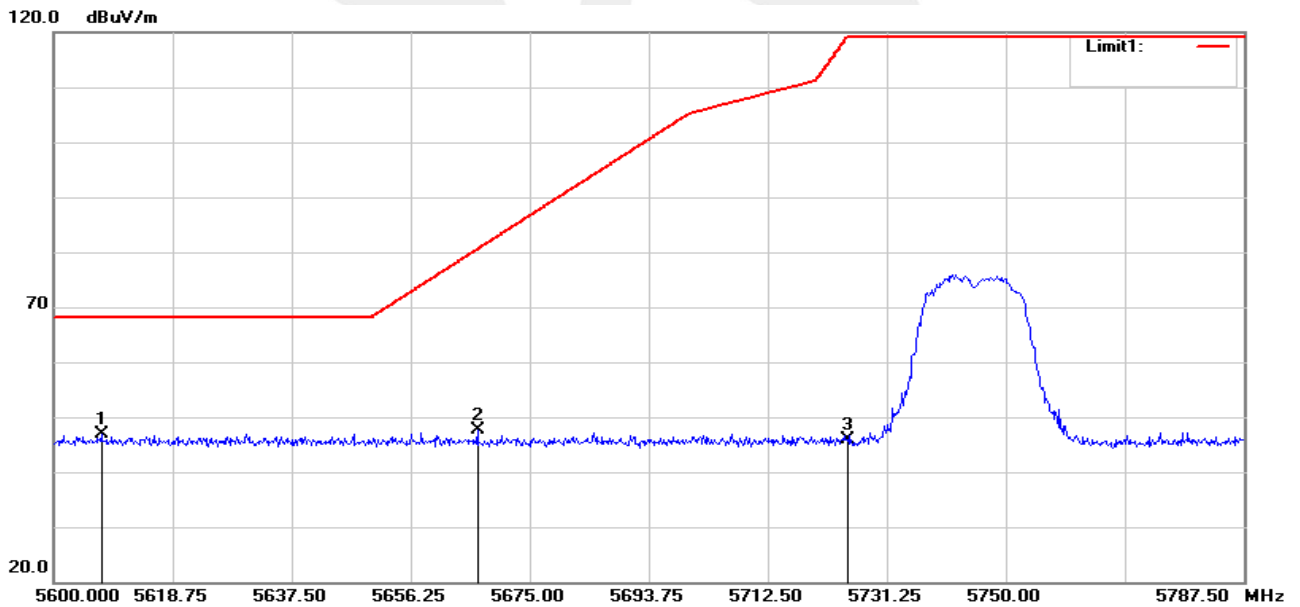

No.	Frequency (MHz)	Reading (dBuV)	Correct Factor(dB/m)	Result (dBuV/m)	Limit (dBuV/m)	Margin (dB)	Remark
1	5607.500	51.47	-4.70	46.77	68.20	-21.43	peak
2	5666.750	52.41	-4.67	47.74	80.59	-32.85	peak
3	5725.000	50.54	-4.57	45.97	119.20	-73.23	peak



802.11a-H-H

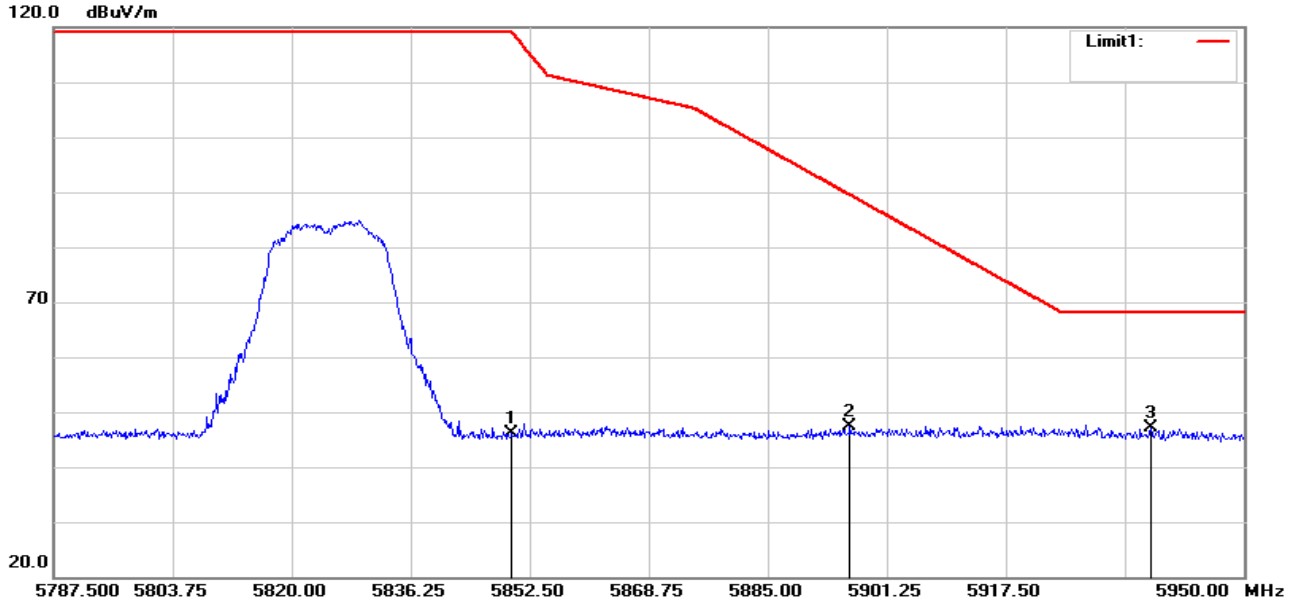

No.	Frequency (MHz)	Reading (dBuV)	Correct Factor(dB/m)	Result (dBuV/m)	Limit (dBuV/m)	Margin (dB)	Remark
1	5850.000	50.32	-4.10	46.22	119.20	-72.98	peak
2	5896.212	51.17	-3.90	47.27	89.50	-42.23	peak
3	5937.325	51.13	-3.94	47.19	68.20	-21.01	peak

802.11a-H-V

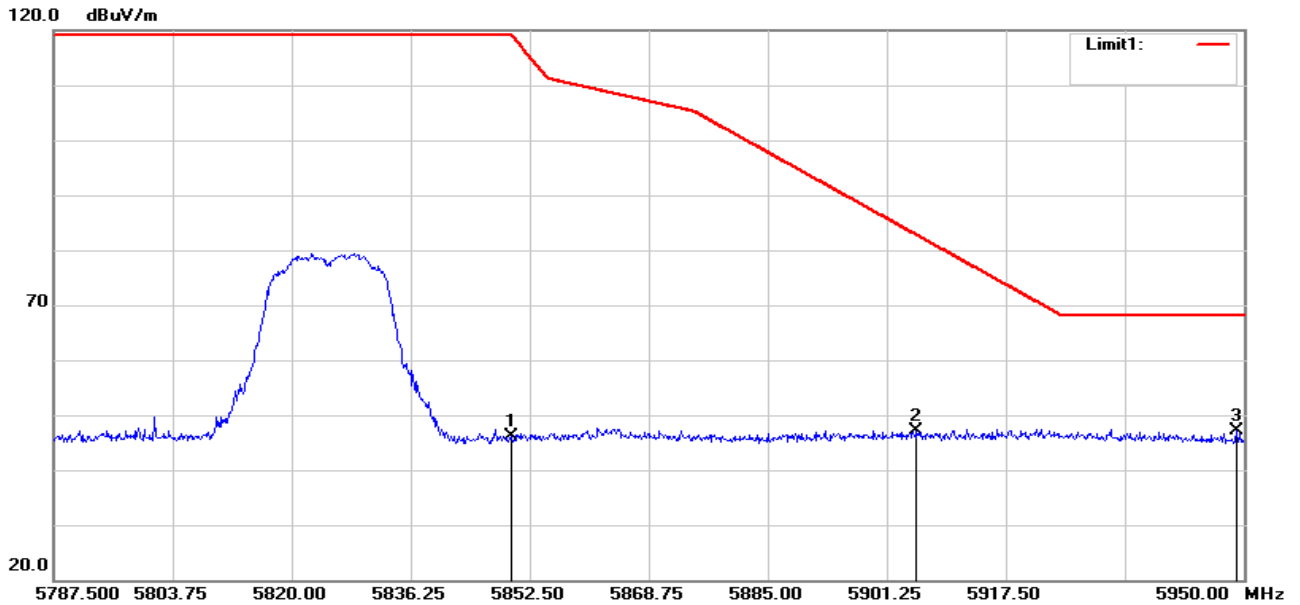

No.	Frequency (MHz)	Reading (dBuV)	Correct Factor(dB/m)	Result (dBuV/m)	Limit (dBuV/m)	Margin (dB)	Remark
1	5850.000	50.35	-4.10	46.25	119.20	-72.95	peak
2	5905.313	51.06	-3.89	47.17	82.77	-35.60	peak
3	5949.025	51.10	-3.96	47.14	68.20	-21.06	peak



802.11n40-L-H

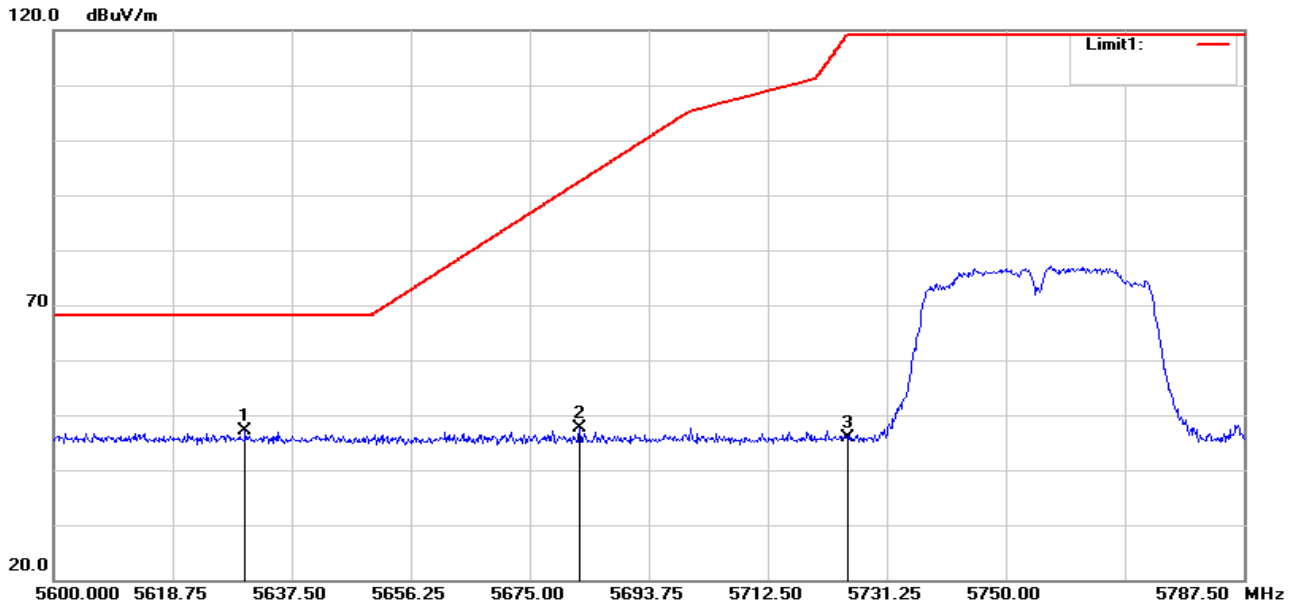

No.	Frequency (MHz)	Reading (dBuV)	Correct Factor(dB/m)	Result (dBuV/m)	Limit (dBuV/m)	Margin (dB)	Remark
1	5630.188	51.86	-4.69	47.17	68.20	-21.03	peak
2	5682.875	52.36	-4.67	47.69	92.53	-44.84	peak
3	5725.000	50.34	-4.57	45.77	119.20	-73.43	peak

802.11n40-L-V

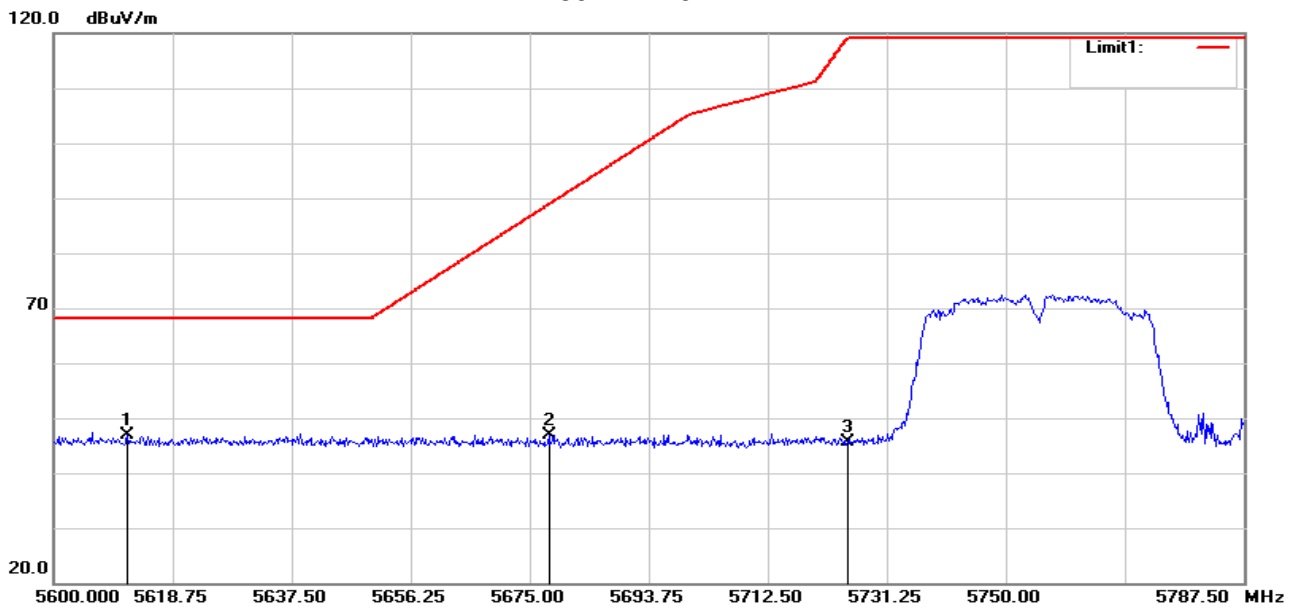

No.	Frequency (MHz)	Reading (dBuV)	Correct Factor(dB/m)	Result (dBuV/m)	Limit (dBuV/m)	Margin (dB)	Remark
1	5611.625	51.52	-4.69	46.83	68.20	-21.37	peak
2	5678.000	51.66	-4.67	46.99	88.92	-41.93	peak
3	5725.000	50.19	-4.57	45.62	119.20	-73.58	peak



802.11n40-H-H

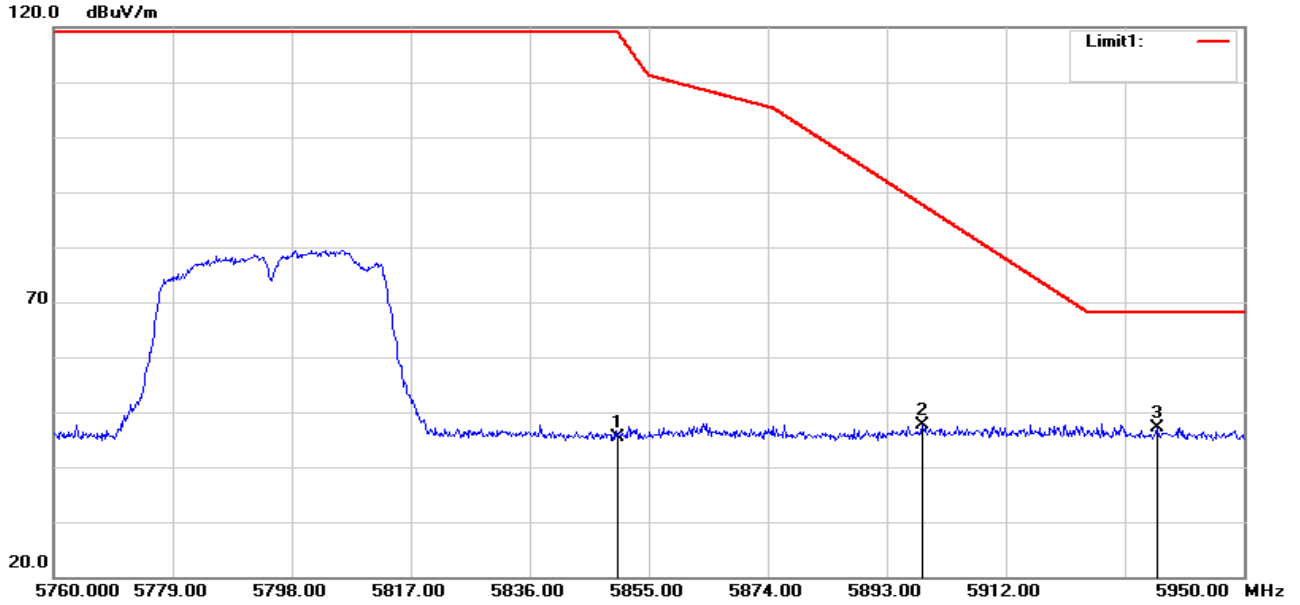

No.	Frequency (MHz)	Reading (dBuV)	Correct Factor(dB/m)	Result (dBuV/m)	Limit (dBuV/m)	Margin (dB)	Remark
1	5850.000	49.49	-4.10	45.39	119.20	-73.81	peak
2	5898.700	51.56	-3.88	47.68	87.66	-39.98	peak
3	5936.130	51.04	-3.94	47.10	68.20	-21.10	peak

802.11n40-H-V

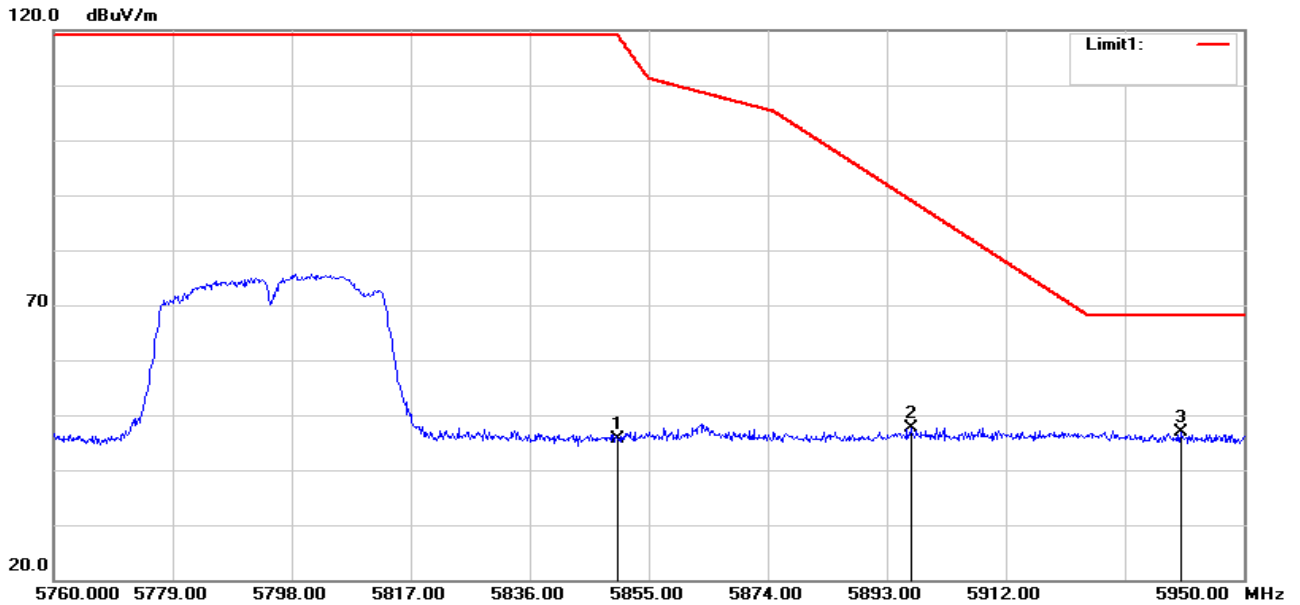

No.	Frequency (MHz)	Reading (dBuV)	Correct Factor(dB/m)	Result (dBuV/m)	Limit (dBuV/m)	Margin (dB)	Remark
1	5850.000	49.64	-4.10	45.54	119.20	-73.66	peak
2	5896.800	51.56	-3.90	47.66	89.07	-41.41	peak
3	5939.930	50.75	-3.95	46.80	68.20	-21.40	peak





802.11ac80-H

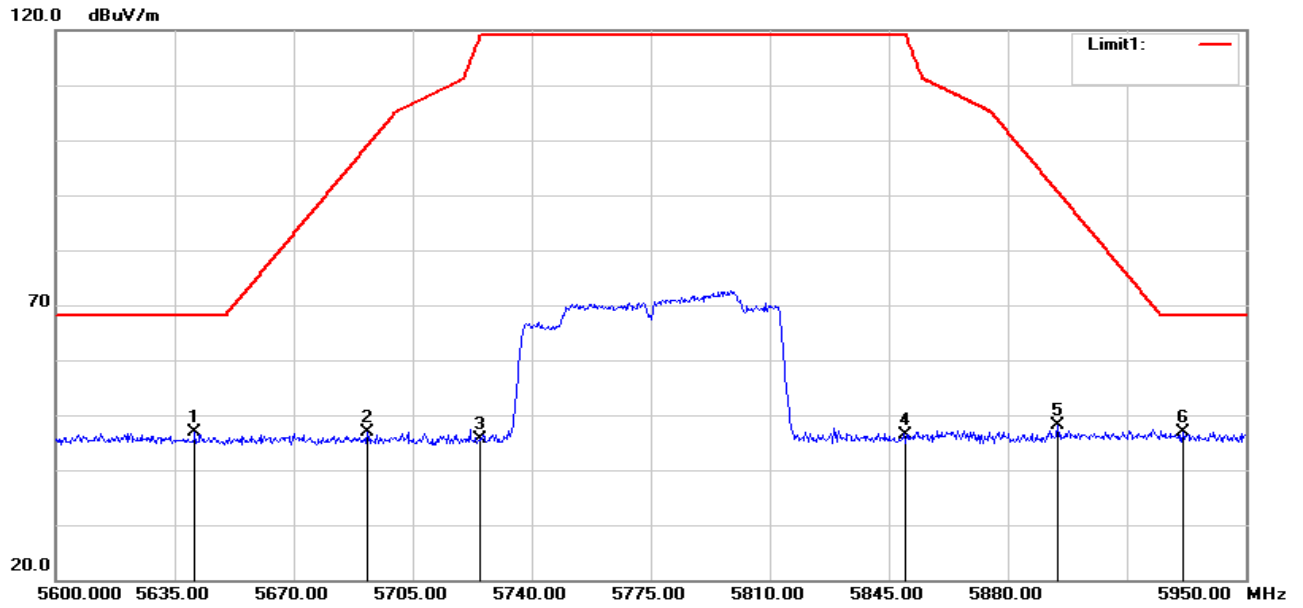

No.	Frequency (MHz)	Reading (dBuV)	Correct Factor(dB/m)	Result (dBuV/m)	Limit (dBuV/m)	Margin (dB)	Remark
1	5640.950	51.52	-4.68	46.84	68.20	-21.36	peak
2	5691.700	51.48	-4.66	46.82	99.06	-52.24	peak
3	5725.000	50.10	-4.57	45.53	119.20	-73.67	peak
4	5850.000	50.55	-4.10	46.45	119.20	-72.75	peak
5	5894.700	52.04	-3.90	48.14	90.62	-42.48	peak
6	5931.450	50.79	-3.93	46.86	68.20	-21.34	peak



802.11ac80-V

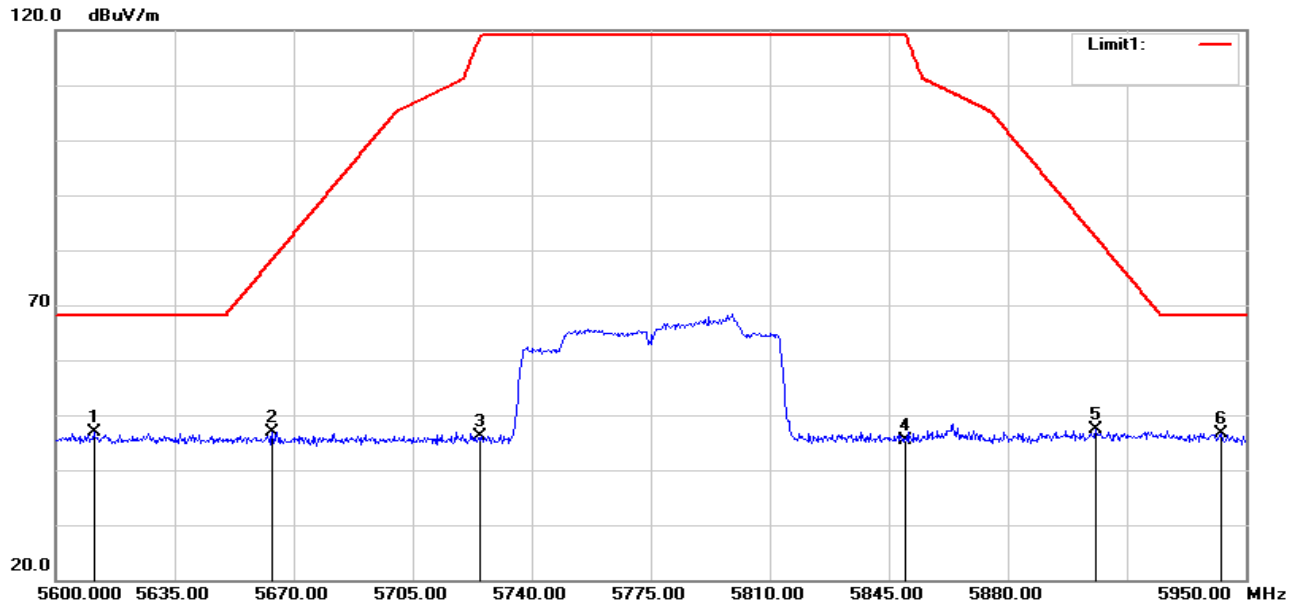

No.	Frequency (MHz)	Reading (dBuV)	Correct Factor(dB/m)	Result (dBuV/m)	Limit (dBuV/m)	Margin (dB)	Remark
1	5611.200	51.54	-4.69	46.85	68.20	-21.35	peak
2	5663.700	51.66	-4.68	46.98	78.34	-31.36	peak
3	5725.000	50.58	-4.57	46.01	119.20	-73.19	peak
4	5850.000	49.54	-4.10	45.44	119.20	-73.76	peak
5	5905.900	51.23	-3.89	47.34	82.33	-34.99	peak
6	5942.650	50.67	-3.95	46.72	68.20	-21.48	peak

Note: All modes have been tested. Only the worst mode shown in the report.



## 4. POWER SPECTRAL DENSITY TEST

### 4.1 LIMIT

1. For mobile and portable client devices in the 5.15-5.25 GHz band, the maximum power spectral density shall not exceed 11 dBm in any 1 megahertz band. If transmitting antennas of directional gain greater than 6 dBi are used, both the maximum conducted output power and the maximum power spectral density shall be reduced by the amount in dB that the directional gain of the antenna exceeds 6 dBi.
2. For the 5.25-5.35 GHz and 5.47-5.725 GHz bands, the maximum power spectral density shall not exceed 11 dBm in any 1 megahertz band. If transmitting antennas of directional gain greater than 6 dBi are used, both the maximum conducted output power and the maximum power spectral density shall be reduced by the amount in dB that the directional gain of the antenna exceeds 6 dBi.
3. For the band 5.725-5.850 GHz, the peak power spectral density shall not exceed 30 dBm in any 500KHz band. If transmitting antenna directional gain is greater than 6 dBi, both the maximum conducted output power and the peak power spectral density shall be reduced by the amount in dB that the directional gain of the antenna exceeds 6 dBi.

### 4.2 TEST PROCEDURE

1. The setting follows Method SA-1 of FCC KDB D02 General UNII Test Procedures New Rules v01r03.

For devices operating in the band, the rules specify a measurement bandwidth of 500 kHz.

Many spectrum analyzers do not have 500 kHz RBW, thus a narrower RBW may need to be used.

The rules permit the use of a RBWs less than 1 MHz, or 500 kHz, "provided that the measured power is integrated over the full reference bandwidth" to show the total power over the specified measurement bandwidth (*i.e.*, 1 MHz, or 500 kHz). If measurements are performed using a reduced resolution bandwidth (< 1 MHz, or < 500 kHz) and integrated over 1 MHz, or 500 KHz bandwidth, the following adjustments to the procedures apply:

- a) Set  $RBW \geq 1/T$ , where  $T$  is defined in section II.B.I.a).
- b) Set  $VBW \geq 3 RBW$ .
- c) If measurement bandwidth of Maximum PSD is specified in 500 kHz, add  $10 \log (500\text{kHz}/RBW)$  to the measured result, whereas  $RBW (< 500 \text{ kHz})$  is the reduced resolution bandwidth of the spectrum analyzer set during measurement.
- d) If measurement bandwidth of Maximum PSD is specified in 1 MHz, add  $10 \log (1\text{MHz}/RBW)$  to the measured result, whereas  $RBW (< 1 \text{ MHz})$  is the reduced resolution bandwidth of spectrum analyzer set during measurement.
- e) Care must be taken to ensure that the measurements are performed during a period of continuous transmission or are corrected upward for duty cycle.

Note: As a practical matter, it is recommended to use reduced RBW of 100 kHz for the sections 5.c) and 5.d) above, since  $RBW=100 \text{ KHZ}$  is available on nearly all spectrum analyzers.



**4.3 DEVIATION FROM STANDARD**

No deviation.

**4.4 TEST SETUP**



**4.5 EUT OPERATION CONDITIONS**

The EUT tested system was configured as the statements of 2.1 Unless otherwise a special operating condition is specified in the follows during the testing.

**4.6 TEST RESULTS**

5150-5250MHz					
Frequency	Direct measurement Power Density (dBm)	Duty cycle factor (dB)	Final Power Density (dBm)	Limit (dBm)	Result
802.11a					
5180	-3.158	0.206	-2.952	11	PASS
5200	-3.300	0.206	-3.094	11	PASS
5240	-2.842	0.206	-2.636	11	PASS
802.11n20					
5180	-6.566	0.122	-6.444	11	PASS
5200	-6.417	0.122	-6.295	11	PASS
5240	-6.091	0.122	-5.969	11	PASS
802.11n40					
5190	-11.212	0.650	-10.562	11	PASS
5230	-10.693	0.650	-10.043	11	PASS
802.11ac20					
5180	-6.507	0.144	-6.363	11	PASS
5200	-6.303	0.144	-6.159	11	PASS
5240	-5.684	0.144	-5.540	11	PASS
802.11ac40					
5190	-11.182	0.679	-10.503	11	PASS
5230	-10.420	0.679	-9.741	11	PASS
802.11ac80					
5210	-14.944	0.638	-14.306	11	PASS



5250-5350MHz					
Frequency	Direct measurement Power Density (dBm)	Duty cycle factor (dB)	Final Power Density (dBm)	Limit (dBm)	Result
802.11a					
5260	-6.420	0.195	-6.225	11	PASS
5300	-6.250	0.195	-6.055	11	PASS
5320	-6.251	0.195	-6.056	11	PASS
802.11n20					
5260	-7.273	0.155	-7.118	11	PASS
5300	-7.495	0.155	-7.340	11	PASS
5320	-6.732	0.155	-6.577	11	PASS
802.11n40					
5270	-11.303	0.662	-10.641	11	PASS
5310	-11.314	0.662	-10.652	11	PASS
802.11ac20					
5260	-7.416	0.132	-7.284	11	PASS
5300	-7.397	0.132	-7.265	11	PASS
5320	-7.023	0.132	-6.891	11	PASS
802.11ac40					
5270	-11.105	0.681	-10.424	11	PASS
5310	-11.107	0.681	-10.426	11	PASS
802.11ac80					
5290	-14.459	0.651	-13.808	11	PASS



5470-5725MHz					
Frequency	Direct measurement Power Density (dBm)	Duty cycle factor (dB)	Final Power Density (dBm)	Limit (dBm)	Result
802.11a					
5500	-6.764	0.185	-6.579	11	PASS
5580	-7.944	0.185	-7.759	11	PASS
5700	-9.485	0.185	-9.300	11	PASS
802.11n20					
5500	-5.592	0.156	-5.436	11	PASS
5580	-6.540	0.156	-6.384	11	PASS
5700	-7.540	0.156	-7.384	11	PASS
802.11n40					
5510	-10.546	0.675	-9.871	11	PASS
5550	-10.972	0.675	-10.297	11	PASS
5670	-12.473	0.675	-11.798	11	PASS
802.11ac20					
5500	-5.306	0.143	-5.163	11	PASS
5580	-6.936	0.143	-6.793	11	PASS
5700	-7.322	0.143	-7.179	11	PASS
802.11ac40					
5510	-10.606	0.681	-9.925	11	PASS
5550	-11.057	0.681	-10.376	11	PASS
5670	-12.475	0.681	-11.794	11	PASS
802.11ac80					
5530	-13.472	0.454	-13.018	11	PASS
5610	-15.186	0.454	-14.732	11	PASS



5725-5850MHz						
Frequency	Use RBW 510KHz direct measurement Direct measurement Power Density (dBm)	Convert to RBW 500KHz direct measurement Power Density (dBm)	Duty cycle factor (dB)	Final Power Density (dBm)	Limit (dBm)	Result
802.11a						
5745	-5.825	-5.911	0.165	-5.746	30	PASS
5785	-6.680	-6.766	0.165	-6.601	30	PASS
5825	-6.095	-6.181	0.165	-6.016	30	PASS
802.11n20						
5745	-6.227	-6.313	0.142	-6.171	30	PASS
5785	-6.981	-7.067	0.142	-6.925	30	PASS
5825	-6.897	-6.983	0.142	-6.841	30	PASS
802.11n40						
5755	-10.241	-10.327	0.623	-9.704	30	PASS
5795	-10.054	-10.140	0.623	-9.517	30	PASS
802.11ac20						
5745	-6.505	-6.591	0.159	-6.432	30	PASS
5785	-1.227	-1.313	0.159	-1.154	30	PASS
5825	-7.313	-7.399	0.159	-7.240	30	PASS
802.11ac40						
5755	-10.690	-10.776	0.638	-10.138	30	PASS
5795	-10.562	-10.648	0.638	-10.010	30	PASS
802.11ac80						
5775	-17.363	-17.449	0.635	-16.814	30	PASS

- Note: 1. RB conversion formula:  $10 \cdot \text{LOG}(500\text{KHz}/\text{RBW})$   
2. Test plots see Attachment A.

## 5. BANDWIDTH MEASUREMENT

### 5.1 EMISSION BANDWIDTH (EBW) 26 BANDWID PROCEDURES / LIMIT

The following procedure shall be used for measuring 26 bandwidth.

#### 5.1.1 TEST PROCEDURE

1. The testing follows FCC KDB 789033 D02 General UNII Test Procedures New Rules v02r01
2. Set RBW = approximately 1% of the emission bandwidth.
3. Set the VBW  $\geq$  RBW.
4. Detector = Peak.
5. Trace mode = max hold.
6. Measure the maximum width of the emission that is 26 dB down from the peak of the emission. Compare this with the RBW setting of the analyzer. Readjust RBW and repeat measurement as needed until the RBW/EBW ratio is approximately 1%.

#### 5.1.2 DEVIATION FROM STANDARD

No deviation.

#### 5.1.3 TEST SETUP

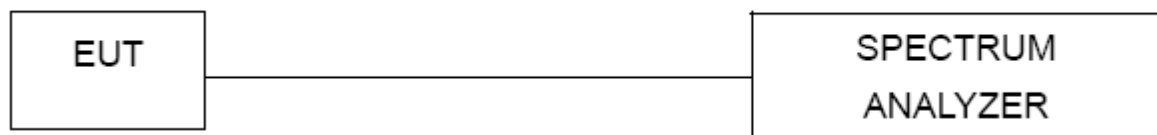

#### 5.1.4 EUT OPERATION CONDITIONS

The EUT tested system was configured as the statements of 2.4 Unless otherwise a special operating condition is specified in the follows during the testing.



**5.1.5 TEST RESULTS**

Frequency (MHz)	26dB Bandwidth (MHz)	Pass/Fail
802.11a		
5180	23.09	Pass
5200	22.25	Pass
5240	22.53	Pass
802.11n(HT20)		
5180	23.71	Pass
5200	22.72	Pass
5240	23.25	Pass
802.11n(HT40)		
5190	43.35	Pass
5230	41.25	Pass
802.11ac(VHT20)		
5180	22.66	Pass
5200	23.43	Pass
5240	22.25	Pass
802.11ac(VHT40)		
5190	43.32	Pass
5230	42.80	Pass
802.11ac(VHT80)		
5210	81.27	Pass

Frequency (MHz)	26dB Bandwidth (MHz)	Pass/Fail
802.11a		
5260	22.58	Pass
5300	23.02	Pass
5320	22.32	Pass
802.11n(HT20)		
5260	23.08	Pass
5300	22.46	Pass
5320	22.80	Pass
802.11n(HT40)		
5270	42.38	Pass
5310	42.27	Pass
802.11ac(VHT20)		
5260	22.71	Pass
5300	23.25	Pass
5320	22.55	Pass
802.11ac(VHT40)		
5270	41.85	Pass
5310	42.70	Pass
802.11ac(VHT80)		
5290	80.90	Pass



Frequency (MHz)	26dB Bandwidth (MHz)	Pass/Fail
802.11a		
5500	22.32	Pass
5580	22.95	Pass
5700	22.69	Pass
802.11n(HT20)		
5500	23.34	Pass
5580	22.99	Pass
5700	22.70	Pass
802.11n(HT40)		
5510	42.24	Pass
5550	41.95	Pass
5670	42.09	Pass
802.11ac(VHT20)		
5500	22.46	Pass
5580	22.89	Pass
5700	22.56	Pass
802.11ac(VHT40)		
5510	42.40	Pass
5550	41.58	Pass
5670	42.50	Pass
802.11ac(VHT80)		
5530	81.14	Pass
5610	81.10	Pass

Frequency (MHz)	26dB Bandwidth (MHz)	Pass/Fail
802.11a		
5745	22.81	Pass
5785	22.40	Pass
5825	21.76	Pass
802.11n(HT20)		
5745	22.41	Pass
5785	22.84	Pass
5825	22.00	Pass
802.11n(HT40)		
5755	42.61	Pass
5795	41.33	Pass
802.11ac(VHT20)		
5745	22.91	Pass
5785	23.01	Pass
5825	23.01	Pass
802.11ac(VHT40)		
5755	41.62	Pass
5795	42.14	Pass
802.11ac(VHT80)		
5775	80.73	Pass

Test plot see Attachment B

## 5.2 OCCUPIED BANDWIDTH ( 99%) TEST APPLIED PROCEDURES / LIMIT

The following procedure shall be used for measuring (99 %) power bandwidth:

### 5.2.1 TEST PROCEDURE

1. The testing follows FCC KDB 789033 D02 General UNII Test Procedures v02r01.

The following procedure shall be used for measuring (99 %) power bandwidth:

1. Set center frequency to the nominal EUT channel center frequency.
2. Set span = 1.5 times to 5.0 times the OBW.
3. Set RBW = 1 % to 5 % of the OBW
4. Set VBW  $\geq 3 \cdot$  RBW
5. Video averaging is not permitted. Where practical, a sample detection and single sweep mode shall be used. Otherwise, peak detection and max hold mode (until the trace stabilizes) shall be used.
6. Use the 99 % power bandwidth function of the instrument (if available).
7. If the instrument does not have a 99 % power bandwidth function, the trace data points are recovered and directly summed in power units. The recovered amplitude data points, beginning at the lowest frequency, are placed in a running sum until 0.5 % of the total is reached; that frequency is recorded as the lower frequency. The process is repeated until 99.5 % of the total is reached; that frequency is recorded as the upper frequency. The 99% occupied bandwidth is the difference between these two frequencies.

### 5.2.2 DEVIATION FROM STANDARD

No deviation.

### 5.2.3 TEST SETUP

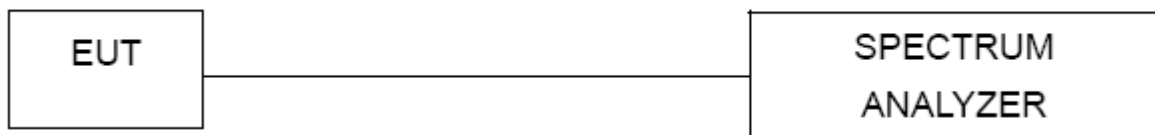

### 5.2.4 EUT OPERATION CONDITIONS

The EUT tested system was configured as the statements of 2.4 Unless otherwise a special operating condition is specified in the follows during the testing.

**5.2.5 TEST RESULTS**

Frequency (MHz)	99% Bandwidth (MHz)	Pass/Fail
802.11a		
5180	16.436	Pass
5200	16.418	Pass
5240	16.461	Pass
802.11n(HT20)		
5180	17.621	Pass
5200	17.619	Pass
5240	17.614	Pass
802.11n(HT40)		
5190	36.087	Pass
5230	36.039	Pass
802.11ac(VHT20)		
5180	17.632	Pass
5200	17.617	Pass
5240	17.612	Pass
802.11ac(VHT40)		
5190	36.064	Pass
5230	36.036	Pass
802.11ac(VHT80)		
5210	75.350	Pass

Frequency (MHz)	99% Bandwidth (MHz)	Pass/Fail
802.11a		
5260	16.440	Pass
5300	16.447	Pass
5320	16.471	Pass
802.11n(HT20)		
5260	17.618	Pass
5300	17.611	Pass
5320	17.609	Pass
802.11n(HT40)		
5270	36.015	Pass
5310	36.070	Pass
802.11ac(VHT20)		
5260	17.625	Pass
5300	17.611	Pass
5320	17.624	Pass
802.11ac(VHT40)		
5270	36.020	Pass
5310	36.048	Pass
802.11ac(VHT80)		
5290	75.313	Pass



Frequency (MHz)	99% Bandwidth (MHz)	Pass/Fail
802.11a		
5500	16.430	Pass
5580	16.453	Pass
5700	16.440	Pass
802.11n(HT20)		
5500	17.625	Pass
5580	17.604	Pass
5700	17.601	Pass
802.11n(HT40)		
5510	42.240	Pass
5550	41.950	Pass
5670	42.090	Pass
802.11ac(VHT20)		
5500	17.601	Pass
5580	17.613	Pass
5700	17.601	Pass
802.11ac(VHT40)		
5510	36.062	Pass
5550	36.048	Pass
5670	36.045	Pass
802.11ac(VHT80)		
5530	75.271	Pass
5610	75.375	Pass

Frequency (MHz)	99% Bandwidth (MHz)	Pass/Fail
802.11a		
5745	16.42	Pass
5785	16.47	Pass
5825	16.41	Pass
802.11n(HT20)		
5745	17.61	Pass
5785	17.61	Pass
5825	17.61	Pass
802.11n(HT40)		
5755	36.03	Pass
5795	36.05	Pass
802.11ac(VHT20)		
5745	17.61	Pass
5785	17.61	Pass
5825	17.61	Pass
802.11ac(VHT40)		
5755	36.03	Pass
5795	36.01	Pass
802.11ac(VHT80)		
5775	74.44	Pass

Test plot See Attachment B

### 5.3 MINIMUM EMISSION BANDWIDTH(6 DB) PROCEDURES / LIMIT

Section 15.407(e) specifies the minimum 6 dB emission bandwidth of at least 500 KHz for the band 5.725-5.85 GHz. The following procedure shall be used for measuring this bandwidth:

#### 5.3.1 TEST PROCEDURE

1. The testing follows FCC KDB 789033 D02 General UNII Test Procedures v02r01.
  - a) Set RBW = 100 kHz.
  - b) Set the video bandwidth (VBW)  $\geq 3 \times$  RBW.
  - c) Detector = Peak.
  - d) Trace mode = max hold.
  - e) Sweep = auto couple.
  - f) Allow the trace to stabilize.
  - g) Measure the maximum width of the emission that is constrained by the frequencies associated with the two outermost amplitude points (upper and lower frequencies) that are attenuated by 6 dB relative to the maximum level measured in the fundamental emission.

#### 5.3.2 DEVIATION FROM STANDARD

No deviation.

#### 5.3.3 TEST SETUP



#### 5.3.4 EUT OPERATION CONDITIONS

The EUT tested system was configured as the statements of 2.4 Unless otherwise a special operating condition is specified in the follows during the testing.

**5.3.5 TEST RESULTS**

Frequency (MHz)	6dB Bandwidth (MHz)	Pass/Fail
802.11a		
5745	15.10	Pass
5785	15.12	Pass
5825	15.14	Pass
802.11n(HT20)		
5745	15.11	Pass
5785	15.13	Pass
5825	15.05	Pass
802.11n(HT40)		
5755	35.10	Pass
5795	35.05	Pass
802.11ac(VHT20)		
5745	15.34	Pass
5785	16.09	Pass
5825	15.27	Pass
802.11ac(VHT40)		
5755	35.11	Pass
5795	35.12	Pass
802.11ac(VHT80)		
5775	75.20	Pass

Test plots see Attachment C.

## 6. MAXIMUM CONDUCTED OUTPUT POWER

### 6.1 LIMIT

For mobile and portable client devices in the 5.15-5.25 GHz band, the maximum conducted output power over the frequency band of operation shall not exceed 250 mW provided the maximum antenna gain does not exceed 6 dBi. If transmitting antennas of directional gain greater than 6 dBi are used, both the maximum conducted output power and the maximum power spectral density shall be reduced by the amount in dB that the directional gain of the antenna exceeds 6 dBi.

For the 5.25-5.35 GHz and 5.47-5.725 GHz bands, the maximum conducted output power over the frequency bands of operation shall not exceed the lesser of 250 mW or 11 dBm + 10 log B, where B is the 26 dB emission bandwidth in megahertz, If transmitting antennas of directional gain greater than 6 dBi are used.

For the band 5.725-5.85 GHz, the maximum conducted output power over the frequency band of operation shall not exceed 1 W. If transmitting antennas of directional gain greater than 6 dBi are used.

FCC Part15 (15.407) , Subpart E				
Section	Test Item	Limit	Frequency Range (MHz)	Result
15.407(a) (1) (iv)	Peak Output Power	0.25 watt	5150-5250	PASS
		The lesser of 250 mW or 11 dBm + 10 log (26 dB emission bandwidth)	5250-5350 5470-5725	
15.407(a) (3)		1 watt	5725-5825	

### 6.2 TEST PROCEDURE

The EUT was directly connected to the Power Sensor&PC

### 6.3 DEVIATION FROM STANDARD

No deviation.

### 6.4 TEST SETUP

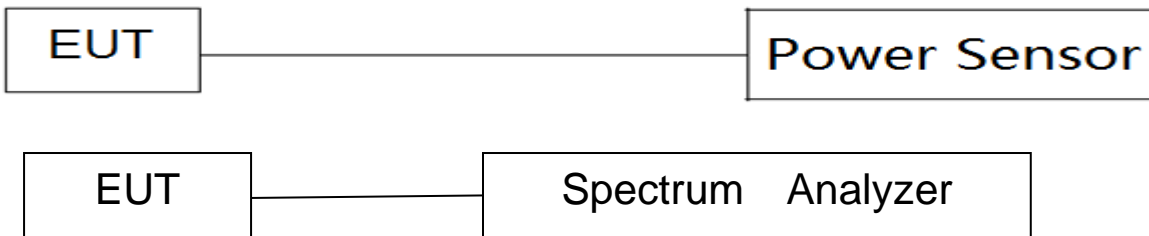

### 6.5 EUT OPERATION CONDITIONS

The EUT tested system was configured as the statements of 5 Unless otherwise a special operating condition is specified in the follows during the testing.



**6.6 TEST RESULTS**

Band I (5.15-5.25GHz)					
Test Channel	Frequency (MHz)	Direct measurement AV Power (dBm)	Duty cycle factor (dB)	Final AV Power (dBm)	LIMIT (dBm)
802.11a					
36	5180	12.57	0.206	12.78	23.98
40	5200	12.70	0.206	12.91	23.98
48	5240	12.73	0.206	12.94	23.98
802.11n(HT20)					
36	5180	12.54	0.122	12.66	23.98
40	5200	12.36	0.122	12.48	23.98
48	5240	12.55	0.122	12.67	23.98
802.11n(HT40)					
38	5190	11.76	0.650	12.41	23.98
46	5230	11.80	0.650	12.45	23.98
802.11ac(VHT20)					
36	5180	12.48	0.144	12.62	23.98
40	5200	12.75	0.144	12.89	23.98
48	5240	12.77	0.144	12.91	23.98
802.11ac(VHT40)					
38	5190	11.35	0.679	12.03	23.98
46	5230	12.10	0.679	12.78	23.98
802.11ac(VHT80)					
42	5210	2.84	0.638	3.48	23.98



Band II(5.25-5.35GHz)					
Test Channel	Frequency (MHz)	Direct measurement AV Power (dBm)	Duty cycle factor (dB)	Final AV Power (dBm)	LIMIT (dBm)
802.11a					
52	5260	12.68	0.195	12.88	23.98
60	5300	12.60	0.195	12.80	23.98
64	5320	12.66	0.195	12.86	23.98
802.11n(HT20)					
52	5260	12.02	0.155	12.18	23.98
60	5300	12.20	0.155	12.36	23.98
64	5320	12.58	0.155	12.74	23.98
802.11n(HT40)					
54	5270	11.65	0.662	12.31	23.98
62	5310	11.78	0.662	12.44	23.98
802.11ac(VHT20)					
52	5260	12.50	0.132	12.63	23.98
60	5300	12.37	0.132	12.50	23.98
64	5320	12.45	0.132	12.58	23.98
802.11ac(VHT40)					
54	5270	12.03	0.681	12.71	23.98
62	5310	11.70	0.681	12.38	23.98
802.11ac(VHT80)					
58	5290	2.40	0.651	3.05	23.98



Band III(5.47-5.725GHz)					
Test Channel	Frequency (MHz)	Direct measurement AV Power (dBm)	Duty cycle factor (dB)	Final AV Power (dBm)	LIMIT (dBm)
802.11a					
100	5500	14.01	0.185	14.20	23.98
116	5580	13.43	0.185	13.62	23.98
140	5700	12.41	0.185	12.60	23.98
802.11n(HT20)					
100	5500	13.95	0.156	14.11	23.98
116	5580	13.28	0.156	13.44	23.98
140	5700	12.27	0.156	12.43	23.98
802.11n(HT40)					
102	5510	13.24	0.675	13.92	23.98
110	5550	13.10	0.675	13.78	23.98
134	5670	11.99	0.675	12.67	23.98
802.11ac(VHT20)					
100	5500	14.33	0.143	14.47	23.98
116	5580	13.54	0.143	13.68	23.98
140	5700	12.48	0.143	12.62	23.98
802.11ac(VHT40)					
102	5510	13.59	0.681	14.27	23.98
110	5550	12.93	0.681	13.61	23.98
134	5670	11.49	0.681	12.17	23.98
802.11ac(VHT80)					
106	5530	2.24	0.454	2.69	23.98
122	5610	1.33	0.454	1.78	23.98



Band IV (5.725-5.85GHz)					
Test Channel	Frequency (MHz)	Direct measurement AV Power (dBm)	Duty cycle factor (dB)	Final AV Power (dBm)	LIMIT (dBm)
802.11a					
149	5745	6.15	0.165	6.31	30.00
157	5785	6.06	0.165	6.22	30.00
165	5825	6.44	0.165	6.60	30.00
802.11n(HT20)					
149	5745	5.85	0.142	5.99	30.00
157	5785	5.92	0.142	6.06	30.00
165	5825	5.84	0.142	5.98	30.00
802.11n(HT40)					
151	5755	5.67	0.623	6.29	30.00
159	5795	5.27	0.623	5.89	30.00
802.11ac(VHT20)					
149	5745	5.89	0.159	6.05	30.00
157	5785	5.90	0.159	6.06	30.00
165	5825	5.82	0.159	5.98	30.00
802.11ac(VHT40)					
151	5755	5.81	0.638	6.45	30.00
159	5795	5.39	0.638	6.03	30.00
802.11ac(VHT80)					
155	5775	8.22	0.635	8.86	30.00

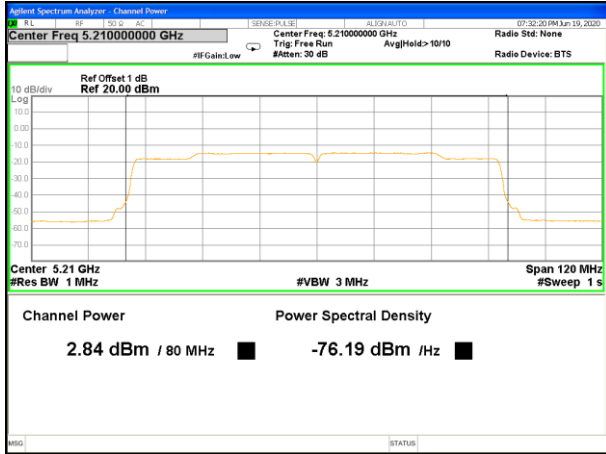

5210MHz

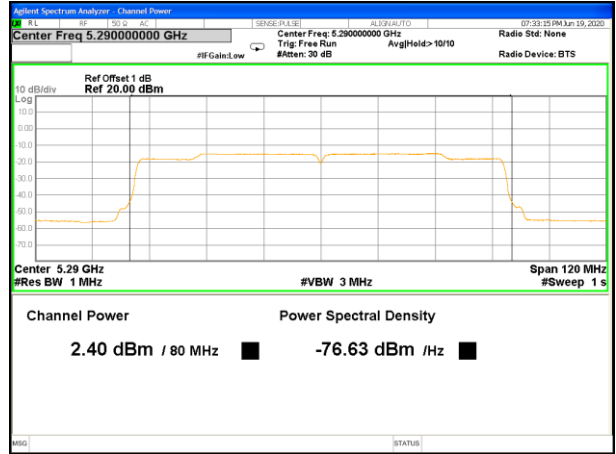

5290MHz

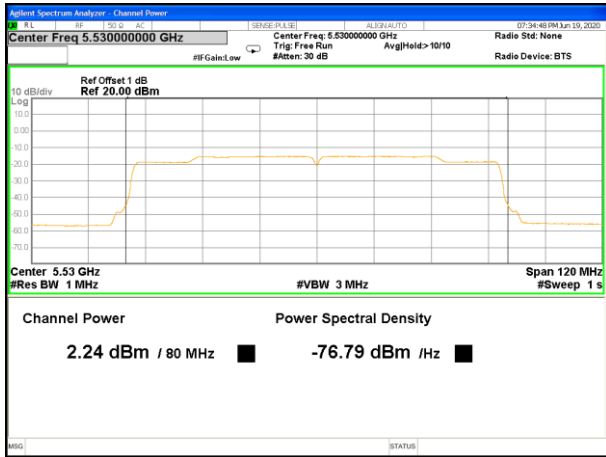

5530MHz

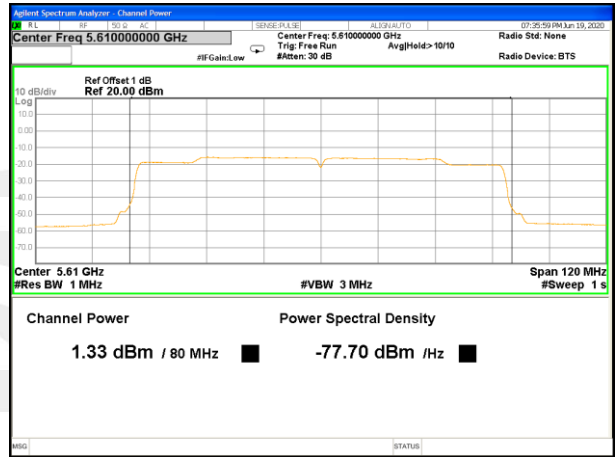

5610MHz

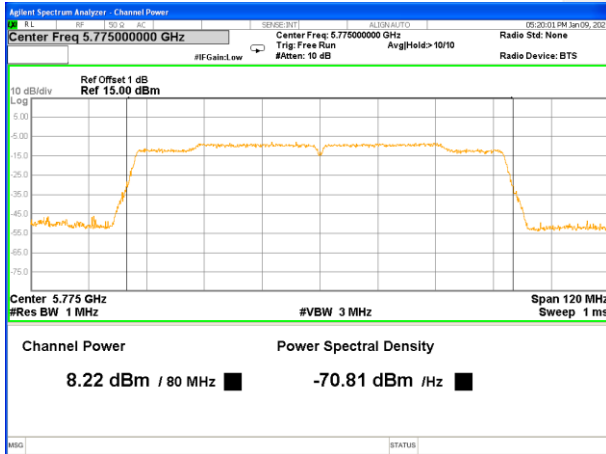

5775MHz



## Duty cycle

Band1				
Mode	Ton(ms)	Tp(ms)	Duty cycle(%)	Duty factor(dB)
a	2.060	2.160	95.37%	0.206
n20	1.935	1.990	97.24%	0.122
n40	0.948	1.101	86.10%	0.650
ac20	1.925	1.990	96.73%	0.144
ac40	0.957	1.119	85.52%	0.679
ac80	0.468	0.542	86.35%	0.638

Band2				
Mode	Ton(ms)	Tp(ms)	Duty cycle(%)	Duty factor(dB)
a	2.065	2.160	95.60%	0.195
n20	1.925	1.995	96.49%	0.155
n40	0.948	1.104	85.87%	0.662
ac20	1.940	2.000	97.00%	0.132
ac40	0.954	1.116	85.48%	0.681
ac80	0.470	0.546	86.08%	0.651

Band3				
Mode	Ton(ms)	Tp(ms)	Duty cycle(%)	Duty factor(dB)
a	2.065	2.155	95.82%	0.185
n20	1.920	1.990	96.48%	0.156
n40	0.945	1.104	85.60%	0.675
ac20	1.935	2.000	96.75%	0.143
ac40	0.954	1.116	85.48%	0.681
ac80	0.472	0.524	90.08%	0.454

Band4				
Mode	Ton(ms)	Tp(ms)	Duty cycle(%)	Duty factor(dB)
a	2.072	2.152	96.28%	0.165
n20	1.928	1.992	96.79%	0.142
n40	0.960	1.108	86.64%	0.623
ac20	1.928	2.000	96.40%	0.159
ac40	0.960	1.112	86.33%	0.638
ac80	0.470	0.544	86.40%	0.635



Band 1-a20

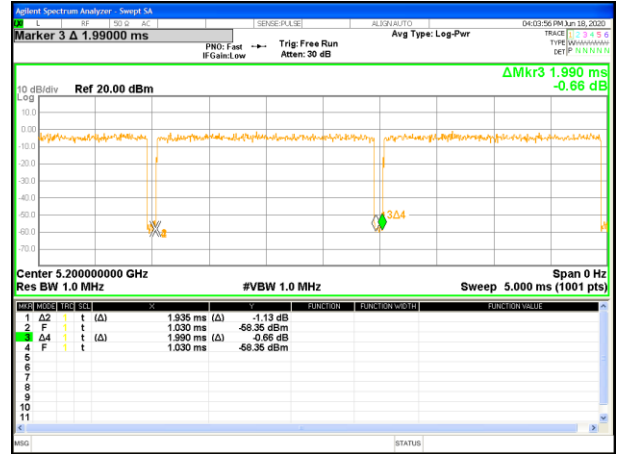

Band 1-n20



Band 1-n40

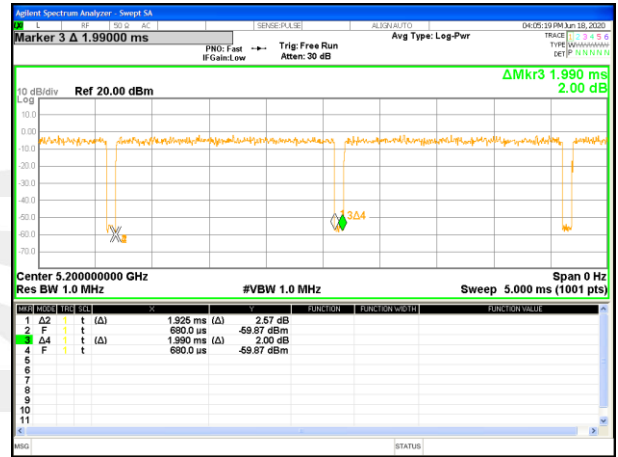

Band 1-ac20

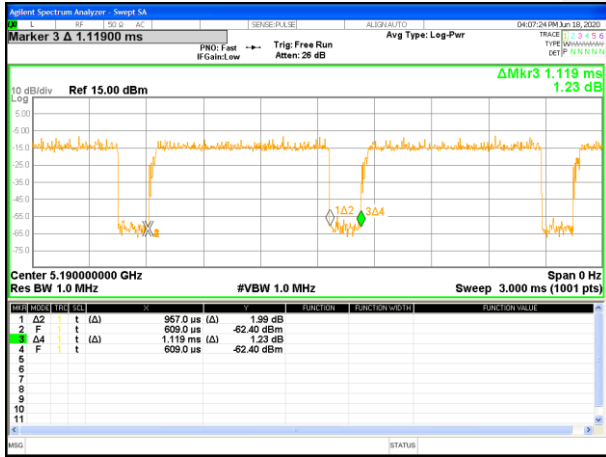

Band 1-ac40



Band 1-ac80

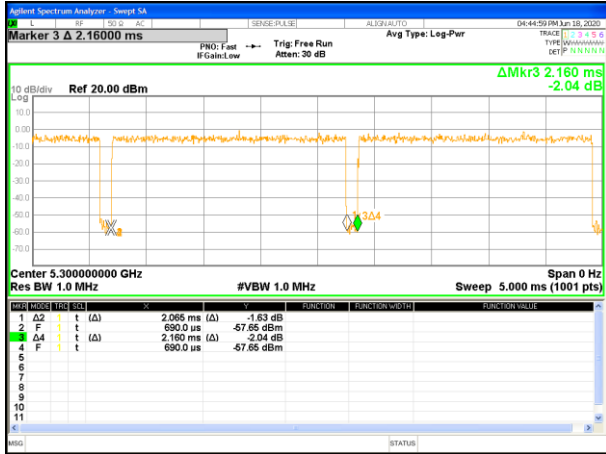

Band 2-a20



Band 2-n20



Band 2-n40

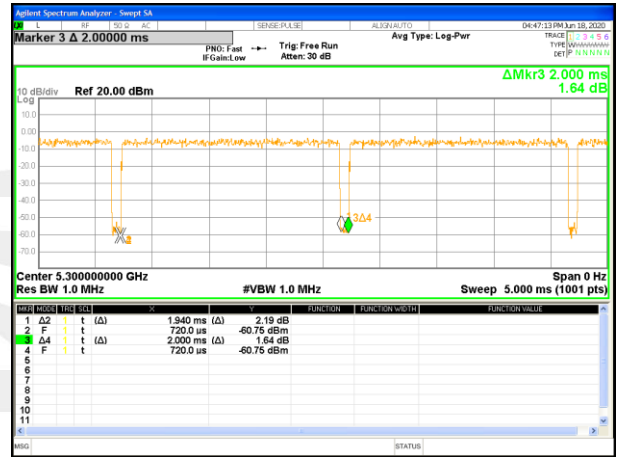

Band 2-ac20

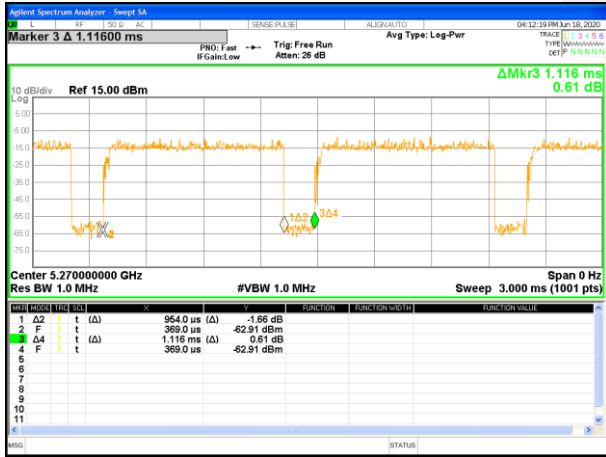

Band 2-ac40

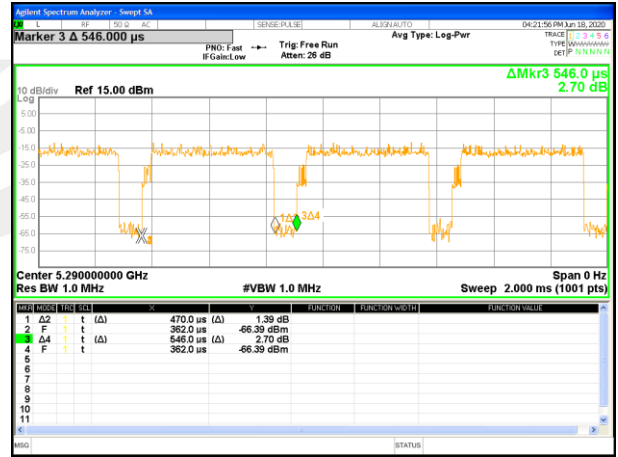

Band 2-ac80





Band 3-a20

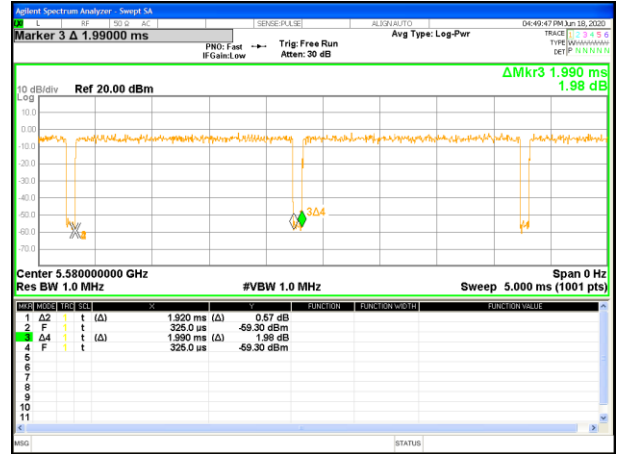

Band 3-n20

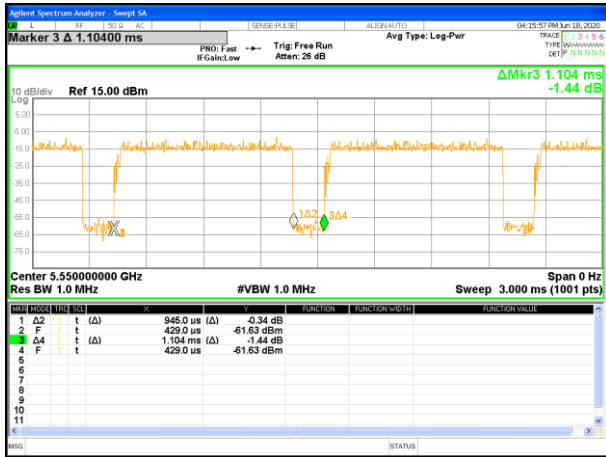

Band 3-n40



Band 3-ac20

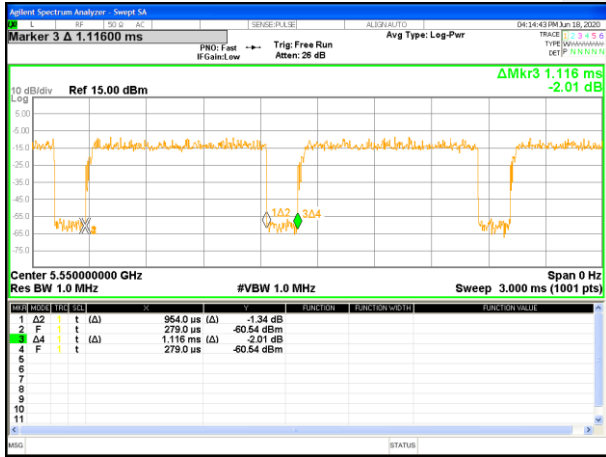

Band 3-ac40

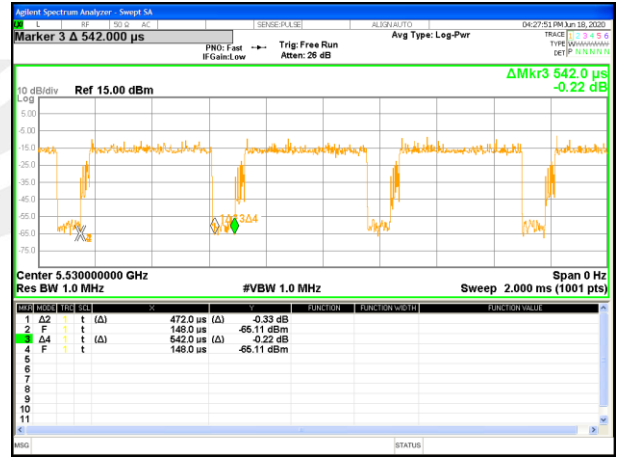

Band 3-ac80



Band 4-a20

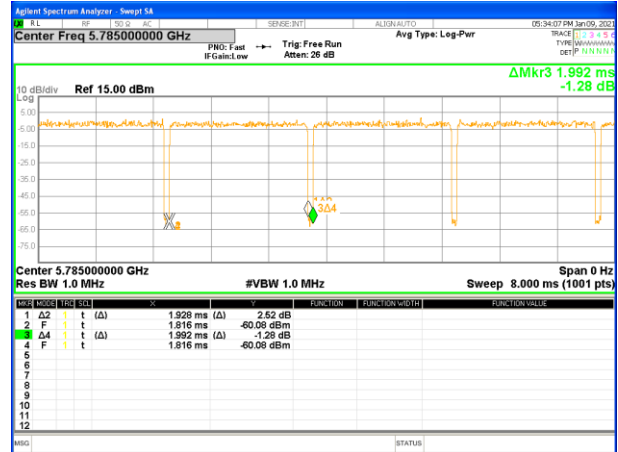

Band 4-n20



Band 4-n40

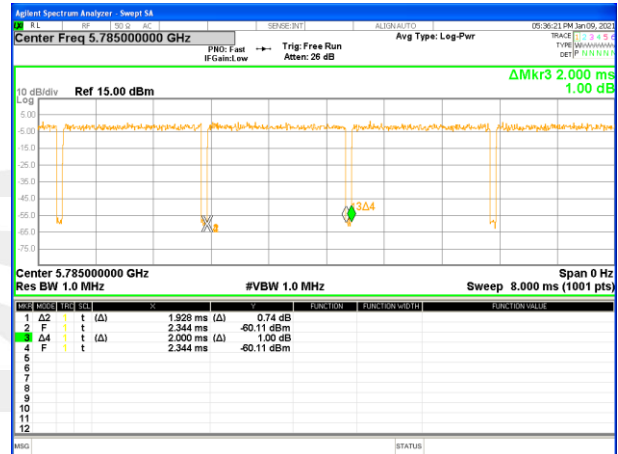

Band 4-ac20



Band 4-ac40

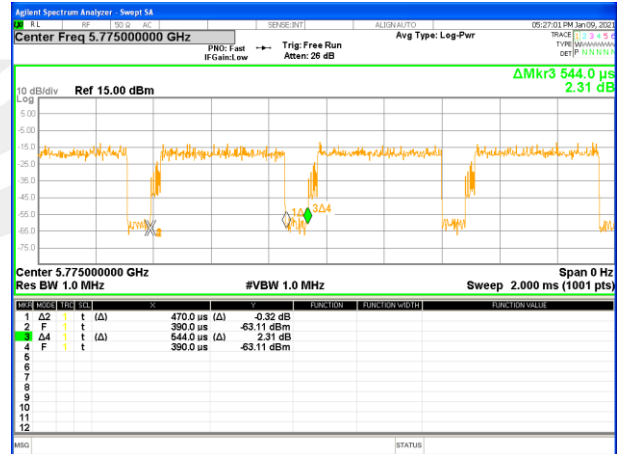

Band 4-ac80



## 7. AUTOMATICALLY DISCONTINUE TRANSMISSION

### 7.1 LIMIT OF AUTOMATICALLY DISCONTINUE TRANSMISSION

The device shall automatically discontinue transmission in case of either absence of information to transmit or operational failure. These provisions are not intended to preclude the transmission of control or signaling information or the use of repetitive codes used by certain digital technologies to complete frame or burst intervals. Applicants shall include in their application for equipment authorization to describe how this requirement is met.

### 7.2 TEST RESULT OF AUTOMATICALLY DISCONTINUE TRANSMISSION

During no any information transmission, the EUT can automatically discontinue transmission and become standby mode for power saving. The EUT can detect the controlling signal of ACK message transmitting from remote device and verify whether it shall resend or discontinue transmission





## 8. ANTENNA REQUIREMENT

### 8.1 STANDARD REQUIREMENT

15.203 requirement: For intentional device, according to 15.203: an intentional radiator shall be designed to ensure that no antenna other than that furnished by the responsible party shall be used with the device.

### 8.2 EUT ANTENNA

The EUT antenna is External Antenna. It comply with the standard requirement.





## APPENDIX - PHOTOS OF TEST SETUP

Note: See test photos in setup photo document for the actual connections between Product and support equipment.

※※※※※END OF THE REPORT※※※※※

