

**CD-62**

**Turntable**



**INSTRUCTION MANUAL**

*READ THIS INSTRUCTION MANUAL CAREFULLY BEFORE USE*

## PRODUCT FEATURES

- BLUETOOTH WIRELESS MUSIC STREAMING
- PROGRAMMABLE CD/MP3 PLAYER
- AUX IN FOR CONNECTION OF OTHER DEVICE (EG. CD & MP3 PLAYER)
- USB SLOT FOR MP3 PLAYBACK
- AM/FM RADIO
- CLOCK DISPLAY
- LCD DISPLAY WITH BLUE BACKLIGHT
- STEREO BUILT-IN SPEAKER
- ADAPTOR & REMOTE CONTROL INCLUDED

## LOCATION OF CONTROL

- 1) SPEAKER
- 2) STOP ■
- 3) PLAY/PAUSE ►|| BUTTON
- 4) MODE / CLK
- 5) RADIO FREQUENCY DIAL SCALE
- 6) DIAL POINTER
- 7) RADIO TUNING KNOB
- 8) SKIP UP ►►
- 9) SKIP DOWN ◀◀
- 10) SPEAKER
- 11) VOLUME KNOB
- 12) USB SLOT
- 13) EARPHONE JACK
- 14) CD/USB
- 15) BT INDICATOR
- 16) STANDBY
- 17) LCD DISPLAY
- 18) AM/FM
- 19) AUX
- 20) AUX IN JACK
- 21) REMOTE CONTROL RECEIVER
- 22) ALBUM UP/DOWN
- 23) CD DOOR
- 24) CD DOOR OPEN BUTTON
- 25) FM ANTENNA
- 26) EXTERNAL POWER ADAPTOR JACK

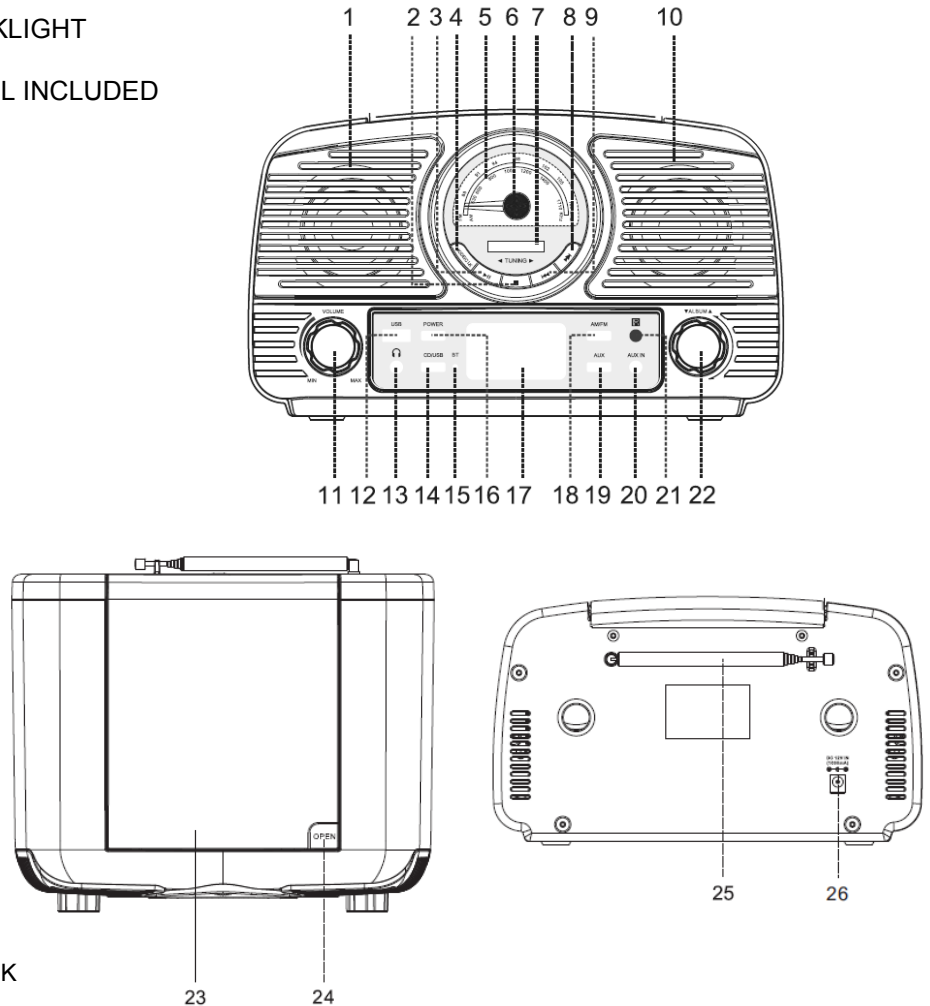

## CAUTION:

USAGE OF CONTROLS OR ADJUSTMENTS OR PERFORMANCE OF PROCEDURES OTHER THAN THOSE SPECIFIED HEREIN MAY RESULT IN HAZARDOUS RADIATION EXPOSURE. THIS UNIT SHOULD NOT BE ADJUSTED OR REPAIRED BY ANYONE EXCEPT QUALIFIED SERVICE PERSONNEL.

## WARNING:

- THE APPARATUS SHALL NOT BE EXPOSED TO DRIPPING OR SPLASHING AND THAT NO OBJECTS FILLED WITH LIQUIDS, SUCH AS VASES, SHALL BE PLACED ON THE APPARATUS.
- BATTERIES (BATTERY PACK OR BATTERIES INSTALLED) SHALL NOT BE EXPOSED TO EXCESSIVE HEAT SUCH AS SUNSHINE, FIRE OR THE LIKE.
- THE MAINS PLUGS OR AN APPLIANCE COUPLER IS USED AS THE DISCONNECT DEVICE, AND THE DISCONNECT DEVICE SHALL REMAIN READILY OPERABLE.

## PRECAUTIONS FOR USE

### INSTALLATION

- UNPACK ALL PARTS AND REMOVE PROTECTIVE MATERIAL.
- DO NOT CONNECT THE UNIT TO THE MAINS BEFORE CHECKING THE MAINS VOLTAGE AND BEFORE ALL OTHER CONNECTIONS HAVE BEEN MADE.
- DO NOT COVER ANY VENTS AND MAKE SURE THAT THERE IS A SPACE OF SEVERAL CENTIMETERS

AROUND THE UNIT FOR VENTILATION.







## CONNECTION

---

1. CONNECT **EXTERNAL POWER ADAPTOR TO EXTERNAL POWER ADAPTOR JACK**
2. PUSH THE **STANDBY** TO SWITCH ON THE UNIT. LCD WILL BE BRIGHT UP FROM DIMMER LIGHTING.

## SETTING THE CLOCK

---

1. WHEN THE LCD DISPLAY IN DIMMER LIGHTNING, UNIT IS IN THE STANDBY MODE.
2. DURING STANDBY MODE, SELECT BETWEEN 12H OR 24H MODE: PRESS AND HOLD **CLK BUTTON** FOR 3-5 SECONDS, 12H / 24H WILL BE FLASHING. PRESS **SKIP UP**  OR **SKIP DOWN**  BUTTON TO SELECT 12H / 24H MODE. PRESS **CLK BUTTON** AGAIN TO CONFIRM.
3. SETTING HOUR: PRESS **SKIP UP**  OR **SKIP DOWN**  BUTTON TO SELECT THE CORRECT HOUR, THEN PRESS **CLK BUTTON** AGAIN TO CONFIRM.
4. SETTING MINUTE: AFTER STEP 3 IS COMPLETED, PRESS **SKIP UP**  OR **SKIP DOWN**  BUTTON TO SELECT THE CORRECT MINUTE, THEN PRESS **CLK BUTTON** AGAIN TO CONFIRM.

## LISTENING TO RADIO

---

### RADIO TUNING

1. PRESS **AM/FM BUTTON** TO ACTIVATE "TUNE" MODE. PRESS **AM/FM BUTTON** REPEATEDLY TO SWITCH BETWEEN AM AND FM BAND.
2. TURN THE **RADIO TUNING KNOB** LEFT OR RIGHT TO SELECT THE DESIRED STATION.
3. **RADIO FREQUENCY DIAL SCALE** AND **DIAL POINTER** WILL SHOW THE RADIO FREQUENCY

### HINTS FOR BETTER RECEPTION

1. AM: THERE IS A BUILT-IN AM BAR ANTENNA. IF AM RECEPTION IS WEAK, SLIGHTLY ROTATING OR RE-POSITIONING OF THE UNIT WILL USUALLY IMPROVE THE AM RECEPTION.
2. FM : PUT OUT THE TELESCOPIC ANTENNA TO ENHANCE RADIO RECEPTION IF NECESSARY.

## AUX IN MODE

---

PRESS AUX BUTTON TO ACTIVATE "AUX" ON DISPLAY, THEN CONNECT THE EXTERNAL AUDIO DEVICE (SUCH AS CD PLAYER) THROUGH THE AUX IN JACK. AUDIO SIGNAL FROM THE EXTERNAL AUDIO DEVICE CAN BE PLAYED THROUGH THE SYSTEM.

## PLAYBACK OF MP3/WMA SONG VIA USB STORAGE MEDIA

---

### CONNECTING

THE SYSTEM IS ABLE TO DECODE AND PLAYBACK ALL MP3 / WMA FILE WHICH STORED IN THE MEMORY MEDIA WITH USB CONNECTING PORT.

1. PLUG-IN THE USB PLUG WITH THE FACE UP & MAKE SURE IT GOING INTO COMPLETELY. INSERT STRAIGHT WITHOUT BENDING.
2. CONNECTING THE USB UPSIDE DOWN OR BACKWARDS COULD DAMAGE THE AUDIO SYSTEM OR THE STORAGE MEDIA (USB THUMB DRIVE). CHECK TO BE SURE THE DIRECTION IS CORRECT BEFORE CONNECTION.
3. PRESS **CD/USB** BUTTON REPEATEDLY TO SELECT "USB" ON DISPLAY, THEN INSERT MEMORY DEVICE.
4. THE SYSTEM WILL START READING THE STORAGE MEDIA AUTOMATICALLY AFTER FUNCTION SELECTION, AND DISPLAY WILL SHOW THE TOTAL NUMBER OF MP3/WMA FILES (EG. 016). THEN THE SYSTEM WILL START AUDIO PLAYBACK

- **PLAY / PAUSE BUTTON** 

- PRESS THE "PLAY/PAUSE"  BUTTON ONCE TO HALT PLAYING, PRESS IT AGAIN TO CONTINUE.

- **STOP BUTTON** 

- PRESS **STOP**  BUTTON TO END UP AUDIO PLAYBACK, THEN DISPLAY WILL SHOW THE TOTAL NUMBER OF MP3/WMA FILES. AND THEN USER CAN PRESS "SKIP UP"  OR "SKIP DOWN"  BUTTON TO SELECT FILE FORWARD OR BACKWARD.

- **SKIP UP**  / **SKIP DOWN**  BUTTON

- DURING MP3/WMA PLAYBACK, PRESS **SKIP UP**  BUTTON ONCE TO PLAY THE NEXT FILE.

PRESS AND HOLD **SKIP UP** ►►I BUTTON CONTINUOUSLY TO SPEED UP SELECTING FORWARD.

- DURING MP3/WMA PLAYBACK, PRESS **SKIP DOWN** I◄◄ BUTTON ONCE TO PLAY THE PREVIOUS FILE. PRESS AND HOLD **SKIP DOWN** I◄◄ BUTTON CONTINUOUSLY TO SPEED UP SELECTING BACKWARD.

- **FOLDER SEARCHING**

TURN **ALBUM UP/DOWN** KNOB TO SEARCH FOLDER BACKWARD OR FORWARD.

- **REPEAT FUNCTION**

DURING AUDIO PLAYBACK, PRESS **MODE** BUTTON ONCE, SINGLE TRACK WILL BE PLAYED REPEATEDLY. PRESS **MODE** BUTTON AGAIN, IT WILL REPEATEDLY PLAY ALL TRACKS IN THE WHOLE USB DRIVE.

**REMARK**

- IF CONNECT THE SYSTEM TO MP3 PLAYER VIA THE USB SOCKET, DUE TO VARIANCES IN MP3 ENCODING FORMAT, SOME MP3 PLAYER MAY NOT BE ABLE TO PLAY VIA THE USB SOCKET. THIS IS NOT A MALFUNCTION OF THE SYSTEM.
- THERE ARE NUMEROUS USB DEVICE PRODUCERS ARE. SOLUTION AND FORMAT ARE VARIABLE BETWEEN EACH OTHER. THEREFORE, WE DO NOT GARANTTEE THIS UNIT CAN SUPPORT ALL USB DEVICE FROM EVERY BRAND.

**TRACKS PROGRAMMING**

UP TO 99 TRACKS CAN BE PROGRAMMED FOR MP3/WMA FILE AND PLAY IN ANY ORDER. BEFORE USE, BE SURE THE SYSTEM IS AT STOP MODE BEFORE PROGRAMMING:

1. SET AT USB MODE, THEN PRESS **STOP** BUTTON.
2. PRESS **MODE** BUTTON, "MEM" WILL BE FLASHING ON LCD DISPLAY. MOREOVER, IT WILL INDICATE PROGRAM NO. AND DIGITS FOR TRACK NO. TO BE PROGRAMMED.
3. SELECT A DESIRED TRACK BY PRESSING **SKIP UP** ►►I OR **SKIP DOWN** I◄◄ BUTTON. IF FOLDER SELECTION IS REQUIRED, TURNING **ALBUM DOWN** OR **ALBUM UP** TO SEARCH FOLDER BACKWARD OR FORWARD.
4. PRESS **MODE** BUTTON TO CONFIRM AND STORE THE TRACK INTO MEMORY.
5. REPEAT STEPS 3 AND 4 TO ENTER ADDITIONAL TRACKS INTO THE MEMORY IF NECESSARY.
6. WHEN ALL THE DESIRED TRACKS HAVE BEEN PROGRAMMED, PRESS "**PLAY/PAUSE**" ►|| BUTTON TO PLAY THE TRACKS IN ASSIGNED ORDER.
7. PRESS **STOP** ■ BUTTON TO STOP PLAYING OF PROGRAMMED TRACKES, PRESS **STOP** ■ BUTTON AGAIN TO CANCEL PROGRAMMING.

**COMPACT DISC (CD) PLAYBACK & ENCODING**

---

1. PRESS **CD/USB** BUTTON REPEATED TO SELECT "CD" ON DISPLAY.
2. PRESS **CD DOOR OPEN** BUTTON, CD DOOR WILL BE OPENED, PUT THE CD IN THE TRAY AND THEN CLOSE THE CD DOOR.
3. THE SYSTEM WILL START READING THE CD:

- **PLAY / PAUSE** ►||

- PRESS THE **PLAY/PAUSE** ►|| BUTTON ONCE TO HALT PLAYING, PRESS IT AGAIN TO CONTINUE.

- **STOP** ■

- PRESS THE **STOP** ■ BUTTON TO END UP AUDIO PLAYBACK, THEN DISPLAY WILL SHOW THE TOTAL NUMBER OF TRACKS. AND THEN USER CAN TURN **SKIP UP** ►►I / **SKIP DOWN** I◄◄ KNOB TO SELECT TRACKS.

- **SKIP UP** ►►I / **SKIP DOWN** I◄◄ **BUTTON**

- DURING CD PLAYBACK, PRESS **SKIP UP** ►►I BUTTON ONCE TO PLAY THE NEXT FILE. PRESS AND HOLD **SKIP UP** ►►I BUTTON CONTINUOUSLY TO SPEED UP SELECTING FORWARD
- DURING CD PLAYBACK, PRESS **TURN SKIP DOWN** I◄◄ BUTTON ONCE TO PLAY THE PREVIOUS FILE. PRESS AND HOLD **SKIP DOWN** I◄◄ BUTTON CONTINUOUSLY TO SPEED UP SELECTING BACKWARD.
- 

- **FOLDER SEARCHING**

TURN **ALBUM UP/DOWN** **BUTTON** TO SEARCH FOLDER BACKWARD OR FORWARD.

- **REPEAT FUNCTION**

DURING AUDIO PLAYBACK, PRESS **MODE** BUTTON ONCE, SINGLE TRACK WILL BE PLAYED

REPEATEDLY. PRESS **MODE** BUTTON AGAIN, IT WILL REPEATEDLY PLAY ALL TRACKS IN THE WHOLE CD.

### **TRACKS PROGRAMMING**

UP TO 99 MP3 TRACKS & 20 CD AUDIO FORMAT TRACK CAN BE PROGRAMMED AND PLAYED IN ANY ORDER. BEFORE USE, BE SURE THE SYSTEM IS AT STOP MODE BEFORE PROGRAMMING:

1. PRESS **CD/USB** BUTTON REPEATEDLY TO CHOOSE "CD" AND SET AT STOP MODE
2. PRESS THE **MODE** BUTTON, "MEM" WILL BE FLASHING ON LCD DISPLAY. MOREOVER, IT WILL INDICATE PROGRAM NO. AND DIGITS FOR TRACK NO. TO BE PROGRAMMED.
3. SELECT A DESIRED TRACK BY PRESSING **SKIP UP** ►| OR **SKIP DOWN** |◄◄ BUTTON. FOR MP3/WMA DISC, TURNING **ALBUM DOWN** OR **ALBUM UP** KNOB TO SEARCH FOLDER BACKWARD OR FORWARD.
4. PRESS THE **MODE** BUTTON TO STORE THE TRACK INTO MEMORY.
5. REPEAT STEPS 3 AND 4 TO ENTER ADDITIONAL TRACKS INTO THE MEMORY IF NECESSARY.
6. WHEN ALL THE DESIRED TRACKS HAVE BEEN PROGRAMMED, PRESS **PLAY/PAUSE** ►|| BUTTON TO PLAY THE TRACKS IN ASSIGNED ORDER.
7. PRESS **STOP** ■ BUTTON TO STOP PLAYING OF PROGRAMMED TRACKES, PRESS **STOP** ■ BUTTON AGAIN TO CANCEL PROGRAMMING.

### **BLUETOOTH CONNECTION**

- THIS UNIT HAVE BLUETOOTH FUNCTION, WHICH CAN CONNECT AND PLAY MUSIC FROM YOUR BLUETOOTH DEVICE (SUCH AS MOBILE PHONE).
- PRESS AND HOLD **CD/USB** BUTTON TILL DISPLAY SHOWS "BT", THEN **BT INDICATOR (BLUE COLOR)** WILL BE FLASHING, IT MEANS THE UNIT IS READY FOR CONNECTION WITH YOUR BLUETOOTH DEVICE.
- SWITCH ON THE BLUETOOTH FUNCTION OF YOUR BLUETOOTH DEVICE, AND SELECT "**QT62BT**" BLUETOOTH EQUIPMENT FOR CONNECTION.
- AFTER YOUR BLUETOOTH DEVICE IS CONNECTED WITH THE UNIT, **BT INDICATOR (BLUE COLOR)** WILL STAY ON, THEN START TO PLAYBACK YOUR DEVICE.

### **EARPHONE JACK**

- THIS SYSTEM CAN BE CONNECTED WITH HEADPHONE OR EXTERNAL AMPLIFIER / SPEAKER BY 3.5MM **EARPHONE JACK**.

### **POWER SAVING FEATURE:**

TO SAVE ENERGY, IF THERE IS NO AUDIO SIGNAL FROM CD / AUX IN / USB FOR A PERIOD OF OVER 10 MINUTES, THEN THE UNIT WILL AUTOMATICALLY SWITCH TO STANDBY MODE.

## REMOTE CONTROL BATTERY INSTALLATION

---

THE INFRA-RED TRANSMITTER REQUIRES 1 PC CR2025 LITHIUM BATTERY FOR OPERATION

### BUTTON DESCRIPTION

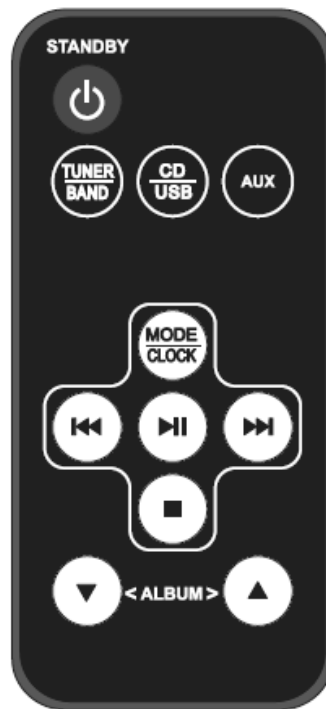

- 1 **STANDBY:** TRIGGER BETWEEN STANDBY MODE AND OPERATION MODE.
- 2 **TUNER/BAND:** PERFORM SAME FUNCTION AS “**AM/FM**” BUTTON ON THE UNIT.
- 3 **CD/USB:** PERFORM SAME FUNCTION AS “CD/USB” BUTTON ON THE UNIT.
- 4 **AUX:** PERFORM SAME FUNCTION AS “AUX” BUTTON ON THE UNIT.
- 5 **MODE/CLOCK:** PERFORM SAME FUNCTION AS “MODE/CLK” BUTTON ON THE UNIT.
- 6 **⏮ (SKIP DOWN ):** PERFORM SAME FUNCTION AS “**⏮ SKIP DOWN**” BUTTON ON THE UNIT.
- 7 **▶⏸ (PLAY/PAUSE):** PERFORM SAME FUNCTION AS “**▶⏸ PLAY/PAUSE**” BUTTON ON THE UNIT.
- 8 **⏭ (SKIP UP ):** PERFORM SAME FUNCTION AS “**⏭ SKIP UP**” BUTTON ON THE UNIT.
- 9 **■ (STOP):** PERFORM SAME FUNCTION AS “**■ STOP**” BUTTON ON THE UNIT.
- 10 **ALBUM DOWN:** PERFORM SAME FUNCTION AS “**ALBUM DOWN**” BUTTON ON THE UNIT.
- 11 **ALBUM UP:** PERFORM SAME FUNCTION AS “**ALBUM UP**” BUTTON ON THE UNIT.

#### FCC Warning Statement

Changes or modifications not expressly approved by the party responsible for compliance could void the user's authority to operate the equipment. This equipment has been tested and found to comply with the limits for a Class B digital device, pursuant to Part 15 of the FCC Rules. These limits are designed to provide reasonable protection against harmful interference in a residential installation. This equipment generates uses and can radiate radio frequency energy and, if not installed and used in accordance with the instructions, may cause harmful interference to radio communications. However, there is no guarantee that interference will not occur in a particular installation. If this equipment does cause harmful interference to radio or television reception, which can be determined by turning the equipment off and on, the user is encouraged to try to correct the interference by one or more of the following measures:

- - Reorient or relocate the receiving antenna.
- - Increase the separation between the equipment and receiver.
- - Connect the equipment into an outlet on a circuit different from that to which the receiver is connected.
- - Consult the dealer or an experienced radio/TV technician for help.

This device complies with part 15 of the FCC Rules. Operation is subject to the following two conditions: (1) This device may not cause harmful interference, and (2) this device must accept any interference received, including interference that may cause undesired operation.

The device has been evaluated to meet general RF exposure requirement.