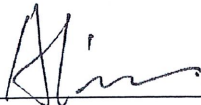

FCC RADIO TEST REPORT

Applicant..... : Shenzhen Interthings Technology Co., Ltd.
Address..... : Room305, T3 Building, Silicon Valley Compound,Longhua District, Shenzhen,
China.
Manufacturer..... : Shenzhen Interthings Technology Co., Ltd.
Address..... : Room305, T3 Building, Silicon Valley Compound,Longhua District, Shenzhen,
China.
Factory..... : YIBIN YINGTONG INTELLIGENT TECHNOLOGY CO.,LTD.
Address..... : 3F, Building 1, Area A, Intelligent Terminal Demonstraion park, Gangyuan Road
West,Yibin Economic Development Zone, YibinSi,Sichuan,China
Product Name..... : Digital Camera
Brand Name..... : Polaroid
Model No. : WDC508, IE50 (For model difference refer to section 2)
FCC ID..... : 2AQ7B-WDC508
Measurement Standard..... : 47 CFR FCC Part 15, Subpart C (Section 15.247)
Receipt Date of Samples.... : January 09, 2021
Date of Tested..... : January 09, 2021 to March 29, 2021
Date of Report..... : March 30, 2021

This report shows that above equipment is technically compliant with the requirements of the standards above. All test results in this report apply only to the tested sample(s). Without prior written approval of Dongguan Nore Testing Center Co., Ltd, this report shall not be reproduced except in full.

Prepared by

Alina Guo / Project Engineer

Approved by

Iori Fan / Authorized Signatory

Table of Contents

1. Summary of Test Result	4
2. General Description of EUT.....	5
3. Test Channels and Modes Detail	7
4. Configuration of EUT	7
5. Modification of EUT	7
6. Description of Support Device	8
7. Test Facility and Location.....	9
8. Applicable Standards and References	9
9. Deviations and Abnormalities from Standard Conditions	10
10. Test Conditions	10
11. Measurement Uncertainty	10
12. Sample Calculations.....	11
13. Duty Cycle of Test Signal	12
14. Test Items and Results.....	14
14.1 Conducted Emissions Measurement.....	14
14.2 Maximum Conducted Output Power Measurement.....	18
14.3 6dB Bandwidth Measurement	20
14.4 Power Spectral Density Measurement	24
14.5 Band Edge and Conducted Spurious Emissions Measurement	28
14.6 Radiated Spurious Emissions and Restricted Bands	32
14.7 Antenna Requirement	39
15. Test Equipment List.....	40

1. Summary of Test Result

FCC Rules	Description of Test	Result	Remarks
§15.207 (a)	AC Power Conducted Emission	PASS	---
§15.247(b)(3)	Maximum Conducted Output Power	PASS	---
§15.247(a)(2)	6dB Bandwidth	PASS	---
§15.247(e)	Power Spectral Density	PASS	---
§15.247(d)	Band Edge and Conducted Spurious Emissions	PASS	---
§15.247(d), §15.209, §15.205	Radiated Spurious Emissions and Restricted Bands	PASS	---
§15.203	Antenna Requirement	PASS	---

2. General Description of EUT

Product Information	
Product Name:	Digital Camera
Main Model Name:	WDC508
Additional Model Name:	IE50
Model Difference:	Both models have the same circuitry, electrical mechanical, PCB Layout and physical construction. The differences are model number due to marketing purpose.
S/N:	2101-0084
Brand Name:	Polaroid
Hardware Version:	V1.1
Software Version:	594
Rating:	DC 5V come from SUB port DC 3.7V come from internal battery
Typical arrangement:	Table-top
I/O Port:	SD card port*1, USB port*1
Accessories Information	
Adapter:	N/A
Cable:	N/A
Other:	N/A
Additional Information	
Note:	According to the model difference, all tests were performed on model WDC508.
Remark:	All the information above are provided by the manufacturer. More detailed feature of the EUT please refers to the user manual.

Technical Specification	
Frequency Range:	2412-2462MHz for IEEE 802.11b/g/n(HT20)
Modulation Technology:	DSSS, OFDM
Modulation Type:	CCK, DQPSK, DBPSK, 64-QAM, 16-QAM, QPSK, BPSK
Number of Channel:	11 for IEEE 802.11b/g/n(HT20)
Channel Space:	5MHz
Antenna Type:	PCB antenna
Antenna Gain:	2dBi (Declared by the manufacturer)

Channel List			
IEEE 802.11b/ g/ n(HT20)			
Channel	Frequency (MHz)	Channel	Frequency (MHz)
1	2412	7	2442
2	2417	8	2447
3	2422	9	2452
4	2427	10	2457
5	2432	11	2462
6	2437	----	----

3. Test Channels and Modes Detail

Mode		Channel	Frequency (MHz)	Remark
1	TX	1	2412	IEEE 802.11b/ g/ n(HT20)
		6	2437	IEEE 802.11b/ g/ n(HT20)
		11	2462	IEEE 802.11b/ g/ n(HT20)
2.	Normal Mode	---	---	---

Note: TX mode means that the EUT was programmed to be in continuously transmitting mode.

4. Configuration of EUT

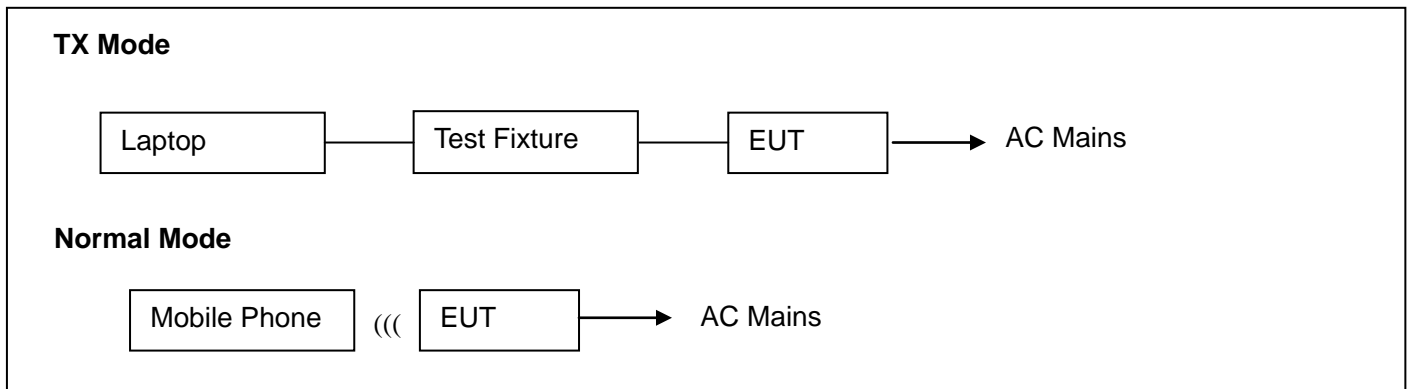

5. Modification of EUT

No modifications are made to the EUT during all test items.

6. Description of Support Device

The EUT has been tested as an independent unit together with other necessary accessories or support units. The following support units or accessories were used to form a representative test configuration during the tests.

No.	Equipment	Brand	M/N	S/N	Cable Specification	Remarks
1.	Laptop	Lenovo	02213DC	0A33012	Power cord, 1.8m, unshielded	---
2.	Power supply (Laptop)	Delta	92P1154	N/A		---
3.	Test fixture	---	---	---	---	Provided by the laboratory
4.	Mobile Phone	APPLE	MD298CH/A	DNQK31HE DTWF	---	---

Software	Power Setting
JL2380_ISP	Default

7. Test Facility and Location

Test Site	:	Dongguan Nore Testing Center Co., Ltd. (Dongguan NTC Co., Ltd.)
Accreditations and Authorizations	:	<p>The Laboratory has been assessed and proved to be in compliance with CNAS/CL01 Listed by CNAS, August 13, 2018 The Certificate Registration Number is L5795. The Certificate is valid until August 13, 2024</p> <p>The Laboratory has been assessed and proved to be in compliance with ISO17025 Listed by A2LA, November 01, 2017 The Certificate Registration Number is 4429.01 The Certificate is valid until December 31, 2021</p> <p>Listed by FCC, November 06, 2017 Test Firm Registration Number is 907417</p> <p>Listed by Industry Canada, June 08, 2017 The Certificate Registration Number is 46405-9743A</p>
Test Site Location	:	Building D, Gaosheng Science and Technology Park, Hongtu Road, Nancheng District, Dongguan City, Guangdong Province, China

8. Applicable Standards and References

According to the specifications of the manufacturer, the EUT must comply with the requirements of the following standards:

Test Standards:

47 CFR Part 15, Subpart C, 15.247

ANSI C63.10-2013

References Test Guidance:

DTS KDB 558074 D01 15.247 Meas Guidance v05r02

9. Deviations and Abnormalities from Standard Conditions

No additions, deviations and exclusions from the standard.

10. Test Conditions

No.	Test Item	Test Mode	Test Voltage	Tested by	Remarks
1.	AC Power Conducted Emission	2	AC 120V 60Hz	Ray Ding	See note 1
2.	Max. Conducted Output Power	1	DC 3.7V	Ray Ding	See note 1
3.	6dB Bandwidth	1	DC 3.7V	Ray Ding	See note 1
4.	Power Spectral Density	1	DC 3.7V	Ray Ding	See note 1
5.	Band Edge and Conducted Spurious Emissions	1	DC 3.7V	Ray Ding	See note 1
6.	Radiated Spurious Emissions and Restricted Bands	1, 2	AC 120V 60Hz, DC 3.7V	Ray Ding	See note 1
7..	Antenna Requirement	---	---	---	See note 1

Note:

1. The testing climatic conditions for temperature, humidity, and atmospheric pressure are within: 15~35°C, 30~70%, 86~106kPa.
2. As the EUT can be operated multiple positions, all X,Y,Z axis were considered during the test and only the worst case X was recorded.

11. Measurement Uncertainty

No.	Test Item	Frequency	Uncertainty	Remarks
1.	Conducted Emission	150KHz ~ 30MHz	±2.52 dB	---
2.	Radiated Emission Test	9kHz ~ 30MHz	±2.60 dB	---
		30MHz ~ 1GHz	±4.68 dB	---
		1GHz ~ 18GHz	±5.14 dB	---
		18GHz ~ 40GHz	±5.14 dB	---

Note:

1. This uncertainty represents an expanded uncertainty expressed at approximately the 95% confidence level using a coverage factor of k=2.
2. The measurement uncertainty levels above are estimated and calculated according to CISPR 16-4-2.
3. The conformity assessment statement in this report is based solely on the test results, measurement uncertainty is excluded.

12. Sample Calculations

Conducted Emission						
Freq. (MHz)	Reading Level (dBuV)	Correct Factor (dB)	Measurement (dBuV)	Limit (dBuV)	Over (dB)	Detector
0.1900	30.10	10.60	40.70	79.00	-38.30	QP
Where, Freq. = Emission frequency in MHz Reading Level = Uncorrected Analyzer/Receiver reading Corrector Factor = Insertion loss of LISN + Cable Loss + RF Switching Unit attenuation Measurement = Reading + Corrector Factor Limit = Limit stated in standard Margin = Measurement - Limit Detector = Reading for Quasi-Peak / Average / Peak						

Radiated Spurious Emissions and Restricted Bands						
Freq. (MHz)	Reading Level (dBuV)	Correct Factor (dB/m)	Measurement (dBuV/m)	Limit (dBuV/m)	Over (dB)	Detector
60.0700	45.88	-18.38	27.50	49.00	-21.50	QP
Where, Freq. = Emission frequency in MHz Reading Level = Uncorrected Analyzer/Receiver reading Corrector Factor = Antenna Factor + Cable Loss - Pre-amplifier Measurement = Reading + Corrector Factor Limit = Limit stated in standard Over = Margin, which calculated by Measurement - Limit Detector = Reading for Quasi-Peak / Average / Peak						

Note: For all conducted test items, the spectrum analyzer offset or transducer is derived from RF cable loss and attenuator factor. The offset or transducer is equal to the RF cable loss plus attenuator factor.

13. Duty Cycle of Test Signal

Frequency MHz	Ton time (ms)	Ton time + off (ms)	Duty cycle	Duty cycle Factor
IEEE 802.11b	2437	0.986	84.42%	0.74
IEEE 802.11g	2437	0.994	91.03%	0.41

Test Plots - IEEE 802.11b

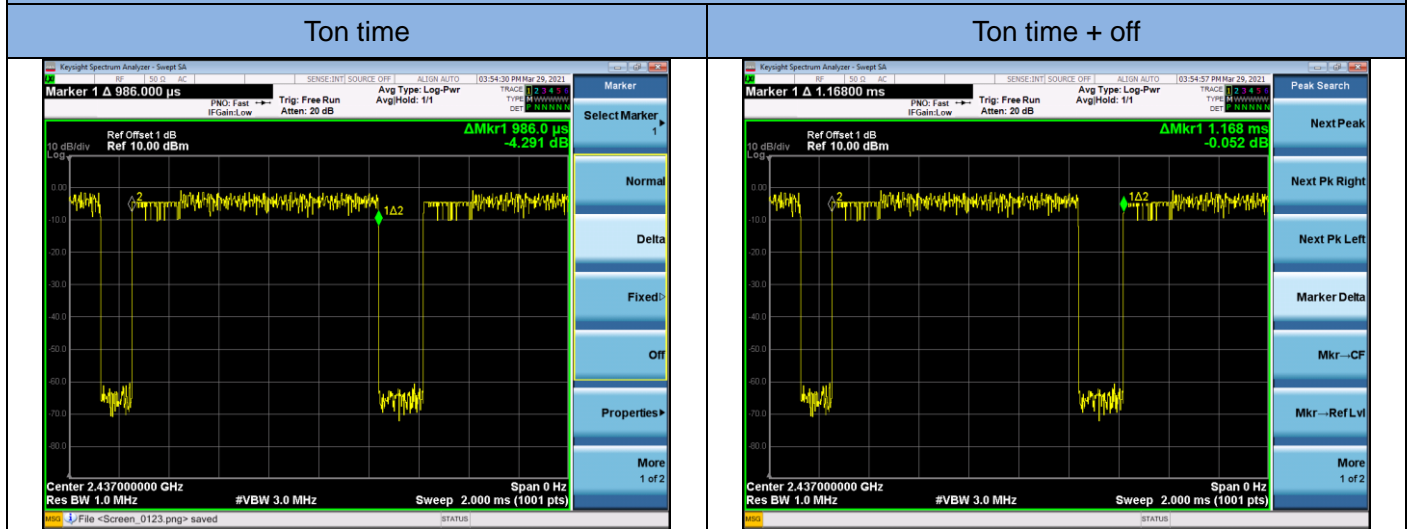

Test Plots - IEEE 802.11g

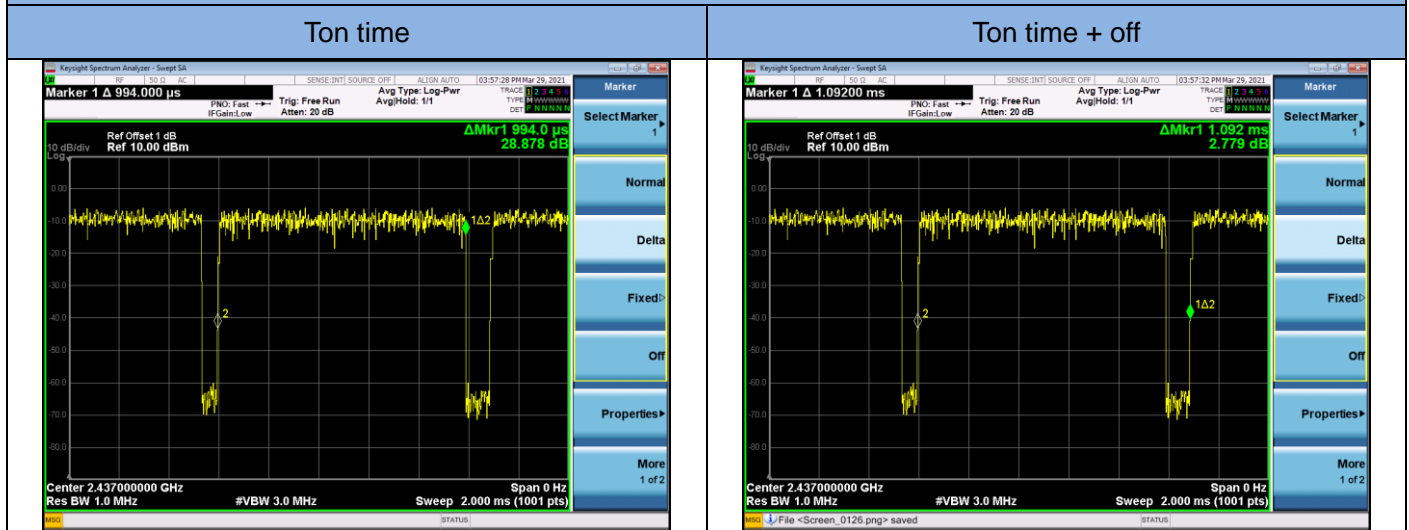

Note: If Duty Cycle of test signal is $\geq 98\%$, Duty cycle factor is not required.

$$\text{Duty Cycle} = (\text{Ton time} + \text{off} / \text{Ton time}) \times 100\%$$

$$\text{Duty Cycle Factor} = 10 \times \log(1/\text{Duty Cycle})$$

The test results are for reference only.

Frequency MHz		Ton time (ms)	Ton time + off (ms)	Duty cycle	Duty cycle Factor
IEEE 802.11n(HT20)	2437	0.994	1.156	85.99%	0.66

Test Plots - IEEE 802.11n(HT20)

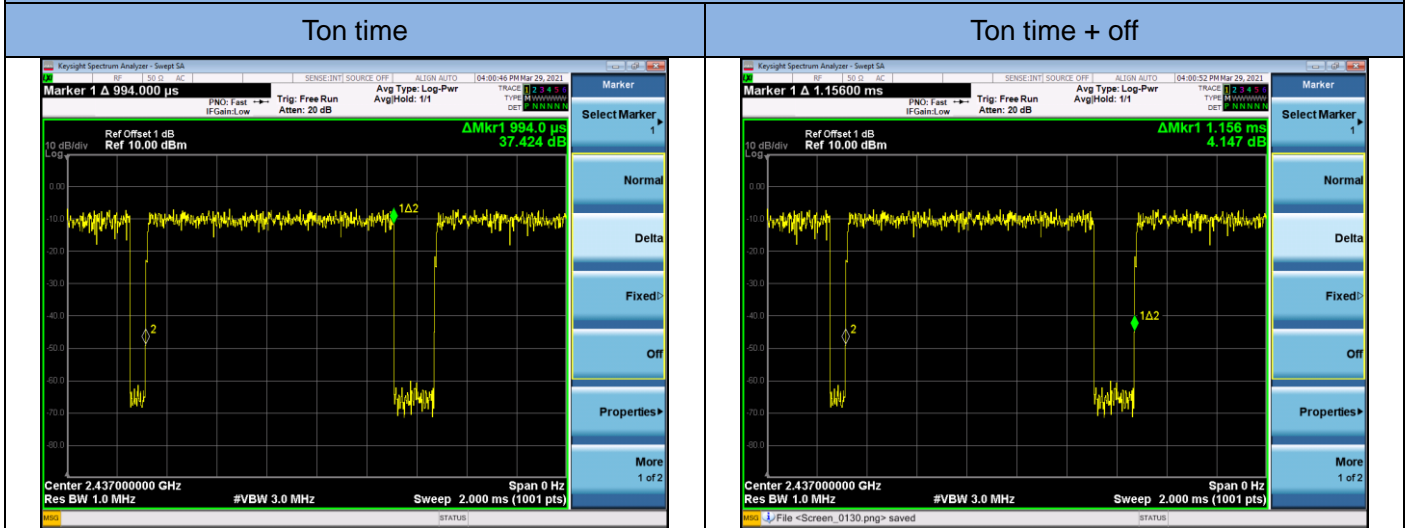

Note: If Duty Cycle of test signal is $\geq 98\%$, Duty cycle factor is not required.

$$\text{Duty Cycle} = (\text{Ton time} + \text{off} / \text{Ton time}) \times 100\%$$

$$\text{Duty Cycle Factor} = 10 \times \log(1/\text{Duty Cycle})$$

The test results are for reference only.

14. Test Items and Results

14.1 Conducted Emissions Measurement

LIMIT

According to the requirements of FCC PART 15.207, the limits are as follows:

Frequency (MHz)	Quasi-peak	Average
0.15 to 0.5	66 to 56	56 to 46
0.5 to 5	56	46
5 to 30	60	50

- Note:
1. If the limits for the average detector are met when using the quasi-peak detector, then the limits for the measurements with the average detector are considered to be met.
 2. The lower limit shall apply at the transition frequencies.
 3. The limit decreases linearly with the logarithm of the frequency in the range 0.15 MHz to 0.5MHz.

BLOCK DIAGRAM OF TEST SETUP

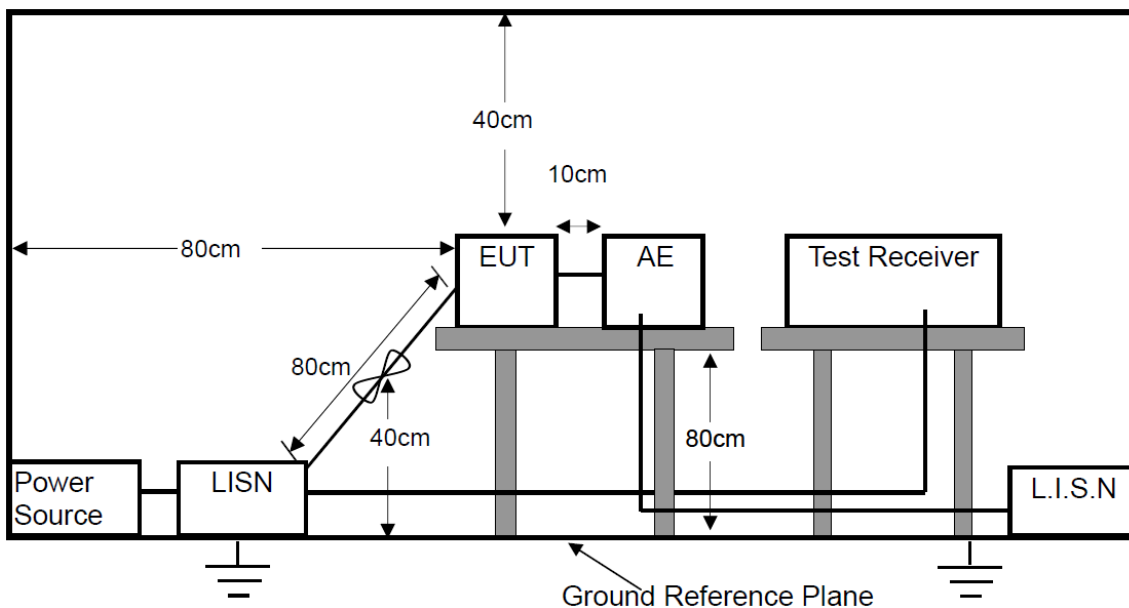

TEST PROCEDURES

- a. The EUT was placed on a wooden table 0.8m height from the metal ground plan and 0.4m from the conducting wall of the shielding room and it was kept at 0.8m from any other grounded conducting surface.
- b. All I/O cables and support devices were positioned as per ANSI C63.10.
- c. Connect mains power port of the EUT to a line impedance stabilization network (LISN).
- d. Connect all support devices to the other LISN and AAN, if needed.
- e. Scan the frequency range from 150KHz to 30MHz at both sides of AC line for maximum conducted interference checking and record the test data.

TEST RESULTS

PASS

Please refer to the following pages.

M/N: WDC508	Testing Voltage: AC 120V 60Hz
Phase: L1	Detector: QP & AVG
Test Mode: 2	

Conducted Emission Measurement

Date: 2021/1/18

Time: 10:41:07

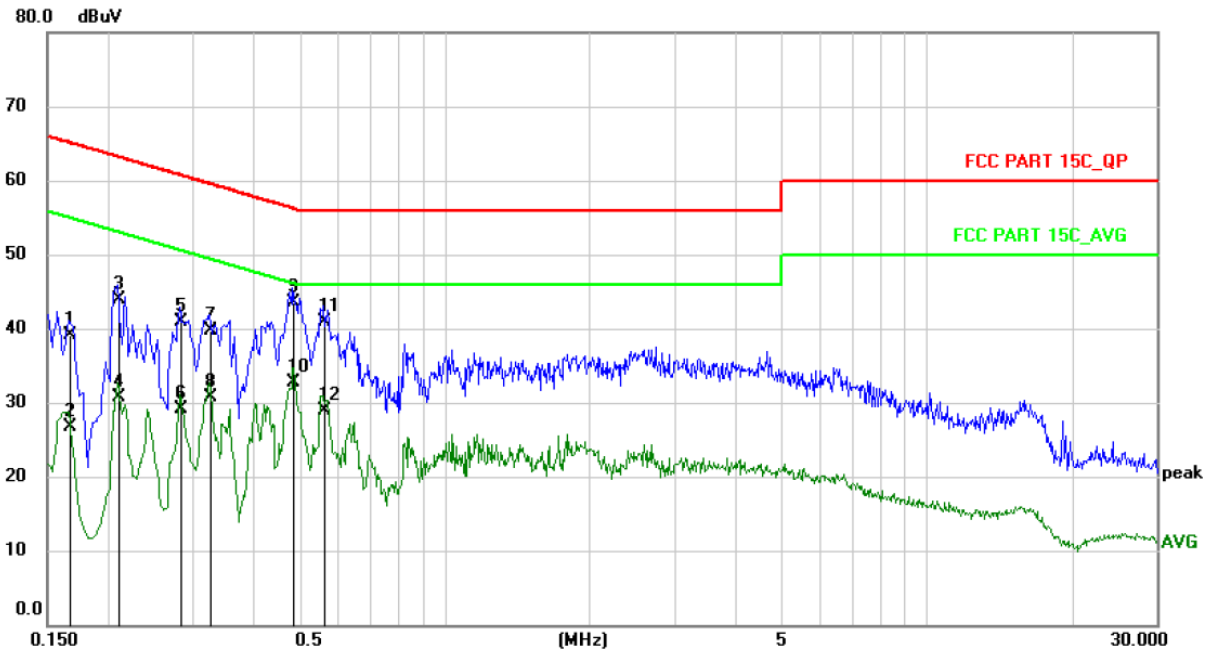

No. Mk.	Freq.	Reading Level	Correct Factor	Measurement	Limit	Over	Detector	Comment
	MHz	dBuV	dB	dBuV	dBuV	dB		
1	0.1660	28.60	10.60	39.20	65.16	-25.96	QP	
2	0.1660	16.10	10.60	26.70	55.16	-28.46	AVG	
3	0.2100	33.30	10.60	43.90	63.21	-19.31	QP	
4	0.2100	20.10	10.60	30.70	53.21	-22.51	AVG	
5	0.2819	30.30	10.60	40.90	60.76	-19.86	QP	
6	0.2819	18.50	10.60	29.10	50.76	-21.66	AVG	
7	0.3260	29.20	10.60	39.80	59.55	-19.75	QP	
8	0.3260	20.10	10.60	30.70	49.55	-18.85	AVG	
9 *	0.4860	32.97	10.63	43.60	56.24	-12.64	QP	
10	0.4860	22.17	10.63	32.80	46.24	-13.44	AVG	
11	0.5620	30.36	10.64	41.00	56.00	-15.00	QP	
12	0.5620	18.36	10.64	29.00	46.00	-17.00	AVG	

M/N: WDC508	Testing Voltage: AC 120V 60Hz
Phase: N	Detector: QP & AVG
Test Mode: 2	

Conducted Emission Measurement

Date: 2021/1/18

Time: 10:48:00

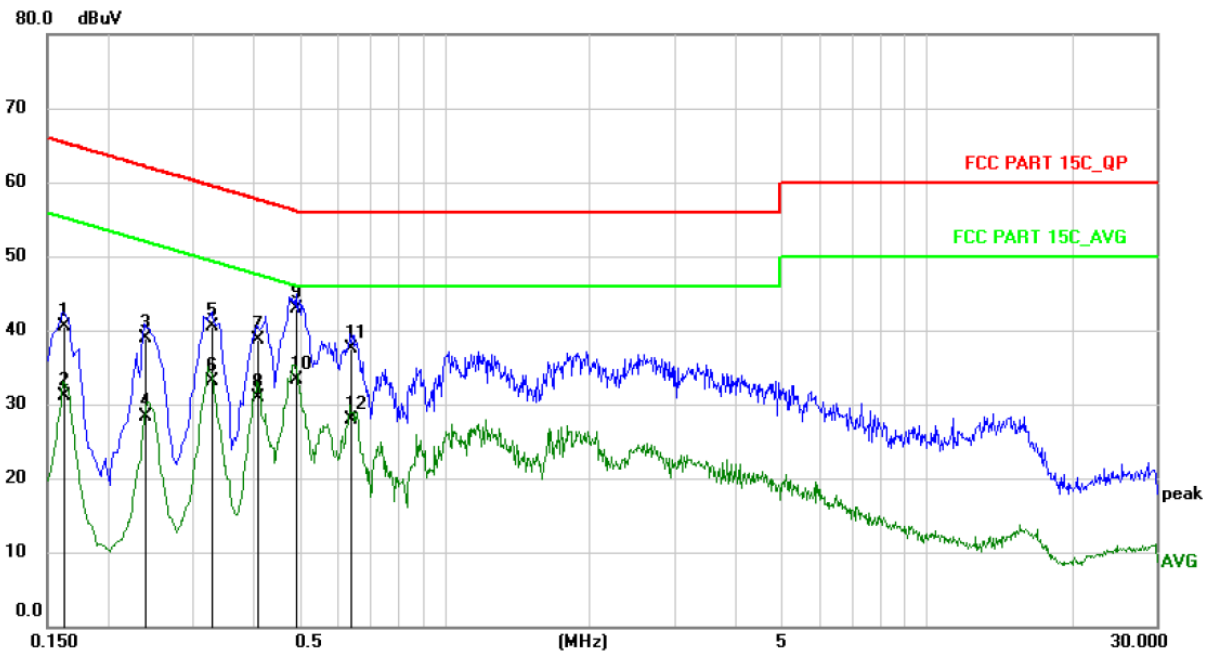

No. Mk.	Freq.	Reading Level	Correct Factor	Measurement	Limit	Over	Detector	Comment
	MHz	dBuV	dB	dBuV	dBuV	dB		
1	0.1620	30.00	10.60	40.60	65.36	-24.76	QP	
2	0.1620	20.50	10.60	31.10	55.36	-24.26	AVG	
3	0.2380	28.30	10.60	38.90	62.17	-23.27	QP	
4	0.2380	17.80	10.60	28.40	52.17	-23.77	AVG	
5	0.3300	29.90	10.60	40.50	59.45	-18.95	QP	
6	0.3300	22.60	10.60	33.20	49.45	-16.25	AVG	
7	0.4100	28.08	10.62	38.70	57.65	-18.95	QP	
8	0.4100	20.38	10.62	31.00	47.65	-16.65	AVG	
9	0.4940	32.27	10.63	42.90	56.10	-13.20	QP	
10 *	0.4940	22.77	10.63	33.40	46.10	-12.70	AVG	
11	0.6380	26.95	10.65	37.60	56.00	-18.40	QP	
12	0.6380	17.25	10.65	27.90	46.00	-18.10	AVG	

14.2 Maximum Conducted Output Power Measurement

LIMIT

For system using digital modulation in the 2400-2483.5 MHz bands, the limit for peak output power is 1 Watt.

If the transmitting antenna of directional gain greater than 6dBi are used the peak output power from the intentional radiator shall be reduced below the above stated value by the amount in dB that the directional gain of the Antenna exceeds 6dBi.

In case of point-to-point operation, the limit has to be reduced by 1dB for every 3dB that the directional gain of Antenna exceeds 6dBi.

BLOCK DIAGRAM OF TEST SETUP

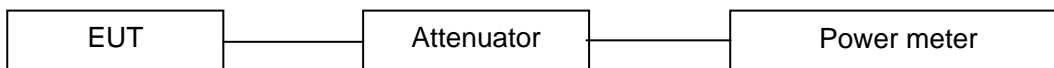

TEST PROCEDURES

ANSI C63.10 - 2013, Section 11.9.1.3

ANSI C63.10 - 2013, Section 11.9.2.3.2

TEST RESULTS

PASS

Please refer to the following table.

Temperature: 24°C		Humidity: 48%		Test Date: 2021-03-29	
Channel	Frequency (MHz)	Data Rate (Mbps)	Peak Output Power (dBm)	Limit (dBm)	Result
IEEE 802.11b					
1	2412	1	8.19	≤30	PASS
6	2437	1	8.30	≤30	PASS
11	2462	1	7.76	≤30	PASS
IEEE 802.11g					
1	2412	6	7.89	≤30	PASS
6	2437	6	7.79	≤30	PASS
11	2462	6	7.35	≤30	PASS
IEEE 802.11n(HT20)					
1	2412	MCS0	7.05	≤30	PASS
6	2437	MCS0	7.35	≤30	PASS
11	2462	MCS0	6.63	≤30	PASS

14.3 6dB Bandwidth Measurement

LIMIT

The minimum 6dB bandwidth shall be at least 500 kHz

BLOCK DIAGRAM OF TEST SETUP

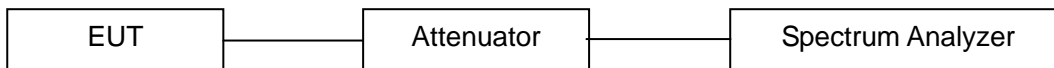

TEST PROCEDURES

The antenna port of the EUT was connected to the input of a spectrum analyzer. Analyzer was set as below according to DTS KDB 558074 D01 15.247 Meas Guidance v05r02:

- a. Set the RBW = 100KHz.
- b. Set the VBW $\geq 3 \times$ RBW
- c. Set the Detector = peak.
- d. Set the Sweep time = auto couple.
- e. Set the Trace mode = max hold.
- f. Allow trace to fully stabilize.
- g. Measure the maximum width of the emission that is constrained by the frequencies associated with the two outermost amplitude points (upper and lower frequencies) that are attenuated by 6 dB relative to the maximum level measured in the fundamental emission.

TEST RESULTS

PASS

Please refer to the following tables.

Temperature: 24°C			Humidity: 48%	Test Date: 2021-03-29		
Channel	Frequency (MHz)	Data Rate (Mbps)	6dB Bandwidth (MHz)	99% Bandwidth (MHz)	Limit (MHz)	Result
IEEE 802.11b						
1	2412	1	10.04	---	>0.5	PASS
6	2437	1	9.58	---	>0.5	PASS
11	2462	1	9.59	---	>0.5	PASS
IEEE 802.11g						
1	2412	6	16.06	---	>0.5	PASS
6	2437	6	15.69	---	>0.5	PASS
11	2462	6	16.36	---	>0.5	PASS
IEEE 802.11n(HT20)						
1	2412	MCS0	16.29	---	>0.5	PASS
6	2437	MCS0	16.31	---	>0.5	PASS
11	2462	MCS0	15.69	---	>0.5	PASS

Test Plots of 6dB Bandwidth

IEEE 802.11b - 2412MHz

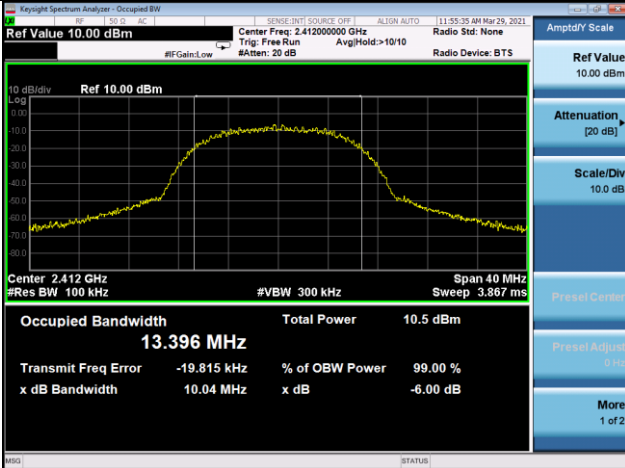

IEEE 802.11b - 2437MHz

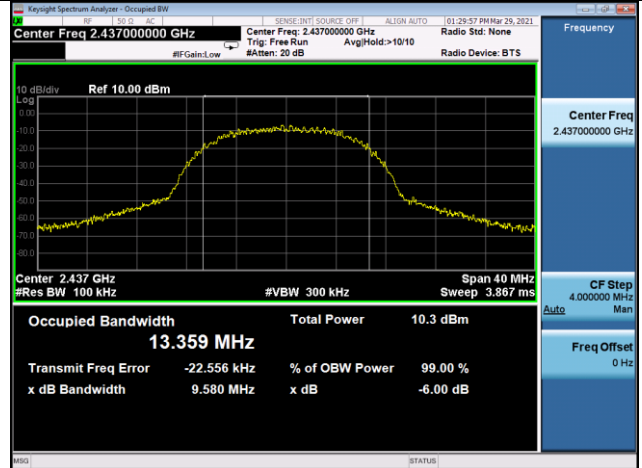

IEEE 802.11b - 2462MHz

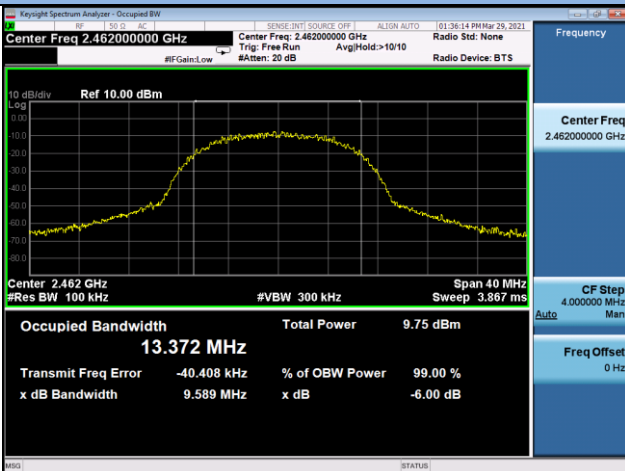

IEEE 802.11g - 2412MHz

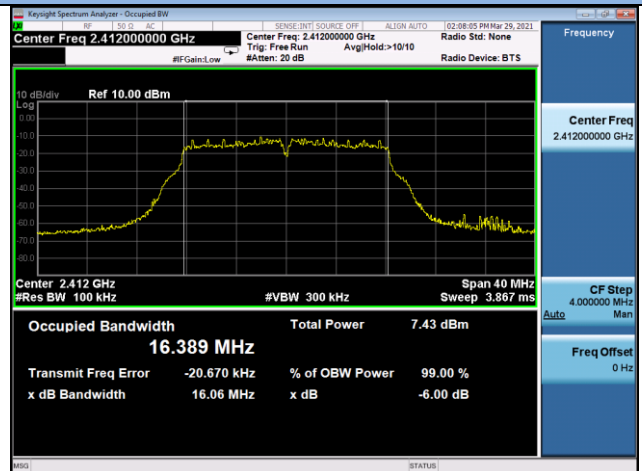

IEEE 802.11g - 2437MHz



IEEE 802.11g - 2462MHz

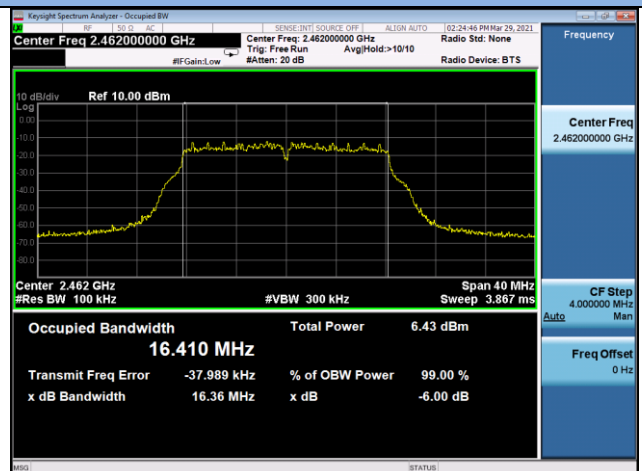

Test Plots of 6dB Bandwidth

IEEE 802.11n(HT20) - 2412MHz

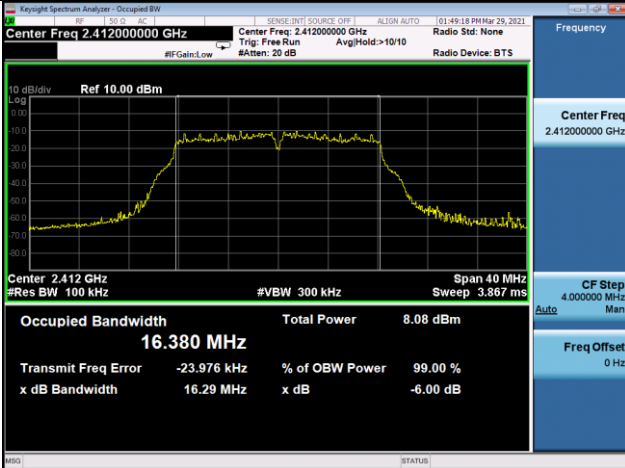

IEEE 802.11n(HT20) - 2437MHz

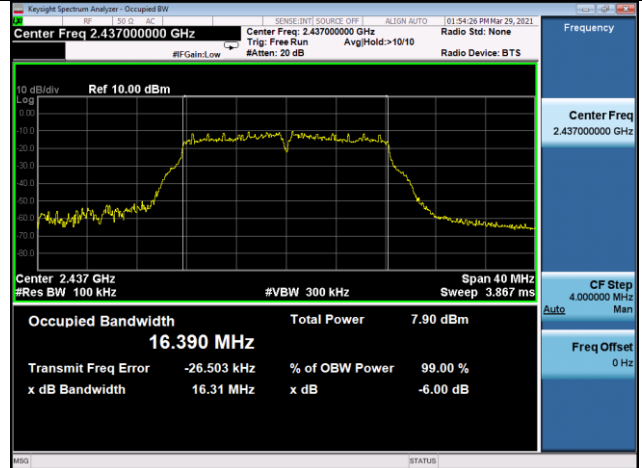

IEEE 802.11n(HT20) - 2462MHz

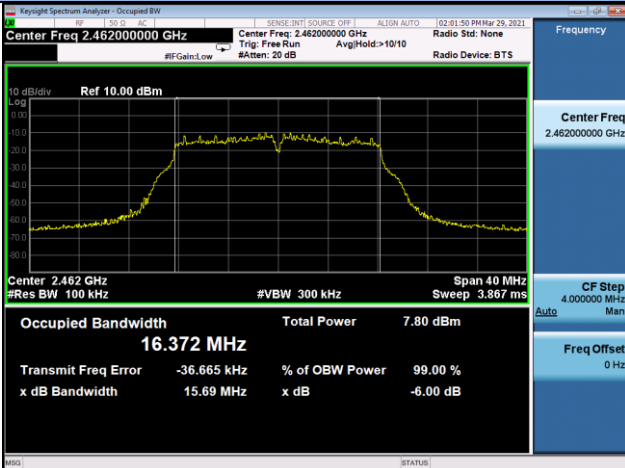

14.4 Power Spectral Density Measurement

LIMIT

The Maximum of Power Spectral Density Measurement is 8dBm in any 3 kHz.

BLOCK DIAGRAM OF TEST SETUP

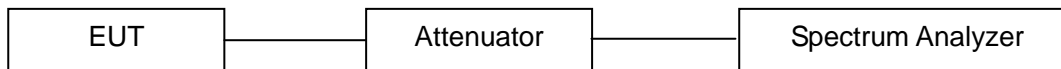

TEST PROCEDURES

The antenna port of the EUT was connected to the input of a spectrum analyzer. Analyzer was set as below according to FCC DTS KDB 558074 D01 15.247 Meas Guidance v05r02:

- a. Set analyzer center frequency to DTS channel center frequency.
- b. Set the span to 1.5 times the DTS bandwidth.
- c. Set the RBW to: $3 \text{ kHz} \leq \text{RBW} \leq 100\text{KHz}$
- d. Set the VBW $\geq 3 \times \text{RBW}$.
- e. Set the Detector = peak.
- f. Set the Sweep time = auto couple.
- g. Set the Trace mode = max hold.
- h. Allow trace to fully stabilize.
- i. Use the peak marker function to determine the maximum amplitude level within the RBW.
- j. If measured value exceeds limit, reduce RBW (no less than 3 kHz) and repeat.

TEST RESULTS

PASS

Please refer to the following table.

Temperature: 24°C			Humidity: 48%		Test Date: 2021-01-15, 2021-01-20	
Channel	Frequency (MHz)	Data Rate (Mbps)	PSD dBm / 3kHz	Limit dBm / 3kHz	Result	
IEEE 802.11b						
1	2412	1	-21.188	8	PASS	
6	2437	1	-21.523	8	PASS	
11	2462	1	-18.175	8	PASS	
IEEE 802.11g						
1	2412	6	-25.601	8	PASS	
6	2437	6	-24.950	8	PASS	
11	2462	6	-25.763	8	PASS	
IEEE 802.11n(HT20)						
1	2412	MCS0	-26.602	8	PASS	
6	2437	MCS0	-27.106	8	PASS	
11	2462	MCS0	-27.646	8	PASS	

Test Plots of Power Spectral Density

IEEE 802.11b - 2412MHz

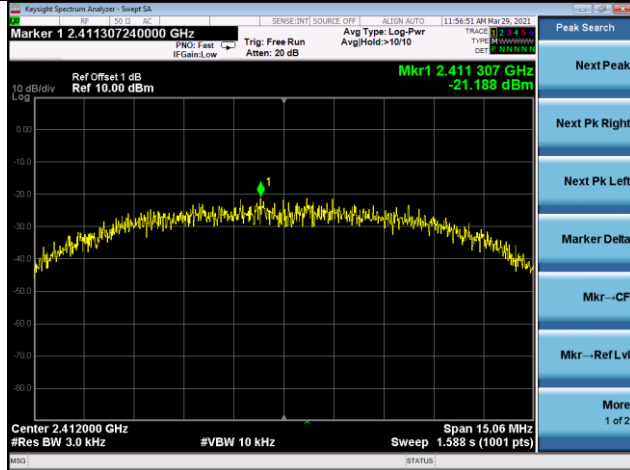

IEEE 802.11b - 2437MHz

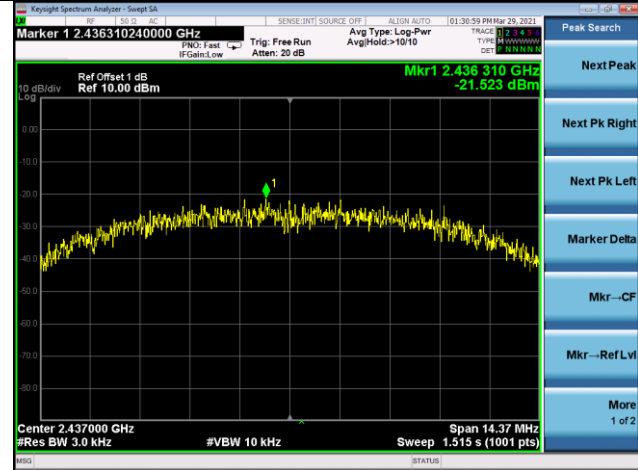

IEEE 802.11b - 2462MHz

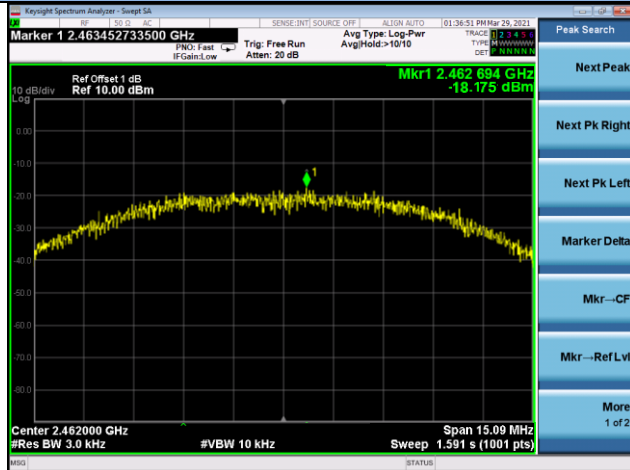

IEEE 802.11g - 2412MHz

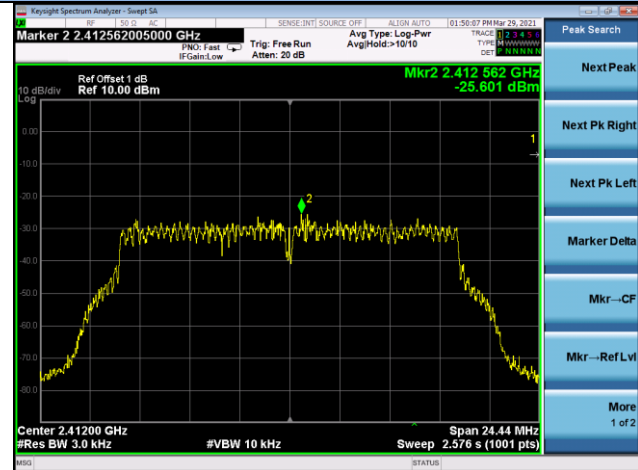

IEEE 802.11g - 2437MHz

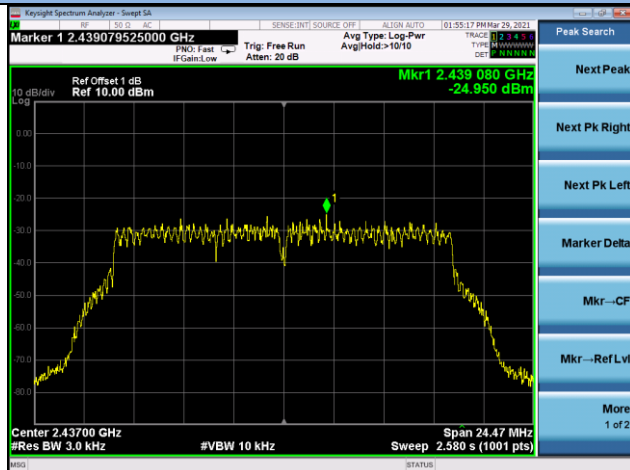

IEEE 802.11g - 2462MHz

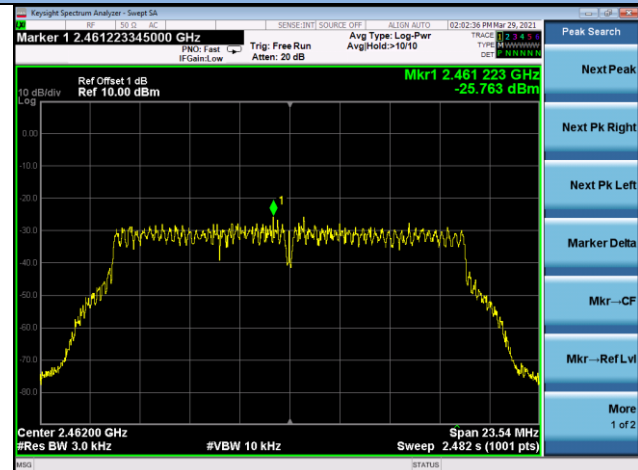

Test Plots of Power Spectral Density

IEEE 802.11n(HT20) - 2412MHz

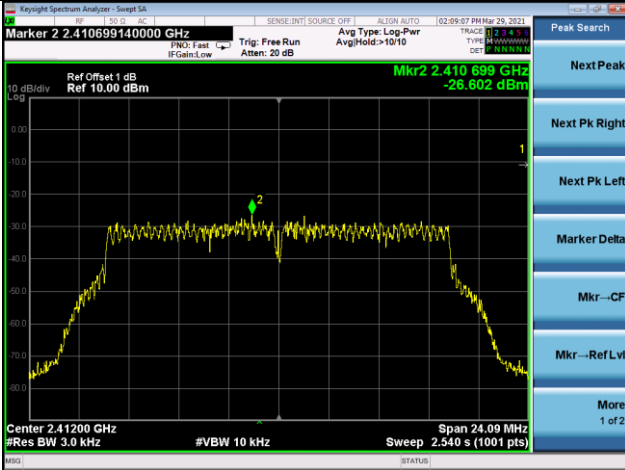

IEEE 802.11n(HT20) - 2437MHz

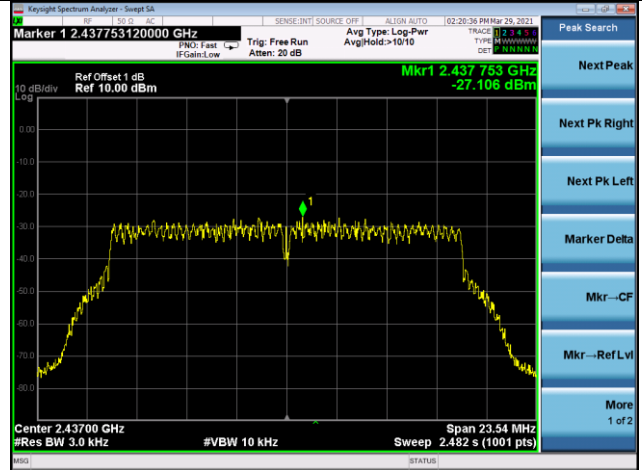

IEEE 802.11n(HT20) - 2462MHz

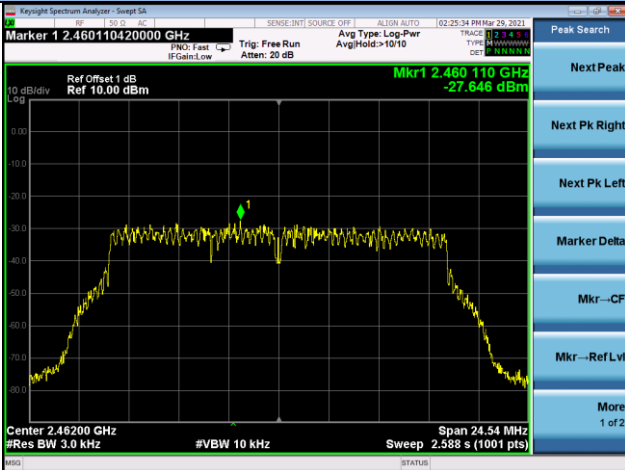

14.5 Band Edge and Conducted Spurious Emissions Measurement

LIMIT

In any 100KHz bandwidth outside the frequency band in which the spread spectrum intentional radiator is operating, the radio frequency power that is produced by the intentional radiator shall be at least 20dB below that in the 100KHz bandwidth within the band that contains the highest level of the desired power, based on either an RF conducted or a radiated measurement.

BLOCK DIAGRAM OF TEST SETUP

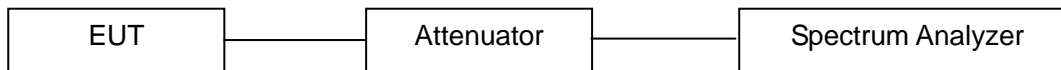

TEST PROCEDURES

The antenna port of the EUT was connected to the input of a spectrum analyzer. Analyzer was set as below according to ANSI C63.10-2013, Section 11.11

Measurement Procedure REF

- a. Set the RBW = 100 kHz.
- b. Set the VBW \geq 300 kHz.
- c. Set the Detector = peak.
- d. Set the Sweep time = auto couple.
- e. Trace mode = max hold.
- f. Allow trace to fully stabilize.
- g. Use the peak marker function to determine the maximum power level in any 100 kHz band segment within the fundamental EBW.

Measurement Procedure OOBE

- a. Set RBW = 100 kHz.
- b. Set VBW \geq 300 kHz.
- c. Set the Detector = peak.
- d. Set the Sweep = auto couple.
- e. Set the Trace Mode = max hold.
- f. Allow trace to fully stabilize.
- g. Use the peak marker function to determine the maximum amplitude level.

TEST RESULTS

PASS

Please refer to the following test plots.

Band Edge

IEEE 802.11b / Low Channel

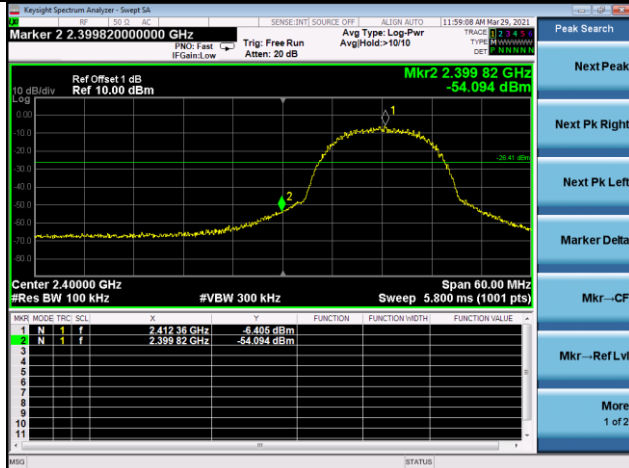

IEEE 802.11b / High Channel

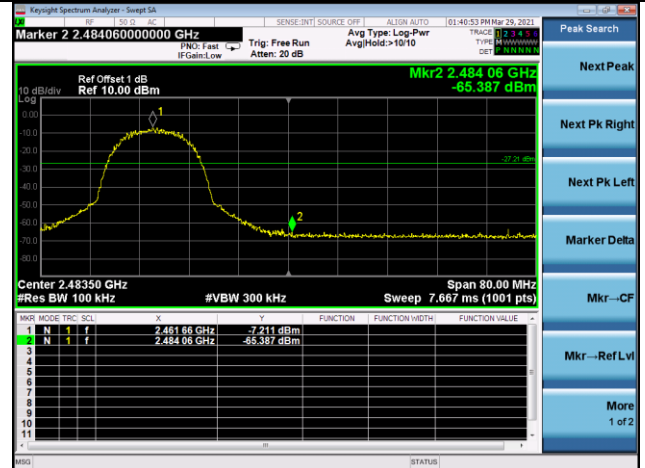

IEEE 802.11g / Low Channel

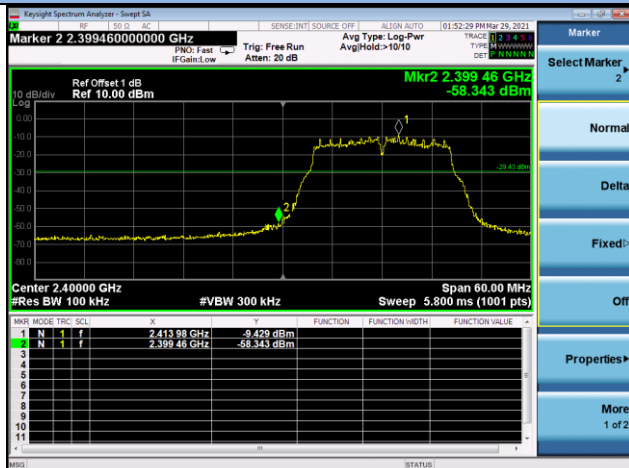

IEEE 802.11g / High Channel

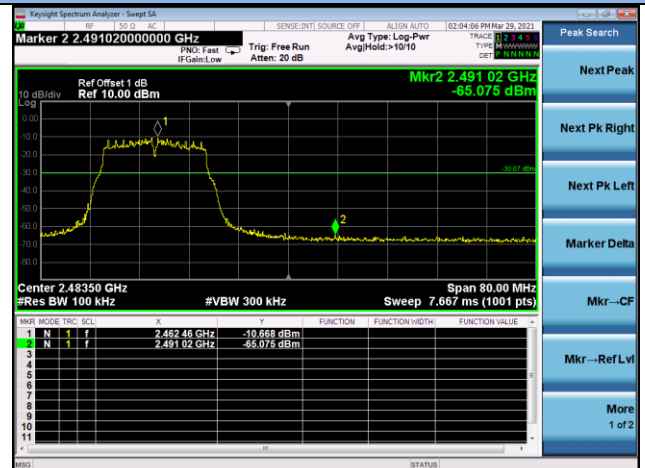

IEEE 802.11n(HT20) / Low Channel

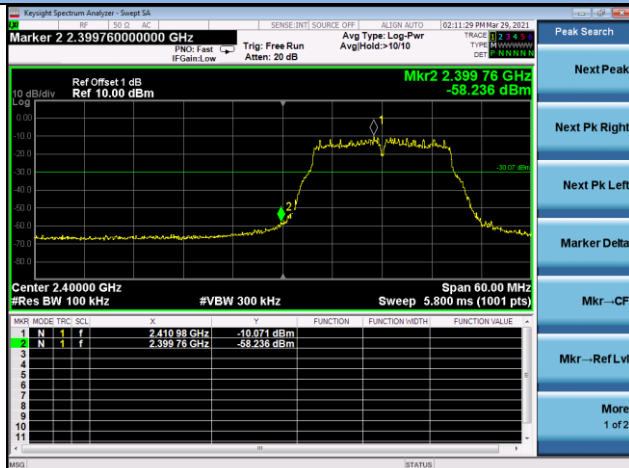

IEEE 802.11n(HT20) / High Channel

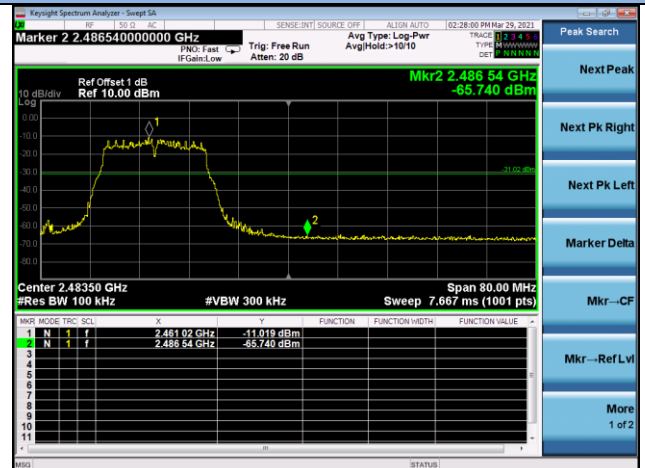

Conducted Spurious Emissions – IEEE 802.11b (The Worst Case)

Low Channel / 30MHz~1GHz

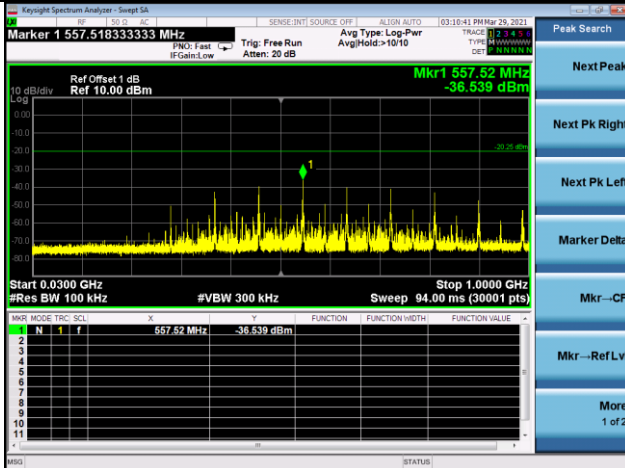

Low Channel / 1GHz~25GHz

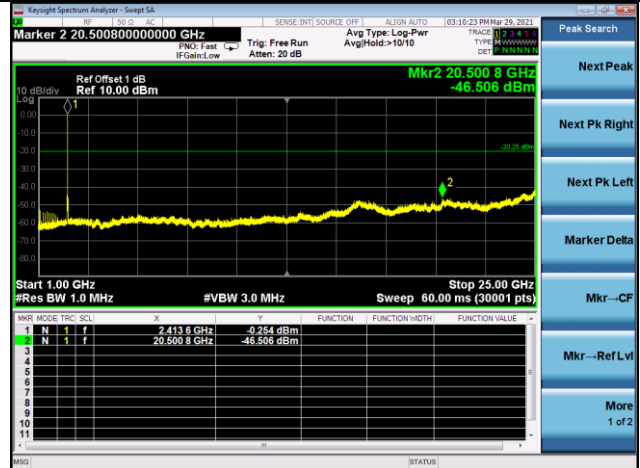

Middle Channel / 30MHz~1GHz

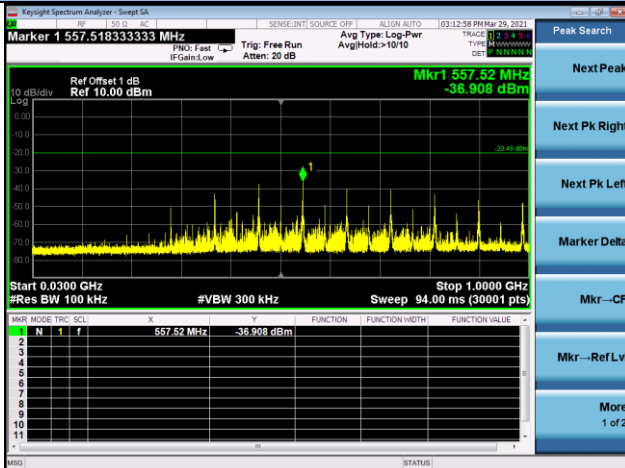

Middle Channel / 1GHz~25GHz

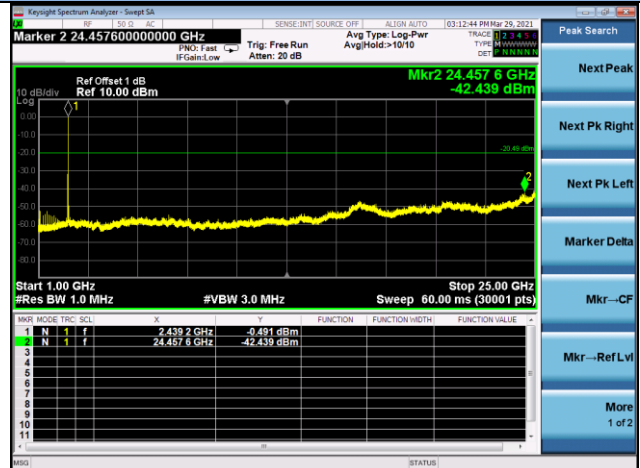

High Channel / 30MHz~1GHz

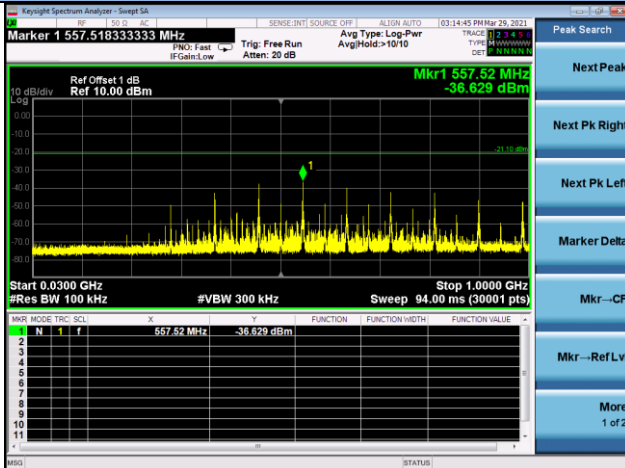

High Channel / 1GHz~25GHz

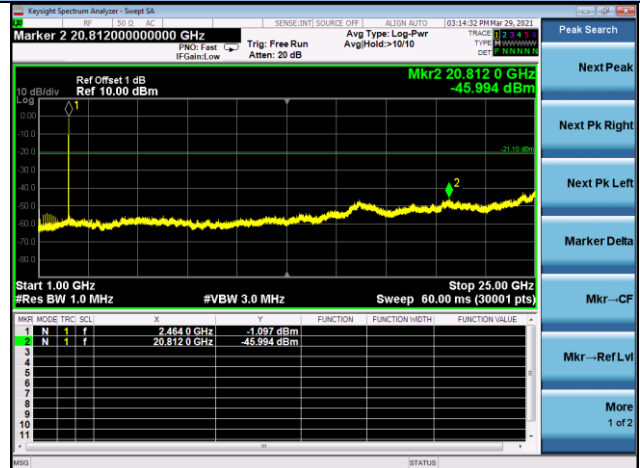

14.6 Radiated Spurious Emissions and Restricted Bands Measurement

LIMIT

Frequency range MHz	Distance Meters	Field Strengths Limit (15.209)
		μV/m
0.009 ~ 0.490	300	2400/F(kHz)
0.490 ~ 1.705	30	24000/F(kHz)
1.705 ~ 30	30	30
30 ~ 88	3	100
88 ~ 216	3	150
216 ~ 960	3	200
Above 960	3	500

- Remark:
- (1) Emission level (dB)μV = 20 log Emission level μV/m
 - (2) The smaller limit shall apply at the cross point between two frequency bands.
 - (3) As shown in 15.35(b), for frequencies above 1000MHz, the field strength limits are based on average detector, however, the peak field strength of any emission shall not exceed the maximum permitted average limits, specified above by more than 20dB under any condition of modulation.
 - (4) The frequency range scanned is from the lowest radio frequency signal generated in the device which is greater than 9 kHz to the tenth harmonic of the highest fundamental frequency or 40 GHz, whichever is lower.
 - (5) §15.247(d) specifies that emissions which fall in the restricted bands, as defined in §15.205 comply with radiated emission limits specified in §15.209.

BLOCK DIAGRAM OF TEST SETUP

For Radiated Emission below 30MHz

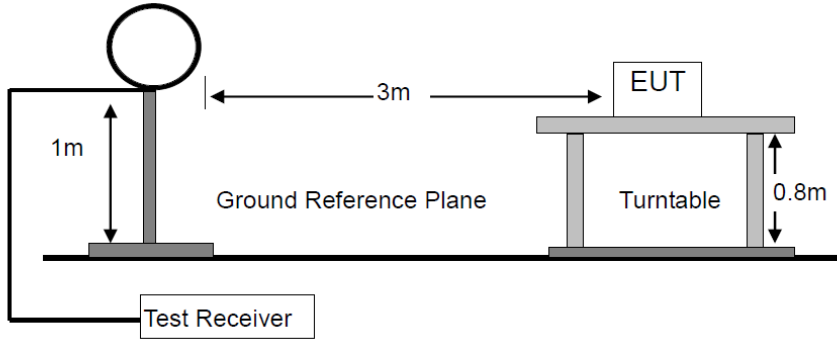

For Radiated Emission 30-1000MHz

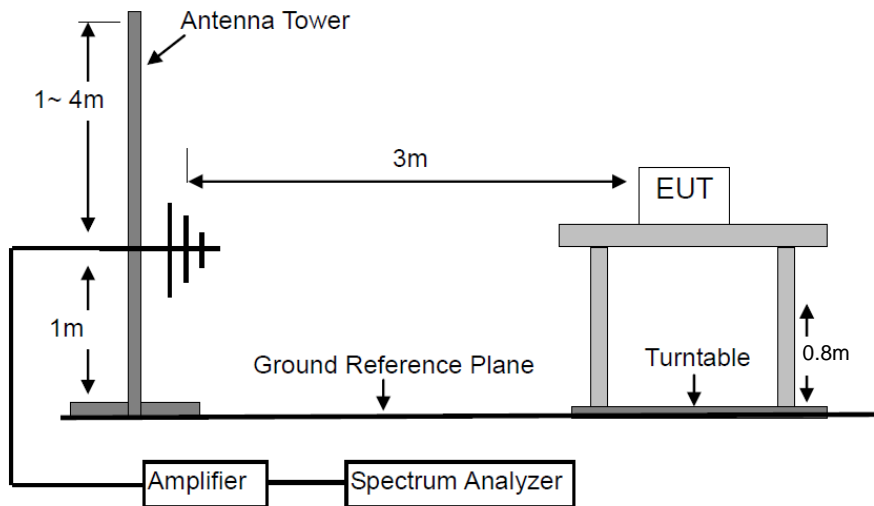

For Radiated Emission Above 1000MHz.

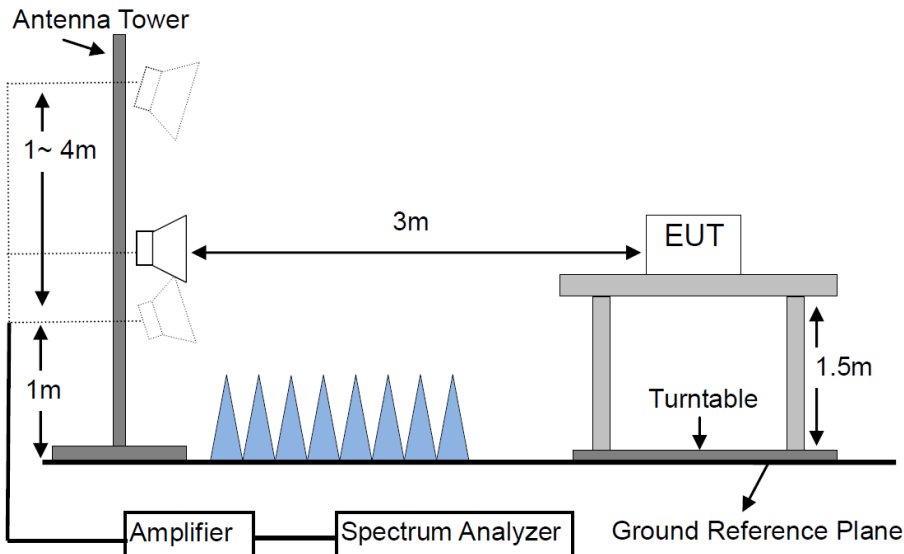

TEST PROCEDURES

- a. Below 1GHz, the EUT was placed on the top of a rotating table 0.8 meters above the ground at a 3 meter semi- anechoic chamber room.
- b. For the radiated emission test above 1GHz:
The EUT was placed on the top of a rotating table 1.5 meters above the ground at a 3 meter full anechoic chamber room. The table was rotated 360 degrees to determine the position of the highest radiation. Place the measurement antenna away from each area of the EUT determined to be a source of emissions at the specified measurement distance, while keeping the measurement antenna aimed at the source of emissions at each frequency of significant emissions, with polarization oriented for maximum response. The measurement antenna may have to be higher or lower than the EUT, depending on the radiation pattern of the emission and staying aimed at the emission source for receiving the maximum signal. The final measurement antenna elevation shall be that which maximizes the emissions. The measurement antenna elevation for maximum emissions shall be restricted to a range of heights of from 1 m to 4 m above the ground or reference ground plane.
- c. The EUT was set 3 meters away from the interference-receiving antenna, which was mounted on the top of a variable-height antenna tower.
- d. The height of antenna is varied from one meter to four meters above the ground to determine the maximum value of the field strength. Both horizontal and vertical polarizations of the antenna are set to make the measurement.
- e. For each suspected emission, the EUT was arranged to its worst case and then the antenna was tuned to heights from 1 meter to 4 meters and the rotatable table was turned from 0 degrees to 360 degrees to find the maximum reading. The test-receiver system was set to peak detect function and specified bandwidth with maximum hold mode.
- f. A Quasi-peak measurement was then made for that frequency point for below 1GHz test. PK and AV for above 1GHz emission test.

During the radiated emission test, the spectrum analyzer was set with the following configurations:

Frequency Band (MHz)	Detector	Resolution Bandwidth	Video Bandwidth
30 to 1000	QP	120 kHz	300 kHz
Above 1000	Peak	1 MHz	3 MHz
	Average	1 MHz	10 Hz

TEST RESULTS

PASS

Please refer to the following pages.

M/N: WDC508	Testing Voltage: AC 120V 60Hz
Polarization: Horizontal	Detector: QP
Test Mode: 1(IEEE 802.11b middle channel, the worst case)	Distance: 3m

Radiated Emission Measurement

Date: 2021/1/22

Time: 8:51:40

80.0 dBuV/m

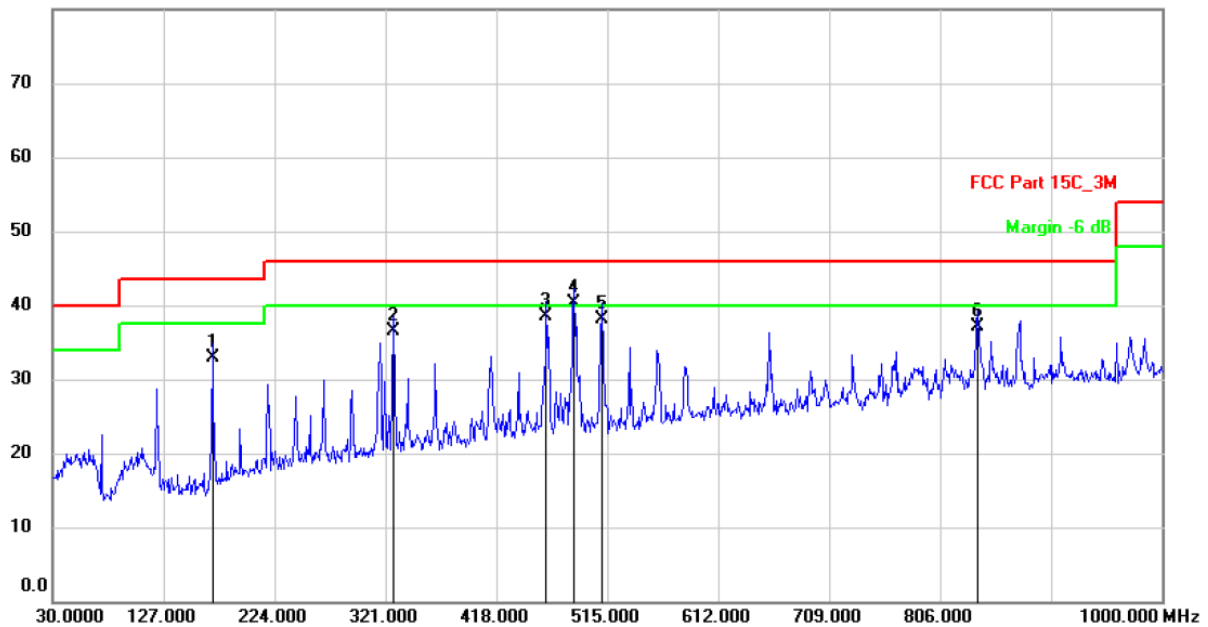

No.	Mk.	Freq.	Reading Level	Correct Factor	Measurement	Limit	Over	Detector	Comment
		MHz	dBuV	dB/m	dBuV/m	dBuV/m	dB		
1		169.6799	42.92	-10.02	32.90	43.50	-10.60	QP	
2		327.7900	41.22	-4.72	36.50	46.00	-9.50	QP	
3		461.6500	40.87	-2.37	38.50	46.00	-7.50	QP	
4	*	485.9000	42.26	-1.96	40.30	46.00	-5.70	QP	
5		510.1500	39.80	-1.60	38.20	46.00	-7.80	QP	
6		838.9800	32.58	4.62	37.20	46.00	-8.80	QP	

Note: Below 30MHz, the emissions are lower than 20dB below the allowable limit.

M/N: WDC508	Testing Voltage: AC 120V 60Hz
Polarization: Vertical	Detector: QP
Test Mode: 1(IEEE 802.11b middle channel, the worst case)	Distance: 3m

Radiated Emission Measurement

Date: 2021/1/22

Time: 8:58:00

80.0 dBuV/m

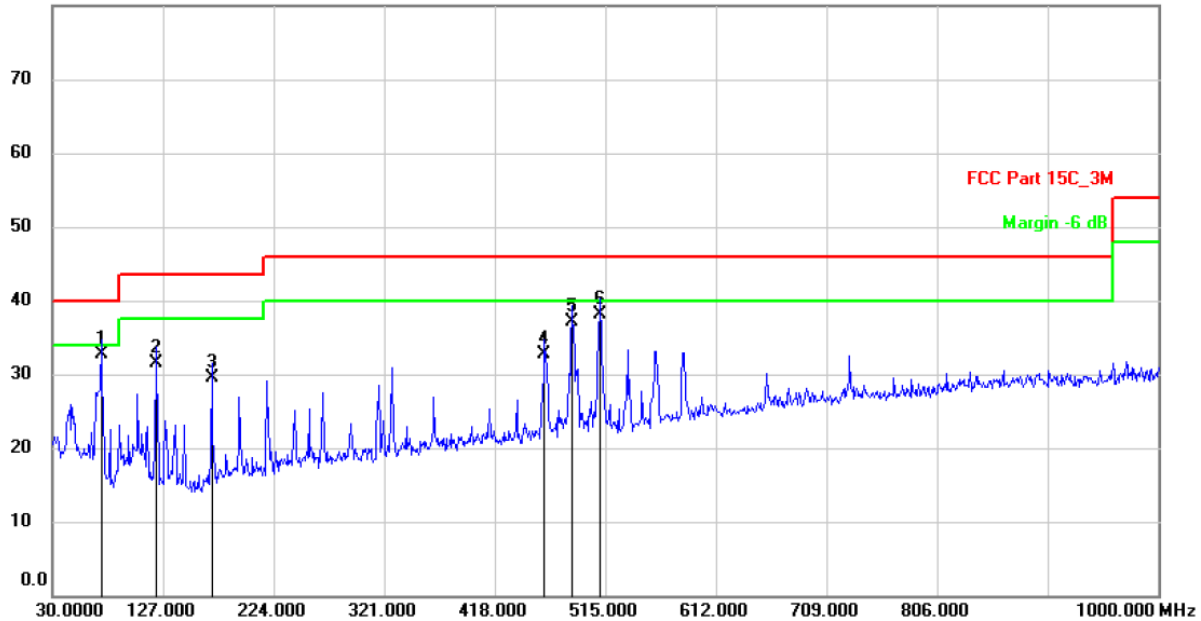

No.	Mk.	Freq.	Reading Level	Correct Factor	Measurement	Limit	Over	Detector	Comment
		MHz	dBuV	dB/m	dBuV/m	dBuV/m	dB		
1	*	72.6800	43.78	-11.08	32.70	40.00	-7.30	QP	
2		121.1800	42.73	-11.13	31.60	43.50	-11.90	QP	
3		169.6799	39.81	-10.31	29.50	43.50	-14.00	QP	
4		461.6500	36.07	-3.37	32.70	46.00	-13.30	QP	
5		485.9000	40.16	-2.96	37.20	46.00	-8.80	QP	
6		510.1500	40.80	-2.60	38.20	46.00	-7.80	QP	

Note: Below 30MHz, the emissions are lower than 20dB below the allowable limit.

Modulation: TX (IEEE 802.11b the worst case)		Test Result: PASS					Test frequency range: 1-25GHz			
Freq. (MHz)	Ant. Pol. (H/V)	Reading Level(dBuV)		Factor (dB/m)	Emission Level (dBuV/m)		Limit 3m (dBuV/m)		Margin (dB)	
		PK	AV		PK	AV	PK	AV	PK	AV
Operation Mode: TX Mode (Low)										
4824	V	49.52	36.41	6.38	55.90	42.79	74.00	54.00	-18.10	-11.21
7236	V	46.38	31.64	10.48	56.86	42.12	74.00	54.00	-17.14	-11.88

4824	H	49.63	36.62	6.38	56.01	43.00	74.00	54.00	-17.99	-11.00
7236	H	46.32	31.28	10.48	56.80	41.76	74.00	54.00	-17.20	-12.24

Operation Mode: TX Mode (Mid)										
4874	V	47.74	32.78	6.56	54.30	39.34	74.00	54.00	-19.70	-14.66
7311	V	45.93	31.08	10.53	56.46	41.61	74.00	54.00	-17.54	-12.39

4874	H	46.68	32.07	6.56	53.24	38.63	74.00	54.00	-20.76	-15.37
7311	H	46.00	31.04	10.53	56.53	41.57	74.00	54.00	-17.47	-12.43

Operation Mode: TX Mode (High)										
4924	V	47.95	31.97	6.76	54.71	38.73	74.00	54.00	-19.29	-15.27
7386	V	45.90	30.86	10.57	56.47	41.43	74.00	54.00	-17.53	-12.57

4924	H	47.29	32.15	6.76	54.05	38.91	74.00	54.00	-19.95	-15.09
7386	H	45.85	30.87	10.57	56.42	41.44	74.00	54.00	-17.58	-12.56

Spurious Emission in restricted band:										
2390.000	V	51.41	33.04	0.09	51.50	33.13	74.00	54.00	-22.50	-20.87
2390.000	H	57.58	33.40	0.09	57.67	33.49	74.00	54.00	-16.33	-20.51
2483.500	V	51.99	30.57	0.34	52.33	30.91	74.00	54.00	-21.67	-23.09
2483.500	H	56.44	30.60	0.34	56.78	30.94	74.00	54.00	-17.22	-23.06

Remark: 1. Data of measurement within this frequency range shown "---" in the table above means the reading of emissions are attenuated more than 20dB below the permissible limits.
2. Others emissions are attenuated 20dB below the limits, so it does not record in report.

14.7 Antenna Requirement

STANDARD APPLICABLE

According to of FCC part 15C section 15.203 and 15.247:

An intentional radiator shall be designed to ensure that no antenna other than that furnished by the responsible party shall be used with the device. The use of a permanently attached antenna or of an antenna that uses a unique coupling to the intentional radiator, the manufacturer may design the unit so that a broken antenna can be replaced by the user, but the use of a standard antenna jack or electrical connector is prohibited.

Systems operating in the 2400-2483.5MHz band that are used exclusively for fixed, point-to-point operations may employ transmitting antennas with directional gain greater than 6dBi provided the maximum peak output power of the intentional radiator is reduced by 1dB for every 3dB that the directional gain of the antenna exceeds 6dBi.

ANTENNA CONNECTED CONSTRUCTION

The antenna is PCB antenna that no antenna other than furnished by the responsible party shall be used with the device, and the best case gain of the antenna is 2dBi, Therefore, the antenna is consider meet the requirement.

15. Test Equipment List

Item	Equipment	Manufacturer	Model No.	Serial No.	Last Cal.	Cal. Interval
1.	Test Receiver	Rohde & Schwarz	ESCI7	100837	Mar. 13, 2021	1 Year
2.	Antenna	Schwarzbeck	VULB9162	9162-010	Mar. 23, 2021	1 Year
3.	Spectrum Analyzer	Rohde & Schwarz	FSU26	200409/026	Mar. 13, 2021	1 Year
4.	Spectrum Analyzer	Keysight	N9020A	MY54200831	Mar. 13, 2021	1 Year
5.	Spectrum Analyzer	Rohde & Schwarz	FSV40	101094	Mar. 13, 2021	1 Year
6.	Horn Antenna	Schwarzbeck	BBHA9170	9170-172	Mar. 22, 2020	2 Year
7.	Power Sensor	DARE	RPR3006W	15I00041SNO 64	Mar. 13, 2021	1 Year
8.	Horn Antenna	COM-Power	AH-118	071078	Mar. 23, 2021	1 Year
9.	Pre-Amplifier	HP	HP 8449B	3008A00964	Mar. 13, 2021	1 Year
10.	Pre-Amplifier	HP	HP 8447D	1145A00203	Mar. 13, 2021	1 Year
11.	Loop Antenna	Schwarzbeck	FMZB 1513	1513-272	Mar. 23, 2021	1 Year
12.	Test Receiver	Rohde & Schwarz	ESCI	101152	Mar. 14, 2021	1 Year
13.	L.I.S.N	Rohde & Schwarz	ENV 216	101317	Mar. 13, 2021	1 Year
14.	RF Switching Unit	Compliance Direction Systems Inc.	RSU-M2	38311	Mar.13, 2021	1 Year
15.	Temporary antenna connector	TESCOM	SS402	N/A	N/A	N/A
16.	Chamber	SAEMC	9*7*7m	N/A	Jun. 20, 2019	2 Year
17.	Test Software	EZ	EZ_EMCC	N/A	N/A	N/A

Note: For photographs of EUT and measurement, please refer to appendix in separate documents.

---End---