



FCC RADIO TEST REPORT

FCC ID : 2AQ68T99W368M
Equipment : 5G WWAN Module
Brand Name : Foxconn
Model Name : T99W368M
Applicant : Hon Lin Technology Co., Ltd
11F, No.32, Jihu Rd., Neihu Dist., Taipei City
114, Taiwan R.O.C.
Manufacturer : Hon Lin Technology Co., Ltd
11F, No.32, Jihu Rd., Neihu Dist., Taipei City
114, Taiwan R.O.C.
Standard : FCC 47 CFR Part 2, 96

The product was received on Jul. 01, 2022 and testing was performed from Jul. 16, 2022 to Oct. 25, 2022. We, Sporton International Inc. EMC & Wireless Communications Laboratory, would like to declare that the tested sample has been evaluated in accordance with the test procedures given in ANSI / TIA-603-E and has been in compliance with the applicable technical standards.

The test results in this report apply exclusively to the tested model / sample. Without written approval from Sporton International Inc. EMC & Wireless Communications Laboratory, the test report shall not be reproduced except in full.

Louis Wu

Approved by: Louis Wu

Sporton International Inc. EMC & Wireless Communications Laboratory

No. 52, Huaya 1st Rd., Guishan Dist., Taoyuan City 333, Taiwan (R.O.C.)



Table of Contents

History of this test report3

Summary of Test Result4

1 General Description5

 1.1 Product Feature of Equipment Under Test5

 1.2 Modification of EUT.....5

 1.3 Testing Location6

 1.4 Applied Standards7

2 Test Configuration of Equipment Under Test8

 2.1 Test Mode8

 2.2 Connection Diagram of Test System10

 2.3 Support Unit used in test configuration10

 2.4 Measurement Results Explanation Example10

 2.5 Frequency List of Low/Middle/High Channels11

3 Conducted Test Items14

 3.1 Measuring Instruments14

 3.2 Conducted Output Power15

 3.3 Peak-to-Average Ratio16

 3.4 EIRP17

 3.5 Occupied Bandwidth18

 3.6 Conducted Band Edge19

 3.7 Conducted Spurious Emission20

 3.8 Frequency Stability21

4 Radiated Test Items22

 4.1 Measuring Instruments22

 4.2 Test Setup22

 4.3 Test Result of Radiated Test23

 4.4 Radiated Spurious Emission.....24

5 List of Measuring Equipment25

6 Uncertainty of Evaluation27

Appendix A. Test Results of Conducted Test

Appendix B. Test Results of Radiated Test

Appendix C. Test Setup Photographs



Summary of Test Result

Report Clause	Ref Std. Clause	Test Items	Result (PASS/FAIL)	Remark
3.2	§2.1046	Conducted Output Power	Reporting only	-
3.3	§96.41	Peak-to-Average Ratio	Pass	
3.4	§96.41	Effective Isotropic Radiated Power	Pass	-
3.5	§2.1049 §96.41	Occupied Bandwidth	Reporting only	-
3.6	§2.1051 §96.41	Conducted Band Edge Measurement	Pass	-
3.7	§2.1051 §96.41	Conducted Spurious Emission	Pass	
3.8	§2.1055	Frequency Stability for Temperature & Voltage	Pass	-
4.4	§2.1051 §96.41	Radiated Spurious Emission	Pass	0.54 dB under the limit at 10653.000 MHz

Declaration of Conformity:

- The test results (PASS/FAIL) with all measurement uncertainty excluded are presented in accordance with the regulation limits or requirements declared by manufacturers. It's means measurement values may risk exceeding the limit of regulation standards, if measurement uncertainty is include in test results.
- The measurement uncertainty please refer to report "Uncertainty of Evaluation".

Comments and Explanations:

The product specifications of the EUT presented in the report are declared by the manufacturer who shall take full responsibility for the authenticity.

Reviewed by: Keven Cheng

Report Producer: Clio Lo



1 General Description

1.1 Product Feature of Equipment Under Test

WCDMA/LTE/5G NR and GNSS

The following antennas were provided to the EUT

	Band	Brand	Model	Antenna Type	RF Exposure Max Antenna Gain(dBi)
5G NR	n48	WHA YU	C107-511725-A	PCB	1
	n77 (3550~3700MHz)	WHA YU	C107-511725-A	PCB	1
	n78 (3550~3700MHz)	WHA YU	C107-511725-A	PCB	1

Remark: The above EUT's information was declared by manufacturer and used for Radiated Spurious Emission test.

There are three different HW of T99W368M.

Brand	Model	HW
Foxconn	T99W368M	1. WCDMA+LTE+Sub6+mmWave+eSIM
		2. WCDMA+LTE+Sub6+mmWave w/o eSIM
		3. WCDMA+LTE+Sub6+mmWave +FPC connector on bottom w/o eSIM

Note: All the tests were performed with Sample 1.

1.2 Modification of EUT

No modifications made to the EUT during the testing.



1.3 Testing Location

Test Site	Sporton International Inc. EMC & Wireless Communications Laboratory
Test Site Location	No.52, Huaya 1st Rd., Guishan Dist., Taoyuan City 333, Taiwan (R.O.C.) TEL: +886-3-327-3456 FAX: +886-3-328-4978
Test Site No.	Sporton Site No. TH03-HY
Test Engineer	Peter Liao, Nina Cheng and Luffy Lin
Temperature (°C)	23.5~24.1
Relative Humidity (%)	48~52

Test Site	Sporton International Inc. Wensan Laboratory
Test Site Location	No.58, Aly. 75, Ln. 564, Wenhua 3rd, Rd., Guishan Dist., Taoyuan City 333010, Taiwan (R.O.C.) TEL: +886-3-327-0868 FAX: +886-3-327-0855
Test Site No.	Sporton Site No. 03CH12-HY (TAF Code: 3786)
Test Engineer	Jack Cheng, Tim Lee and Wilson Wu
Temperature (°C)	20~25
Relative Humidity (%)	50~60
Remark	The Radiated Spurious Emission test item subcontracted to Sporton International Inc. Wensan Laboratory.

Note: The test site complies with ANSI C63.4 2014 requirement.

FCC Designation No.: TW1190 and TW3786



1.4 Applied Standards

According to the specifications declared by the manufacturer, the EUT must comply with the requirements of the following standards:

- ♦ ANSI C63.26-2015
- ♦ ANSI / TIA-603-E
- ♦ FCC 47 CFR Part 2, 96
- ♦ FCC KDB 971168 D01 Power Meas. License Digital Systems v03r01
- ♦ FCC KDB 940660 D01 Part 96 CBRS Eqpt v01
- ♦ FCC KDB 412172 D01 Determining ERP and EIRP v01r01
- ♦ FCC KDB 414788 D01 Radiated Test Site v01r01
- ♦ FCC KDB 662911 D01 Multiple Transmitter Output v02r01.

Remark:

1. All the test items were validated and recorded in accordance with the standards without any modification during the testing.
2. This EUT has also been tested and complied with the requirements of FCC Part 15, Subpart B, recorded in a separate test report.
3. The TAF code is not including all the FCC KDB listed without accreditation.



2 Test Configuration of Equipment Under Test

2.1 Test Mode

Antenna port conducted and radiated test items listed below are performed according to KDB 971168 D01 Power Meas. License Digital Systems v03r01 with maximum output power.

For radiated measurement, the measured emission level of the EUT was maximized by rotating the EUT on a turntable, adjusting the orientation of the EUT and EUT antenna in three orthogonal axis (X: flat, Y: portrait, Z: landscape), and adjusting the measurement antenna orientation, following C63.26 exploratory test procedures and only the worst case emissions were reported in this report.

Test Items	Band	Bandwidth (MHz)				Modulation					RB #			Test Channel		
		10	20	30	40	PI/2 BPSK	QPSK	16QAM	64QAM	256QAM	1	Half	Full	L	M	H
Max. Output Power	n48	v	v	v	v	v	v	v	v	v	v	v	v	v	v	v
26dB and 99% Bandwidth	n48	v	v	v	v	v	v	v	v	v			v		v	
Conducted Band Edge	n48	v	v	v	v	v	v	v	v	v	v		v	v	v	v
Peak-to-Average Ratio	n48		v			v	v	v	v	v			v		v	
Conducted Spurious Emission	n48	v					v				v			v	v	v
E.I.R.P	n48	v	v	v	v	v	v	v	v	v	Max. Power					
Frequency Stability	n48		v			v					v				v	
Radiated Spurious Emission	n48	Worst Case											v	v	v	
Remark	<ol style="list-style-type: none"> The mark "v" means that this configuration is chosen for testing The mark "-" means that this bandwidth is not supported. The device is investigated from 30MHz to 10 times of fundamental signal for radiated spurious emission test under different RB size/offset and modulations in exploratory test. Subsequently, only the worst case emissions are reported. For radiated measurement, pre-scanned in two modes, DFT-s OFDM and CP OFDM. The worst cases (DFT-s OFDM) were recorded in this report. One representative bandwidth is selected to perform PAR and frequency stability. 															



Test Items	NR Band	Bandwidth (MHz)												Modulation					RB #			Test Channel		
		10	15	20	25	30	40	50	60	70	80	90	100	PI/2 BPSK	QPSK	16QAM	64QAM	256QAM	1	Half	Full	L	M	H
Max. Output Power	n77	v	v	v	-	v	v	v	v	v	v	v	v	v	v	v	v	v	v	v	v	v	v	
	n78	v	v	v	-	v	v	v	v	v	v	v	v	v	v	v	v	v	v	v	v	v	v	
Peak-to-Average Ratio	n77			v	-									v	v	v	v	v			v		v	
	n78	Covered by 5G NR n77																						
26dB and 99% Bandwidth	n77	v	v	v	-	v	v	v	v	v	v	v	v	v	v	v	v	v			v		v	
	n78	Covered by 5G NR n77																						
Conducted Band Edge	n77	v	v	v	-	v	v	v	v	v	v	v	v	v	v	v	v	v	v		v	v	v	
	n78	Covered by 5G NR n77																						
Conducted Spurious Emission	n77	v			-										v				v			v	v	
	n78	Covered by 5G NR n77																						
Frequency Stability	n77			v	-									v	v						v		v	
	n78	Covered by 5G NR n77																						
E.I.R.P	n77	v	v	v	-	v	v	v	v	v	v	v	v	v	v	v	v	v	Max. Power					
	n78	v	v	v	-	v	v	v	v	v	v	v	v	v	v	v	v	v	Max. Power					
Radiated Spurious Emission	n77	Worst Case																			v	v	v	
	n78	Covered by 5G NR n77																						
Remark	<ol style="list-style-type: none"> The mark "v" means that this configuration is chosen for testing The mark "-" means that this bandwidth is not supported. The device is investigated from 30MHz to 10 times of fundamental signal for radiated spurious emission test under different RB size/offset and modulations in exploratory test. Subsequently, only the worst case emissions are reported. For radiated measurement, pre-scanned in two modes, DFT-s OFDM and CP OFDM. The worst cases (DFT-s OFDM) were recorded in this report. One representative bandwidth is selected to perform PAR and frequency stability. Wider operating range bandwidth covers narrower one when the power is higher or the same. 																							

2.2 Connection Diagram of Test System

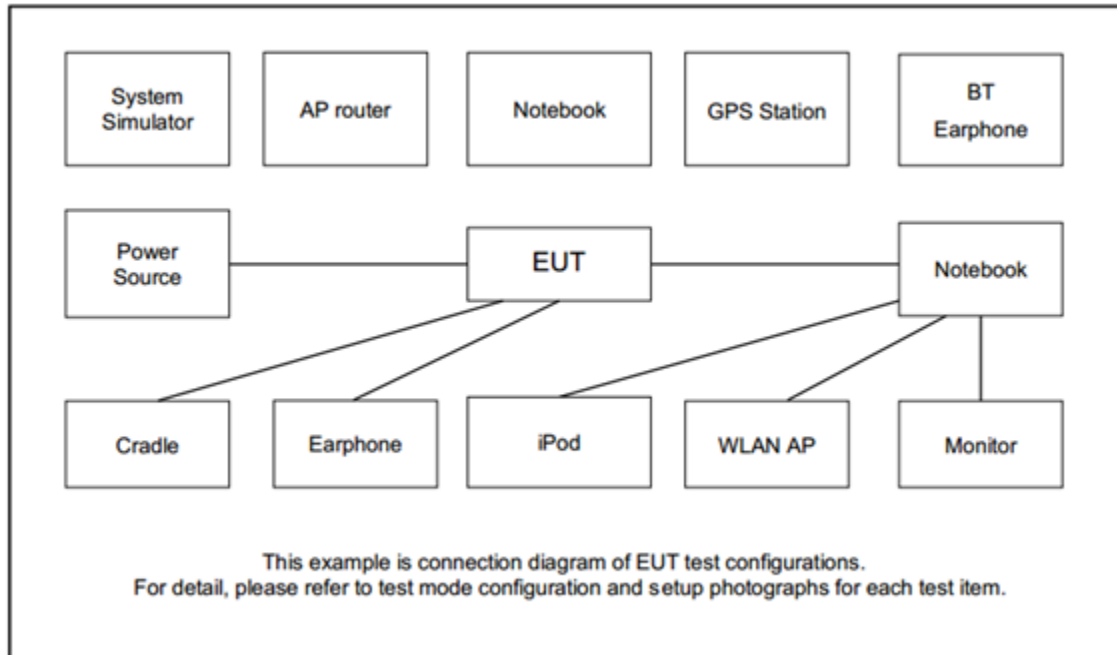

2.3 Support Unit used in test configuration

Item	Equipment	Brand Name	Model No.	FCC ID	Data Cable	Power Cord
1.	Notebook	Dell	Latitude 3400	N/A	N/A	AC I/P: Unshielded, 1.2 m DC O/P: Shielded, 1.8 m
2.	System Simulator	Anritsu	MT8821C	N/A	N/A	Unshielded, 1.8 m
3.	System Simulator	Anritsu	MT8000A	N/A	N/A	Unshielded, 1.8 m
4.	Fixture	Foxconn	95.2580T00	N/A	N/A	N/A

2.4 Measurement Results Explanation Example

For all conducted test items:

The offset level is set in the spectrum analyzer to compensate the RF cable loss and attenuator factor between EUT conducted output port and spectrum analyzer. With the offset compensation, the spectrum analyzer reading level is exactly the EUT RF output level.

The spectrum analyzer offset is derived from RF cable loss and attenuator factor.

Offset = RF cable loss + attenuator factor.

Following shows an offset computation example with cable loss 4.2 dB and 10dB attenuator.

Example :

Offset(dB) = RF cable loss(dB) + attenuator factor(dB).

$$= 4.2 + 10 = 14.2 \text{ (dB)}$$



2.5 Frequency List of Low/Middle/High Channels

5G NR n48 Channel and Frequency List				
BW [MHz]	Channel/Frequency(MHz)	Lowest	Middle	Highest
40	Channel	638000	641666	645332
	Frequency	3570	3624.99	3679.98
30	Channel	637668	641666	645666
	Frequency	3565.02	3624.99	3684.99
20	Channel	637334	641666	646000
	Frequency	3560.01	3624.99	3690
10	Channel	637000	641666	646332
	Frequency	3555	3624.99	3694.98



5G NR n77 Channel and Frequency List				
BW [MHz]	Channel/Frequency(MHz)	Lowest	Middle	Highest
100	Channel	640000	641666	643332
	Frequency	3600	3624.99	3649.98
90	Channel	639668	641666	643666
	Frequency	3595.02	3624.99	3654.99
80	Channel	639334	641666	644000
	Frequency	3590.01	3624.99	3660
70	Channel	639000	641666	644332
	Frequency	3585	3624.99	3664.98
60	Channel	638668	641666	644666
	Frequency	3580.02	3624.99	3669.99
50	Channel	638334	641666	645000
	Frequency	3575.01	3624.99	3675
40	Channel	638000	641666	645332
	Frequency	3570	3624.99	3679.98
30	Channel	637666	641666	645666
	Frequency	3564.99	3624.99	3684.99
20	Channel	637334	641666	646000
	Frequency	3560.01	3624.99	3690
15	Channel	637168	641666	646166
	Frequency	3557.52	3624.99	3692.49
10	Channel	637000	641666	646332
	Frequency	3555	3624.99	3694.98



5G NR n78 Channel and Frequency List				
BW [MHz]	Channel/Frequency(MHz)	Lowest	Middle	Highest
100	Channel	640000	641666	643332
	Frequency	3600	3624.99	3649.98
90	Channel	639668	641666	643666
	Frequency	3595.02	3624.99	3654.99
80	Channel	639334	641666	644000
	Frequency	3590.01	3624.99	3660
70	Channel	639000	641666	644332
	Frequency	3585	3624.99	3664.98
60	Channel	638668	641666	644666
	Frequency	3580.02	3624.99	3669.99
50	Channel	638334	641666	645000
	Frequency	3575.01	3624.99	3675
40	Channel	638000	641666	645332
	Frequency	3570	3624.99	3679.98
30	Channel	637666	641666	645666
	Frequency	3564.99	3624.99	3684.99
20	Channel	637334	641666	646000
	Frequency	3560.01	3624.99	3690
15	Channel	637168	641666	646166
	Frequency	3557.52	3624.99	3692.49
10	Channel	637000	641666	646332
	Frequency	3555	3624.99	3694.98

3 Conducted Test Items

3.1 Measuring Instruments

See list of measuring instruments of this test report.

3.1.1 Test Setup

3.1.2 Conducted Output Power

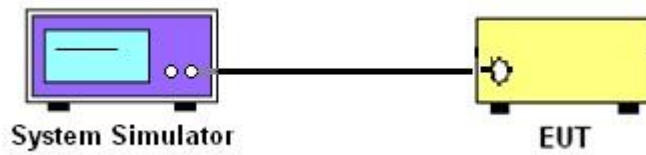

3.1.3 EIRP, Peak-to-Average Ratio, Occupied Bandwidth, Conducted Band-Edge and Conducted Spurious Emission

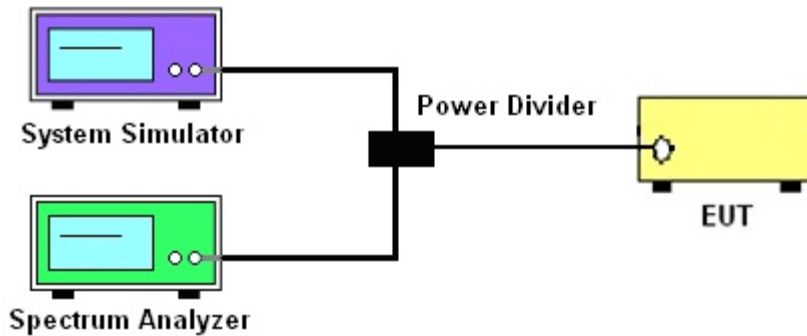

3.1.4 Frequency Stability

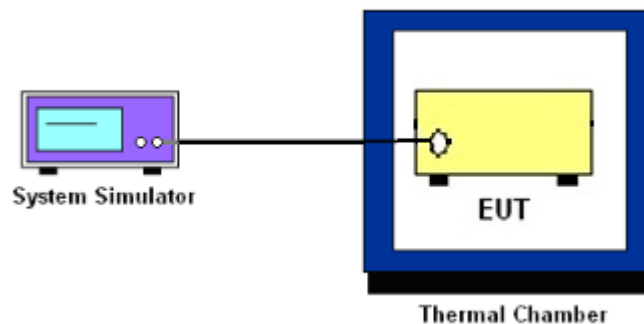

3.1.5 Test Result of Conducted Test

Please refer to Appendix A.



3.2 Conducted Output Power

3.2.1 Description of the Conducted Output Power Measurement

A system simulator was used to establish communication with the EUT. Its parameters were set to force the EUT transmitting at maximum output power. The measured power in the radio frequency on the transmitter output terminals shall be reported.

3.2.2 Test Procedures

1. The transmitter output port was connected to the system simulator.
2. Set EUT at maximum power through the system simulator.
3. Select lowest, middle, and highest channels for each band and different modulation.
4. Measure and record the power level from the system simulator.



3.3 Peak-to-Average Ratio

3.3.1 Description of the PAR Measurement

Power Complementary Cumulative Distribution Function (CCDF) curves provide a means for characterizing the power peaks of a digitally modulated signal on a statistical basis. A CCDF curve depicts the probability of the peak signal amplitude exceeding the average power level. Most contemporary measurement instrumentation include the capability to produce CCDF curves for an input signal provided that the instrument's resolution bandwidth can be set wide enough to accommodate the entire input signal bandwidth. In measuring transmissions in this band using an average power technique, the peak-to-average ratio (PAR) of the transmission may not exceed 13 dB.

3.3.2 Test Procedures

The testing follows ANSI C63.26-2015 Section 5.2.6

1. The EUT was connected to spectrum and system simulator via a power divider.
2. Set the CCDF (Complementary Cumulative Distribution Function) option in spectrum analyzer.
3. The highest RF powers were measured and recorded the maximum PAPR level associated with a probability of 0.1 %.
4. Record the deviation as Peak to Average Ratio



3.4 EIRP

3.4.1 Description of the EIRP Measurement

The EIRP of mobile transmitters must not exceed 23 dBm /10 megahertz for 5G NR n48, n77, n78.

The testing follows ANSI C63.26-2015 Section 5.2.5.5

According to KDB 412172 D01 Power Approach,

$EIRP = PT + GT - LC$, where

PT = transmitter output power in dBm

GT = gain of the transmitting antenna in dBi

LC = signal attenuation in the connecting cable between the transmitter and antenna in dB

Device	Maximum EIRP (dBm/10 MHz)	Maximum PSD (dBm/MHz)
End User Device	23	n/a

Remark:

1. Total channel power is complied with EIRP limit 23dBm/10MHz.
2. The MIMO mode is completely uncorrelated, so the directional gain is selected the maximum gain among all antennas.

3.4.2 Test Procedures

The testing follows procedure in Section 5.2 of ANSI C63.26-2015 and KDB 940660 D01 Part 96 CBRS Eqpt v03 Section 3.2(b)(2)

Determine the EIRP by adding the effective antenna gain to the measured average conducted power level.



3.5 Occupied Bandwidth

3.5.1 Description of Occupied Bandwidth Measurement

The occupied bandwidth is the width of a frequency band such that, below the lower and above the upper frequency limits, the mean powers emitted are each equal to a specified percentage 0.5% of the total mean transmitted power.

The 26 dB emission bandwidth is defined as the frequency range between two points, one above and one below the carrier frequency, at which the spectral density of the emission is attenuated 26 dB below the maximum in-band spectral density of the modulated signal. Spectral density (power per unit bandwidth) is to be measured with a detector of resolution bandwidth equal to approximately 1.0% of the emission bandwidth.

The occupied bandwidth shall not exceed the equipment's channel bandwidth, which is declared by the manufacturer.

3.5.2 Test Procedures

The testing follows ANSI C63.26-2015 Section 5.4.3 (26dB) and Section 5.4.4 (99OB)

1. The EUT was connected to spectrum analyzer and system simulator via a power divider.
2. The spectrum analyzer center frequency is set to the nominal EUT channel center frequency. The span range for the spectrum analyzer shall be between two and five times the anticipated OBW.
3. The nominal resolution bandwidth (RBW) shall be in the range of 1 to 5 % of the anticipated OBW, and the VBW shall be at least 3 times the RBW.
4. Set the detection mode to peak, and the trace mode to max hold.
5. Determine the reference value: Set the EUT to transmit a modulated signal. Allow the trace to stabilize. Set the spectrum analyzer marker to the highest level of the displayed trace.
(this is the reference value)
6. Determine the "-26 dB down amplitude" as equal to (Reference Value - X).
7. Place two markers, one at the lowest and the other at the highest frequency of the envelope of the spectral display such that each marker is at or slightly below the "-X dB down amplitude" determined in step 6. If a marker is below this "-X dB down amplitude" value it shall be placed as close as possible to this value. The OBW is the positive frequency difference between the two markers.
8. Use the 99 % power bandwidth function of the spectrum analyzer and report the measured bandwidth.



3.6 Conducted Band Edge

3.6.1 Description of Conducted Band Edge Measurement

The conducted power of any End User Device emission outside the fundamental emission (whether in or outside of the authorized band) shall not exceed -13 dBm/MHz within 0 to B megahertz (where B is the bandwidth in megahertz of the assigned channel or multiple contiguous channels of the End User Device) above the upper CBSD-assigned channel edge and within 0 to B megahertz below the lower CBSD-assigned channel edge. At all frequencies greater than B megahertz above the upper CBSD assigned channel edge and less than B megahertz below the lower CBSD-assigned channel edge, the conducted power of any End User Device emission shall not exceed -25 dBm/MHz. Notwithstanding the emission limits in this paragraph, the Adjacent Channel Leakage Ratio for End User Devices shall be at least 30 dB.

3.6.2 Test Procedures

The testing follows FCC KDB 971168 D01 v03r01 Section 6.1.

1. The EUT was connected to spectrum analyzer and system simulator via a power divider.
2. The band edges of low and high channels for the highest RF powers were measured.
3. Set RBW $\geq 1\%$ EBW in the 1MHz band immediately outside and adjacent to the band edge.
4. Beyond the 1 MHz band from the band edge, RBW=1MHz was used
5. Set spectrum analyzer with RMS detector.
6. The RF fundamental frequency should be excluded against the limit line in the operating frequency band.
7. For MIMO mode, add additional MIMO factor $10\log(\text{NTX}=2) = 3.01\text{dB}$ into the spectrum analyzer offset.

For Adjacent Channel Leakage Ratio (ACLR) measurement,

1. The Adjacent Channel Leakage Ratio (ACLR) is the ratio of the average power in the assigned aggregated channel bandwidth to the average power over the equivalent adjacent channel bandwidth.
2. The option ACLR of spectrum analyzer is used and measures the ACLR ratio by setting equivalent channel bandwidth.
3. The measured ACLR ratio shall be at least 30 dB.



3.7 Conducted Spurious Emission

3.7.1 Description of Conducted Spurious Emission Measurement

96.41 (e)(2)

The conducted power of any emissions below 3530 MHz or above 3720 MHz shall not exceed -40dBm/MHz.

3.7.2 Test Procedures

The testing follows FCC KDB 971168 D01 v03r01 Section 6.1.

1. The EUT was connected to spectrum analyzer and system simulator via a power divider.
2. The RF output of EUT was connected to the spectrum analyzer by RF cable and attenuator. The path loss was compensated to the results for each measurement.
3. The middle channel for the highest RF power within the transmitting frequency was measured.
4. The conducted spurious emission for the whole frequency range was taken.
5. Make the measurement with the spectrum analyzer's RBW = 1MHz, VBW = 3MHz.
6. Set spectrum analyzer with RMS detector.
7. Taking the record of maximum spurious emission.
8. The RF fundamental frequency should be excluded against the limit line in the operating frequency band.
9. The limit line is -40dBm/MHz.
10. For MIMO mode, add additional MIMO factor $10\log(\text{NTX}=2) = 3.01\text{dB}$ into the spectrum analyzer offset.



3.8 Frequency Stability

3.8.1 Description of Frequency Stability Measurement

The frequency stability shall be measured by variation of ambient temperature and variation of primary supply voltage to ensure that the fundamental emission stays within the authorized frequency block. The frequency stability of the transmitter shall be maintained within $\pm 0.00025\%$ ($\pm 2.5\text{ppm}$) of the center frequency

3.8.2 Test Procedures for Temperature Variation

The testing follows FCC KDB 971168 D01 v03r01 Section 9.0.

1. The EUT was set up in the thermal chamber and connected with the system simulator.
2. With power OFF, the temperature was decreased to -30°C and the EUT was stabilized before testing. Power was applied and the maximum change in frequency was recorded within one minute.
3. With power OFF, the temperature was raised in 10°C step up to 50°C . The EUT was stabilized at each step for at least half an hour. Power was applied and the maximum frequency change was recorded within one minute.

3.8.3 Test Procedures for Voltage Variation

The testing follows FCC KDB 971168 D01 v03r01 Section 9.0.

1. The EUT was placed in a temperature chamber at $25\pm 5^{\circ}\text{C}$ and connected with the system simulator.
2. The power supply voltage to the EUT was varied from 85% to 115% of the nominal value measured at the input to the EUT.
3. The variation in frequency was measured for the worst case.

4 Radiated Test Items

4.1 Measuring Instruments

See list of measuring instruments of this test report.

4.2 Test Setup

For radiated emissions below 30MHz

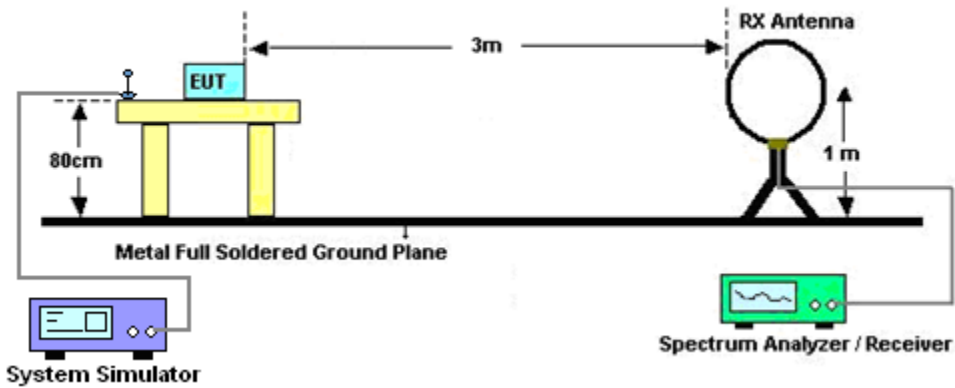

For radiated emissions from 30MHz to 1GHz

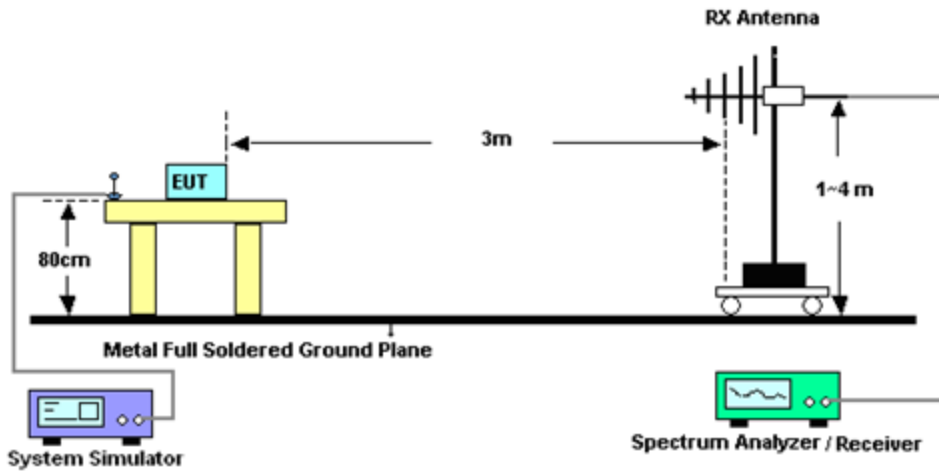

For radiated emissions 1GHz to 18GHz

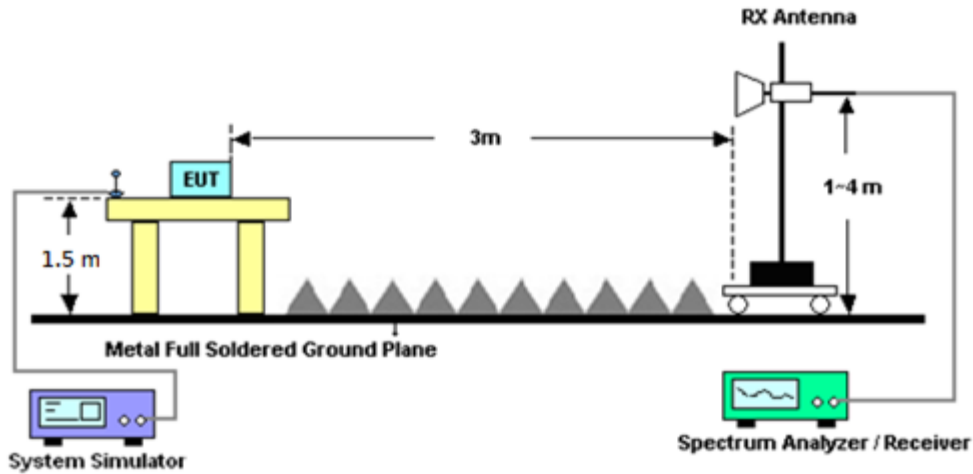

For radiated test above 18GHz

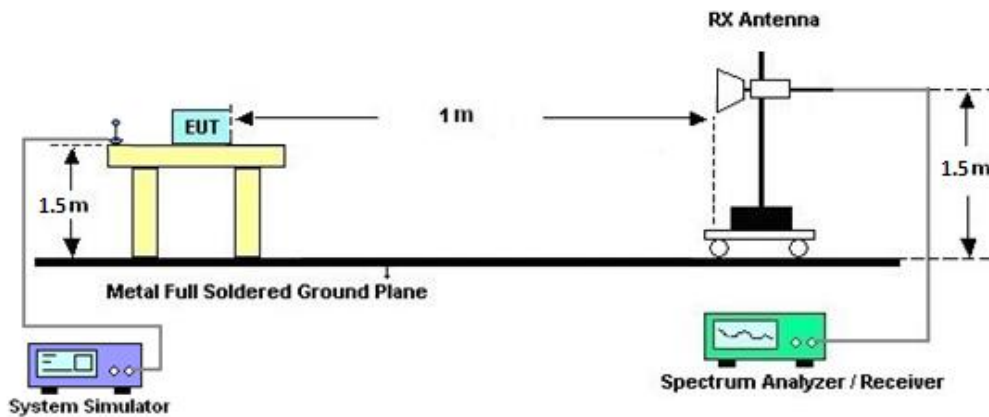

4.3 Test Result of Radiated Test

Please refer to Appendix B.

Note:

The low frequency, which started from 9 kHz to 30MHz, was pre-scanned and the result which was 20dB lower than the limit line was not reported.

There is adequate comparison measurement of both open-field test site and alternative test site - semi-Anechoic chamber according to 414788 D01 Radiated Test Site v01r01, and the result came out very similar.



4.4 Radiated Spurious Emission

4.4.1 Description of Radiated Spurious Emission Measurement

The radiated spurious emission was measured by substitution method according to ANSI / TIA-603-E. The power of any emission outside of the authorized operating frequency ranges must be attenuated below the transmitter power (P) by a factor of at least -40dBm / MHz .
The spectrum is scanned from 30 MHz up to a frequency including its 10th harmonic.

4.4.2 Test Procedures

The testing follows FCC KDB 971168 D01 v03r01 Section 7 and ANSI / TIA-603-E Section 2.2.12.

1. The EUT was placed on a turntable with 0.8 meter height for frequency below 1GHz and 1.5 meter height for frequency above 1GHz respectively above ground.
2. The EUT was set 3 meters from the receiving antenna mounted on the antenna tower.
3. The table was rotated 360 degrees to determine the position of the highest spurious emission.
4. The height of the receiving antenna is varied between 1m to 4m to search the maximum spurious emission for both horizontal and vertical polarizations.
5. During the measurement, the system simulator parameters were set to force the EUT transmitting at maximum output power.
6. Make the measurement with the spectrum analyzer's RBW = 1MHz, VBW = 3MHz, taking the record of maximum spurious emission.
7. A horn antenna was substituted in place of the EUT and was driven by a signal generator. Tune the output power of signal generator to the same emission level with EUT maximum spurious emission.
 $EIRP \text{ (dBm)} = S.G. \text{ Power} - Tx \text{ Cable Loss} + Tx \text{ Antenna Gain}$
 $ERP \text{ (dBm)} = EIRP - 2.15$
8. The RF fundamental frequency should be excluded against the limit line in the operating frequency band.
The limit line is -40dBm/MHz



5 List of Measuring Equipment

Instrument	Brand Name	Model No.	Serial No.	Characteristics	Calibration Date	Test Date	Due Date	Remark
Loop Antenna	Rohde & Schwarz	HFH2-Z2	100488	9 kHz~30 MHz	May 13, 2022	Jul. 16, 2022~ Sep. 06, 2022	May 12, 2023	Radiation (03CH12-HY)
Bilog Antenna	TESEQ	CBL 6111D & 00800N1D01 N-06	37059 & 01	30MHz~1GHz	Oct. 09, 2021	Jul. 16, 2022~ Sep. 06, 2022	Oct. 08, 2022	Radiation (03CH12-HY)
Bilog Antenna	TESEQ	CBL 6111D & N-6-06	35414 & AT-N0602	30MHz~1GHz	Oct. 09, 2021	Jul. 16, 2022~ Sep. 06, 2022	Oct. 08, 2022	Radiation (03CH12-HY)
Horn Antenna	SCHWARZBE CK	BBHA 9120 D	9120D-132 8	1GHz~18GHz	Dec. 03, 2021	Jul. 16, 2022~ Sep. 06, 2022	Dec. 02, 2022	Radiation (03CH12-HY)
Horn Antenna	SCHWARZBE CK	BBHA 9120 D	9120D-121 2	1GHz~18GHz	Mar. 10, 2022	Jul. 16, 2022~ Sep. 06, 2022	Mar. 09, 2023	Radiation (03CH12-HY)
SHF-EHF Horn Antenna	SCHWARZBE CK	BBHA9170	00993	18GHz~40GHz	Nov. 30, 2021	Jul. 16, 2022~ Sep. 06, 2022	Nov. 29, 2022	Radiation (03CH12-HY)
SHF-EHF Horn Antenna	SCHWARZBE CK	BBHA 9170	BBHA9170 251	18GHz~40GHz	Nov. 30, 2021	Jul. 16, 2022~ Sep. 06, 2022	Nov. 29, 2022	Radiation (03CH12-HY)
Preamplifier	COM-POWER	PA-103	161075	10MHz~1GHz	Mar. 23, 2022	Jul. 16, 2022~ Sep. 06, 2022	Mar. 22, 2023	Radiation (03CH12-HY)
Preamplifier	Aglient	8449B	3008A023 75	1GHz~26.5GHz	May 24, 2022	Jul. 16, 2022~ Sep. 06, 2022	May 23, 2023	Radiation (03CH12-HY)
Preamplifier	E-INSTRUME NT TECH LTD.	ERA-100M-18 G-56-01-A70	EC190024 9	1GHz-18GHz	Dec. 22, 2021	Jul. 16, 2022~ Sep. 06, 2022	Dec. 21, 2022	Radiation (03CH12-HY)
Preamplifier	EMEC	EM18G40G	060715	18GHz~40GHz	Dec. 24, 2021	Jul. 16, 2022~ Sep. 06, 2022	Dec. 23, 2022	Radiation (03CH12-HY)
Spectrum Analyzer	Agilent	N9010A	MY534701 18	10Hz~44GHz	Jan. 12, 2022	Jul. 16, 2022~ Sep. 06, 2022	Jan. 11, 2023	Radiation (03CH12-HY)
Filter	Wainwright	WLKS1200-1 2SS	SN2	1.2GHz Low Pass Filter	Mar. 15, 2022	Jul. 16, 2022~ Sep. 06, 2022	Mar. 14, 2023	Radiation (03CH12-HY)
Filter	Wainwright	WHKX8-5872. 5-6750-18000 -40ST	SN2	6.75GHz High Pass Filter	Mar. 16, 2022	Jul. 16, 2022~ Sep. 06, 2022	Mar. 15, 2023	Radiation (03CH12-HY)
RF Cable	HUBER + SUHNER	SUCOFLEX 104	MY9837/4 PE	9kHz~30MHz	Mar. 10, 2022	Jul. 16, 2022~ Sep. 06, 2022	Mar. 09, 2023	Radiation (03CH12-HY)
RF Cable	HUBER + SUHNER	SUCOFLEX 126E	0058/126E	30MHz~18GHz	Dec. 10, 2021	Jul. 16, 2022~ Sep. 06, 2022	Dec. 09, 2022	Radiation (03CH12-HY)
RF Cable	HUBER + SUHNER	SUCOFLEX 102	505134/2	30MHz~40GHz	Feb. 21, 2022	Jul. 16, 2022~ Sep. 06, 2022	Feb. 20, 2023	Radiation (03CH12-HY)
RF Cable	HUBER + SUHNER	SUCOFLEX 102	803953/2	30MHz~40GHz	Mar. 08, 2022	Jul. 16, 2022~ Sep. 06, 2022	Mar. 07, 2023	Radiation (03CH12-HY)
Hygrometer	TECPEL	DTM-303B	TP140349	N/A	Sep. 30, 2021	Jul. 16, 2022~ Sep. 06, 2022	Sep. 29, 2022	Radiation (03CH12-HY)
Controller	EMEC	EM1000	N/A	Control Turn table & Ant Mast	N/A	Jul. 16, 2022~ Sep. 06, 2022	N/A	Radiation (03CH12-HY)
Antenna Mast	EMEC	AM-BS-4500- B	N/A	1m~4m	N/A	Jul. 16, 2022~ Sep. 06, 2022	N/A	Radiation (03CH12-HY)
Turn Table	EMEC	TT2000	N/A	0~360 Degree	N/A	Jul. 16, 2022~ Sep. 06, 2022	N/A	Radiation (03CH12-HY)



Instrument	Brand Name	Model No.	Serial No.	Characteristics	Calibration Date	Test Date	Due Date	Remark
Programmable Power Supply	GW Instek	PSS-2005	EL883644	50Hz~60Hz	Dec. 03, 2021	Jul. 28, 2022~ Oct. 25, 2022	Dec. 02, 2023	Conducted (TH03-HY)
Hygrometer	Testo	608-H11	34893240	NA	Nov. 17, 2021	Jul. 28, 2022~ Oct. 25, 2022	Nov. 16, 2022	Conducted (TH03-HY)
Signal Analyzer	Rohde & Schwarz	FSV3044	101048	10Hz~44GHz	May 05, 2022	Jul. 28, 2022~ Oct. 25, 2022	May 04, 2023	Conducted (TH03-HY)
Temperature Chamber	ESPEC	SH-641	92013720	-40°C ~90°C	Sep. 09, 2021	Jul. 28, 2022~ Sep. 07, 2022	Sep. 08, 2022	Conducted (TH03-HY)
Temperature Chamber	ESPEC	SH-641	92013720	-40°C ~90°C	Sep. 07, 2022	Sep. 08, 2022~ Oct. 25, 2022	Sep. 06, 2023	Conducted (TH03-HY)
Base Station (Measure)	Anritsu	MT8821C	626211673 0	LTE	Jun. 15, 2021	Jul. 28, 2022~ Oct. 25, 2022	Jun. 14, 2023	Conducted (TH03-HY)
Base Station (Measure)	Anritsu	MT8000A	626194032 7	FR1	Oct. 29, 2021	Jul. 28, 2022~ Oct. 25, 2022	Oct. 28, 2022	Conducted (TH03-HY)



6 Uncertainty of Evaluation

Uncertainty of Radiated Emission Measurement (30 MHz ~ 1000 MHz)

Measuring Uncertainty for a Level of Confidence of 95% ($U = 2Uc(y)$)	3.31 dB
---	---------

Uncertainty of Radiated Emission Measurement (1 GHz ~ 18 GHz)

Measuring Uncertainty for a Level of Confidence of 95% ($U = 2Uc(y)$)	3.25 dB
---	---------

Uncertainty of Radiated Emission Measurement (18 GHz ~ 40 GHz)

Measuring Uncertainty for a Level of Confidence of 95% ($U = 2Uc(y)$)	3.81 dB
---	---------



Appendix A. Test Results of Conducted Test

Conducted Output Power(Average power) and EIRP

NR n48 Maximum Average Power [dBm] (GT - LC = 1 dB)								
BW [MHz]	RB Size	RB Offset	Mod	Lowest	Middle	Highest	EIRP (dBm)	EIRP(W)
10	1	1	PI/2 BPSK	21.45	21.40	21.36	22.53	0.1791
10	1	22		21.49	21.42	21.32		
10	12	6		21.53	21.47	21.39		
10	1	0		20.98	20.86	20.78		
10	1	23		20.94	20.88	20.75		
10	24	0		21.06	20.98	20.92		
10	1	1	QPSK	21.42	21.35	21.33	22.53	0.1791
10	1	22		21.44	21.38	21.30		
10	12	6		21.51	21.45	21.35		
10	1	0		20.43	20.33	20.27		
10	1	23		20.40	20.35	20.22		
10	24	0		20.48	20.40	20.37		
10	1	1	16-QAM	20.57	20.53	20.50	21.57	0.1435
10	1	1	64-QAM	18.94	18.79	18.73		
10	1	1	256-QAM	16.66	16.65	16.51		
Limit	EIRP < 23dBm/10MHz			Result			Pass	

Total EIRP power is less than partial EIRP limit 23 dBm/10MHz.



NR n48 Maximum Average Power [dBm] (GT - LC = 1 dB)										
BW [MHz]	RB Size	RB Offset	Mod	Lowest	Middle	Highest	EIRP (dBm)	EIRP(W)		
20	1	1	PI/2 BPSK	21.64	21.56	21.52	22.64	0.1837		
20	1	49		21.52	21.50	21.40				
20	25	12		21.59	21.63	21.60				
20	1	0		21.10	21.07	21.05				
20	1	50		20.97	20.99	20.85				
20	50	0		21.07	21.09	21.08				
20	1	1	QPSK	21.61	21.54	21.50			22.64	0.1837
20	1	49		21.49	21.48	21.38				
20	25	12		21.55	21.57	21.56				
20	1	0		20.60	20.58	20.48				
20	1	50		20.44	20.46	20.37				
20	50	0		20.52	20.57	20.53				
20	1	1	16-QAM	20.74	20.60	20.64	21.74	0.1493		
20	1	1	64-QAM	19.11	19.08	19.05				
20	1	1	256-QAM	16.90	16.72	16.71				
Limit	EIRP < 23dBm/10MHz			Result			Pass			

NR n48 Maximum Average Power [dBm] (GT - LC = 1 dB)										
BW [MHz]	RB Size	RB Offset	Mod	Lowest	Middle	Highest	EIRP (dBm)	EIRP(W)		
30	1	1	PI/2 BPSK	21.79	21.78	21.66	22.79	0.1901		
30	1	76		21.55	21.56	21.43				
30	36	18		21.67	21.66	21.54				
30	1	0		21.23	21.24	21.11				
30	1	77		20.94	21.03	20.95				
30	75	0		21.18	21.19	21.03				
30	1	1	QPSK	21.75	21.74	21.63			22.79	0.1901
30	1	76		21.53	21.54	21.41				
30	36	18		21.65	21.64	21.52				
30	1	0		20.70	20.71	20.60				
30	1	77		20.40	20.52	20.41				
30	75	0		20.61	20.62	20.52				
30	1	1	16-QAM	20.85	20.89	20.74	21.89	0.1545		
30	1	1	64-QAM	19.29	19.24	19.17				
30	1	1	256-QAM	17.00	16.95	16.91				
Limit	EIRP < 23dBm/10MHz			Result			Pass			

Total EIRP power is less than partial EIRP limit 23 dBm/10MHz.



NR n48 Maximum Average Power [dBm] (GT - LC = 1 dB)										
BW [MHz]	RB Size	RB Offset	Mod	Lowest	Middle	Highest	EIRP (dBm)	EIRP(W)		
40	1	1	PI/2 BPSK	21.81	21.73	21.55	22.81	0.1910		
40	1	104		21.63	21.56	21.53				
40	50	25		21.70	21.69	21.67				
40	1	0		21.25	21.27	21.02				
40	1	105		21.10	21.05	21.00				
40	100	0		21.22	21.20	21.12				
40	1	1	QPSK	21.79	21.69	21.51			21.90	0.1549
40	1	104		21.61	21.53	21.47				
40	50	25		21.66	21.64	21.62				
40	1	0		20.74	20.71	20.50				
40	1	105		20.56	20.53	20.46				
40	100	0		20.68	20.63	20.59				
40	1	1	16-QAM	20.90	20.81	20.66	21.90	0.1549		
40	1	1	64-QAM	19.29	19.20	19.03				
40	1	1	256-QAM	17.01	16.89	16.84				
Limit	EIRP < 23dBm/10MHz			Result			Pass			

Total EIRP power is less than partial EIRP limit 23 dBm/10MHz.



NR n77 Maximum Average Power [dBm] (GT - LC = 1 dB)								
BW [MHz]	RB Size	RB Offset	Mod	Lowest	Middle	Highest	EIRP (dBm)	EIRP(W)
10	1	1	PI/2 BPSK	20.05	20.32	20.39	21.54	0.1426
10	1	22		20.03	20.31	20.44		
10	12	6		20.12	20.43	20.54		
10	1	0		16.49	16.82	16.83		
10	1	23		16.50	16.81	16.86		
10	24	0		19.61	19.91	20.01		
10	1	1	QPSK	20.00	20.30	20.40		
10	1	22		19.98	20.33	20.42		
10	12	6		20.11	20.41	20.51		
10	1	0		16.44	16.75	16.76		
10	1	23		16.46	16.77	16.80		
10	24	0		19.10	19.38	19.53		
10	1	1	16-QAM	19.13	19.39	19.52	20.52	0.1127
10	1	1	64-QAM	17.52	17.78	17.86		
10	1	1	256-QAM	15.24	15.56	15.59		
Limit	EIRP < 23dBm/10MHz			Result			Pass	

NR n77 Maximum Average Power [dBm] (GT - LC = 1 dB)								
BW [MHz]	RB Size	RB Offset	Mod	Lowest	Middle	Highest	EIRP (dBm)	EIRP(W)
15	1	1	PI/2 BPSK	20.13	20.49	20.61	21.67	0.1469
15	1	36		20.11	20.45	20.63		
15	18	9		20.17	20.55	20.67		
15	1	0		16.57	16.88	17.04		
15	1	37		16.56	16.85	17.05		
15	36	0		19.65	19.97	20.12		
15	1	1	QPSK	20.12	20.43	20.55		
15	1	36		20.11	20.40	20.59		
15	18	9		20.16	20.51	20.64		
15	1	0		16.55	16.83	19.96		
15	1	37		16.52	16.81	16.97		
15	36	0		19.11	19.48	19.61		
15	1	1	16-QAM	19.32	19.47	19.68	20.68	0.1169
15	1	1	64-QAM	17.63	17.84	18.02		
15	1	1	256-QAM	15.33	15.63	15.74		
Limit	EIRP < 23dBm/10MHz			Result			Pass	

Total EIRP power is less than partial EIRP limit 23 dBm/10MHz.



NR n77 Maximum Average Power [dBm] (GT - LC = 1 dB)								
BW [MHz]	RB Size	RB Offset	Mod	Lowest	Middle	Highest	EIRP (dBm)	EIRP(W)
20	1	1	PI/2 BPSK	20.16	20.45	20.60	21.64	0.1459
20	1	49		20.19	20.47	20.56		
20	25	12		20.18	20.48	20.64		
20	1	0		16.61	16.89	17.00		
20	1	50		16.64	16.82	17.02		
20	50	0		19.76	20.05	20.15		
20	1	1	QPSK	20.12	20.38	20.58		
20	1	49		20.19	20.41	20.53		
20	25	12		20.23	20.50	20.62		
20	1	0		16.60	16.82	16.98		
20	1	50		16.64	16.78	16.95		
20	50	0		19.17	19.52	19.62		
20	1	1	16-QAM	19.27	19.57	19.71	20.71	0.1178
20	1	1	64-QAM	17.68	18.01	18.10		
20	1	1	256-QAM	15.38	15.62	15.74		
Limit	EIRP < 23dBm/10MHz			Result			Pass	

Total EIRP power is less than partial EIRP limit 23 dBm/10MHz.



NR n77 Maximum Average Power [dBm] (GT - LC = 1 dB)										
BW [MHz]	RB Size	RB Offset	Mod	Lowest	Middle	Highest	EIRP (dBm)	EIRP(W)		
30	1	1	PI/2 BPSK	20.24	20.51	20.62	21.70	0.1479		
30	1	76		20.21	20.44	20.70				
30	36	18		20.25	20.55	20.65				
30	1	0		16.70	17.00	17.15				
30	1	77		16.67	16.94	17.10				
30	75	0		19.77	20.04	20.14				
30	1	1	QPSK	20.22	20.50	20.58			20.71	0.1178
30	1	76		20.21	20.45	20.55				
30	36	18		20.25	20.52	20.62				
30	1	0		16.64	16.96	17.10				
30	1	77		16.61	16.89	17.06				
30	75	0		19.29	19.51	19.62				
30	1	1	16-QAM	19.34	19.60	19.71	20.71	0.1178		
30	1	1	64-QAM	17.70	17.97	18.11				
30	1	1	256-QAM	15.45	15.72	15.85				
Limit	EIRP < 23dBm/10MHz			Result			Pass			

NR n77 Maximum Average Power [dBm] (GT - LC = 1 dB)										
BW [MHz]	RB Size	RB Offset	Mod	Lowest	Middle	Highest	EIRP (dBm)	EIRP(W)		
40	1	1	PI/2 BPSK	20.50	20.74	20.84	21.84	0.1528		
40	1	104		20.43	20.60	20.73				
40	50	25		20.39	20.64	20.74				
40	1	0		16.97	17.25	17.36				
40	1	105		16.85	17.13	17.25				
40	100	0		19.87	20.13	20.24				
40	1	1	QPSK	20.40	20.73	20.81			20.82	0.1208
40	1	104		20.38	20.61	20.74				
40	50	25		20.37	20.59	20.72				
40	1	0		16.92	17.19	17.31				
40	1	105		16.82	17.03	17.26				
40	100	0		19.37	19.62	19.71				
40	1	1	16-QAM	19.38	19.74	19.82	20.82	0.1208		
40	1	1	64-QAM	17.92	18.21	18.29				
40	1	1	256-QAM	16.01	16.23	16.34				
Limit	EIRP < 23dBm/10MHz			Result			Pass			

Total EIRP power is less than partial EIRP limit 23 dBm/10MHz.



NR n77 Maximum Average Power [dBm] (GT - LC = 1 dB)										
BW [MHz]	RB Size	RB Offset	Mod	Lowest	Middle	Highest	EIRP (dBm)	EIRP(W)		
50	1	1	PI/2 BPSK	20.15	20.38	20.37	21.48	0.1406		
50	1	131		19.98	20.15	20.30				
50	64	32		20.16	20.37	20.48				
50	1	0		16.62	16.82	16.93				
50	1	132		16.42	16.61	16.82				
50	128	0		19.65	19.84	19.93				
50	1	1	QPSK	20.15	20.31	20.42			20.56	0.1138
50	1	131		20.00	20.11	20.27				
50	64	32		20.17	20.36	20.44				
50	1	0		16.57	16.80	16.85				
50	1	132		16.38	16.58	16.74				
50	128	0		19.14	19.34	19.42				
50	1	1	16-QAM	19.25	19.46	19.56	20.56	0.1138		
50	1	1	64-QAM	17.63	17.85	17.88				
50	1	1	256-QAM	15.35	15.61	15.67				
Limit	EIRP < 23dBm/10MHz			Result			Pass			

NR n77 Maximum Average Power [dBm] (GT - LC = 1 dB)										
BW [MHz]	RB Size	RB Offset	Mod	Lowest	Middle	Highest	EIRP (dBm)	EIRP(W)		
60	1	1	PI/2 BPSK	20.12	20.32	20.37	21.41	0.1384		
60	1	160		19.98	20.07	20.28				
60	81	40		20.17	20.30	20.41				
60	1	0		16.62	16.76	16.86				
60	1	161		16.46	16.63	16.79				
60	162	0		19.67	19.81	19.90				
60	1	1	QPSK	20.16	20.27	20.34			20.47	0.1114
60	1	160		19.95	20.10	20.27				
60	81	40		20.14	20.27	20.40				
60	1	0		16.57	16.73	16.86				
60	1	161		16.42	16.57	16.74				
60	162	0		19.17	19.32	19.41				
60	1	1	16-QAM	19.22	19.36	19.47	20.47	0.1114		
60	1	1	64-QAM	17.64	17.82	17.85				
60	1	1	256-QAM	15.37	15.55	15.65				
Limit	EIRP < 23dBm/10MHz			Result			Pass			

Total EIRP power is less than partial EIRP limit 23 dBm/10MHz.



NR n77 Maximum Average Power [dBm] (GT - LC = 1 dB)										
BW [MHz]	RB Size	RB Offset	Mod	Lowest	Middle	Highest	EIRP (dBm)	EIRP(W)		
70	1	1	PI/2 BPSK	19.92	20.22	20.27	21.32	0.1355		
70	1	187		19.80	20.01	20.05				
70	90	45		20.10	20.27	20.30				
70	1	0		16.49	16.68	16.73				
70	1	188		16.26	16.50	16.60				
70	180	0		19.54	19.73	19.79				
70	1	1	QPSK	19.91	20.22	20.26			20.29	0.1069
70	1	187		19.81	19.95	20.06				
70	90	45		20.06	20.26	20.32				
70	1	0		16.43	16.67	16.73				
70	1	188		16.25	16.42	16.53				
70	180	0		19.03	19.25	19.31				
70	1	1	16-QAM	19.01	19.29	19.29	20.29	0.1069		
70	1	1	64-QAM	17.39	17.72	17.74				
70	1	1	256-QAM	15.23	15.51	15.51				
Limit	EIRP < 23dBm/10MHz			Result			Pass			

NR n77 Maximum Average Power [dBm] (GT - LC = 1 dB)										
BW [MHz]	RB Size	RB Offset	Mod	Lowest	Middle	Highest	EIRP (dBm)	EIRP(W)		
80	1	1	PI/2 BPSK	20.04	20.17	20.32	21.33	0.1358		
80	1	215		19.95	20.06	20.14				
80	108	54		20.07	20.32	20.30				
80	1	0		16.47	16.67	16.83				
80	1	216		16.42	16.43	16.63				
80	216	0		19.48	19.79	19.77				
80	1	1	QPSK	19.97	20.13	20.31			20.46	0.1112
80	1	215		19.91	20.05	20.21				
80	108	54		20.05	20.21	20.33				
80	1	0		16.46	16.61	16.77				
80	1	216		16.27	16.38	16.57				
80	216	0		19.01	19.17	19.33				
80	1	1	16-QAM	19.09	19.28	19.46	20.46	0.1112		
80	1	1	64-QAM	17.51	17.64	17.81				
80	1	1	256-QAM	15.24	15.46	15.52				
Limit	EIRP < 23dBm/10MHz			Result			Pass			

Total EIRP power is less than partial EIRP limit 23 dBm/10MHz.



NR n77 Maximum Average Power [dBm] (GT - LC = 1 dB)										
BW [MHz]	RB Size	RB Offset	Mod	Lowest	Middle	Highest	EIRP (dBm)	EIRP(W)		
90	1	1	PI/2 BPSK	19.99	20.21	20.26	21.30	0.1349		
90	1	243		19.97	20.07	20.24				
90	120	60		20.07	20.23	20.30				
90	1	0		16.47	16.63	16.72				
90	1	244		16.49	16.57	16.64				
90	243	0		19.51	19.64	19.74				
90	1	1	QPSK	19.97	20.18	20.26			20.32	0.1076
90	1	243		19.96	20.13	20.24				
90	120	60		20.04	20.21	20.28				
90	1	0		16.40	16.20	16.72				
90	1	244		16.41	16.49	16.61				
90	243	0		19.02	19.15	19.26				
90	1	1	16-QAM	19.09	19.32	19.31	20.32	0.1076		
90	1	1	64-QAM	17.45	17.63	17.72				
90	1	1	256-QAM	15.27	15.41	15.52				
Limit	EIRP < 23dBm/10MHz			Result			Pass			

NR n77 Maximum Average Power [dBm] (GT - LC = 1 dB)										
BW [MHz]	RB Size	RB Offset	Mod	Lowest	Middle	Highest	EIRP (dBm)	EIRP(W)		
100	1	1	PI/2 BPSK	20.03	20.14	20.23	21.27	0.1340		
100	1	271		20.02	20.06	20.21				
100	135	67		20.14	20.21	20.27				
100	1	0		16.51	16.61	16.73				
100	1	272		16.52	16.56	16.69				
100	270	0		19.55	19.67	19.76				
100	1	1	QPSK	20.00	20.14	20.17			20.32	0.1076
100	1	271		20.02	20.02	20.20				
100	135	67		20.09	20.22	20.27				
100	1	0		16.49	16.62	16.69				
100	1	272		16.47	16.52	16.67				
100	270	0		19.04	19.13	19.25				
100	1	1	16-QAM	19.10	19.24	19.32	20.32	0.1076		
100	1	1	64-QAM	17.49	17.63	17.70				
100	1	1	256-QAM	15.29	15.38	15.48				
Limit	EIRP < 23dBm/10MHz			Result			Pass			

Total EIRP power is less than partial EIRP limit 23 dBm/10MHz.



NR n78 Maximum Average Power [dBm] (GT - LC = 1 dB)										
BW [MHz]	RB Size	RB Offset	Mod	Lowest	Middle	Highest	EIRP (dBm)	EIRP(W)		
10	1	1	PI/2 BPSK	20.28	20.34	20.18	21.44	0.1393		
10	1	22		20.29	20.41	20.24				
10	12	6		20.32	20.43	20.32				
10	1	0		16.75	16.84	16.78				
10	1	23		16.69	16.81	16.74				
10	24	0		19.85	19.95	19.83				
10	1	1	QPSK	20.20	20.32	20.27			20.43	0.1104
10	1	22		20.21	20.33	20.30				
10	12	6		20.32	20.44	20.34				
10	1	0		16.74	16.77	16.67				
10	1	23		16.65	16.72	16.70				
10	24	0		19.33	19.40	19.30				
10	1	1	16-QAM	19.34	19.43	19.32	20.43	0.1104		
10	1	1	64-QAM	17.76	17.82	17.79				
10	1	1	256-QAM	15.56	15.74	15.56				
Limit	EIRP < 23dBm/10MHz			Result			Pass			

NR n78 Maximum Average Power [dBm] (GT - LC = 1 dB)										
BW [MHz]	RB Size	RB Offset	Mod	Lowest	Middle	Highest	EIRP (dBm)	EIRP(W)		
15	1	1	PI/2 BPSK	20.40	20.49	20.42	21.53	0.1422		
15	1	36		20.45	20.46	20.31				
15	18	9		20.47	20.53	20.46				
15	1	0		16.95	16.93	16.83				
15	1	37		16.92	16.89	16.74				
15	36	0		19.98	20.05	19.95				
15	1	1	QPSK	20.42	20.49	20.39			20.61	0.1151
15	1	36		20.28	20.38	20.32				
15	18	9		20.47	20.51	20.43				
15	1	0		16.90	16.93	16.83				
15	1	37		16.84	16.85	16.78				
15	36	0		19.46	19.48	19.42				
15	1	1	16-QAM	19.58	19.60	19.61	20.61	0.1151		
15	1	1	64-QAM	17.88	17.98	17.93				
15	1	1	256-QAM	15.74	15.89	15.75				
Limit	EIRP < 23dBm/10MHz			Result			Pass			

Total EIRP power is less than partial EIRP limit 23 dBm/10MHz.



NR n78 Maximum Average Power [dBm] (GT - LC = 1 dB)								
BW [MHz]	RB Size	RB Offset	Mod	Lowest	Middle	Highest	EIRP (dBm)	EIRP(W)
20	1	1	PI/2 BPSK	20.48	20.46	20.34	21.53	0.1422
20	1	49		20.42	20.32	20.36		
20	25	12		20.46	20.52	20.41		
20	1	0		16.89	16.97	16.80		
20	1	50		16.81	16.78	16.85		
20	50	0		19.99	20.08	19.92		
20	1	1	QPSK	20.44	20.49	20.36	21.53	0.1422
20	1	49		20.30	20.35	20.39		
20	25	12		20.45	20.53	20.42		
20	1	0		16.91	16.91	16.81		
20	1	50		16.74	16.79	16.82		
20	50	0		19.50	19.50	19.39		
20	1	1	16-QAM	19.52	19.59	19.46	20.59	0.1146
20	1	1	64-QAM	18.01	18.01	17.92		
20	1	1	256-QAM	15.79	15.85	15.77		
Limit	EIRP < 23dBm/10MHz			Result			Pass	

Total EIRP power is less than partial EIRP limit 23 dBm/10MHz.



NR n78 Maximum Average Power [dBm] (GT - LC = 1 dB)										
BW [MHz]	RB Size	RB Offset	Mod	Lowest	Middle	Highest	EIRP (dBm)	EIRP(W)		
30	1	1	PI/2 BPSK	20.57	20.59	20.50	21.61	0.1449		
30	1	76		20.47	20.40	20.40				
30	36	18		20.46	20.55	20.52				
30	1	0		17.00	17.06	16.98				
30	1	77		16.86	16.87	16.82				
30	75	0		19.94	20.09	20.01				
30	1	1	QPSK	20.58	20.61	20.53			20.71	0.1178
30	1	76		20.41	20.45	20.37				
30	36	18		20.45	20.52	20.49				
30	1	0		17.00	17.03	16.92				
30	1	77		16.83	16.87	16.77				
30	75	0		19.44	19.50	19.51				
30	1	1	16-QAM	19.70	19.71	19.63	20.71	0.1178		
30	1	1	64-QAM	18.02	18.14	18.03				
30	1	1	256-QAM	15.92	16.04	15.98				
Limit	EIRP < 23dBm/10MHz			Result			Pass			

NR n78 Maximum Average Power [dBm] (GT - LC = 1 dB)										
BW [MHz]	RB Size	RB Offset	Mod	Lowest	Middle	Highest	EIRP (dBm)	EIRP(W)		
40	1	1	PI/2 BPSK	20.72	20.70	20.59	21.75	0.1496		
40	1	104		20.59	20.50	20.48				
40	50	25		20.48	20.53	20.49				
40	1	0		17.14	17.18	17.04				
40	1	105		16.97	16.95	16.90				
40	100	0		20.01	20.00	20.02				
40	1	1	QPSK	20.68	20.75	20.55			20.83	0.1211
40	1	104		20.56	20.53	20.40				
40	50	25		20.47	20.51	20.52				
40	1	0		17.11	17.16	17.01				
40	1	105		16.95	16.96	16.88				
40	100	0		19.52	19.54	19.53				
40	1	1	16-QAM	19.83	19.82	19.69	20.83	0.1211		
40	1	1	64-QAM	18.23	18.27	18.05				
40	1	1	256-QAM	16.05	16.14	16.04				
Limit	EIRP < 23dBm/10MHz			Result			Pass			

Total EIRP power is less than partial EIRP limit 23 dBm/10MHz.



NR n78 Maximum Average Power [dBm] (GT - LC = 1 dB)												
BW [MHz]	RB Size	RB Offset	Mod	Lowest	Middle	Highest	EIRP (dBm)	EIRP(W)				
50	1	1	PI/2 BPSK	20.31	20.31	20.25	21.37	0.1371				
50	1	131		20.01	20.05	20.08						
50	64	32		20.25	20.37	20.23						
50	1	0		16.73	16.78	16.72						
50	1	132		16.48	16.55	16.58						
50	128	0		19.70	19.77	19.68						
50	1	1	QPSK	20.32	20.32	20.27			20.42	0.1102		
50	1	131		20.01	20.07	20.10						
50	64	32		20.22	20.35	20.18						
50	1	0		16.78	16.77	16.67						
50	1	132		16.46	16.53	16.51						
50	128	0		19.19	19.29	19.18						
50	1	1	16-QAM	19.41	19.42	19.35					20.42	0.1102
50	1	1	64-QAM	17.81	17.85	17.75						
50	1	1	256-QAM	15.65	15.72	15.67						
Limit	EIRP < 23dBm/10MHz			Result			Pass					

NR n78 Maximum Average Power [dBm] (GT - LC = 1 dB)												
BW [MHz]	RB Size	RB Offset	Mod	Lowest	Middle	Highest	EIRP (dBm)	EIRP(W)				
60	1	1	PI/2 BPSK	20.23	20.32	20.18	21.35	0.1365				
60	1	160		20.04	20.08	20.09						
60	81	40		20.28	20.33	20.23						
60	1	0		16.71	16.82	16.63						
60	1	161		16.48	16.52	16.53						
60	162	0		19.77	19.78	19.68						
60	1	1	QPSK	20.24	20.33	20.18			20.46	0.1112		
60	1	160		20.02	20.06	20.07						
60	81	40		20.25	20.35	20.20						
60	1	0		16.73	16.79	16.61						
60	1	161		16.47	16.49	16.56						
60	162	0		19.22	19.35	19.22						
60	1	1	16-QAM	19.36	19.46	19.25					20.46	0.1112
60	1	1	64-QAM	17.79	17.83	17.70						
60	1	1	256-QAM	15.67	15.63	15.56						
Limit	EIRP < 23dBm/10MHz			Result			Pass					

Total EIRP power is less than partial EIRP limit 23 dBm/10MHz.



NR n78 Maximum Average Power [dBm] (GT - LC = 1 dB)										
BW [MHz]	RB Size	RB Offset	Mod	Lowest	Middle	Highest	EIRP (dBm)	EIRP(W)		
70	1	1	PI/2 BPSK	20.34	20.30	20.27	21.34	0.1361		
70	1	187		19.85	19.89	19.87				
70	90	45		20.21	20.24	20.21				
70	1	0		16.72	16.75	16.72				
70	1	188		16.26	16.28	16.31				
70	180	0		19.65	19.71	19.70				
70	1	1	QPSK	20.30	20.31	20.23			20.42	0.1102
70	1	187		19.87	19.85	19.85				
70	90	45		20.15	20.26	20.21				
70	1	0		16.80	16.78	16.72				
70	1	188		16.26	16.35	16.29				
70	180	0		19.15	19.23	19.16				
70	1	1	16-QAM	19.42	19.40	19.34	20.42	0.1102		
70	1	1	64-QAM	17.87	17.78	17.71				
70	1	1	256-QAM	15.68	15.71	15.66				
Limit	EIRP < 23dBm/10MHz			Result			Pass			

NR n78 Maximum Average Power [dBm] (GT - LC = 1 dB)										
BW [MHz]	RB Size	RB Offset	Mod	Lowest	Middle	Highest	EIRP (dBm)	EIRP(W)		
80	1	1	PI/2 BPSK	20.31	20.42	20.38	21.42	0.1387		
80	1	215		19.91	20.01	19.95				
80	108	54		20.24	20.29	20.20				
80	1	0		16.83	16.89	16.81				
80	1	216		16.38	16.37	16.34				
80	216	0		19.71	19.81	19.77				
80	1	1	QPSK	20.31	20.35	20.36			20.49	0.1119
80	1	215		19.89	19.99	19.86				
80	108	54		20.26	20.34	20.26				
80	1	0		16.78	16.82	16.81				
80	1	216		16.23	16.32	16.43				
80	216	0		19.23	19.27	19.23				
80	1	1	16-QAM	19.43	19.49	19.43	20.49	0.1119		
80	1	1	64-QAM	17.79	17.84	17.85				
80	1	1	256-QAM	15.66	15.81	15.74				
Limit	EIRP < 23dBm/10MHz			Result			Pass			

Total EIRP power is less than partial EIRP limit 23 dBm/10MHz.



NR n78 Maximum Average Power [dBm] (GT - LC = 1 dB)								
BW [MHz]	RB Size	RB Offset	Mod	Lowest	Middle	Highest	EIRP (dBm)	EIRP(W)
90	1	1	PI/2 BPSK	20.31	20.47	20.33	21.47	0.1403
90	1	243		19.97	20.02	20.02		
90	120	60		20.24	20.27	20.26		
90	1	0		16.76	16.87	16.73		
90	1	244		16.31	16.47	16.45		
90	243	0		19.74	19.71	19.70		
90	1	1	QPSK	20.25	20.43	20.28		
90	1	243		19.96	19.96	20.01		
90	120	60		20.26	20.25	20.26		
90	1	0		16.73	16.89	16.78		
90	1	244		16.29	16.38	16.47		
90	243	0		19.18	19.21	19.20		
90	1	1	16-QAM	19.42	19.54	19.40	20.54	0.1132
90	1	1	64-QAM	17.74	17.92	17.82		
90	1	1	256-QAM	15.61	15.82	15.70		
Limit	EIRP < 23dBm/10MHz			Result			Pass	

NR n78 Maximum Average Power [dBm] (GT - LC = 1 dB)								
BW [MHz]	RB Size	RB Offset	Mod	Lowest	Middle	Highest	EIRP (dBm)	EIRP(W)
100	1	1	PI/2 BPSK	20.32	20.41	20.29	21.43	0.1390
100	1	271		19.94	20.03	20.04		
100	135	67		20.30	20.30	20.25		
100	1	0		16.75	16.78	16.79		
100	1	272		16.38	16.51	16.46		
100	270	0		19.73	19.75	19.68		
100	1	1	QPSK	20.31	20.43	20.27		
100	1	271		19.96	20.03	20.03		
100	135	67		20.29	20.28	20.26		
100	1	0		16.77	16.87	16.72		
100	1	272		16.36	16.46	16.43		
100	270	0		19.21	19.24	19.24		
100	1	1	16-QAM	19.41	19.51	19.44	20.51	0.1125
100	1	1	64-QAM	17.84	17.92	17.77		
100	1	1	256-QAM	15.73	15.81	15.79		
Limit	EIRP < 23dBm/10MHz			Result			Pass	

Total EIRP power is less than partial EIRP limit 23 dBm/10MHz.



<MIMO Mode>

Part96 NR n77 Maximum Average Power [dBm], DG = 1 dBi														
BW (MHz)	RB Size	RB Offset	Mod	Antenna 0			Antenna 2			Combine			EIRP (dBm)	EIRP (W)
				Lowest	Middle	Highest	Lowest	Middle	Highest	Lowest	Middle	Highest		
10	1	1	QPSK	15.15	15.56	16.07	14.49	14.85	14.72	17.84	18.23	18.46	19.51	0.0893
10	1	22		15.25	15.96	15.84	14.45	14.98	14.91	17.88	18.51	18.41		
10	12	6		15.24	15.65	15.85	14.52	14.90	14.80	17.91	18.30	18.37		
10	1	0		13.03	13.72	13.67	12.44	12.72	12.63	15.76	16.26	16.19		
10	1	23		13.29	13.54	13.76	12.53	12.77	12.65	15.94	16.18	16.25		
10	24	0		13.67	14.11	14.32	13.08	13.32	13.23	16.40	16.74	16.82		
10	1	1	16-QAM	14.69	15.02	15.26	14.18	14.47	14.42	17.45	17.76	17.87	18.87	0.0771
10	1	1	64-QAM	13.03	13.47	13.70	12.29	12.58	12.52	15.69	16.06	16.16		
10	1	1	256-QAM	10.06	10.55	10.78	9.54	9.84	9.77	12.82	13.22	13.31		
Limit	EIRP < 23dBm/10MHz		Result									Pass		

Part96 NR n77 Maximum Average Power [dBm], DG = 1 dBi														
BW (MHz)	RB Size	RB Offset	Mod	Antenna 0			Antenna 2			Combine			EIRP (dBm)	EIRP (W)
				Lowest	Middle	Highest	Lowest	Middle	Highest	Lowest	Middle	Highest		
15	1	1	QPSK	15.61	15.68	15.81	14.86	14.87	14.85	18.26	18.30	18.37	19.55	0.0902
15	1	36		15.59	15.89	16.05	14.86	15.15	14.92	18.25	18.55	18.53		
15	19	9		15.37	15.69	15.93	14.70	14.92	14.78	18.06	18.33	18.40		
15	1	0		13.24	13.77	14.06	12.79	12.89	12.84	16.03	16.36	16.50		
15	1	37		13.65	13.66	14.25	12.92	12.92	12.83	16.31	16.32	16.61		
15	38	0		13.85	14.13	14.37	13.21	13.34	13.26	16.55	16.76	16.86		
15	1	1	16-QAM	14.87	15.27	15.29	14.53	14.63	14.51	17.71	17.97	17.93	18.97	0.0789
15	1	1	64-QAM	13.24	13.62	13.83	12.59	12.67	12.64	15.94	16.18	16.29		
15	1	1	256-QAM	10.34	10.72	10.85	9.88	9.95	9.92	13.13	13.36	13.42		
Limit	EIRP < 23dBm/10MHz		Result									Pass		

Part96 NR n77 Maximum Average Power [dBm], DG = 1 dBi														
BW (MHz)	RB Size	RB Offset	Mod	Antenna 0			Antenna 2			Combine			EIRP (dBm)	EIRP (W)
				Lowest	Middle	Highest	Lowest	Middle	Highest	Lowest	Middle	Highest		
20	1	1	QPSK	15.32	15.62	15.93	14.84	14.99	14.73	18.10	18.33	18.38	19.50	0.0891
20	1	49		15.36	15.92	15.96	14.93	15.01	14.88	18.16	18.50	18.46		
20	25	12		15.43	15.70	15.92	14.77	14.94	14.79	18.12	18.35	18.40		
20	1	0		13.29	13.71	13.75	12.82	12.89	12.73	16.07	16.33	16.28		
20	1	50		12.52	13.77	13.85	12.85	12.89	12.70	15.70	16.36	16.32		
20	51	0		13.16	14.19	14.36	13.21	13.34	13.32	16.20	16.80	16.88		
20	1	1	16-QAM	14.77	15.16	15.30	14.47	14.61	14.43	17.63	17.90	17.90	18.90	0.0776
20	1	1	64-QAM	13.25	13.55	13.73	12.56	12.69	12.52	15.93	16.15	16.18		
20	1	1	256-QAM	10.36	10.69	10.87	9.98	9.96	9.83	13.18	13.35	13.39		
Limit	EIRP < 23dBm/10MHz		Result									Pass		

Total EIRP power is less than partial EIRP limit 23 dBm/10MHz.



Part96 NR n77 Maximum Average Power [dBm], DG = 1 dBi														
BW	RB	RB	Mod	Antenna 0			Antenna 2			Combine			EIRP	EIRP
(MHz)	Size	Offset		Lowest	Middle	Highest	Lowest	Middle	Highest	Lowest	Middle	Highest	(dBm)	(W)
30	1	1	QPSK	15.82	16.06	16.12	14.83	14.97	14.87	18.36	18.56	18.55	19.66	0.0925
30	1	76		15.85	16.09	16.25	15.22	15.15	14.84	18.56	18.66	18.61		
30	39	19		15.57	15.82	16.06	14.87	14.97	14.94	18.24	18.43	18.55		
30	1	0		13.62	13.95	13.99	12.82	12.89	12.86	16.25	16.46	16.47		
30	1	77		13.55	13.92	14.05	12.90	13.02	12.72	16.25	16.50	16.45		
30	78	0		14.05	14.35	14.53	13.33	13.42	13.38	16.72	16.92	17.00		
30	1	1	16-QAM	15.05	15.14	15.45	14.62	14.65	14.56	17.85	17.91	18.04	19.04	0.0802
30	1	1	64-QAM	13.37	13.65	14.02	12.65	12.63	12.72	16.04	16.18	16.43		
30	1	1	256-QAM	10.45	10.72	10.93	9.86	9.85	9.86	13.18	13.32	13.44		
Limit	EIRP < 23dBm/10MHz			Result									Pass	

Part96 NR n77 Maximum Average Power [dBm], DG = 1 dBi														
BW	RB	RB	Mod	Antenna 0			Antenna 2			Combine			EIRP	EIRP
(MHz)	Size	Offset		Lowest	Middle	Highest	Lowest	Middle	Highest	Lowest	Middle	Highest	(dBm)	(W)
40	1	1	QPSK	15.92	15.85	15.98	15.05	15.11	15.03	18.52	18.51	18.54	20.03	0.1007
40	1	104		15.84	16.18	16.12	15.65	15.86	15.63	18.76	19.03	18.89		
40	53	26		15.53	15.83	15.95	14.80	15.01	14.78	18.19	18.45	18.41		
40	1	0		13.62	13.78	14.08	12.98	12.97	13.01	16.32	16.40	16.59		
40	1	105		13.56	13.93	13.95	12.93	13.04	12.75	16.27	16.52	16.40		
40	106	0		13.97	14.32	14.49	13.32	13.47	13.35	16.67	16.93	16.97		
40	1	1	16-QAM	15.05	15.38	15.51	14.65	14.76	14.76	17.86	18.09	18.16	19.16	0.0824
40	1	1	64-QAM	13.47	13.79	13.69	12.73	12.83	12.76	16.13	16.35	16.26		
40	1	1	256-QAM	10.62	10.82	10.94	10.05	10.02	10.02	13.35	13.45	13.51		
Limit	EIRP < 23dBm/10MHz			Result									Pass	

Part96 NR n77 Maximum Average Power [dBm], DG = 1 dBi														
BW	RB	RB	Mod	Antenna 0			Antenna 2			Combine			EIRP	EIRP
(MHz)	Size	Offset		Lowest	Middle	Highest	Lowest	Middle	Highest	Lowest	Middle	Highest	(dBm)	(W)
50	1	1	QPSK	15.16	15.46	15.82	14.65	15.06	14.78	17.92	18.27	18.34	19.34	0.0859
50	1	131		15.18	15.48	15.56	14.72	14.75	14.56	17.97	18.14	18.10		
50	67	33		15.21	15.59	15.72	14.57	14.82	14.54	17.91	18.23	18.18		
50	1	0		13.32	13.52	13.62	12.52	12.48	12.69	15.95	16.04	16.19		
50	1	132		13.12	13.57	13.81	12.57	12.69	12.46	15.86	16.16	16.20		
50	133	0		13.75	14.12	14.16	13.21	13.25	13.04	16.50	16.72	16.65		
50	1	1	16-QAM	14.63	14.85	14.96	14.27	14.53	14.32	17.46	17.70	17.66	18.70	0.0741
50	1	1	64-QAM	13.15	13.49	13.46	12.33	12.63	12.46	15.77	16.09	16.00		
50	1	1	256-QAM	10.20	10.48	10.50	9.55	9.89	9.72	12.90	13.21	13.14		
Limit	EIRP < 23dBm/10MHz			Result									Pass	

Part96 NR n77 Maximum Average Power [dBm], DG = 1 dBi														
BW	RB	RB	Mod	Antenna 0			Antenna 2			Combine			EIRP	EIRP
(MHz)	Size	Offset		Lowest	Middle	Highest	Lowest	Middle	Highest	Lowest	Middle	Highest	(dBm)	(W)
60	1	1	QPSK	15.21	15.27	15.42	14.58	14.85	14.82	17.92	18.08	18.14	19.27	0.0845
60	1	160		15.65	15.72	15.68	14.72	14.75	14.62	18.22	18.27	18.19		
60	81	40		15.24	15.58	15.69	14.72	14.76	14.57	18.00	18.20	18.18		
60	1	0		13.33	13.45	13.54	12.58	12.75	12.72	15.98	16.12	16.16		
60	1	161		13.51	13.72	13.78	12.62	12.67	12.53	16.10	16.24	16.21		
60	162	0		13.77	14.05	14.13	13.18	13.22	13.13	16.50	16.67	16.67		
60	1	1	16-QAM	14.72	14.77	14.92	14.25	14.56	14.45	17.50	17.68	17.70	18.70	0.0741
60	1	1	64-QAM	13.24	13.21	13.42	12.34	12.56	12.54	15.82	15.91	16.01		
60	1	1	256-QAM	10.26	10.32	10.43	9.69	9.86	9.80	12.99	13.11	13.14		
Limit	EIRP < 23dBm/10MHz			Result									Pass	

Total EIRP power is less than partial EIRP limit 23 dBm/10MHz.



Part96 NR n77 Maximum Average Power [dBm], DG = 1 dBi														
BW	RB	RB	Mod	Antenna 0			Antenna 2			Combine			EIRP	EIRP
(MHz)	Size	Offset		Lowest	Middle	Highest	Lowest	Middle	Highest	Lowest	Middle	Highest	(dBm)	(W)
70	1	1	QPSK	15.06	15.38	15.34	14.52	14.66	14.67	17.81	18.05	18.03	19.34	0.0859
70	1	187		15.17	16.02	15.58	14.49	14.52	14.43	17.85	18.34	18.05		
70	95	47		15.05	15.48	15.62	14.53	14.61	14.65	17.81	18.08	18.17		
70	1	0		13.18	12.96	13.46	12.38	12.62	12.63	15.81	15.81	16.08		
70	1	188		13.46	13.61	13.67	12.37	12.34	12.44	15.96	16.03	16.11		
70	189	0		13.58	13.90	14.03	12.94	13.06	13.03	16.28	16.51	16.57		
70	1	1	16-QAM	14.42	14.63	14.82	14.13	14.31	14.32	17.29	17.48	17.59	18.59	0.0723
70	1	1	64-QAM	13.03	13.07	13.28	12.13	12.46	12.46	15.61	15.79	15.90		
70	1	1	256-QAM	10.03	10.10	10.32	9.37	9.72	9.63	12.72	12.92	13.00		
Limit	EIRP < 23dBm/10MHz			Result									Pass	

Part96 NR n77 Maximum Average Power [dBm], DG = 1 dBi														
BW	RB	RB	Mod	Antenna 0			Antenna 2			Combine			EIRP	EIRP
(MHz)	Size	Offset		Lowest	Middle	Highest	Lowest	Middle	Highest	Lowest	Middle	Highest	(dBm)	(W)
80	1	1	QPSK	14.96	15.10	15.25	14.48	14.66	14.46	17.74	17.90	17.88	19.16	0.0824
80	1	215		15.28	15.68	15.58	14.45	14.54	14.40	17.90	18.16	18.04		
80	109	54		15.15	15.43	15.47	14.52	14.61	14.54	17.86	18.05	18.04		
80	1	0		12.93	12.96	13.24	12.31	12.60	12.46	15.64	15.79	15.88		
80	1	216		13.42	13.53	13.68	12.47	12.36	12.36	15.98	15.99	16.08		
80	217	0		13.71	13.87	13.99	13.02	13.03	12.94	16.39	16.48	16.51		
80	1	1	16-QAM	14.45	14.34	14.83	14.05	14.29	14.19	17.26	17.33	17.53	18.53	0.0713
80	1	1	64-QAM	12.92	12.92	13.20	12.62	12.39	12.28	15.78	15.67	15.77		
80	1	1	256-QAM	9.93	10.06	10.27	9.46	9.62	9.45	12.71	12.86	12.89		
Limit	EIRP < 23dBm/10MHz			Result									Pass	

Part96 NR n77 Maximum Average Power [dBm], DG = 1 dBi														
BW	RB	RB	Mod	Antenna 0			Antenna 2			Combine			EIRP	EIRP
(MHz)	Size	Offset		Lowest	Middle	Highest	Lowest	Middle	Highest	Lowest	Middle	Highest	(dBm)	(W)
90	1	1	QPSK	14.95	14.98	15.24	14.31	14.72	14.54	17.65	17.86	17.91	19.16	0.0824
90	1	243		15.23	15.56	15.68	14.58	14.46	14.54	17.93	18.06	18.16		
90	123	61		15.14	15.45	15.55	14.45	14.62	14.49	17.82	18.07	18.06		
90	1	0		12.93	12.92	13.35	12.31	12.56	12.52	15.64	15.75	15.97		
90	1	244		13.15	13.58	13.47	12.50	12.33	13.37	15.85	16.01	16.43		
90	245	0		13.63	13.84	14.00	12.94	13.07	13.01	16.31	16.48	16.54		
90	1	1	16-QAM	14.42	14.52	14.65	14.04	14.25	14.24	17.24	17.40	17.46	18.46	0.0701
90	1	1	64-QAM	12.84	12.91	13.24	12.12	12.36	12.30	15.51	15.65	15.81		
90	1	1	256-QAM	9.92	9.96	10.21	9.26	9.62	9.54	12.61	12.80	12.90		
Limit	EIRP < 23dBm/10MHz			Result									Pass	

Part96 NR n77 Maximum Average Power [dBm], DG = 1 dBi														
BW	RB	RB	Mod	Antenna 0			Antenna 2			Combine			EIRP	EIRP
(MHz)	Size	Offset		Lowest	Middle	Highest	Lowest	Middle	Highest	Lowest	Middle	Highest	(dBm)	(W)
100	1	1	QPSK	15.19	15.19	15.47	14.46	14.62	14.58	17.85	17.92	18.06	19.21	0.0834
100	1	271		15.34	15.83	15.58	14.63	14.47	14.47	18.01	18.21	18.07		
100	137	68		15.17	15.41	15.47	14.53	14.60	14.53	17.87	18.03	18.04		
100	1	0		13.03	13.07	13.21	12.36	12.56	12.56	15.72	15.83	15.91		
100	1	272		13.52	13.73	13.75	12.50	12.39	12.41	16.05	16.12	16.14		
100	273	0		13.68	13.85	13.92	13.02	13.10	12.95	16.37	16.50	16.47		
100	1	1	16-QAM	14.41	14.44	14.67	14.09	14.31	14.22	17.26	17.39	17.46	18.46	0.0701
100	1	1	64-QAM	12.88	12.87	13.08	12.16	12.34	12.33	15.55	15.62	15.73		
100	1	1	256-QAM	10.04	9.96	10.13	9.43	9.56	9.56	12.76	12.77	12.86		
Limit	EIRP < 23dBm/10MHz			Result									Pass	

Total EIRP power is less than partial EIRP limit 23 dBm/10MHz.



Part96 NR n78 Maximum Average Power [dBm], DG = 1 dBi														
BW	RB	RB	Mod	Antenna 0			Antenna 2			Combine			EIRP	EIRP
(MHz)	Size	Offset		Lowest	Middle	Highest	Lowest	Middle	Highest	Lowest	Middle	Highest	(dBm)	(W)
10	1	1	QPSK	15.72	15.62	15.68	15.62	15.75	15.76	18.68	18.70	18.73	19.75	0.0944
10	1	22		15.62	15.76	15.75	15.70	15.72	15.60	18.67	18.75	18.69		
10	12	6		15.65	15.72	15.72	15.62	15.68	15.72	18.65	18.71	18.73		
10	1	0		13.48	13.67	13.84	13.62	12.82	13.79	16.56	16.28	16.83		
10	1	23		13.80	13.42	13.75	13.53	13.87	13.77	16.68	16.66	16.77		
10	24	0		14.14	14.24	14.34	14.02	14.25	14.21	17.09	17.26	17.29		
10	1	1	16-QAM	15.12	15.27	15.24	15.31	15.44	15.42	18.23	18.37	18.34	19.37	0.0865
10	1	1	64-QAM	13.46	13.65	13.56	13.32	13.58	13.52	16.40	16.63	16.55		
10	1	1	256-QAM	10.59	10.87	10.78	10.54	10.83	10.75	13.57	13.86	13.78		
Limit	EIRP < 23dBm/10MHz			Result									Pass	

Part96 NR n78 Maximum Average Power [dBm], DG = 1 dBi														
BW	RB	RB	Mod	Antenna 0			Antenna 2			Combine			EIRP	EIRP
(MHz)	Size	Offset		Lowest	Middle	Highest	Lowest	Middle	Highest	Lowest	Middle	Highest	(dBm)	(W)
15	1	1	QPSK	15.86	15.58	15.79	15.82	15.98	15.89	18.85	18.79	18.85	20.01	0.1002
15	1	36		15.87	15.95	15.95	15.82	16.04	15.94	18.86	19.01	18.96		
15	19	9		15.72	15.72	15.76	15.71	15.70	15.67	18.73	18.72	18.73		
15	1	0		13.62	13.79	13.77	13.75	13.94	13.52	16.70	16.88	16.66		
15	1	37		13.66	13.82	13.82	13.78	13.94	13.96	16.73	16.89	16.90		
15	38	0		14.23	14.34	14.31	14.21	14.42	14.26	17.23	17.39	17.30		
15	1	1	16-QAM	15.21	15.37	15.36	15.42	15.66	15.46	18.33	18.53	18.42	19.53	0.0897
15	1	1	64-QAM	13.54	13.75	13.77	13.62	13.76	13.58	16.59	16.77	16.69		
15	1	1	256-QAM	10.69	10.85	10.75	10.82	10.92	10.85	13.77	13.90	13.81		
Limit	EIRP < 23dBm/10MHz			Result									Pass	

Part96 NR n78 Maximum Average Power [dBm], DG = 1 dBi														
BW	RB	RB	Mod	Antenna 0			Antenna 2			Combine			EIRP	EIRP
(MHz)	Size	Offset		Lowest	Middle	Highest	Lowest	Middle	Highest	Lowest	Middle	Highest	(dBm)	(W)
20	1	1	QPSK	15.68	16.11	15.91	15.62	15.67	15.78	18.66	18.91	18.86	19.91	0.0979
20	1	49		15.88	15.83	15.98	15.86	15.86	15.82	18.88	18.86	18.91		
20	25	12		15.74	15.87	15.76	15.77	15.92	15.77	18.77	18.91	18.78		
20	1	0		13.64	13.81	13.88	13.83	13.92	13.72	16.75	16.88	16.81		
20	1	50		13.85	13.98	13.70	13.82	14.02	13.72	16.85	17.01	16.72		
20	51	0		14.21	14.36	14.34	14.25	14.37	14.26	17.24	17.38	17.31		
20	1	1	16-QAM	15.15	15.32	15.35	15.42	15.54	15.32	18.30	18.44	18.35	19.44	0.0879
20	1	1	64-QAM	13.54	13.75	13.69	13.54	13.69	13.54	16.55	16.73	16.63		
20	1	1	256-QAM	10.68	10.86	10.72	10.85	10.94	10.75	13.78	13.91	13.75		
Limit	EIRP < 23dBm/10MHz			Result									Pass	

Total EIRP power is less than partial EIRP limit 23 dBm/10MHz.



Part96 NR n78 Maximum Average Power [dBm], DG = 1 dBi														
BW	RB	RB	Mod	Antenna 0			Antenna 2			Combine			EIRP	EIRP
(MHz)	Size	Offset		Lowest	Middle	Highest	Lowest	Middle	Highest	Lowest	Middle	Highest	(dBm)	(W)
30	1	1	QPSK	15.98	15.96	15.92	16.03	16.04	15.88	19.02	19.01	18.91	20.02	0.1005
30	1	76		15.94	15.95	15.93	15.85	15.91	15.83	18.91	18.94	18.89		
30	39	19		15.95	15.97	16.01	15.98	15.95	15.89	18.98	18.97	18.96		
30	1	0		13.82	14.06	13.92	14.02	14.07	13.98	16.93	17.08	16.96		
30	1	77		13.92	14.06	13.89	14.17	14.08	13.96	17.06	17.08	16.94		
30	78	0		14.45	14.43	14.15	14.50	14.45	14.42	17.49	17.45	17.30		
30	1	1	16-QAM	15.36	15.41	15.44	15.62	15.72	15.62	18.50	18.58	18.54	19.58	0.0908
30	1	1	64-QAM	13.74	13.82	13.81	13.82	13.81	13.71	16.79	16.83	16.77		
30	1	1	256-QAM	10.86	10.94	10.98	11.01	11.08	10.82	13.95	14.02	13.91		
Limit	EIRP < 23dBm/10MHz			Result									Pass	

Part96 NR n78 Maximum Average Power [dBm], DG = 1 dBi														
BW	RB	RB	Mod	Antenna 0			Antenna 2			Combine			EIRP	EIRP
(MHz)	Size	Offset		Lowest	Middle	Highest	Lowest	Middle	Highest	Lowest	Middle	Highest	(dBm)	(W)
40	1	1	QPSK	15.85	15.95	15.95	16.02	15.81	15.92	18.95	18.89	18.95	19.99	0.0998
40	1	104		15.70	15.98	15.95	16.15	15.98	15.91	18.94	18.99	18.94		
40	53	26		15.82	15.94	15.95	15.93	15.98	15.78	18.89	18.97	18.88		
40	1	0		13.82	14.09	14.41	14.12	14.12	14.35	16.98	17.12	17.39		
40	1	105		13.73	14.03	13.92	14.09	14.12	13.82	16.92	17.09	16.88		
40	106	0		14.38	14.48	14.39	14.46	14.52	14.36	17.43	17.51	17.39		
40	1	1	16-QAM	15.42	15.41	15.26	15.55	15.74	15.47	18.50	18.59	18.38	19.59	0.0910
40	1	1	64-QAM	13.82	13.82	13.89	13.76	13.93	13.83	16.80	16.89	16.87		
40	1	1	256-QAM	10.92	11.06	11.01	11.01	11.16	10.98	13.98	14.12	14.01		
Limit	EIRP < 23dBm/10MHz			Result									Pass	

Part96 NR n78 Maximum Average Power [dBm], DG = 1 dBi														
BW	RB	RB	Mod	Antenna 0			Antenna 2			Combine			EIRP	EIRP
(MHz)	Size	Offset		Lowest	Middle	Highest	Lowest	Middle	Highest	Lowest	Middle	Highest	(dBm)	(W)
50	1	1	QPSK	15.72	15.54	15.42	15.64	15.82	15.72	18.69	18.69	18.58	19.73	0.0940
50	1	131		15.42	15.45	15.49	15.62	15.83	15.51	18.53	18.65	18.51		
50	67	33		15.51	15.68	15.62	15.67	15.76	15.54	18.60	18.73	18.59		
50	1	0		13.54	13.51	13.58	13.62	13.85	13.66	16.59	16.69	16.63		
50	1	132		13.62	13.48	13.51	13.65	13.74	13.52	16.65	16.62	16.53		
50	133	0		14.01	14.19	14.10	14.14	14.32	14.04	17.09	17.27	17.08		
50	1	1	16-QAM	15.06	15.01	14.72	15.32	15.25	15.32	18.20	18.14	18.04	19.20	0.0832
50	1	1	64-QAM	13.44	13.42	13.36	13.45	13.57	13.47	16.46	16.51	16.43		
50	1	1	256-QAM	10.56	10.54	10.42	10.65	10.85	10.67	13.62	13.71	13.56		
Limit	EIRP < 23dBm/10MHz			Result									Pass	

Part96 NR n78 Maximum Average Power [dBm], DG = 1 dBi														
BW	RB	RB	Mod	Antenna 0			Antenna 2			Combine			EIRP	EIRP
(MHz)	Size	Offset		Lowest	Middle	Highest	Lowest	Middle	Highest	Lowest	Middle	Highest	(dBm)	(W)
60	1	1	QPSK	15.54	15.65	15.73	15.63	15.88	15.81	18.60	18.78	18.78	19.82	0.0959
60	1	160		15.86	15.73	15.56	15.76	15.77	15.72	18.82	18.76	18.65		
60	81	40		15.45	15.76	15.18	15.78	15.80	15.12	18.63	18.79	18.16		
60	1	0		13.52	13.47	13.32	13.65	13.52	13.72	16.60	16.51	16.53		
60	1	161		13.68	13.58	13.72	13.76	13.68	13.63	16.73	16.64	16.69		
60	162	0		14.07	14.11	14.10	14.23	14.27	14.15	17.16	17.20	17.14		
60	1	1	16-QAM	14.92	14.88	14.93	15.32	15.36	15.43	18.13	18.14	18.20	19.20	0.0832
60	1	1	64-QAM	13.33	13.31	13.35	13.45	13.53	13.51	16.40	16.43	16.44		
60	1	1	256-QAM	10.58	10.42	10.51	10.72	10.83	10.77	13.66	13.64	13.65		
Limit	EIRP < 23dBm/10MHz			Result									Pass	

Total EIRP power is less than partial EIRP limit 23 dBm/10MHz.



Part96 NR n78 Maximum Average Power [dBm], DG = 1 dBi														
BW	RB	RB	Mod	Antenna 0			Antenna 2			Combine			EIRP	EIRP
(MHz)	Size	Offset		Lowest	Middle	Highest	Lowest	Middle	Highest	Lowest	Middle	Highest	(dBm)	(W)
70	1	1	QPSK	14.47	15.42	15.62	15.54	15.72	15.72	18.05	18.58	18.68	19.69	0.0931
70	1	187		15.62	15.52	15.46	15.46	15.78	15.54	18.55	18.66	18.51		
70	95	47		15.42	15.69	15.72	15.55	15.66	15.37	18.50	18.69	18.56		
70	1	0		13.58	13.49	13.56	13.54	13.75	13.68	16.57	16.63	16.63		
70	1	188		13.36	13.68	13.47	13.45	13.53	13.45	16.42	16.62	16.47		
70	189	0		13.95	14.08	14.10	13.97	14.16	14.11	16.97	17.13	17.12		
70	1	1	16-QAM	14.85	14.83	15.02	15.26	15.35	15.35	18.07	18.11	18.20	19.20	0.0832
70	1	1	64-QAM	13.35	13.29	13.45	13.25	13.45	13.52	16.31	16.38	16.50		
70	1	1	256-QAM	10.41	10.34	10.47	10.51	10.73	10.70	13.47	13.55	13.60		
Limit	EIRP < 23dBm/10MHz			Result									Pass	

Part96 NR n78 Maximum Average Power [dBm], DG = 1 dBi														
BW	RB	RB	Mod	Antenna 0			Antenna 2			Combine			EIRP	EIRP
(MHz)	Size	Offset		Lowest	Middle	Highest	Lowest	Middle	Highest	Lowest	Middle	Highest	(dBm)	(W)
80	1	1	QPSK	15.35	15.52	15.54	15.52	15.76	15.61	18.45	18.65	18.59	19.75	0.0944
80	1	215		15.52	15.94	15.72	15.65	15.54	15.54	18.60	18.75	18.64		
80	109	54		15.42	15.62	15.54	15.62	15.64	15.52	18.53	18.64	18.54		
80	1	0		13.42	13.35	13.45	13.54	13.68	13.56	16.49	16.53	16.52		
80	1	216		13.62	13.65	13.52	13.52	13.43	13.39	16.58	16.55	16.47		
80	217	0		13.92	14.06	14.03	14.04	14.13	14.02	16.99	17.11	17.04		
80	1	1	16-QAM	14.87	14.76	14.97	15.24	15.26	15.21	18.07	18.03	18.10	19.12	0.0817
80	1	1	64-QAM	13.21	13.14	14.98	13.31	13.41	15.24	16.27	16.29	18.12		
80	1	1	256-QAM	10.39	10.24	10.46	10.54	10.64	10.55	13.48	13.45	13.52		
Limit	EIRP < 23dBm/10MHz			Result									Pass	

Part96 NR n78 Maximum Average Power [dBm], DG = 1 dBi														
BW	RB	RB	Mod	Antenna 0			Antenna 2			Combine			EIRP	EIRP
(MHz)	Size	Offset		Lowest	Middle	Highest	Lowest	Middle	Highest	Lowest	Middle	Highest	(dBm)	(W)
90	1	1	QPSK	15.49	15.28	15.72	15.60	15.73	15.65	18.56	18.52	18.70	19.70	0.0933
90	1	243		15.61	15.70	15.78	15.65	15.51	15.54	18.64	18.62	18.67		
90	123	61		15.34	15.62	15.60	15.53	15.65	15.66	18.45	18.65	18.64		
90	1	0		13.45	13.26	13.48	13.54	13.62	13.60	16.51	16.45	16.55		
90	1	244		13.50	13.65	13.74	13.58	13.42	13.45	16.55	16.55	16.61		
90	245	0		13.84	14.00	14.07	13.98	14.09	14.05	16.92	17.06	17.07		
90	1	1	16-QAM	15.01	14.83	15.14	15.19	15.23	15.24	18.11	18.04	18.20	19.20	0.0832
90	1	1	64-QAM	13.37	13.28	13.48	13.26	13.42	13.36	16.33	16.36	16.43		
90	1	1	256-QAM	10.33	10.64	10.53	10.54	10.62	10.58	13.45	13.64	13.57		
Limit	EIRP < 23dBm/10MHz			Result									Pass	

Part96 NR n78 Maximum Average Power [dBm], DG = 1 dBi														
BW	RB	RB	Mod	Antenna 0			Antenna 2			Combine			EIRP	EIRP
(MHz)	Size	Offset		Lowest	Middle	Highest	Lowest	Middle	Highest	Lowest	Middle	Highest	(dBm)	(W)
100	1	1	QPSK	15.71	15.65	15.42	15.65	15.54	15.65	18.69	18.61	18.55	19.69	0.0931
100	1	271		15.60	15.56	15.72	15.68	15.49	15.51	18.65	18.54	18.63		
100	137	68		15.45	15.62	15.51	15.64	15.66	15.54	18.56	18.65	18.54		
100	1	0		13.37	13.31	13.35	13.52	13.62	13.57	16.46	16.48	16.47		
100	1	272		13.47	13.62	13.53	13.62	13.45	13.47	16.56	16.55	16.51		
100	273	0		13.96	14.01	13.98	14.05	14.07	13.87	17.02	17.05	16.94		
100	1	1	16-QAM	14.89	14.81	14.93	15.24	15.24	15.16	18.08	18.04	18.06	19.08	0.0809
100	1	1	64-QAM	13.36	13.27	13.34	13.31	13.45	13.37	16.35	16.37	16.37		
100	1	1	256-QAM	10.39	10.35	10.38	10.52	10.62	10.54	13.47	13.50	13.47		
Limit	EIRP < 23dBm/10MHz			Result									Pass	

Total EIRP power is less than partial EIRP limit 23 dBm/10MHz.



FR1 n48

Peak-to-Average Ratio

Mode	FR1 n48 / 20MHz / DFT-S OFDM				
Mod.	PI/2 BPSK	QPSK	16QAM	64QAM	Limit: 13dB
RB Size	Full RB	Full RB	Full RB	Full RB	Result
Middle CH	3.94	4.62	5.56	6.02	PASS
Mode	FR1 n48 / 20MHz / DFT-S OFDM				
Mod.	256QAM				Limit: 13dB
RB Size	Full RB				Result
Middle CH	6.52				PASS



FR1 n48 / 20MHz / DFT-S OFDM / Middle Channel / Full RB

PI/2 BPSK

QPSK

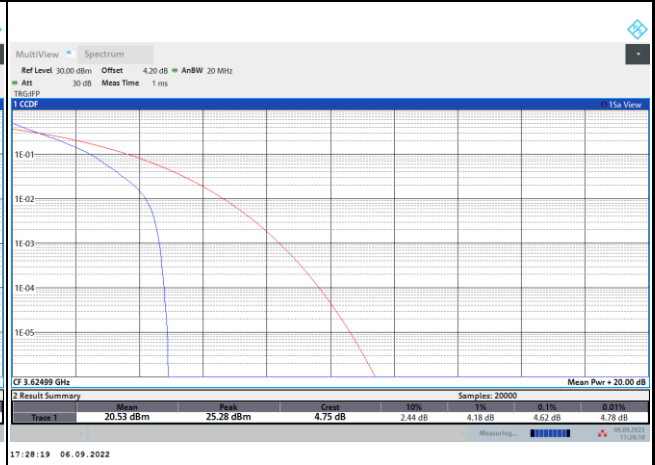
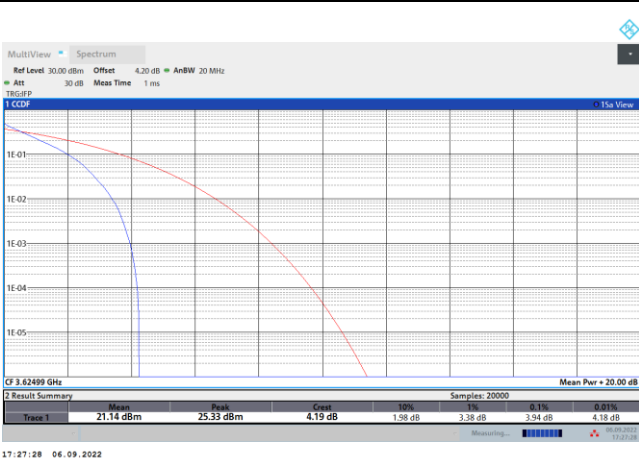

16QAM

64QAM

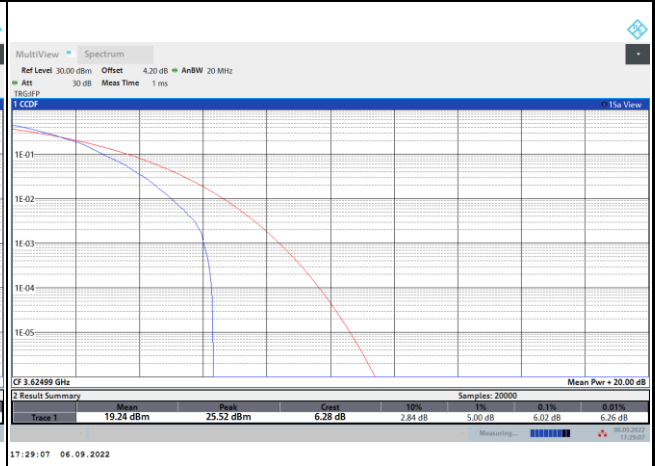
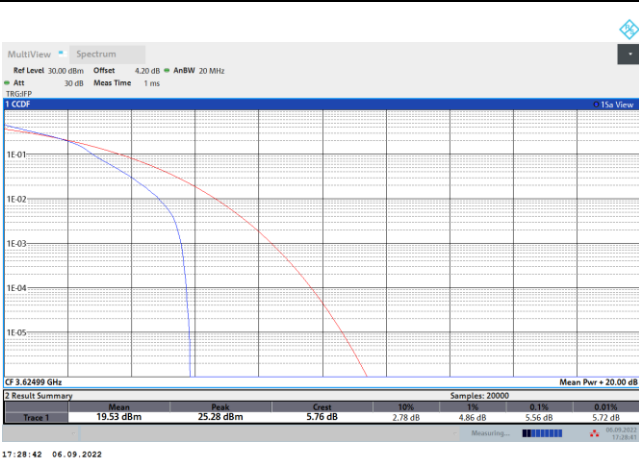

256QAM

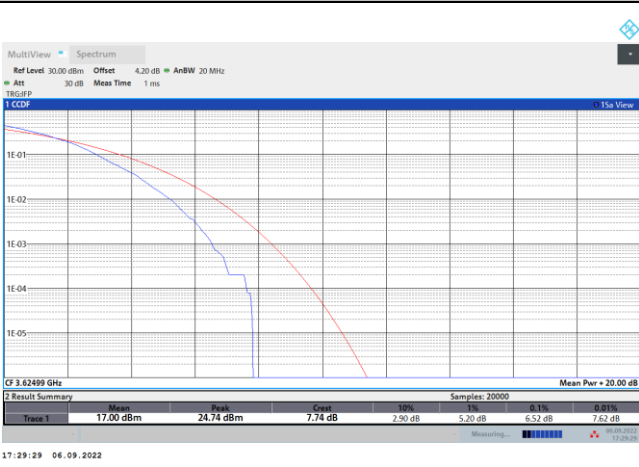



26dB Bandwidth

Mode	FR1 n48 : 26dB BW(MHz) / DFT-S OFDM							
BW	10MHz	15MHz	20MHz	30MHz	40MHz	50MHz	60MHz	70MHz
Mod.	PI/2 BPSK	PI/2 BPSK	PI/2 BPSK	PI/2 BPSK	PI/2 BPSK	PI/2 BPSK	PI/2 BPSK	PI/2 BPSK
Middle CH	9.27	-	18.90	27.81	38.36	-	-	-
BW	80MHz	90MHz	100MHz					
Mod.	PI/2 BPSK	PI/2 BPSK	PI/2 BPSK					
Middle CH	-	-	-					

Mode	FR1 n48 : 26dB BW(MHz) / CP OFDM							
BW	10MHz		15MHz		20MHz		30MHz	
Mod.	QPSK	16QAM	QPSK	16QAM	QPSK	16QAM	QPSK	16QAM
Middle CH	9.21	9.25	-	-	19.10	19.26	29.13	29.07
Mod.	64QAM	256QAM	64QAM	256QAM	64QAM	256QAM	64QAM	256QAM
Middle CH	9.17	9.09	-	-	19.02	19.34	29.13	29.25
BW	40MHz		50MHz		60MHz		70MHz	
Mod.	QPSK	16QAM	QPSK	16QAM	QPSK	16QAM	QPSK	16QAM
Middle CH	40.36	40.44	-	-	-	-	-	-
Mod.	64QAM	256QAM	64QAM	256QAM	64QAM	256QAM	64QAM	256QAM
Middle CH	40.36	40.44	-	-	-	-	-	-
BW	80MHz		90MHz		100MHz			
Mod.	QPSK	16QAM	QPSK	16QAM	QPSK	16QAM		
Middle CH	-	-	-	-	-	-		
Mod.	64QAM	256QAM	64QAM	256QAM	64QAM	256QAM		
Middle CH	-	-	-	-	-	-		



FR1 n48 / 10MHz / DFT-S OFDM / Middle Channel / Full RB

PI/2 BPSK

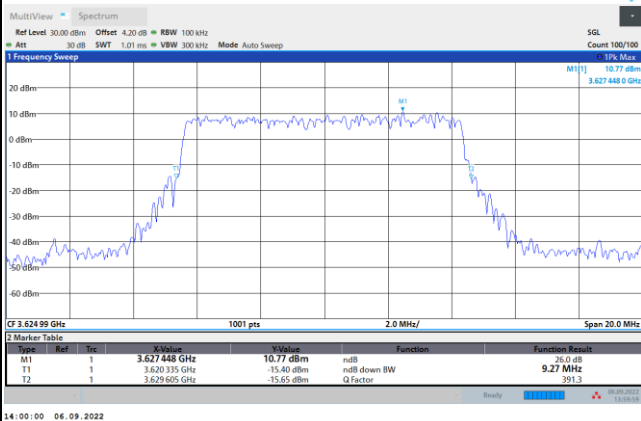

FR1 n48 / 10MHz / CP OFDM / Middle Channel / Full RB

QPSK

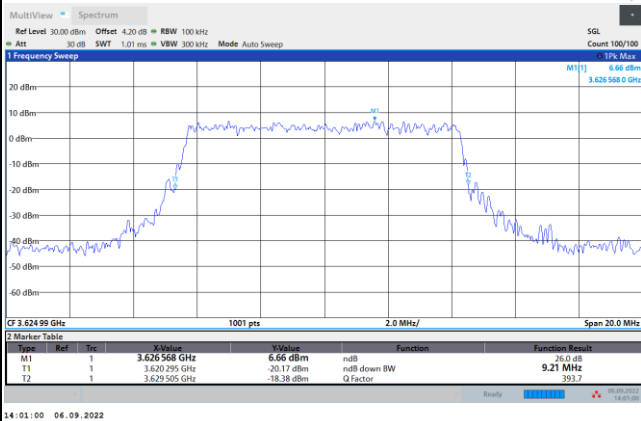

16QAM

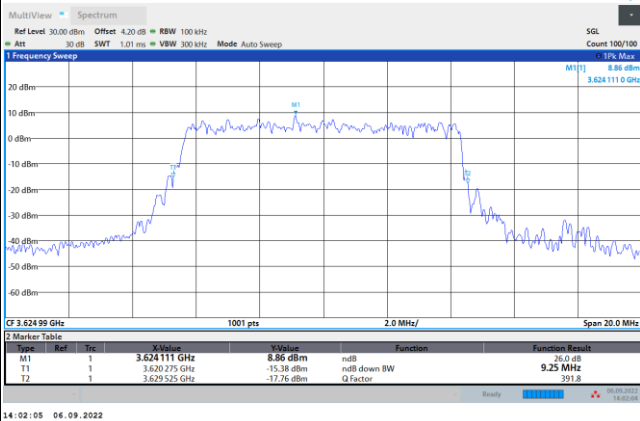

64QAM

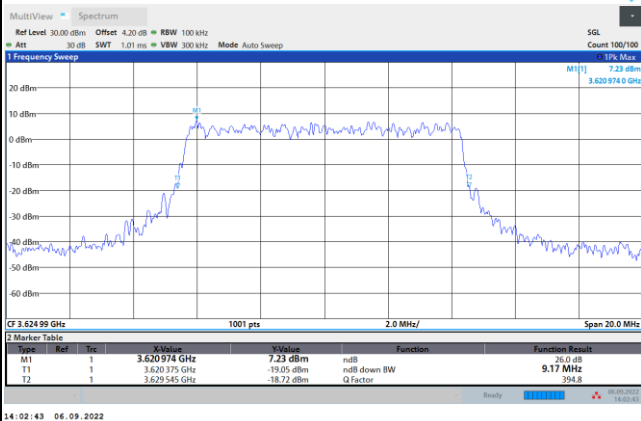

256QAM

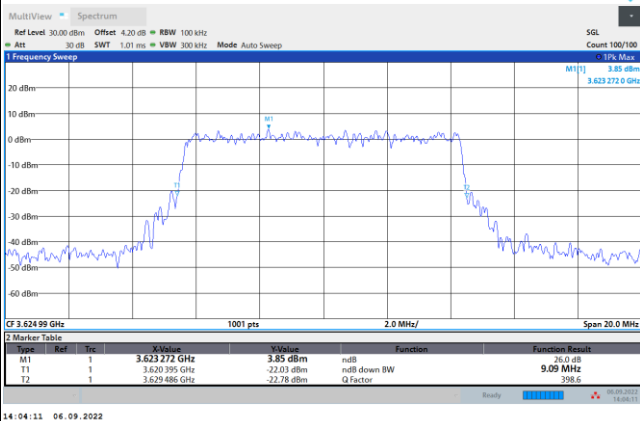



FR1 n48 / 20MHz / DFT-S OFDM / Middle Channel / Full RB

PI/2 BPSK

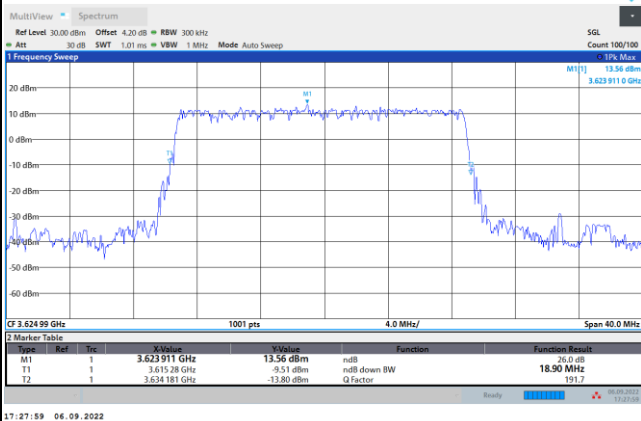

FR1 n48 / 20MHz / CP OFDM / Middle Channel / Full RB

QPSK

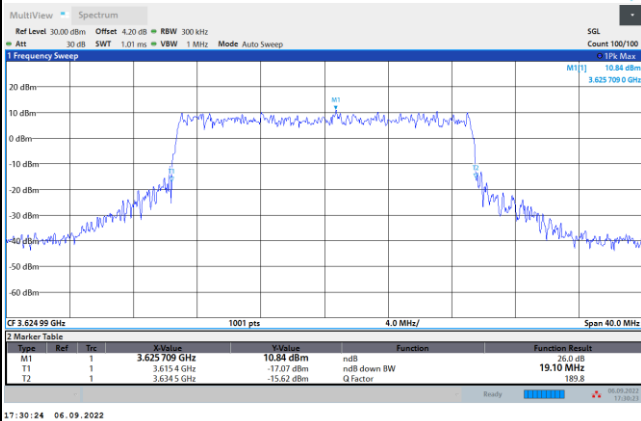

16QAM

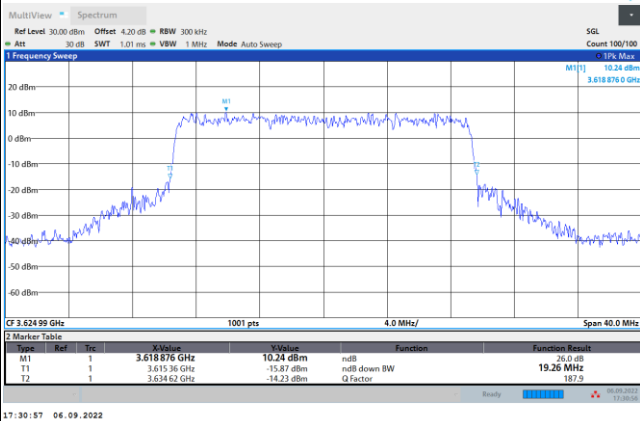

64QAM

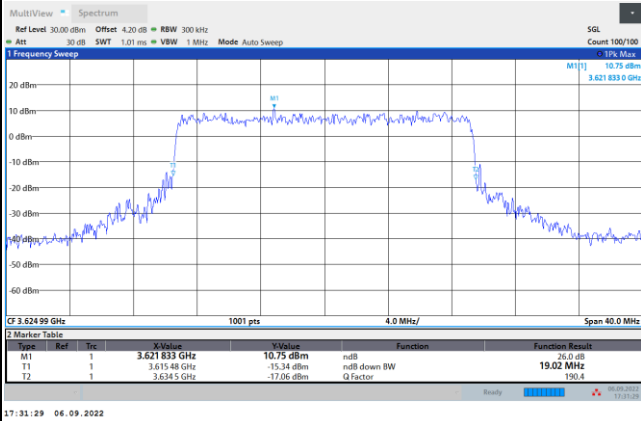

256QAM

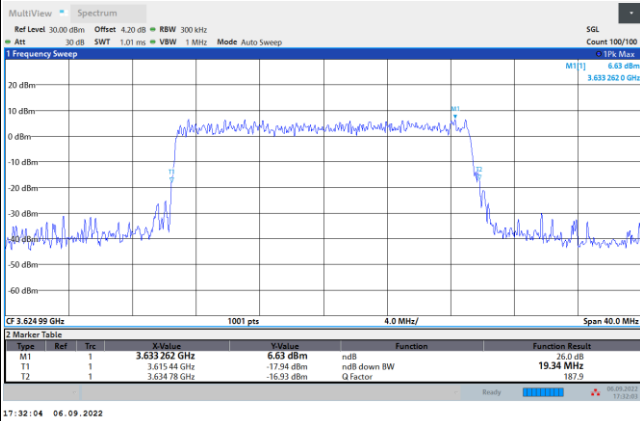



FR1 n48 / 30MHz / DFT-S OFDM / Middle Channel / Full RB

PI/2 BPSK

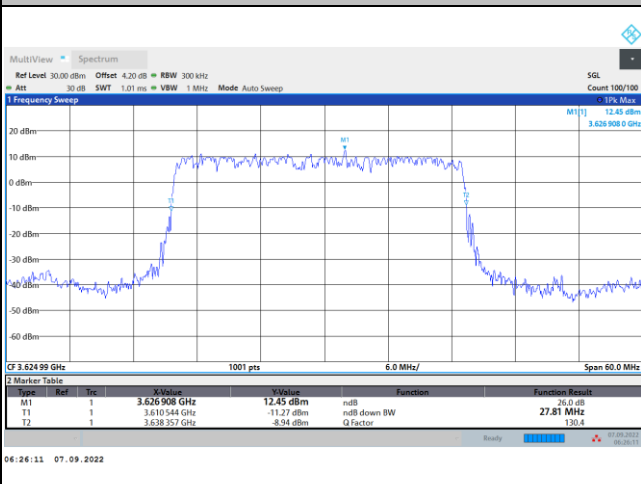

FR1 n48 / 30MHz / CP OFDM / Middle Channel / Full RB

QPSK

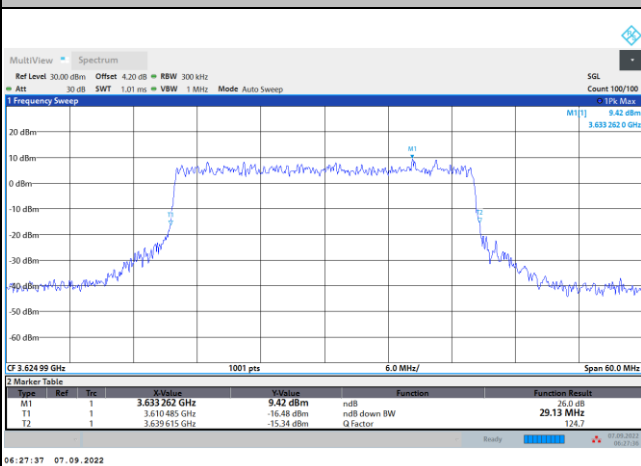

16QAM

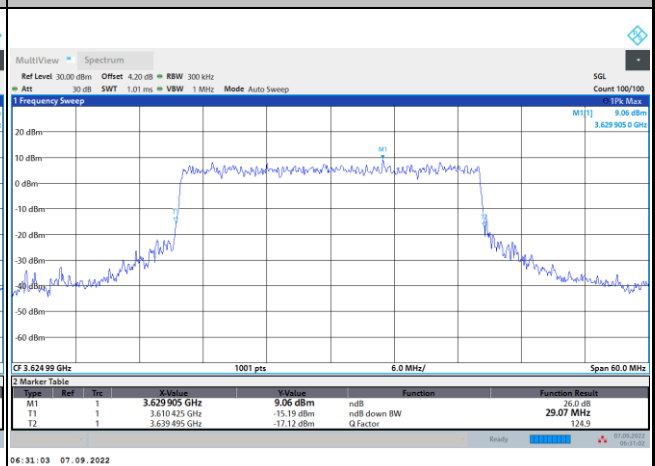

64QAM

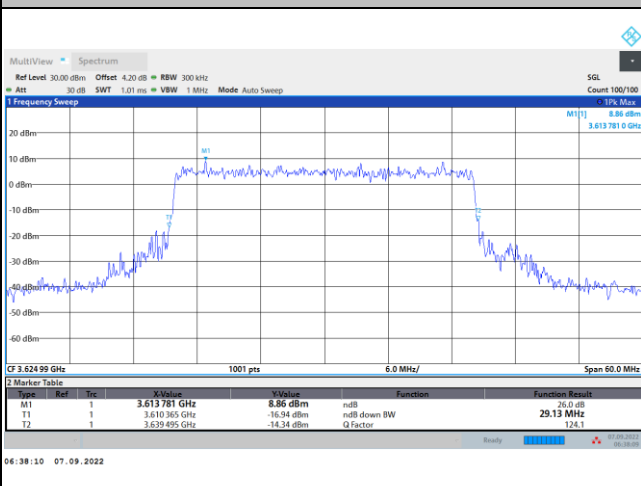

256QAM

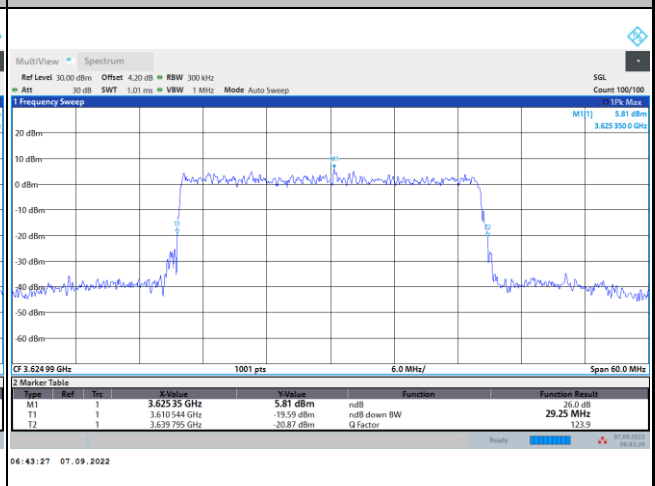



FR1 n48 / 40MHz / DFT-S OFDM / Middle Channel / Full RB

PI/2 BPSK

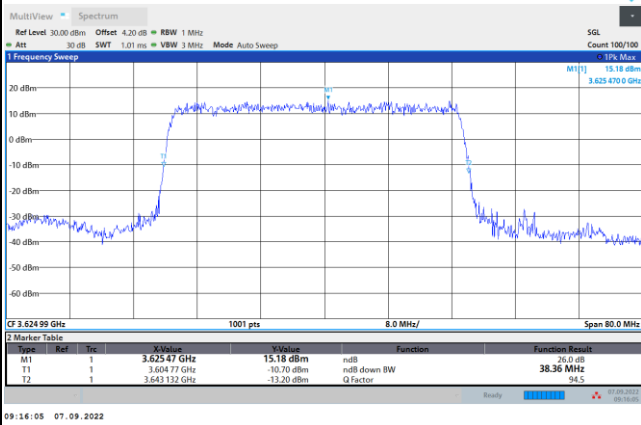

FR1 n48 / 40MHz / CP OFDM / Middle Channel / Full RB

QPSK

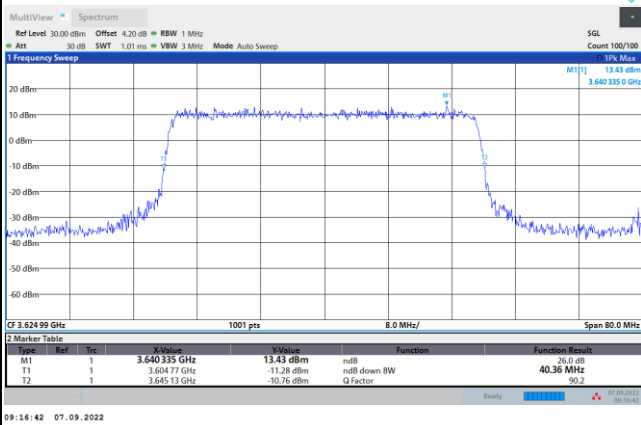

16QAM

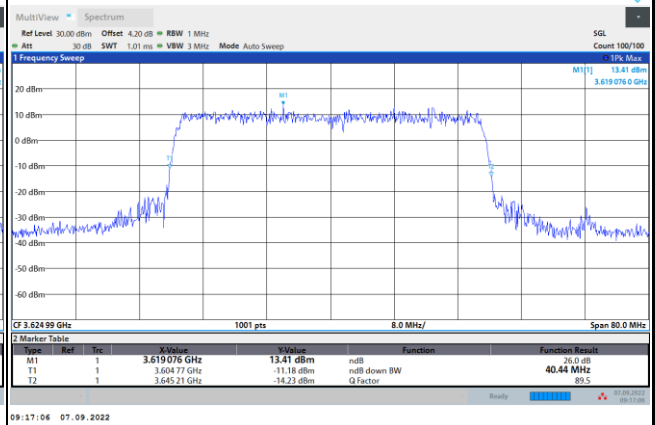

64QAM

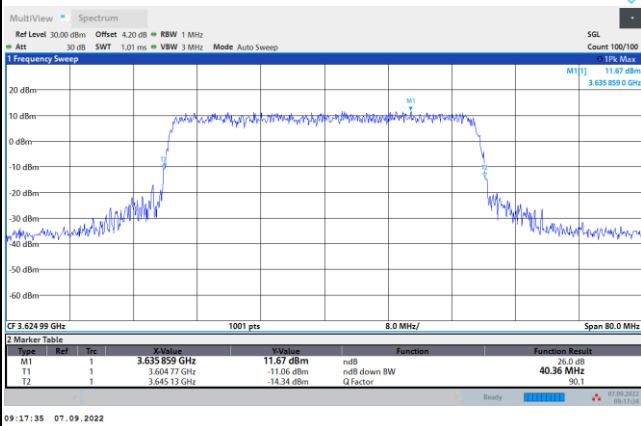

256QAM

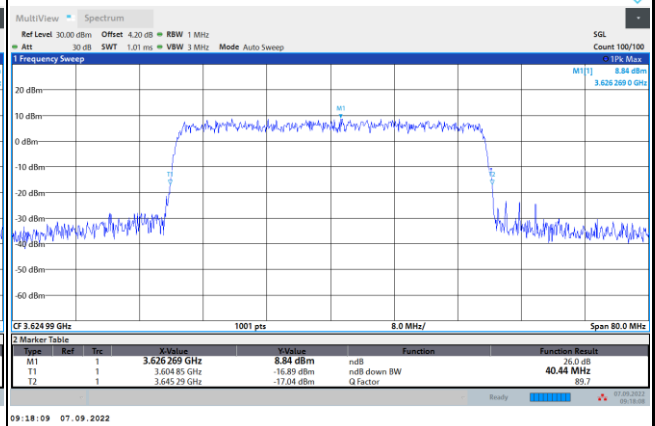



Occupied Bandwidth

Mode	FR1 n48 : OB BW(MHz) / DFT-S OFDM							
BW	10MHz	15MHz	20MHz	30MHz	40MHz	50MHz	60MHz	70MHz
Mod.	PI/2 BPSK	PI/2 BPSK	PI/2 BPSK	PI/2 BPSK	PI/2 BPSK	PI/2 BPSK	PI/2 BPSK	PI/2 BPSK
Middle CH	8.59	-	17.83	26.74	35.84	-	-	-
BW	80MHz	90MHz	100MHz					
Mod.	PI/2 BPSK	PI/2 BPSK	PI/2 BPSK					
Middle CH	-	-	-					

Mode	FR1 n48 : OB BW(MHz) / CP OFDM							
BW	10MHz		15MHz		20MHz		30MHz	
Mod.	QPSK	16QAM	QPSK	16QAM	QPSK	16QAM	QPSK	16QAM
Middle CH	8.57	8.60	-	-	18.23	18.23	27.85	27.82
Mod.	64QAM	256QAM	64QAM	256QAM	64QAM	256QAM	64QAM	256QAM
Middle CH	8.56	8.60	-	-	18.30	18.20	27.87	27.83
BW	40MHz		50MHz		60MHz		70MHz	
Mod.	QPSK	16QAM	QPSK	16QAM	QPSK	16QAM	QPSK	16QAM
Middle CH	38.00	37.99	-	-	-	-	-	-
Mod.	64QAM	256QAM	64QAM	256QAM	64QAM	256QAM	64QAM	256QAM
Middle CH	37.88	37.91	-	-	-	-	-	-
BW	80MHz		90MHz		100MHz			
Mod.	QPSK	16QAM	QPSK	16QAM	QPSK	16QAM		
Middle CH	-	-	-	-	-	-		
Mod.	64QAM	256QAM	64QAM	256QAM	64QAM	256QAM		
Middle CH	-	-	-	-	-	-		



FR1 n48 / 10MHz / DFT-S OFDM / Middle Channel / Full RB

PI/2 BPSK

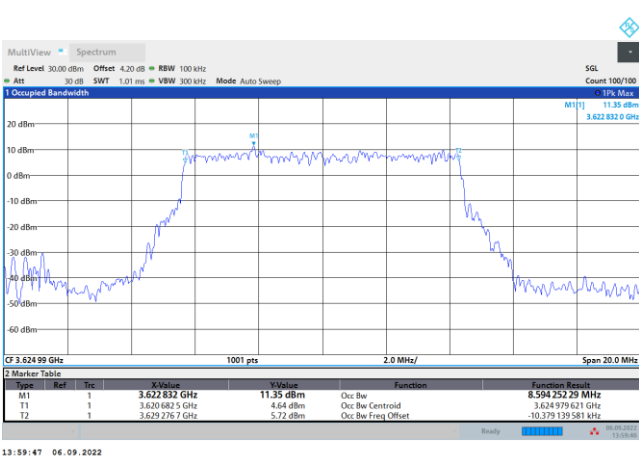

FR1 n48 / 10MHz / CP OFDM / Middle Channel / Full RB

QPSK

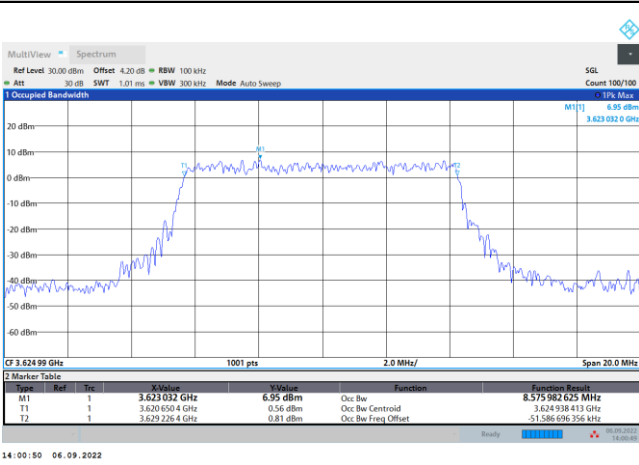

16QAM

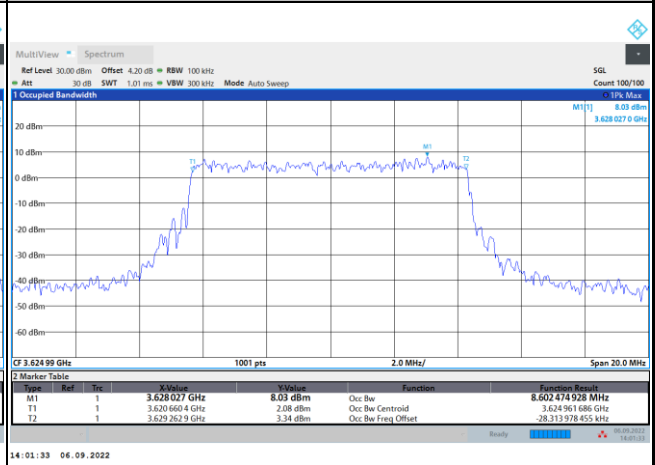

64QAM

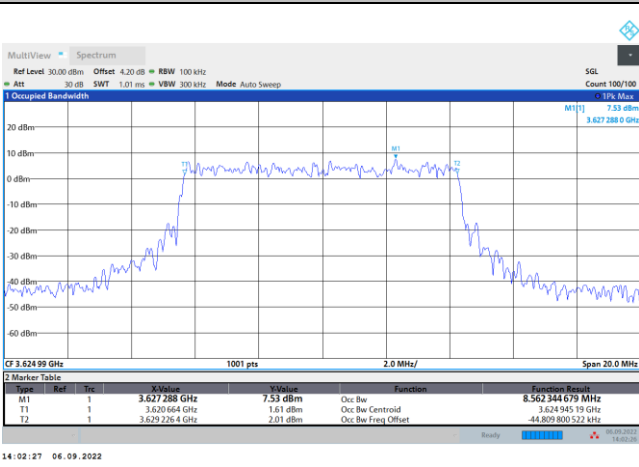

256QAM

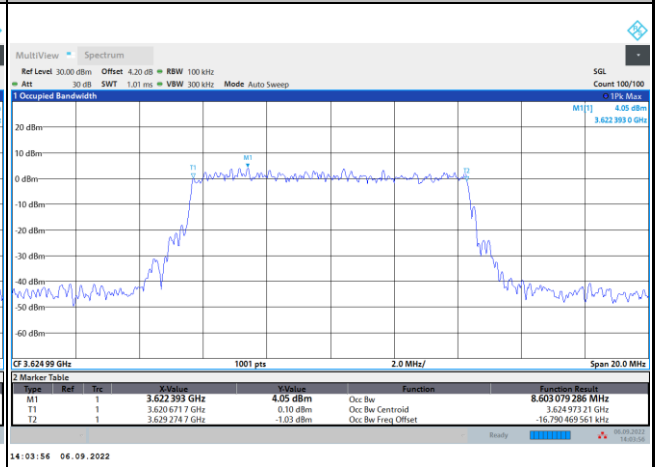



FR1 n48 / 20MHz / DFT-S OFDM / Middle Channel / Full RB

PI/2 BPSK

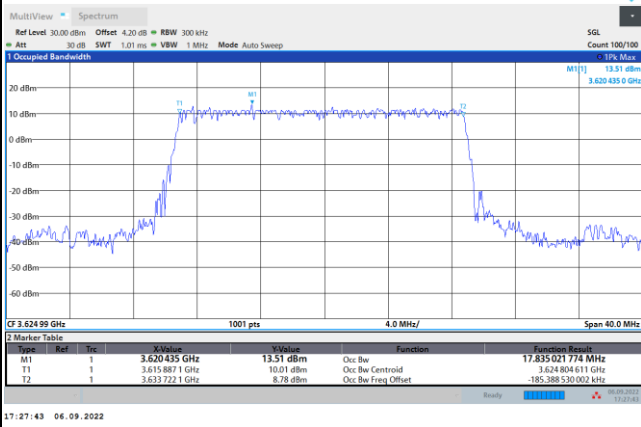

FR1 n48 / 20MHz / CP OFDM / Middle Channel / Full RB

QPSK

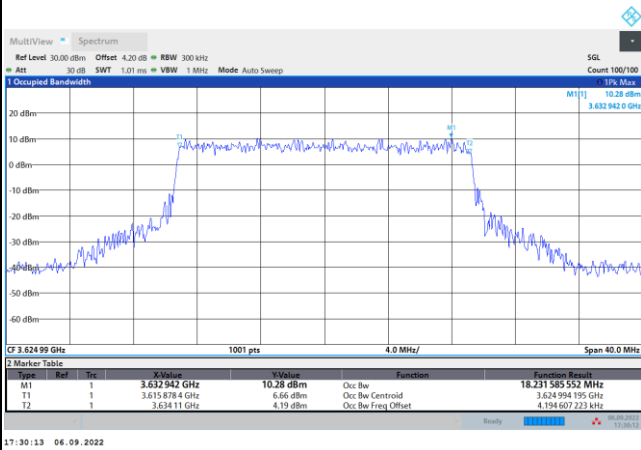

16QAM

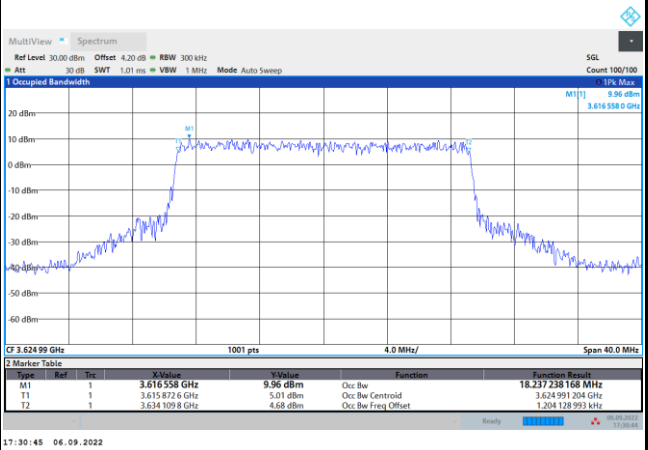

64QAM

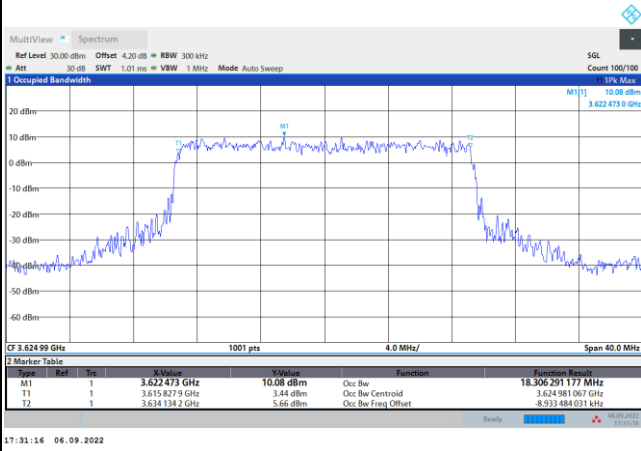

256QAM

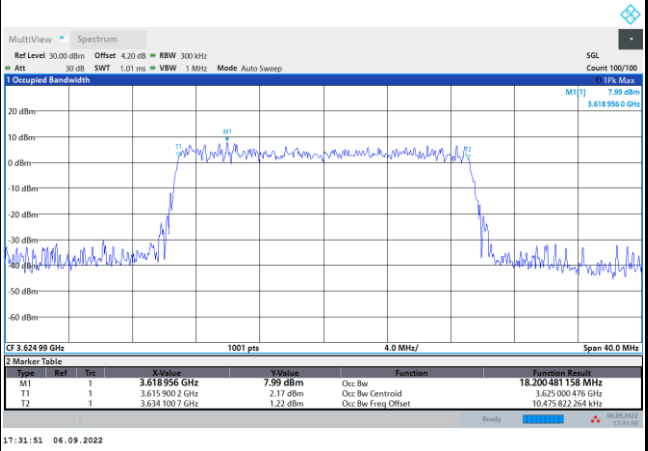



FR1 n48 / 30MHz / DFT-S OFDM / Middle Channel / Full RB

PI/2 BPSK

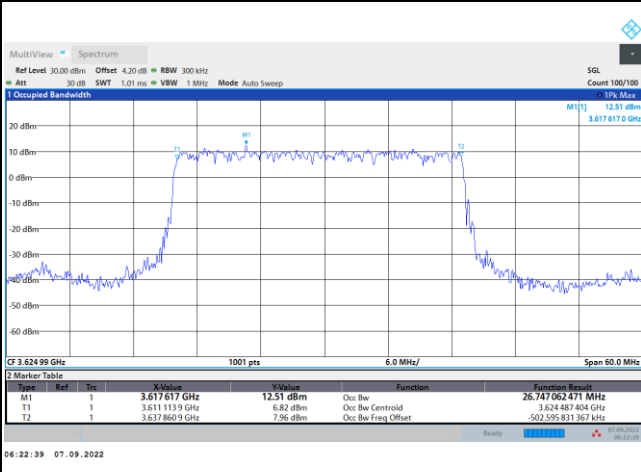

FR1 n48 / 30MHz / CP OFDM / Middle Channel / Full RB

QPSK

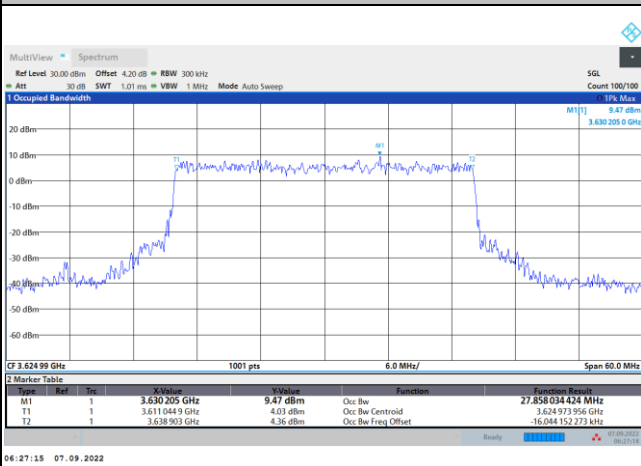

16QAM

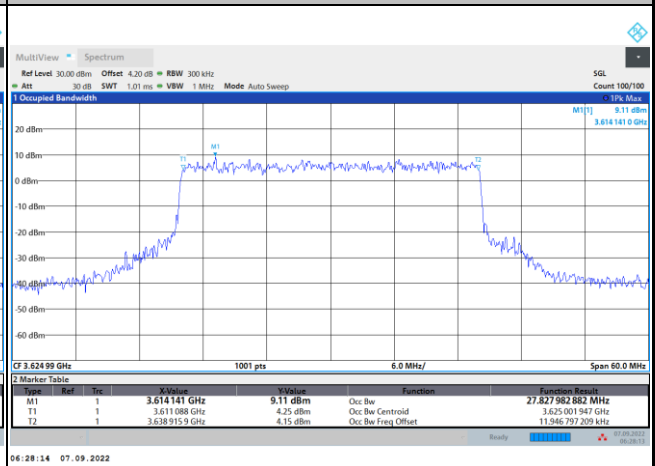

64QAM

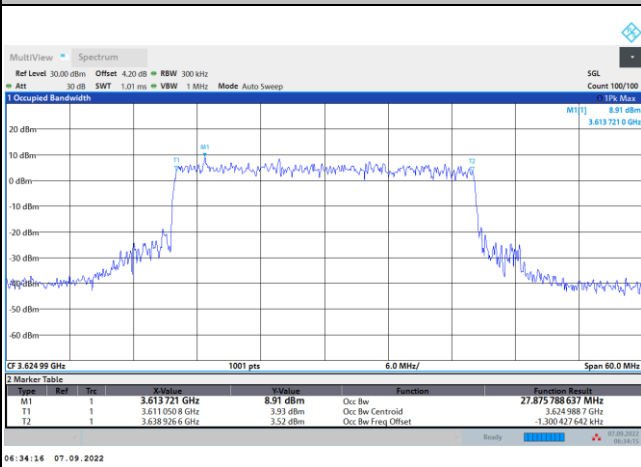

256QAM

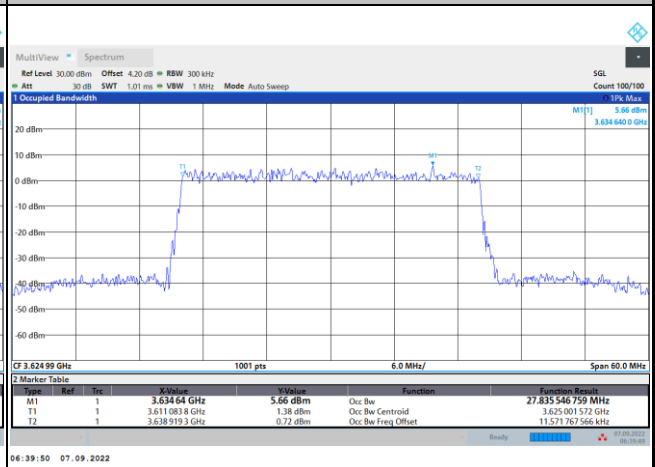



FR1 n48 / 40MHz / DFT-S OFDM / Middle Channel / Full RB

PI/2 BPSK

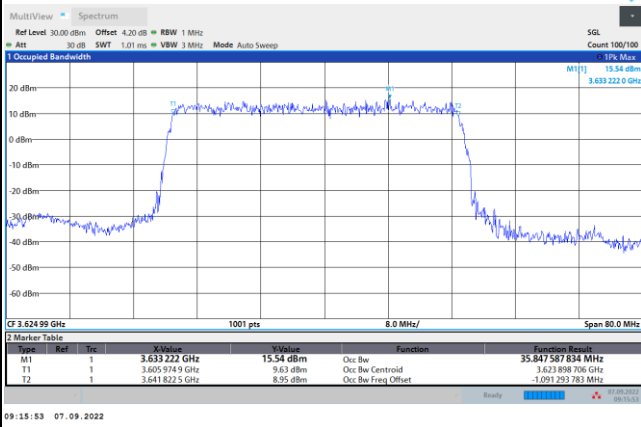

FR1 n48 / 40MHz / CP OFDM / Middle Channel / Full RB

QPSK

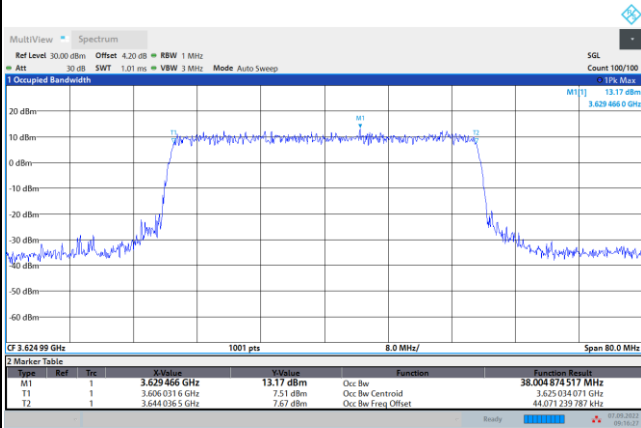

16QAM

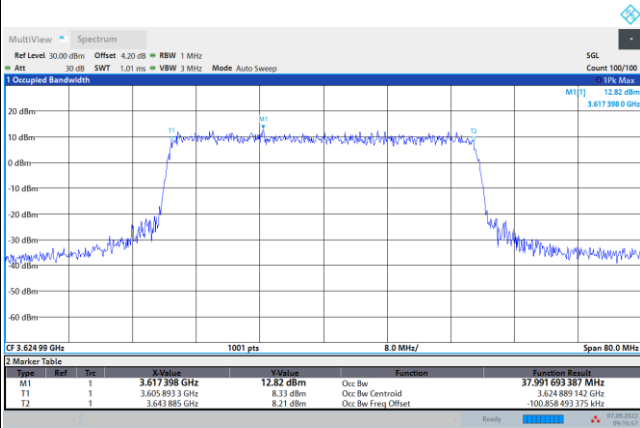

64QAM

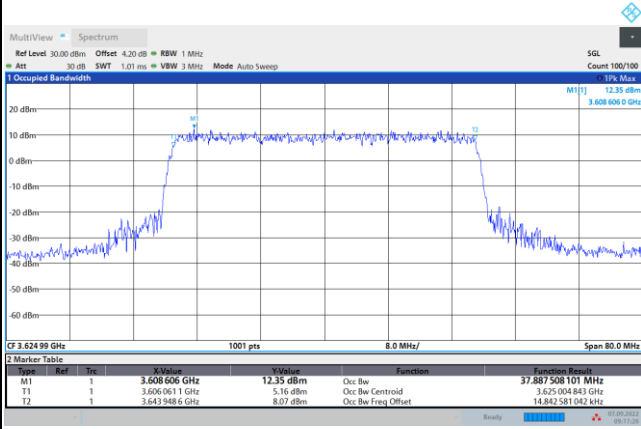

256QAM

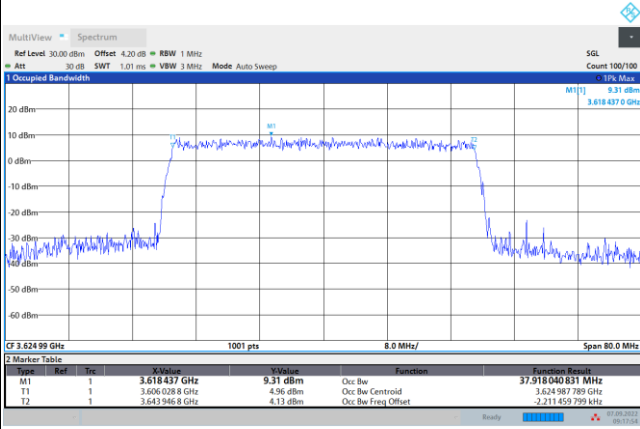



Unwanted Emission (MASK)

FR1 n48 / 10MHz / DFT-S OFDM / PI/2 BPSK

Lowest Channel

1RB0

1RBmax

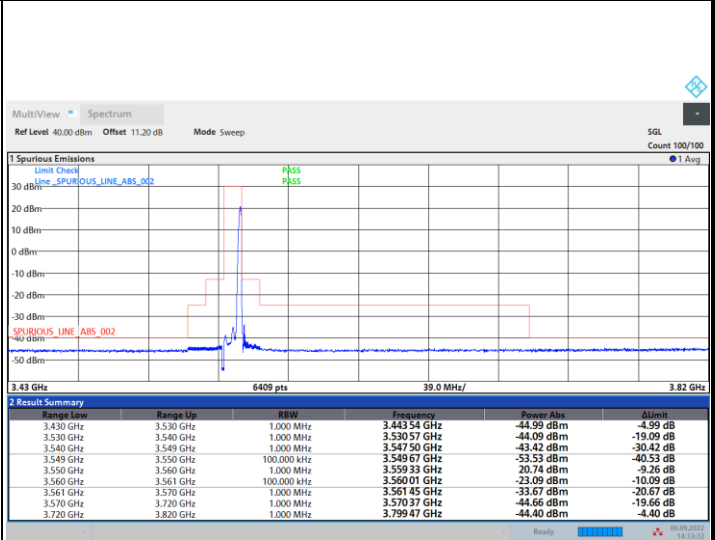
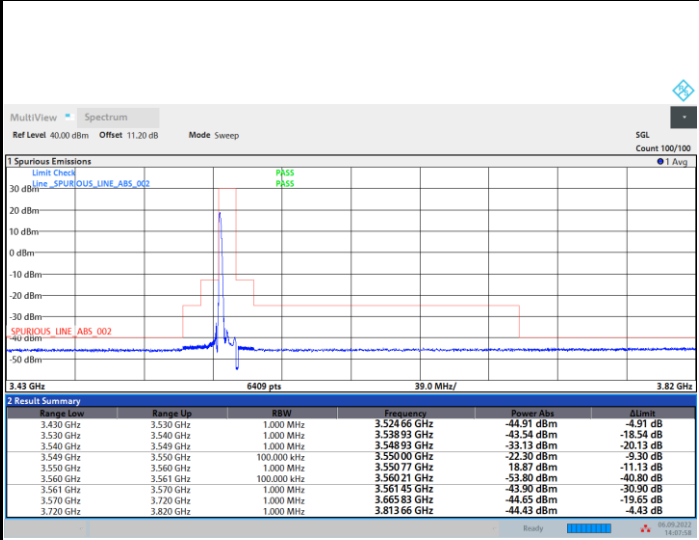

Full RB

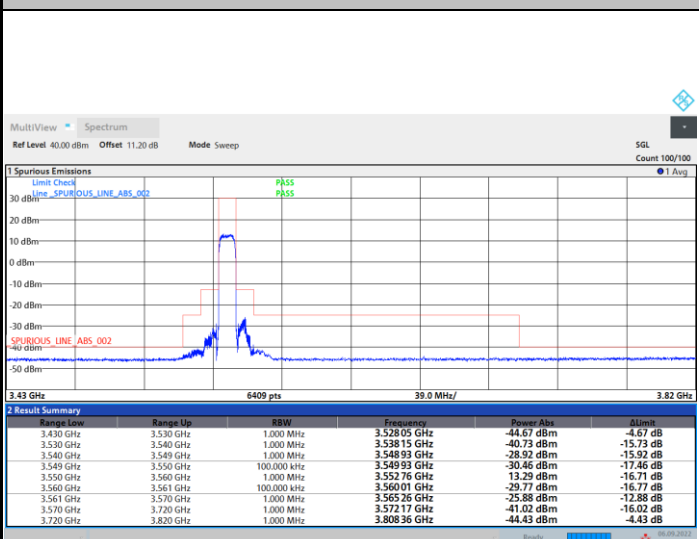



FR1 n48 / 10MHz / DFT-S OFDM / PI/2 BPSK

Middle Channel

1RB0

1RBmax

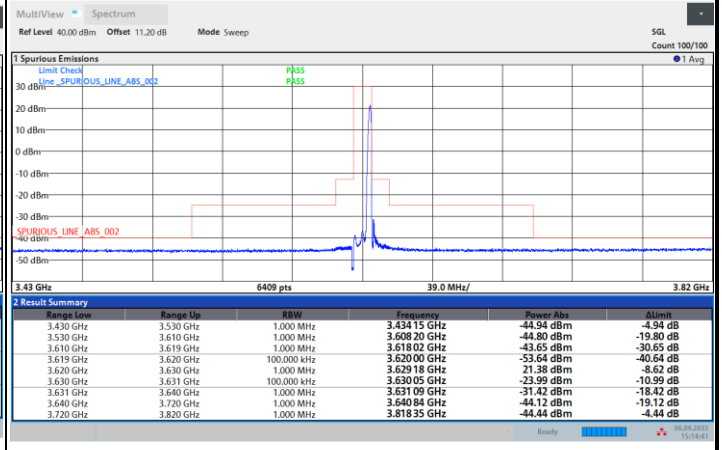
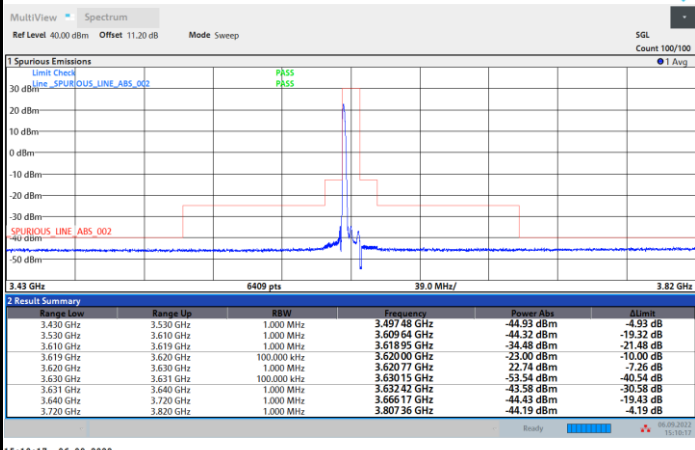

Full RB

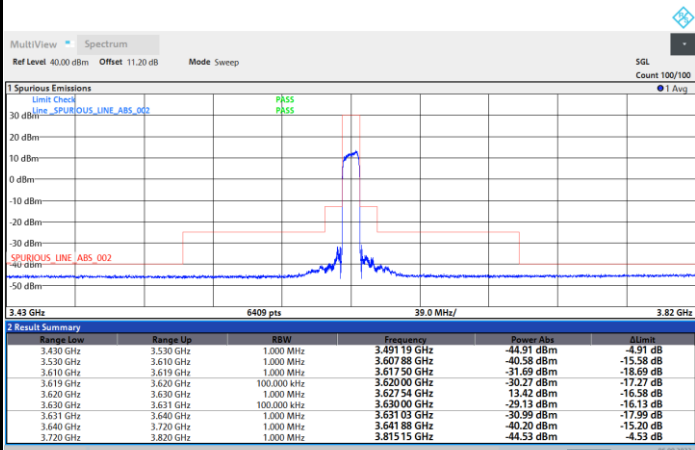



FR1 n48 / 10MHz / DFT-S OFDM / PI/2 BPSK

Highest Channel

1RB0

1RBmax

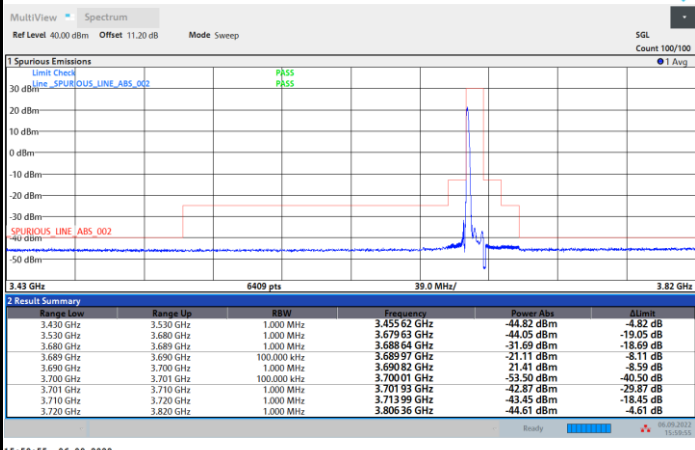

15:59:55 06.09.2022

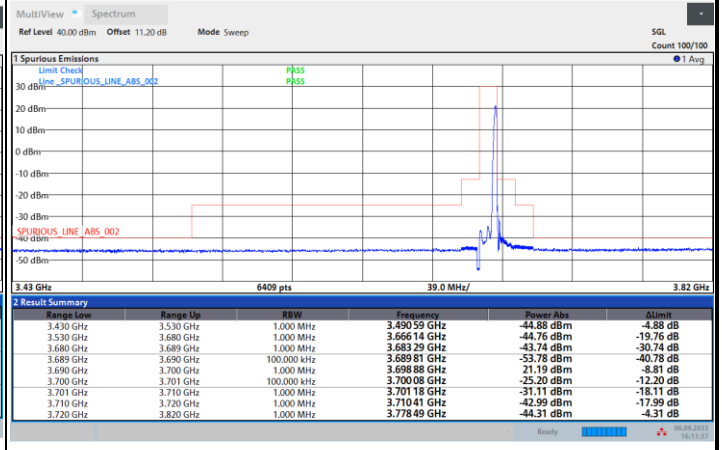

16:11:38 06.09.2022

Full RB

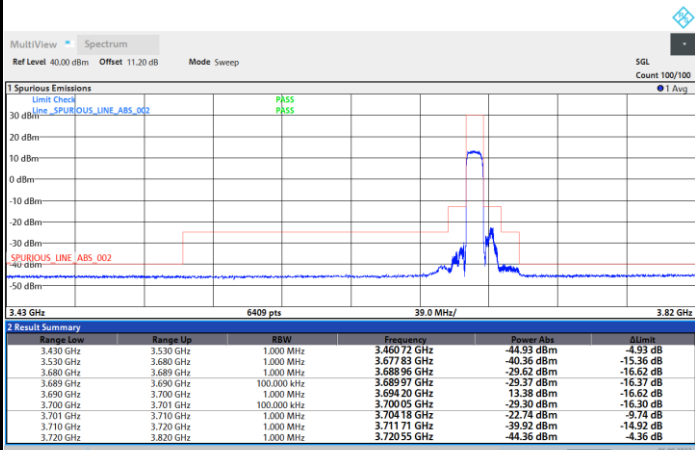

16:16:12 06.09.2022



FR1 n48 / 10MHz / DFT-S OFDM / QPSK

Lowest Channel

1RB0

1RBmax

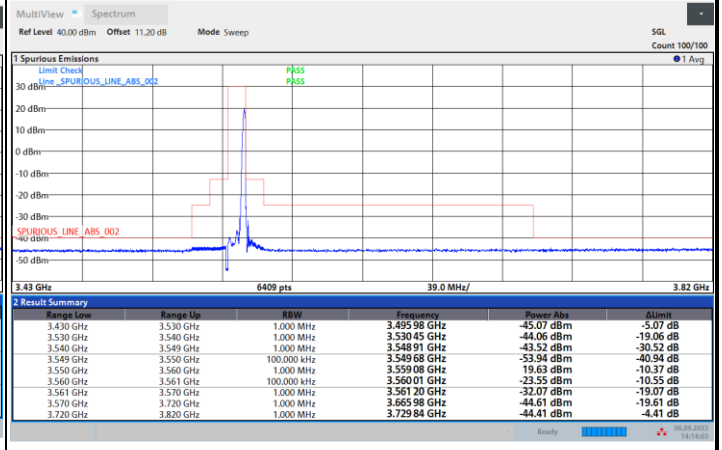
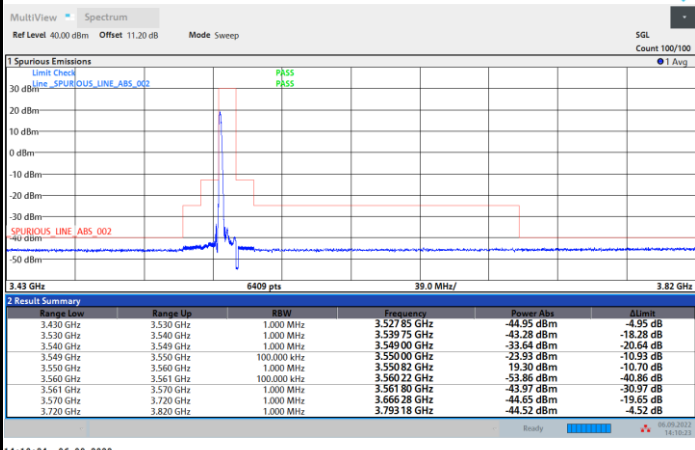

Full RB

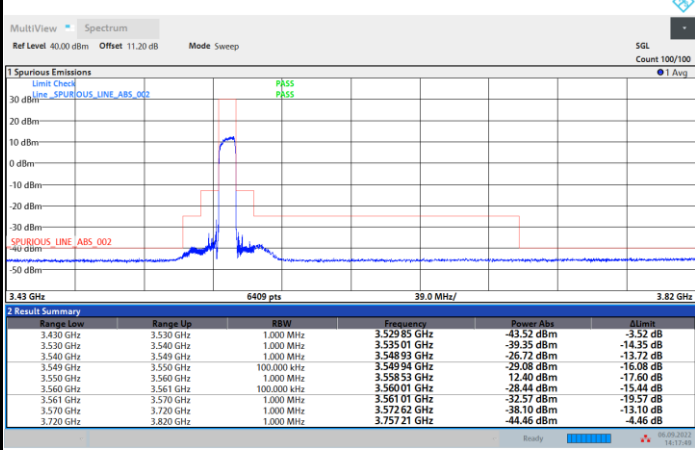



FR1 n48 / 10MHz / DFT-S OFDM / QPSK

Middle Channel

1RB0

1RBmax

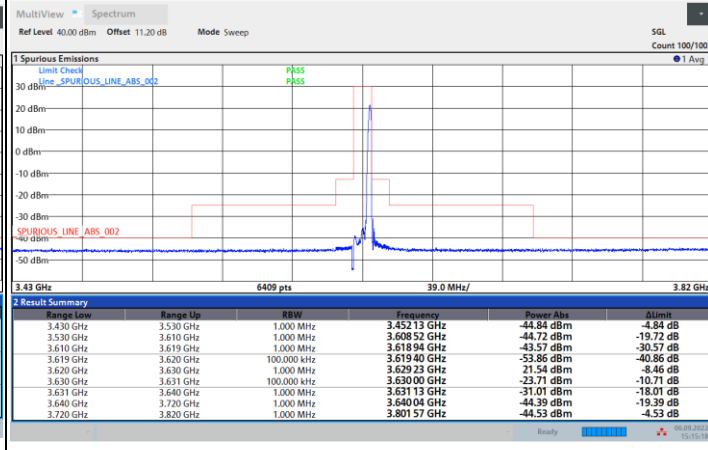
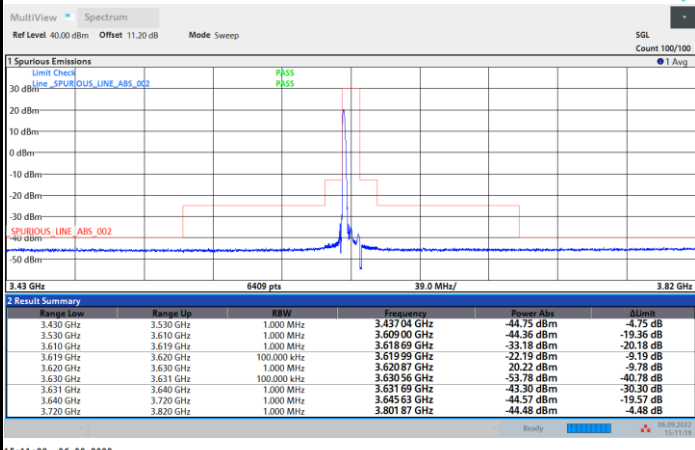

Full RB

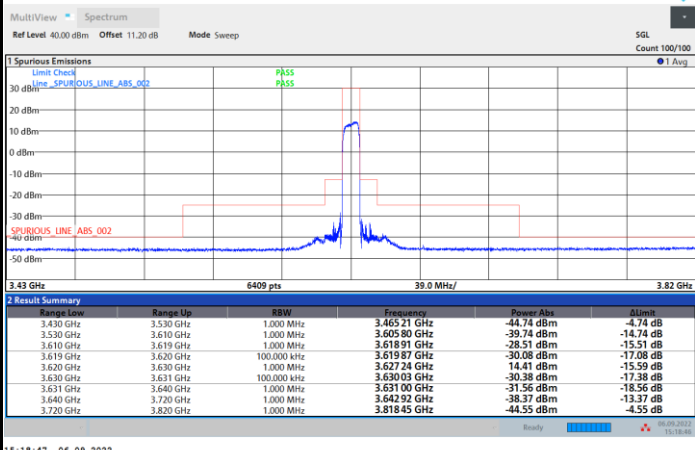



FR1 n48 / 10MHz / DFT-S OFDM / QPSK

Highest Channel

1RB0

1RBmax

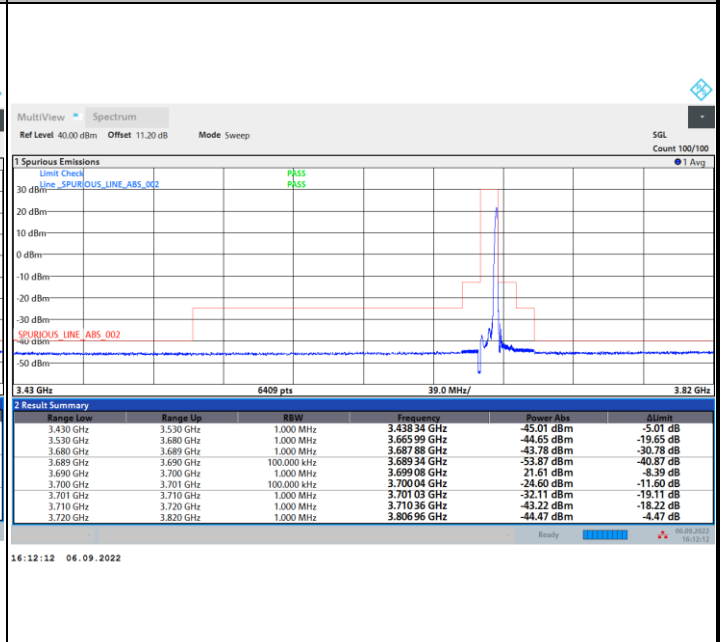
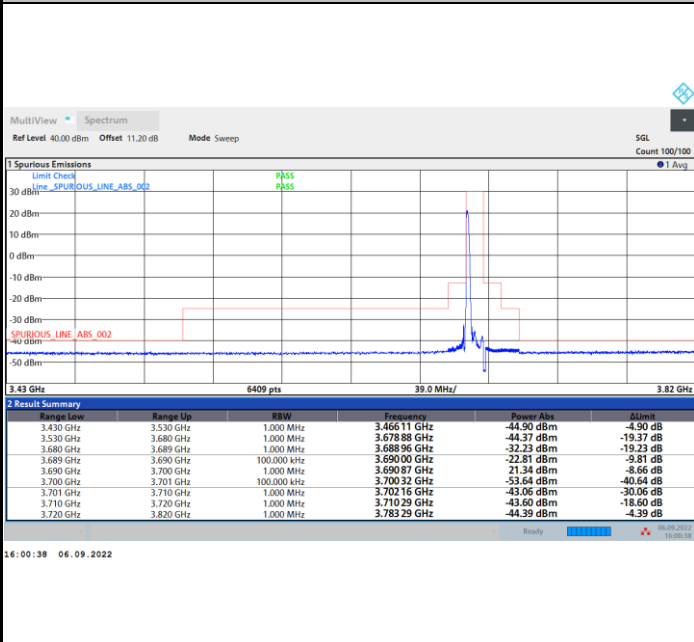

Full RB

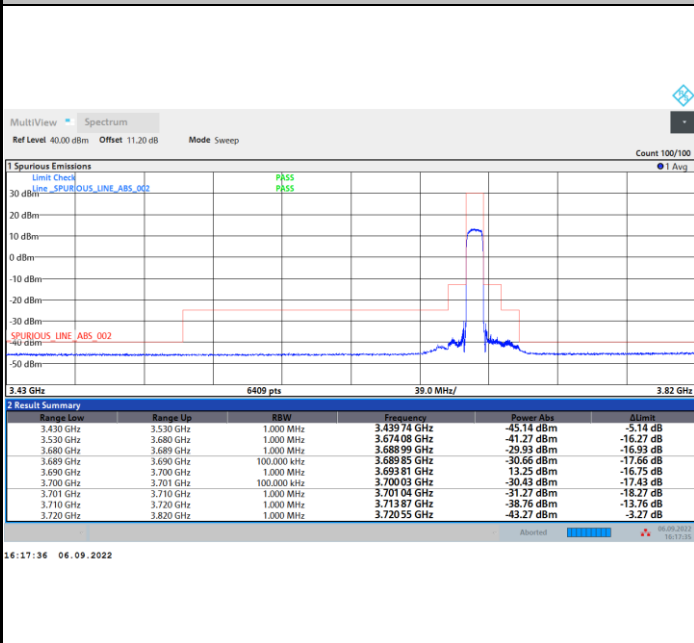



FR1 n48 / 10MHz / DFT-S OFDM / 16QAM

Lowest Channel

1RB0

1RBmax

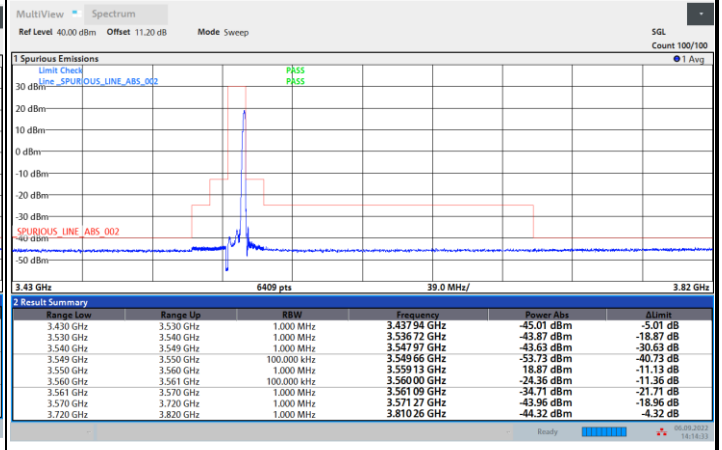
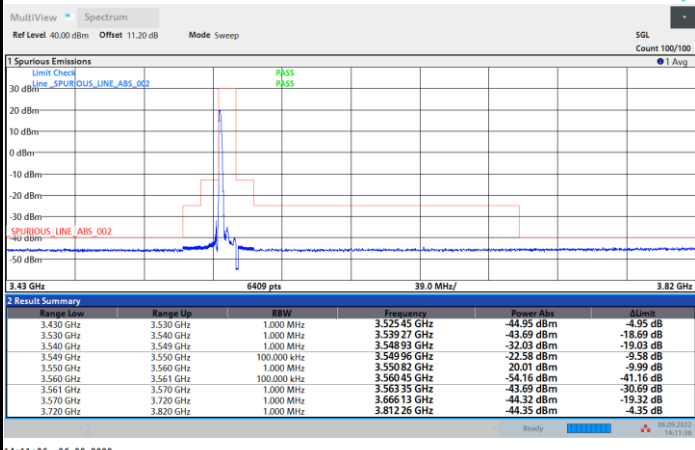

Full RB

