



FCC RADIO TEST REPORT

FCC ID : 2AQ68T99W368M
Equipment : 5G WWAN Module
Brand Name : Foxconn
Model Name : T99W368M
Applicant : Hon Lin Technology Co., Ltd
11F, No.32, Jihu Rd., Neihu Dist., Taipei City 114, Taiwan R.O.C.
Manufacturer : Hon Lin Technology Co., Ltd
11F, No.32, Jihu Rd., Neihu Dist., Taipei City 114, Taiwan R.O.C.
Standard : FCC 47 CFR Part 2, 22(H), 24(E), 27(L)

The product was received on Jul. 01, 2022 and testing was performed from Jul. 19, 2022 to Aug. 26, 2022. We, Sporton International Inc. Wensan Laboratory, would like to declare that the tested sample has been evaluated in accordance with the test procedures given in ANSI / TIA-603-E and has been in compliance with the applicable technical standards.

The test results in this report apply exclusively to the tested model / sample. Without written approval from Sporton International Inc. Wensan Laboratory, the test report shall not be reproduced except in full.

Louis Wu

Approved by: Louis Wu

Sporton International Inc. Wensan Laboratory

No.58, Aly. 75, Ln. 564, Wenhua 3rd, Rd., Guishan Dist., Taoyuan City 333010, Taiwan (R.O.C.)



Table of Contents

History of this test report.....3

Summary of Test Result.....4

1 General Description5

 1.1 Product Feature of Equipment Under Test5

 1.2 Modification of EUT5

 1.3 Testing Location6

 1.4 Applicable Standards7

2 Test Configuration of Equipment Under Test8

 2.1 Test Mode.....8

 2.2 Connection Diagram of Test System8

 2.3 Support Unit used in test configuration9

 2.4 Measurement Results Explanation Example9

 2.5 Frequency List of Low/Middle/High Channels.....9

3 Conducted Test Result10

 3.1 Measuring Instruments.....10

 3.2 Conducted Output Power and ERP/EIRP11

 3.3 Peak-to-Average Ratio12

 3.4 99% Occupied Bandwidth and 26dB Bandwidth Measurement.....13

 3.5 Conducted Band Edge14

 3.6 Conducted Spurious Emission15

 3.7 Frequency Stability.....16

4 Radiated Test Items17

 4.1 Measuring Instruments.....17

 4.2 Test Setup17

 4.3 Test Result of Radiated Test.....18

 4.4 Field Strength of Spurious Radiation Measurement19

5 List of Measuring Equipment.....20

6 Uncertainty of Evaluation22

Appendix A. Test Results of Conducted Test

Appendix B. Test Results of Radiated Test

Appendix C. Test Setup Photographs



Summary of Test Result

Report Clause	Ref Std. Clause	Test Items	Result (PASS/FAIL)	Remark
3.2	§2.1046	Conducted Output Power	Pass	-
	§22.913 (a)(5)	Effective Radiated Power (WCDMA Band V)		
	§24.232 (c)	Equivalent Isotropic Radiated Power (WCDMA Band II)		
	§27.50 (d)(4)	Equivalent Isotropic Radiated Power (WCDMA Band IV)		
3.3	§24.232 (d)	Peak-to-Average Ratio	Pass	
3.4	§2.1049 §22.917 (b) §24.238 (b) §27.53 (g)	Occupied Bandwidth (WCDMA Band V) (WCDMA Band II) (WCDMA Band IV)	Pass	-
3.5	§2.1051 §22.917 (a) §24.238 (a) §27.53 (g)	Band Edge Measurement (WCDMA Band V) (WCDMA Band II) (WCDMA Band IV)	Pass	-
3.6	§2.1051 §22.917 (a) §24.238 (a) §27.53 (g)	Conducted Emission (WCDMA Band V) (WCDMA Band II) (WCDMA Band IV)	Pass	-
3.7	§2.1055 §22.355 §24.235 §27.54	Frequency Stability Temperature & Voltage	Pass	-
4.4	§2.1053 §22.917 (a) §24.238 (a) §27.53 (h)	Field Strength of Spurious Radiation (WCDMA Band V) (WCDMA Band II) (WCDMA Band IV)	Pass	33.52 dB under the limit at 7630.000 MHz

Declaration of Conformity:

- The test results (PASS/FAIL) with all measurement uncertainty excluded are presented in accordance with the regulation limits or requirements declared by manufacturers. It's means measurement values may risk exceeding the limit of regulation standards, if measurement uncertainty is include in test results.
- The measurement uncertainty please refer to report "Uncertainty of Evaluation".

Comments and Explanations:

The product specifications of the EUT presented in the report are declared by the manufacturer who shall take full responsibility for the authenticity.

Reviewed by: Keven Cheng

Report Producer: Michelle Chen



1 General Description

1.1 Product Feature of Equipment Under Test

WCDMA/LTE/5G NR and GNSS

The following antennas were provided to the EUT

	Band	Brand	Model	Antenna Type	RF Exposure Max Antenna Gain(dBi)
WCDMA	2	WHA YU	C107-511722-A	PCB	5.9
	4	WHA YU	C107-511722-A	PCB	5.5
	5	WHA YU	C107-511721-A	PCB	3.5

Remark: The above EUT's information was declared by manufacturer and used for Radiated Spurious Emission test.

There are three different HW of T99W368M.

Brand	Model	HW
Foxconn	T99W368M	1. WCDMA+LTE+Sub6+mmWave+eSIM
		2. WCDMA+LTE+Sub6+mmWave w/o eSIM
		3. WCDMA+LTE+Sub6+mmWave +FPC connector on bottom w/o eSIM

Note: All the tests were performed with Sample 1.

1.2 Modification of EUT

No modifications made to the EUT during the testing.



1.3 Testing Location

Test Site	Sporton International Inc. EMC & Wireless Communications Laboratory
Test Site Location	No.52, Huaya 1st Rd., Guishan Dist., Taoyuan City 333, Taiwan (R.O.C.) TEL: +886-3-327-3456 FAX: +886-3-328-4978
Test Site No.	Sporton Site No. TH03-HY (TAF Code: 1190)
Test Engineer	Cotty Hsu
Temperature (°C)	23.6~24
Relative Humidity (%)	48~49.6
Remark	The Conducted test item subcontracted to Sporton International Inc. EMC & Wireless Communications Laboratory

Test Site	Sporton International Inc. Wensan Laboratory
Test Site Location	No.58, Aly. 75, Ln. 564, Wenhua 3rd, Rd., Guishan Dist., Taoyuan City 333010, Taiwan (R.O.C.) TEL: +886-3-327-0868 FAX: +886-3-327-0855
Test Site No.	Sporton Site No. 03CH11-HY
Test Engineer	Yuan Lee and Troye Hsieh
Temperature (°C)	20.1~21.5
Relative Humidity (%)	55.8~68.3

Note: The test site complies with ANSI C63.4 2014 requirement.

FCC Designation No.: TW1190 and TW3786



1.4 Applicable Standards

According to the specifications declared by the manufacturer, the EUT must comply with the requirements of the following standards:

- ♦ ANSI C63.26-2015
- ♦ ANSI / TIA-603-E
- ♦ FCC 47 CFR Part 2, 22(H), 24(E), 27(L)
- ♦ FCC KDB 971168 D01 Power Meas. License Digital Systems v03r01
- ♦ FCC KDB 412172 D01 Determining ERP and EIRP v01r01
- ♦ FCC KDB 414788 D01 Radiated Test Site v01r01

Remark:

1. All the test items were validated and recorded in accordance with the standards without any modification during the testing.
2. The TAF code is not including all the FCC KDB listed without accreditation.

2 Test Configuration of Equipment Under Test

2.1 Test Mode

Antenna port conducted and radiated test items were performed according to KDB 971168 D01 Power Meas. License Digital Systems v03r01 with maximum output power.

For radiated measurement, the measured emission level of the EUT was maximized by rotating the EUT on a turntable, adjusting the orientation of the EUT and EUT antenna in three orthogonal axis (X: flat, Y: portrait, Z: landscape), and adjusting the measurement antenna orientation, following C63.26 exploratory test procedures and only the worst case emissions were reported in this report..

Radiated emissions were investigated as following frequency range:

1. 30 MHz to 9000 MHz for WCDMA Band V
2. 30 MHz to 18000 MHz for WCDMA Band IV
3. 30 MHz to 19100 MHz for WCDMA Band II

All modes, data rates and positions were investigated.

Test modes are chosen to be reported as the worst case configuration below:

Test Modes		
Band	Radiated TCs	Conducted TCs
WCDMA Band V	■ RMC 12.2Kbps Link	■ RMC 12.2Kbps Link
WCDMA Band II	■ RMC 12.2Kbps Link	■ RMC 12.2Kbps Link
WCDMA Band IV	■ RMC 12.2Kbps Link	■ RMC 12.2Kbps Link

2.2 Connection Diagram of Test System

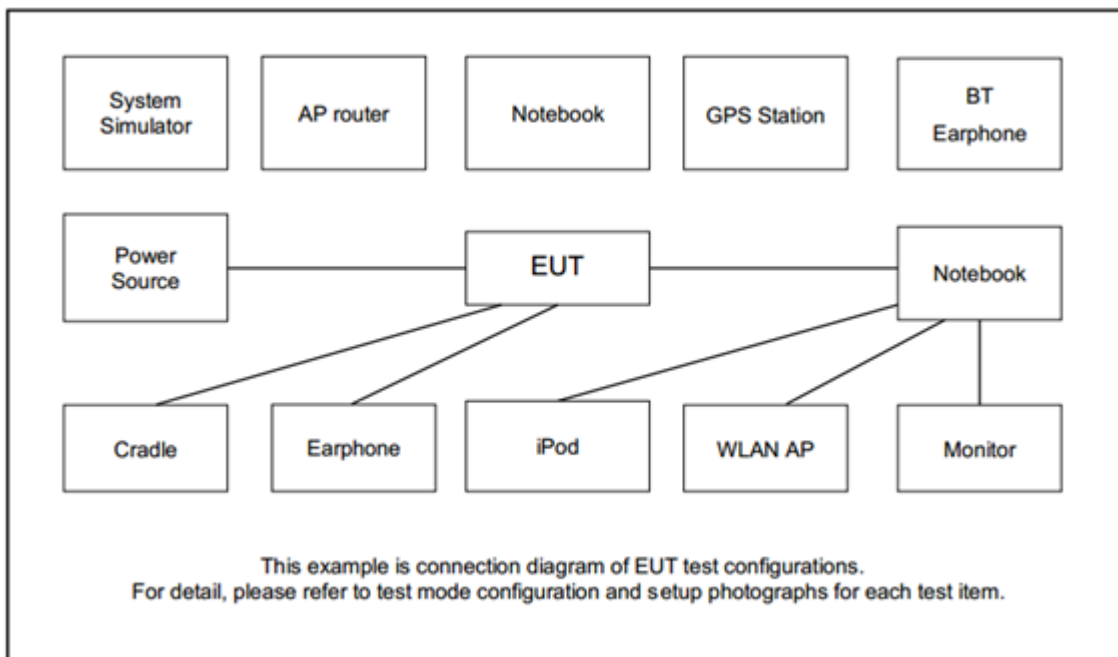



2.3 Support Unit used in test configuration

Item	Equipment	Brand Name	Model No.	FCC ID	Data Cable	Power Cord
1.	System Simulator	Anritsu	MT8820C	N/A	N/A	Unshielded, 1.8 m
2.	Fixture	Foxconn	95.2580T00	N/A	N/A	N/A

2.4 Measurement Results Explanation Example

For all conducted test items:

The offset level is set in the spectrum analyzer to compensate the RF cable loss and attenuator factor between RF conducted output port and spectrum analyzer. With the offset compensation, the spectrum analyzer reading level will be exactly the RF output level.

The spectrum analyzer offset is derived from RF cable loss and attenuator factor.

Offset = RF cable loss + attenuator factor.

The following shows an offset computation example with RF cable loss 4.2 dB and a 10 dB attenuator.

Example:

$$\begin{aligned}
 \text{Offset(dB)} &= \text{RF cable loss(dB)} + \text{attenuator factor(dB)} \\
 &= 4.2 + 10 = 14.2 \text{ (dB)}
 \end{aligned}$$

2.5 Frequency List of Low/Middle/High Channels

Frequency List				
Band	Channel/Frequency(MHz)	Lowest	Middle	Highest
WCDMA Band V	Channel	4132	4182	4233
	Frequency	826.4	836.4	846.6
WCDMA Band II	Channel	9262	9400	9538
	Frequency	1852.4	1880.0	1907.6
WCDMA Band IV	Channel	1312	1413	1513
	Frequency	1712.4	1732.6	1752.6

3 Conducted Test Result

3.1 Measuring Instruments

Please refer to the measuring equipment list in this test report.

3.1.1 Test Setup

3.1.2 Conducted Output Power

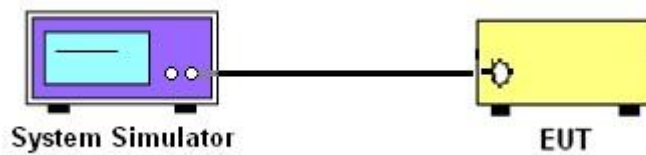

3.1.3 Peak-to-Average Ratio, Occupied Bandwidth, Conducted Band-Edge and Conducted Spurious Emission

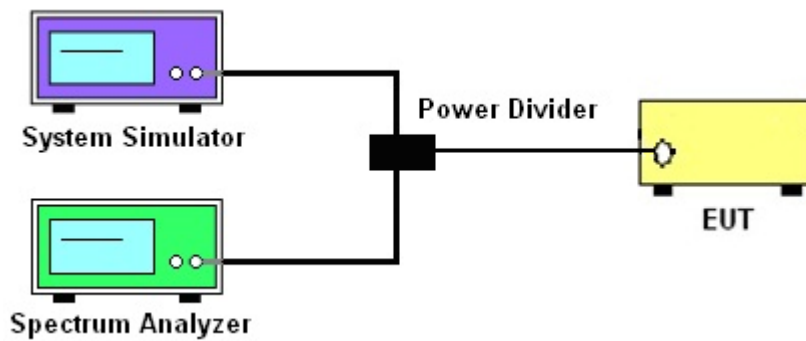

3.1.4 Frequency Stability

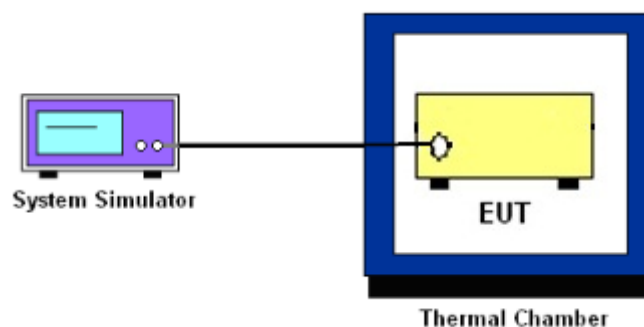

3.1.5 Test Result of Conducted Test

Please refer to Appendix A.



3.2 Conducted Output Power and ERP/EIRP

3.2.1 Description of the Conducted Output Power and ERP/EIRP

A system simulator was used to establish communication with the EUT. Its parameters were set to enforce EUT transmitting at the maximum power. The measured power in the radio frequency on the transmitter output terminals shall be reported.

The ERP of mobile transmitters must not exceed 7 Watts for WCDMA Band V

The EIRP of mobile transmitters must not exceed 2 Watts for WCDMA Band II

The EIRP of mobile transmitters must not exceed 1 Watts for WCDMA Band IV

According to KDB 412172 D01 Power Approach,

$EIRP = P_T + G_T - L_C$, $ERP = EIRP - 2.15$, where

P_T = transmitter output power in dBm

G_T = gain of the transmitting antenna in dBi

L_C = signal attenuation in the connecting cable between the transmitter and antenna in dB

3.2.2 Test Procedures

1. The transmitter output port is connected to the system simulator.
2. Set EUT at maximum power through system simulator.
3. Select the lowest, middle, and the highest channels for each band and different modulation.
4. Measure the maximum burst average power for GSM and maximum average power for other modulation signal.



3.3 Peak-to-Average Ratio

3.3.1 Description of the PAR Measurement

The peak-to-average ratio (PAR) of the transmission may not exceed 13 dB.

3.3.2 Test Procedures

The testing follows ANSI C63.26-2015 Section 5.2.6

1. The EUT is connected to spectrum analyzer and system simulator via a power divider.
2. Set EUT to transmit at maximum output power.
3. When the duty cycle is less than 98%, then signal gating will be implemented on the spectrum analyzer by triggering from the system simulator.
4. Set the CCDF (Complementary Cumulative Distribution Function) option of the spectrum analyzer.
5. Record the maximum PAPR level associated with a probability of 0.1%.



3.4 99% Occupied Bandwidth and 26dB Bandwidth Measurement

3.4.1 Description of 99% Occupied Bandwidth and 26dB Bandwidth Measurement

The occupied bandwidth is the width of a frequency band such that, below the lower and above the upper frequency limits, the mean powers emitted are each equal to a specified percentage 0.5% of the total mean transmitted power.

The 26 dB emission bandwidth is defined as the frequency range between two points, one above and one below the carrier frequency, at which the spectral density of the emission is attenuated 26 dB below the maximum in-band spectral density of the modulated signal. Spectral density (power per unit bandwidth) is to be measured with a detector of resolution bandwidth equal to approximately 1.0% of the emission bandwidth.

3.4.2 Test Procedures

The testing follows ANSI C63.26-2015 Section 5.4.3 (26dB) and Section 5.4.4 (99OB)

1. The EUT is connected to spectrum analyzer and system simulator via a power divider.
2. The spectrum analyzer center frequency is set to the nominal EUT channel center frequency. The span range for the spectrum analyzer shall be between two and five times the anticipated OBW.
3. The nominal resolution bandwidth (RBW) shall be in the range of 1 to 5 % of the anticipated OBW, and the VBW shall be at least 3 times the RBW.
4. Set the detection mode to peak, and the trace mode to max hold.
5. Determine the reference value: Set the EUT to transmit a modulated signal. Allow the trace to stabilize. Set the spectrum analyzer marker to the highest level of the displayed trace.
(This is the reference value)
6. Determine the “-26 dB down amplitude” as equal to (Reference Value – X).
7. Place two markers, one at the lowest and the other at the highest frequency of the envelope of the spectral display such that each marker is at or slightly below the “-X dB down amplitude” determined in step 6. If a marker is below this “-X dB down amplitude” value it shall be placed as close as possible to this value. The OBW is the positive frequency difference between the two markers.
8. Use the 99 % power bandwidth function of the spectrum analyzer and report the measured bandwidth.



3.5 Conducted Band Edge

3.5.1 Description of Conducted Band Edge Measurement

The power of any emission outside of the authorized operating frequency ranges must be lower than the transmitter power (P) by a factor of at least $43 + 10 \log (P)$ dB.

3.5.2 Test Procedures

The testing follows FCC KDB 971168 D01 v03r01 Section 6.1.

1. The EUT is connected to the spectrum analyzer and system simulator via a power divider.
2. The RF output of EUT is connected to the spectrum analyzer by an RF cable and attenuator. The path loss is compensated to the results for each measurement.
3. The band edges of low and high channels for the highest RF powers are measured.
4. The RF fundamental frequency shall be excluded against the limit line in the operating frequency band.
5. The limit line is derived from $43 + 10\log(P)$ dB below the transmitter power P(Watts)



3.6 Conducted Spurious Emission

3.6.1 Description of Conducted Spurious Emission Measurement

The power of any emission outside of the authorized operating frequency ranges must be lower than the transmitter power (P) by a factor of at least $43 + 10 \log (P)$ dB.

It is measured by means of a calibrated spectrum analyzer and scanned from 30 MHz up to a frequency including its 10th harmonic.

3.6.2 Test Procedures

The testing follows FCC KDB 971168 D01 v03r01 Section 6.1.

1. The EUT is connected to the spectrum analyzer and system simulator via a power divider.
2. The RF output of EUT is connected to the spectrum analyzer by an RF cable and attenuator. The path loss is compensated to the results for each measurement.
3. The middle channel for the highest RF power within the transmitting frequency is measured.
4. The conducted spurious emission for the whole frequency range is taken.
5. The RF fundamental frequency shall be excluded against the limit line in the operating frequency band.
6. The limit line is derived from $43 + 10\log(P)$ dB below the transmitter power P(Watts)



3.7 Frequency Stability

3.7.1 Description of Frequency Stability Measurement

22.355

The frequency stability shall be measured by variation of ambient temperature and variation of primary supply voltage to ensure that the fundamental emission stays within the authorized frequency block. The frequency stability of the transmitter shall be maintained within $\pm 0.00025\%$ ($\pm 2.5\text{ppm}$) of the center frequency.

24.235 & 27.54

The frequency stability shall be sufficient to ensure that the fundamental emission stays within the authorized frequency block.

3.7.2 Test Procedures for Temperature Variation

The testing follows FCC KDB 971168 D01 v03r01 Section 9.0.

1. The EUT is set up in the thermal chamber and connected with the system simulator.
2. With power OFF, the temperature is decreased to -30°C and the EUT is stabilized before testing. Power is applied and the maximum change in frequency is recorded within one minute.
3. With power OFF, the temperature is raised in 10°C steps up to 50°C . The EUT is stabilized at each step for at least half an hour. Power is applied and the maximum frequency change is recorded within one minute.

3.7.3 Test Procedures for Voltage Variation

The testing follows FCC KDB 971168 D01 v03r01 Section 9.0.

1. The EUT is placed in a temperature chamber at $20\pm 5^{\circ}\text{C}$ and connected with the system simulator.
2. The power supply voltage to the EUT is varied from 85% to 115% of the nominal value measured at the input to the EUT.
3. The variation in frequency is measured for the worst case.

4 Radiated Test Items

4.1 Measuring Instruments

Please refer to the measuring equipment list in this test report.

4.2 Test Setup

For radiated test below 30MHz

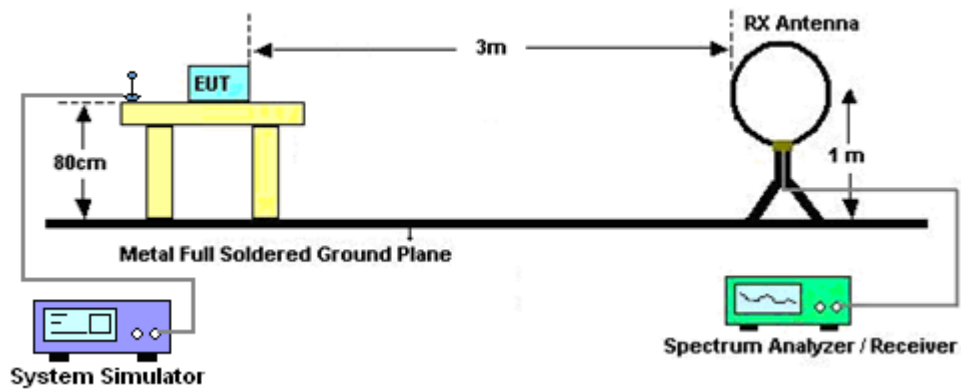

For radiated test from 30MHz to 1GHz

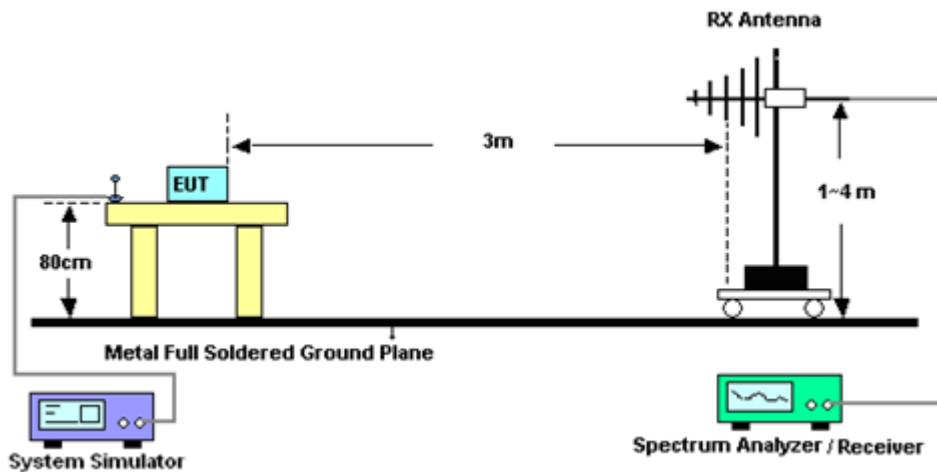

For radiated test from 1GHz to 18GHz

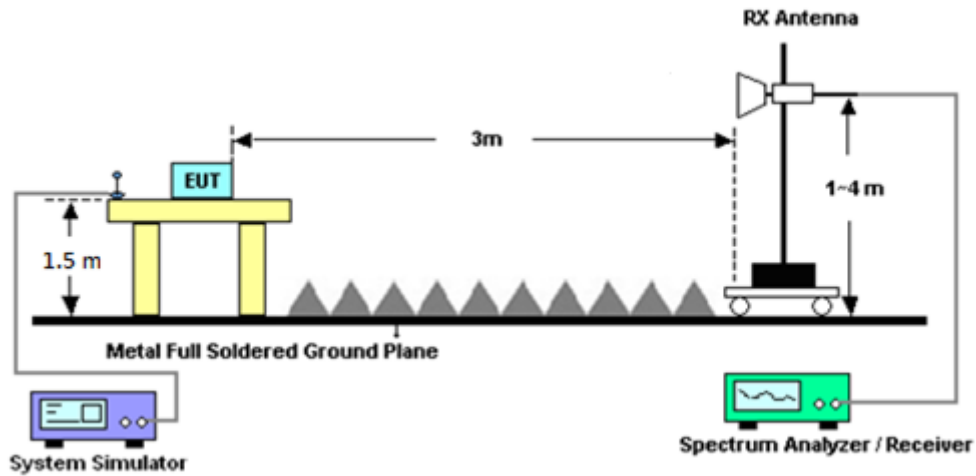

For radiated test above 18GHz

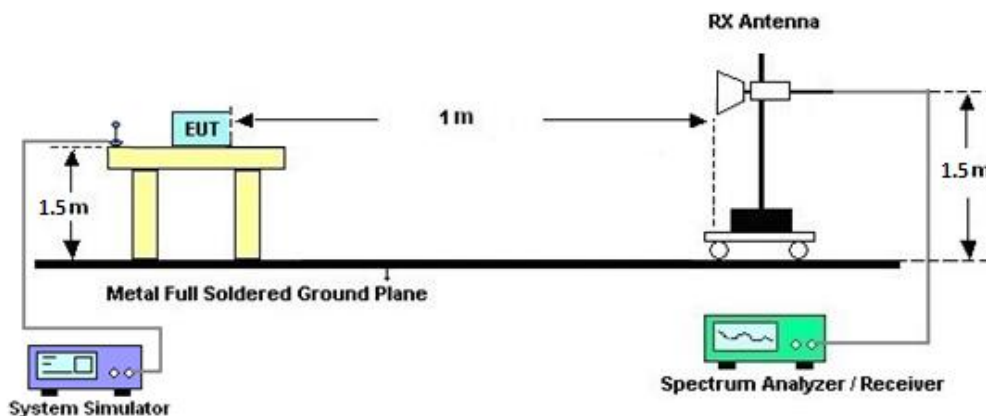

4.3 Test Result of Radiated Test

Please refer to Appendix B.

Note:

The low frequency, which starts from 9 kHz to 30 MHz, is pre-scanned and the result which is 20 dB lower than the limit line is not reported.

There is adequate comparison measurement of both open-field test site and alternative test site - semi-Anechoic chamber according to 414788 D01 Radiated Test Site v01r01, and the result came out very similar.



4.4 Field Strength of Spurious Radiation Measurement

4.4.1 Description of Field Strength of Spurious Radiated Measurement

The power of any emission outside of the authorized operating frequency ranges must be attenuated below the transmitter power (P) by a factor of at least $43 + 10 \log (P)$ dB. The spectrum is scanned from 30 MHz up to a frequency including its 10th harmonic.

4.4.2 Test Procedures

The testing follows FCC KDB 971168 D01 v03r01 Section 7 and ANSI / TIA-603-E Section 2.2.12.

1. The EUT is placed on a rotatable wooden table 0.8 meters for frequency below 1 GHz and 1.5 meter for frequency above 1 GHz above the ground.
2. The EUT is set 3 meters away from the receiving antenna, which is mounted on the antenna tower.
3. The table is rotated 360 degrees to determine the position of the highest spurious emission.
4. The height of the receiving antenna is varied between one meter and four meters to search for the maximum spurious emission for both horizontal and vertical polarizations.
5. Make the measurement with the spectrum analyzer's RBW = 1 MHz, VBW = 3 MHz, taking record of maximum spurious emission.
6. A horn antenna is substituted in place of the EUT and is driven by a signal generator.
7. Tune the output power of signal generator to the same emission level with EUT maximum spurious emission.
8. Take the record of output power at antenna port.
9. Repeat step 7 to step 8 for another polarization.
10. $EIRP (dBm) = S.G. Power - Tx Cable Loss + Tx Antenna Gain$
11. $ERP (dBm) = EIRP - 2.15$
12. The RF fundamental frequency shall be excluded against the limit line in the operating frequency band.
13. The limit line is derived from $43 + 10\log(P)$ dB below the transmitter power P(Watts)



5 List of Measuring Equipment

Instrument	Brand Name	Model No.	Serial No.	Characteristics	Calibration Date	Test Date	Due Date	Remark
Hygrometer	TECEPEL	DTM-303B	TP210073	N/A	Nov. 16, 2021	Jul. 19, 2022~ Jul. 21, 2022	Nov. 15, 2022	Conducted (TH03-HY)
Spectrum Analyzer	Rohde & Schwarz	FSP30	101329	9kHz~30GHz	Sep. 30, 2021	Jul. 19, 2022~ Jul. 21, 2022	Sep. 29, 2022	Conducted (TH03-HY)
Temperature & Humidity Cabinet Chamber	ESPEC	LHU-113	1012005860	-20°C~85°C	Dec. 09, 2021	Jul. 19, 2022~ Jul. 21, 2022	Dec. 08, 2022	Conducted (TH03-HY)
Programmable Power Supply	GW Instek	PSS-2005	EL890001	1V~20V 0.5A~4A	Oct. 06, 2021	Jul. 19, 2022~ Jul. 21, 2022	Oct. 05, 2022	Conducted (TH03-HY)
Base Station(Measure)	Rohde & Schwarz	CMU200	117997	GSM / GPRS / WCDMA / CDMA	Sep. 19, 2021	Jul. 19, 2022~ Jul. 21, 2022	Sep. 18, 2022	Conducted (TH03-HY)
Power Divider	Warison	WCOU-0.4-26.5S-20	#A	N/A	Nov. 01, 2021	Jul. 19, 2022~ Jul. 21, 2022	Oct. 31, 2022	Conducted (TH03-HY)
Loop Antenna	Rohde & Schwarz	HFH2-Z2	100315	9 kHz~30 MHz	Jan. 07, 2022	Aug. 03, 2022~ Aug. 26, 2022	Jan. 06, 2023	Radiation (03CH11-HY)
Bilog Antenna	TESEQ	CBL 6111D & N-6-06	35414 & AT-N0602	30MHz~1GHz	Oct. 09, 2021	Aug. 03, 2022~ Aug. 26, 2022	Oct. 08, 2022	Radiation (03CH11-HY)
Horn Antenna	SCHWARZBECK	BBHA 9120 D	9120D-1212	1GHz ~ 18GHz	Mar. 10, 2022	Aug. 03, 2022~ Aug. 26, 2022	Mar. 09, 2023	Radiation (03CH11-HY)
SHF-EHF Horn Antenna	SCHWARZBECK	BBHA9170	00993	18GHz~40GHz	Nov. 30, 2021	Aug. 03, 2022~ Aug. 26, 2022	Nov. 29, 2022	Radiation (03CH11-HY)
Amplifier	SONOMA	310N	187312	9kHz~1GHz	Dec. 10, 2021	Aug. 03, 2022~ Aug. 26, 2022	Dec. 09, 2022	Radiation (03CH11-HY)
Preamplifier	Keysight	83017A	MY53270080	1GHz~26.5GHz	Nov. 10, 2021	Aug. 03, 2022~ Aug. 26, 2022	Nov. 09, 2022	Radiation (03CH11-HY)
Preamplifier	Jet-Power	JPA0118-55-303	1710001800 055007	1GHz~18GHz	Jun. 15, 2022	Aug. 03, 2022~ Aug. 26, 2022	Jun. 14, 2023	Radiation (03CH11-HY)
Preamplifier	EMEC	EM18G40G	060801	18GHz~40GHz	Jun. 28, 2022	Aug. 03, 2022~ Aug. 26, 2022	Jun. 27, 2023	Radiation (03CH11-HY)
Spectrum Analyzer	Keysight	N9010A	MY54200486	10Hz~44GHz	Oct. 15, 2021	Aug. 03, 2022~ Aug. 26, 2022	Oct. 14, 2022	Radiation (03CH11-HY)
EMI Test Receiver	Keysight	N9038A(MXE)	MY54130085	20MHz~8.4GHz	Oct. 21, 2021	Aug. 03, 2022~ Aug. 26, 2022	Oct. 20, 2022	Radiation (03CH11-HY)
Controller	EMEC	EM 1000	N/A	Control Turn table & Ant Mast	N/A	Aug. 03, 2022~ Aug. 26, 2022	N/A	Radiation (03CH11-HY)
Antenna Mast	EMEC	AM-BS-4500-B	N/A	1~4m	N/A	Aug. 03, 2022~ Aug. 26, 2022	N/A	Radiation (03CH11-HY)
Turn Table	EMEC	TT 2000	N/A	0~360 Degree	N/A	Aug. 03, 2022~ Aug. 26, 2022	N/A	Radiation (03CH11-HY)
Software	Audix	E3 6.2009-8-24	RK-001053	N/A	N/A	Aug. 03, 2022~ Aug. 26, 2022	N/A	Radiation (03CH11-HY)
RF Cable	HUBER + SUHNER	SUCOFLEX 102	MY2859/2	30MHz-40GHz	Mar. 10, 2022	Aug. 03, 2022~ Aug. 26, 2022	Mar. 09, 2023	Radiation (03CH11-HY)
RF Cable	HUBER + SUHNER	SUCOFLEX 104	MY9837/4PE	9kHz-30MHz	Mar. 10, 2022	Aug. 03, 2022~ Aug. 26, 2022	Mar. 09, 2023	Radiation (03CH11-HY)
RF Cable	HUBER + SUHNER	SUCOFLEX 104	MY9837/4PE	30MHz-18GHz	Mar. 10, 2022	Aug. 03, 2022~ Aug. 26, 2022	Mar. 09, 2023	Radiation (03CH11-HY)
RF Cable	HUBER + SUHNER	SUCOFLEX 104	811852/4	30MHz-18GHz	Mar. 10, 2022	Aug. 03, 2022~ Aug. 26, 2022	Mar. 09, 2023	Radiation (03CH11-HY)



Instrument	Brand Name	Model No.	Serial No.	Characteristics	Calibration Date	Test Date	Due Date	Remark
Filter	Wainwright	WLK4-1000-1530-8000-40SS	SN11	1.53G Low Pass	Sep. 13, 2021	Aug. 03, 2022~ Aug. 26, 2022	Sep. 12, 2022	Radiation (03CH11-HY)
Filter	Wainwright	WHKX12-2700-3000-18000-60SS	SN3	3GHz High Pass Filter	Sep. 13, 2021	Aug. 03, 2022~ Aug. 26, 2022	Sep. 12, 2022	Radiation (03CH11-HY)
Filter	Wainwright	WHKX8-5872.5-6750-18000-40SS	SN3	6.75GHz High Pass Filter	Sep. 13, 2021	Aug. 03, 2022~ Aug. 26, 2022	Sep. 12, 2022	Radiation (03CH11-HY)
Filter	Wainwright	WHKX12-900-1000-15000-60SS	SN12	1GHz High Pass Filter	Nov. 04, 2021	Aug. 03, 2022~ Aug. 26, 2022	Nov. 03, 2022	Radiation (03CH11-HY)
Hygrometer	TECPEL	DTM-303B	TP140325	N/A	Nov. 26, 2021	Aug. 03, 2022~ Aug. 26, 2022	Nov. 25, 2022	Radiation (03CH11-HY)
Hygrometer	TECPEL	DTM-303B	TP200880	N/A	Sep. 30, 2021	Aug. 03, 2022~ Aug. 26, 2022	Sep. 29, 2022	Radiation (03CH11-HY)



6 Uncertainty of Evaluation

Uncertainty of Radiated Emission Measurement (30 MHz ~ 1000 MHz)

Measuring Uncertainty for a Level of Confidence of 95% ($U = 2Uc(y)$)	3.15 dB
---	---------

Uncertainty of Radiated Emission Measurement (1 GHz ~ 18 GHz)

Measuring Uncertainty for a Level of Confidence of 95% ($U = 2Uc(y)$)	3.41 dB
---	---------

Uncertainty of Radiated Emission Measurement (18 GHz ~ 40 GHz)

Measuring Uncertainty for a Level of Confidence of 95% ($U = 2Uc(y)$)	4.45 dB
---	---------



Appendix A. Test Results of Conducted Test

Conducted Output Power(Average power & ERP / EIRP)

WCDMA Band V Maximum Average Power [dBm] (GT - LC = 3.5 dB)					
Channel	4132	4182	4233	ERP (dBm)	ERP (W)
Frequency	826.4	836.4	846.6		
RMC 12.2K	23.75	23.97	24.19	25.54	0.3581
HSDPA Subtest-1	22.93	23.15	23.37		
HSDPA Subtest-2	22.90	23.15	23.36		
HSDPA Subtest-3	22.44	22.65	22.88		
HSDPA Subtest-4	22.37	22.64	22.87		
HSUPA Subtest-1	22.89	23.14	23.37		
HSUPA Subtest-2	20.43	20.66	20.88		
HSUPA Subtest-3	21.42	21.63	21.85		
HSUPA Subtest-4	20.40	20.64	20.87		
HSUPA Subtest-5	22.84	23.07	23.20		
Limit	ERP < 7W				

WCDMA Band II Maximum Average Power [dBm] (GT - LC = 5.9 dB)					
Channel	9262	9400	9538	EIRP (dBm)	EIRP (W)
Frequency	1852.4	1880	1907.6		
RMC 12.2K	23.62	23.96	24.12	30.02	1.0046
HSDPA Subtest-1	22.77	23.04	23.13		
HSDPA Subtest-2	22.78	23.06	23.15		
HSDPA Subtest-3	22.27	22.55	22.64		
HSDPA Subtest-4	22.21	22.57	22.65		
HSUPA Subtest-1	22.77	23.04	23.15		
HSUPA Subtest-2	20.70	21.00	21.06		
HSUPA Subtest-3	21.68	21.96	22.04		
HSUPA Subtest-4	20.70	20.97	21.07		
HSUPA Subtest-5	22.70	22.96	23.08		
Limit	EIRP < 2W				

WCDMA Band IV Maximum Average Power [dBm] (GT - LC = 5.5 dB)					
Channel	1312	1413	1513	EIRP (dBm)	EIRP (W)
Frequency	1712.4	1732.6	1752.6		
RMC 12.2K	23.41	23.50	23.76	29.26	0.8433
HSDPA Subtest-1	22.69	22.66	22.86		
HSDPA Subtest-2	22.68	22.65	22.83		
HSDPA Subtest-3	22.14	22.15	22.35		
HSDPA Subtest-4	22.17	22.12	22.35		
HSUPA Subtest-1	22.67	22.65	22.85		
HSUPA Subtest-2	20.56	20.55	20.71		
HSUPA Subtest-3	21.54	21.53	21.74		
HSUPA Subtest-4	20.54	20.52	20.73		
HSUPA Subtest-5	22.56	22.57	22.77		
Limit	EIRP < 1W				



A2. WCDMA

Peak-to-Average Ratio

Mode	WCDMA Band V	WCDMA Band II	WCDMA Band IV	Limit: 13dB
Mod.	RMC 12.2Kbps	RMC 12.2Kbps	RMC 12.2Kbps	Result
Lowest CH	2.84	3.00	2.88	PASS
Middle CH	3.04	2.96	2.60	
Highest CH	3.04	2.88	2.96	

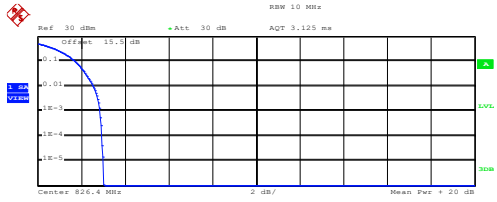
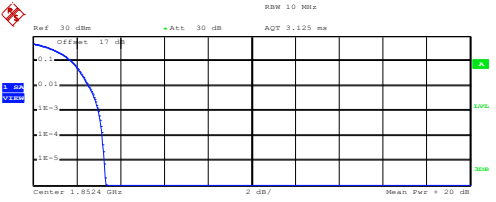
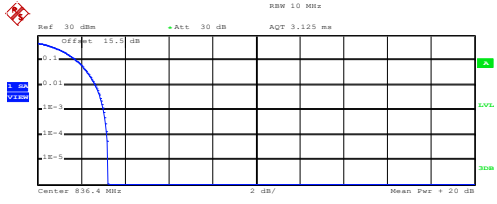
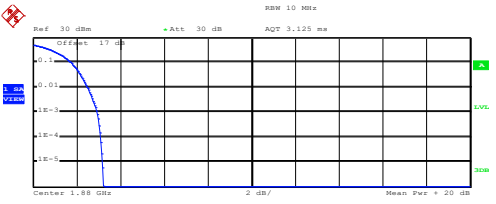
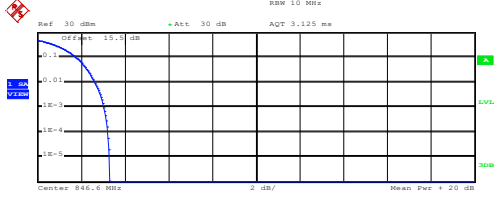
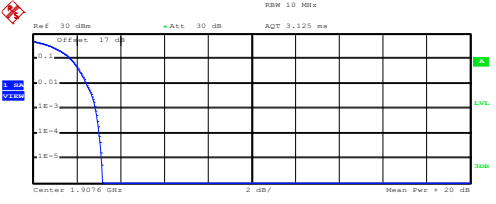

WCDMA Band V (RMC 12.2Kbps)	WCDMA Band II (RMC 12.2Kbps)
<p style="text-align: center;">Lowest Channel</p>  <p>Center: 826.4 MHz 2 dB/ Mean Pwr: +20 dB</p> <p>Complementary Cumulative Distribution Function (100000 samples)</p> <p>Trace 1</p> <p>Mean 23.71 dBm Peak 26.72 dBm Crest 3.01 dB</p> <p>10 % 1.72 dB 1 % 2.56 dB .1 % 2.84 dB .01 % 2.96 dB</p> <p>Date: 19.JUL.2022 17:02:02</p>	<p style="text-align: center;">Lowest Channel</p>  <p>Center: 1.8524 GHz 2 dB/ Mean Pwr: +20 dB</p> <p>Complementary Cumulative Distribution Function (100000 samples)</p> <p>Trace 1</p> <p>Mean 24.03 dBm Peak 27.36 dBm Crest 3.33 dB</p> <p>10 % 1.76 dB 1 % 2.56 dB .1 % 3.00 dB .01 % 3.16 dB</p> <p>Date: 19.JUL.2022 17:37:42</p>
<p style="text-align: center;">Middle Channel</p>  <p>Center: 836.4 MHz 2 dB/ Mean Pwr: +20 dB</p> <p>Complementary Cumulative Distribution Function (100000 samples)</p> <p>Trace 1</p> <p>Mean 23.92 dBm Peak 27.14 dBm Crest 3.22 dB</p> <p>10 % 1.76 dB 1 % 2.64 dB .1 % 3.04 dB .01 % 3.16 dB</p> <p>Date: 19.JUL.2022 17:02:32</p>	<p style="text-align: center;">Middle Channel</p>  <p>Center: 1.88 GHz 2 dB/ Mean Pwr: +20 dB</p> <p>Complementary Cumulative Distribution Function (100000 samples)</p> <p>Trace 1</p> <p>Mean 24.12 dBm Peak 27.36 dBm Crest 3.24 dB</p> <p>10 % 1.76 dB 1 % 2.52 dB .1 % 2.96 dB .01 % 3.12 dB</p> <p>Date: 19.JUL.2022 17:38:08</p>
<p style="text-align: center;">Highest Channel</p>  <p>Center: 846.6 MHz 2 dB/ Mean Pwr: +20 dB</p> <p>Complementary Cumulative Distribution Function (100000 samples)</p> <p>Trace 1</p> <p>Mean 24.19 dBm Peak 27.50 dBm Crest 3.31 dB</p> <p>10 % 1.80 dB 1 % 2.64 dB .1 % 3.04 dB .01 % 3.24 dB</p> <p>Date: 19.JUL.2022 17:02:57</p>	<p style="text-align: center;">Highest Channel</p>  <p>Center: 1.9076 GHz 2 dB/ Mean Pwr: +20 dB</p> <p>Complementary Cumulative Distribution Function (100000 samples)</p> <p>Trace 1</p> <p>Mean 24.25 dBm Peak 27.43 dBm Crest 3.17 dB</p> <p>10 % 1.72 dB 1 % 2.48 dB .1 % 2.88 dB .01 % 3.04 dB</p> <p>Date: 19.JUL.2022 17:38:27</p>

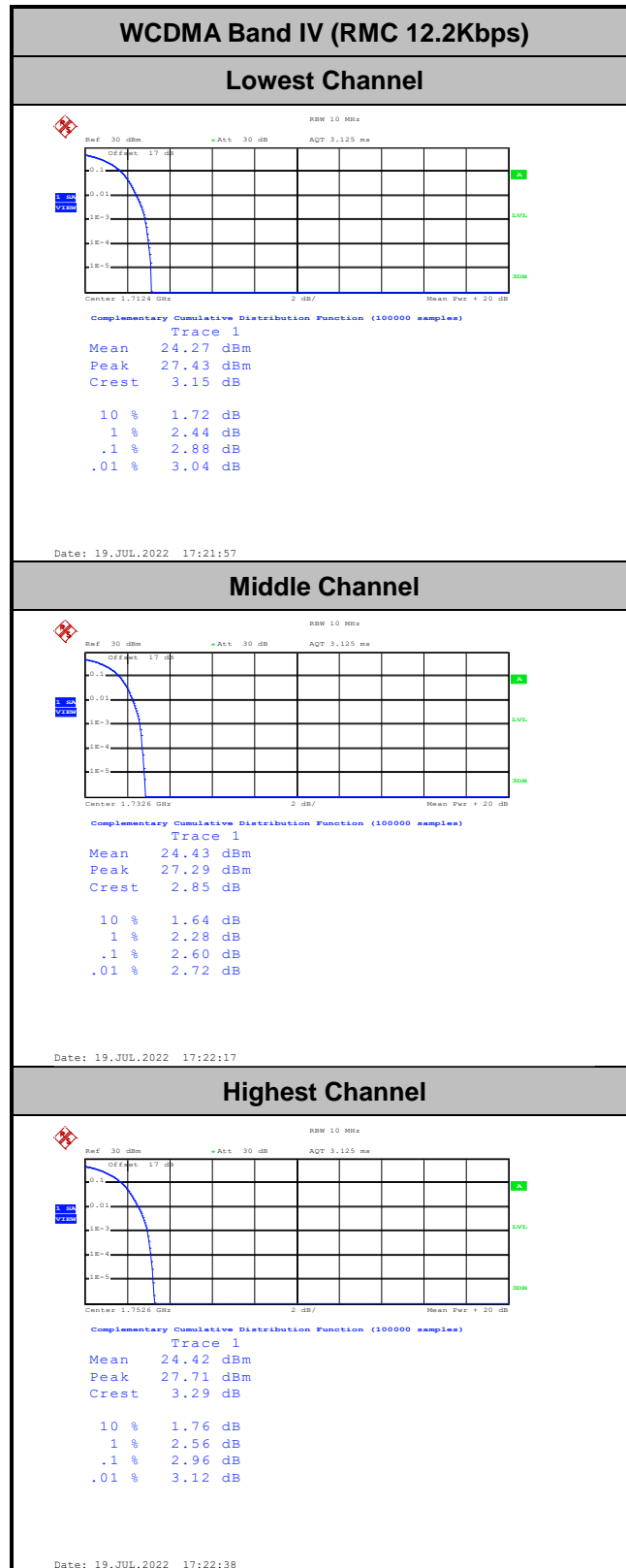



26dB Bandwidth

Mode	WCDMA Band V	WCDMA Band II	WCDMA Band IV
Mod.	RMC 12.2Kbps	RMC 12.2Kbps	RMC 12.2Kbps
Lowest CH	4.73	4.72	4.74
Middle CH	4.72	4.72	4.74
Highest CH	4.72	4.74	4.72



WCDMA Band V (RMC 12.2Kbps)

WCDMA Band II (RMC 12.2Kbps)

Lowest Channel

Lowest Channel

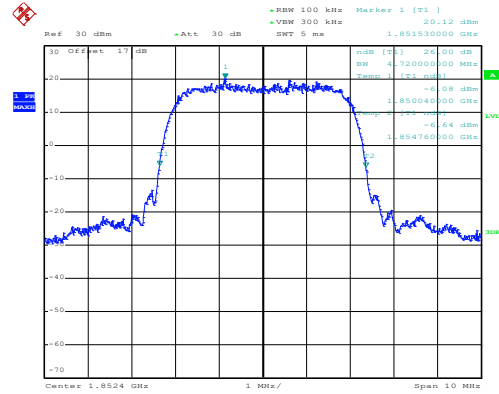
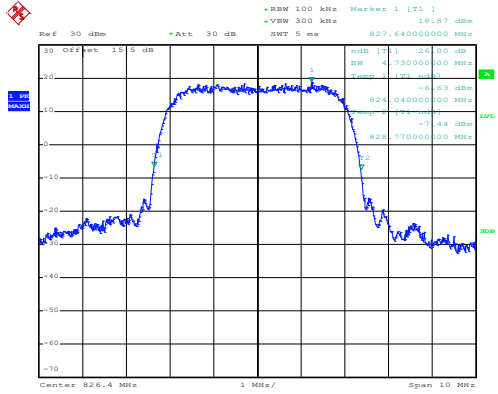

Date: 19.JUL.2022 16:44:37

Date: 19.JUL.2022 17:24:55

Middle Channel

Middle Channel

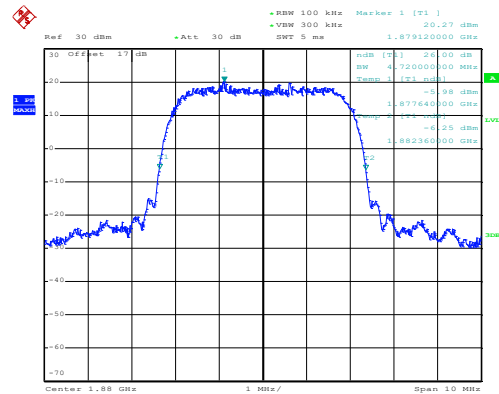
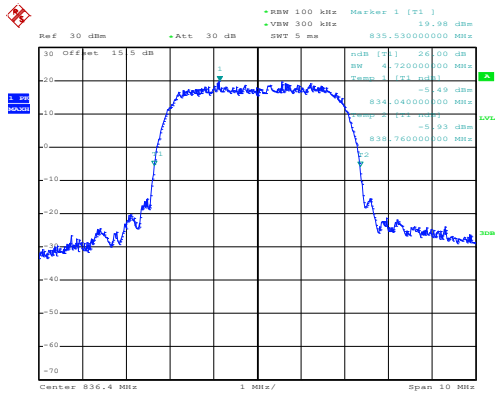

Date: 19.JUL.2022 16:45:31

Date: 19.JUL.2022 17:25:37

Highest Channel

Highest Channel

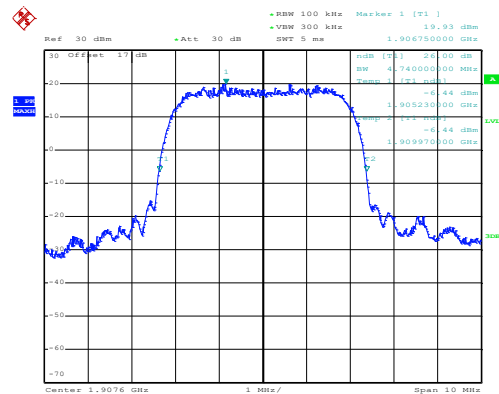
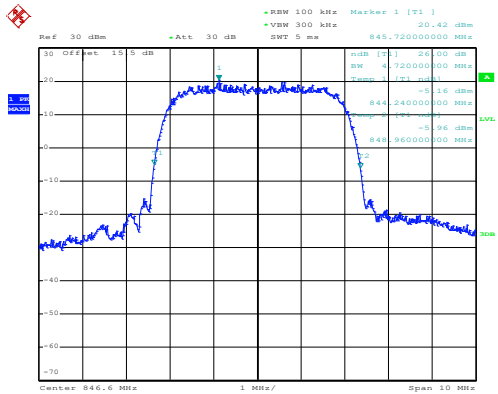

Date: 19.JUL.2022 16:45:27

Date: 19.JUL.2022 17:26:15



WCDMA Band IV (RMC 12.2Kbps)

Lowest Channel

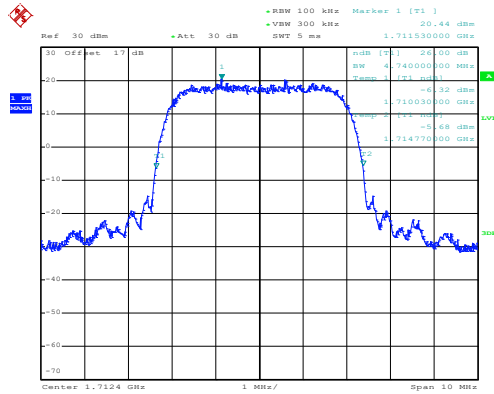

Date: 19.JUL.2022 17:05:29

Middle Channel

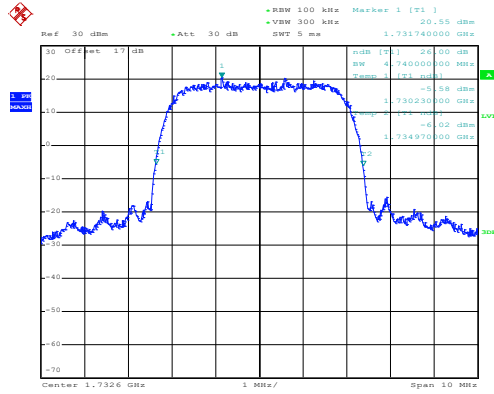

Date: 19.JUL.2022 17:06:09

Highest Channel

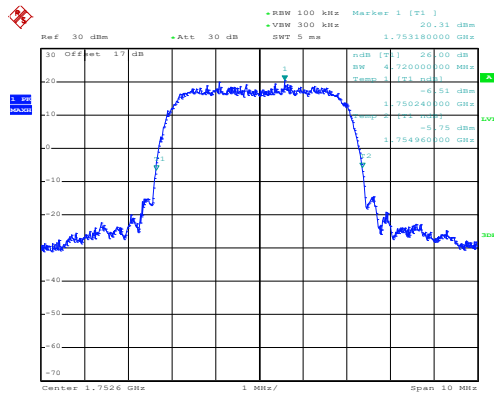



Occupied Bandwidth

Mode	WCDMA Band V	WCDMA Band II	WCDMA Band IV
Mod.	RMC 12.2Kbps	RMC 12.2Kbps	RMC 12.2Kbps
Lowest CH	4.14	4.16	4.17
Middle CH	4.15	4.16	4.16
Highest CH	4.15	4.16	4.15

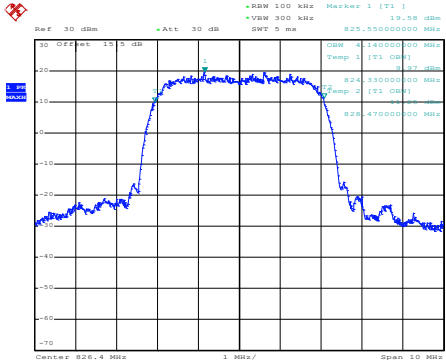
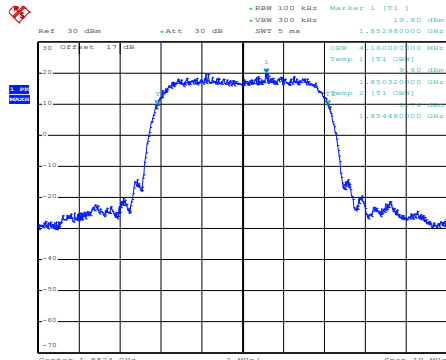
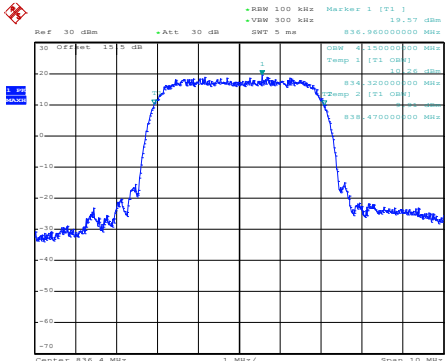
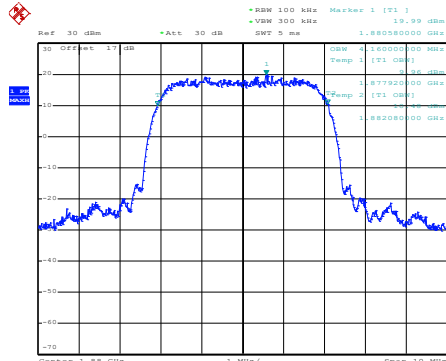
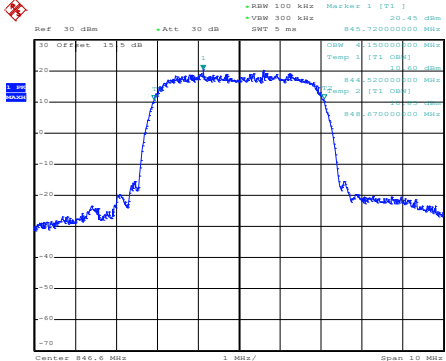
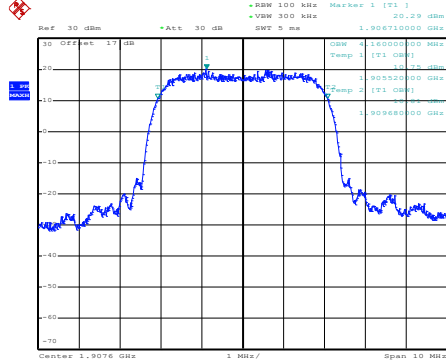

WCDMA Band V (RMC 12.2Kbps)	WCDMA Band II (RMC 12.2Kbps)
<p style="text-align: center;">Lowest Channel</p>  <p>Date: 19.JUL.2022 16:53:31</p>	<p style="text-align: center;">Lowest Channel</p>  <p>Date: 19.JUL.2022 17:29:57</p>
<p style="text-align: center;">Middle Channel</p>  <p>Date: 19.JUL.2022 16:54:11</p>	<p style="text-align: center;">Middle Channel</p>  <p>Date: 19.JUL.2022 17:30:40</p>
<p style="text-align: center;">Highest Channel</p>  <p>Date: 19.JUL.2022 16:54:54</p>	<p style="text-align: center;">Highest Channel</p>  <p>Date: 19.JUL.2022 17:31:21</p>



WCDMA Band IV (RMC 12.2Kbps)

Lowest Channel

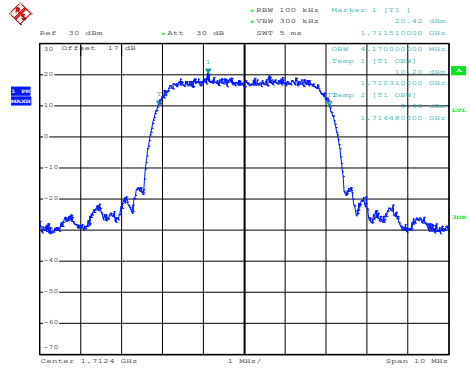

Date: 19.JUL.2022 17:10:46

Middle Channel

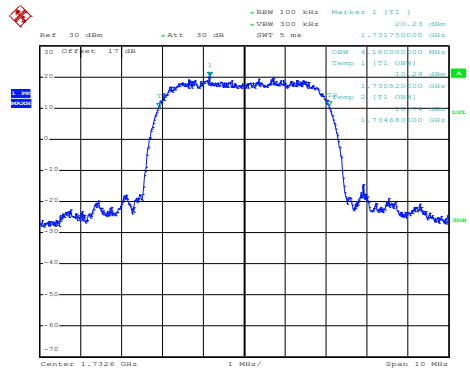

Date: 19.JUL.2022 17:11:57

Highest Channel

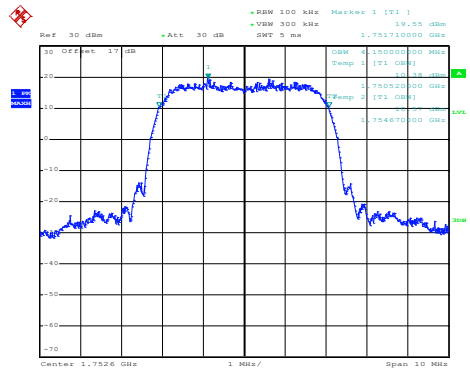

Date: 19.JUL.2022 17:13:58



Conducted Band Edge

WCDMA Band V (RMC 12.2Kbps)

Lowest Band Edge

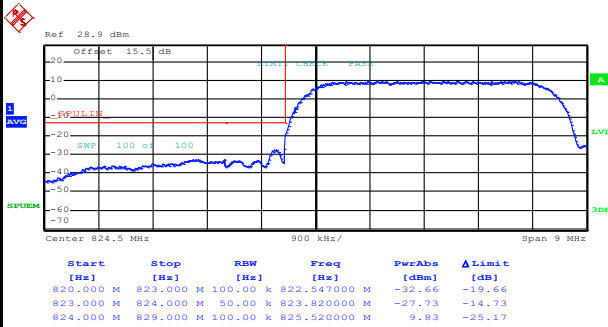

Date: 19.JUL.2022 16:57:54

Highest Band Edge

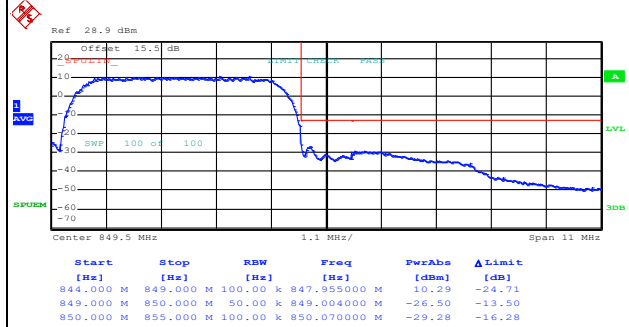

Date: 19.JUL.2022 17:01:13



WCDMA Band II (RMC 12.2Kbps)

Lowest Band Edge

Highest Band Edge

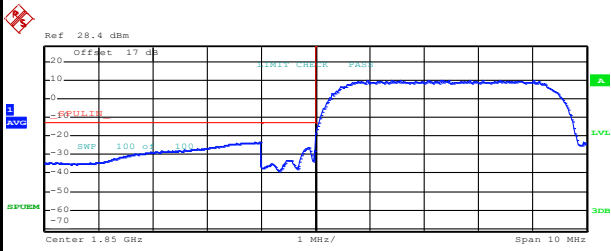

Start [Hz]	Stop [Hz]	RBW [Hz]	Freq [Hz]	PwrAbs [dBm]	ΔLimit [dB]
1.845 G	1.849 G	1.00 M	1.848976 G	-23.45	-10.45
1.849 G	1.850 G	50.00 k	1.849852 G	-26.36	-13.36
1.850 G	1.855 G	100.00 k	1.850955 G	10.08	-24.92

Date: 19.JUL.2022 17:34:19

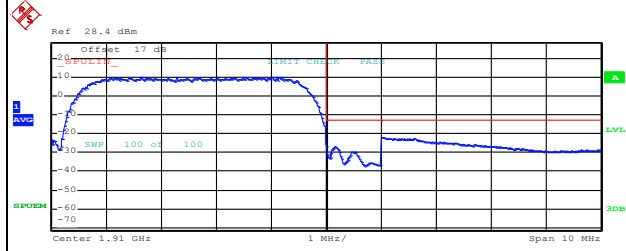

Start [Hz]	Stop [Hz]	RBW [Hz]	Freq [Hz]	PwrAbs [dBm]	ΔLimit [dB]
1.905 G	1.910 G	100.00 k	1.908475 G	10.20	-24.80
1.910 G	1.911 G	50.00 k	1.910152 G	-27.11	-14.11
1.911 G	1.915 G	1.00 M	1.911012 G	-22.19	-9.19

Date: 19.JUL.2022 17:37:13



WCDMA Band IV (RMC 12.2Kbps)

Lowest Band Edge

Highest Band Edge

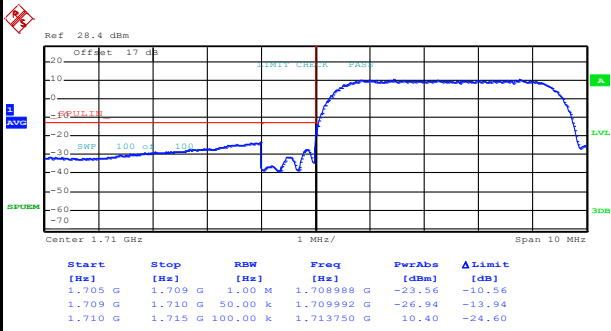

Date: 19.JUL.2022 17:16:53

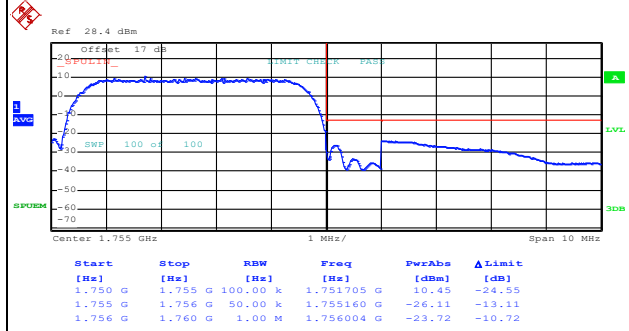

Date: 19.JUL.2022 17:20:52

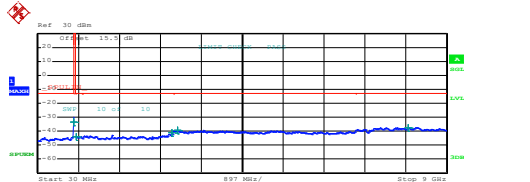
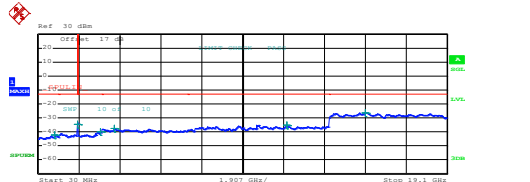
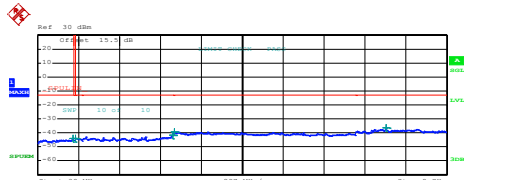
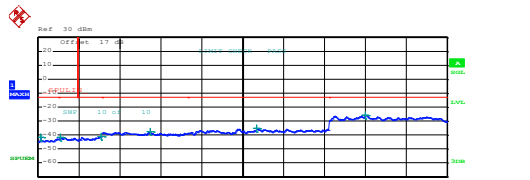
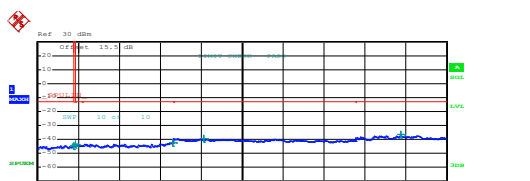
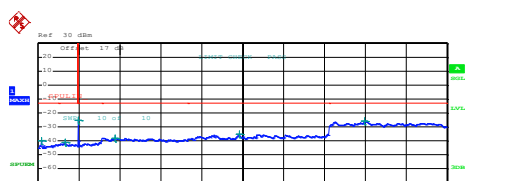

Conducted Spurious Emission

WCDMA Band V (RMC 12.2Kbps)	WCDMA Band II (RMC 12.2Kbps)																																																																														
Lowest Channel	Lowest Channel																																																																														
 <table border="1" data-bbox="252 660 735 739"> <thead> <tr> <th>Start [Hz]</th> <th>Stop [Hz]</th> <th>RBW [Hz]</th> <th>Freq [Hz]</th> <th>PwrAve [dBm]</th> <th>ΔLimit [dB]</th> </tr> </thead> <tbody> <tr><td>30,000 M</td><td>820,000 M</td><td>1,000 M</td><td>810,000000 M</td><td>-33.49</td><td>-20.49</td></tr> <tr><td>855,000 M</td><td>1,000 G</td><td>1,000 M</td><td>870,043751 M</td><td>-43.82</td><td>-30.82</td></tr> <tr><td>1,000 G</td><td>3,000 G</td><td>1,000 M</td><td>2,965000 G</td><td>-40.96</td><td>-27.96</td></tr> <tr><td>3,000 G</td><td>7,000 G</td><td>1,000 M</td><td>3,0390000 G</td><td>-39.39</td><td>-26.39</td></tr> <tr><td>7,000 G</td><td>9,000 G</td><td>1,000 M</td><td>8,158500 G</td><td>-37.32</td><td>-24.32</td></tr> </tbody> </table> <p>Date: 19.JUL.2022 16:50:24</p>	Start [Hz]	Stop [Hz]	RBW [Hz]	Freq [Hz]	PwrAve [dBm]	ΔLimit [dB]	30,000 M	820,000 M	1,000 M	810,000000 M	-33.49	-20.49	855,000 M	1,000 G	1,000 M	870,043751 M	-43.82	-30.82	1,000 G	3,000 G	1,000 M	2,965000 G	-40.96	-27.96	3,000 G	7,000 G	1,000 M	3,0390000 G	-39.39	-26.39	7,000 G	9,000 G	1,000 M	8,158500 G	-37.32	-24.32	 <table border="1" data-bbox="901 660 1385 739"> <thead> <tr> <th>Start [Hz]</th> <th>Stop [Hz]</th> <th>RBW [Hz]</th> <th>Freq [Hz]</th> <th>PwrAve [dBm]</th> <th>ΔLimit [dB]</th> </tr> </thead> <tbody> <tr><td>30,000 M</td><td>1,000 G</td><td>1,000 M</td><td>797,950000 M</td><td>-42.20</td><td>-29.20</td></tr> <tr><td>1,000 G</td><td>3,845 G</td><td>1,000 M</td><td>1,845078 G</td><td>-36.41</td><td>-21.41</td></tr> <tr><td>1,915 G</td><td>3,000 G</td><td>1,000 M</td><td>2,916726 G</td><td>-40.10</td><td>-27.10</td></tr> <tr><td>3,000 G</td><td>7,000 G</td><td>1,000 M</td><td>3,984000 G</td><td>-37.78</td><td>-24.78</td></tr> <tr><td>7,000 G</td><td>13,600 G</td><td>1,000 M</td><td>11,633878 G</td><td>-35.45</td><td>-22.45</td></tr> <tr><td>13,600 G</td><td>19,100 G</td><td>1,000 M</td><td>15,272688 G</td><td>-26.25</td><td>-13.25</td></tr> </tbody> </table> <p>Date: 19.JUL.2022 17:27:17</p>	Start [Hz]	Stop [Hz]	RBW [Hz]	Freq [Hz]	PwrAve [dBm]	ΔLimit [dB]	30,000 M	1,000 G	1,000 M	797,950000 M	-42.20	-29.20	1,000 G	3,845 G	1,000 M	1,845078 G	-36.41	-21.41	1,915 G	3,000 G	1,000 M	2,916726 G	-40.10	-27.10	3,000 G	7,000 G	1,000 M	3,984000 G	-37.78	-24.78	7,000 G	13,600 G	1,000 M	11,633878 G	-35.45	-22.45	13,600 G	19,100 G	1,000 M	15,272688 G	-26.25	-13.25
Start [Hz]	Stop [Hz]	RBW [Hz]	Freq [Hz]	PwrAve [dBm]	ΔLimit [dB]																																																																										
30,000 M	820,000 M	1,000 M	810,000000 M	-33.49	-20.49																																																																										
855,000 M	1,000 G	1,000 M	870,043751 M	-43.82	-30.82																																																																										
1,000 G	3,000 G	1,000 M	2,965000 G	-40.96	-27.96																																																																										
3,000 G	7,000 G	1,000 M	3,0390000 G	-39.39	-26.39																																																																										
7,000 G	9,000 G	1,000 M	8,158500 G	-37.32	-24.32																																																																										
Start [Hz]	Stop [Hz]	RBW [Hz]	Freq [Hz]	PwrAve [dBm]	ΔLimit [dB]																																																																										
30,000 M	1,000 G	1,000 M	797,950000 M	-42.20	-29.20																																																																										
1,000 G	3,845 G	1,000 M	1,845078 G	-36.41	-21.41																																																																										
1,915 G	3,000 G	1,000 M	2,916726 G	-40.10	-27.10																																																																										
3,000 G	7,000 G	1,000 M	3,984000 G	-37.78	-24.78																																																																										
7,000 G	13,600 G	1,000 M	11,633878 G	-35.45	-22.45																																																																										
13,600 G	19,100 G	1,000 M	15,272688 G	-26.25	-13.25																																																																										
Middle Channel	Middle Channel																																																																														
 <table border="1" data-bbox="252 1176 735 1254"> <thead> <tr> <th>Start [Hz]</th> <th>Stop [Hz]</th> <th>RBW [Hz]</th> <th>Freq [Hz]</th> <th>PwrAve [dBm]</th> <th>ΔLimit [dB]</th> </tr> </thead> <tbody> <tr><td>30,000 M</td><td>820,000 M</td><td>1,000 M</td><td>794,127500 M</td><td>-43.99</td><td>-30.99</td></tr> <tr><td>855,000 M</td><td>1,000 G</td><td>1,000 M</td><td>858,262500 M</td><td>-43.78</td><td>-30.78</td></tr> <tr><td>1,000 G</td><td>3,000 G</td><td>1,000 M</td><td>2,994000 G</td><td>-43.33</td><td>-30.33</td></tr> <tr><td>3,000 G</td><td>7,000 G</td><td>1,000 M</td><td>3,031000 G</td><td>-39.44</td><td>-26.44</td></tr> <tr><td>7,000 G</td><td>9,000 G</td><td>1,000 M</td><td>7,675500 G</td><td>-38.65</td><td>-23.65</td></tr> </tbody> </table> <p>Date: 19.JUL.2022 16:51:21</p>	Start [Hz]	Stop [Hz]	RBW [Hz]	Freq [Hz]	PwrAve [dBm]	ΔLimit [dB]	30,000 M	820,000 M	1,000 M	794,127500 M	-43.99	-30.99	855,000 M	1,000 G	1,000 M	858,262500 M	-43.78	-30.78	1,000 G	3,000 G	1,000 M	2,994000 G	-43.33	-30.33	3,000 G	7,000 G	1,000 M	3,031000 G	-39.44	-26.44	7,000 G	9,000 G	1,000 M	7,675500 G	-38.65	-23.65	 <table border="1" data-bbox="901 1176 1385 1254"> <thead> <tr> <th>Start [Hz]</th> <th>Stop [Hz]</th> <th>RBW [Hz]</th> <th>Freq [Hz]</th> <th>PwrAve [dBm]</th> <th>ΔLimit [dB]</th> </tr> </thead> <tbody> <tr><td>30,000 M</td><td>1,000 G</td><td>1,000 M</td><td>142,520000 M</td><td>-41.76</td><td>-28.76</td></tr> <tr><td>1,000 G</td><td>3,845 G</td><td>1,000 M</td><td>1,005910 G</td><td>-41.42</td><td>-28.42</td></tr> <tr><td>1,915 G</td><td>3,000 G</td><td>1,000 M</td><td>2,982688 G</td><td>-40.92</td><td>-27.92</td></tr> <tr><td>3,000 G</td><td>7,000 G</td><td>1,000 M</td><td>5,237000 G</td><td>-37.82</td><td>-24.82</td></tr> <tr><td>7,000 G</td><td>13,600 G</td><td>1,000 M</td><td>10,215025 G</td><td>-35.45</td><td>-22.45</td></tr> <tr><td>13,600 G</td><td>19,100 G</td><td>1,000 M</td><td>15,203313 G</td><td>-25.90</td><td>-12.90</td></tr> </tbody> </table> <p>Date: 19.JUL.2022 17:28:13</p>	Start [Hz]	Stop [Hz]	RBW [Hz]	Freq [Hz]	PwrAve [dBm]	ΔLimit [dB]	30,000 M	1,000 G	1,000 M	142,520000 M	-41.76	-28.76	1,000 G	3,845 G	1,000 M	1,005910 G	-41.42	-28.42	1,915 G	3,000 G	1,000 M	2,982688 G	-40.92	-27.92	3,000 G	7,000 G	1,000 M	5,237000 G	-37.82	-24.82	7,000 G	13,600 G	1,000 M	10,215025 G	-35.45	-22.45	13,600 G	19,100 G	1,000 M	15,203313 G	-25.90	-12.90
Start [Hz]	Stop [Hz]	RBW [Hz]	Freq [Hz]	PwrAve [dBm]	ΔLimit [dB]																																																																										
30,000 M	820,000 M	1,000 M	794,127500 M	-43.99	-30.99																																																																										
855,000 M	1,000 G	1,000 M	858,262500 M	-43.78	-30.78																																																																										
1,000 G	3,000 G	1,000 M	2,994000 G	-43.33	-30.33																																																																										
3,000 G	7,000 G	1,000 M	3,031000 G	-39.44	-26.44																																																																										
7,000 G	9,000 G	1,000 M	7,675500 G	-38.65	-23.65																																																																										
Start [Hz]	Stop [Hz]	RBW [Hz]	Freq [Hz]	PwrAve [dBm]	ΔLimit [dB]																																																																										
30,000 M	1,000 G	1,000 M	142,520000 M	-41.76	-28.76																																																																										
1,000 G	3,845 G	1,000 M	1,005910 G	-41.42	-28.42																																																																										
1,915 G	3,000 G	1,000 M	2,982688 G	-40.92	-27.92																																																																										
3,000 G	7,000 G	1,000 M	5,237000 G	-37.82	-24.82																																																																										
7,000 G	13,600 G	1,000 M	10,215025 G	-35.45	-22.45																																																																										
13,600 G	19,100 G	1,000 M	15,203313 G	-25.90	-12.90																																																																										
Highest Channel	Highest Channel																																																																														
 <table border="1" data-bbox="252 1691 735 1769"> <thead> <tr> <th>Start [Hz]</th> <th>Stop [Hz]</th> <th>RBW [Hz]</th> <th>Freq [Hz]</th> <th>PwrAve [dBm]</th> <th>ΔLimit [dB]</th> </tr> </thead> <tbody> <tr><td>30,000 M</td><td>820,000 M</td><td>1,000 M</td><td>814,470000 M</td><td>-44.38</td><td>-31.38</td></tr> <tr><td>855,000 M</td><td>1,000 G</td><td>1,000 M</td><td>855,336250 M</td><td>-43.44</td><td>-30.44</td></tr> <tr><td>1,000 G</td><td>3,000 G</td><td>1,000 M</td><td>2,994500 G</td><td>-42.35</td><td>-29.35</td></tr> <tr><td>3,000 G</td><td>7,000 G</td><td>1,000 M</td><td>3,040400 G</td><td>-39.05</td><td>-26.05</td></tr> <tr><td>7,000 G</td><td>9,000 G</td><td>1,000 M</td><td>7,994500 G</td><td>-36.36</td><td>-23.36</td></tr> </tbody> </table> <p>Date: 19.JUL.2022 16:52:24</p>	Start [Hz]	Stop [Hz]	RBW [Hz]	Freq [Hz]	PwrAve [dBm]	ΔLimit [dB]	30,000 M	820,000 M	1,000 M	814,470000 M	-44.38	-31.38	855,000 M	1,000 G	1,000 M	855,336250 M	-43.44	-30.44	1,000 G	3,000 G	1,000 M	2,994500 G	-42.35	-29.35	3,000 G	7,000 G	1,000 M	3,040400 G	-39.05	-26.05	7,000 G	9,000 G	1,000 M	7,994500 G	-36.36	-23.36	 <table border="1" data-bbox="901 1691 1385 1769"> <thead> <tr> <th>Start [Hz]</th> <th>Stop [Hz]</th> <th>RBW [Hz]</th> <th>Freq [Hz]</th> <th>PwrAve [dBm]</th> <th>ΔLimit [dB]</th> </tr> </thead> <tbody> <tr><td>30,000 M</td><td>1,000 G</td><td>1,000 M</td><td>168,910000 M</td><td>-39.75</td><td>-26.75</td></tr> <tr><td>1,000 G</td><td>3,845 G</td><td>1,000 M</td><td>1,274826 G</td><td>-41.50</td><td>-28.50</td></tr> <tr><td>1,915 G</td><td>3,000 G</td><td>1,000 M</td><td>1,915271 G</td><td>-25.37</td><td>-12.37</td></tr> <tr><td>3,000 G</td><td>7,000 G</td><td>1,000 M</td><td>3,602000 G</td><td>-37.94</td><td>-24.94</td></tr> <tr><td>7,000 G</td><td>13,600 G</td><td>1,000 M</td><td>9,339800 G</td><td>-35.45</td><td>-22.45</td></tr> <tr><td>13,600 G</td><td>19,100 G</td><td>1,000 M</td><td>15,260313 G</td><td>-25.82</td><td>-12.82</td></tr> </tbody> </table> <p>Date: 19.JUL.2022 17:29:07</p>	Start [Hz]	Stop [Hz]	RBW [Hz]	Freq [Hz]	PwrAve [dBm]	ΔLimit [dB]	30,000 M	1,000 G	1,000 M	168,910000 M	-39.75	-26.75	1,000 G	3,845 G	1,000 M	1,274826 G	-41.50	-28.50	1,915 G	3,000 G	1,000 M	1,915271 G	-25.37	-12.37	3,000 G	7,000 G	1,000 M	3,602000 G	-37.94	-24.94	7,000 G	13,600 G	1,000 M	9,339800 G	-35.45	-22.45	13,600 G	19,100 G	1,000 M	15,260313 G	-25.82	-12.82
Start [Hz]	Stop [Hz]	RBW [Hz]	Freq [Hz]	PwrAve [dBm]	ΔLimit [dB]																																																																										
30,000 M	820,000 M	1,000 M	814,470000 M	-44.38	-31.38																																																																										
855,000 M	1,000 G	1,000 M	855,336250 M	-43.44	-30.44																																																																										
1,000 G	3,000 G	1,000 M	2,994500 G	-42.35	-29.35																																																																										
3,000 G	7,000 G	1,000 M	3,040400 G	-39.05	-26.05																																																																										
7,000 G	9,000 G	1,000 M	7,994500 G	-36.36	-23.36																																																																										
Start [Hz]	Stop [Hz]	RBW [Hz]	Freq [Hz]	PwrAve [dBm]	ΔLimit [dB]																																																																										
30,000 M	1,000 G	1,000 M	168,910000 M	-39.75	-26.75																																																																										
1,000 G	3,845 G	1,000 M	1,274826 G	-41.50	-28.50																																																																										
1,915 G	3,000 G	1,000 M	1,915271 G	-25.37	-12.37																																																																										
3,000 G	7,000 G	1,000 M	3,602000 G	-37.94	-24.94																																																																										
7,000 G	13,600 G	1,000 M	9,339800 G	-35.45	-22.45																																																																										
13,600 G	19,100 G	1,000 M	15,260313 G	-25.82	-12.82																																																																										



WCDMA Band IV (RMC 12.2Kbps)

Lowest Channel

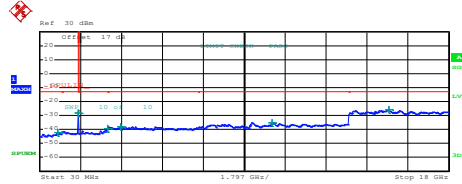

Start [Hz]	Stop [Hz]	RBW [Hz]	Freq [Hz]	PwrAbs [dBm]	LimIt [dB]
30.000 M	1.000 G	1.00 M	832.452500 M	-42.24	-29.28
1.000 G	1.700 G	1.00 M	1.704824 G	-26.14	-19.14
1.700 G	3.000 G	1.00 M	2.097830 G	-39.57	-26.57
3.000 G	7.000 G	1.00 M	3.288000 G	-38.09	-23.09
7.000 G	13.600 G	1.00 M	10.242250 G	-35.16	-22.16
13.600 G	18.000 G	1.00 M	15.389700 G	-26.13	-13.13

Date: 19.JUL.2022 17:08:01

Middle Channel

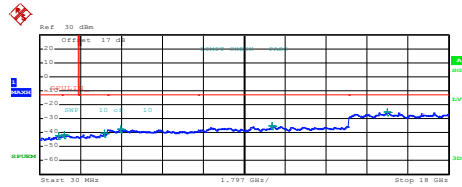

Start [Hz]	Stop [Hz]	RBW [Hz]	Freq [Hz]	PwrAbs [dBm]	LimIt [dB]
30.000 M	1.000 G	1.00 M	843.830000 M	-42.36	-29.36
1.000 G	1.700 G	1.00 M	1.099704 G	-43.86	-28.86
1.700 G	3.000 G	1.00 M	2.872240 G	-40.33	-27.33
3.000 G	7.000 G	1.00 M	3.596000 G	-37.81	-24.81
7.000 G	13.600 G	1.00 M	10.222450 G	-35.14	-22.14
13.600 G	18.000 G	1.00 M	15.303350 G	-25.47	-12.47

Date: 19.JUL.2022 17:08:59

Highest Channel

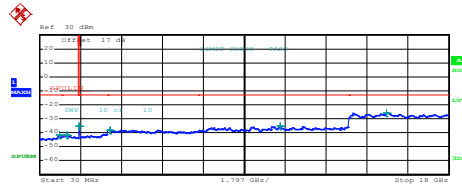

Start [Hz]	Stop [Hz]	RBW [Hz]	Freq [Hz]	PwrAbs [dBm]	LimIt [dB]
30.000 M	1.000 G	1.00 M	896.937500 M	-41.64	-28.64
1.000 G	1.700 G	1.00 M	1.202159 G	-41.41	-28.41
1.700 G	3.000 G	1.00 M	1.760310 G	-39.17	-22.17
3.000 G	7.000 G	1.00 M	3.103000 G	-37.87	-24.87
7.000 G	13.600 G	1.00 M	10.587925 G	-35.19	-22.19
13.600 G	18.000 G	1.00 M	15.268700 G	-25.79	-12.79

Date: 19.JUL.2022 17:09:55



Frequency Stability

Test Conditions Temperature (°C)	Middle Channel Voltage (Volt)	WCDMA Band V (RMC 12.2Kbps)		Limit Note 2.
		Deviation (ppm)	Deviation (Hz)	Result
70	Normal Voltage	0.0000	4	PASS
40	Normal Voltage	0.0000	4	
30	Normal Voltage	0.0012	5	
20(Ref.)	Normal Voltage	0.0000	4	
10	Normal Voltage	0.0120	-6	
0	Normal Voltage	0.0108	-5	
-10	Normal Voltage	0.0096	-4	
-20	Normal Voltage	0.0108	-5	
-30	Normal Voltage	0.0000	4	
20	Maximum Voltage	0.0024	6	
20	Normal Voltage	0.0000	4	
20	Battery End Point	0.0000	4	

Test Conditions Temperature (°C)	Middle Channel Voltage (Volt)	WCDMA Band II (RMC 12.2Kbps)		Limit Note 2.
		Deviation (ppm)	Deviation (Hz)	Result
70	Normal Voltage	0.0021	11	PASS
40	Normal Voltage	0.0011	9	
30	Normal Voltage	0.0005	6	
20(Ref.)	Normal Voltage	0.0000	7	
10	Normal Voltage	0.0005	6	
0	Normal Voltage	0.0016	4	
-10	Normal Voltage	0.0016	4	
-20	Normal Voltage	0.0005	6	
-30	Normal Voltage	0.0005	8	
20	Maximum Voltage	0.0005	8	
20	Normal Voltage	0.0000	7	
20	Battery End Point	0.0000	7	

Note:

1. Normal Voltage = 3.3V. ; Battery End Point (BEP) = 3.135 V. ; Maximum Voltage =3.63 V
2. The frequency fundamental emissions stay within the authorized frequency block based on the frequency deviation measured is small.



Test Conditions	Middle Channel	WCDMA Band IV (RMC 12.2Kbps)		Limit Note 2.
Temperature (°C)	Voltage (Volt)	Deviation (ppm)	Deviation (Hz)	Result
70	Normal Voltage	0.0006	8	PASS
40	Normal Voltage	0.0040	16	
30	Normal Voltage	0.0006	8	
20(Ref.)	Normal Voltage	0.0000	9	
10	Normal Voltage	0.0110	-10	
0	Normal Voltage	0.0139	-15	
-10	Normal Voltage	0.0115	-11	
-20	Normal Voltage	0.0110	-10	
-30	Normal Voltage	0.0017	12	
20	Maximum Voltage	0.0012	7	
20	Normal Voltage	0.0000	9	
20	Battery End Point	0.0017	6	

Note:

1. Normal Voltage = 3.3V. ; Battery End Point (BEP) = 3.135 V. ; Maximum Voltage =3.63 V
2. The frequency fundamental emissions stay within the authorized frequency block.



Appendix B. Test Results of Radiated Test

WCDMA 850

WCDMA 850									
Channel	Frequency (MHz)	ERP (dBm)	Limit (dBm)	Margin (dB)	SPA Reading (dBm)	S.G. Power (dBm)	TX Cable loss (dB)	TX Antenna Gain (dBi)	Polarization (H/V)
Lowest	1653	-62.70	-13	-49.70	-73.13	-66.18	3.89	9.52	H
	2479	-59.35	-13	-46.35	-74.04	-62.95	4.81	10.56	H
	3306	-57.55	-13	-44.55	-74.47	-62.06	5.56	12.22	H
									H
									H
									H
									H
	1653	-62.04	-13	-49.04	-72.59	-65.52	3.89	9.52	V
	2479	-59.06	-13	-46.06	-74.12	-62.66	4.81	10.56	V
	3306	-57.48	-13	-44.48	-74.88	-61.99	5.56	12.22	V
									V
									V
									V
									V
Middle	1673	-62.71	-13	-49.71	-73.23	-66.29	3.91	9.64	H
	2509	-59.49	-13	-46.49	-74.16	-63.16	4.84	10.65	H
	3346	-57.71	-13	-44.71	-74.57	-62.35	5.60	12.38	H
									H
									H
									H
									H
	1673	-62.44	-13	-49.44	-73.08	-66.02	3.91	9.64	V
	2509	-58.61	-13	-45.61	-73.69	-62.28	4.84	10.65	V
	3346	-57.49	-13	-44.49	-74.85	-62.13	5.60	12.38	V
									V
									V
									V
									V



Highest	1693	-62.34	-13	-49.34	-72.96	-66.01	3.93	9.76	H
	2540	-59.16	-13	-46.16	-73.9	-62.98	4.87	10.84	H
	3386	-58.05	-13	-45.05	-74.86	-62.74	5.64	12.47	H
									H
									H
									H
									H
	1693	-62.25	-13	-49.25	-72.99	-65.92	3.93	9.76	V
	2540	-59.18	-13	-46.18	-74.2	-63	4.87	10.84	V
	3386	-57.49	-13	-44.49	-74.82	-62.18	5.64	12.47	V
									V
									V
									V
									V

Remark: Spurious emissions within 30-1000MHz were found more than 20dB below limit line.



WCDMA 1700

WCDMA 1700									
Channel	Frequency (MHz)	EIRP (dBm)	Limit (dBm)	Margin (dB)	SPA Reading (dBm)	S.G. Power (dBm)	TX Cable loss (dB)	TX Antenna Gain (dBi)	Polarization (H/V)
Lowest	3424	-57.29	-13	-44.29	-75.11	-64.12	5.67	12.50	H
	5137	-54.88	-13	-41.88	-77.37	-59.81	7.55	12.47	H
	6849	-49.97	-13	-36.97	-78.49	-53.73	8.44	12.20	H
									H
									H
									H
									H
	3424	-57.03	-13	-44.03	-75.32	-63.86	5.67	12.50	V
	5137	-54.85	-13	-41.85	-77.34	-59.78	7.55	12.47	V
	6849	-49.47	-13	-36.47	-77.98	-53.23	8.44	12.20	V
									V
									V
									V
									V
Middle	3465	-56.27	-13	-43.27	-74.44	-63.03	5.71	12.47	H
	5197	-54.88	-13	-41.88	-77.57	-60.18	7.57	12.88	H
	6930	-49.73	-13	-36.73	-77.89	-53.17	8.50	11.94	H
									H
									H
									H
									H
	3465	-56.42	-13	-43.42	-74.98	-63.18	5.71	12.47	V
	5197	-55.13	-13	-42.13	-77.81	-60.43	7.57	12.88	V
	6930	-49.05	-13	-36.05	-77.84	-52.49	8.50	11.94	V
									V
									V
									V
									V



Highest	3505	-56.86	-13	-43.86	-75.33	-63.49	5.74	12.37	H
	5257	-55.00	-13	-42.00	-78.07	-60.63	7.60	13.23	H
	7010	-49.45	-13	-36.45	-77.37	-52.74	8.55	11.84	H
									H
									H
									H
									H
	3505	-56.41	-13	-43.41	-75.18	-63.04	5.74	12.37	V
	5257	-55.52	-13	-42.52	-78.54	-61.15	7.60	13.23	V
	7010	-48.19	-13	-35.19	-77.24	-51.48	8.55	11.84	V
									V
									V
									V
									V

Remark: Spurious emissions within 30-1000MHz were found more than 20dB below limit line.



WCDMA 1900

WCDMA 1900									
Channel	Frequency (MHz)	EIRP (dBm)	Limit (dBm)	Margin (dB)	SPA Reading (dBm)	S.G. Power (dBm)	TX Cable loss (dB)	TX Antenna Gain (dBi)	Polarization (H/V)
Lowest	3705	-55.82	-13	-42.82	-74.41	-62.19	5.93	12.30	H
	5557	-52.66	-13	-39.66	-76.37	-58.23	7.75	13.31	H
	7410	-47.64	-13	-34.64	-77.99	-50.12	8.72	11.20	H
									H
									H
									H
									H
	3705	-54.41	-13	-41.41	-73.05	-60.78	5.93	12.30	V
	5557	-52.66	-13	-39.66	-76.69	-58.23	7.75	13.31	V
	7410	-47.59	-13	-34.59	-77.84	-50.07	8.72	11.20	V
									V
									V
									V
									V
Middle	3760	-55.72	-13	-42.72	-74.41	-62.04	5.98	12.30	H
	5640	-53.00	-13	-40.00	-76.62	-58.67	7.81	13.48	H
	7520	-47.55	-13	-34.55	-77.4	-50.06	8.77	11.28	H
									H
									H
									H
									H
	3760	-53.64	-13	-40.64	-72.42	-59.96	5.98	12.30	V
	5640	-52.54	-13	-39.54	-76.62	-58.21	7.81	13.48	V
	7520	-47.30	-13	-34.30	-77.24	-49.81	8.77	11.28	V
									V
									V
									V
									V



Highest	3815	-55.54	-13	-42.54	-74.4	-61.78	6.03	12.27	H
	5723	-52.92	-13	-39.92	-76.73	-58.45	7.88	13.41	H
	7630	-47.60	-13	-34.60	-76.95	-50.44	8.82	11.66	H
									H
									H
									H
									H
	3815	-55.04	-13	-42.04	-74.01	-61.28	6.03	12.27	V
	5723	-52.43	-13	-39.43	-76.67	-57.96	7.88	13.41	V
	7630	-46.52	-13	-33.52	-76.47	-49.36	8.82	11.66	V
									V
									V
									V
									V

Remark: Spurious emissions within 30-1000MHz were found more than 20dB below limit line.