



# FCC RADIO TEST REPORT

**FCC ID** : 2AQ68T99W368M  
**Equipment** : 5G WWAN Module  
**Brand Name** : Foxconn  
**Model Name** : T99W368M  
**Applicant** : Hon Lin Technology Co., Ltd  
11F, No.32, Jihu Rd., Neihu Dist., Taipei  
City 114, Taiwan R.O.C.  
**Manufacturer** : Hon Lin Technology Co., Ltd  
11F, No.32, Jihu Rd., Neihu Dist., Taipei  
City 114, Taiwan R.O.C.  
**Standard** : FCC 47 CFR Part 2, 27

The product was received on Jul. 01, 2022 and testing was performed from Jul. 16, 2022 to Oct. 25, 2022. We, Sporton International Inc. EMC & Wireless Communications Laboratory, would like to declare that the tested sample has been evaluated in accordance with the test procedures given in ANSI / TIA-603-E and has been in compliance with the applicable technical standards.

The test results in this report apply exclusively to the tested model / sample. Without written approval of Sporton International Inc. EMC & Wireless Communications Laboratory, the test report shall not be reproduced except in full.

*Louis Wu*

Approved by: Louis Wu

**Sporton International Inc. EMC & Wireless Communications Laboratory**

No. 52, Huaya 1st Rd., Guishan Dist., Taoyuan City 333, Taiwan (R.O.C.)



# Table of Contents

**History of this test report..... 3**

**Summary of Test Result..... 4**

**1 General Description ..... 5**

    1.1 Product Feature of Equipment Under Test..... 5

    1.2 Modification of EUT ..... 5

    1.3 Testing Location ..... 6

    1.4 Applicable Standards..... 6

**2 Test Configuration of Equipment Under Test ..... 7**

    2.1 Test Mode..... 7

    2.2 Connection Diagram of Test System..... 8

    2.3 Support Unit used in test configuration and system ..... 8

    2.4 Measurement Results Explanation Example..... 9

    2.5 Frequency List of Low/Middle/High Channels ..... 10

**3 Conducted Test Items..... 12**

    3.1 Measuring Instruments ..... 12

    3.2 Conducted Output Power and EIRP ..... 13

    3.3 Peak-to-Average Ratio ..... 14

    3.4 Occupied Bandwidth..... 15

    3.5 Conducted Band Edge ..... 16

    3.6 Conducted Spurious Emission ..... 17

    3.7 Frequency Stability ..... 18

**4 Radiated Test Items ..... 19**

    4.1 Measuring Instruments ..... 19

    4.2 Radiated Spurious Emission Measurement ..... 21

**5 List of Measuring Equipment..... 22**

**6 Uncertainty of Evaluation..... 23**

**Appendix A. Test Results of Conducted Test**

**Appendix B. Test Results of Radiated Test**

**Appendix C. Test Setup Photographs**



### History of this test report

Report No.	Version	Description	Issued Date
FG262904I	01	Initial issue of report	Oct. 28, 2022



### Summary of Test Result

Report Clause	Ref Std. Clause	Test Items	Result (PASS/FAIL)	Remark
3.2	§2.1046	Conducted Output Power	Reporting only	-
	§27.50 (k)(3)	Equivalent Isotropic Radiated Power (n77) (n78)	Pass	
3.3	§27.50 (k)(4)	Peak-to-Average Ratio	Pass	-
3.4	§2.1049	Occupied Bandwidth	Reporting only	-
3.5	§2.1051 §27.53 (n)(2)	Conducted Band Edge Measurement (n77) (n78)	Pass	-
3.6	§2.1051 §27.53 (n)(2)	Conducted Spurious Emission (n77) (n78)	Pass	-
3.7	§2.1055 §27.54	Frequency Stability Temperature & Voltage	Pass	-
4.2	§2.1053 §27.53 (n)(2)	Radiated Spurious Emission (n77) (n78)	Pass	Under limit 15.86 dB at 13806.000 MHz

**Declaration of Conformity:**

- The test results (PASS/FAIL) with all measurement uncertainty excluded are presented in accordance with the regulation limits or requirements declared by manufacturers. It's means measurement values may risk exceeding the limit of regulation standards, if measurement uncertainty is include in test results.
- The measurement uncertainty please refer to this report "Uncertainty of Evaluation".

**Comments and Explanations:**

The product specifications of the EUT presented in the report are declared by the manufacturer who shall take full responsibility for the authenticity.

**Reviewed by: Keven Cheng**

**Report Producer: Michelle Chen**



# 1 General Description

## 1.1 Product Feature of Equipment Under Test

WCDMA/LTE/5G NR and GNSS

The following antennas were provided to the EUT

	Band	Brand	Model	Antenna Type	RF Exposure Max Antenna Gain(dBi)
5G NR	n77 (3450~3550MHz)	WHA YU	C107-511725-A	PCB	3
	n78 (3450~3550MHz)	WHA YU	C107-511725-A	PCB	3

**Remark:** The above EUT's information was declared by manufacturer and used for Radiated Spurious Emission test.

There are three different HW of T99W368M.

Brand	Model	HW
Foxconn	T99W368M	1. WCDMA+LTE+Sub6+mmWave+eSIM
		2. WCDMA+LTE+Sub6+mmWave w/o eSIM
		3. WCDMA+LTE+Sub6+mmWave +FPC connector on bottom w/o eSIM

**Note:** All the tests were performed with Sample 1.

## 1.2 Modification of EUT

No modifications are made to the EUT during all test items.



### 1.3 Testing Location

<b>Test Site</b>	Sporton International Inc. EMC & Wireless Communications Laboratory
<b>Test Site Location</b>	No.52, Huaya 1st Rd., Guishan Dist., Taoyuan City 333, Taiwan (R.O.C.) TEL: +886-3-327-3456 FAX: +886-3-328-4978
<b>Test Site No.</b>	<b>Sporton Site No.</b> TH03-HY
<b>Test Engineer</b>	Peter Liao, Nina Cheng and Luffy Lin
<b>Temperature</b>	23.5~24.1
<b>Relative Humidity</b>	48~52

<b>Test Site</b>	Sporton International Inc. Wensan Laboratory.
<b>Test Site Location</b>	No.58, Aly. 75, Ln. 564, Wenhua 3rd, Rd., Guishan Dist., Taoyuan City 333010, Taiwan (R.O.C.) TEL: +886-3-327-0868 FAX: +886-3-327-0855
<b>Test Site No.</b>	<b>Sporton Site No.</b> 03CH12-HY (TAF Code: 3786)
<b>Test Engineer</b>	Jack Cheng, Tim Lee and Wilson Wu
<b>Temperature</b>	20~25
<b>Relative Humidity</b>	50~60
<b>Remark</b>	The Radiated Spurious Emission test item subcontracted to Sporton International Inc. Wensan Laboratory.

**Note:** The test site complies with ANSI C63.4 2014 requirement.

FCC Designation No.: TW1190 and TW3786

### 1.4 Applicable Standards

According to the specifications of the manufacturer, the EUT must comply with the requirements of the following standards:

- ♦ ANSI C63.26-2015
- ♦ ANSI / TIA-603-E
- ♦ FCC 47 CFR Part 2, 27
- ♦ FCC KDB 971168 D01 Power Meas. License Digital Systems v03r01
- ♦ FCC KDB 412172 D01 Determining ERP and EIRP v01r01
- ♦ FCC KDB 414788 D01 Radiated Test Site v01r01.
- ♦ FCC KDB 662911 D01 Multiple Transmitter Output v02r01.

**Remark:**

1. All test items were verified and recorded according to the standards and without any deviation during the test.
2. This EUT has also been tested and complied with the requirements of FCC Part 15, Subpart B, recorded in a separate test report.
3. The TAF code is not including all the FCC KDB listed without accreditation.



## 2 Test Configuration of Equipment Under Test

### 2.1 Test Mode

Antenna port conducted and radiated test items listed below are performed according to KDB 971168 D01 Power Meas. License Digital Systems v03r01 with maximum output power.

For radiated measurement, the measured emission level of the EUT was maximized by rotating the EUT on a turntable, adjusting the orientation of the EUT and EUT antenna in three orthogonal axis (X: flat, Y: portrait, Z: landscape), and adjusting the measurement antenna orientation, following C63.26 exploratory test procedures and only the worst case emissions were reported in this report..

Test Items	NR Band	Bandwidth (MHz)												Modulation					RB #			Test Channel			
		10	15	20	25	30	40	50	60	70	80	90	100	PI/2 BPSK	QPSK	16QAM	64QAM	256QAM	1	Half	Full	L	M	H	
Max. Output Power	n77	v	v	v	-	v	v	v	v	v	v	v	v	v	v	v	v	v	v	v	v	v	v	v	v
	n78	v	v	v	-	v	v	v	v	v	v	v	v	v	v	v	v	v	v	v	v	v	v	v	v
Peak-to-Average Ratio	n77			v	-									v	v	v	v	v			v		v		
	n78	Covered by 5G NR n77																							
26dB and 99% Bandwidth	n77	v	v	v	-	v	v	v	v	v	v	v	v	v	v	v	v	v			v		v		
	n78	Covered by 5G NR n77																							
Conducted Band Edge	n77	v	v	v	-	v	v	v	v	v	v	v	v	v	v	v	v	v	v		v	v		v	
	n78	Covered by 5G NR n77																							
Conducted Spurious Emission	n77	v	-	-	-										v					v			v	v	v
	n78	Covered by 5G NR n77																							
Frequency Stability	n77			v	-									v							v		v		
	n78	Covered by 5G NR n77																							
E.I.R.P	n77	v	v	v	-	v	v	v	v	v	v	v	v	v	v	v	v	v		Max. Power					
	n78	v	v	v	-	v	v	v	v	v	v	v	v	v	v	v	v	v							
Radiated Spurious Emission	n77	Worst Case																				v	v	v	
	n78	Covered by 5G NR n77																							
Remark	<ol style="list-style-type: none"> <li>The mark "v" means that this configuration is chosen for testing</li> <li>The mark "-" means that this bandwidth is not supported.</li> <li>The device is investigated from 30MHz to 10 times of fundamental signal for radiated spurious emission test under different RB size/offset and modulations in exploratory test. Subsequently, only the worst case emissions are reported.</li> <li>For radiated measurement, pre-scanned in two modes, DFT-s OFDM and CP OFDM. The worst cases (DFT-s OFDM) were recorded in this report, and the worst modes of FR1 and LTE for simultaneous transmission were verified and compliant.</li> <li>One representative bandwidth is selected to perform PAR and frequency stability.</li> <li>Wider operating range bandwidth covers narrower one when the power is higher or the same.</li> </ol>																								

## 2.2 Connection Diagram of Test System

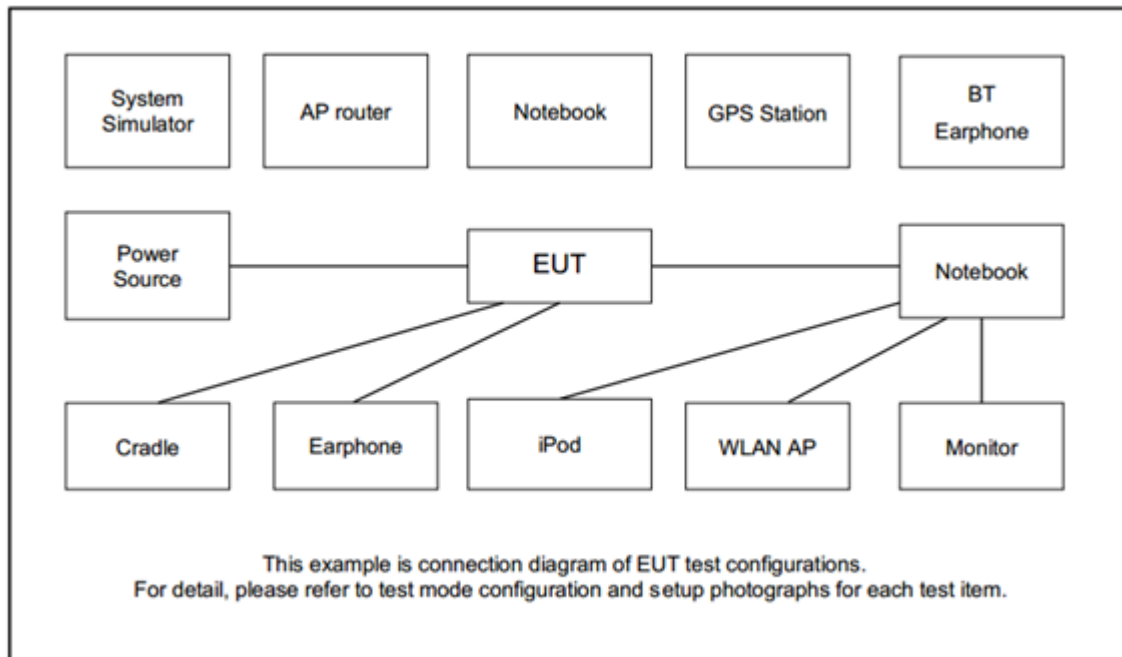

## 2.3 Support Unit used in test configuration and system

Item	Equipment	Brand Name	Model No.	FCC ID	Data Cable	Power Cord
1.	System Simulator	Anritsu	MT8821C	N/A	N/A	Unshielded, 1.8 m
2.	System Simulator	Anritsu	MT8000A	N/A	N/A	Unshielded, 1.8 m
3.	Notebook	Dell	E3340	N/A	N/A	AC I/P: Unshielded, 1.2 m DC O/P: Shielded, 1.8 m
4.	Fixture	Foxconn	95.2580T00	N/A	N/A	N/A





## 2.4 Measurement Results Explanation Example

### For all conducted test items:

The offset level is set in the spectrum analyzer to compensate the RF cable loss and attenuator factor between EUT conducted output port and spectrum analyzer. With the offset compensation, the spectrum analyzer reading level is exactly the EUT RF output level.

The spectrum analyzer offset is derived from RF cable loss and attenuator factor.

*Offset = RF cable loss + attenuator factor.*

Following shows an offset computation example with cable loss 4.2 dB and 10dB attenuator.

Example :

$$\begin{aligned} \text{Offset(dB)} &= \text{RF cable loss(dB)} + \text{attenuator factor(dB)}. \\ &= 4.2 + 10 = 14.2 \text{ (dB)} \end{aligned}$$



### 2.5 Frequency List of Low/Middle/High Channels

5G NR Band n77 Channel and Frequency List				
BW [MHz]	Channel/Frequency(MHz)	Lowest	Middle	Highest
100	Channel	-	633334	-
	Frequency	-	3500.01	-
90	Channel	633000	633334	633666
	Frequency	3495	3500.01	3504.99
80	Channel	632668	633334	634000
	Frequency	3490.02	3500.01	3510
70	Channel	632334	633334	634332
	Frequency	3485.01	3500.01	3514.98
60	Channel	632000	633334	634666
	Frequency	3480	3500.01	3519.99
50	Channel	631668	633334	635000
	Frequency	3475.02	3500.01	3525
40	Channel	631334	633334	635332
	Frequency	3470.01	3500.01	3529.98
30	Channel	631000	633334	635666
	Frequency	3465	3500.01	3534.99
20	Channel	630668	633334	636000
	Frequency	3460.02	3500.01	3540
15	Channel	630500	633334	636166
	Frequency	3457.5	3500.01	3542.49
10	Channel	630334	633334	636332
	Frequency	3455.01	3500.01	3544.98



5G NR Band n78 Channel and Frequency List				
BW [MHz]	Channel/Frequency(MHz)	Lowest	Middle	Highest
100	Channel	-	633334	-
	Frequency	-	3500.01	-
90	Channel	633000	633334	633666
	Frequency	3495	3500.01	3504.99
80	Channel	632668	633334	634000
	Frequency	3490.02	3500.01	3510
70	Channel	632334	633334	634332
	Frequency	3485.01	3500.01	3514.98
60	Channel	632000	633334	634666
	Frequency	3480	3500.01	3519.99
50	Channel	631668	633334	635000
	Frequency	3475.02	3500.01	3525
40	Channel	631334	633334	635332
	Frequency	3470.01	3500.01	3529.98
30	Channel	631000	633334	635666
	Frequency	3465	3500.01	3534.99
20	Channel	630668	633334	636000
	Frequency	3460.02	3500.01	3540
15	Channel	630500	633334	636166
	Frequency	3457.5	3500.01	3542.49
10	Channel	630334	633334	636332
	Frequency	3455.01	3500.01	3544.98

### 3 Conducted Test Items

#### 3.1 Measuring Instruments

See list of measuring instruments of this test report.

##### 3.1.1 Test Setup

##### 3.1.2 Conducted Output Power



##### 3.1.3 Peak-to-Average Ratio, Occupied Bandwidth ,Conducted Band-Edge and Conducted Spurious Emission

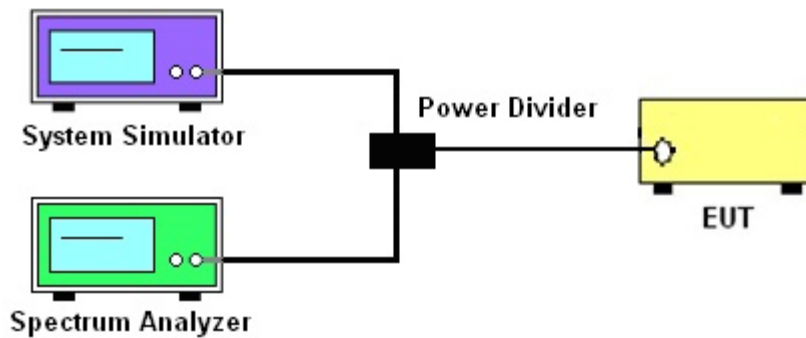

##### 3.1.4 Frequency Stability



##### 3.1.5 Test Result of Conducted Test

Please refer to Appendix A.



## **3.2 Conducted Output Power and EIRP**

### **3.2.1 Description of the Conducted Output Power Measurement and EIRP Measurement**

A system simulator was used to establish communication with the EUT. Its parameters were set to force the EUT transmitting at maximum output power. The measured power in the radio frequency on the transmitter output terminals shall be reported.

The EIRP of mobile transmitters must not exceed 1 Watts for 5G NR n77 and n78.

According to KDB 412172 D01 Power Approach,

$EIRP = P_T + G_T - L_C$ ,  $ERP = EIRP - 2.15$ , where

$P_T$  = transmitter output power in dBm

$G_T$  = gain of the transmitting antenna in dBi

$L_C$  = signal attenuation in the connecting cable between the transmitter and antenna in dB

### **3.2.2 Test Procedures**

1. The transmitter output port was connected to the system simulator.
2. Set EUT at maximum power through the system simulator.
3. Select lowest, middle, and highest channels for each band and different modulation.
4. Measure and record the power level from the system simulator.
5. The MIMO mode is completely uncorrelated, so the directional gain is selected the maximum gain among all antennas.



### **3.3 Peak-to-Average Ratio**

#### **3.3.1 Description of the PAR Measurement**

Power Complementary Cumulative Distribution Function (CCDF) curves provide a means for characterizing the power peaks of a digitally modulated signal on a statistical basis. A CCDF curve depicts the probability of the peak signal amplitude exceeding the average power level. Most contemporary measurement instrumentation include the capability to produce CCDF curves for an input signal provided that the instrument's resolution bandwidth can be set wide enough to accommodate the entire input signal bandwidth. In measuring transmissions in this band using an average power technique, the peak-to-average ratio (PAR) of the transmission may not exceed 13 dB.

#### **3.3.2 Test Procedures**

The testing follows ANSI C63.26-2015 Section 5.2.6

1. The EUT was connected to spectrum and system simulator via a power divider.
2. Set the CCDF (Complementary Cumulative Distribution Function) option in spectrum analyzer.
3. The highest RF powers were measured and recorded the maximum PAPR level associated with a probability of 0.1 %.
4. Record the deviation as Peak to Average Ratio.



## 3.4 Occupied Bandwidth

### 3.4.1 Description of Occupied Bandwidth Measurement

The occupied bandwidth is the width of a frequency band such that, below the lower and above the upper frequency limits, the mean powers emitted are each equal to a specified percentage 0.5% of the total mean transmitted power.

The 26 dB emission bandwidth is defined as the frequency range between two points, one above and one below the carrier frequency, at which the spectral density of the emission is attenuated 26 dB below the maximum in-band spectral density of the modulated signal. Spectral density (power per unit bandwidth) is to be measured with a detector of resolution bandwidth equal to approximately 1.0% of the emission bandwidth.

### 3.4.2 Test Procedures

The testing follows ANSI C63.26-2015 Section 5.4.3 (26dB) and Section 5.4.4 (99OB)

1. The EUT was connected to spectrum analyzer and system simulator via a power divider.
2. The spectrum analyzer center frequency is set to the nominal EUT channel center frequency. The span range for the spectrum analyzer shall be between two and five times the anticipated OBW.
3. The nominal resolution bandwidth (RBW) shall be in the range of 1 to 5 % of the anticipated OBW, and the VBW shall be at least 3 times the RBW.
4. Set the detection mode to peak, and the trace mode to max hold.
5. Determine the reference value: Set the EUT to transmit a modulated signal. Allow the trace to stabilize. Set the spectrum analyzer marker to the highest level of the displayed trace.  
(this is the reference value)
6. Determine the “-26 dB down amplitude” as equal to (Reference Value – X).
7. Place two markers, one at the lowest and the other at the highest frequency of the envelope of the spectral display such that each marker is at or slightly below the “-X dB down amplitude” determined in step 6. If a marker is below this “-X dB down amplitude” value it shall be placed as close as possible to this value. The OBW is the positive frequency difference between the two markers.
8. Use the 99 % power bandwidth function of the spectrum analyzer and report the measured bandwidth.



### **3.5 Conducted Band Edge**

#### **3.5.1 Description of Conducted Band Edge Measurement**

27.53 (n)(2)

(2) For mobile operations in the 3450-3550 MHz band, the conducted power of any emission outside the licensee's authorized bandwidth shall not exceed  $-13$  dBm/MHz. Compliance with this paragraph (n)(2) is based on the use of measurement instrumentation employing a resolution bandwidth of 1 megahertz or greater. However, in the 1 megahertz bands immediately outside and adjacent to the licensee's frequency block, a resolution bandwidth of at least one percent of the emission bandwidth of the fundamental emission of the transmitter may be employed, but limited to a maximum of 200 kHz. In the bands between 1 and 5 MHz removed from the licensee's frequency block, the minimum resolution bandwidth for the measurement shall be 500 kHz. The emission bandwidth is defined as the width of the signal between two points, one below the carrier center frequency and one above the carrier center frequency, outside of which all emissions are attenuated at least 26 dB below the transmitter power.

#### **3.5.2 Test Procedures**

The testing follows FCC KDB 971168 D01 v03r01 Section 6.1.

1. The EUT was connected to spectrum analyzer and system simulator via a power divider.
2. The band edges of low and high channels for the highest RF powers were measured.
3. For  $EBW < 20\text{MHz}$ , set  $RBW \geq 1\%$  EBW in the 1MHz band immediately outside and adjacent to the band edge.
4. For  $EBW \geq 20\text{MHz}$ , set  $RBW = 200\text{kHz}$  in the 1MHz band immediately outside and adjacent to the band edge.
5. Between 1 ~5 MHz from the band edge,  $RBW=500$  kHz was used.
6. Set spectrum analyzer with RMS detector.
7. The RF fundamental frequency should be excluded against the limit line in the operating frequency band.
8. Checked that all the results comply with the emission limit line.  
The limit line is derived from  $43 + 10\log(P)\text{dB}$  below the transmitter power P(Watts)
9. For MIMO mode, add additional MIMO factor  $10\log(\text{NTX}=2) = 3.01\text{dB}$  into the spectrum analyzer offset.





## **3.6 Conducted Spurious Emission**

### **3.6.1 Description of Conducted Spurious Emission Measurement**

The power of any emission outside of the authorized operating frequency ranges must be lower than the transmitter power (P) by a factor of at least  $43 + 10 \log (P)$  dB.

It is measured by means of a calibrated spectrum analyzer and scanned from 30 MHz up to a frequency including its 10<sup>th</sup> harmonic.

### **3.6.2 Test Procedures**

The testing follows FCC KDB 971168 D01 v03r01 Section 6.1.

1. The EUT was connected to spectrum analyzer and system simulator via a power divider.
2. The RF output of EUT was connected to the spectrum analyzer by RF cable and attenuator. The path loss was compensated to the results for each measurement.
3. The middle channel for the highest RF power within the transmitting frequency was measured.
4. The conducted spurious emission for the whole frequency range was taken.
5. Make the measurement with the spectrum analyzer's RBW = 1MHz, VBW = 3MHz.
6. Set spectrum analyzer with RMS detector.
7. Taking the record of maximum spurious emission.
8. The RF fundamental frequency should be excluded against the limit line in the operating frequency band.
9. The limit line is derived from  $43 + 10\log(P)$ dB below the transmitter power P(Watts)
10. For MIMO mode, add additional MIMO factor  $10\log(\text{NTX}=2) = 3.01\text{dB}$  into the spectrum analyzer offset.



## **3.7 Frequency Stability**

### **3.7.1 Description of Frequency Stability Measurement**

27.54

The frequency stability shall be sufficient to ensure that the fundamental emission stays within the authorized frequency block.

### **3.7.2 Test Procedures for Temperature Variation**

The testing follows FCC KDB 971168 D01 v03r01 Section 9.0.

1. The EUT was set up in the thermal chamber and connected with the system simulator.
2. With power OFF, the temperature was decreased to -30°C and the EUT was stabilized before testing. Power was applied and the maximum change in frequency was recorded within one minute.
3. With power OFF, the temperature was raised in 10°C step up to 50°C. The EUT was stabilized at each step for at least half an hour. Power was applied and the maximum frequency change was recorded within one minute.

### **3.7.3 Test Procedures for Voltage Variation**

The testing follows FCC KDB 971168 D01 v03r01 Section 9.0.

1. The EUT was placed in a temperature chamber at 20±5° C and connected with the system simulator.
2. The power supply voltage to the EUT was varied from 85% to 115% of the nominal value measured at the input to the EUT.
3. The variation in frequency was measured for the worst case.

## 4 Radiated Test Items

### 4.1 Measuring Instruments

See list of measuring instruments of this test report.

#### 4.1.1 Test Setup

For radiated test below 30MHz



For radiated test from 30MHz to 1GHz



For radiated test from 1GHz to 18GHz

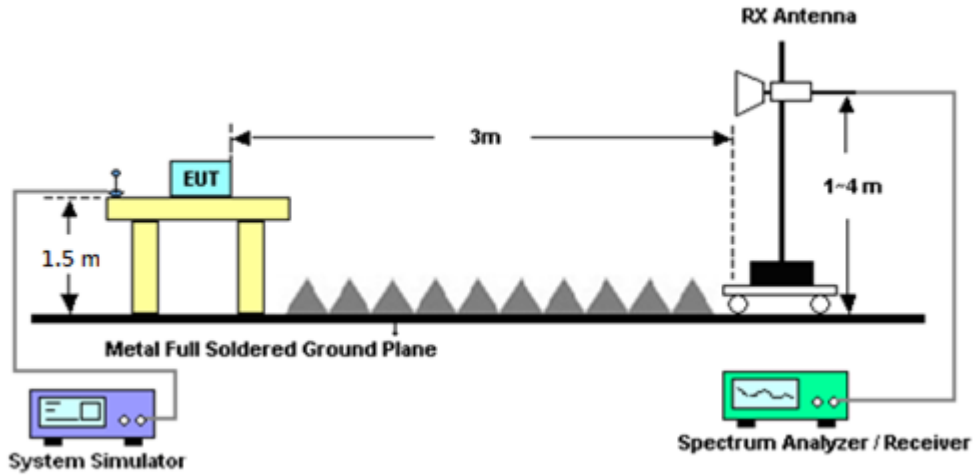

For radiated test above 18GHz

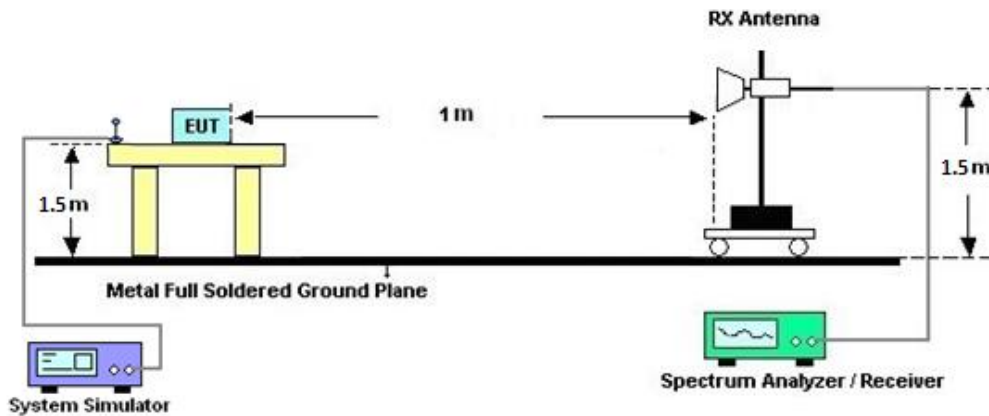

### 4.1.2 Test Result of Radiated Test

Please refer to Appendix B.

**Note:**

The low frequency, which started from 9 kHz to 30MHz, was pre-scanned and the result which was 20dB lower than the limit line was not reported.

There is adequate comparison measurement of both open-field test site and alternative test site - semi-Anechoic chamber according to 414788 D01 Radiated Test Site v01r01, and the result came out very similar.



## 4.2 Radiated Spurious Emission Measurement

### 4.2.1 Description of Radiated Spurious Emission Measurement

The radiated spurious emission was measured by substitution method according to ANSI / TIA-603-E. The power of any emission outside of the authorized operating frequency ranges must be attenuated below the transmitter power (P) by a factor of at least  $43 + 10 \log (P)$  dB.

The spectrum is scanned from 30 MHz up to a frequency including its 10th harmonic.

### 4.2.2 Test Procedures

The testing follows FCC KDB 971168 D01 v03r01 Section 7 and ANSI / TIA-603-E Section 2.2.12.

1. The EUT was placed on a turntable with 0.8 meter for frequency below 1GHz and 1.5 meter for frequency above 1GHz respectively above ground.
2. The EUT was set 3 meters from the receiving antenna, which was mounted on the antenna tower.
3. The table was rotated 360 degrees to determine the position of the highest spurious emission.
4. The height of the receiving antenna is varied between one meter and four meters to search the maximum spurious emission for both horizontal and vertical polarizations.
5. Make the measurement with the spectrum analyzer's RBW = 1MHz, VBW = 3MHz, taking the record of maximum spurious emission.
6. A horn antenna was substituted in place of the EUT and was driven by a signal generator.
7. Tune the output power of signal generator to the same emission level with EUT maximum spurious emission.
8. Taking the record of output power at antenna port.
9. Repeat step 7 to step 8 for another polarization.
10. The RF fundamental frequency should be excluded against the limit line in the operating frequency band.

The limit line is derived from  $43 + 10\log(P)$ dB below the transmitter power P(Watts)

$EIRP \text{ (dBm)} = S.G. \text{ Power} - Tx \text{ Cable Loss} + Tx \text{ Antenna Gain}$

$ERP \text{ (dBm)} = EIRP - 2.15$



## 5 List of Measuring Equipment

Instrument	Brand Name	Model No.	Serial No.	Characteristics	Calibration Date	Test Date	Due Date	Remark
Programmable Power Supply	GW Instek	PSS-2005	EL883644	50Hz~60Hz	Dec. 03, 2021	Jul. 28, 2022~ Oct. 25, 2022	Dec. 02, 2023	Conducted (TH03-HY)
Hygrometer	Testo	608-H11	34893240	NA	Nov. 17, 2021	Jul. 28, 2022~ Oct. 25, 2022	Nov. 16, 2022	Conducted (TH03-HY)
Signal Analyzer	Rohde & Schwarz	FSV3044	101048	10Hz~44GHz	May 05, 2022	Jul. 28, 2022~ Oct. 25, 2022	May 04, 2023	Conducted (TH03-HY)
Temperature Chamber	ESPEC	SH-641	92013720	-40°C ~90°C	Sep. 09, 2021	Jul. 28, 2022~ Sep. 07, 2022	Sep. 08, 2022	Conducted (TH03-HY)
Temperature Chamber	ESPEC	SH-641	92013720	-40°C ~90°C	Sep. 07, 2022	Sep. 08, 2022~ Oct. 25, 2022	Sep. 06, 2023	Conducted (TH03-HY)
System Simulator	Anritsu	MT8821C	6262116730	LTE	Jun. 15, 2021	Jul. 28, 2022~ Oct. 25, 2022	Jun. 14, 2023	Conducted (TH03-HY)
System Simulator	Anritsu	MT8000A	6261940327	FR1	Oct. 29, 2021	Jul. 28, 2022~ Oct. 25, 2022	Oct. 28, 2022	Conducted (TH03-HY)
Loop Antenna	Rohde & Schwarz	HFH2-Z2	100488	9 kHz~30 MHz	May 13, 2022	Jul. 16, 2022~ Sep. 06, 2022	May 12, 2023	Radiation (03CH12-HY)
Bilog Antenna	TESEQ	CBL 6111D & 00800N1D01N -06	37059 & 01	30MHz~1GHz	Oct. 09, 2021	Jul. 16, 2022~ Sep. 06, 2022	Oct. 08, 2022	Radiation (03CH12-HY)
Bilog Antenna	TESEQ	CBL 6111D & N-6-06	35414 & AT-N0602	30MHz~1GHz	Oct. 09, 2021	Jul. 16, 2022~ Sep. 06, 2022	Oct. 08, 2022	Radiation (03CH12-HY)
Horn Antenna	SCHWARZBE CK	BBHA 9120 D	9120D-1328	1GHz~18GHz	Dec. 03, 2021	Jul. 16, 2022~ Sep. 06, 2022	Dec. 02, 2022	Radiation (03CH12-HY)
Horn Antenna	SCHWARZBE CK	BBHA 9120 D	9120D-1212	1GHz~18GHz	Mar. 10, 2022	Jul. 16, 2022~ Sep. 06, 2022	Mar. 09, 2023	Radiation (03CH12-HY)
SHF-EHF Horn Antenna	SCHWARZBE CK	BBHA9170	00993	18GHz~40GHz	Nov. 30, 2021	Jul. 16, 2022~ Sep. 06, 2022	Nov. 29, 2022	Radiation (03CH12-HY)
SHF-EHF Horn Antenna	SCHWARZBE CK	BBHA 9170	BBHA91702 51	18GHz~40GHz	Nov. 30, 2021	Jul. 16, 2022~ Sep. 06, 2022	Nov. 29, 2022	Radiation (03CH12-HY)
Preamplifier	COM-POWER	PA-103	161075	10MHz~1GHz	Mar. 23, 2022	Jul. 16, 2022~ Sep. 06, 2022	Mar. 22, 2023	Radiation (03CH12-HY)
Preamplifier	Aglient	8449B	3008A02375	1GHz~26.5GHz	May 24, 2022	Jul. 16, 2022~ Sep. 06, 2022	May 23, 2023	Radiation (03CH12-HY)
Preamplifier	E-INSTRUME NT TECH LTD.	ERA-100M-18 G-56-01-A70	EC1900249	1GHz-18GHz	Dec. 22, 2021	Jul. 16, 2022~ Sep. 06, 2022	Dec. 21, 2022	Radiation (03CH12-HY)
Preamplifier	EMEC	EM18G40G	060715	18GHz~40GHz	Dec. 24, 2021	Jul. 16, 2022~ Sep. 06, 2022	Dec. 23, 2022	Radiation (03CH12-HY)
Spectrum Analyzer	Agilent	N9010A	MY53470118	10Hz~44GHz	Jan. 12, 2022	Jul. 16, 2022~ Sep. 06, 2022	Jan. 11, 2023	Radiation (03CH12-HY)
Filter	Wainwright	WLKS1200-12 SS	SN2	1.2GHz Low Pass Filter	Mar. 15, 2022	Jul. 16, 2022~ Sep. 06, 2022	Mar. 14, 2023	Radiation (03CH12-HY)
Filter	Wainwright	WHKX8-5872. 5-6750-18000- 40ST	SN2	6.75GHz High Pass Filter	Mar. 16, 2022	Jul. 16, 2022~ Sep. 06, 2022	Mar. 15, 2023	Radiation (03CH12-HY)
RF Cable	HUBER + SUHNER	SUCOFLEX 104	MY9837/4PE	9kHz~30MHz	Mar. 10, 2022	Jul. 16, 2022~ Sep. 06, 2022	Mar. 09, 2023	Radiation (03CH12-HY)
RF Cable	HUBER + SUHNER	SUCOFLEX 126E	0058/126E	30MHz~18GHz	Dec. 10, 2021	Jul. 16, 2022~ Sep. 06, 2022	Dec. 09, 2022	Radiation (03CH12-HY)
RF Cable	HUBER + SUHNER	SUCOFLEX 102	505134/2	30MHz~40GHz	Feb. 21, 2022	Jul. 16, 2022~ Sep. 06, 2022	Feb. 20, 2023	Radiation (03CH12-HY)
RF Cable	HUBER + SUHNER	SUCOFLEX 102	803953/2	30MHz~40GHz	Mar. 08, 2022	Jul. 16, 2022~ Sep. 06, 2022	Mar. 07, 2023	Radiation (03CH12-HY)
Hygrometer	TECPEL	DTM-303B	TP140349	N/A	Sep. 30, 2021	Jul. 16, 2022~ Sep. 06, 2022	Sep. 29, 2022	Radiation (03CH12-HY)
Controller	EMEC	EM1000	N/A	Control Turn table & Ant Mast	N/A	Jul. 16, 2022~ Sep. 06, 2022	N/A	Radiation (03CH12-HY)
Antenna Mast	EMEC	AM-BS-4500-B	N/A	1m~4m	N/A	Jul. 16, 2022~ Sep. 06, 2022	N/A	Radiation (03CH12-HY)
Turn Table	EMEC	TT2000	N/A	0~360 Degree	N/A	Jul. 16, 2022~ Sep. 06, 2022	N/A	Radiation (03CH12-HY)



## 6 Uncertainty of Evaluation

### Uncertainty of Radiated Emission Measurement (30 MHz ~ 1000 MHz)

Measuring Uncertainty for a Level of Confidence of 95% ( $U = 2Uc(y)$ )	3.31 dB
---	---------

### Uncertainty of Radiated Emission Measurement (1 GHz ~ 18 GHz)

Measuring Uncertainty for a Level of Confidence of 95% ( $U = 2Uc(y)$ )	3.25 dB
---	---------

### Uncertainty of Radiated Emission Measurement (18 GHz ~ 40 GHz)

Measuring Uncertainty for a Level of Confidence of 95% ( $U = 2Uc(y)$ )	3.81 dB
---	---------



## Appendix A. Test Results of Conducted Test

### Conducted Output Power(Average power) and EIRP

<SISO Mode>

NR n77 Maximum Average Power [dBm] (GT - LC = 3 dB)								
BW [MHz]	RB Size	RB Offset	Mod	Lowest	Middle	Highest	EIRP (dBm)	EIRP(W)
10	1	1	PI/2 BPSK	26.20	26.53	26.67	29.78	0.9506
10	1	22		26.15	26.46	26.74		
10	12	6		26.23	26.55	26.78		
10	1	0		22.75	23.07	23.20		
10	1	23		22.62	22.93	23.23		
10	24	0		25.74	26.08	26.31		
10	1	1	QPSK	26.16	26.46	26.64		
10	1	22		26.13	26.41	26.71		
10	12	6		26.21	26.52	22.76		
10	1	0		22.69	23.01	23.17		
10	1	23		22.60	22.89	23.20		
10	24	0		25.22	25.56	25.78		
10	1	1	16-QAM	25.36	25.62	25.74	28.74	0.7482
10	1	1	64-QAM	23.78	24.13	24.30		
10	1	1	256-QAM	21.50	21.72	21.96		
Limit	EIRP < 1W			Result			Pass	

NR n77 Maximum Average Power [dBm] (GT - LC = 3 dB)								
BW [MHz]	RB Size	RB Offset	Mod	Lowest	Middle	Highest	EIRP (dBm)	EIRP(W)
15	1	1	PI/2 BPSK	26.40	26.59	26.72	29.87	0.9705
15	1	36		26.37	26.50	26.87		
15	18	9		26.43	26.62	26.85		
15	1	0		22.94	23.13	23.28		
15	1	37		22.87	23.00	23.32		
15	36	0		25.93	26.10	26.31		
15	1	1	QPSK	26.36	26.56	26.65		
15	1	36		26.34	26.48	26.78		
15	18	9		26.41	26.58	26.82		
15	1	0		22.89	23.06	23.24		
15	1	37		22.85	22.97	23.29		
15	36	0		25.42	25.62	25.82		
15	1	1	16-QAM	25.50	25.73	25.85	28.85	0.7674
15	1	1	64-QAM	24.00	24.24	24.33		
15	1	1	256-QAM	21.66	21.82	22.06		
Limit	EIRP < 1W			Result			Pass	





NR n77 Maximum Average Power [dBm] (GT - LC = 3 dB)								
BW [MHz]	RB Size	RB Offset	Mod	Lowest	Middle	Highest	EIRP (dBm)	EIRP(W)
20	1	1	PI/2 BPSK	26.51	26.72	26.74	29.9	0.9772
20	1	49		26.48	26.51	26.90		
20	25	12		26.46	26.62	26.84		
20	1	0		23.02	23.24	23.23		
20	1	50		23.00	23.01	23.40		
20	50	0		26.00	26.13	26.35		
20	1	1	QPSK	26.48	26.65	26.69		
20	1	49		26.45	26.43	26.85		
20	25	12		26.43	26.60	26.81		
20	1	0		22.92	23.16	23.20		
20	1	50		22.90	22.95	23.33		
20	50	0		25.51	25.64	25.85		
20	1	1	16-QAM	25.69	25.86	25.70	28.86	0.7691
20	1	1	64-QAM	24.06	24.35	24.23		
20	1	1	256-QAM	21.70	21.99	21.91		
Limit	EIRP < 1W			Result			Pass	



NR n77 Maximum Average Power [dBm] (GT - LC = 3 dB)								
BW [MHz]	RB Size	RB Offset	Mod	Lowest	Middle	Highest	EIRP (dBm)	EIRP(W)
30	1	1	PI/2 BPSK	26.64	26.80	26.85	29.96	0.9908
30	1	76		26.65	26.60	26.96		
30	36	18		26.53	26.70	26.94		
30	1	0		23.12	23.28	23.35		
30	1	77		23.17	23.10	23.47		
30	75	0		26.14	26.22	26.49		
30	1	1	QPSK	26.59	26.75	26.82		
30	1	76		26.60	26.56	26.93		
30	36	18		26.50	26.68	26.92		
30	1	0		23.07	23.21	23.32		
30	1	77		23.15	23.02	23.44		
30	75	0		25.60	25.73	25.97		
30	1	1	16-QAM	25.79	25.99	26.02	29.02	0.798
30	1	1	64-QAM	24.21	24.33	24.41		
30	1	1	256-QAM	21.87	22.00	22.04		
Limit	EIRP < 1W			Result			Pass	

NR n77 Maximum Average Power [dBm] (GT - LC = 3 dB)								
BW [MHz]	RB Size	RB Offset	Mod	Lowest	Middle	Highest	EIRP (dBm)	EIRP(W)
40	1	1	PI/2 BPSK	26.73	26.86	26.80	29.95	0.9886
40	1	104		26.87	26.65	26.95		
40	50	25		26.70	26.73	26.84		
40	1	0		23.19	23.32	23.30		
40	1	105		23.41	23.21	23.49		
40	100	0		26.21	26.26	26.38		
40	1	1	QPSK	26.65	26.82	26.73		
40	1	104		26.80	26.60	26.90		
40	50	25		26.61	26.70	26.79		
40	1	0		23.13	23.30	23.23		
40	1	105		23.36	23.13	23.45		
40	100	0		25.70	25.74	25.86		
40	1	1	16-QAM	25.88	26.06	25.95	29.06	0.8054
40	1	1	64-QAM	24.24	24.42	24.37		
40	1	1	256-QAM	22.11	22.01	22.02		
Limit	EIRP < 1W			Result			Pass	



NR n77 Maximum Average Power [dBm] (GT - LC = 3 dB)										
BW [MHz]	RB Size	RB Offset	Mod	Lowest	Middle	Highest	EIRP (dBm)	EIRP(W)		
50	1	1	PI/2 BPSK	26.27	26.36	26.42	29.45	0.881		
50	1	131		26.26	26.13	26.43				
50	64	32		26.34	26.45	26.28				
50	1	0		22.81	22.85	22.92				
50	1	132		22.77	22.67	22.93				
50	128	0		25.87	25.91	25.84				
50	1	1	QPSK	26.25	26.38	26.41			28.54	0.7145
50	1	131		26.22	26.16	26.42				
50	64	32		26.32	26.43	26.26				
50	1	0		22.76	22.84	22.86				
50	1	132		22.71	22.60	22.89				
50	128	0		25.34	25.37	25.33				
50	1	1	16-QAM	25.32	25.36	25.54	28.54	0.7145		
50	1	1	64-QAM	23.82	23.88	24.05				
50	1	1	256-QAM	21.51	21.57	21.64				
Limit	EIRP < 1W			Result			Pass			

NR n77 Maximum Average Power [dBm] (GT - LC = 3 dB)										
BW [MHz]	RB Size	RB Offset	Mod	Lowest	Middle	Highest	EIRP (dBm)	EIRP(W)		
60	1	1	PI/2 BPSK	26.28	26.27	26.45	29.48	0.8872		
60	1	160		26.21	26.18	26.43				
60	81	40		26.48	26.48	26.41				
60	1	0		22.81	22.71	22.98				
60	1	161		22.72	22.69	22.89				
60	162	0		25.95	25.90	25.91				
60	1	1	QPSK	26.25	26.17	26.37			28.47	0.7031
60	1	160		26.17	26.13	26.36				
60	81	40		26.47	26.45	26.41				
60	1	0		22.74	22.73	22.85				
60	1	161		22.73	22.66	22.89				
60	162	0		25.46	25.36	25.48				
60	1	1	16-QAM	25.27	25.22	25.47	28.47	0.7031		
60	1	1	64-QAM	23.87	23.85	24.00				
60	1	1	256-QAM	21.52	21.42	21.68				
Limit	EIRP < 1W			Result			Pass			



NR n77 Maximum Average Power [dBm] (GT - LC = 3 dB)										
BW [MHz]	RB Size	RB Offset	Mod	Lowest	Middle	Highest	EIRP (dBm)	EIRP(W)		
70	1	1	PI/2 BPSK	26.28	26.13	26.38	29.44	0.879		
70	1	187		26.06	26.14	26.37				
70	90	45		26.35	26.33	26.44				
70	1	0		22.76	22.66	22.94				
70	1	188		22.59	22.71	22.92				
70	180	0		25.80	25.83	25.98				
70	1	1	QPSK	26.22	26.10	26.37			28.33	0.6808
70	1	187		26.06	26.15	26.36				
70	90	45		26.35	26.37	26.42				
70	1	0		22.74	22.61	22.91				
70	1	188		22.55	22.66	22.90				
70	180	0		25.31	25.34	25.46				
70	1	1	16-QAM	25.23	25.30	25.33	28.33	0.6808		
70	1	1	64-QAM	23.79	23.68	23.89				
70	1	1	256-QAM	21.42	21.38	21.91				
Limit	EIRP < 1W			Result			Pass			

NR n77 Maximum Average Power [dBm] (GT - LC = 3 dB)										
BW [MHz]	RB Size	RB Offset	Mod	Lowest	Middle	Highest	EIRP (dBm)	EIRP(W)		
80	1	1	PI/2 BPSK	26.26	26.15	26.29	29.5	0.8913		
80	1	215		26.23	26.31	26.44				
80	108	54		26.50	26.43	26.42				
80	1	0		22.81	22.64	22.79				
80	1	216		22.76	22.84	22.98				
80	216	0		25.92	25.88	25.94				
80	1	1	QPSK	26.27	26.12	26.24			28.26	0.6699
80	1	215		26.21	26.29	26.39				
80	108	54		26.48	26.41	26.47				
80	1	0		22.77	22.62	22.73				
80	1	216		22.73	22.81	22.88				
80	216	0		25.42	25.37	25.48				
80	1	1	16-QAM	25.15	25.21	25.26	28.26	0.6699		
80	1	1	64-QAM	23.74	23.63	23.76				
80	1	1	256-QAM	21.58	21.37	21.48				
Limit	EIRP < 1W			Result			Pass			



NR n77 Maximum Average Power [dBm] (GT - LC = 3 dB)								
BW [MHz]	RB Size	RB Offset	Mod	Lowest	Middle	Highest	EIRP (dBm)	EIRP(W)
90	1	1	PI/2 BPSK	26.21	26.12	26.17	29.51	0.8933
90	1	243		26.36	26.41	26.44		
90	120	60		26.36	26.42	26.51		
90	1	0		22.71	22.63	22.69		
90	1	244		22.89	22.95	22.99		
90	243	0		25.84	25.87	25.97		
90	1	1	QPSK	26.19	26.08	26.12		
90	1	243		26.39	26.37	26.41		
90	120	60		26.35	26.41	26.47		
90	1	0		22.70	22.59	22.58		
90	1	244		22.85	22.92	22.94		
90	243	0		25.28	25.36	25.43		
90	1	1	16-QAM	25.33	25.21	25.29	28.33	0.6808
90	1	1	64-QAM	23.89	23.70	23.73		
90	1	1	256-QAM	21.40	21.32	21.37		
Limit	EIRP < 1W			Result			Pass	

NR n77 Maximum Average Power [dBm] (GT - LC = 3 dB)								
BW [MHz]	RB Size	RB Offset	Mod	Lowest	Middle	Highest	EIRP (dBm)	EIRP(W)
100	1	1	PI/2 BPSK	-	26.21	-	29.49	0.8892
100	1	271		-	26.49	-		
100	135	67		-	26.45	-		
100	1	0		-	22.72	-		
100	1	272		-	22.98	-		
100	270	0		-	25.89	-		
100	1	1	QPSK	-	26.12	-		
100	1	271		-	26.41	-		
100	135	67		-	26.39	-		
100	1	0		-	22.67	-		
100	1	272		-	22.88	-		
100	270	0		-	25.34	-		
100	1	1	16-QAM	-	25.29	-	28.29	0.6745
100	1	1	64-QAM	-	23.75	-		
100	1	1	256-QAM	-	21.39	-		
Limit	EIRP < 1W			Result			Pass	



NR n78 Maximum Average Power [dBm] (GT - LC = 3 dB)								
BW [MHz]	RB Size	RB Offset	Mod	Lowest	Middle	Highest	EIRP (dBm)	EIRP(W)
10	1	1	PI/2 BPSK	26.01	26.14	26.14	29.17	0.826
10	1	22		25.97	25.93	26.13		
10	12	6		26.06	26.17	26.16		
10	1	0		22.50	22.62	22.61		
10	1	23		22.46	22.42	22.56		
10	24	0		25.53	25.64	25.63		
10	1	1	QPSK	26.03	26.12	26.12		
10	1	22		25.98	25.90	26.08		
10	12	6		26.02	26.15	25.99		
10	1	0		22.51	22.63	22.59		
10	1	23		22.41	22.41	22.56		
10	24	0		24.99	25.11	25.11		
10	1	1	16-QAM	26.18	25.25	25.22	29.18	0.8279
10	1	1	64-QAM	23.56	23.68	23.69		
10	1	1	256-QAM	21.30	21.44	21.39		
Limit	EIRP < 1W			Result			Pass	

NR n78 Maximum Average Power [dBm] (GT - LC = 3 dB)								
BW [MHz]	RB Size	RB Offset	Mod	Lowest	Middle	Highest	EIRP (dBm)	EIRP(W)
15	1	1	PI/2 BPSK	26.15	26.36	26.24	29.36	0.863
15	1	36		26.04	26.17	26.20		
15	18	9		26.14	26.23	26.26		
15	1	0		22.57	22.72	22.73		
15	1	37		22.51	22.56	22.67		
15	36	0		25.64	25.69	25.74		
15	1	1	QPSK	26.10	26.33	26.19		
15	1	36		26.01	26.08	26.12		
15	18	9		26.16	26.21	26.23		
15	1	0		22.60	22.68	22.63		
15	1	37		22.48	22.57	22.59		
15	36	0		25.16	25.21	25.24		
15	1	1	16-QAM	25.18	25.34	25.24	28.34	0.6823
15	1	1	64-QAM	23.69	23.92	23.72		
15	1	1	256-QAM	21.43	21.65	21.54		
Limit	EIRP < 1W			Result			Pass	



NR n78 Maximum Average Power [dBm] (GT - LC = 3 dB)								
BW [MHz]	RB Size	RB Offset	Mod	Lowest	Middle	Highest	EIRP (dBm)	EIRP(W)
20	1	1	PI/2 BPSK	25.99	26.12	26.01	29.17	0.826
20	1	49		26.01	26.06	26.17		
20	25	12		25.94	26.13	26.05		
20	1	0		22.47	22.60	22.43		
20	1	50		22.45	22.59	22.61		
20	50	0		25.48	25.64	25.59		
20	1	1	QPSK	25.96	26.13	25.97		
20	1	49		25.95	26.07	26.15		
20	25	12		25.91	26.13	26.05		
20	1	0		22.46	22.62	22.46		
20	1	50		22.43	22.58	22.62		
20	50	0		24.92	25.11	25.06		
20	1	1	16-QAM	25.13	25.14	25.18	28.18	0.6577
20	1	1	64-QAM	23.51	23.75	23.51		
20	1	1	256-QAM	21.11	21.32	21.23		
Limit	EIRP < 1W			Result			Pass	



NR n78 Maximum Average Power [dBm] (GT - LC = 3 dB)								
BW [MHz]	RB Size	RB Offset	Mod	Lowest	Middle	Highest	EIRP (dBm)	EIRP(W)
30	1	1	PI/2 BPSK	26.04	26.26	26.16	29.4	0.871
30	1	76		26.15	25.94	26.40		
30	36	18		26.01	26.21	26.25		
30	1	0		22.57	22.79	22.56		
30	1	77		22.63	22.46	22.87		
30	75	0		25.54	25.71	25.77		
30	1	1	QPSK	26.09	26.19	26.06		
30	1	76		26.16	25.94	26.36		
30	36	18		25.99	26.20	26.27		
30	1	0		22.58	22.71	22.59		
30	1	77		22.66	22.47	22.83		
30	75	0		25.06	25.22	25.28		
30	1	1	16-QAM	25.20	25.48	25.23	28.48	0.7047
30	1	1	64-QAM	23.62	23.79	23.65		
30	1	1	256-QAM	21.31	21.57	21.34		
Limit	EIRP < 1W			Result			Pass	

NR n78 Maximum Average Power [dBm] (GT - LC = 3 dB)								
BW [MHz]	RB Size	RB Offset	Mod	Lowest	Middle	Highest	EIRP (dBm)	EIRP(W)
40	1	1	PI/2 BPSK	26.20	26.25	26.22	29.34	0.859
40	1	104		26.27	26.04	26.34		
40	50	25		26.17	26.23	26.13		
40	1	0		22.72	22.81	22.69		
40	1	105		22.76	22.53	22.85		
40	100	0		25.69	25.70	25.66		
40	1	1	QPSK	26.16	26.21	26.20		
40	1	104		26.18	25.98	26.32		
40	50	25		26.14	26.19	26.10		
40	1	0		22.68	22.79	22.67		
40	1	105		22.71	22.51	22.80		
40	100	0		25.19	25.20	25.14		
40	1	1	16-QAM	25.17	25.50	25.41	28.5	0.7079
40	1	1	64-QAM	23.74	23.83	23.76		
40	1	1	256-QAM	21.39	21.42	21.35		
Limit	EIRP < 1W			Result			Pass	





NR n78 Maximum Average Power [dBm] (GT - LC = 3 dB)								
BW [MHz]	RB Size	RB Offset	Mod	Lowest	Middle	Highest	EIRP (dBm)	EIRP(W)
50	1	1	PI/2 BPSK	25.73	25.85	25.78	28.94	0.7834
50	1	131		25.89	25.79	25.86		
50	64	32		25.86	25.94	25.83		
50	1	0		22.20	22.33	22.34		
50	1	132		22.39	22.31	22.38		
50	128	0		25.35	25.41	25.36		
50	1	1	QPSK	25.70	25.77	25.75		
50	1	131		25.87	25.68	25.83		
50	64	32		25.83	25.92	25.80		
50	1	0		22.15	22.27	22.27		
50	1	132		22.27	22.24	22.36		
50	128	0		24.83	24.92	24.85		
50	1	1	16-QAM	24.93	24.69	24.87	27.93	0.6209
50	1	1	64-QAM	23.27	23.43	23.33		
50	1	1	256-QAM	20.91	21.04	20.99		
Limit	EIRP < 1W			Result			Pass	

NR n78 Maximum Average Power [dBm] (GT - LC = 3 dB)								
BW [MHz]	RB Size	RB Offset	Mod	Lowest	Middle	Highest	EIRP (dBm)	EIRP(W)
60	1	1	PI/2 BPSK	25.81	25.76	25.93	28.94	0.7834
60	1	160		25.78	25.74	25.85		
60	81	40		25.92	25.89	25.83		
60	1	0		22.28	22.26	22.42		
60	1	161		22.25	22.27	22.38		
60	162	0		25.41	25.34	25.39		
60	1	1	QPSK	25.74	25.67	25.87		
60	1	160		25.76	25.75	25.83		
60	81	40		25.94	25.88	25.81		
60	1	0		22.24	22.25	22.40		
60	1	161		22.29	22.26	22.32		
60	162	0		24.92	24.89	24.92		
60	1	1	16-QAM	24.98	24.76	24.85	27.98	0.6281
60	1	1	64-QAM	23.31	23.34	23.42		
60	1	1	256-QAM	20.98	20.90	21.16		
Limit	EIRP < 1W			Result			Pass	



NR n78 Maximum Average Power [dBm] (GT - LC = 3 dB)								
BW [MHz]	RB Size	RB Offset	Mod	Lowest	Middle	Highest	EIRP (dBm)	EIRP(W)
70	1	1	PI/2 BPSK	25.80	25.62	25.86	28.9	0.7762
70	1	187		25.67	25.78	25.81		
70	90	45		25.85	25.83	25.90		
70	1	0		22.27	22.15	22.41		
70	1	188		22.10	22.26	22.36		
70	180	0		25.29	25.31	25.41		
70	1	1	QPSK	25.71	25.57	25.90		
70	1	187		25.60	25.70	25.85		
70	90	45		25.85	25.83	25.88		
70	1	0		22.21	22.11	22.41		
70	1	188		22.08	22.26	22.31		
70	180	0		24.77	24.81	24.91		
70	1	1	16-QAM	24.77	24.72	24.97	27.97	0.6266
70	1	1	64-QAM	23.25	23.15	23.41		
70	1	1	256-QAM	21.13	20.86	21.13		
Limit	EIRP < 1W			Result			Pass	

NR n78 Maximum Average Power [dBm] (GT - LC = 3 dB)								
BW [MHz]	RB Size	RB Offset	Mod	Lowest	Middle	Highest	EIRP (dBm)	EIRP(W)
80	1	1	PI/2 BPSK	25.71	25.61	25.70	28.91	0.778
80	1	215		25.74	25.75	25.83		
80	108	54		25.91	25.86	25.87		
80	1	0		22.21	22.12	22.20		
80	1	216		22.13	22.28	22.40		
80	216	0		25.31	25.31	25.37		
80	1	1	QPSK	25.65	25.52	25.67		
80	1	215		25.67	25.74	25.81		
80	108	54		25.89	25.84	25.85		
80	1	0		22.10	22.07	22.14		
80	1	216		22.15	22.22	22.31		
80	216	0		24.81	24.79	24.87		
80	1	1	16-QAM	24.57	24.43	24.59	27.59	0.5741
80	1	1	64-QAM	23.26	23.16	23.31		
80	1	1	256-QAM	20.88	20.85	20.96		
Limit	EIRP < 1W			Result			Pass	



NR n78 Maximum Average Power [dBm] (GT - LC = 3 dB)								
BW [MHz]	RB Size	RB Offset	Mod	Lowest	Middle	Highest	EIRP (dBm)	EIRP(W)
90	1	1	PI/2 BPSK	25.78	25.53	25.60	28.94	0.7834
90	1	243		25.84	25.83	25.90		
90	120	60		25.84	25.84	25.94		
90	1	0		22.25	22.07	22.07		
90	1	244		22.33	22.37	22.41		
90	243	0		25.28	25.27	25.37		
90	1	1	QPSK	25.77	25.51	25.51		
90	1	243		25.78	25.78	25.81		
90	120	60		25.83	25.84	25.92		
90	1	0		22.21	21.99	22.02		
90	1	244		22.31	22.32	22.34		
90	243	0		24.73	24.77	24.89		
90	1	1	16-QAM	24.87	24.43	24.58	27.87	0.6124
90	1	1	64-QAM	23.23	23.10	23.12		
90	1	1	256-QAM	20.93	20.77	20.81		
Limit	EIRP < 1W			Result			Pass	

NR n78 Maximum Average Power [dBm] (GT - LC = 3 dB)								
BW [MHz]	RB Size	RB Offset	Mod	Lowest	Middle	Highest	EIRP (dBm)	EIRP(W)
100	1	1	PI/2 BPSK	-	25.71	-	28.85	0.7674
100	1	271		-	25.83	-		
100	135	67		-	25.79	-		
100	1	0		-	22.19	-		
100	1	272		-	22.33	-		
100	270	0		-	25.29	-		
100	1	1	QPSK	-	25.62	-		
100	1	271		-	25.79	-		
100	135	67		-	25.85	-		
100	1	0		-	22.13	-		
100	1	272		-	22.29	-		
100	270	0		-	24.77	-		
100	1	1	16-QAM	-	24.52	-	27.52	0.5649
100	1	1	64-QAM	-	23.20	-		
100	1	1	256-QAM	-	20.91	-		
Limit	EIRP < 1W			Result			Pass	



<MIMO Mode>

Part27Q NR n77 Maximum Average Power [dBm], DG = 3 dBi														
BW (MHz)	RB Size	RB Offset	Mod	Antenna 0			Antenna 2			Combine			EIRP (dBm)	EIRP (W)
				Lowest	Middle	Highest	Lowest	Middle	Highest	Lowest	Middle	Highest		
10	1	1	QPSK	22.47	22.26	22.45	22.70	22.81	22.68	25.60	25.55	25.58	28.6	0.724
10	1	22		22.25	22.17	22.44	22.70	22.79	22.73	25.49	25.50	25.60		
10	12	6		22.21	22.16	22.17	22.64	22.81	22.72	25.44	25.51	25.46		
10	1	0		20.45	20.45	20.38	20.71	20.89	20.70	23.59	23.69	23.55		
10	1	23		20.26	20.28	20.33	20.62	20.81	20.65	23.45	23.56	23.50		
10	24	0		20.71	20.75	20.75	21.17	21.31	21.22	23.96	24.05	24.00		
10	1	1	16-QAM	21.78	21.69	21.68	22.42	22.47	22.28	25.12	25.11	25.00	28.12	0.649
10	1	1	64-QAM	20.08	20.03	20.01	20.57	20.81	20.61	23.34	23.45	23.33		
10	1	1	256-QAM	17.27	17.19	17.27	17.51	17.71	17.50	20.40	20.47	20.40		
Limit	EIRP < 1W			Result									Pass	

Part27Q NR n77 Maximum Average Power [dBm], DG = 3 dBi														
BW (MHz)	RB Size	RB Offset	Mod	Antenna 0			Antenna 2			Combine			EIRP (dBm)	EIRP (W)
				Lowest	Middle	Highest	Lowest	Middle	Highest	Lowest	Middle	Highest		
15	1	1	QPSK	22.66	22.78	22.51	22.84	22.97	23.14	25.76	25.89	25.85	28.89	0.775
15	1	36		22.49	22.49	22.59	22.89	22.92	23.11	25.70	25.72	25.87		
15	19	9		22.22	22.39	22.37	22.83	22.91	23.12	25.55	25.67	25.77		
15	1	0		20.40	20.70	20.67	20.82	21.08	21.04	23.63	23.90	23.87		
15	1	37		20.53	20.43	20.51	20.87	20.92	21.09	23.71	23.69	23.82		
15	38	0		20.72	20.84	20.90	21.28	21.32	21.50	24.02	24.10	24.22		
15	1	1	16-QAM	21.85	22.07	21.94	22.49	22.73	22.66	25.19	25.42	25.33	28.42	0.695
15	1	1	64-QAM	20.28	20.41	20.33	20.80	20.96	21.03	23.56	23.70	23.70		
15	1	1	256-QAM	17.46	17.51	17.51	17.68	17.86	17.91	20.58	20.70	20.72		
Limit	EIRP < 1W			Result									Pass	



Part27Q NR n77 Maximum Average Power [dBm], DG = 3 dBi														
BW (MHz)	RB Size	RB Offset	Mod	Antenna 0			Antenna 2			Combine			EIRP (dBm)	EIRP (W)
				Lowest	Middle	Highest	Lowest	Middle	Highest	Lowest	Middle	Highest		
20	1	1	QPSK	22.65	22.79	22.67	22.86	22.97	23.02	25.77	25.89	25.86	28.89	0.775
20	1	49		22.57	22.44	22.58	22.94	22.86	23.09	25.77	25.67	25.85		
20	25	12		22.26	22.33	22.38	22.78	22.90	23.00	25.54	25.63	25.71		
20	1	0		20.58	20.41	20.64	20.82	20.99	21.01	23.71	23.72	23.84		
20	1	50		20.39	20.34	20.51	20.85	20.88	21.06	23.64	23.63	23.80		
20	51	0		20.82	20.85	20.96	21.30	21.36	21.47	24.08	24.12	24.23		
20	1	1	16-QAM	21.87	21.94	22.07	22.52	22.66	22.72	25.22	25.33	25.42	28.42	0.695
20	1	1	64-QAM	20.23	20.37	20.30	20.87	20.91	20.90	23.57	23.66	23.62		
20	1	1	256-QAM	17.45	17.53	17.53	17.74	17.88	17.84	20.61	20.72	20.70		
Limit	EIRP < 1W			Result									Pass	

Part27Q NR n77 Maximum Average Power [dBm], DG = 3 dBi														
BW (MHz)	RB Size	RB Offset	Mod	Antenna 0			Antenna 2			Combine			EIRP (dBm)	EIRP (W)
				Lowest	Middle	Highest	Lowest	Middle	Highest	Lowest	Middle	Highest		
30	1	1	QPSK	22.53	22.69	22.59	23.12	23.19	23.18	25.85	25.96	25.91	28.96	0.787
30	1	76		22.73	22.58	22.64	23.01	22.86	23.09	25.88	25.73	25.88		
30	39	19		22.36	22.38	22.42	22.99	23.02	23.07	25.70	25.72	25.77		
30	1	0		20.50	20.52	20.62	21.02	21.20	21.10	23.78	23.88	23.88		
30	1	77		20.61	20.41	20.52	21.07	20.97	21.12	23.86	23.71	23.84		
30	78	0		21.01	20.89	20.91	21.45	21.50	21.56	24.25	24.22	24.26		
30	1	1	16-QAM	21.94	22.05	22.15	22.66	22.84	22.67	25.33	25.47	25.43	28.47	0.703
30	1	1	64-QAM	20.35	20.49	20.42	20.93	21.12	21.04	23.66	23.83	23.75		
30	1	1	256-QAM	17.53	17.52	17.60	17.82	18.16	17.91	20.69	20.86	20.77		
Limit	EIRP < 1W			Result									Pass	

Part27Q NR n77 Maximum Average Power [dBm], DG = 3 dBi														
BW (MHz)	RB Size	RB Offset	Mod	Antenna 0			Antenna 2			Combine			EIRP (dBm)	EIRP (W)
				Lowest	Middle	Highest	Lowest	Middle	Highest	Lowest	Middle	Highest		
40	1	1	QPSK	22.78	22.90	22.64	23.07	23.00	23.15	25.94	25.96	25.91	28.99	0.793
40	1	104		22.78	22.66	22.42	23.17	22.92	23.15	25.99	25.80	25.81		
40	53	26		22.44	22.37	22.34	23.00	23.08	23.01	25.74	25.75	25.70		
40	1	0		20.67	20.89	20.58	21.04	21.23	21.09	23.87	24.07	23.85		
40	1	105		20.57	20.48	20.40	21.12	20.96	21.12	23.86	23.74	23.79		
40	106	0		20.92	20.92	20.85	21.53	21.53	21.56	24.25	24.25	24.23		
40	1	1	16-QAM	22.09	22.34	22.02	22.76	22.80	22.81	25.45	25.59	25.44	28.59	0.723
40	1	1	64-QAM	20.48	20.56	20.37	21.02	21.19	21.08	23.77	23.90	23.75		
40	1	1	256-QAM	17.59	17.84	17.51	17.88	18.12	17.91	20.75	20.99	20.72		
Limit	EIRP < 1W			Result									Pass	



Part27Q NR n77 Maximum Average Power [dBm], DG = 3 dBi														
BW (MHz)	RB Size	RB Offset	Mod	Antenna 0			Antenna 2			Combine			EIRP (dBm)	EIRP (W)
				Lowest	Middle	Highest	Lowest	Middle	Highest	Lowest	Middle	Highest		
50	1	1	QPSK	22.51	22.76	22.68	22.62	22.92	22.76	25.58	25.85	25.73	28.85	0.767
50	1	131		22.24	22.24	22.25	22.54	22.61	22.67	25.40	25.44	25.48		
50	67	33		22.29	22.15	22.23	22.63	22.70	22.54	25.47	25.44	25.40		
50	1	0		20.49	20.64	20.58	20.64	20.87	20.72	23.58	23.77	23.66		
50	1	132		20.07	20.12	20.12	20.50	20.55	20.59	23.30	23.35	23.37		
50	133	0		20.84	20.72	20.70	21.03	21.21	21.06	23.95	23.98	23.89		
50	1	1	16-QAM	21.90	21.97	21.88	22.23	22.50	22.39	25.08	25.25	25.15	28.25	0.668
50	1	1	64-QAM	20.24	20.32	20.20	20.60	20.89	20.70	23.43	23.62	23.47		
50	1	1	256-QAM	17.42	17.55	17.52	17.50	17.73	17.62	20.47	20.65	20.58		
Limit	EIRP < 1W			Result									Pass	

Part27Q NR n77 Maximum Average Power [dBm], DG = 3 dBi														
BW (MHz)	RB Size	RB Offset	Mod	Antenna 0			Antenna 2			Combine			EIRP (dBm)	EIRP (W)
				Lowest	Middle	Highest	Lowest	Middle	Highest	Lowest	Middle	Highest		
60	1	1	QPSK	22.19	22.80	22.17	22.43	22.73	22.31	25.32	25.78	25.25	28.78	0.755
60	1	160		22.12	22.18	22.41	22.26	22.48	22.26	25.20	25.34	25.35		
60	81	40		21.87	22.26	22.17	22.38	22.68	22.22	25.14	25.49	25.21		
60	1	0		19.94	20.52	20.03	20.45	20.73	20.18	23.21	23.64	23.12		
60	1	161		19.88	20.06	20.28	20.23	20.46	20.25	23.07	23.27	23.28		
60	162	0		20.36	20.78	20.67	20.86	21.10	20.72	23.63	23.95	23.71		
60	1	1	16-QAM	21.30	22.05	21.51	22.07	22.26	21.89	24.71	25.17	24.71	28.17	0.656
60	1	1	64-QAM	19.61	20.34	19.93	20.41	20.70	20.12	23.04	23.53	23.04		
60	1	1	256-QAM	16.85	17.61	16.98	17.30	17.55	17.03	20.09	20.59	20.02		
Limit	EIRP < 1W			Result									Pass	



Part27Q NR n77 Maximum Average Power [dBm], DG = 3 dBi														
BW	RB	RB	Mod	Antenna 0			Antenna 2			Combine			EIRP	EIRP
(MHz)	Size	Offset		Lowest	Middle	Highest	Lowest	Middle	Highest	Lowest	Middle	Highest	(dBm)	(W)
70	1	1	QPSK	22.58	22.61	22.74	22.55	22.65	22.81	25.58	25.64	25.79	28.79	0.757
70	1	187		21.96	22.08	22.11	22.27	22.49	22.53	25.13	25.30	25.34		
70	95	47		22.17	22.15	22.05	21.24	21.83	21.63	24.74	25.00	24.86		
70	1	0		20.48	20.53	20.65	20.59	20.64	20.82	23.55	23.60	23.75		
70	1	188		19.84	19.97	19.96	20.22	20.46	20.51	23.04	23.23	23.25		
70	189	0		20.58	20.64	20.64	19.43	20.02	19.76	23.05	23.35	23.23		
70	1	1	16-QAM	21.96	21.94	22.10	22.14	22.21	22.38	25.06	25.09	25.25	28.25	0.668
70	1	1	64-QAM	20.21	20.19	20.32	20.45	20.58	20.72	23.34	23.40	23.53		
70	1	1	256-QAM	17.40	17.45	17.52	17.43	17.47	17.71	20.43	20.47	20.63		
Limit	EIRP < 1W			Result									Pass	

Part27Q NR n77 Maximum Average Power [dBm], DG = 3 dBi														
BW	RB	RB	Mod	Antenna 0			Antenna 2			Combine			EIRP	EIRP
(MHz)	Size	Offset		Lowest	Middle	Highest	Lowest	Middle	Highest	Lowest	Middle	Highest	(dBm)	(W)
80	1	1	QPSK	22.66	22.61	22.60	22.51	22.55	22.82	25.60	25.59	25.72	28.72	0.745
80	1	215		21.99	22.14	22.08	22.33	22.46	22.48	25.17	25.31	25.29		
80	109	54		22.13	22.17	22.16	22.67	22.67	22.62	25.42	25.44	25.41		
80	1	0		20.46	20.42	20.63	20.54	20.60	20.73	23.51	23.52	23.69		
80	1	216		19.71	19.97	19.90	20.35	20.44	20.49	23.05	23.22	23.22		
80	217	0		20.58	20.63	20.64	21.03	21.12	21.07	23.82	23.89	23.87		
80	1	1	16-QAM	21.86	21.79	22.08	22.26	22.26	22.31	25.07	25.04	25.21	28.21	0.662
80	1	1	64-QAM	20.25	20.16	20.35	20.51	20.52	20.64	23.39	23.35	23.51		
80	1	1	256-QAM	17.38	17.39	17.59	17.47	17.45	17.57	20.44	20.43	20.59		
Limit	EIRP < 1W			Result									Pass	



Part27Q NR n77 Maximum Average Power [dBm], DG = 3 dBi														
BW	RB	RB	Mod	Antenna 0			Antenna 2			Combine			EIRP	EIRP
(MHz)	Size	Offset		Lowest	Middle	Highest	Lowest	Middle	Highest	Lowest	Middle	Highest	(dBm)	(W)
90	1	1	QPSK	22.53	22.62	22.71	22.58	22.62	22.67	25.57	25.63	25.70	28.7	0.741
90	1	243		22.14	22.24	22.18	22.54	22.68	22.70	25.35	25.48	25.46		
90	123	61		22.11	22.14	22.18	22.62	22.64	22.64	25.38	25.41	25.43		
90	1	0		20.41	20.39	20.53	20.56	20.64	20.65	23.50	23.53	23.60		
90	1	244		19.93	20.02	19.99	20.50	20.64	20.64	23.23	23.35	23.34		
90	245	0		20.60	20.61	20.66	21.00	21.09	21.12	23.81	23.87	23.91		
90	1	1	16-QAM	21.77	21.97	22.03	22.23	22.32	22.40	25.02	25.16	25.23	28.23	0.665
90	1	1	64-QAM	20.12	20.22	20.27	20.53	20.54	20.62	23.34	23.39	23.46		
90	1	1	256-QAM	17.42	17.37	17.46	17.45	17.51	17.46	20.45	20.45	20.47		
Limit	EIRP < 1W			Result									Pass	

Part27Q NR n77 Maximum Average Power [dBm], DG = 3 dBi														
BW	RB	RB	Mod	Antenna 0			Antenna 2			Combine			EIRP	EIRP
(MHz)	Size	Offset		Lowest	Middle	Highest	Lowest	Middle	Highest	Lowest	Middle	Highest	(dBm)	(W)
100	1	1	QPSK	-	22.63	-	-	22.62	-	-	25.64	-	28.64	0.731
100	1	271		-	22.16	-	-	22.60	-	-	25.40	-		
100	137	68		-	22.16	-	-	22.63	-	-	25.41	-		
100	1	0		-	20.33	-	-	20.68	-	-	23.52	-		
100	1	272		-	19.95	-	-	20.60	-	-	23.30	-		
100	273	0		-	20.65	-	-	21.11	-	-	23.90	-		
100	1	1	16-QAM	-	21.89	-	-	22.27	-	-	25.09	-	28.09	0.644
100	1	1	64-QAM	-	20.17	-	-	20.56	-	-	23.38	-		
100	1	1	256-QAM	-	17.34	-	-	17.48	-	-	20.42	-		
Limit	EIRP < 1W			Result									Pass	





Part27Q NR n78 Maximum Average Power [dBm], DG = 3 dBi														
BW (MHz)	RB Size	RB Offset	Mod	Antenna 0			Antenna 2			Combine			EIRP (dBm)	EIRP (W)
				Lowest	Middle	Highest	Lowest	Middle	Highest	Lowest	Middle	Highest		
10	1	1	QPSK	22.47	22.39	22.49	22.65	22.97	22.72	25.57	25.70	25.62	28.7	0.741
10	1	22		22.33	22.45	22.32	22.65	22.80	22.72	25.50	25.64	25.53		
10	12	6		22.11	22.13	22.16	22.57	22.68	22.68	25.36	25.42	25.44		
10	1	0		20.29	20.40	20.26	20.57	20.85	20.65	23.44	23.64	23.47		
10	1	23		20.26	20.29	20.32	20.63	20.74	20.74	23.46	23.53	23.55		
10	24	0		20.63	20.73	20.70	21.10	21.20	21.22	23.88	23.98	23.98		
10	1	1	16-QAM	21.80	21.82	21.77	22.35	22.51	22.45	25.09	25.19	25.13	28.19	0.659
10	1	1	64-QAM	20.13	20.06	20.07	20.54	20.72	20.62	23.35	23.41	23.36		
10	1	1	256-QAM	17.21	17.24	17.22	17.56	17.67	17.54	20.40	20.47	20.39		
Limit	EIRP < 1W			Result									Pass	

Part27Q NR n78 Maximum Average Power [dBm], DG = 3 dBi														
BW (MHz)	RB Size	RB Offset	Mod	Antenna 0			Antenna 2			Combine			EIRP (dBm)	EIRP (W)
				Lowest	Middle	Highest	Lowest	Middle	Highest	Lowest	Middle	Highest		
15	1	1	QPSK	22.36	22.71	22.66	22.84	22.92	22.93	25.62	25.83	25.81	28.83	0.764
15	1	36		22.43	22.46	22.27	22.77	22.79	22.82	25.61	25.64	25.56		
15	19	9		22.15	22.35	22.29	22.73	22.81	22.92	25.46	25.60	25.63		
15	1	0		20.50	20.46	20.57	20.71	20.85	20.93	23.62	23.67	23.76		
15	1	37		20.11	20.21	20.46	20.67	20.68	21.00	23.41	23.46	23.75		
15	38	0		20.67	20.83	20.86	21.21	21.30	21.41	23.96	24.08	24.15		
15	1	1	16-QAM	21.88	21.93	21.97	22.24	22.57	22.66	25.07	25.27	25.34	28.34	0.682
15	1	1	64-QAM	20.17	20.34	20.27	20.61	20.87	20.84	23.41	23.62	23.57		
15	1	1	256-QAM	17.35	17.44	17.25	17.57	17.76	17.87	20.47	20.61	20.58		
Limit	EIRP < 1W			Result									Pass	



Part27Q NR n78 Maximum Average Power [dBm], DG = 3 dBi														
BW (MHz)	RB Size	RB Offset	Mod	Antenna 0			Antenna 2			Combine			EIRP (dBm)	EIRP (W)
				Lowest	Middle	Highest	Lowest	Middle	Highest	Lowest	Middle	Highest		
20	1	1	QPSK	22.61	22.52	22.66	22.75	23.07	22.87	25.69	25.81	25.78	28.81	0.76
20	1	49		22.53	22.41	22.52	22.88	22.73	22.91	25.72	25.58	25.73		
20	25	12		22.16	22.27	22.34	22.67	22.83	22.87	25.43	25.57	25.62		
20	1	0		20.46	20.39	20.54	20.77	20.93	20.89	23.63	23.68	23.73		
20	1	50		20.41	20.11	20.45	20.80	20.74	20.99	23.62	23.45	23.74		
20	51	0		20.71	20.82	20.81	21.19	21.27	21.36	23.97	24.06	24.10		
20	1	1	16-QAM	21.88	22.07	21.87	22.30	22.53	22.54	25.11	25.32	25.23	28.32	0.679
20	1	1	64-QAM	20.13	20.30	20.25	20.79	20.91	20.84	23.48	23.63	23.57		
20	1	1	256-QAM	17.34	17.56	17.50	17.66	17.82	17.79	20.51	20.70	20.66		
Limit	EIRP < 1W			Result									Pass	

Part27Q NR n78 Maximum Average Power [dBm], DG = 3 dBi														
BW (MHz)	RB Size	RB Offset	Mod	Antenna 0			Antenna 2			Combine			EIRP (dBm)	EIRP (W)
				Lowest	Middle	Highest	Lowest	Middle	Highest	Lowest	Middle	Highest		
30	1	1	QPSK	22.49	22.83	22.73	23.00	23.06	22.89	25.76	25.96	25.82	28.96	0.787
30	1	76		22.42	22.49	22.60	23.02	22.79	22.98	25.74	25.65	25.80		
30	39	19		22.39	22.35	22.38	22.81	22.97	22.99	25.62	25.68	25.71		
30	1	0		20.58	20.51	20.61	20.90	21.06	20.98	23.75	23.80	23.81		
30	1	77		20.54	20.37	20.46	20.96	20.79	20.97	23.77	23.60	23.73		
30	78	0		20.84	20.86	20.90	21.37	21.44	21.46	24.12	24.17	24.20		
30	1	1	16-QAM	21.87	22.15	21.94	22.49	22.69	22.56	25.20	25.44	25.27	28.44	0.698
30	1	1	64-QAM	20.26	20.42	20.31	20.81	21.07	20.91	23.55	23.77	23.63		
30	1	1	256-QAM	17.50	17.67	17.49	17.72	17.95	17.80	20.62	20.82	20.66		
Limit	EIRP < 1W			Result									Pass	

Part27Q NR n78 Maximum Average Power [dBm], DG = 3 dBi														
BW (MHz)	RB Size	RB Offset	Mod	Antenna 0			Antenna 2			Combine			EIRP (dBm)	EIRP (W)
				Lowest	Middle	Highest	Lowest	Middle	Highest	Lowest	Middle	Highest		
40	1	1	QPSK	22.73	22.75	22.68	23.06	23.01	23.02	25.91	25.89	25.86	28.91	0.778
40	1	104		22.54	22.38	22.66	23.17	22.82	23.06	25.88	25.62	25.87		
40	53	26		22.36	22.33	22.29	22.89	23.00	22.99	25.64	25.69	25.66		
40	1	0		20.60	20.78	20.57	20.93	21.17	20.99	23.78	23.99	23.80		
40	1	105		20.43	20.33	20.43	20.95	20.95	20.98	23.71	23.66	23.72		
40	106	0		20.89	20.85	20.77	21.43	21.45	21.44	24.18	24.17	24.13		
40	1	1	16-QAM	22.06	22.31	21.97	22.64	22.81	22.68	25.37	25.58	25.35	28.58	0.721
40	1	1	64-QAM	20.45	20.56	20.31	20.96	21.10	20.92	23.72	23.85	23.64		
40	1	1	256-QAM	17.58	17.85	17.51	17.78	17.96	17.79	20.69	20.92	20.66		
Limit	EIRP < 1W			Result									Pass	



Part27Q NR n78 Maximum Average Power [dBm], DG = 3 dBi														
BW	RB	RB	Mod	Antenna 0			Antenna 2			Combine			EIRP	EIRP
(MHz)	Size	Offset		Lowest	Middle	Highest	Lowest	Middle	Highest	Lowest	Middle	Highest	(dBm)	(W)
50	1	1	QPSK	22.44	22.63	22.52	22.51	22.72	22.59	25.49	25.69	25.57	28.69	0.74
50	1	131		22.18	22.27	22.23	22.55	22.50	22.52	25.38	25.40	25.39		
50	67	33		22.14	22.26	22.12	22.64	22.63	22.53	25.41	25.46	25.34		
50	1	0		20.34	20.37	20.43	20.50	20.62	20.65	23.43	23.51	23.55		
50	1	132		20.04	20.11	20.10	20.56	20.48	20.54	23.32	23.31	23.34		
50	133	0		20.64	20.66	20.67	21.10	21.13	21.11	23.89	23.91	23.91		
50	1	1	16-QAM	21.69	21.99	21.70	22.11	22.24	22.31	24.92	25.13	25.03	28.13	0.65
50	1	1	64-QAM	20.02	20.22	20.13	20.51	20.68	20.52	23.28	23.47	23.34		
50	1	1	256-QAM	17.26	17.48	17.29	17.32	17.56	17.48	20.30	20.53	20.40		
Limit	EIRP < 1W			Result									Pass	

Part27Q NR n78 Maximum Average Power [dBm], DG = 3 dBi														
BW	RB	RB	Mod	Antenna 0			Antenna 2			Combine			EIRP	EIRP
(MHz)	Size	Offset		Lowest	Middle	Highest	Lowest	Middle	Highest	Lowest	Middle	Highest	(dBm)	(W)
60	1	1	QPSK	22.24	22.58	22.16	22.47	22.70	22.31	25.37	25.65	25.25	28.65	0.733
60	1	160		22.29	22.11	22.44	22.38	22.49	22.25	25.35	25.31	25.36		
60	81	40		22.03	22.17	22.21	22.48	22.66	22.23	25.27	25.43	25.23		
60	1	0		20.07	20.44	20.07	20.44	20.69	20.21	23.27	23.58	23.15		
60	1	161		20.06	20.00	20.29	20.37	20.40	20.36	23.23	23.21	23.34		
60	162	0		20.43	20.72	20.68	20.98	21.09	20.75	23.72	23.92	23.73		
60	1	1	16-QAM	21.46	21.84	21.50	22.10	22.34	21.74	24.80	25.11	24.63	28.11	0.647
60	1	1	64-QAM	19.84	20.20	19.93	20.43	20.64	20.16	23.16	23.44	23.06		
60	1	1	256-QAM	17.05	17.40	17.00	17.36	17.59	17.00	20.22	20.51	20.01		
Limit	EIRP < 1W			Result									Pass	



Part27Q NR n78 Maximum Average Power [dBm], DG = 3 dBi														
BW	RB	RB	Mod	Antenna 0			Antenna 2			Combine			EIRP	EIRP
(MHz)	Size	Offset		Lowest	Middle	Highest	Lowest	Middle	Highest	Lowest	Middle	Highest	(dBm)	(W)
70	1	1	QPSK	22.35	22.54	22.67	22.70	22.67	22.84	25.54	25.62	25.77	28.77	0.753
70	1	187		21.77	21.98	22.02	22.31	22.45	22.50	25.06	25.23	25.28		
70	95	47		22.12	22.09	22.05	21.41	21.54	21.32	24.79	24.83	24.71		
70	1	0		20.25	20.50	20.60	20.55	20.67	20.80	23.41	23.60	23.71		
70	1	188		19.74	19.92	19.90	20.31	20.46	20.52	23.04	23.21	23.23		
70	189	0		20.54	20.59	20.60	19.45	19.74	19.62	23.04	23.20	23.15		
70	1	1	16-QAM	21.76	21.83	22.03	22.21	22.30	22.41	25.00	25.08	25.23	28.23	0.665
70	1	1	64-QAM	20.10	20.19	20.27	20.55	20.62	20.74	23.34	23.42	23.52		
70	1	1	256-QAM	17.21	17.37	17.49	17.40	17.45	17.65	20.32	20.42	20.58		
Limit	EIRP < 1W			Result									Pass	

Part27Q NR n78 Maximum Average Power [dBm], DG = 3 dBi														
BW	RB	RB	Mod	Antenna 0			Antenna 2			Combine			EIRP	EIRP
(MHz)	Size	Offset		Lowest	Middle	Highest	Lowest	Middle	Highest	Lowest	Middle	Highest	(dBm)	(W)
80	1	1	QPSK	22.55	22.33	22.69	22.61	22.71	22.70	25.59	25.53	25.71	28.71	0.743
80	1	215		22.03	22.05	21.97	22.34	22.41	22.49	25.20	25.24	25.25		
80	109	54		22.13	22.06	22.11	22.65	22.65	22.53	25.41	25.38	25.34		
80	1	0		20.45	20.40	20.42	20.58	20.60	20.66	23.53	23.51	23.55		
80	1	216		19.78	19.88	19.86	20.29	20.44	20.48	23.05	23.18	23.19		
80	217	0		20.42	20.56	20.61	21.03	21.05	21.12	23.75	23.82	23.88		
80	1	1	16-QAM	21.87	21.92	21.79	22.13	22.22	22.36	25.01	25.08	25.09	28.09	0.644
80	1	1	64-QAM	20.07	20.09	20.31	20.47	20.47	20.67	23.28	23.29	23.50		
80	1	1	256-QAM	17.37	17.27	17.49	17.40	17.43	17.51	20.40	20.36	20.51		
Limit	EIRP < 1W			Result									Pass	



Part27Q NR n78 Maximum Average Power [dBm], DG = 3 dBi														
BW	RB	RB	Mod	Antenna 0			Antenna 2			Combine			EIRP	EIRP
(MHz)	Size	Offset		Lowest	Middle	Highest	Lowest	Middle	Highest	Lowest	Middle	Highest	(dBm)	(W)
90	1	1	QPSK	22.44	22.54	22.42	22.55	22.56	22.73	25.51	25.56	25.59	28.59	0.723
90	1	243		22.03	22.15	22.05	22.49	22.58	22.65	25.28	25.38	25.37		
90	123	61		22.04	22.08	22.15	22.53	22.62	22.58	25.30	25.37	25.38		
90	1	0		20.31	20.34	20.44	20.53	20.57	20.62	23.43	23.47	23.54		
90	1	244		19.84	19.83	19.88	20.47	20.54	20.57	23.18	23.21	23.25		
90	245	0		20.50	20.52	20.61	20.98	21.03	21.07	23.76	23.79	23.86		
90	1	1	16-QAM	21.71	21.74	21.91	22.19	22.23	22.36	24.97	25.00	25.15	28.15	0.653
90	1	1	64-QAM	20.16	20.13	20.25	20.52	20.46	20.50	23.35	23.31	23.39		
90	1	1	256-QAM	17.34	17.24	17.39	17.37	17.41	17.42	20.37	20.34	20.42		
Limit	EIRP < 1W			Result									Pass	

Part27Q NR n78 Maximum Average Power [dBm], DG = 3 dBi														
BW	RB	RB	Mod	Antenna 0			Antenna 2			Combine			EIRP	EIRP
(MHz)	Size	Offset		Lowest	Middle	Highest	Lowest	Middle	Highest	Lowest	Middle	Highest	(dBm)	(W)
100	1	1	QPSK	-	22.52	-	-	22.69	-	-	25.62	-	28.62	0.728
100	1	271		-	21.85	-	-	22.62	-	-	25.26	-		
100	137	68		-	22.01	-	-	22.61	-	-	25.33	-		
100	1	0		-	20.28	-	-	20.58	-	-	23.44	-		
100	1	272		-	19.78	-	-	20.50	-	-	23.17	-		
100	273	0		-	20.53	-	-	21.04	-	-	23.80	-		
100	1	1	16-QAM	-	21.74	-	-	22.21	-	-	24.99	-	27.99	0.63
100	1	1	64-QAM	-	20.25	-	-	20.47	-	-	23.37	-		
100	1	1	256-QAM	-	17.36	-	-	17.39	-	-	20.39	-		
Limit	EIRP < 1W			Result									Pass	



# FR1 n77

<SISO Mode>

## Peak-to-Average Ratio

Mode	FR1 n77 / 20MHz / DFT-S OFDM				
Mod.	PI/2 BPSK	QPSK	16QAM	64QAM	Limit: 13dB
RB Size	Full RB	Full RB	Full RB	Full RB	Result
Middle CH	4.02	4.76	5.78	6.08	PASS
Mode	FR1 n77 / 20MHz / DFT-S OFDM				
Mod.	256QAM				Limit: 13dB
RB Size	Full RB				Result
Middle CH	6.50				PASS



FR1 n77 / 20MHz / DFT-S OFDM / Middle Channel / Full RB

PI/2 BPSK

QPSK

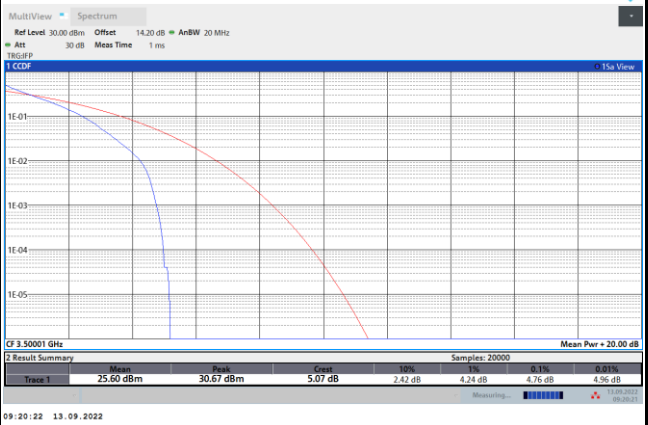
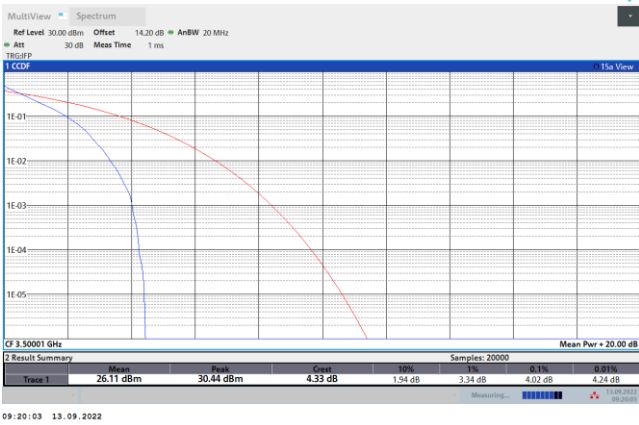

16QAM

64QAM

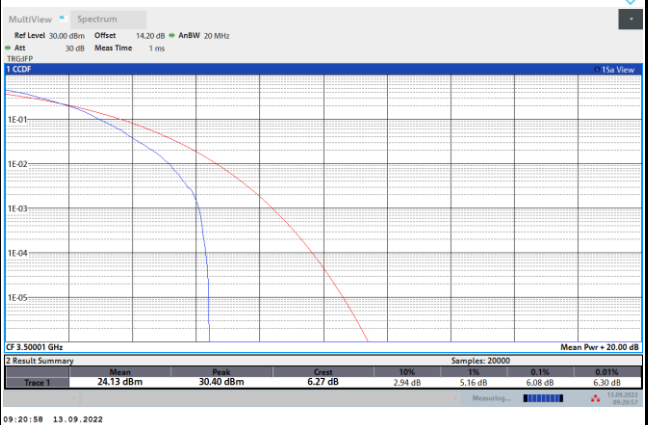
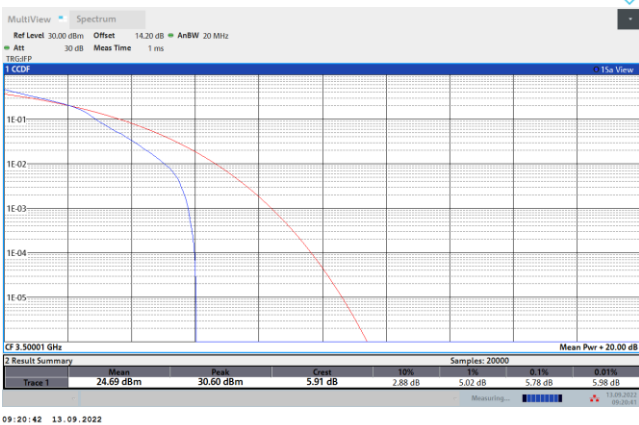

256QAM

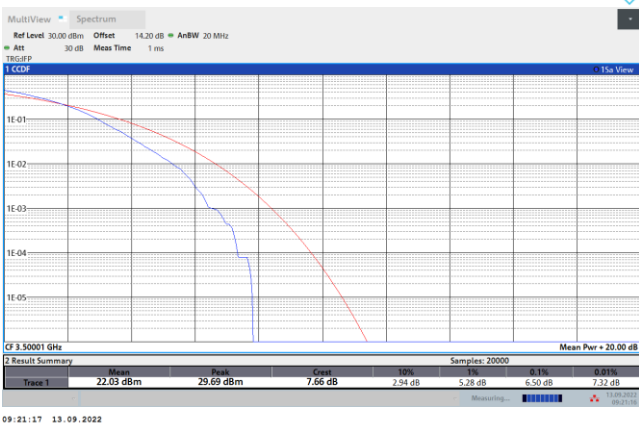



**26dB Bandwidth**

Mode	FR1 n77 : 26dB BW(MHz) / DFT-S OFDM							
BW	10MHz	15MHz	20MHz		30MHz	40MHz	50MHz	60MHz
Mod.	PI/2 BPSK	PI/2 BPSK	PI/2 BPSK		PI/2 BPSK	PI/2 BPSK	PI/2 BPSK	PI/2 BPSK
Middle CH	9.35	13.91	18.94		27.93	38.44	48.35	60.42
BW	70MHz	80MHz	90MHz	100MHz				
Mod.	PI/2 BPSK	PI/2 BPSK	PI/2 BPSK	PI/2 BPSK				
Middle CH	67.13	79.92	89.73	99.30				

Mode	FR1 n77 : 26dB BW(MHz) / CP OFDM							
BW	10MHz		15MHz		20MHz			
Mod.	QPSK	16QAM	QPSK	16QAM	QPSK	16QAM		
Middle CH	9.39	9.43	14.63	14.39	19.14	19.14		
Mod.	64QAM	256QAM	64QAM	256QAM	64QAM	256QAM		
Middle CH	9.45	9.23	14.69	14.33	19.10	19.38		
BW	30MHz		40MHz		50MHz		60MHz	
Mod.	QPSK	16QAM	QPSK	16QAM	QPSK	16QAM	QPSK	16QAM
Middle CH	29.07	29.07	40.36	40.36	49.85	50.35	60.54	60.54
Mod.	64QAM	256QAM	64QAM	256QAM	64QAM	256QAM	64QAM	256QAM
Middle CH	28.77	29.01	40.36	40.44	50.05	50.05	60.66	60.66
BW	70MHz		80MHz		90MHz		100MHz	
Mod.	QPSK	16QAM	QPSK	16QAM	QPSK	16QAM	QPSK	16QAM
Middle CH	70.35	70.35	80.24	80.40	90.45	90.45	100.70	100.70
Mod.	64QAM	256QAM	64QAM	256QAM	64QAM	256QAM	64QAM	256QAM
Middle CH	70.35	70.07	80.24	80.24	90.45	90.45	100.70	100.70





FR1 n77 / 10MHz / DFT-S OFDM / Middle Channel / Full RB

PI/2 BPSK

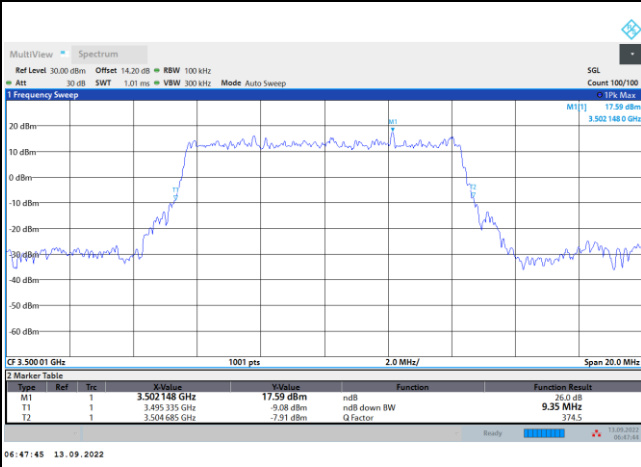

FR1 n77 / 10MHz / CP OFDM / Middle Channel / Full RB

QPSK

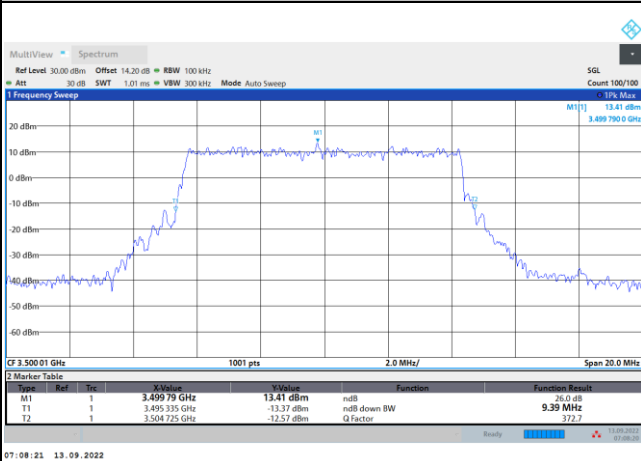

16QAM

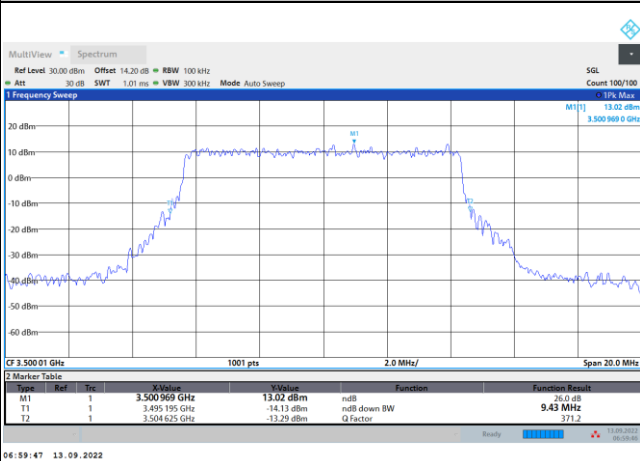

64QAM

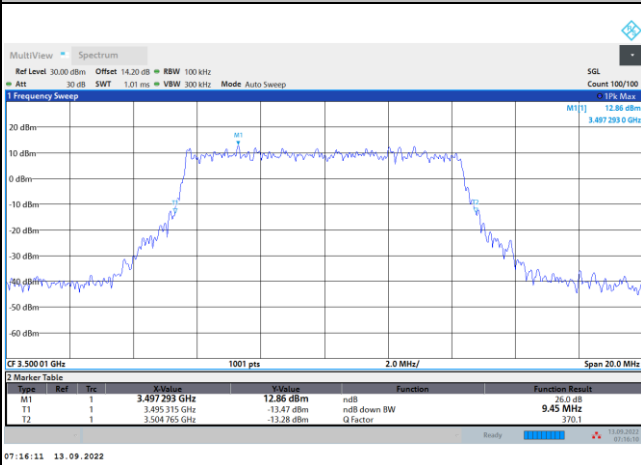

256QAM

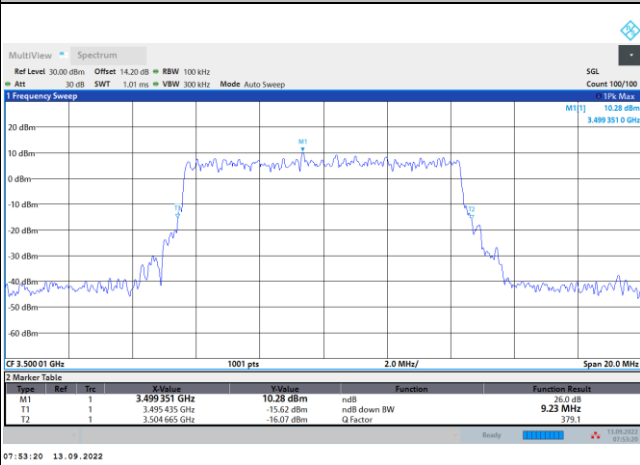



FR1 n77 / 15MHz / DFT-S OFDM / Middle Channel / Full RB

PI/2 BPSK

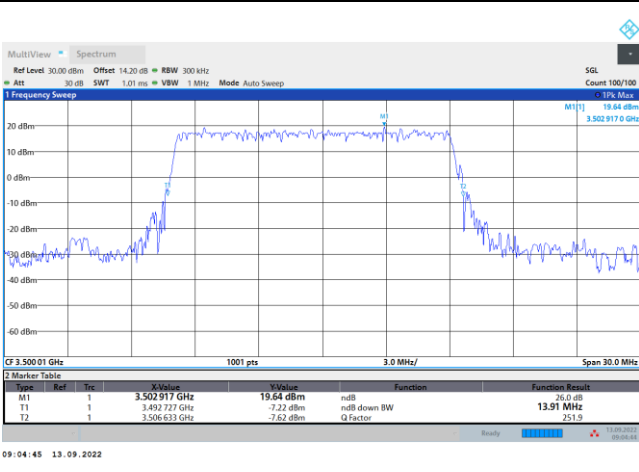

FR1 n77 / 15MHz / CP OFDM / Middle Channel / Full RB

QPSK

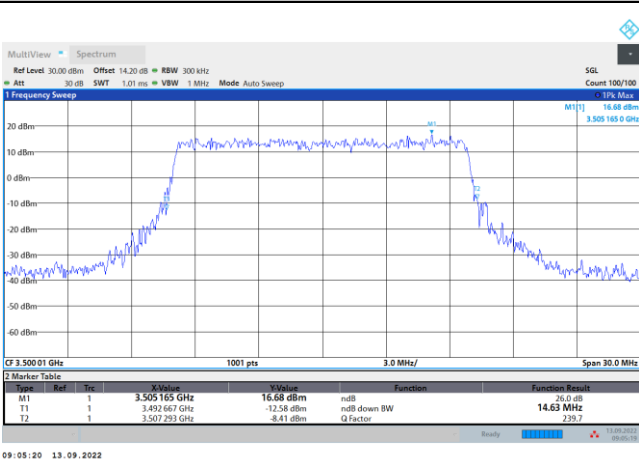

16QAM

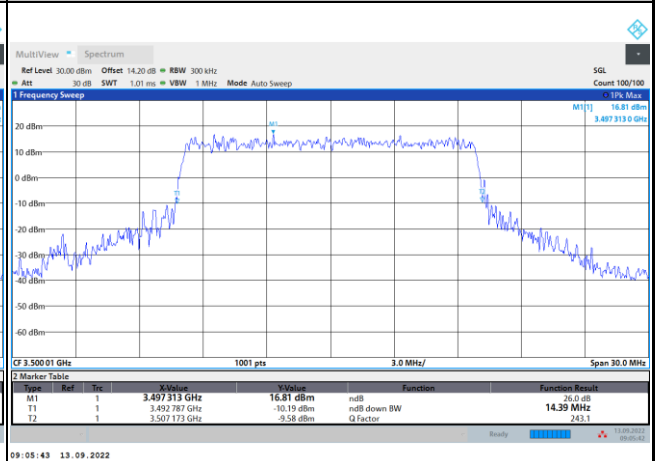

64QAM

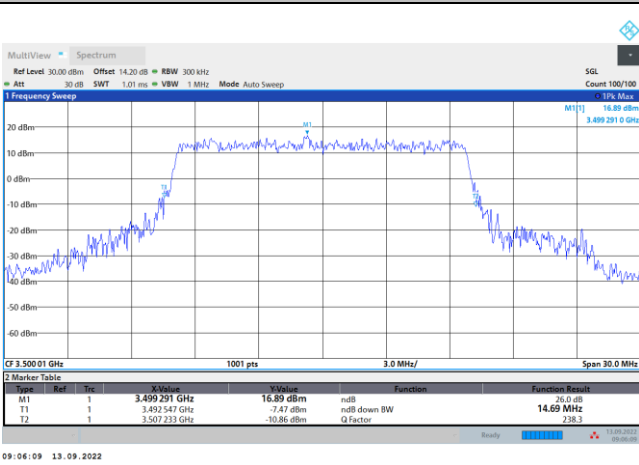

256QAM

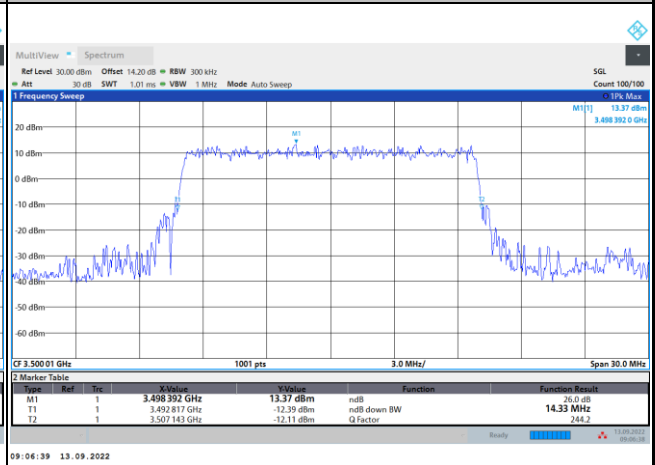



FR1 n77 / 20MHz / DFT-S OFDM / Middle Channel / Full RB

PI/2 BPSK

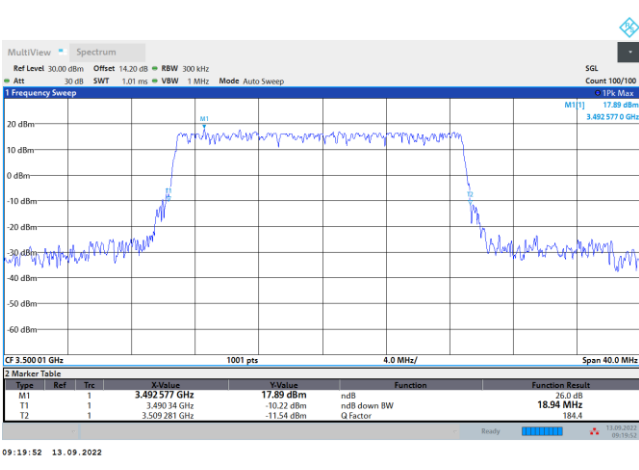

FR1 n77 / 20MHz / CP OFDM / Middle Channel / Full RB

QPSK

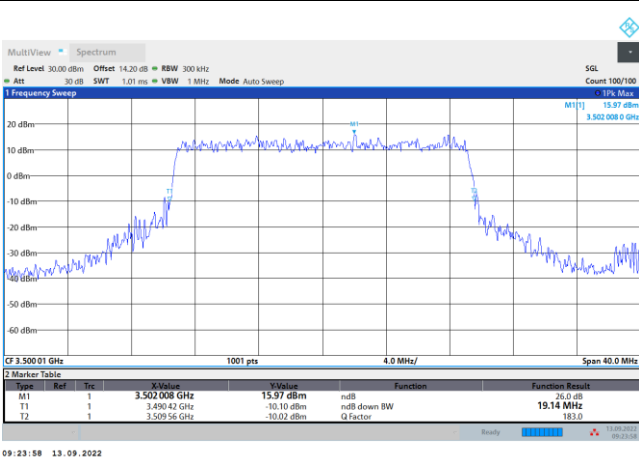

16QAM

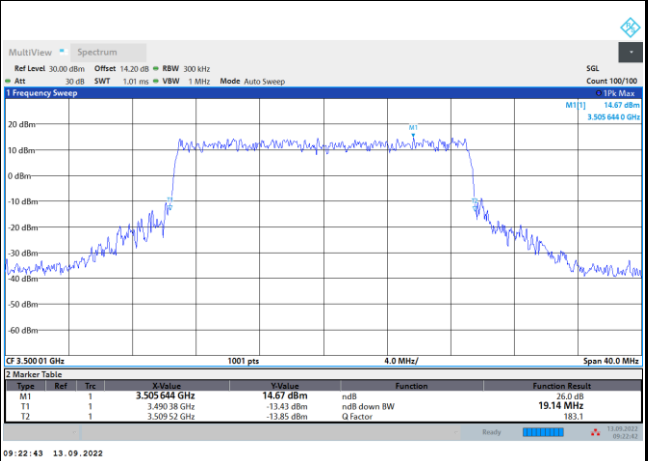

64QAM

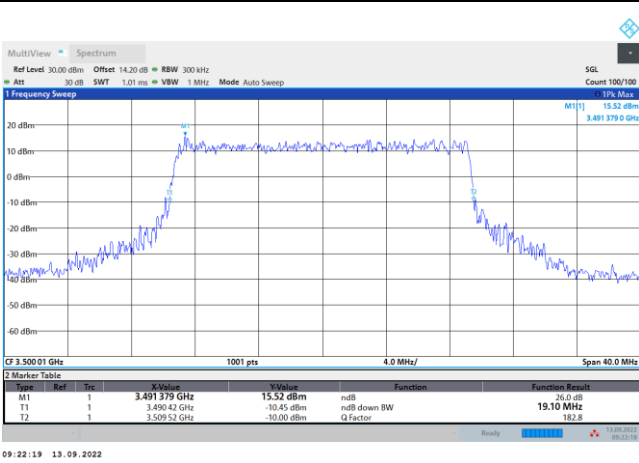

256QAM

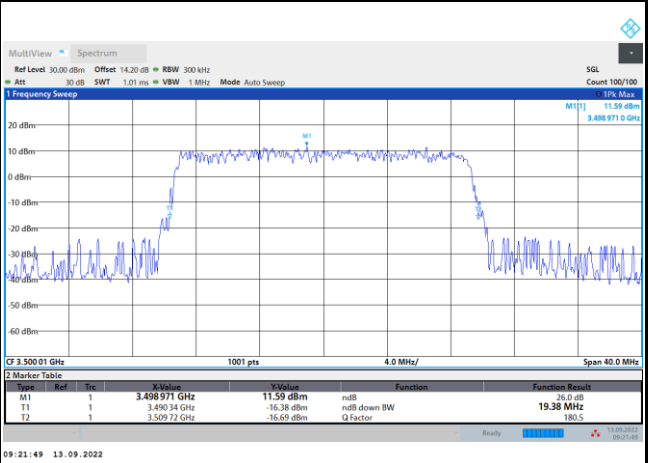



FR1 n77 / 30MHz / DFT-S OFDM / Middle Channel / Full RB

PI/2 BPSK

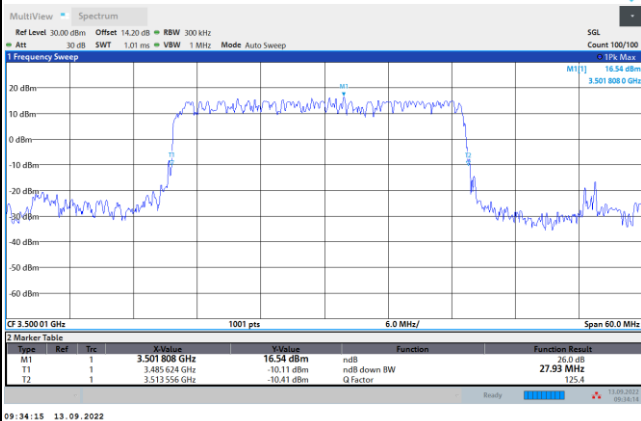

FR1 n77 / 30MHz / CP OFDM / Middle Channel / Full RB

QPSK

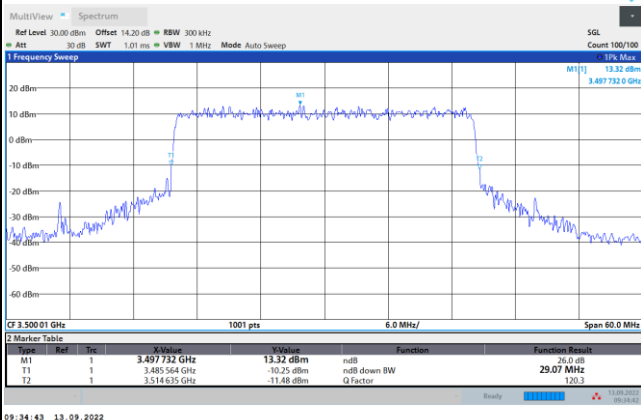

16QAM

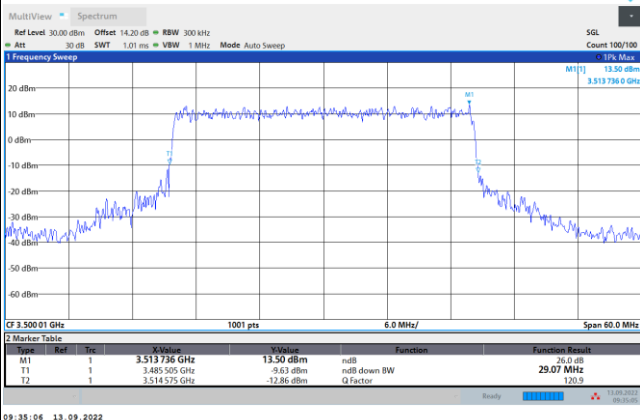

64QAM

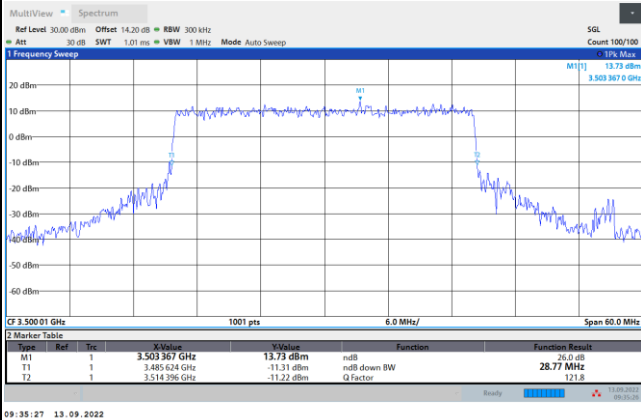

256QAM

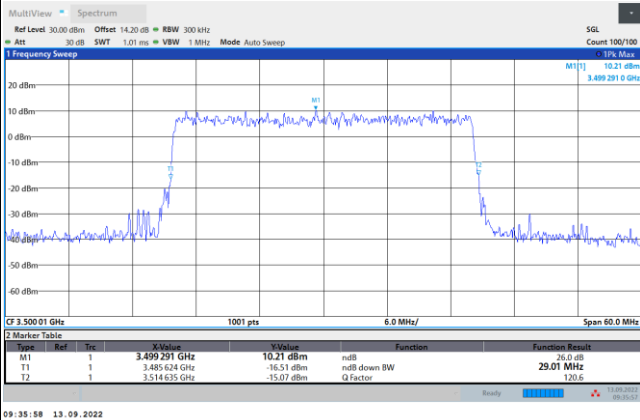



FR1 n77 / 40MHz / DFT-S OFDM / Middle Channel / Full RB

PI/2 BPSK

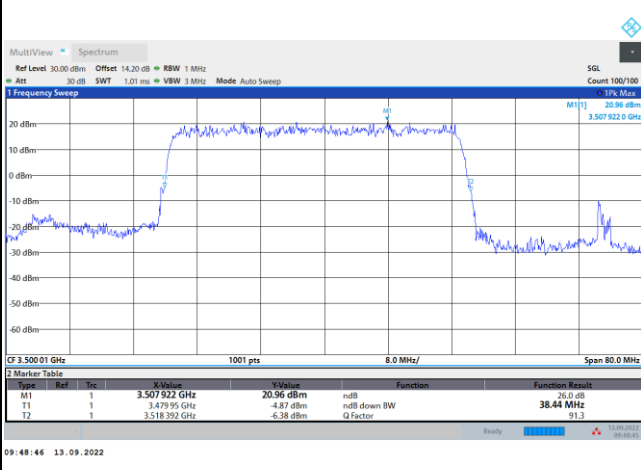

FR1 n77 / 40MHz / CP OFDM / Middle Channel / Full RB

QPSK

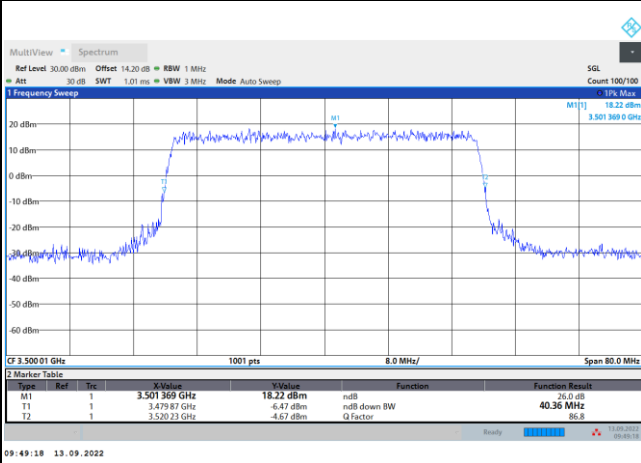

16QAM

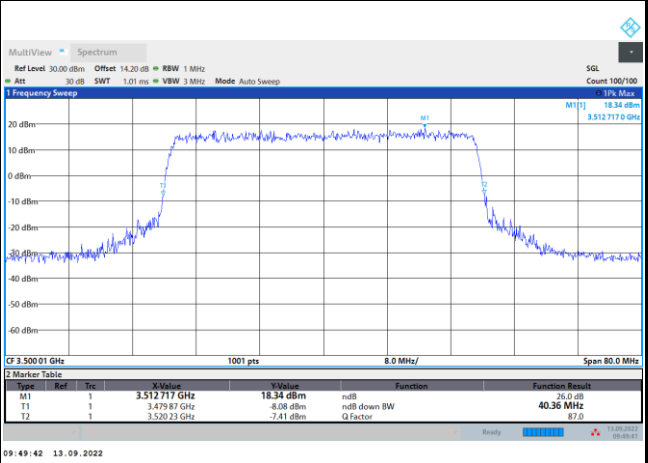

64QAM

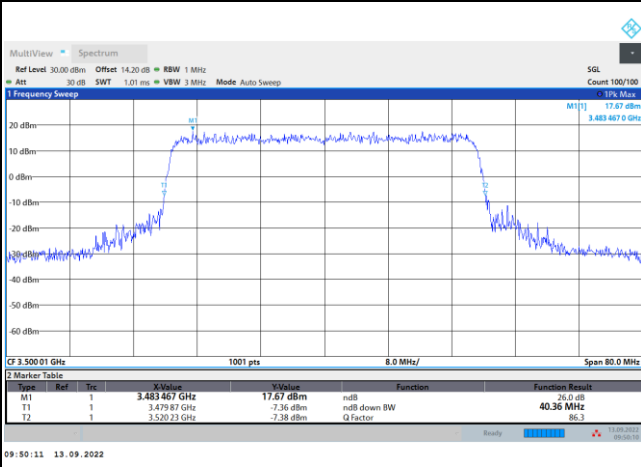

256QAM

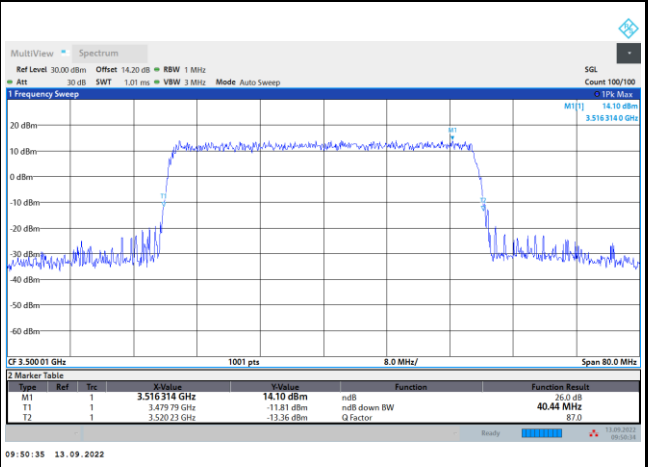



FR1 n77 / 50MHz / DFT-S OFDM / Middle Channel / Full RB

PI/2 BPSK

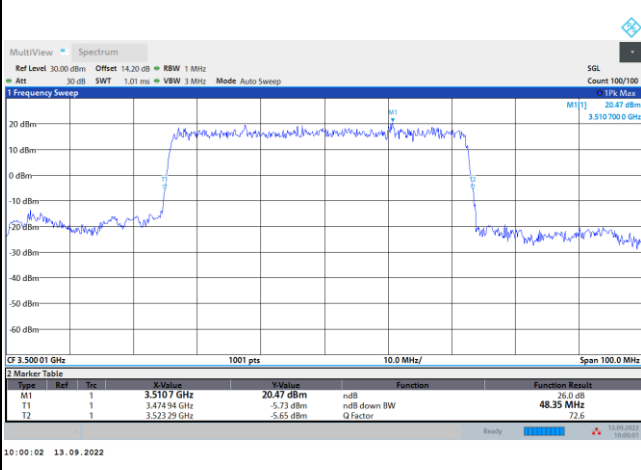

FR1 n77 / 50MHz / CP OFDM / Middle Channel / Full RB

QPSK

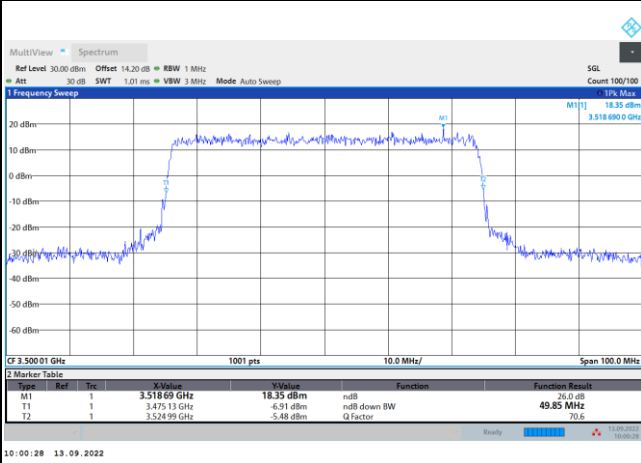

16QAM

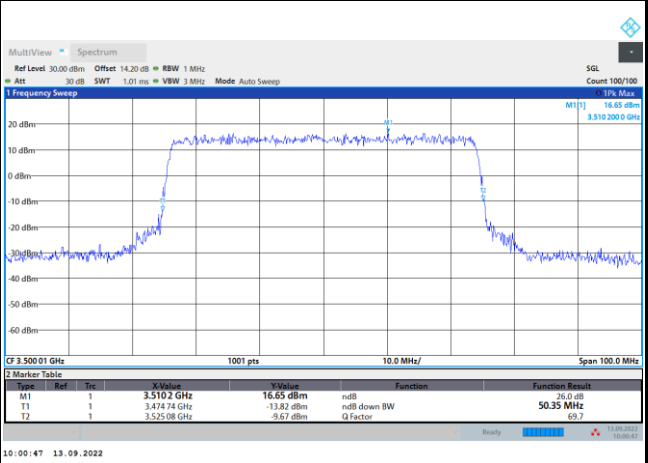

64QAM

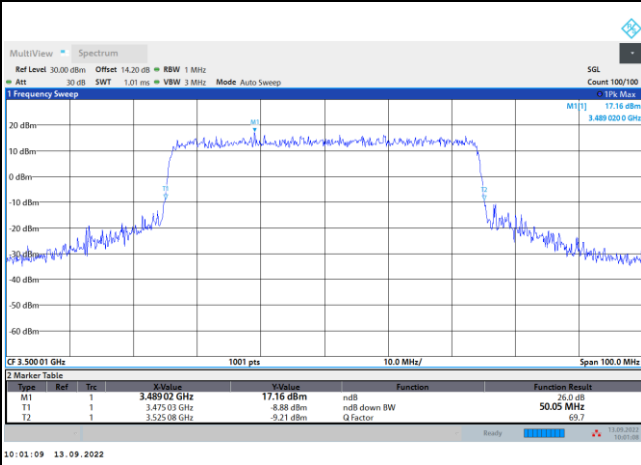

256QAM

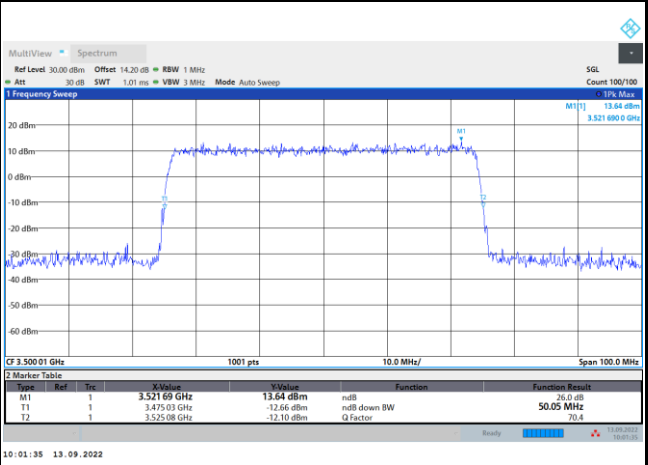



FR1 n77 / 60MHz / DFT-S OFDM / Middle Channel / Full RB

PI/2 BPSK

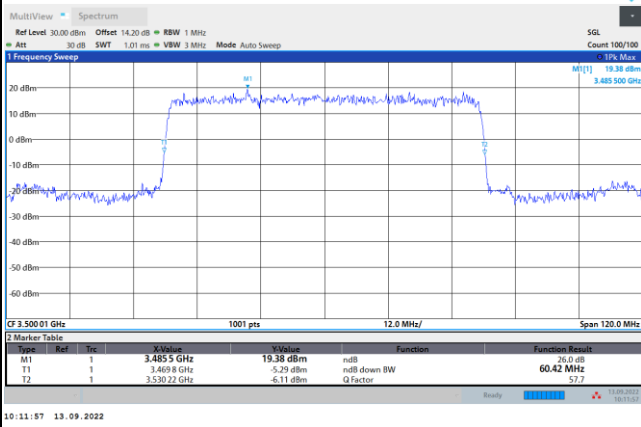

FR1 n77 / 60MHz / CP OFDM / Middle Channel / Full RB

QPSK

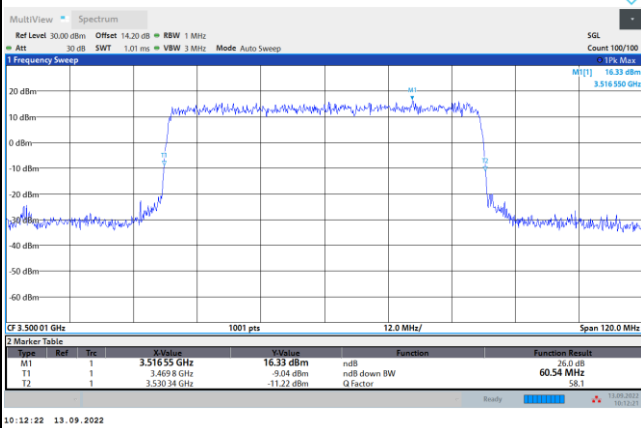

16QAM

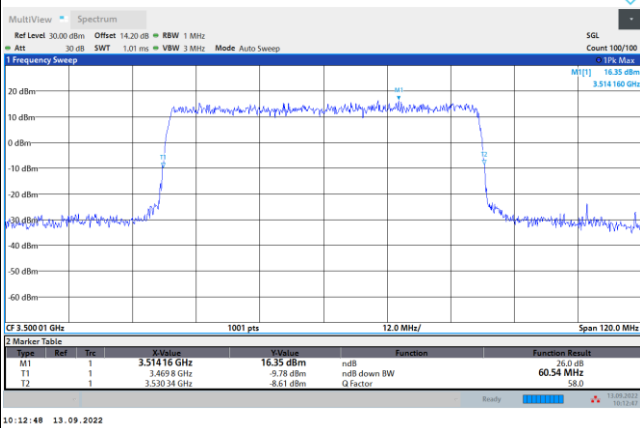

64QAM

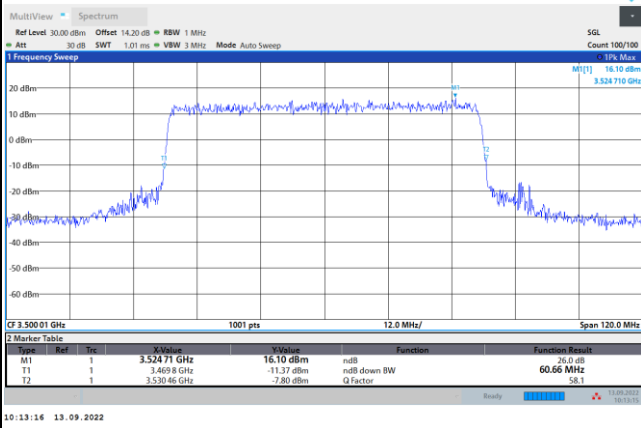

256QAM

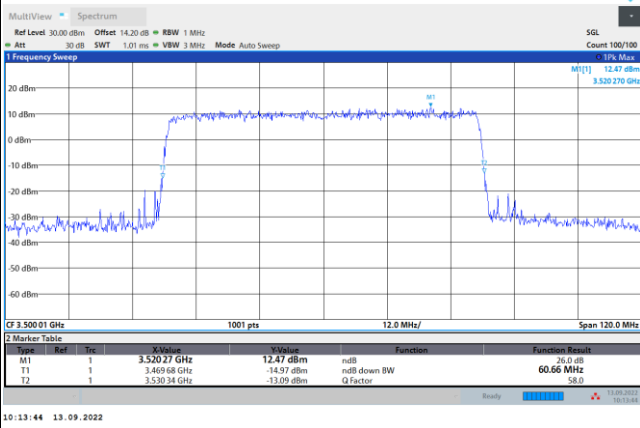



FR1 n77 / 70MHz / DFT-S OFDM / Middle Channel / Full RB

PI/2 BPSK

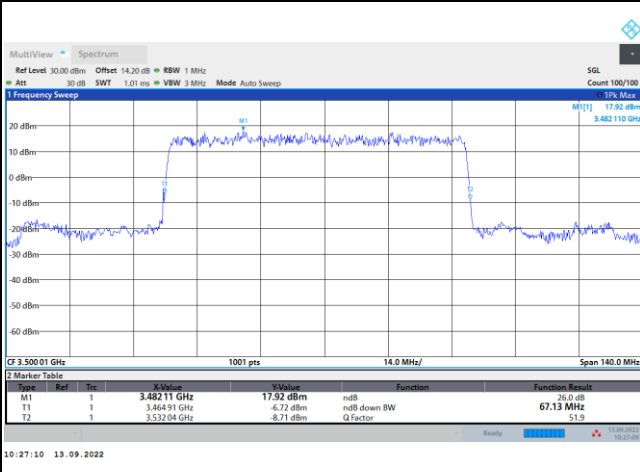

FR1 n77 / 70MHz / CP OFDM / Middle Channel / Full RB

QPSK

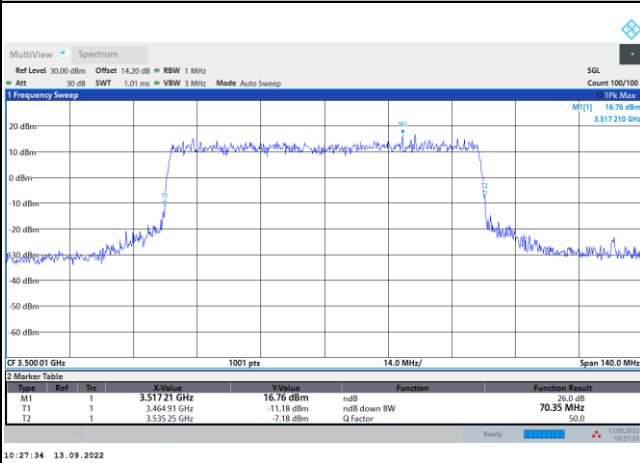

16QAM

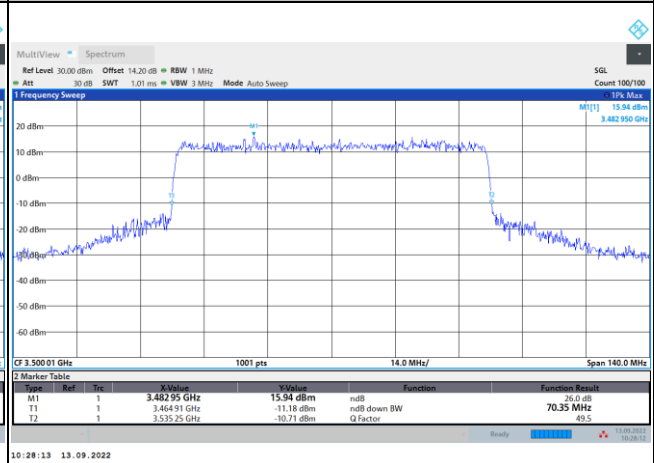

64QAM

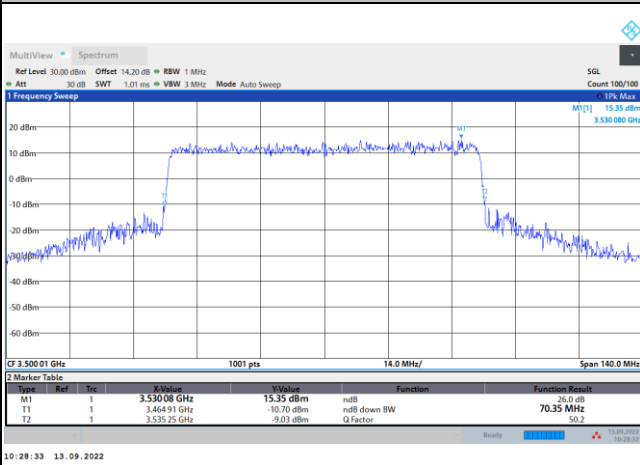

256QAM

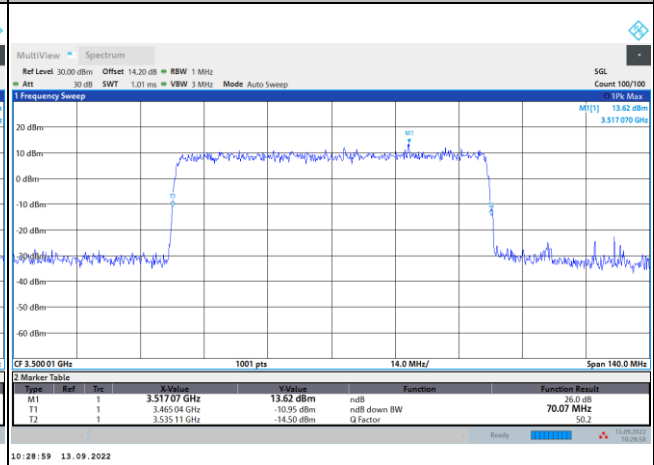





FR1 n77 / 80MHz / DFT-S OFDM / Middle Channel / Full RB

PI/2 BPSK

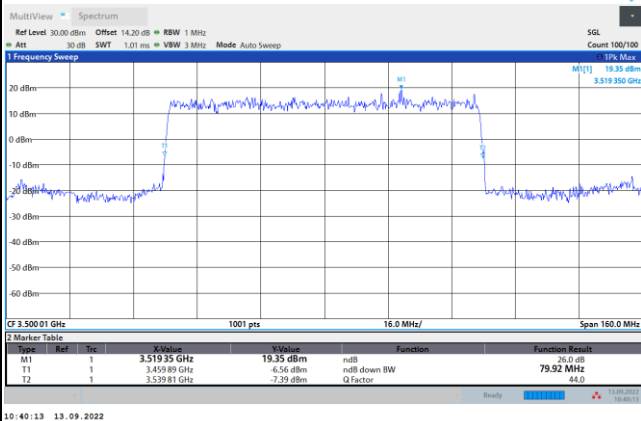

FR1 n77 / 80MHz / CP OFDM / Middle Channel / Full RB

QPSK

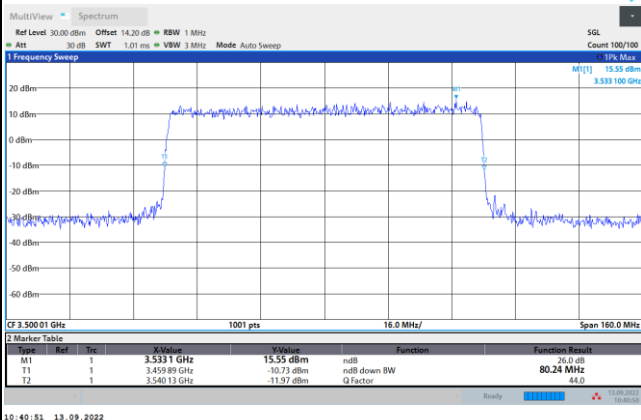

16QAM

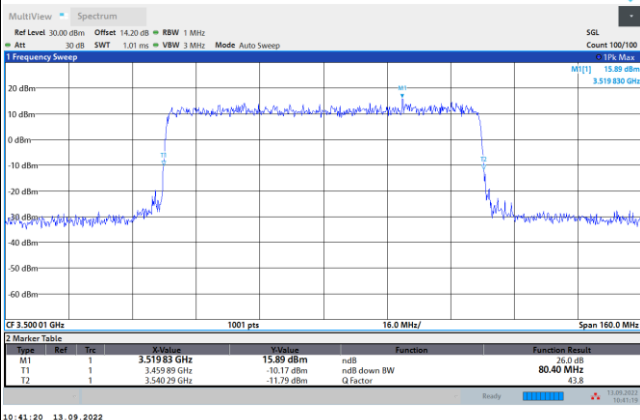

64QAM

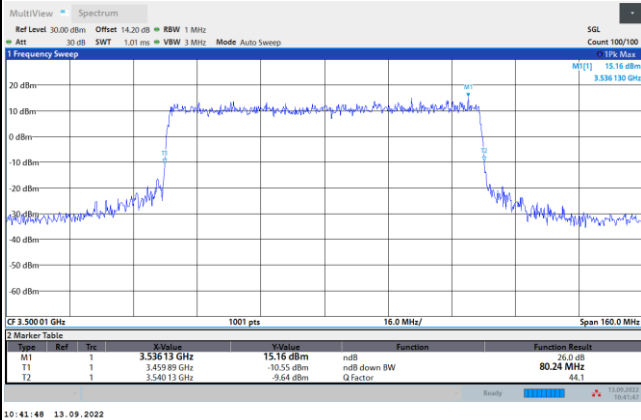

256QAM

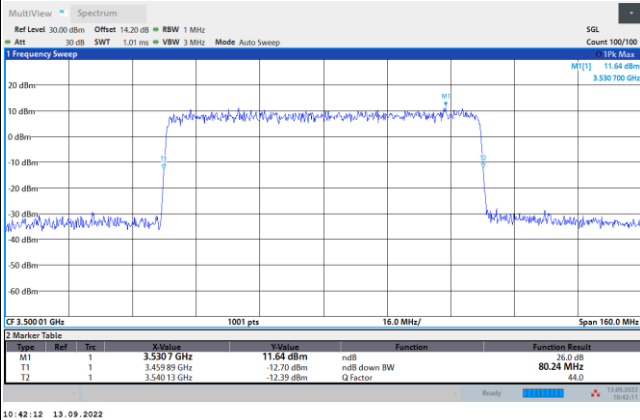



FR1 n77 / 90MHz / DFT-S OFDM / Middle Channel / Full RB

PI/2 BPSK

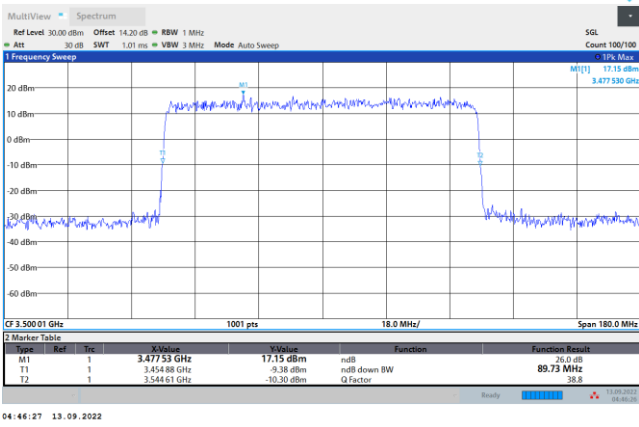

FR1 n77 / 90MHz / CP OFDM / Middle Channel / Full RB

QPSK

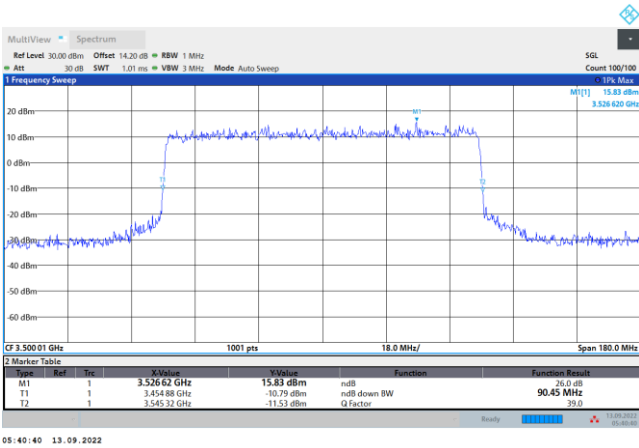

16QAM

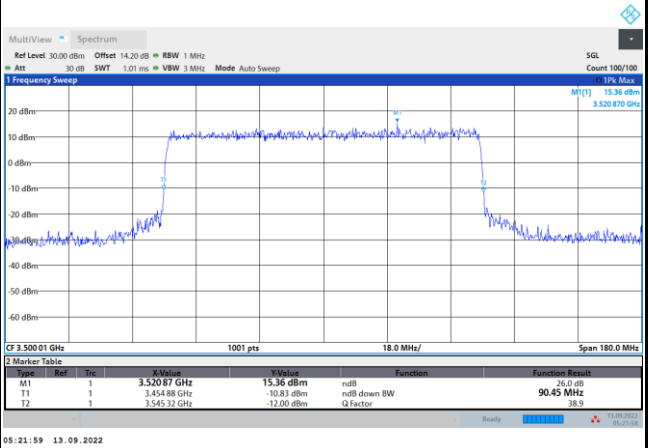

64QAM

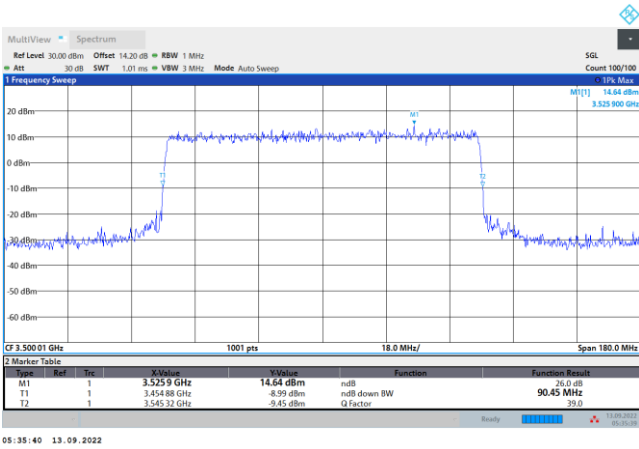

256QAM

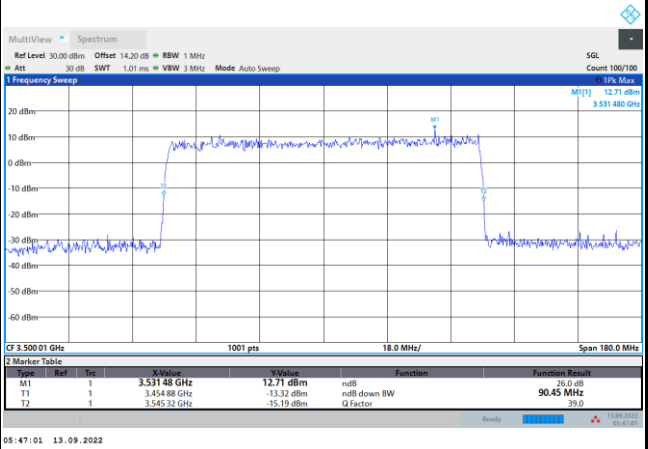



FR1 n77 / 100MHz / DFT-S OFDM / Middle Channel / Full RB

PI/2 BPSK

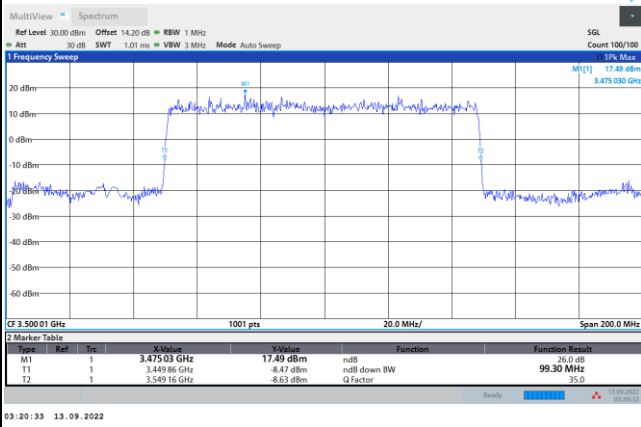

FR1 n77 / 100MHz / CP OFDM / Middle Channel / Full RB

QPSK

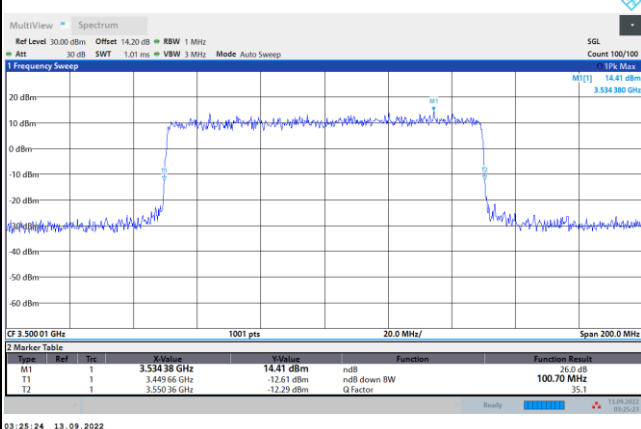

16QAM

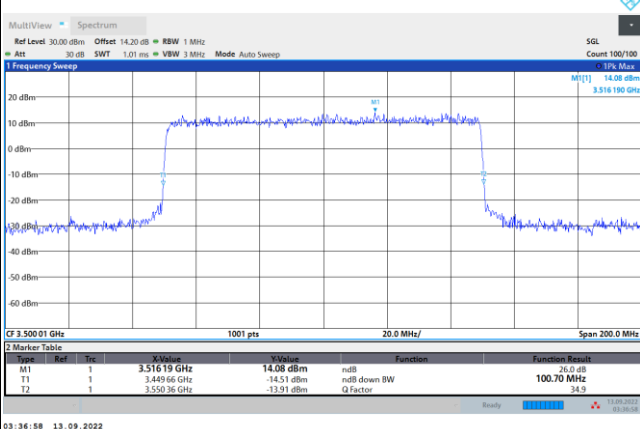

64QAM

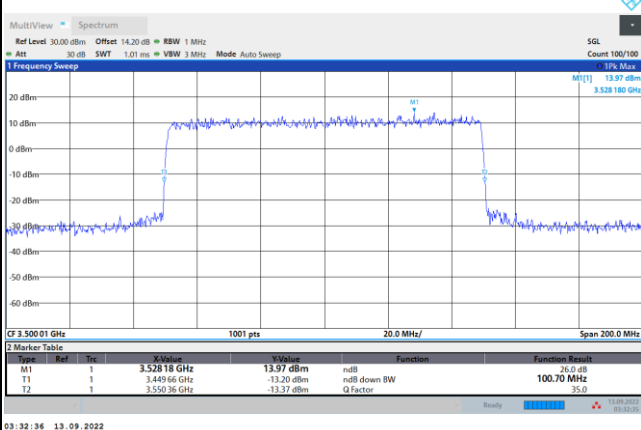

256QAM

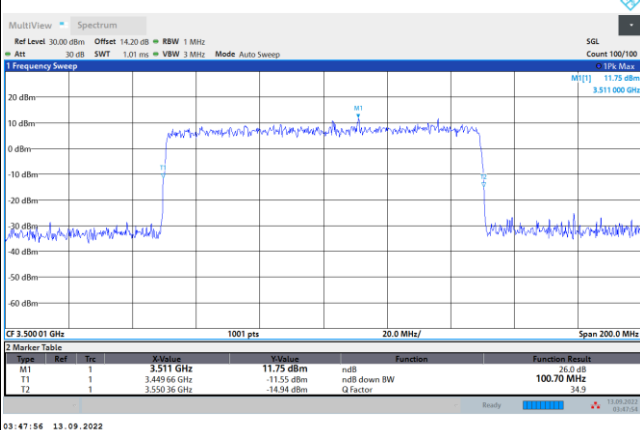



### Occupied Bandwidth

Mode	FR1 n77 : OB BW(MHz) / DFT-S OFDM							
BW	10MHz	15MHz	20MHz		30MHz	40MHz	50MHz	60MHz
Mod.	PI/2 BPSK	PI/2 BPSK	PI/2 BPSK		PI/2 BPSK	PI/2 BPSK	PI/2 BPSK	PI/2 BPSK
Middle CH	8.58	12.90	17.83		26.77	35.96	45.84	57.84
BW	70MHz	80MHz	90MHz	100MHz				
Mod.	PI/2 BPSK	PI/2 BPSK	PI/2 BPSK	PI/2 BPSK				
Middle CH	64.25	77.18	86.65	96.17				

Mode	FR1 n77 : OB BW(MHz) / CP OFDM							
BW	10MHz		15MHz		20MHz			
Mod.	QPSK	16QAM	QPSK	16QAM	QPSK	16QAM		
Middle CH	8.58	8.59	13.62	13.64	18.26	18.25		
Mod.	64QAM	256QAM	64QAM	256QAM	64QAM	256QAM		
Middle CH	8.60	8.58	13.62	13.61	18.17	18.17		
BW	30MHz		40MHz		50MHz		60MHz	
Mod.	QPSK	16QAM	QPSK	16QAM	QPSK	16QAM	QPSK	16QAM
Middle CH	27.79	27.83	37.92	37.97	47.50	47.59	57.79	57.89
Mod.	64QAM	256QAM	64QAM	256QAM	64QAM	256QAM	64QAM	256QAM
Middle CH	27.81	27.84	38.08	38.01	47.66	47.52	57.82	57.85
BW	70MHz		80MHz		90MHz		100MHz	
Mod.	QPSK	16QAM	QPSK	16QAM	QPSK	16QAM	QPSK	16QAM
Middle CH	67.60	67.45	77.57	77.54	87.36	87.43	97.30	97.31
Mod.	64QAM	256QAM	64QAM	256QAM	64QAM	256QAM	64QAM	256QAM
Middle CH	67.54	67.22	77.49	77.22	87.56	87.60	97.36	97.34



FR1 n77 / 10MHz / DFT-S OFDM / Middle Channel / Full RB

PI/2 BPSK

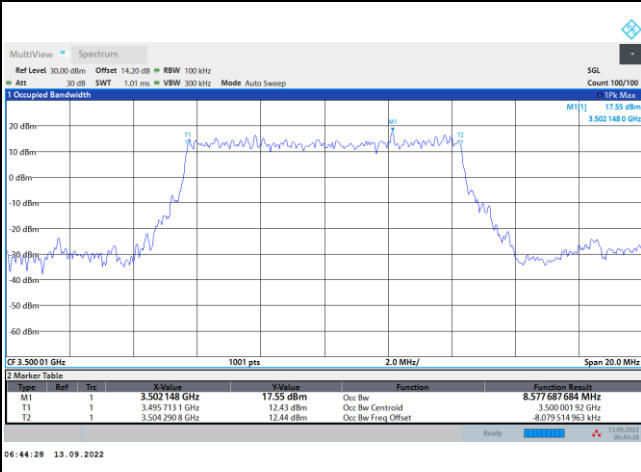

FR1 n77 / 10MHz / CP OFDM / Middle Channel / Full RB

QPSK

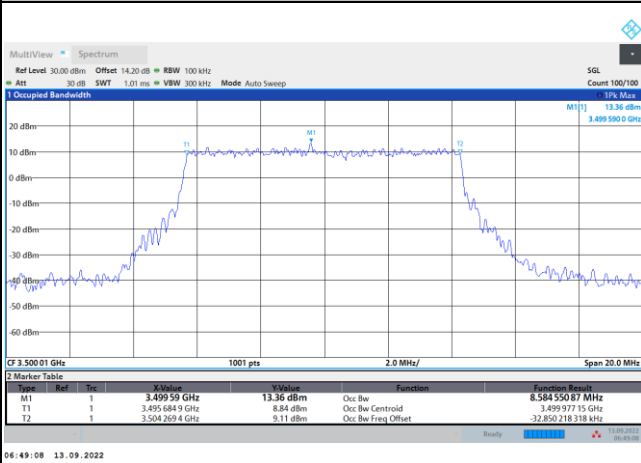

16QAM

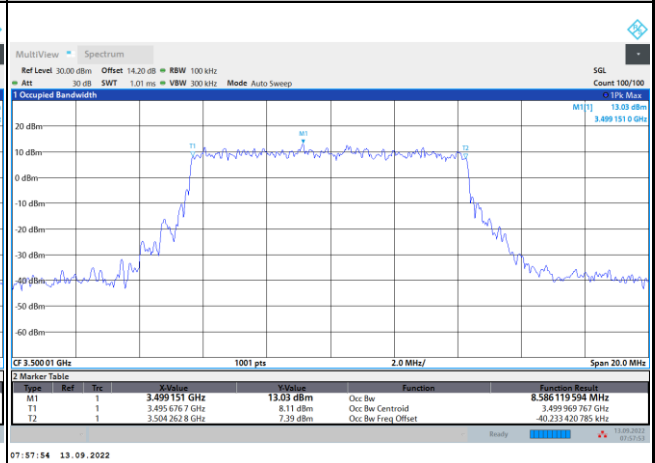

64QAM

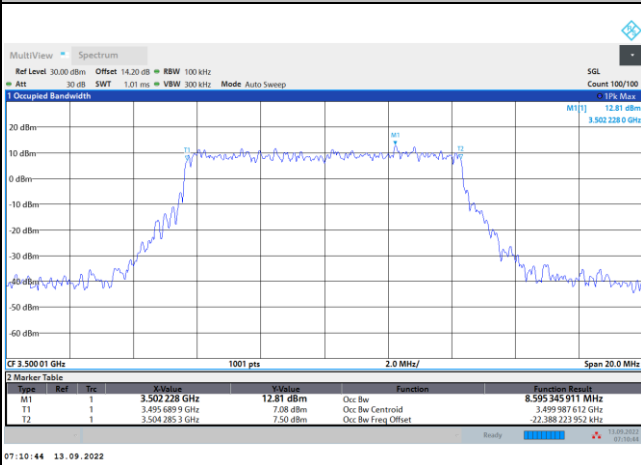

256QAM

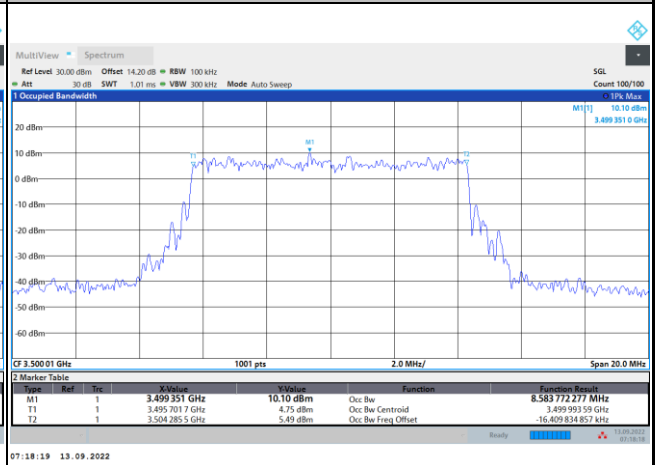



FR1 n77 / 15MHz / DFT-S OFDM / Middle Channel / Full RB

PI/2 BPSK

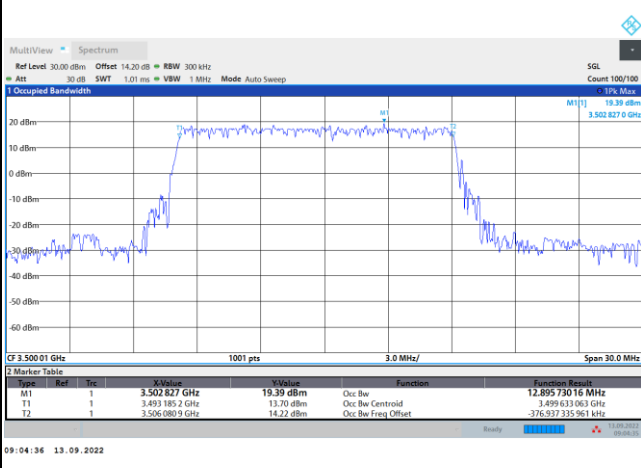

FR1 n77 / 15MHz / CP OFDM / Middle Channel / Full RB

QPSK

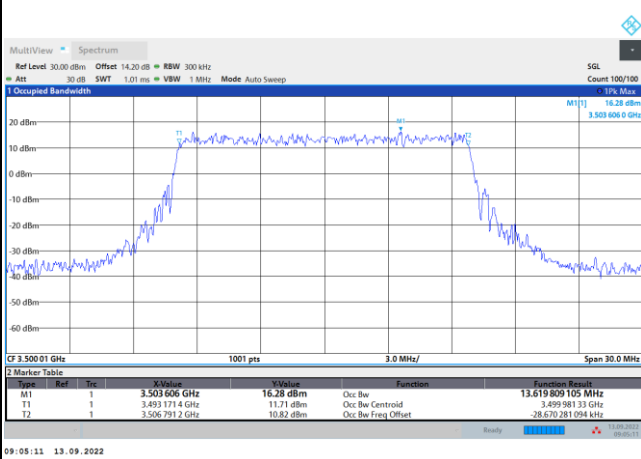

16QAM

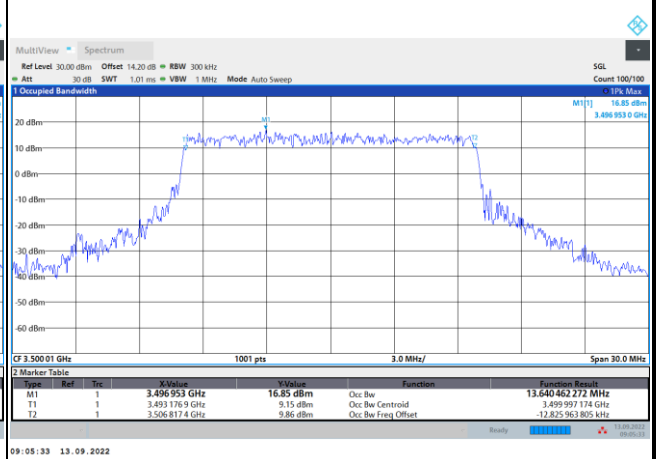

64QAM

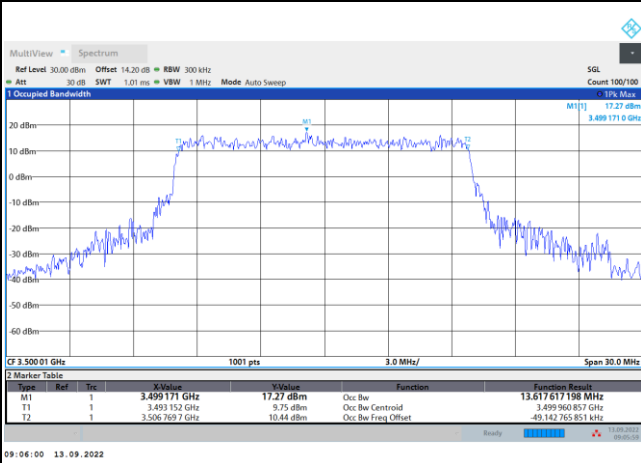

256QAM

