

### LTE Band 13

### Spectrum Plot of Measurement Value

Channel: 23230 / Frequency (MHz): 782.0MHz

#### QPSK

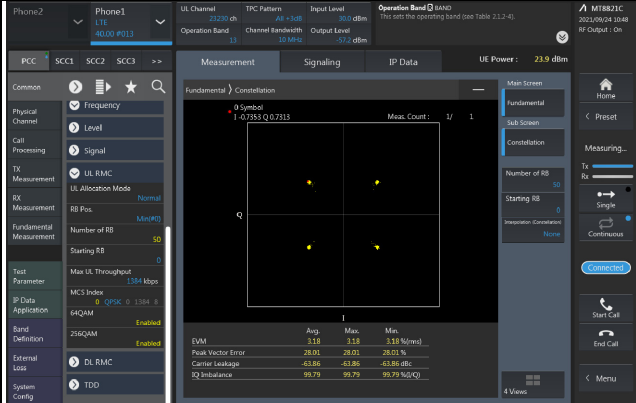

#### 16QAM

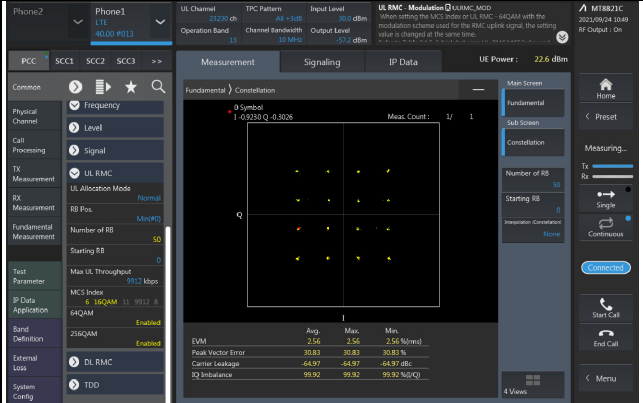

#### 64QAM

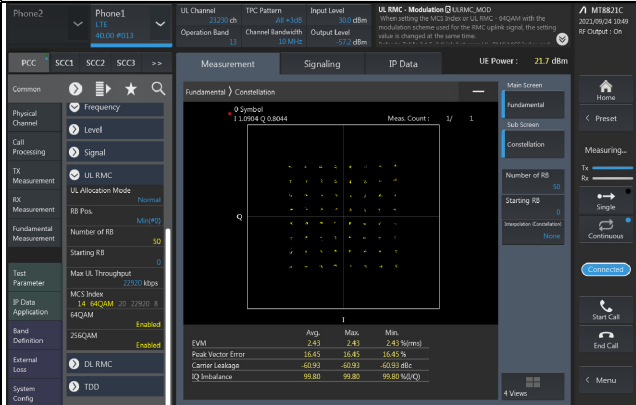

#### 256QAM

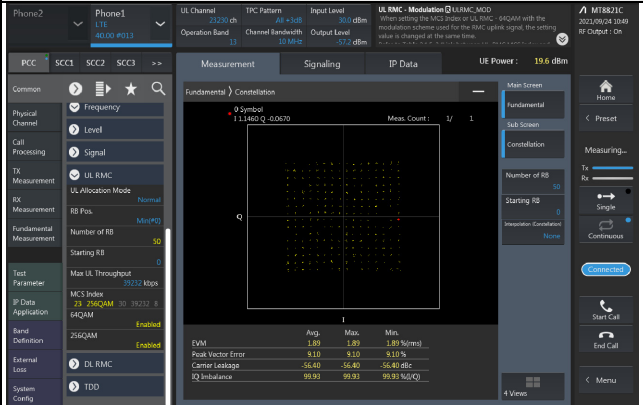

### LTE Band 14

### Spectrum Plot of Measurement Value

Channel: 23330 / Frequency (MHz): 793.0MHz

#### QPSK

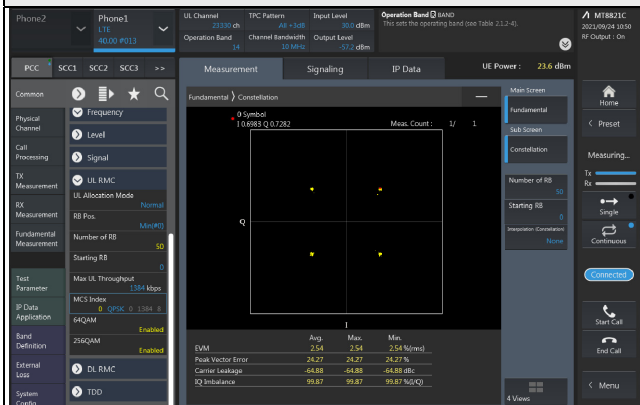

#### 16QAM

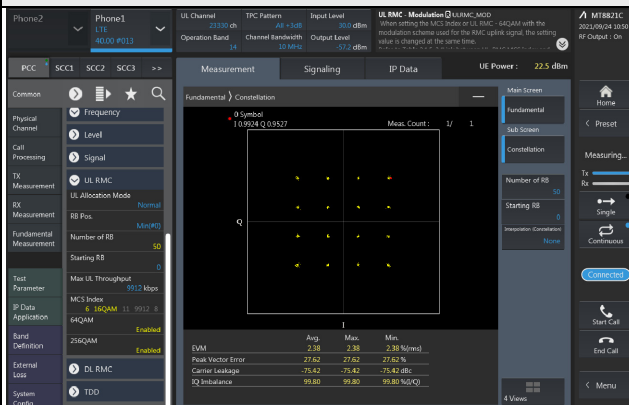

#### 64QAM

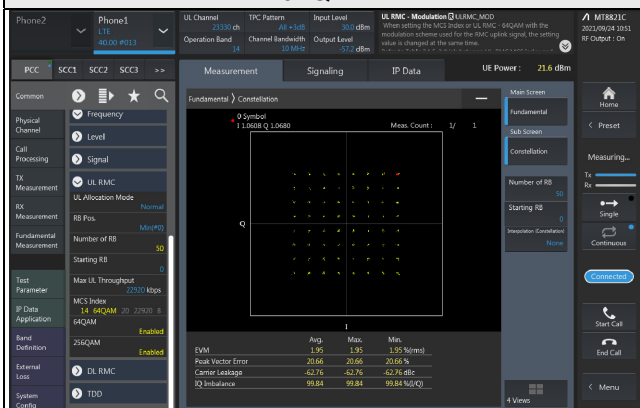

#### 256QAM

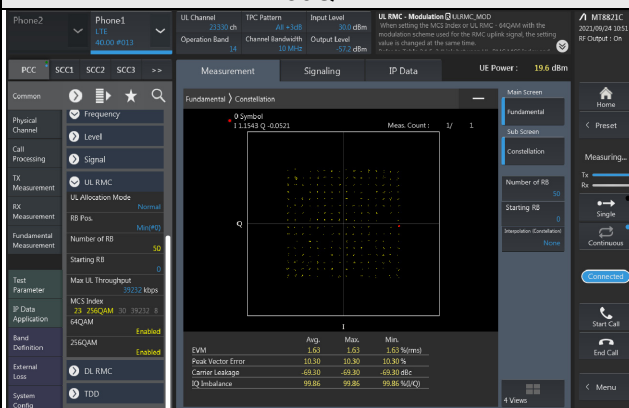

### LTE Band 30

### Spectrum Plot of Measurement Value

Channel: 27710 / Frequency (MHz): 2310.0 MHz

#### QPSK

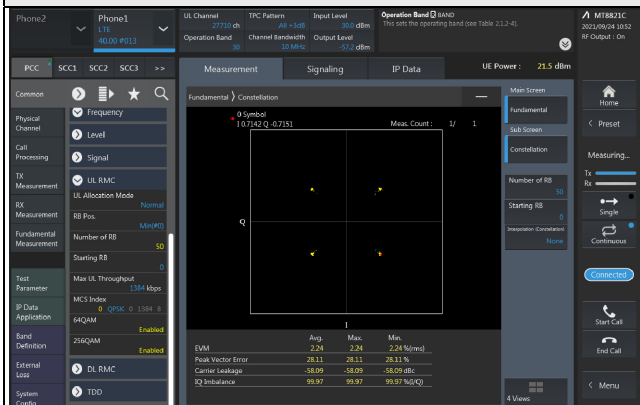

#### 16QAM

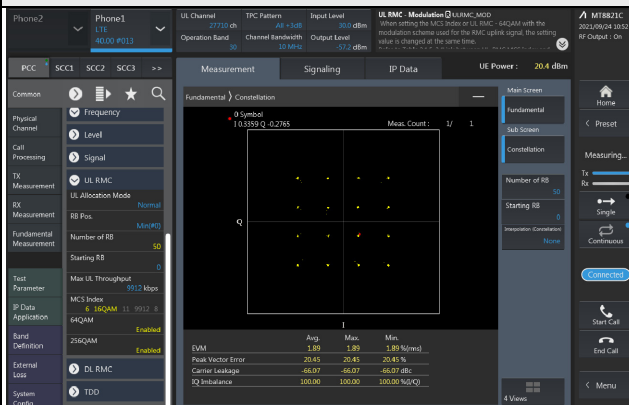

#### 64QAM

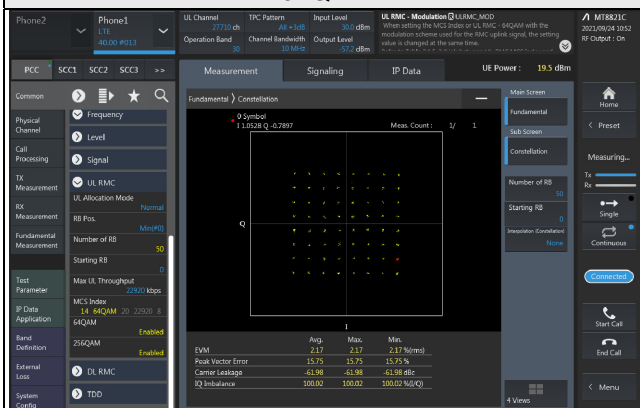

#### 256QAM

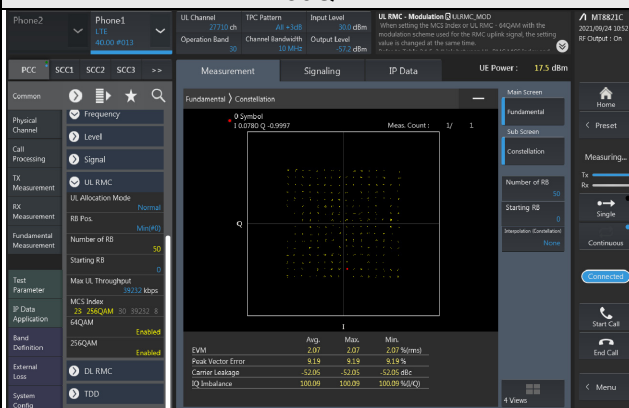

### LTE Band 41

### Spectrum Plot of Measurement Value

Channel: 40620 / Frequency (MHz): 2593.0 MHz

#### QPSK

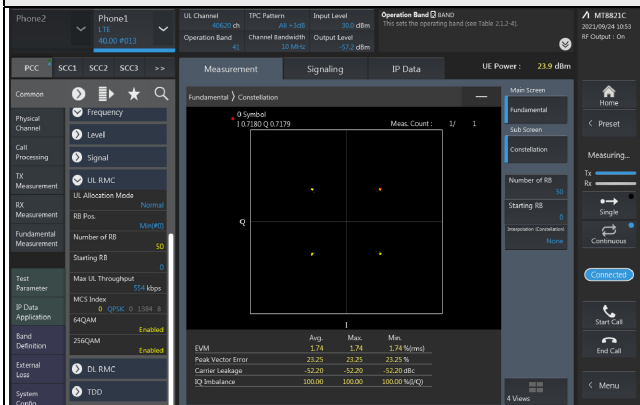

#### 16QAM

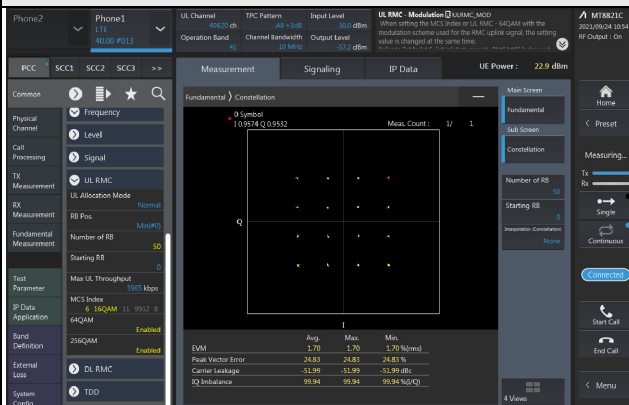

#### 64QAM

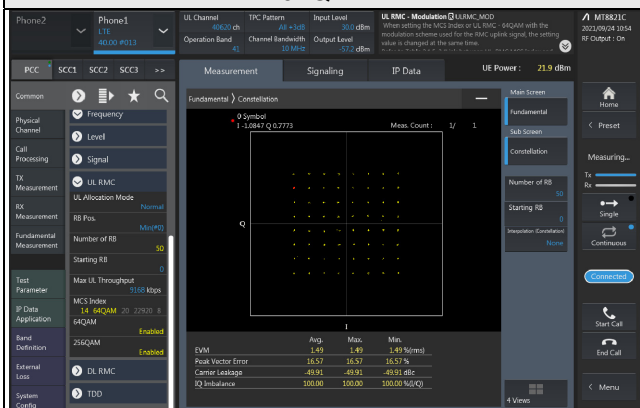

#### 256QAM

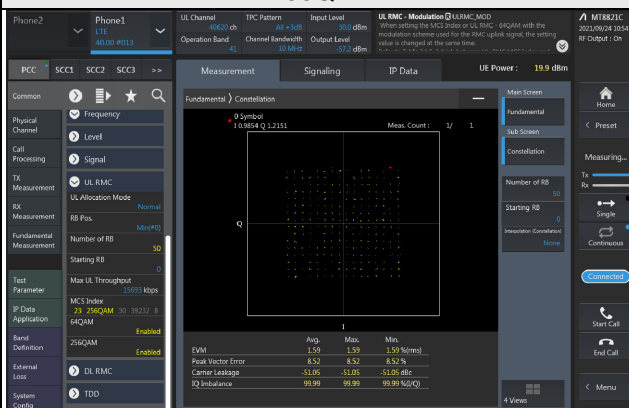

### LTE Band 66

### Spectrum Plot of Measurement Value

Channel: 132322 / Frequency (MHz): 1745.0 MHz

#### QPSK

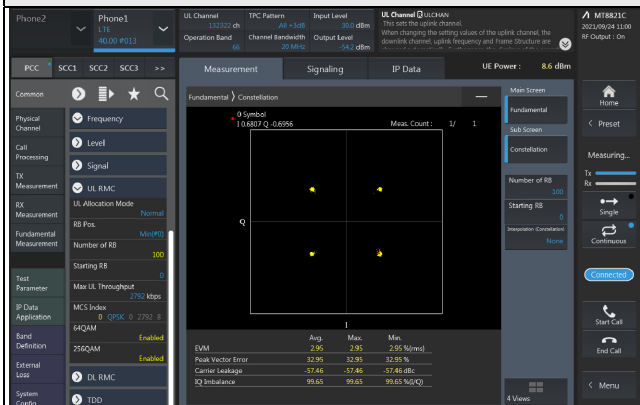

#### 16QAM

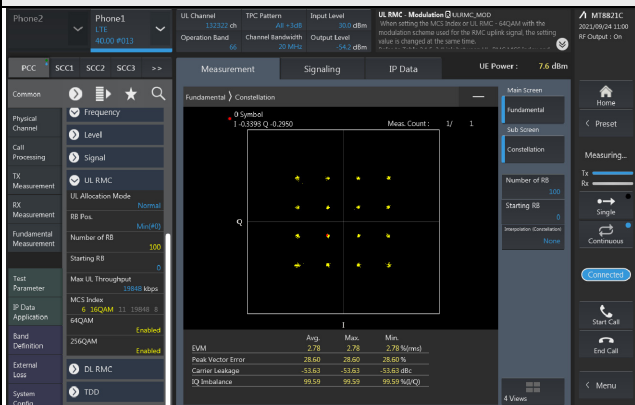

#### 64QAM

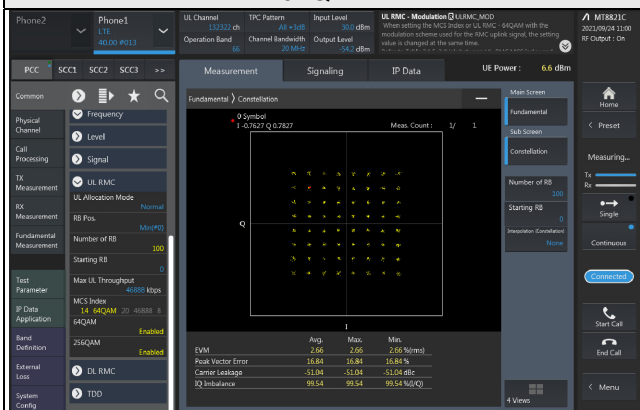

#### 256QAM

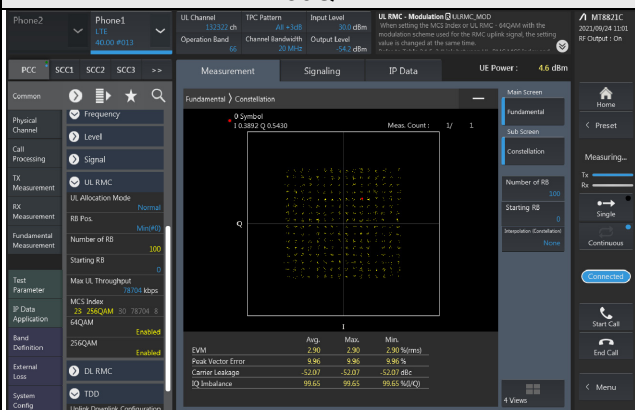

### 4.3 Frequency Stability Measurement

#### 4.3.1 Limits of Frequency Stability Measurement

The frequency stability shall be sufficient to ensure that the fundamental emissions stay within the authorized bands of operation.

According to the FCC part 2.1055 shall be tested the frequency stability. The rule is defined that "The frequency stability shall be sufficient to ensure that the fundamental emission stays within the authorized frequency block." The test extreme voltage is according to the 2.1055(d)(1) Vary primary supply voltage from 85 to 115 percent of the nominal value for other than hand carried battery equipment and the extreme temperature rule is comply with specification of EUT  $-30^{\circ}\text{C} \sim 50^{\circ}\text{C}$ .

#### 4.3.2 Test Procedure

- Device is placed at the oven room. The oven room could control the temperatures and humidity. Power warm up is at least 15 min and power applied should perform before recording frequency error.
- EUT is connected the external power supply to control the DC input power. The test voltage range is from minimum to maximum working voltage. Each step shall be record the frequency error rate.
- The temperature range step is 10 degrees in this test items. All temperature levels shall be hold the  $\pm 0.5^{\circ}\text{C}$  during the measurement testing. The each temperature step shall be at least 0.5 hours, consider the EUT could be test under the stability condition.

Note: The frequency error was recorded frequency error from the communication simulator.

#### 4.3.3 Test Instruments

Description & Manufacturer	Model No.	Serial No.	Cal. Date	Cal. Due
5G Wireless Test Platforms Keysight	E7515B	MY60102114	May 21, 2021	May 20, 2022
Temperature & Humidity Chamber TERCHY	HRM-120RF	931022	Dec. 24, 2020	Dec. 23, 2021
Digital Multimeter Fluke	87-III	70360742	Jun. 24, 2021	Jun. 23, 2022
DC Power Supply Topward	6306A	727263	NA	NA

Note: 1. The calibration interval of the above test instruments is 12 months and the calibrations are traceable to NML/ROC and NIST/USA.

#### 4.3.4 Test Setup

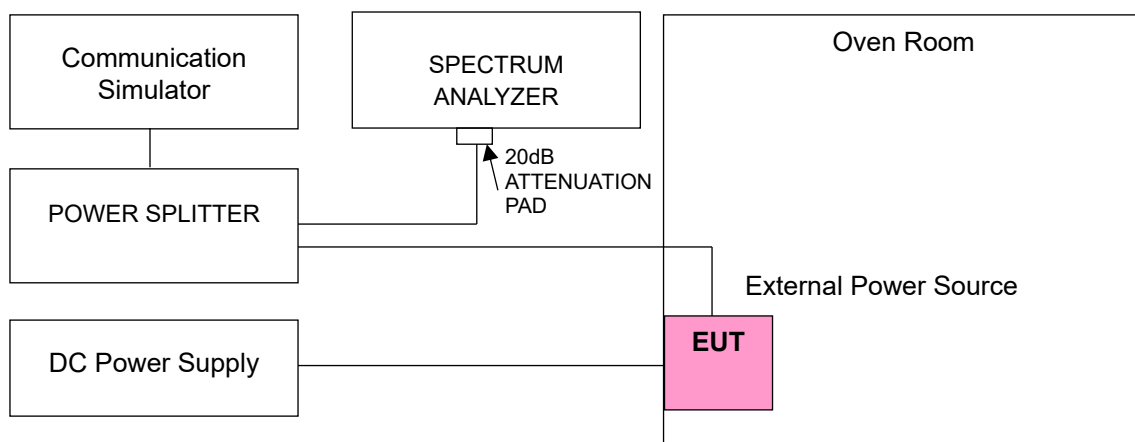

#### 4.3.5 Test Results

##### Frequency Error vs. Voltage

Voltage (Vdc)	5GNR n77 (Part 270)			
	Channel Bandwidth 20 MHz			
	Low Channel		High Channel	
	Frequency (MHz)	Frequency Error (ppm)	Frequency (MHz)	Frequency Error (ppm)
4.25	3710.010010	0.003	3969.990000	0.003
5	3710.010033	0.009	3969.990000	0.006
5.75	3710.010039	0.011	3969.990000	0.006

Note: The applicant defined the normal working voltage is from 4.25Vdc to 5.75Vdc.

##### Frequency Error vs. Temperature

Temp. (°C)	5GNR n77 (Part 270)			
	Channel Bandwidth 20 MHz			
	Low Channel		High Channel	
	Frequency (MHz)	Frequency Error (ppm)	Frequency (MHz)	Frequency Error (ppm)
-30	3710.010010	0.003	3969.990000	0.009
-20	3710.010021	0.006	3969.990000	0.007
-10	3710.010015	0.004	3969.990000	0.008
0	3710.010015	0.004	3969.990000	0.008
10	3710.009990	-0.003	3969.990000	-0.008
20	3710.009985	-0.004	3969.990000	-0.005
30	3710.009987	-0.004	3969.990000	-0.004
40	3710.009983	-0.005	3969.990000	-0.007
50	3710.009975	-0.007	3969.990000	-0.006

### Frequency Error vs. Voltage

Voltage (Vdc)	5GNR n77 (Part 270)			
	Channel Bandwidth 40 MHz			
	Low Channel		High Channel	
	Frequency (MHz)	Frequency Error (ppm)	Frequency (MHz)	Frequency Error (ppm)
4.25	3720.000030	0.008	3960.000018	0.005
5	3720.000038	0.010	3960.000015	0.004
5.75	3720.000031	0.008	3960.000033	0.008

Note: The applicant defined the normal working voltage is from 4.25Vdc to 5.75Vdc.

### Frequency Error vs. Temperature

Temp. (°C)	5GNR n77 (Part 270)			
	Channel Bandwidth 40 MHz			
	Low Channel		High Channel	
	Frequency (MHz)	Frequency Error (ppm)	Frequency (MHz)	Frequency Error (ppm)
-30	3720.000015	0.004	3960.000012	0.003
-20	3720.000038	0.010	3960.000014	0.004
-10	3720.000013	0.004	3960.000016	0.004
0	3720.000020	0.005	3960.000018	0.005
10	3719.999978	-0.006	3959.999975	-0.006
20	3719.999960	-0.011	3959.999972	-0.007
30	3719.999968	-0.009	3959.999985	-0.004
40	3719.999980	-0.005	3959.999970	-0.008
50	3719.999985	-0.004	3959.999969	-0.008



Frequency Error vs. Voltage

Voltage (Vdc)	5GNR n77 (Part 270)			
	Channel Bandwidth 50 MHz			
	Low Channel		High Channel	
	Frequency (MHz)	Frequency Error (ppm)	Frequency (MHz)	Frequency Error (ppm)
4.25	3725.010032	0.009	3954.990018	0.005
5	3725.010020	0.005	3954.990025	0.006
5.75	3725.010032	0.009	3954.990028	0.007

Note: The applicant defined the normal working voltage is from 4.25Vdc to 5.75Vdc.

Frequency Error vs. Temperature

Temp. (°C)	5GNR n77 (Part 270)			
	Channel Bandwidth 50 MHz			
	Low Channel		High Channel	
	Frequency (MHz)	Frequency Error (ppm)	Frequency (MHz)	Frequency Error (ppm)
-30	3725.010020	0.005	3954.990026	0.007
-20	3725.010029	0.008	3954.990027	0.007
-10	3725.010035	0.009	3954.990037	0.009
0	3725.010020	0.005	3954.990031	0.008
10	3725.009979	-0.006	3954.989983	-0.004
20	3725.009960	-0.011	3954.989981	-0.005
30	3725.009983	-0.005	3954.989977	-0.006
40	3725.009979	-0.006	3954.989967	-0.008
50	3725.009983	-0.005	3954.989978	-0.006

### Frequency Error vs. Voltage

Voltage (Vdc)	5GNR n77 (Part 270)			
	Channel Bandwidth 60 MHz			
	Low Channel		High Channel	
	Frequency (MHz)	Frequency Error (ppm)	Frequency (MHz)	Frequency Error (ppm)
4.25	3730.020040	0.011	3949.980011	0.003
5	3730.020016	0.004	3949.980019	0.005
5.75	3730.020011	0.003	3949.980012	0.003

Note: The applicant defined the normal working voltage is from 4.25Vdc to 5.75Vdc.

### Frequency Error vs. Temperature

Temp. (°C)	5GNR n77 (Part 270)			
	Channel Bandwidth 60 MHz			
	Low Channel		High Channel	
	Frequency (MHz)	Frequency Error (ppm)	Frequency (MHz)	Frequency Error (ppm)
-30	3730.020029	0.008	3949.980013	0.003
-20	3730.020020	0.005	3949.980014	0.004
-10	3730.020023	0.006	3949.980025	0.006
0	3730.020038	0.010	3949.980030	0.008
10	3730.019960	-0.011	3949.979964	-0.009
20	3730.019970	-0.008	3949.979960	-0.010
30	3730.019984	-0.004	3949.979981	-0.005
40	3730.019983	-0.005	3949.979965	-0.009
50	3730.019980	-0.005	3949.979965	-0.009

Frequency Error vs. Voltage

Voltage (Vdc)	5GNR n77 (Part 270)			
	Channel Bandwidth 80 MHz			
	Low Channel		High Channel	
	Frequency (MHz)	Frequency Error (ppm)	Frequency (MHz)	Frequency Error (ppm)
4.25	3740.010021	0.006	3939.990039	0.010
5	3740.010017	0.005	3939.990035	0.009
5.75	3740.010039	0.011	3939.990022	0.006

Note: The applicant defined the normal working voltage is from 4.25Vdc to 5.75Vdc.

Frequency Error vs. Temperature

Temp. (°C)	5GNR n77 (Part 270)			
	Channel Bandwidth 80 MHz			
	Low Channel		High Channel	
	Frequency (MHz)	Frequency Error (ppm)	Frequency (MHz)	Frequency Error (ppm)
-30	3740.010011	0.003	3939.990022	0.006
-20	3740.010021	0.006	3939.990024	0.006
-10	3740.010024	0.006	3939.990021	0.005
0	3740.010022	0.006	3939.990038	0.010
10	3740.009966	-0.009	3939.989974	-0.007
20	3740.009963	-0.010	3939.989973	-0.007
30	3740.009969	-0.008	3939.989962	-0.010
40	3740.009963	-0.010	3939.989966	-0.009
50	3740.009974	-0.007	3939.989971	-0.007

### Frequency Error vs. Voltage

Voltage (Vdc)	5GNR n77 (Part 270)			
	Channel Bandwidth 90 MHz			
	Low Channel		High Channel	
	Frequency (MHz)	Frequency Error (ppm)	Frequency (MHz)	Frequency Error (ppm)
4.25	3745.020014	0.004	3934.980013	0.003
5	3745.020026	0.007	3934.980016	0.004
5.75	3745.020018	0.005	3934.980034	0.009

Note: The applicant defined the normal working voltage is from 4.25Vdc to 5.75Vdc.

### Frequency Error vs. Temperature

Temp. (°C)	5GNR n77 (Part 270)			
	Channel Bandwidth 90 MHz			
	Low Channel		High Channel	
	Frequency (MHz)	Frequency Error (ppm)	Frequency (MHz)	Frequency Error (ppm)
-30	3745.020030	0.005	3934.980012	0.007
-20	3745.020030	0.008	3934.980012	0.003
-10	3745.020026	0.007	3934.980037	0.009
0	3745.020012	0.003	3934.980023	0.006
10	3745.019972	-0.008	3934.979960	-0.010
20	3745.019987	-0.004	3934.979981	-0.005
30	3745.019966	-0.009	3934.979964	-0.009
40	3745.019987	-0.004	3934.979973	-0.007
50	3745.019986	-0.004	3934.979970	-0.008

Frequency Error vs. Voltage

Voltage (Vdc)	5GNR n77 (Part 270)			
	Channel Bandwidth 100 MHz			
	Low Channel		High Channel	
	Frequency (MHz)	Frequency Error (ppm)	Frequency (MHz)	Frequency Error (ppm)
4.25	3750.000029	0.008	3930.000036	0.009
5	3750.000022	0.006	3930.000012	0.003
5.75	3750.000013	0.004	3930.000025	0.006

Note: The applicant defined the normal working voltage is from 4.25Vdc to 5.75Vdc.

Frequency Error vs. Temperature

Temp. (°C)	5GNR n77 (Part 270)			
	Channel Bandwidth 100 MHz			
	Low Channel		High Channel	
	Frequency (MHz)	Frequency Error (ppm)	Frequency (MHz)	Frequency Error (ppm)
-30	3750.000016	0.004	3930.000027	0.005
-20	3750.000016	0.004	3930.000027	0.007
-10	3750.000038	0.010	3930.000022	0.006
0	3750.000025	0.007	3930.000021	0.005
10	3749.999979	-0.006	3929.999970	-0.008
20	3749.999982	-0.005	3929.999973	-0.007
30	3749.999971	-0.008	3929.999977	-0.006
40	3749.999977	-0.006	3929.999990	-0.003
50	3749.999987	-0.004	3929.999966	-0.009

Frequency Error vs. Voltage

Voltage (Vdc)	5GNR n77 (Part 27Q)			
	Channel Bandwidth 20 MHz			
	Low Channel		High Channel	
	Frequency (MHz)	Frequency Error (ppm)	Frequency (MHz)	Frequency Error (ppm)
4.25	3460.020020	0.006	3540.000000	0.011
5	3460.020032	0.009	3540.000000	0.008
5.75	3460.020015	0.004	3540.000000	0.009

Note: The applicant defined the normal working voltage is from 4.25Vdc to 5.75Vdc.

Frequency Error vs. Temperature

Temp. (°C)	5GNR n77 (Part 27Q)			
	Channel Bandwidth 20 MHz			
	Low Channel		High Channel	
	Frequency (MHz)	Frequency Error (ppm)	Frequency (MHz)	Frequency Error (ppm)
-30	3460.020013	0.004	3540.000000	0.004
-20	3460.020013	0.004	3540.000000	0.010
-10	3460.020011	0.003	3540.000000	0.006
0	3460.020029	0.008	3540.000000	0.007
10	3460.019985	-0.004	3540.000000	-0.003
20	3460.019981	-0.005	3540.000000	-0.009
30	3460.019963	-0.011	3540.000000	-0.004
40	3460.019974	-0.008	3540.000000	-0.006
50	3460.019971	-0.008	3540.000000	-0.009

### Frequency Error vs. Voltage

Voltage (Vdc)	5GNR n77 (Part 27Q)			
	Channel Bandwidth 40 MHz			
	Low Channel		High Channel	
	Frequency (MHz)	Frequency Error (ppm)	Frequency (MHz)	Frequency Error (ppm)
4.25	3470.010032	0.009	3529.980014	0.004
5	3470.010022	0.006	3529.980030	0.008
5.75	3470.010029	0.008	3529.980013	0.004

Note: The applicant defined the normal working voltage is from 4.25Vdc to 5.75Vdc.

### Frequency Error vs. Temperature

Temp. (°C)	5GNR n77 (Part 27Q)			
	Channel Bandwidth 40 MHz			
	Low Channel		High Channel	
	Frequency (MHz)	Frequency Error (ppm)	Frequency (MHz)	Frequency Error (ppm)
-30	3470.010010	0.003	3529.980013	0.004
-20	3470.010022	0.006	3529.980027	0.008
-10	3470.010039	0.011	3529.980037	0.010
0	3470.010033	0.010	3529.980040	0.011
10	3470.009980	-0.006	3529.979977	-0.006
20	3470.009985	-0.004	3529.979968	-0.009
30	3470.009969	-0.009	3529.979966	-0.010
40	3470.009972	-0.008	3529.979973	-0.008
50	3470.009987	-0.004	3529.979963	-0.010

Frequency Error vs. Voltage

Voltage (Vdc)	5GNR n77 (Part 27Q)			
	Channel Bandwidth 50 MHz			
	Low Channel		High Channel	
	Frequency (MHz)	Frequency Error (ppm)	Frequency (MHz)	Frequency Error (ppm)
4.25	3475.020034	0.010	3525.000020	0.006
5	3475.020020	0.006	3525.000028	0.008
5.75	3475.020012	0.003	3525.000014	0.004

Note: The applicant defined the normal working voltage is from 4.25Vdc to 5.75Vdc.

Frequency Error vs. Temperature

Temp. (°C)	5GNR n77 (Part 27Q)			
	Channel Bandwidth 50 MHz			
	Low Channel		High Channel	
	Frequency (MHz)	Frequency Error (ppm)	Frequency (MHz)	Frequency Error (ppm)
-30	3475.020040	0.012	3525.000016	0.005
-20	3475.020036	0.010	3525.000015	0.004
-10	3475.020014	0.004	3525.000036	0.010
0	3475.020025	0.007	3525.000032	0.009
10	3475.019974	-0.008	3524.999986	-0.004
20	3475.019979	-0.006	3524.999969	-0.009
30	3475.019982	-0.005	3524.999972	-0.008
40	3475.019975	-0.007	3524.999985	-0.004
50	3475.019976	-0.007	3524.999970	-0.008



### Frequency Error vs. Voltage

Voltage (Vdc)	5GNR n77 (Part 27Q)			
	Channel Bandwidth 60 MHz			
	Low Channel		High Channel	
	Frequency (MHz)	Frequency Error (ppm)	Frequency (MHz)	Frequency Error (ppm)
4.25	3480.000031	0.009	3519.990014	0.004
5	3480.000015	0.004	3519.990033	0.009
5.75	3480.000036	0.010	3519.990025	0.007

Note: The applicant defined the normal working voltage is from 4.25Vdc to 5.75Vdc.

### Frequency Error vs. Temperature

Temp. (°C)	5GNR n77 (Part 27Q)			
	Channel Bandwidth 60 MHz			
	Low Channel		High Channel	
	Frequency (MHz)	Frequency Error (ppm)	Frequency (MHz)	Frequency Error (ppm)
-30	3480.000033	0.010	3519.990012	0.003
-20	3480.000013	0.004	3519.990015	0.004
-10	3480.000017	0.005	3519.990019	0.005
0	3480.000032	0.009	3519.990013	0.004
10	3479.999979	-0.006	3519.989972	-0.008
20	3479.999982	-0.005	3519.989968	-0.009
30	3479.999964	-0.010	3519.989985	-0.004
40	3479.999978	-0.006	3519.989970	-0.008
50	3479.999983	-0.005	3519.989967	-0.009

Frequency Error vs. Voltage

Voltage (Vdc)	5GNR n77 (Part 27Q)			
	Channel Bandwidth 80 MHz			
	Low Channel		High Channel	
	Frequency (MHz)	Frequency Error (ppm)	Frequency (MHz)	Frequency Error (ppm)
4.25	3490.020037	0.011	3510.000015	0.004
5	3490.020030	0.009	3510.000024	0.007
5.75	3490.020035	0.010	3510.000028	0.008

Note: The applicant defined the normal working voltage is from 4.25Vdc to 5.75Vdc.

Frequency Error vs. Temperature

Temp. (°C)	5GNR n77 (Part 27Q)			
	Channel Bandwidth 80 MHz			
	Low Channel		High Channel	
	Frequency (MHz)	Frequency Error (ppm)	Frequency (MHz)	Frequency Error (ppm)
-30	3490.020021	0.006	3510.000026	0.007
-20	3490.020017	0.005	3510.000031	0.009
-10	3490.020034	0.010	3510.000014	0.004
0	3490.020035	0.010	3510.000017	0.005
10	3490.019968	-0.009	3509.999980	-0.006
20	3490.019983	-0.005	3509.999981	-0.005
30	3490.019963	-0.011	3509.999977	-0.006
40	3490.019983	-0.005	3509.999969	-0.009
50	3490.019964	-0.010	3509.999977	-0.006

### Frequency Error vs. Voltage

Voltage (Vdc)	5GNR n77 (Part 27Q)			
	Channel Bandwidth 90 MHz			
	Low Channel		High Channel	
	Frequency (MHz)	Frequency Error (ppm)	Frequency (MHz)	Frequency Error (ppm)
4.25	3495.000030	0.009	3504.990018	0.005
5	3495.000022	0.006	3504.990026	0.007
5.75	3495.000019	0.005	3504.990038	0.011

Note: The applicant defined the normal working voltage is from 4.25Vdc to 5.75Vdc.

### Frequency Error vs. Temperature

Temp. (°C)	5GNR n77 (Part 27Q)			
	Channel Bandwidth 90 MHz			
	Low Channel		High Channel	
	Frequency (MHz)	Frequency Error (ppm)	Frequency (MHz)	Frequency Error (ppm)
-30	3495.000023	0.004	3504.990029	0.009
-20	3495.000023	0.007	3504.990029	0.008
-10	3495.000018	0.005	3504.990035	0.010
0	3495.000038	0.011	3504.990017	0.005
10	3494.999967	-0.010	3504.989987	-0.004
20	3494.999963	-0.011	3504.989990	-0.003
30	3494.999967	-0.010	3504.989964	-0.010
40	3494.999974	-0.008	3504.989980	-0.006
50	3494.999969	-0.009	3504.989963	-0.010

Frequency Error vs. Voltage

Voltage (Vdc)	5GNR n77 (Part 27Q)	
	Channel Bandwidth 100 MHz	
	Frequency (MHz)	Frequency Error (ppm)
4.25	3500.010014	0.004
5	3500.010030	0.009
5.75	3500.010015	0.004

Note: The applicant defined the normal working voltage is from 4.25Vdc to 5.75Vdc.

Frequency Error vs. Temperature

Temp. (°C)	5GNR n77 (Part 27Q)	
	Channel Bandwidth 100 MHz	
	Frequency (MHz)	Frequency Error (ppm)
-30	3500.010037	0.004
-20	3500.010037	0.011
-10	3500.010031	0.009
0	3500.010029	0.008
10	3500.009962	-0.011
20	3500.009971	-0.008
30	3500.009990	-0.003
40	3500.009964	-0.010
50	3500.009983	-0.005

### Frequency Error vs. Voltage

Voltage (Volts)	LTE Band 2			
	Channel Bandwidth: 1.4 MHz			
	Low Channel		High Channel	
	Frequency (MHz)	Frequency Error (ppm)	Frequency (MHz)	Frequency Error (ppm)
4.25	1850.700002	0.001	1909.300000	0.001
5	1850.700004	0.002	1909.300002	0.001
5.75	1850.700003	0.002	1909.300003	0.001

Note: The applicant defined the normal working voltage is from 4.25Vdc to 5.75Vdc.

### Frequency Error vs. Temperature

Temp. (°C)	LTE Band 2			
	Channel Bandwidth: 1.4 MHz			
	Low Channel		High Channel	
	Frequency (MHz)	Frequency Error (ppm)	Frequency (MHz)	Frequency Error (ppm)
-30	1850.700003	0.002	1909.300003	0.001
-20	1850.700002	0.001	1909.300003	0.001
-10	1850.700004	0.002	1909.300001	0.001
0	1850.700003	0.002	1909.300001	0.001
10	1850.700001	0.001	1909.300001	0.001
20	1850.699998	-0.001	1909.299996	-0.002
30	1850.699996	-0.002	1909.299998	-0.001
40	1850.699997	-0.002	1909.299996	-0.002
50	1850.699998	-0.001	1909.299998	-0.001

### Frequency Error vs. Voltage

Voltage (Volts)	LTE Band 2			
	Channel Bandwidth: 3 MHz			
	Low Channel		High Channel	
	Frequency (MHz)	Frequency Error (ppm)	Frequency (MHz)	Frequency Error (ppm)
4.25	1851.500003	0.002	1908.500003	0.001
5	1851.500002	0.001	1908.500004	0.002
5.75	1851.500002	0.001	1908.500004	0.002

Note: The applicant defined the normal working voltage is from 4.25Vdc to 5.75Vdc.

### Frequency Error vs. Temperature

Temp. (°C)	LTE Band 2			
	Channel Bandwidth: 3 MHz			
	Low Channel		High Channel	
	Frequency (MHz)	Frequency Error (ppm)	Frequency (MHz)	Frequency Error (ppm)
-30	1851.500002	0.001	1908.500003	0.002
-20	1851.500003	0.001	1908.500002	0.001
-10	1851.500003	0.002	1908.500002	0.001
0	1851.500002	0.001	1908.500004	0.002
10	1851.500001	0.001	1908.500004	0.002
20	1851.499997	-0.002	1908.499998	-0.001
30	1851.499998	-0.001	1908.499996	-0.002
40	1851.499997	-0.001	1908.499996	-0.002
50	1851.499998	-0.001	1908.499996	-0.002

### Frequency Error vs. Voltage

Voltage (Volts)	LTE Band 2			
	Channel Bandwidth: 5 MHz			
	Low Channel		High Channel	
	Frequency (MHz)	Frequency Error (ppm)	Frequency (MHz)	Frequency Error (ppm)
4.25	1852.500002	0.001	1907.500002	0.001
5	1852.500003	0.002	1907.500002	0.001
5.75	1852.500002	0.001	1907.500003	0.002

Note: The applicant defined the normal working voltage is from 4.25Vdc to 5.75Vdc.

### Frequency Error vs. Temperature

Temp. (°C)	LTE Band 2			
	Channel Bandwidth: 5 MHz			
	Low Channel		High Channel	
	Frequency (MHz)	Frequency Error (ppm)	Frequency (MHz)	Frequency Error (ppm)
-30	1852.500002	0.001	1907.500001	0.001
-20	1852.500004	0.002	1907.500003	0.001
-10	1852.500002	0.001	1907.500004	0.002
0	1852.500002	0.001	1907.500002	0.001
10	1852.500003	0.002	1907.500004	0.002
20	1852.499999	-0.001	1907.499997	-0.002
30	1852.499997	-0.002	1907.499998	-0.001
40	1852.499999	-0.001	1907.499997	-0.002
50	1852.499997	-0.002	1907.499998	-0.001

Frequency Error vs. Voltage

Voltage (Volts)	LTE Band 2			
	Channel Bandwidth: 10 MHz			
	Low Channel		High Channel	
	Frequency (MHz)	Frequency Error (ppm)	Frequency (MHz)	Frequency Error (ppm)
4.25	1855.000003	0.002	1905.000003	0.002
5	1855.000002	0.001	1905.000002	0.001
5.75	1855.000004	0.002	1905.000003	0.001

Note: The applicant defined the normal working voltage is from 4.25Vdc to 5.75Vdc.

Frequency Error vs. Temperature

Temp. (°C)	LTE Band 2			
	Channel Bandwidth: 10 MHz			
	Low Channel		High Channel	
	Frequency (MHz)	Frequency Error (ppm)	Frequency (MHz)	Frequency Error (ppm)
-30	1855.000002	0.001	1905.000004	0.002
-20	1855.000001	0.001	1905.000004	0.002
-10	1855.000003	0.002	1905.000003	0.001
0	1855.000002	0.001	1905.000004	0.002
10	1855.000004	0.002	1905.000001	0.001
20	1854.999997	-0.002	1904.999997	-0.001
30	1854.999999	-0.001	1904.999998	-0.001
40	1854.999998	-0.001	1904.999997	-0.001
50	1854.999996	-0.002	1904.999998	-0.001



### Frequency Error vs. Voltage

Voltage (Volts)	LTE Band 2			
	Channel Bandwidth: 15 MHz			
	Low Channel		High Channel	
	Frequency (MHz)	Frequency Error (ppm)	Frequency (MHz)	Frequency Error (ppm)
4.25	1857.500002	0.001	1902.500004	0.002
5	1857.500003	0.002	1902.500002	0.001
5.75	1857.500002	0.001	1902.500003	0.002

Note: The applicant defined the normal working voltage is from 4.25Vdc to 5.75Vdc.

### Frequency Error vs. Temperature

Temp. (°C)	LTE Band 2			
	Channel Bandwidth: 15 MHz			
	Low Channel		High Channel	
	Frequency (MHz)	Frequency Error (ppm)	Frequency (MHz)	Frequency Error (ppm)
-30	1857.500002	0.001	1902.500004	0.002
-20	1857.500002	0.001	1902.500003	0.002
-10	1857.500001	0.001	1902.500002	0.001
0	1857.500002	0.001	1902.500003	0.002
10	1857.500002	0.001	1902.500003	0.002
20	1857.499998	-0.001	1902.499999	-0.001
30	1857.499998	-0.001	1902.499999	-0.001
40	1857.499998	-0.001	1902.499999	-0.001
50	1857.499999	-0.001	1902.499999	-0.001

Frequency Error vs. Voltage

Voltage (Volts)	LTE Band 2			
	Channel Bandwidth: 20 MHz			
	Low Channel		High Channel	
	Frequency (MHz)	Frequency Error (ppm)	Frequency (MHz)	Frequency Error (ppm)
4.25	1860.000002	0.001	1900.000003	0.002
5	1860.000004	0.002	1900.000001	0.001
5.75	1860.000003	0.001	1900.000001	0.001

Note: The applicant defined the normal working voltage is from 4.25Vdc to 5.75Vdc.

Frequency Error vs. Temperature

Temp. (°C)	LTE Band 2			
	Channel Bandwidth: 20 MHz			
	Low Channel		High Channel	
	Frequency (MHz)	Frequency Error (ppm)	Frequency (MHz)	Frequency Error (ppm)
-30	1860.000003	0.002	1900.000001	0.001
-20	1860.000004	0.002	1900.000003	0.002
-10	1860.000003	0.002	1900.000003	0.002
0	1860.000001	0.001	1900.000004	0.002
10	1860.000003	0.002	1900.000004	0.002
20	1859.999998	-0.001	1899.999997	-0.002
30	1859.999996	-0.002	1899.999998	-0.001
40	1859.999996	-0.002	1899.999998	-0.001
50	1859.999998	-0.001	1899.999997	-0.002

Frequency Error vs. Voltage

Voltage (Volts)	LTE Band 5			
	Channel Bandwidth: 1.4 MHz			
	Low Channel		High Channel	
	Frequency (MHz)	Frequency Error (ppm)	Frequency (MHz)	Frequency Error (ppm)
4.25	824.700002	0.003	848.300001	0.001
5	824.700002	0.002	848.300001	0.001
5.75	824.700002	0.003	848.300003	0.004

Note: The applicant defined the normal working voltage is from 4.25Vdc to 5.75Vdc.

Frequency Error vs. Temperature

Temp. (°C)	LTE Band 5			
	Channel Bandwidth: 1.4 MHz			
	Low Channel		High Channel	
	Frequency (MHz)	Frequency Error (ppm)	Frequency (MHz)	Frequency Error (ppm)
-30	824.700002	0.002	848.300003	0.004
-20	824.700002	0.002	848.300001	0.001
-10	824.700003	0.004	848.300002	0.003
0	824.700004	0.004	848.300004	0.005
10	824.700001	0.001	848.300003	0.003
20	824.699998	-0.003	848.299998	-0.003
30	824.699998	-0.003	848.299999	-0.002
40	824.699999	-0.001	848.299998	-0.003
50	824.699999	-0.002	848.299998	-0.003

### Frequency Error vs. Voltage

Voltage (Volts)	LTE Band 5			
	Channel Bandwidth: 3 MHz			
	Low Channel		High Channel	
	Frequency (MHz)	Frequency Error (ppm)	Frequency (MHz)	Frequency Error (ppm)
4.25	825.500003	0.003	847.500003	0.004
5	825.500001	0.002	847.500004	0.005
5.75	825.500003	0.003	847.500003	0.003

Note: The applicant defined the normal working voltage is from 4.25Vdc to 5.75Vdc.

### Frequency Error vs. Temperature

Temp. (°C)	LTE Band 5			
	Channel Bandwidth: 3 MHz			
	Low Channel		High Channel	
	Frequency (MHz)	Frequency Error (ppm)	Frequency (MHz)	Frequency Error (ppm)
-30	825.500002	0.002	847.500004	0.004
-20	825.500001	0.001	847.500002	0.002
-10	825.500003	0.003	847.500001	0.002
0	825.500002	0.002	847.500002	0.003
10	825.500002	0.002	847.500002	0.002
20	825.499997	-0.004	847.499997	-0.003
30	825.499998	-0.002	847.499997	-0.004
40	825.499997	-0.004	847.499999	-0.001
50	825.499996	-0.005	847.499998	-0.002

### Frequency Error vs. Voltage

Voltage (Volts)	LTE Band 5			
	Channel Bandwidth: 5 MHz			
	Low Channel		High Channel	
	Frequency (MHz)	Frequency Error (ppm)	Frequency (MHz)	Frequency Error (ppm)
4.25	826.500002	0.003	846.500001	0.002
5	826.500003	0.004	846.500004	0.005
5.75	826.500004	0.005	846.500001	0.002

Note: The applicant defined the normal working voltage is from 4.25Vdc to 5.75Vdc.

### Frequency Error vs. Temperature

Temp. (°C)	LTE Band 5			
	Channel Bandwidth: 5 MHz			
	Low Channel		High Channel	
	Frequency (MHz)	Frequency Error (ppm)	Frequency (MHz)	Frequency Error (ppm)
-30	826.500002	0.002	846.500002	0.002
-20	826.500004	0.005	846.500004	0.004
-10	826.500003	0.004	846.500003	0.003
0	826.500004	0.004	846.500001	0.001
10	826.500004	0.005	846.500001	0.002
20	826.499996	-0.004	846.499998	-0.003
30	826.499998	-0.002	846.499997	-0.003
40	826.499997	-0.004	846.499998	-0.003
50	826.499997	-0.004	846.499998	-0.003

### Frequency Error vs. Voltage

Voltage (Volts)	LTE Band 5			
	Channel Bandwidth: 10 MHz			
	Low Channel		High Channel	
	Frequency (MHz)	Frequency Error (ppm)	Frequency (MHz)	Frequency Error (ppm)
4.25	829.000003	0.004	844.000003	0.004
5	829.000004	0.005	844.000003	0.004
5.75	829.000001	0.002	844.000002	0.002

Note: The applicant defined the normal working voltage is from 4.25Vdc to 5.75Vdc.

### Frequency Error vs. Temperature

Temp. (°C)	LTE Band 5			
	Channel Bandwidth: 10 MHz			
	Low Channel		High Channel	
	Frequency (MHz)	Frequency Error (ppm)	Frequency (MHz)	Frequency Error (ppm)
-30	829.000003	0.003	844.000003	0.004
-20	829.000003	0.003	844.000002	0.002
-10	829.000004	0.004	844.000003	0.003
0	829.000004	0.005	844.000004	0.005
10	829.000002	0.003	844.000003	0.004
20	828.999999	-0.002	843.999999	-0.001
30	828.999998	-0.003	843.999998	-0.003
40	828.999997	-0.004	843.999999	-0.002
50	828.999997	-0.004	843.999997	-0.004

### Frequency Error vs. Voltage

Voltage (Volts)	LTE Band 7			
	Channel Bandwidth: 5 MHz			
	Low Channel		High Channel	
	Frequency (MHz)	Frequency Error (ppm)	Frequency (MHz)	Frequency Error (ppm)
4.25	2502.500003	0.001	2567.500002	0.001
5	2502.500004	0.002	2567.500004	0.001
5.75	2502.500002	0.001	2567.500001	0.000

Note: The applicant defined the normal working voltage is from 4.25Vdc to 5.75Vdc.

### Frequency Error vs. Temperature

Temp. (°C)	LTE Band 7			
	Channel Bandwidth: 5 MHz			
	Low Channel		High Channel	
	Frequency (MHz)	Frequency Error (ppm)	Frequency (MHz)	Frequency Error (ppm)
-30	2502.500001	0.000	2567.500002	0.001
-20	2502.500002	0.001	2567.500004	0.002
-10	2502.500003	0.001	2567.500001	0.000
0	2502.500002	0.001	2567.500002	0.001
10	2502.500002	0.001	2567.500002	0.001
20	2502.499996	-0.001	2567.499999	-0.001
30	2502.499997	-0.001	2567.499997	-0.001
40	2502.499999	0.000	2567.499999	0.000
50	2502.499997	-0.001	2567.499999	0.000

### Frequency Error vs. Voltage

Voltage (Volts)	LTE Band 7			
	Channel Bandwidth: 10 MHz			
	Low Channel		High Channel	
	Frequency (MHz)	Frequency Error (ppm)	Frequency (MHz)	Frequency Error (ppm)
4.25	2505.000002	0.001	2565.000003	0.001
5	2505.000003	0.001	2565.000002	0.001
5.75	2505.000003	0.001	2565.000003	0.001

Note: The applicant defined the normal working voltage is from 4.25Vdc to 5.75Vdc.

### Frequency Error vs. Temperature

Temp. (°C)	LTE Band 7			
	Channel Bandwidth: 10 MHz			
	Low Channel		High Channel	
	Frequency (MHz)	Frequency Error (ppm)	Frequency (MHz)	Frequency Error (ppm)
-30	2505.000002	0.001	2565.000002	0.001
-20	2505.000002	0.001	2565.000002	0.001
-10	2505.000003	0.001	2565.000003	0.001
0	2505.000002	0.001	2565.000004	0.001
10	2505.000002	0.001	2565.000003	0.001
20	2504.999998	-0.001	2564.999998	-0.001
30	2504.999996	-0.002	2564.999996	-0.001
40	2504.999998	-0.001	2564.999998	-0.001
50	2504.999998	-0.001	2564.999999	-0.001



### Frequency Error vs. Voltage

Voltage (Volts)	LTE Band 7			
	Channel Bandwidth: 15 MHz			
	Low Channel		High Channel	
	Frequency (MHz)	Frequency Error (ppm)	Frequency (MHz)	Frequency Error (ppm)
4.25	2507.500002	0.001	2562.500003	0.001
5	2507.500001	0.000	2562.500003	0.001
5.75	2507.500002	0.001	2562.500003	0.001

Note: The applicant defined the normal working voltage is from 4.25Vdc to 5.75Vdc.

### Frequency Error vs. Temperature

Temp. (°C)	LTE Band 7			
	Channel Bandwidth: 15 MHz			
	Low Channel		High Channel	
	Frequency (MHz)	Frequency Error (ppm)	Frequency (MHz)	Frequency Error (ppm)
-30	2507.500003	0.001	2562.500004	0.002
-20	2507.500002	0.001	2562.500001	0.000
-10	2507.500001	0.001	2562.500003	0.001
0	2507.500001	0.001	2562.500001	0.000
10	2507.500001	0.000	2562.500001	0.001
20	2507.499998	-0.001	2562.499997	-0.001
30	2507.499997	-0.001	2562.499997	-0.001
40	2507.499998	-0.001	2562.499999	-0.001
50	2507.499998	-0.001	2562.499999	-0.001

### Frequency Error vs. Voltage

Voltage (Volts)	LTE Band 7			
	Channel Bandwidth: 20 MHz			
	Low Channel		High Channel	
	Frequency (MHz)	Frequency Error (ppm)	Frequency (MHz)	Frequency Error (ppm)
4.25	2510.000001	0.000	2560.000003	0.001
5	2510.000004	0.001	2560.000002	0.001
5.75	2510.000003	0.001	2560.000004	0.001

Note: The applicant defined the normal working voltage is from 4.25Vdc to 5.75Vdc.

### Frequency Error vs. Temperature

Temp. (°C)	LTE Band 7			
	Channel Bandwidth: 20 MHz			
	Low Channel		High Channel	
	Frequency (MHz)	Frequency Error (ppm)	Frequency (MHz)	Frequency Error (ppm)
-30	2510.000003	0.001	2560.000002	0.001
-20	2510.000001	0.001	2560.000001	0.000
-10	2510.000002	0.001	2560.000003	0.001
0	2510.000002	0.001	2560.000003	0.001
10	2510.000003	0.001	2560.000002	0.001
20	2509.999997	-0.001	2559.999997	-0.001
30	2509.999998	-0.001	2559.999997	-0.001
40	2509.999998	-0.001	2559.999998	-0.001
50	2509.999999	-0.001	2559.999997	-0.001

### Frequency Error vs. Voltage

Voltage (Volts)	LTE Band 12			
	Channel Bandwidth: 1.4 MHz			
	Low Channel		High Channel	
	Frequency (MHz)	Frequency Error (ppm)	Frequency (MHz)	Frequency Error (ppm)
4.25	699.700004	0.006	715.300001	0.002
5	699.700003	0.005	715.300001	0.002
5.75	699.700003	0.004	715.300001	0.001

Note: The applicant defined the normal working voltage is from 4.25Vdc to 5.75Vdc.

### Frequency Error vs. Temperature

Temp. (°C)	LTE Band 12			
	Channel Bandwidth: 1.4 MHz			
	Low Channel		High Channel	
	Frequency (MHz)	Frequency Error (ppm)	Frequency (MHz)	Frequency Error (ppm)
-30	699.700003	0.004	715.300001	0.002
-20	699.700001	0.001	715.300002	0.003
-10	699.700004	0.005	715.300002	0.003
0	699.700003	0.004	715.300001	0.002
10	699.700004	0.005	715.300002	0.003
20	699.699998	-0.002	715.299996	-0.005
30	699.699997	-0.004	715.299999	-0.002
40	699.699998	-0.003	715.299998	-0.003
50	699.699999	-0.002	715.299999	-0.002

### Frequency Error vs. Voltage

Voltage (Volts)	LTE Band 12			
	Channel Bandwidth: 3 MHz			
	Low Channel		High Channel	
	Frequency (MHz)	Frequency Error (ppm)	Frequency (MHz)	Frequency Error (ppm)
4.25	700.500002	0.003	714.500003	0.004
5	700.500004	0.005	714.500001	0.002
5.75	700.500004	0.005	714.500003	0.004

Note: The applicant defined the normal working voltage is from 4.25Vdc to 5.75Vdc.

### Frequency Error vs. Temperature

Temp. (°C)	LTE Band 12			
	Channel Bandwidth: 3 MHz			
	Low Channel		High Channel	
	Frequency (MHz)	Frequency Error (ppm)	Frequency (MHz)	Frequency Error (ppm)
-30	700.500004	0.005	714.500003	0.004
-20	700.500002	0.003	714.500003	0.004
-10	700.500001	0.002	714.500003	0.004
0	700.500004	0.005	714.500003	0.003
10	700.500003	0.004	714.500002	0.003
20	700.499996	-0.006	714.499998	-0.002
30	700.499996	-0.005	714.499998	-0.003
40	700.499997	-0.004	714.499997	-0.004
50	700.499998	-0.003	714.499996	-0.005

### Frequency Error vs. Voltage

Voltage (Volts)	LTE Band 12			
	Channel Bandwidth: 5 MHz			
	Low Channel		High Channel	
	Frequency (MHz)	Frequency Error (ppm)	Frequency (MHz)	Frequency Error (ppm)
4.25	701.500002	0.003	713.500001	0.002
5	701.500004	0.005	713.500004	0.005
5.75	701.500002	0.003	713.500003	0.004

Note: The applicant defined the normal working voltage is from 4.25Vdc to 5.75Vdc.

### Frequency Error vs. Temperature

Temp. (°C)	LTE Band 12			
	Channel Bandwidth: 5 MHz			
	Low Channel		High Channel	
	Frequency (MHz)	Frequency Error (ppm)	Frequency (MHz)	Frequency Error (ppm)
-30	701.500002	0.003	713.500002	0.003
-20	701.500003	0.004	713.500002	0.003
-10	701.500003	0.004	713.500001	0.001
0	701.500002	0.003	713.500003	0.004
10	701.500003	0.004	713.500003	0.004
20	701.499998	-0.003	713.499998	-0.003
30	701.499999	-0.002	713.499998	-0.003
40	701.499997	-0.004	713.499996	-0.005
50	701.499999	-0.002	713.499998	-0.002

### Frequency Error vs. Voltage

Voltage (Volts)	LTE Band 12			
	Channel Bandwidth: 10 MHz			
	Low Channel		High Channel	
	Frequency (MHz)	Frequency Error (ppm)	Frequency (MHz)	Frequency Error (ppm)
4.25	704.000002	0.003	711.000004	0.005
5	704.000001	0.002	711.000003	0.005
5.75	704.000004	0.006	711.000001	0.001

Note: The applicant defined the normal working voltage is from 4.25Vdc to 5.75Vdc.

### Frequency Error vs. Temperature

Temp. (°C)	LTE Band 12			
	Channel Bandwidth: 10 MHz			
	Low Channel		High Channel	
	Frequency (MHz)	Frequency Error (ppm)	Frequency (MHz)	Frequency Error (ppm)
-30	704.000003	0.004	711.000001	0.002
-20	704.000004	0.005	711.000004	0.005
-10	704.000001	0.002	711.000003	0.005
0	704.000001	0.002	711.000001	0.002
10	704.000001	0.001	711.000002	0.003
20	703.999998	-0.002	710.999999	-0.002
30	703.999996	-0.005	710.999997	-0.004
40	703.999998	-0.002	710.999999	-0.001
50	703.999997	-0.004	710.999997	-0.004

Frequency Error vs. Voltage

Voltage (Volts)	LTE Band 13			
	Channel Bandwidth: 5 MHz			
	Low Channel		High Channel	
	Frequency (MHz)	Frequency Error (ppm)	Frequency (MHz)	Frequency Error (ppm)
4.25	779.500003	0.003	784.500003	0.003
5	779.500003	0.004	784.500003	0.004
5.75	779.500004	0.005	784.500002	0.002

Note: The applicant defined the normal working voltage is from 4.25Vdc to 5.75Vdc.

Frequency Error vs. Temperature

Temp. (°C)	LTE Band 13			
	Channel Bandwidth: 5 MHz			
	Low Channel		High Channel	
	Frequency (MHz)	Frequency Error (ppm)	Frequency (MHz)	Frequency Error (ppm)
-30	779.500003	0.004	784.500003	0.003
-20	779.500002	0.002	784.500001	0.001
-10	779.500002	0.002	784.500002	0.003
0	779.500003	0.003	784.500002	0.002
10	779.500004	0.005	784.500004	0.005
20	779.499997	-0.004	784.499998	-0.003
30	779.499998	-0.002	784.499999	-0.002
40	779.499996	-0.005	784.499999	-0.002
50	779.499998	-0.003	784.499999	-0.002

### Frequency Error vs. Voltage

Voltage (Volts)	LTE Band 13	
	Channel Bandwidth: 10 MHz	
	Frequency (MHz)	Frequency Error (ppm)
4.25	782.000002	0.002
5	782.000004	0.005
5.75	782.000001	0.001

Note: The applicant defined the normal working voltage is from 4.25Vdc to 5.75Vdc.

### Frequency Error vs. Temperature

Temp. (°C)	LTE Band 13	
	Channel Bandwidth: 10 MHz	
	Frequency (MHz)	Frequency Error (ppm)
-30	782.000003	0.004
-20	782.000004	0.005
-10	782.000003	0.004
0	782.000002	0.003
10	782.000001	0.001
20	781.999999	-0.002
30	781.999997	-0.003
40	781.999998	-0.002
50	781.999996	-0.005



Frequency Error vs. Voltage

Voltage (Volts)	LTE Band 14			
	Channel Bandwidth: 5MHz			
	Low Channel		High Channel	
	Frequency (MHz)	Frequency Error (ppm)	Frequency (MHz)	Frequency Error (ppm)
4.25	790.500004	0.005	795.500003	0.003
5	790.500001	0.002	795.500003	0.004
5.75	790.500002	0.003	795.500004	0.005

Note: The applicant defined the normal working voltage is from 4.25Vdc to 5.75Vdc.

Frequency Error vs. Temperature

Temp. (°C)	LTE Band 14			
	Channel Bandwidth: 5 MHz			
	Low Channel		High Channel	
	Frequency (MHz)	Frequency Error (ppm)	Frequency (MHz)	Frequency Error (ppm)
-30	790.500004	0.005	795.500003	0.004
-20	790.500004	0.005	795.500003	0.004
-10	790.500002	0.003	795.500003	0.003
0	790.500003	0.003	795.500001	0.002
10	790.500004	0.005	795.500002	0.002
20	790.499997	-0.003	795.499998	-0.002
30	790.499998	-0.003	795.499999	-0.002
40	790.499996	-0.005	795.499997	-0.004
50	790.499997	-0.003	795.499997	-0.004

Frequency Error vs. Voltage

Voltage (Volts)	LTE Band 14	
	Channel Bandwidth: 10 MHz	
	Frequency (MHz)	Frequency Error (ppm)
4.25	793.000003	0.004
5	793.000002	0.003
5.75	793.000004	0.005

Note: The applicant defined the normal working voltage is from 4.25Vdc to 5.75Vdc.

Frequency Error vs. Temperature

Temp. (°C)	LTE Band 14	
	Channel Bandwidth: 10 MHz	
	Frequency (MHz)	Frequency Error (ppm)
-30	793.000001	0.002
-20	793.000002	0.003
-10	793.000003	0.004
0	793.000004	0.005
10	793.000004	0.005
20	792.999998	-0.003
30	792.999998	-0.002
40	792.999996	-0.005
50	792.999997	-0.004

### Frequency Error vs. Voltage

Voltage (Volts)	LTE Band 30			
	Channel Bandwidth: 5 MHz			
	Low Channel		High Channel	
	Frequency (MHz)	Frequency Error (ppm)	Frequency (MHz)	Frequency Error (ppm)
4.25	2307.500001	0.000	2312.500003	0.001
5	2307.500003	0.001	2312.500003	0.001
5.75	2307.500002	0.001	2312.500002	0.001

Note: The applicant defined the normal working voltage is from 4.25Vdc to 5.75Vdc.

### Frequency Error vs. Temperature

Temp. (°C)	LTE Band 30			
	Channel Bandwidth: 5 MHz			
	Low Channel		High Channel	
	Frequency (MHz)	Frequency Error (ppm)	Frequency (MHz)	Frequency Error (ppm)
-30	2307.500004	0.002	2312.500001	0.001
-20	2307.500002	0.001	2312.500001	0.001
-10	2307.500002	0.001	2312.500004	0.002
0	2307.500002	0.001	2312.500002	0.001
10	2307.500002	0.001	2312.500004	0.002
20	2307.499997	-0.001	2312.499998	-0.001
30	2307.499997	-0.001	2312.499999	0.000
40	2307.499998	-0.001	2312.499997	-0.001
50	2307.499998	-0.001	2312.499998	-0.001

Frequency Error vs. Voltage

Voltage (Volts)	LTE Band 30	
	Channel Bandwidth: 10 MHz	
	Frequency (MHz)	Frequency Error (ppm)
4.25	2310.000002	0.001
5	2310.000001	0.000
5.75	2310.000001	0.000

Note: The applicant defined the normal working voltage is from 4.25Vdc to 5.75Vdc.

Frequency Error vs. Temperature

Temp. (°C)	LTE Band 30	
	Channel Bandwidth: 10 MHz	
	Frequency (MHz)	Frequency Error (ppm)
-30	2310.000002	0.001
-20	2310.000001	0.001
-10	2310.000003	0.001
0	2310.000001	0.001
10	2310.000003	0.001
20	2309.999998	-0.001
30	2309.999997	-0.001
40	2309.999998	-0.001
50	2309.999997	-0.001

### Frequency Error vs. Voltage

Voltage (Volts)	LTE Band 41			
	Channel Bandwidth: 5 MHz			
	Low Channel		High Channel	
	Frequency (MHz)	Frequency Error (ppm)	Frequency (MHz)	Frequency Error (ppm)
4.25	2498.500002	0.001	2687.500002	0.001
5	2498.500003	0.001	2687.500002	0.001
5.75	2498.500002	0.001	2687.500004	0.001

Note: The applicant defined the normal working voltage is from 4.25Vdc to 5.75Vdc.

### Frequency Error vs. Temperature

Temp. (°C)	LTE Band 41			
	Channel Bandwidth: 5 MHz			
	Low Channel		High Channel	
	Frequency (MHz)	Frequency Error (ppm)	Frequency (MHz)	Frequency Error (ppm)
-30	2498.500002	0.001	2687.500002	0.001
-20	2498.500001	0.000	2687.500004	0.001
-10	2498.500003	0.001	2687.500003	0.001
0	2498.500001	0.000	2687.500003	0.001
10	2498.500002	0.001	2687.500002	0.001
20	2498.499997	-0.001	2687.499997	-0.001
30	2498.499998	-0.001	2687.499996	-0.001
40	2498.499999	-0.001	2687.499999	0.000
50	2498.499998	-0.001	2687.499996	-0.001

### Frequency Error vs. Voltage

Voltage (Volts)	LTE Band 41			
	Channel Bandwidth: 10 MHz			
	Low Channel		High Channel	
	Frequency (MHz)	Frequency Error (ppm)	Frequency (MHz)	Frequency Error (ppm)
4.25	2501.000003	0.001	2685.000002	0.001
5	2501.000002	0.001	2685.000002	0.001
5.75	2501.000003	0.001	2685.000003	0.001

Note: The applicant defined the normal working voltage is from 4.25Vdc to 5.75Vdc.

### Frequency Error vs. Temperature

Temp. (°C)	LTE Band 41			
	Channel Bandwidth: 10 MHz			
	Low Channel		High Channel	
	Frequency (MHz)	Frequency Error (ppm)	Frequency (MHz)	Frequency Error (ppm)
-30	2501.000004	0.002	2685.000003	0.001
-20	2501.000003	0.001	2685.000003	0.001
-10	2501.000003	0.001	2685.000002	0.001
0	2501.000002	0.001	2685.000002	0.001
10	2501.000004	0.001	2685.000003	0.001
20	2500.999997	-0.001	2684.999999	-0.001
30	2500.999996	-0.002	2684.999998	-0.001
40	2500.999997	-0.001	2684.999998	-0.001
50	2500.999999	0.000	2684.999999	0.000

### Frequency Error vs. Voltage

Voltage (Volts)	LTE Band 41			
	Channel Bandwidth: 15 MHz			
	Low Channel		High Channel	
	Frequency (MHz)	Frequency Error (ppm)	Frequency (MHz)	Frequency Error (ppm)
4.25	2503.500002	0.001	2682.500004	0.001
5	2503.500001	0.001	2682.500004	0.001
5.75	2503.500003	0.001	2682.500003	0.001

Note: The applicant defined the normal working voltage is from 4.25Vdc to 5.75Vdc.

### Frequency Error vs. Temperature

Temp. (°C)	LTE Band 41			
	Channel Bandwidth: 15 MHz			
	Low Channel		High Channel	
	Frequency (MHz)	Frequency Error (ppm)	Frequency (MHz)	Frequency Error (ppm)
-30	2503.500004	0.002	2682.500003	0.001
-20	2503.500003	0.001	2682.500004	0.001
-10	2503.500001	0.001	2682.500002	0.001
0	2503.500002	0.001	2682.500003	0.001
10	2503.500001	0.000	2682.500003	0.001
20	2503.499996	-0.001	2682.499997	-0.001
30	2503.499998	-0.001	2682.499999	-0.001
40	2503.499999	0.000	2682.499997	-0.001
50	2503.499997	-0.001	2682.499997	-0.001

### Frequency Error vs. Voltage

Voltage (Volts)	LTE Band 41			
	Channel Bandwidth: 20 MHz			
	Low Channel		High Channel	
	Frequency (MHz)	Frequency Error (ppm)	Frequency (MHz)	Frequency Error (ppm)
4.25	2506.000003	0.001	2680.000004	0.001
5	2506.000003	0.001	2680.000003	0.001
5.75	2506.000002	0.001	2680.000002	0.001

Note: The applicant defined the normal working voltage is from 4.25Vdc to 5.75Vdc.

### Frequency Error vs. Temperature

Temp. (°C)	LTE Band 41			
	Channel Bandwidth: 20 MHz			
	Low Channel		High Channel	
	Frequency (MHz)	Frequency Error (ppm)	Frequency (MHz)	Frequency Error (ppm)
-30	2506.000002	0.001	2680.000002	0.001
-20	2506.000001	0.000	2680.000003	0.001
-10	2506.000004	0.001	2680.000003	0.001
0	2506.000004	0.001	2680.000002	0.001
10	2506.000004	0.001	2680.000002	0.001
20	2505.999997	-0.001	2679.999996	-0.001
30	2505.999997	-0.001	2679.999997	-0.001
40	2505.999998	-0.001	2679.999997	-0.001
50	2505.999997	-0.001	2679.999998	-0.001



### Frequency Error vs. Voltage

Voltage (Volts)	LTE Band 66			
	Channel Bandwidth: 1.4 MHz			
	Low Channel		High Channel	
	Frequency (MHz)	Frequency Error (ppm)	Frequency (MHz)	Frequency Error (ppm)
4.25	1710.700001	0.001	1779.300003	0.002
5	1710.700004	0.002	1779.300003	0.002
5.75	1710.700002	0.001	1779.300003	0.002

Note: The applicant defined the normal working voltage is from 4.25Vdc to 5.75Vdc.

### Frequency Error vs. Temperature

Temp. (°C)	LTE Band 66			
	Channel Bandwidth: 1.4 MHz			
	Low Channel		High Channel	
	Frequency (MHz)	Frequency Error (ppm)	Frequency (MHz)	Frequency Error (ppm)
-30	1710.700002	0.001	1779.300003	0.002
-20	1710.700002	0.001	1779.300002	0.001
-10	1710.700003	0.002	1779.300003	0.001
0	1710.700002	0.001	1779.300003	0.002
10	1710.700003	0.002	1779.300004	0.002
20	1710.699997	-0.002	1779.299996	-0.002
30	1710.699998	-0.001	1779.299997	-0.002
40	1710.699997	-0.002	1779.299998	-0.001
50	1710.699998	-0.001	1779.299996	-0.002

### Frequency Error vs. Voltage

Voltage (Volts)	LTE Band 66			
	Channel Bandwidth: 3 MHz			
	Low Channel		High Channel	
	Frequency (MHz)	Frequency Error (ppm)	Frequency (MHz)	Frequency Error (ppm)
4.25	1711.500002	0.001	1778.500002	0.001
5	1711.500001	0.001	1778.500002	0.001
5.75	1711.500001	0.001	1778.500002	0.001

Note: The applicant defined the normal working voltage is from 4.25Vdc to 5.75Vdc.

### Frequency Error vs. Temperature

Temp. (°C)	LTE Band 66			
	Channel Bandwidth: 3 MHz			
	Low Channel		High Channel	
	Frequency (MHz)	Frequency Error (ppm)	Frequency (MHz)	Frequency Error (ppm)
-30	1711.500002	0.001	1778.500004	0.002
-20	1711.500003	0.002	1778.500001	0.001
-10	1711.500002	0.001	1778.500004	0.002
0	1711.500004	0.002	1778.500002	0.001
10	1711.500001	0.001	1778.500002	0.001
20	1711.499996	-0.002	1778.499996	-0.002
30	1711.499997	-0.002	1778.499997	-0.002
40	1711.499996	-0.002	1778.499998	-0.001
50	1711.499998	-0.001	1778.499997	-0.002

Frequency Error vs. Voltage

Voltage (Volts)	LTE Band 66			
	Channel Bandwidth: 5 MHz			
	Low Channel		High Channel	
	Frequency (MHz)	Frequency Error (ppm)	Frequency (MHz)	Frequency Error (ppm)
4.25	1712.500002	0.001	1777.500002	0.001
5	1712.500004	0.002	1777.500001	0.001
5.75	1712.500002	0.001	1777.500003	0.002

Note: The applicant defined the normal working voltage is from 4.25Vdc to 5.75Vdc.

Frequency Error vs. Temperature

Temp. (°C)	LTE Band 66			
	Channel Bandwidth: 5 MHz			
	Low Channel		High Channel	
	Frequency (MHz)	Frequency Error (ppm)	Frequency (MHz)	Frequency Error (ppm)
-30	1712.500002	0.001	1777.500003	0.002
-20	1712.500002	0.001	1777.500002	0.001
-10	1712.500002	0.001	1777.500004	0.002
0	1712.500003	0.002	1777.500004	0.002
10	1712.500003	0.002	1777.500003	0.002
20	1712.499996	-0.002	1777.499999	-0.001
30	1712.499998	-0.001	1777.499999	-0.001
40	1712.499999	-0.001	1777.499998	-0.001
50	1712.499999	-0.001	1777.499997	-0.002

### Frequency Error vs. Voltage

Voltage (Volts)	LTE Band 66			
	Channel Bandwidth: 10 MHz			
	Low Channel		High Channel	
	Frequency (MHz)	Frequency Error (ppm)	Frequency (MHz)	Frequency Error (ppm)
4.25	1715.000003	0.002	1775.000001	0.001
5	1715.000002	0.001	1775.000003	0.002
5.75	1715.000001	0.001	1775.000004	0.002

Note: The applicant defined the normal working voltage is from 4.25Vdc to 5.75Vdc.

### Frequency Error vs. Temperature

Temp. (°C)	LTE Band 66			
	Channel Bandwidth: 10 MHz			
	Low Channel		High Channel	
	Frequency (MHz)	Frequency Error (ppm)	Frequency (MHz)	Frequency Error (ppm)
-30	1715.000004	0.002	1775.000001	0.001
-20	1715.000002	0.001	1775.000003	0.002
-10	1715.000002	0.001	1775.000003	0.001
0	1715.000002	0.001	1775.000004	0.002
10	1715.000004	0.002	1775.000003	0.002
20	1714.999997	-0.002	1774.999997	-0.002
30	1714.999997	-0.002	1774.999997	-0.002
40	1714.999998	-0.001	1774.999997	-0.002
50	1714.999998	-0.001	1774.999997	-0.002

### Frequency Error vs. Voltage

Voltage (Volts)	LTE Band 66			
	Channel Bandwidth: 15 MHz			
	Low Channel		High Channel	
	Frequency (MHz)	Frequency Error (ppm)	Frequency (MHz)	Frequency Error (ppm)
4.25	1717.500002	0.001	1772.500002	0.001
5	1717.500002	0.001	1772.500002	0.001
5.75	1717.500002	0.001	1772.500001	0.001

Note: The applicant defined the normal working voltage is from 4.25Vdc to 5.75Vdc.

### Frequency Error vs. Temperature

Temp. (°C)	LTE Band 66			
	Channel Bandwidth: 15 MHz			
	Low Channel		High Channel	
	Frequency (MHz)	Frequency Error (ppm)	Frequency (MHz)	Frequency Error (ppm)
-30	1717.500004	0.002	1772.500003	0.002
-20	1717.500003	0.002	1772.500003	0.002
-10	1717.500003	0.002	1772.500001	0.001
0	1717.500002	0.001	1772.500003	0.002
10	1717.500002	0.001	1772.500002	0.001
20	1717.499996	-0.002	1772.499997	-0.002
30	1717.499997	-0.002	1772.499999	-0.001
40	1717.499997	-0.002	1772.499996	-0.002
50	1717.499999	-0.001	1772.499997	-0.001

### Frequency Error vs. Voltage

Voltage (Volts)	LTE Band 66			
	Channel Bandwidth: 20 MHz			
	Low Channel		High Channel	
	Frequency (MHz)	Frequency Error (ppm)	Frequency (MHz)	Frequency Error (ppm)
4.25	1720.000001	0.001	1770.000002	0.001
5	1720.000002	0.001	1770.000001	0.001
5.75	1720.000001	0.001	1770.000003	0.002

Note: The applicant defined the normal working voltage is from 4.25Vdc to 5.75Vdc.

### Frequency Error vs. Temperature

Temp. (°C)	LTE Band 66			
	Channel Bandwidth: 20 MHz			
	Low Channel		High Channel	
	Frequency (MHz)	Frequency Error (ppm)	Frequency (MHz)	Frequency Error (ppm)
-30	1720.000003	0.002	1770.000003	0.002
-20	1720.000001	0.001	1770.000004	0.002
-10	1720.000003	0.001	1770.000002	0.001
0	1720.000002	0.001	1770.000002	0.001
10	1720.000002	0.001	1770.000004	0.002
20	1719.999997	-0.002	1769.999999	-0.001
30	1719.999996	-0.002	1769.999999	-0.001
40	1719.999998	-0.001	1769.999996	-0.002
50	1719.999999	-0.001	1769.999996	-0.002

## 4.4 Emission Bandwidth Measurement

### 4.4.1 Test Procedure

According to FCC 2.1049, the occupied bandwidth, that is the frequency bandwidth such that, below its lower and above its upper frequency limits, the mean powers radiated are each equal to 0.5 % of the total mean power radiated by a given emission.

For the 26dBc bandwidth measurement method, please refer to section 5.4.3 of ANSI C63.26.

### 4.4.2 Test Procedure

For the 26dBc bandwidth measurement method, please refer to section 5.4.3 of ANSI C63.26.

- a) The spectrum analyzer center frequency is set to the nominal EUT channel center frequency. The span range for the spectrum analyzer shall be wide enough to see sufficient roll off of the signal to make the measurement.
- b) The nominal RBW shall be in the range of 1% to 5% of the anticipated OBW, and the VBW shall be set  $\geq 3 \times$  RBW.
- c) Set the reference level of the instrument as required to prevent the signal amplitude from exceeding the maximum spectrum analyzer input mixer level for linear operation. See guidance provided in 4.2.3.
- d) The dynamic range of the spectrum analyzer at the selected RBW shall be more than 10 dB below the target “-X dB” requirement, i.e., if the requirement calls for measuring the -26 dB OBW, the spectrum analyzer noise floor at the selected RBW shall be at least 36 dB below the reference level.
- e) Set spectrum analyzer detection mode to peak, and the trace mode to max hold.
- f) Determine the following reference values: Set the EUT to transmit a modulated signal. Allow the trace to stabilize. Set the spectrum analyzer marker to the highest level of the displayed trace (this is the reference value).
- g) Determine the “-X dB amplitude” as equal to (Reference Value - X). Alternatively, this calculation can be performed on the spectrum analyzer using the delta-marker measurement function.
- h) Place two markers, one at the lowest and the other at the highest frequency of the envelope of the spectral display such that each marker is at or slightly below the “-X dB amplitude” determined in step f). If a marker is below this “-X dB amplitude” value it should be as close as possible to this value. The OBW is the positive frequency difference between the two markers.
- i) The OBW shall be reported by providing plot(s) of the measuring instrument display, to include markers depicting the relevant frequency and amplitude information (e.g., marker table). The frequency and amplitude axis and scale shall be clearly labeled. Tabular data may be reported in addition to the plot(s).

For the occupied bandwidth measurement method, please refer to section 5.4.4 of ANSI C63.26.

### 4.4.3 Test Setup

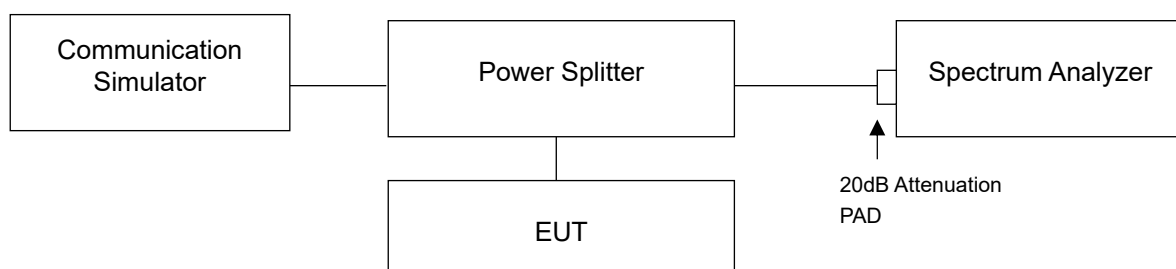

#### 4.4.4 Test Result

##### Occupied Bandwidth

5GNR n77 (Part 270), Channel Bandwidth 20MHz						
Channel	Frequency (MHz)	99% Occupied Bandwidth (MHz)				
		$\pi/2$ BPSK	QPSK	16QAM	64QAM	256QAM
647334	3710.01	18.03	18.25	18.24	18.19	18.20
656000	3840	18.03	18.20	18.20	18.20	18.25
664666	3969.99	18.10	18.24	18.24	18.19	18.19
5GNR n77 (Part 270), Channel Bandwidth 40MHz						
Channel	Frequency (MHz)	99% Occupied Bandwidth (MHz)				
		$\pi/2$ BPSK	QPSK	16QAM	64QAM	256QAM
648000	3720	37.50	37.83	37.83	37.82	37.83
656000	3840	37.48	37.83	37.82	37.83	37.83
664000	3960	37.34	37.83	37.82	37.80	37.81
5GNR n77 (Part 270) Channel Bandwidth 50MHz						
Channel	Frequency (MHz)	99% Occupied Bandwidth (MHz)				
		$\pi/2$ BPSK	QPSK	16QAM	64QAM	256QAM
648334	3725.01	47.04	47.49	47.46	47.48	47.48
656000	3840	47.03	47.48	47.48	47.47	47.47
663666	3954.99	47.05	47.47	47.48	47.49	47.48
5GNR n77 (Part 270) Channel Bandwidth 60MHz						
Channel	Frequency (MHz)	99% Occupied Bandwidth (MHz)				
		$\pi/2$ BPSK	QPSK	16QAM	64QAM	256QAM
648668	3730.02	57.90	57.89	57.88	57.90	57.88
656000	3840	57.85	57.88	57.87	57.87	57.86
663332	3949.98	57.90	57.87	57.87	57.88	57.86
5GNR n77 (Part 270), Channel Bandwidth 80MHz						
Channel	Frequency (MHz)	99% Occupied Bandwidth (MHz)				
		$\pi/2$ BPSK	QPSK	16QAM	64QAM	256QAM
649334	3740.01	77.19	77.52	77.54	77.52	77.51
656000	3840	77.18	77.50	77.48	77.48	77.49
662666	3939.99	77.18	77.50	77.50	77.52	77.51



5GNR n77 (Part 270), Channel Bandwidth 90MHz						
Channel	Frequency (MHz)	99% Occupied Bandwidth (MHz)				
		$\pi/2$ BPSK	QPSK	16QAM	64QAM	256QAM
649558	3745.02	86.90	86.94	86.91	86.92	86.93
656000	3840	86.86	87.53	87.53	87.51	87.52
662332	3934.98	86.84	87.52	87.54	87.53	87.49

5GNR n77 (Part 270), Channel Bandwidth 100MHz						
Channel	Frequency (MHz)	99% Occupied Bandwidth (MHz)				
		$\pi/2$ BPSK	QPSK	16QAM	64QAM	256QAM
650000	3750	96.84	97.62	97.65	97.62	97.39
656000	3840	96.58	97.39	97.40	97.61	97.40
662000	3930	96.57	97.40	97.39	97.38	97.60

**Spectrum Plot of Worst Value**



## Spectrum Plot of Worst Value

### 80MHz / 16QAM

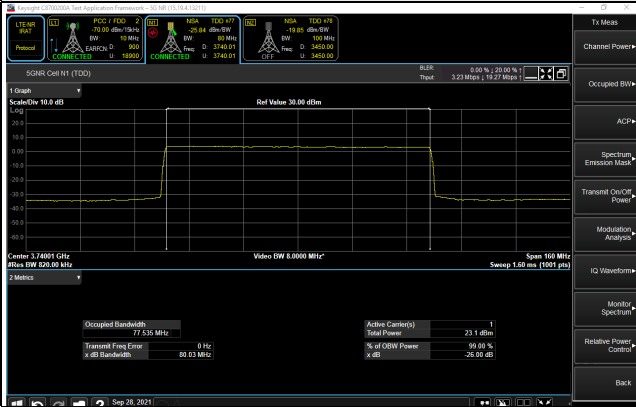

### 90MHz / 16QAM

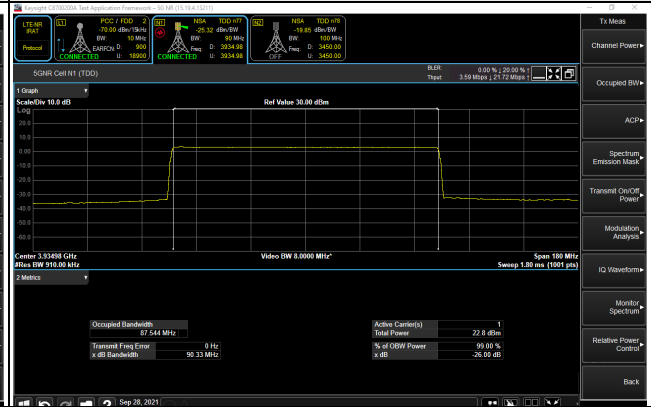

### 100MHz / 16QAM

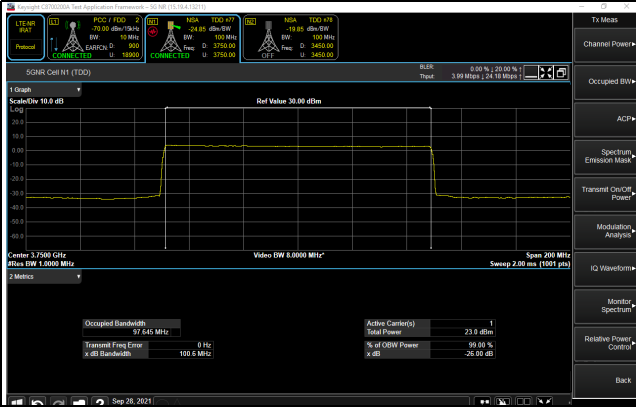

5G NR n77 (Part 27Q), Channel Bandwidth 20MHz

Channel	Frequency (MHz)	99% Occupied Bandwidth (MHz)				
		$\pi/2$ BPSK	QPSK	16QAM	64QAM	256QAM
630668	3460.02	18.02	18.24	18.19	18.20	18.20
633334	3500.01	18.02	18.24	18.24	18.24	18.19
636000	3540	18.03	18.24	18.24	18.25	18.20

5G NR n77 (Part 27Q), Channel Bandwidth 40MHz

Channel	Frequency (MHz)	99% Occupied Bandwidth (MHz)				
		$\pi/2$ BPSK	QPSK	16QAM	64QAM	256QAM
631334	3470.01	37.46	37.82	37.82	37.84	37.82
633334	3500.01	37.34	37.83	37.82	37.84	37.84
635332	3529.98	37.45	37.82	37.82	37.81	37.81

5G NR n77 (Part 27Q) Channel Bandwidth 50MHz

Channel	Frequency (MHz)	99% Occupied Bandwidth (MHz)				
		$\pi/2$ BPSK	QPSK	16QAM	64QAM	256QAM
631668	3475.02	46.88	47.47	47.48	47.46	47.47
633334	3500.01	47.07	47.47	47.48	47.47	47.47
635000	3525	47.03	47.48	47.48	47.48	47.47

5G NR n77 (Part 27Q) Channel Bandwidth 60MHz

Channel	Frequency (MHz)	99% Occupied Bandwidth (MHz)				
		$\pi/2$ BPSK	QPSK	16QAM	64QAM	256QAM
632000	3480	57.85	57.88	57.88	57.85	57.86
633334	3500.01	57.86	57.88	57.89	57.88	57.87
634666	3519.99	57.87	57.88	57.89	57.88	57.86

5G NR n77 (Part 27Q), Channel Bandwidth 80MHz

Channel	Frequency (MHz)	99% Occupied Bandwidth (MHz)				
		$\pi/2$ BPSK	QPSK	16QAM	64QAM	256QAM
632668	3490.02	77.16	77.51	77.52	77.48	77.49
633334	3500.01	77.16	77.51	77.51	77.52	77.51
634000	3510	77.16	77.52	77.51	77.52	77.54

### 5GNR n77 (Part 27Q), Channel Bandwidth 90MHz

Channel	Frequency (MHz)	99% Occupied Bandwidth (MHz)				
		$\pi/2$ BPSK	QPSK	16QAM	64QAM	256QAM
633000	3495	86.87	87.53	87.51	87.54	87.50
633334	3500.01	86.85	87.53	87.52	87.52	87.51
633666	3504.99	86.82	87.53	87.54	87.51	87.52

### 5GNR n77 (Part 27Q), Channel Bandwidth 100MHz

Channel	Frequency (MHz)	99% Occupied Bandwidth (MHz)				
		$\pi/2$ BPSK	QPSK	16QAM	64QAM	256QAM
633334	3500.01	96.51	97.38	97.40	97.40	97.38

### Spectrum Plot of Worst Value

20MHz / 64QAM

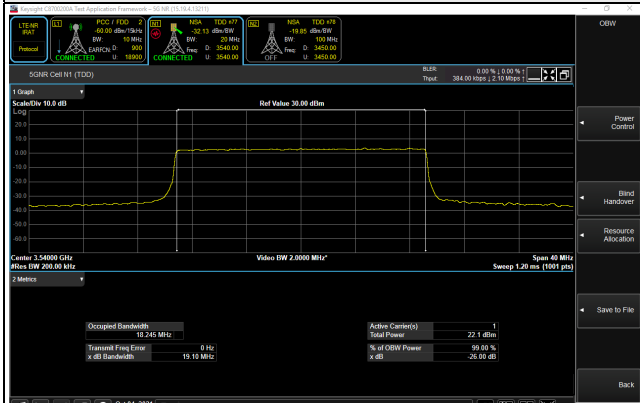

40MHz / 256QAM

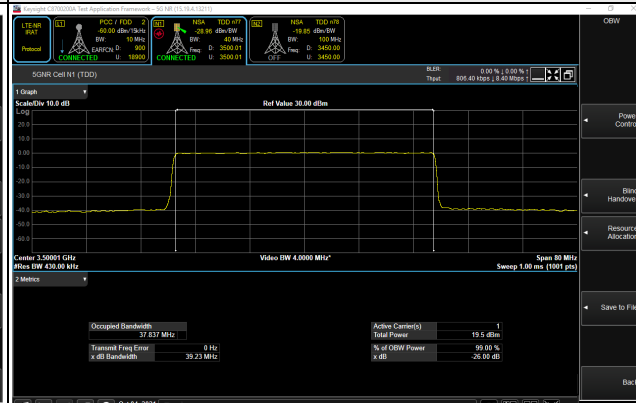

50MHz / 16QAM

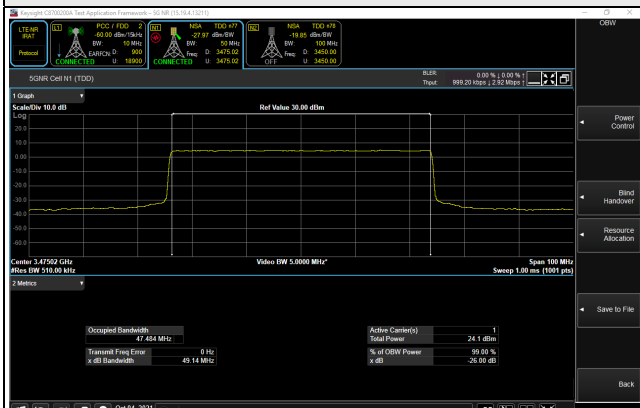

60MHz / 16QAM

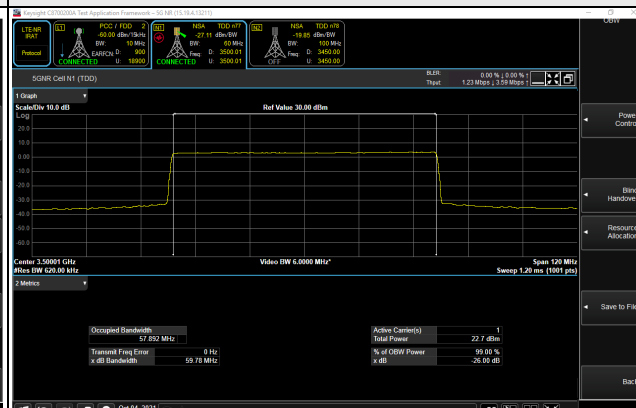

## Spectrum Plot of Worst Value

**80MHz / 256QAM**

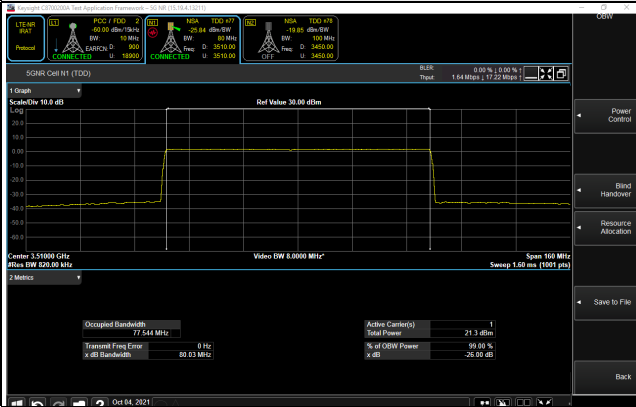

**90MHz / 16QAM**

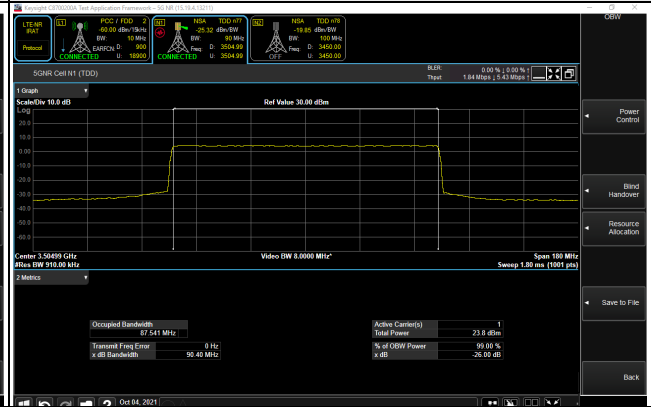

**100MHz / 64QAM**

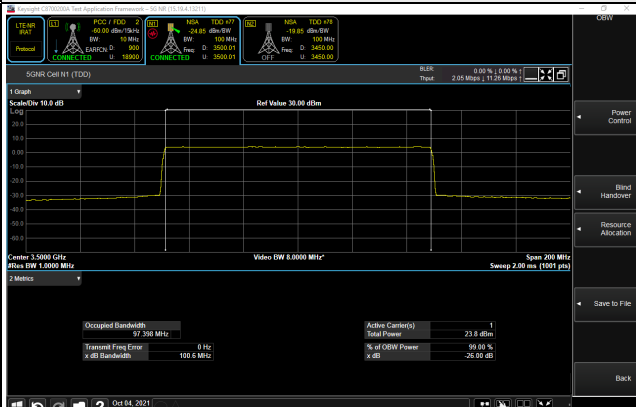

LTE Band 2

LTE Band 2, Channel Bandwidth 1.4MHz					
Channel	Frequency (MHz)	99% Occupied Bandwidth (MHz)			
		QPSK	16QAM	64QAM	256QAM
18607	1850.7	1.09	1.09	1.09	1.08
18900	1880.0	1.09	1.09	1.09	1.08
19193	1909.3	1.09	1.09	1.09	1.08
LTE Band 2, Channel Bandwidth 3MHz					
Channel	Frequency (MHz)	99% Occupied Bandwidth (MHz)			
		QPSK	16QAM	64QAM	256QAM
18615	1851.5	2.70	2.70	2.70	2.70
18900	1880.0	2.70	2.70	2.70	2.70
19185	1908.5	2.70	2.70	2.70	2.70
LTE Band 2, Channel Bandwidth 5MHz					
Channel	Frequency (MHz)	99% Occupied Bandwidth (MHz)			
		QPSK	16QAM	64QAM	256QAM
18625	1852.5	4.48	4.49	4.49	4.49
18900	1880.0	4.49	4.49	4.49	4.49
19175	1907.5	4.48	4.49	4.48	4.48
LTE Band 2, Channel Bandwidth 10MHz					
Channel	Frequency (MHz)	99% Occupied Bandwidth (MHz)			
		QPSK	16QAM	64QAM	256QAM
18650	1855.0	8.97	8.95	8.96	8.95
18900	1880.0	8.97	8.95	8.96	8.95
19150	1905.0	8.97	8.95	8.95	8.95
LTE Band 2, Channel Bandwidth 15MHz					
Channel	Frequency (MHz)	99% Occupied Bandwidth (MHz)			
		QPSK	16QAM	64QAM	256QAM
18675	1857.5	13.44	13.44	13.44	13.44
18900	1880.0	13.45	13.45	13.44	13.44
19125	1902.5	13.46	13.46	13.45	13.45
LTE Band 2, Channel Bandwidth 20MHz					
Channel	Frequency (MHz)	99% Occupied Bandwidth (MHz)			
		QPSK	16QAM	64QAM	256QAM
18700	1860.0	17.92	17.93	17.92	17.92
18900	1880.0	17.91	17.93	17.92	17.92
19100	1900.0	17.95	17.96	17.96	17.97

### Spectrum Plot of Worst Value

#### 1.4MHz / 64QAM

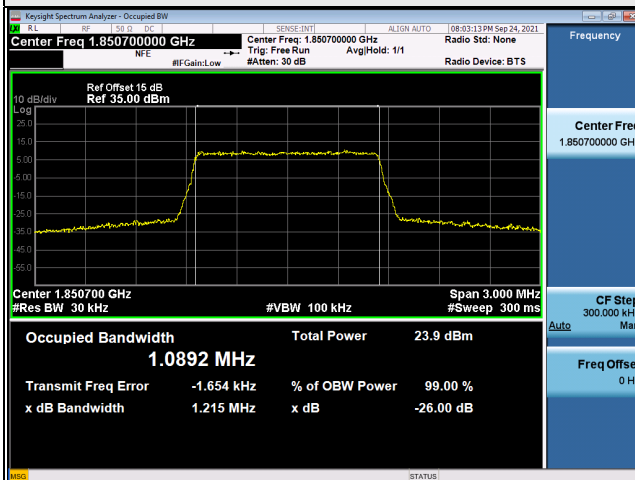

#### 3MHz / 64QAM

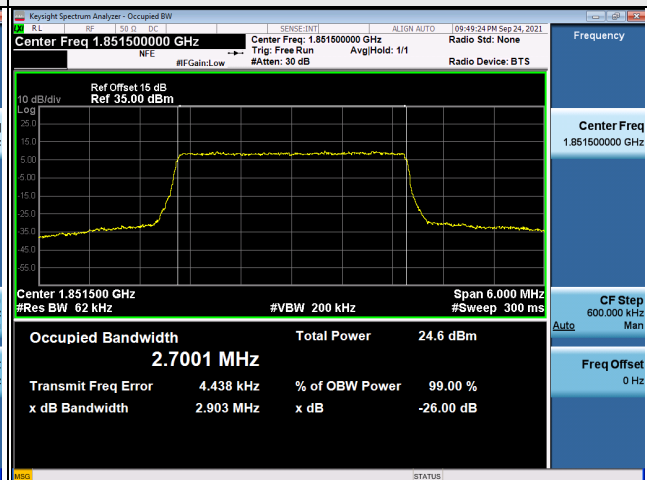

#### 5MHz / 64QAM

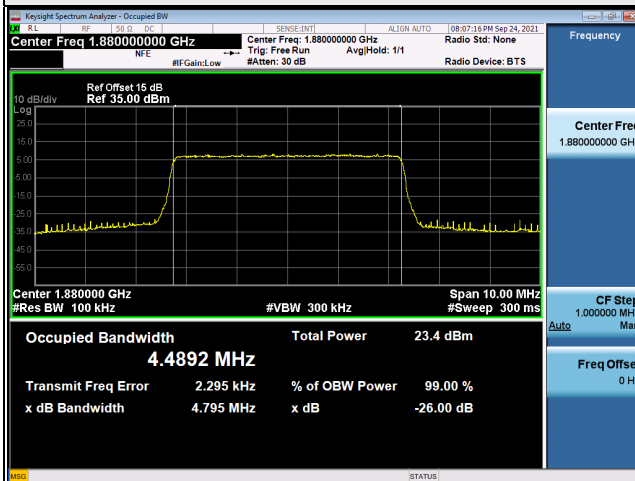

#### 10MHz / QPSK

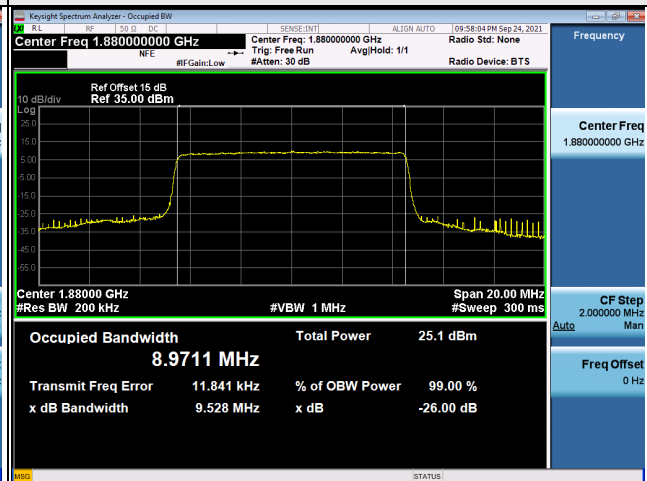

#### 15MHz / 16QAM

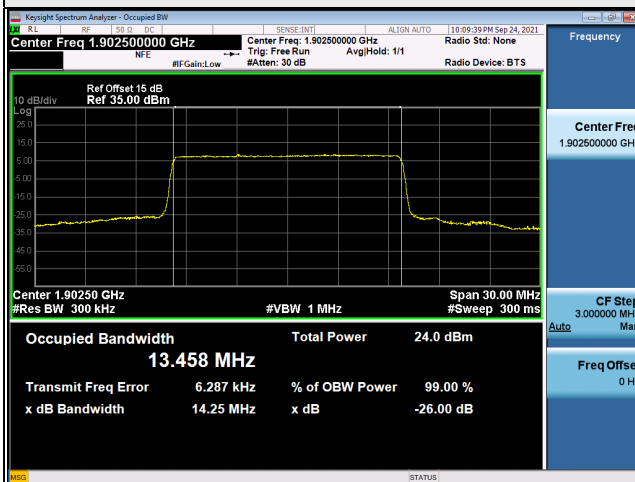

#### 20MHz / 256QAM

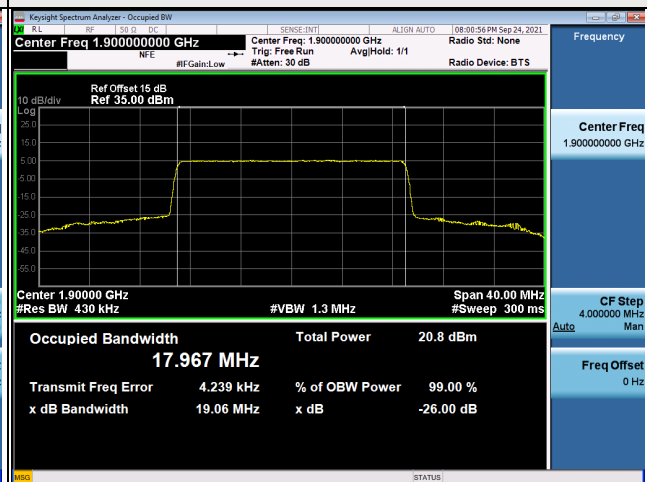

LTE Band 5

LTE Band 5, Channel Bandwidth 1.4MHz					
Channel	Frequency (MHz)	99% Occupied Bandwidth (MHz)			
		QPSK	16QAM	64QAM	256QAM
20407	824.7	1.09	1.09	1.09	1.09
20525	836.5	1.09	1.09	1.09	1.09
20643	848.3	1.09	1.09	1.09	1.08
LTE Band 5, Channel Bandwidth 3MHz					
Channel	Frequency (MHz)	99% Occupied Bandwidth (MHz)			
		QPSK	16QAM	64QAM	256QAM
20415	825.5	2.70	2.70	2.70	2.70
20525	836.5	2.70	2.70	2.70	2.70
20635	847.5	2.70	2.70	2.70	2.70
LTE Band 5, Channel Bandwidth 5MHz					
Channel	Frequency (MHz)	99% Occupied Bandwidth (MHz)			
		QPSK	16QAM	64QAM	256QAM
20425	826.5	4.48	4.49	4.48	4.48
20525	836.5	4.49	4.49	4.49	4.49
20625	846.5	4.49	4.49	4.48	4.48
LTE Band 5, Channel Bandwidth 10MHz					
Channel	Frequency (MHz)	99% Occupied Bandwidth (MHz)			
		QPSK	16QAM	64QAM	256QAM
20450	829.0	8.97	8.95	8.95	8.95
20525	836.5	8.97	8.95	8.95	8.95
20600	844.0	8.95	8.94	8.94	8.94