

FCC Test Report (Part 27: 5G NR)

Report No.: RF200109E02A-2

FCC ID: 2AQ68T99W175

Test Model: T99W175

Received Date: Jan. 10, 2020

Test Date: Feb. 26 ~ Mar. 26, 2020

Issued Date: Apr. 08, 2020

Applicant: Hon Lin Technology Co., Ltd.

Address: 11F, No. 32, Jihu Rd., Neihu Dist., Taipei City 114, Taiwan R.O.C.

Issued By: Bureau Veritas Consumer Products Services (H.K.) Ltd., Taoyuan Branch
Lin Kou Laboratories

Lab Address: No. 47-2, 14th Ling, Chia Pau Vil., Lin Kou Dist., New Taipei City, Taiwan

Test Location: No.19, Hwa Ya 2nd Rd., Wen Hwa Vil., Kwei Shan Dist., Taoyuan City
33383, Taiwan

FCC Registration / 788550 / TW0003

Designation Number:



This report is for your exclusive use. Any copying or replication of this report to or for any other person or entity, or use of our name or trademark, is permitted only with our prior written permission. This report sets forth our findings solely with respect to the test samples identified herein. The results set forth in this report are not indicative or representative of the quality or characteristics of the lot from which a test sample was taken or any similar or identical product unless specifically and expressly noted. Our report includes all of the tests requested by you and the results thereof based upon the information that you provided to us. You have 60 days from date of issuance of this report to notify us of any material error or omission caused by our negligence, provided, however, that such notice shall be in writing and shall specifically address the issue you wish to raise. A failure to raise such issue within the prescribed time shall constitute your unqualified acceptance of the completeness of this report, the tests conducted and the correctness of the report contents. Unless specific mention, the uncertainty of measurement has been explicitly taken into account to declare the compliance or non-compliance to the specification. The report must not be used by the client to claim product certification, approval, or endorsement by TAF or any government agency

Table of Contents

Release Control Record	4
1 Certificate of Conformity	5
2 Summary of Test Results	6
2.1 Measurement Uncertainty.....	6
2.2 Test Site and Instruments.....	7
3 General Information	8
3.1 General Description of EUT.....	8
3.2 Configuration of System under Test.....	11
3.2.1 Description of Support Units.....	11
3.3 Test Mode Applicability and Tested Channel Detail.....	12
3.4 EUT Operating Conditions.....	13
3.5 General Description of Applied Standards and References.....	13
4 Test Types and Results	14
4.1 Output Power Measurement.....	14
4.1.1 Limits of Output Power Measurement.....	14
4.1.2 Test Procedures.....	14
4.1.3 Test Setup.....	14
4.1.4 Test Results.....	15
4.2 Modulation Characteristics Measurement.....	17
4.2.1 Limits of Modulation Characteristics.....	17
4.2.2 Test Procedure.....	17
4.2.3 Test Setup.....	17
4.2.4 Test Results.....	18
4.3 Frequency Stability Measurement.....	19
4.3.1 Limits of Frequency Stability Measurement.....	19
4.3.2 Test Procedure.....	19
4.3.3 Test Setup.....	19
4.3.4 Test Results.....	20
4.4 Occupied Bandwidth Measurement.....	21
4.4.1 Limits of Occupied Bandwidth Measurement.....	21
4.4.2 Test Procedure.....	21
4.4.3 Test Setup.....	21
4.4.4 Test Result.....	22
4.5 Channel Edge Measurement.....	23
4.5.1 Limits of Band Edge Measurement.....	23
4.5.2 Test Setup.....	23
4.5.3 Test Procedures.....	23
4.5.4 Test Results.....	24
4.6 Peak to Average Ratio.....	26
4.6.1 Limits of Peak to Average Ratio Measurement.....	26
4.6.2 Test Setup.....	26
4.6.3 Test Procedures.....	26
4.6.4 Test Results.....	27
4.7 Conducted Spurious Emissions.....	28
4.7.1 Limits of Conducted Spurious Emissions Measurement.....	28
4.7.2 Test Setup.....	28
4.7.3 Test Procedure.....	28
4.7.4 Test Results.....	29
4.8 Radiated Emission Measurement.....	32
4.8.1 Limits of Radiated Emission Measurement.....	32
4.8.2 Test Procedure.....	32
4.8.3 Deviation from Test Standard.....	32
4.8.4 Test Setup.....	33

4.8.5 Test Results	34
5 Pictures of Test Arrangements.....	38
Appendix – Information of the Testing Laboratories	39

Release Control Record

Issue No.	Description	Date Issued
RF200109E02A-2	Original release	Apr. 08, 2020

1 Certificate of Conformity

Product: 5G WWAN Module
Brand: Foxconn
Test Model: T99W175
Sample Status: Engineering Sample
Applicant: Hon Lin Technology Co., Ltd.
Test Date: Feb. 26 ~ Mar. 26, 2020
Standards: FCC Part 27, Subpart M

The above equipment has been tested by **Bureau Veritas Consumer Products Services (H.K.) Ltd., Taoyuan Branch**, and found compliance with the requirement of the above standards. The test record, data evaluation & Equipment Under Test (EUT) configurations represented herein are true and accurate accounts of the measurements of the sample's RF characteristics under the conditions specified in this report.

Prepared by : Pettie Chen, **Date:** Apr. 08, 2020
Pettie Chen / Senior Specialist

Approved by : Bruce Chen, **Date:** Apr. 08, 2020
Bruce Chen / Senior Project Engineer

2 Summary of Test Results

Applied Standard: FCC Part 27 & Part 2			
FCC Clause	Test Item	Result	Remarks
n38			
2.1046 27.50 (h)(2)	Equivalent Isotropically Radiated Power / Equivalent Radiated Power	Pass	Meet the requirement of limit.
2.1047	Modulation Characteristics	Pass	Meet the requirement of limit.
----	Peak To Average Ratio	Pass	Meet the requirement of limit.
2.1055 27.54	Frequency Stability Stay with the authorized bands of operation	Pass	Meet the requirement of limit.
2.1049	Occupied Bandwidth	Pass	Meet the requirement of limit.
2.1051 27.53 (m)(4)(6)	Band Edge Measurements	Pass	Meet the requirement of limit.
2.1051 27.53 (m)(4)(6)	Conducted Spurious Emissions	Pass	Meet the requirement of limit.
2.1053 27.53 (m)(4)(6)	Radiated Spurious Emissions	Pass	Meet the requirement of limit. Minimum passing margin is -19.6dB at 30.00MHz.

Note: Determining compliance based on the results of the compliance measurement, not taking into account measurement instrumentation uncertainty.

2.1 Measurement Uncertainty

Where relevant, the following measurement uncertainty levels have been estimated for tests performed on the EUT as specified in CISPR 16-4-2:

Measurement	Frequency	Expanded Uncertainty (k=2) (\pm)
Radiated Emissions up to 1 GHz	9kHz ~ 30MHz	3.04 dB
	30MHz ~ 200MHz	3.63 dB
	200MHz ~ 1000MHz	3.64 dB
Radiated Emissions above 1 GHz	1GHz ~ 18GHz	2.29 dB
	18GHz ~ 40GHz	2.29 dB

2.2 Test Site and Instruments

Description & Manufacturer	Model No.	Serial No.	Cal. Date	Cal. Due
Test Receiver ROHDE & SCHWARZ	ESCI	100424	Dec. 31, 2019	Dec. 30, 2020
Spectrum Analyzer ROHDE & SCHWARZ	FSP40	100040	Sep. 23, 2019	Sep. 22, 2020
Spectrum Analyzer KEYSIGHT	N9030B	MY57140953	Jul. 03, 2019	Jul. 02, 2020
Radio Communication Analyzer Anritsu	MT8000A	6262012865	Dec. 12, 2019	Dec. 11, 2020
MXG Vector signal generator Agilent	N5182B	MY53050162	Jan. 14, 2020	Jan. 13, 2021
HORN Antenna ETS	3117	00034128	Nov. 24, 2019	Nov. 23, 2020
BILOG Antenna SCHWARZBECK	VULB9168	9168-155	Nov. 11, 2019	Nov. 10, 2020
HORN Antenna SCHWARZBECK	BBHA 9120D	9120D-1170	Nov. 24, 2019	Nov. 23, 2020
HORN Antenna ETS	3117	00034128	Nov. 24, 2019	Nov. 23, 2020
HORN Antenna SCHWARZBECK	BBHA 9170	BBHA9170241	Nov. 24, 2019	Nov. 23, 2020
Loop Antenna TESEQ	HLA 6121	45745	Jul. 01, 2019	Jun. 30, 2020
Preamplifier Agilent (Below 1GHz)	8447D	2944A10631	Jul. 11, 2019	Jul. 10, 2020
Preamplifier KEYSIGHT (Above 1GHz)	83017A	MY53270295	Jun. 11, 2019	Jun. 10, 2020
RF Coaxial Cable WOKEN With 5dB PAD	8D-FB	Cable-CH4-01	Aug. 20, 2019	Aug. 19, 2020
RF Coaxial Cable EMCI	EMC102-KM-KM-3000	150929	Aug. 20, 2019	Aug. 19, 2020
RF Coaxial Cable EMCI	EMC102-KM-KM-600	150928	Aug. 20, 2019	Aug. 19, 2020
RF signal cable HUBER+SUHNER	SUCOFLEX 104	MY 13380+295012/04	Jul. 11, 2019	Jul. 10, 2020
RF signal cable HUBER+SUHNER	SUCOFLEX 104	Cable-CH4-03 (250724)	Jul. 11, 2019	Jul. 10, 2020
Software BV ADT	ADT_Radiated_ V7.6.15.9.5	NA	NA	NA
Antenna Tower inn-co GmbH	MA 4000	010303	NA	NA
Antenna Tower Controller BV ADT	AT100	AT93021703	NA	NA
Boresight Antenna Fixture	FBA-01	FBA-SIP01	NA	NA
Standard Temperature And Humidity Chamber	MHU-225AU	920842	May 31, 2019	May 30, 2020
JFW 20dB attenuation	50HF-020-SMA	NA	NA	NA
True RMS Clamp Meter Fluke	325	31130711WS	May 21, 2019	May 20, 2020
DC power supply	U8002A	MY56330015	NA	NA

Note: 1. The calibration interval of the above test instruments is 12 months and the calibrations are traceable to NML/ROC and NIST/USA.
 2. The test was performed in HwaYa Chamber 4.

3 General Information

3.1 General Description of EUT

Product	5G WWAN Module						
Brand	Foxconn						
Test Model	T99W175						
Status of EUT	Engineering Sample						
Power Supply Rating	5 Vdc (Host equipment) 3.135Vdc~3.63Vdc (Module)						
Modulation Type	$\pi/2$ BPSK, QPSK, 16QAM, 64QAM, 256QAM						
Waveform Type	CP-OFDM, DFT-s-OFDM						
Operating Frequency	n38	Channel Bandwidth 20MHz	2580.0MHz ~ 2610.0MHz				
Max. EIRP Power			$\pi/2$ BPSK	QPSK	16QAM	64QAM	256QAM
	n38	Channel Bandwidth 20MHz	709.578mW (28.51dBm)	674.528mW (28.29dBm)	669.885mW (28.26dBm)	608.135mW (27.84dBm)	363.915mW (25.61dBm)
Emission Designator			$\pi/2$ BPSK	QPSK	16QAM	64QAM	256QAM
	n38	Channel Bandwidth 20MHz	17M9G7D	17M9G7D	17M9D7W	17M9D7W	17M9D7W
Antenna Type	Refer to Note as below						
Antenna Connector	Refer to Note as below						
Accessory Device	NA						
Cable Supplied	NA						

Note:

1. There are four Difference HW of T99W175.

Brand	Model	HW
Foxconn	T99W175	1. 3G+LTE+Sub6+eSIM
		2. 3G+LTE+Sub6 only w/o eSIM
		3. 3G+LTE+Sub6+eSIM+GNSS connector
		4. 3G+LTE+Sub6 only+w/o eSIM+GNSS connector

*After pre-testing, "HW: 1. 3G+LTE+Sub6+eSIM" is the worst for the final tests.

2. After pre-testing, "DFT-s-OFDM" is the worst for the final tests.

3. The following antennas were provided to the EUT.

Antenna No.	RF Chain No.	Brand	Model	Antenna Net Gain(dBi)	Frequency range (MHz)	Antenna Type	Connector Type
1		WHA YU	C107-511720-A	4.41	660~803	PCB	I-PEX
2		WHA YU	C107-511721-A	3.81 4.03	791~960 1447.9~1606	PCB	I-PEX
3		WHA YU	C107-511722-A	4.27 5.31	1710~2170 2500~2690	PCB	I-PEX
4		WHA YU	C107-511723-A	2.99 0.92	2300~2400 3500~3700	PCB	I-PEX
5		WHA YU	C107-511724-A	6.45	5150~5925	PCB	I-PEX
6		WHA YU	C107-511725-A	4.89	3400~3700	PCB	I-PEX
7		AVX	5000106-R1-X01	2.91	699~803	Monopole	I-PEX
8		AVX	5000107-R1-X01	2.59	791~960	Monopole	I-PEX
9		AVX	5000108-R1-X01	2.85	1427~1610	Monopole	I-PEX
10		AVX	5000109-R1-X01	2.23 2.94	1710~2200 5150~5925	Monopole	I-PEX
11		AVX	5000110-R1-X01	0.9	2300~2690	Monopole	I-PEX
12		AVX	5000111-R1-X01	0.87	3300~5000	Monopole	I-PEX
13	Tx1/ Rx1	Ethertronics	5003806	0.4 -1.61 0.39 2.95 1.98 0.38 0.83 2.31	698-821 824-960 1425-1515 1710-2200 2300-2690 3300-4200 4400-5000 5150-5925	PIFA	I-PEX
	Rx2	Ethertronics	5003807	-2.24 -4.52 2.87 2.99 2.93 2.91 2.23 -0.85 -3.04	716-821 824-960 1425-1515 1557-1610 1805-2200 2300-2690 3300-4200 4400-5000 5150-5925	PIFA	I-PEX
	Tx2/ Rx3	Ethertronics	5003806	2.21 2.25 -0.45 2.6	1710-2200 2300-2690 3300-4200 4400-5000	PIFA	I-PEX
	Rx4	Ethertronics	5003700	1.38 2.87 0.6 -2.09	1805-2200 2300-2690 3300-4200 4400-5000	PIFA	I-PEX

Antenna No.	RF Chain No.	Brand	Model	Antenna Net Gain(dBi)	Frequency range (MHz)	Antenna Type	Connector Type
14	Ant. 0 (TX/RX)	Master Wave	NA	2.4	880~960	PCB	I-PEX
				2.2	1020~2170		
				2.9	2545~2595		
				2.9	3565~3600		
				2.9	3900~4000		
	Ant. 2 (TX/RX)	Master Wave	NA	NA	880~960	PCB	I-PEX
				2.2	1020~2170		
				2.8	2545~2595		
				2.9	3565~3600		
				2.8	3900~4000		
	Ant. 1 (RX)	Master Wave	NA	NA	880~960	PCB	I-PEX
				5.3	1020~2170		
				5.1	2545~2595		
				4.3	3565~3600		
				4.5	3900~4000		
	Ant. 3 (RX)	Master Wave	NA	1.3	880~960	PCB	I-PEX
6.8				1020~2170			
3.7				2545~2595			
6.4				3565~3600			
6.2				3900~4000			
				3.7	GPS		

*The antenna for the final tests as following table.

	Band	Antenna
5GNR	38 (30kHz) /20	Antenna 3

3.2 Configuration of System under Test

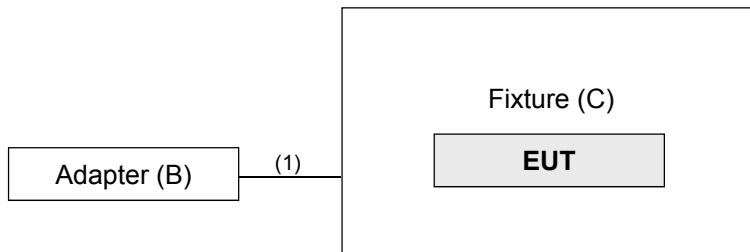

Remote site



3.2.1 Description of Support Units

The EUT has been tested as an independent unit together with other necessary accessories or support units. The following support units or accessories were used to form a representative test configuration during the tests.

ID	Product	Brand	Model No.	Serial No.	FCC ID	Remarks
A.	Radio Communication Analyzer	Anritsu	MT8821C	6261806803	NA	-
B.	Adapter	LITEON	PA-1050-39	NA	NA	-
C.	Fixture	NA	NA	NA	NA	Provided by client.

Note:

1. All power cords of the above support units are non-shielded (1.8m).
2. Item A acted as a communication partner to transfer data.

ID	Descriptions	Qty.	Length (m)	Shielding (Yes/No)	Cores (Qty.)	Remarks
1.	USB cable	1	1.5	Y	0	-

3.3 Test Mode Applicability and Tested Channel Detail

Pre-Scan has been conducted to determine the worst-case mode from all possible combinations between available modulations, data rates, XYZ axis and antenna ports. The worst case was found when positioned on Z-plane. Following channel(s) was (were) selected for the final test as listed below.

n38

EUT Configure Mode	Test item	Available channel	Tested channel	Channel Bandwidth	Modulation	Mode
-	EIRP	512000 to 522000	516000(2580.0MHz), 519000(2595.0MHz), 522000(2610.0MHz)	20MHz	$\pi/2$ BPSK / QPSK / 16QAM / 64QAM / 256QAM	1 RB / 0 RB Offset 1 RB / 50 RB Offset 1 RB / 99 RB Offset 50 RB / 0 RB Offset 50 RB / 25 RB Offset 50 RB / 50 RB Offset 100 RB / 0 RB Offset
-	Modulation Characteristics	512000 to 522000	519000(2595.0MHz)	20MHz	$\pi/2$ BPSK / QPSK / 16QAM / 64QAM / 256QAM	51 RB / 0 RB Offset
-	Frequency Stability	512000 to 522000	516000(2580.0MHz), 522000(2610.0MHz)	20MHz	$\pi/2$ BPSK	51 RB / 0 RB Offset
-	Emission Bandwidth	512000 to 522000	516000(2580.0MHz), 519000(2595.0MHz), 522000(2610.0MHz)	20MHz	$\pi/2$ BPSK / QPSK / 16QAM / 64QAM / 256QAM	51 RB / 0 RB Offset
-	Band Edge	512000 to 522000	516000(2580.0MHz), 519000(2595.0MHz), 522000(2610.0MHz)	20MHz	$\pi/2$ BPSK	1 RB / 0 RB Offset 1 RB / 24 RB Offset 51 RB / 0 RB Offset
-	Peak to Average Ratio	512000 to 522000	516000(2580.0MHz), 519000(2595.0MHz), 522000(2610.0MHz)	20MHz	$\pi/2$ BPSK / QPSK / 16QAM / 64QAM / 256QAM	1 RB / 0 RB Offset
-	Conducted Emission	512000 to 522000	516000(2580.0MHz), 519000(2595.0MHz), 522000(2610.0MHz)	20MHz	$\pi/2$ BPSK	1 RB / 0 RB Offset
-	Radiated Emission Below 1GHz	512000 to 522000	519000(2595.0MHz)	20MHz	$\pi/2$ BPSK	1 RB / 0 RB Offset
-	Radiated Emission Above 1GHz	512000 to 522000	516000(2580.0MHz), 519000(2595.0MHz), 522000(2610.0MHz)	20MHz	$\pi/2$ BPSK	1 RB / 0 RB Offset

Note: The conducted output power for $\pi/2$ BPSK, QPSK, 16QAM, 64QAM and 256QAM, measured value of $\pi/2$ BPSK is higher than QPSK, 16QAM, 64QAM and 256QAM mode. Therefore, only EIRP, Modulation characteristics, occupied bandwidth and Peak to average ratio items had been tested under $\pi/2$ BPSK, QPSK, 16QAM, 64QAM and 256QAM modes, the other test items were performed under $\pi/2$ BPSK mode only.

Test Condition:

Test Item	Environmental Conditions	Input Power	Tested By
EIRP / ERP	25deg. C, 70%RH	5Vdc	James Yang
Modulation characteristics	24deg. C, 64%RH	5Vdc	James Yang
Frequency Stability	24deg. C, 64%RH	5Vdc	James Yang
Occupied Bandwidth	24deg. C, 64%RH	5Vdc	James Yang
Band Edge	24deg. C, 64%RH	5Vdc	James Yang
Peak To Average Ratio	24deg. C, 64%RH	5Vdc	James Yang
Conducted Emission	24deg. C, 64%RH	5Vdc	James Yang
Radiated Emission	22deg. C, 68%RH	120Vac, 60Hz	Greg Lin

3.4 EUT Operating Conditions

The EUT makes a call to the communication simulator. The communication simulator station system controlled a EUT to export maximum output power under transmission mode and specific channel frequency

3.5 General Description of Applied Standards and References

The EUT is a RF Product. According to the specifications of the manufacturer, it must comply with the requirements of the following standards and References:

Test Standard:

FCC 47 CFR Part 2

FCC 47 CFR Part 27

ANSI/TIA/EIA-603-E 2016

ANSI 63.26-2015

All test items have been performed and recorded as per the above standards.

References Test Guidance:

KDB 971168 D01 Power Meas License Digital Systems v03r01

All test items have been performed as a reference to the above KDB test guidance.

4 Test Types and Results

4.1 Output Power Measurement

4.1.1 Limits of Output Power Measurement

Mobile stations are limited to 2.0 watts EIRP. All user stations are limited to 2.0 watts transmitter output power.

4.1.2 Test Procedures

Conducted Power Measurement:

The EUT was set up for the maximum power with 5GNR link data modulation and link up with simulator. Set the EUT to transmit under low, middle and high channel and record the power level shown on simulator.

Maximum EIRP / ERP

The relevant equation for determining the maximum ERP or EIRP from the measured RF output power is

given in Equation as follows:

$$\text{ERP or EIRP} = P_{\text{Meas}} + G_{\text{T}}$$

where

ERP or EIRP effective radiated power or equivalent isotropically radiated power, respectively
(expressed in the same units as P_{Meas} , e.g., dBm or dBW)

P_{Meas} measured transmitter output power or PSD, in dBm or dBW

G_{T} gain of the transmitting antenna, in dBd (ERP) or dBi (EIRP)

4.1.3 Test Setup

Conducted Power Measurement:

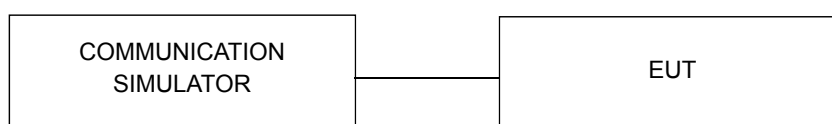

For the actual test configuration, please refer to the attached file (Test Setup Photo).

4.1.4 Test Results

Conducted Output Power (dBm)

n38						
BW	MCS Index	Channel		516000	519000	522000
		Frequency (MHz)		2580	2595	2610
20M	$\pi/2$ BPSK	1	0	22.94	22.99	23.10
		1	12	23.05	23.20	22.99
		1	24	22.86	22.90	22.91
		25	0	22.52	22.42	22.62
		25	12	22.53	22.80	22.57
		25	25	22.42	22.75	22.42
		51	0	22.73	22.45	22.89
	QPSK	1	0	22.82	22.77	22.94
		1	12	22.71	22.86	22.98
		1	24	22.76	22.78	22.94
		25	0	22.60	22.76	22.72
		25	12	22.59	22.78	22.56
		25	25	22.67	22.54	22.66
		51	0	22.62	22.74	22.57
	16QAM	1	0	22.78	22.73	22.79
		1	12	22.60	22.63	22.89
		1	24	22.95	22.59	22.94
		25	0	22.78	22.53	22.73
		25	12	22.77	22.72	22.37
		25	25	22.80	22.49	22.31
		51	0	22.71	22.65	22.47
	64QAM	1	0	22.14	22.49	22.53
		1	12	22.10	22.20	22.36
		1	24	22.21	22.36	22.18
		25	0	22.34	22.14	22.31
		25	12	22.24	21.90	21.84
		25	25	21.92	22.27	22.09
		51	0	22.38	22.01	22.21
	256QAM	1	0	19.76	19.81	20.02
		1	12	19.79	19.81	20.16
1		24	20.26	20.15	20.30	
25		0	19.52	19.82	19.46	
25		12	19.82	19.87	19.12	
25		25	19.33	19.99	19.46	
51		0	19.43	19.24	19.24	

EIRP Power(dBm)

		n38				
BW	MCS Index	Channel		516000	519000	522000
		Frequency (MHz)		2580	2595	2610
20M	$\pi/2$ BPSK	1	0	28.25	28.30	28.41
		1	12	28.36	28.51	28.30
		1	24	28.17	28.21	28.22
		25	0	27.83	27.73	27.93
		25	12	27.84	28.11	27.88
		25	25	27.73	28.06	27.73
		51	0	28.04	27.76	28.20
	QPSK	1	0	28.13	28.08	28.25
		1	12	28.02	28.17	28.29
		1	24	28.07	28.09	28.25
		25	0	27.91	28.07	28.03
		25	12	27.90	28.09	27.87
		25	25	27.98	27.85	27.97
		51	0	27.93	28.05	27.88
	16QAM	1	0	28.09	28.04	28.10
		1	12	27.91	27.94	28.20
		1	24	28.26	27.90	28.25
		25	0	28.09	27.84	28.04
		25	12	28.08	28.03	27.68
		25	25	28.11	27.80	27.62
		51	0	28.02	27.96	27.78
	64QAM	1	0	27.45	27.80	27.84
		1	12	27.41	27.51	27.67
		1	24	27.52	27.67	27.49
		25	0	27.65	27.45	27.62
		25	12	27.55	27.21	27.15
		25	25	27.23	27.58	27.40
		51	0	27.69	27.32	27.52
	256QAM	1	0	25.07	25.12	25.33
		1	12	25.10	25.12	25.47
1		24	25.57	25.46	25.61	
25		0	24.83	25.13	24.77	
25		12	25.13	25.18	24.43	
25		25	24.64	25.30	24.77	
51		0	24.74	24.55	24.55	

*EIRP = Conducted + antenna gain (5.31dBi)

4.2 Modulation Characteristics Measurement

4.2.1 Limits of Modulation Characteristics

N/A

4.2.2 Test Procedure

Connect the EUT to Communication Simulator via the antenna connector, The frequency band is set as EUT supported Modulation and Channels, the EUT output is matched with 50 ohm load, the waveform quality and constellation of the EUT was tested.

4.2.3 Test Setup

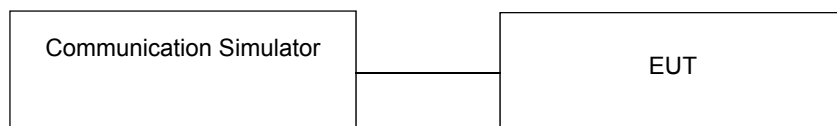

4.2.4 Test Results

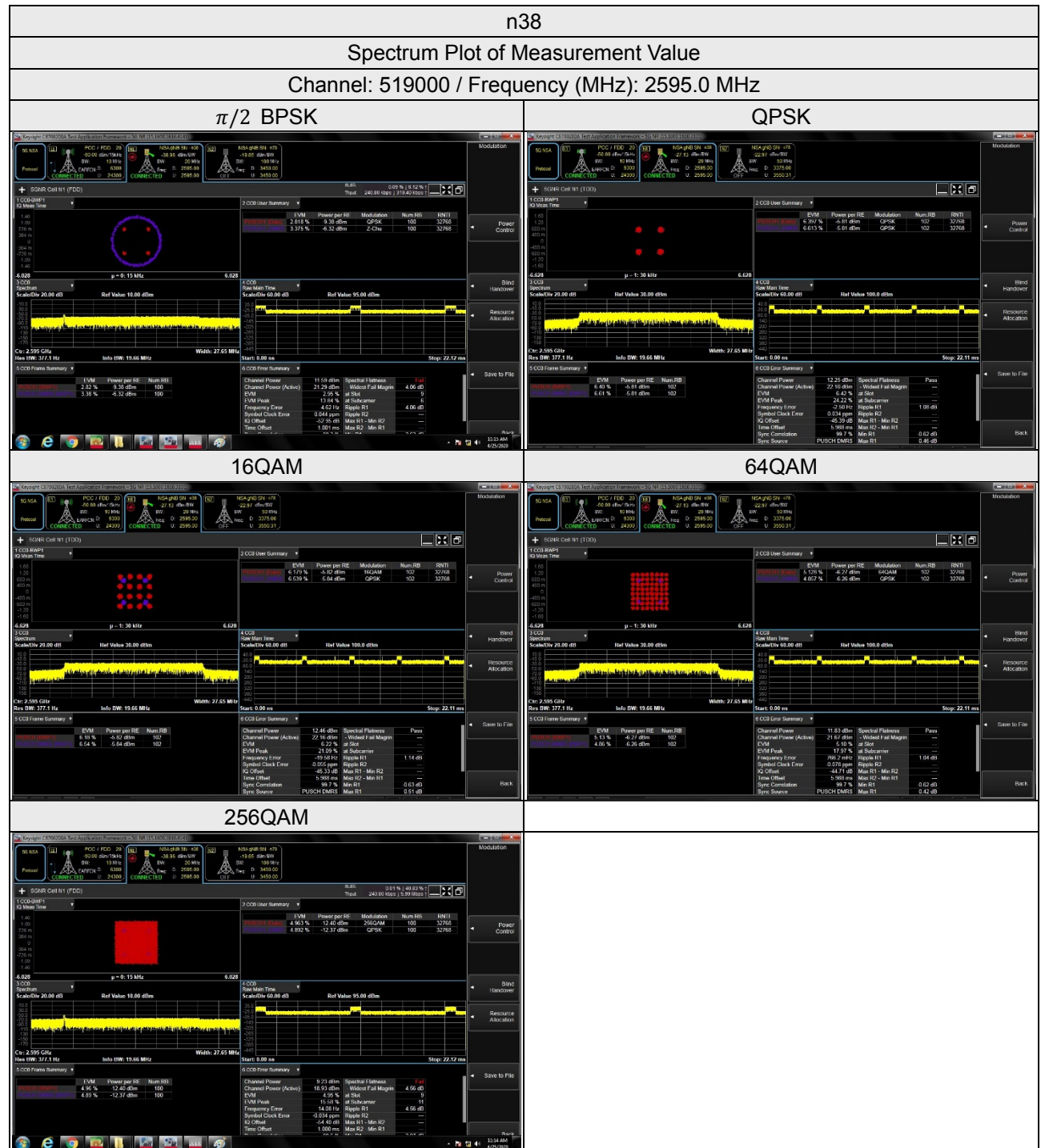

4.3 Frequency Stability Measurement

4.3.1 Limits of Frequency Stability Measurement

According to the FCC part 2.1055 shall be tested the frequency stability. The rule is defined that "The frequency stability shall be sufficient to ensure that the fundamental emission stays within the authorized frequency block." The test extreme voltage is according to the 2.1055(d)(1) Vary primary supply voltage from 85 to 115 percent of the nominal value for other than hand carried battery equipment and the extreme temperature rule is comply with specification of EUT $-30^{\circ}\text{C} \sim 50^{\circ}\text{C}$.

4.3.2 Test Procedure

- Device is placed at the oven room. The oven room could control the temperatures and humidity. Power warm up is at least 15 min and power applied should perform before recording frequency error.
- EUT is connected the external power supply to control the DC input power. The test voltage range is from minimum to maximum working voltage. Each step shall be record the frequency error rate.
- The temperature range step is 10 degrees in this test items. All temperature levels shall be hold the $\pm 0.5^{\circ}\text{C}$ during the measurement testing. The each temperature step shall be at least 0.5 hours, consider the EUT could be test under the stability condition.

Note: The frequency error was recorded frequency error from the communication simulator.

4.3.3 Test Setup

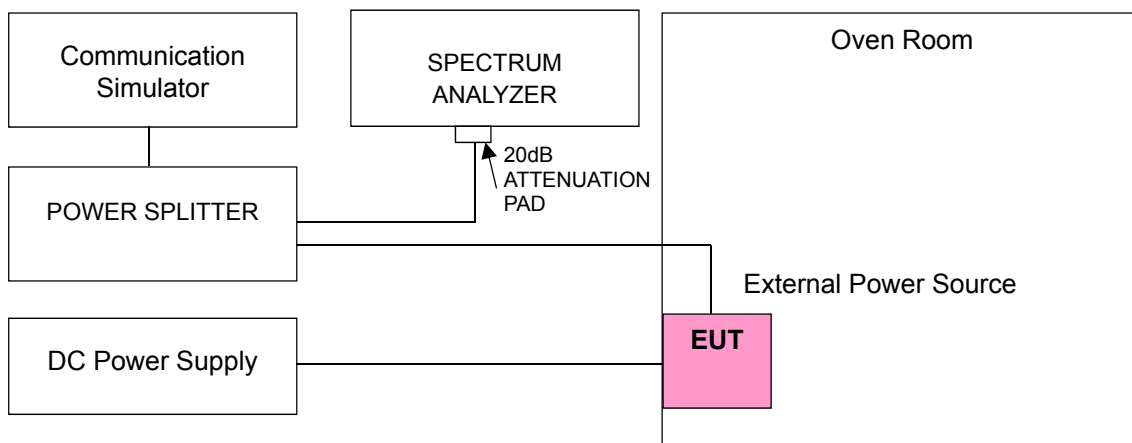

4.3.4 Test Results

Frequency Error vs. Voltage

Voltage (Volts)	n38			
	Channel Bandwidth: 20 MHz			
	Low Channel		High Channel	
	Frequency (MHz)	Frequency Error (ppm)	Frequency (MHz)	Frequency Error (ppm)
4.25	2580.000003	0.001	2610.000003	0.001
5	2580.000003	0.001	2610.000002	0.001
5.75	2580.000003	0.001	2610.000000	0.001

Note: The applicant defined the normal working voltage is from 4.25Vdc to 5.75Vdc.

Frequency Error vs. Temperature

Temp. (°C)	n38			
	Channel Bandwidth: 20 MHz			
	Low Channel		High Channel	
	Frequency (MHz)	Frequency Error (ppm)	Frequency (MHz)	Frequency Error (ppm)
-30	2580.000002	0.001	2610.000003	0.001
-20	2580.000003	0.001	2610.000002	0.001
-10	2580.000001	0.001	2610.000004	0.001
0	2580.000002	0.001	2610.000004	0.001
10	2580.000002	0.001	2610.000003	0.001
20	2579.999998	-0.001	2609.999998	-0.001
30	2579.999999	0.000	2609.999999	0.000
40	2579.999997	-0.001	2609.999996	-0.001
50	2579.999997	-0.001	2609.999997	-0.001

4.4 Occupied Bandwidth Measurement

4.4.1 Limits of Occupied Bandwidth Measurement

The occupied bandwidth (OBW), that is the frequency bandwidth such that, below its lower and above its upper frequency limits, the mean powers radiated are each equal to 0.5 % of the total mean power radiated by a given emission.

4.4.2 Test Procedure

The transmitter output was connected to the spectrum analyzer through an attenuator. The bandwidth of the fundamental frequency was measured by spectrum analyzer with RBW = 430kHz and VBW = 1.3MHz (Channel Bandwidth: 20MHz). The 26dB bandwidth is defined as the total spectrum the power of which is higher than peak power minus 26dB.

4.4.3 Test Setup

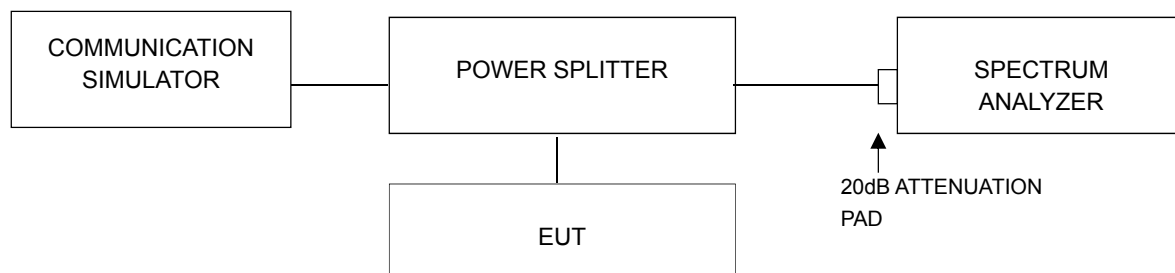

4.4.4 Test Result

Occupied Bandwidth

n38

n38, Channel Bandwidth 20MHz						
Channel	Frequency (MHz)	99% Occupied Bandwidth (MHz)				
		$\pi/2$ BPSK	QPSK	16QAM	64QAM	256QAM
516000	2580.0	17.912	17.903	17.902	17.898	17.899
519000	2595.0	17.906	17.906	17.893	17.900	17.894
522000	2610.0	17.903	17.904	17.891	17.901	17.902

26dB Bandwidth

n38

n38, Channel Bandwidth 20MHz						
Channel	Frequency (MHz)	26dB Bandwidth (MHz)				
		$\pi/2$ BPSK	QPSK	16QAM	64QAM	256QAM
516000	2580.0	19.02	19.00	18.99	19.00	19.00
519000	2595.0	19.02	19.02	19.01	18.99	19.01
522000	2610.0	19.01	19.01	18.99	19.00	19.00

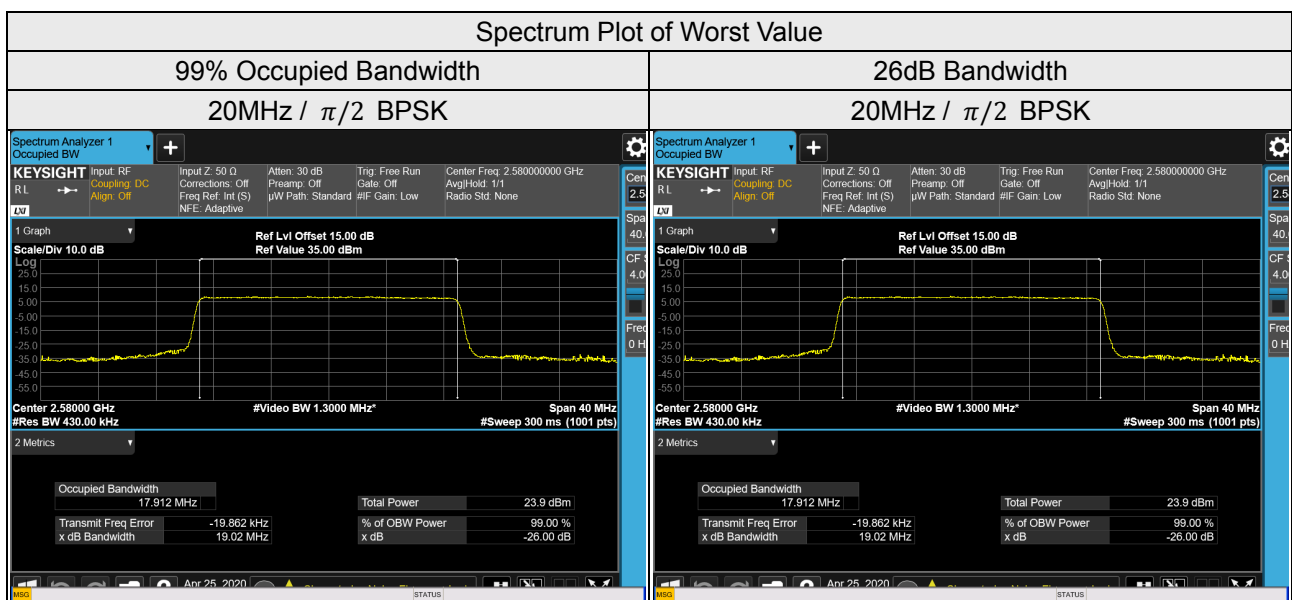

4.5 Channel Edge Measurement

4.5.1 Limits of Band Edge Measurement

According to FCC 27.53(m)(4) specified that power of any emission outside of the channel edge must be attenuated below the transmitting power (P) by a factor shall be not less than $40 + 10 \log (P)$ dB on all frequencies between the channel edge and 5 megahertz from the channel edge, $43 + 10 \log (P)$ dB on all frequencies between 5 megahertz and X megahertz from the channel edge, and $55 + 10 \log (P)$ dB on all frequencies more than X megahertz from the channel edge, where X is the greater of 6 megahertz or the actual emission bandwidth. In addition, the attenuation factor shall not be less that $43 + 10 \log (P)$ dB on all frequencies between 2490.5 MHz and 2496 MHz and $55 + 10 \log (P)$ dB at or below 2490.5 MHz. In the 1 MHz bands immediately outside and adjacent to the frequency block a resolution bandwidth of at least two percent may be employed, except when the 1 megahertz band is 2495-2496 MHz, in which case a resolution bandwidth of at least one percent may be employed.

4.5.2 Test Setup

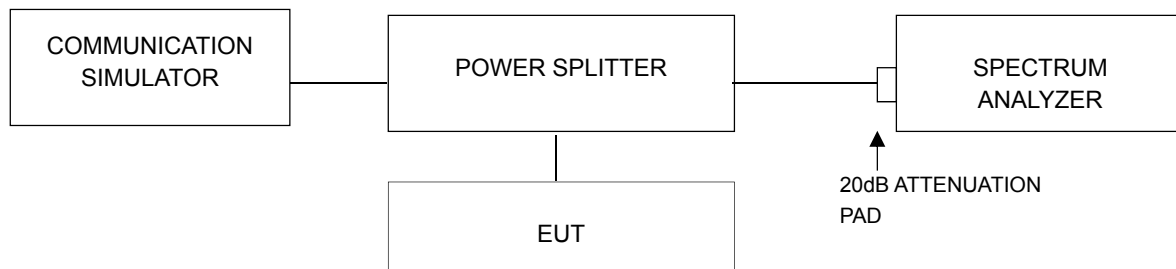

4.5.3 Test Procedures

- The EUT was set up for the rated peak power. The power was measured with Spectrum Analyzer. Band edge measurements were done at 2 channels: low, middle and high operational frequency range. Emission mask measurements were done at 3 channels: low and high operational frequency range.
- The center frequency of spectrum is the band edge frequency and span is 1MHz. RB of the spectrum is 200kHz and VB of the spectrum is 1MHz (Channel Bandwidth 20MHz).
- n38 measurement procedure refer 27.53(m)(4).
- Record the max trace plot into the test report.

4.5.4 Test Results

Emission Mask:

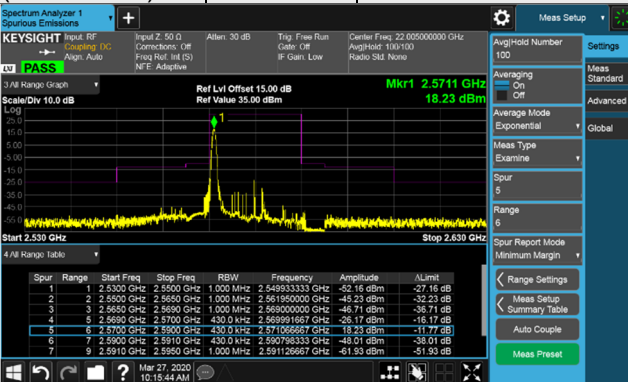
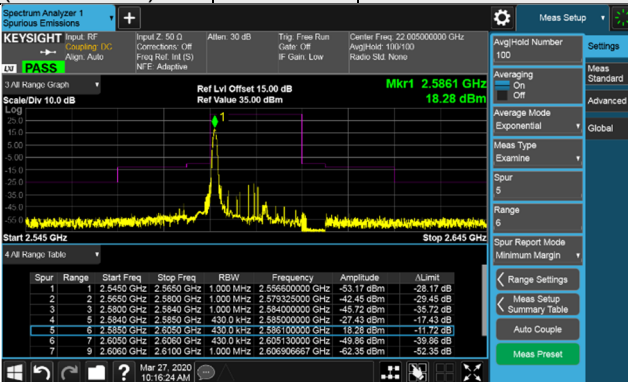
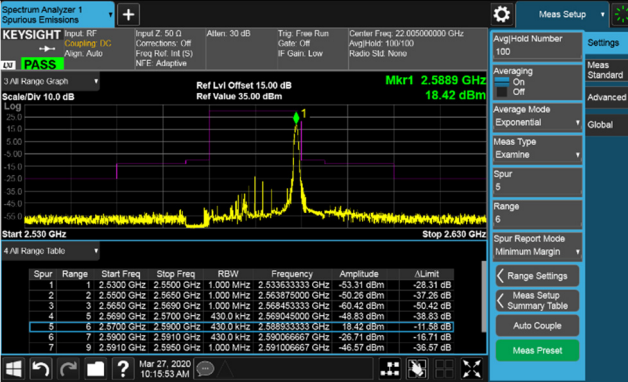
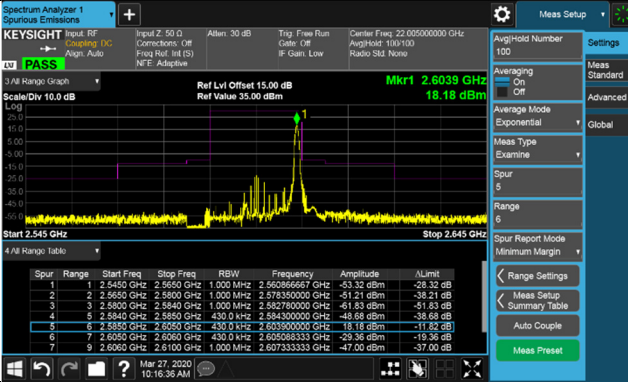
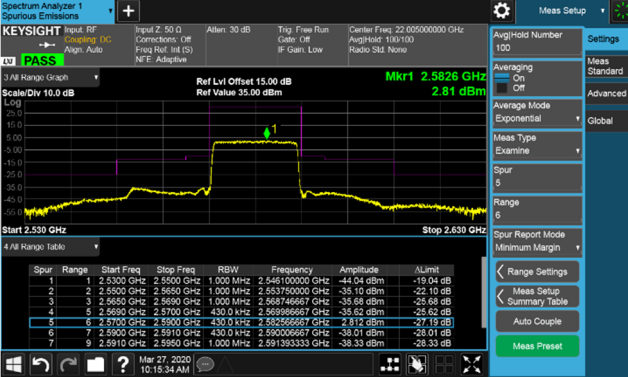
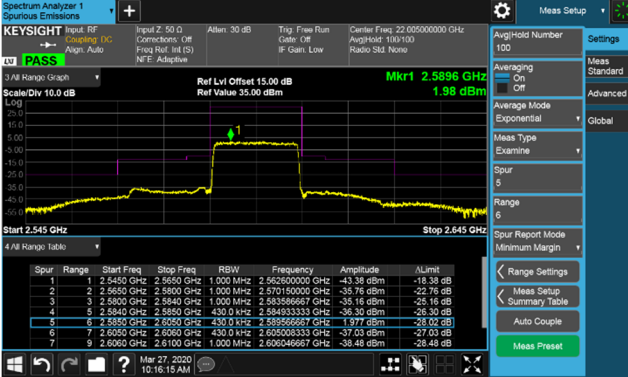
Channel 516000 (2580.0MHz) $\pi/2$ BPSK 1 RB / 0 RB Offset		Channel 519000 (2595.0MHz) $\pi/2$ BPSK 1 RB / 0 RB Offset																																																																																																																																	
 <table border="1"> <thead> <tr> <th>Spur</th> <th>Range</th> <th>Start Freq</th> <th>Stop Freq</th> <th>RBW</th> <th>Frequency</th> <th>Amplitude</th> <th>ALimit</th> </tr> </thead> <tbody> <tr><td>1</td><td></td><td>2.5300 GHz</td><td>2.5500 GHz</td><td>1.000 MHz</td><td>2.569333333 GHz</td><td>-55.16 dBm</td><td>-27.16 dB</td></tr> <tr><td>2</td><td></td><td>2.5300 GHz</td><td>2.5500 GHz</td><td>1.000 MHz</td><td>2.561900000 GHz</td><td>-45.23 dBm</td><td>-32.33 dB</td></tr> <tr><td>3</td><td></td><td>2.5650 GHz</td><td>2.5650 GHz</td><td>1.000 MHz</td><td>2.569300000 GHz</td><td>-46.71 dBm</td><td>-36.71 dB</td></tr> <tr><td>4</td><td></td><td>2.5650 GHz</td><td>2.5650 GHz</td><td>430.0 kHz</td><td>2.569916667 GHz</td><td>-26.17 dBm</td><td>-16.17 dB</td></tr> <tr><td>5</td><td></td><td>2.5700 GHz</td><td>2.5700 GHz</td><td>430.0 kHz</td><td>2.571066667 GHz</td><td>-18.23 dBm</td><td>-11.72 dB</td></tr> <tr><td>6</td><td></td><td>2.5900 GHz</td><td>2.5910 GHz</td><td>430.0 kHz</td><td>2.590768333 GHz</td><td>-43.01 dBm</td><td>-38.01 dB</td></tr> <tr><td>7</td><td></td><td>2.5910 GHz</td><td>2.5920 GHz</td><td>1.000 MHz</td><td>2.591066667 GHz</td><td>-61.93 dBm</td><td>-51.93 dB</td></tr> </tbody> </table>		Spur	Range	Start Freq	Stop Freq	RBW	Frequency	Amplitude	ALimit	1		2.5300 GHz	2.5500 GHz	1.000 MHz	2.569333333 GHz	-55.16 dBm	-27.16 dB	2		2.5300 GHz	2.5500 GHz	1.000 MHz	2.561900000 GHz	-45.23 dBm	-32.33 dB	3		2.5650 GHz	2.5650 GHz	1.000 MHz	2.569300000 GHz	-46.71 dBm	-36.71 dB	4		2.5650 GHz	2.5650 GHz	430.0 kHz	2.569916667 GHz	-26.17 dBm	-16.17 dB	5		2.5700 GHz	2.5700 GHz	430.0 kHz	2.571066667 GHz	-18.23 dBm	-11.72 dB	6		2.5900 GHz	2.5910 GHz	430.0 kHz	2.590768333 GHz	-43.01 dBm	-38.01 dB	7		2.5910 GHz	2.5920 GHz	1.000 MHz	2.591066667 GHz	-61.93 dBm	-51.93 dB	 <table border="1"> <thead> <tr> <th>Spur</th> <th>Range</th> <th>Start Freq</th> <th>Stop Freq</th> <th>RBW</th> <th>Frequency</th> <th>Amplitude</th> <th>ALimit</th> </tr> </thead> <tbody> <tr><td>1</td><td></td><td>2.5450 GHz</td><td>2.5650 GHz</td><td>1.000 MHz</td><td>2.565600000 GHz</td><td>-53.18 dBm</td><td>-28.18 dB</td></tr> <tr><td>2</td><td></td><td>2.5650 GHz</td><td>2.5800 GHz</td><td>1.000 MHz</td><td>2.579325000 GHz</td><td>-42.46 dBm</td><td>-29.46 dB</td></tr> <tr><td>3</td><td></td><td>2.5800 GHz</td><td>2.5840 GHz</td><td>1.000 MHz</td><td>2.584000000 GHz</td><td>-45.72 dBm</td><td>-36.72 dB</td></tr> <tr><td>4</td><td></td><td>2.5840 GHz</td><td>2.5850 GHz</td><td>430.0 kHz</td><td>2.585000000 GHz</td><td>-27.43 dBm</td><td>-17.43 dB</td></tr> <tr><td>5</td><td></td><td>2.5850 GHz</td><td>2.5850 GHz</td><td>430.0 kHz</td><td>2.588100000 GHz</td><td>-18.28 dBm</td><td>-11.72 dB</td></tr> <tr><td>6</td><td></td><td>2.6050 GHz</td><td>2.6060 GHz</td><td>430.0 kHz</td><td>2.605100000 GHz</td><td>-49.86 dBm</td><td>-39.86 dB</td></tr> <tr><td>7</td><td></td><td>2.6060 GHz</td><td>2.6100 GHz</td><td>1.000 MHz</td><td>2.606066667 GHz</td><td>-62.35 dBm</td><td>-52.35 dB</td></tr> </tbody> </table>		Spur	Range	Start Freq	Stop Freq	RBW	Frequency	Amplitude	ALimit	1		2.5450 GHz	2.5650 GHz	1.000 MHz	2.565600000 GHz	-53.18 dBm	-28.18 dB	2		2.5650 GHz	2.5800 GHz	1.000 MHz	2.579325000 GHz	-42.46 dBm	-29.46 dB	3		2.5800 GHz	2.5840 GHz	1.000 MHz	2.584000000 GHz	-45.72 dBm	-36.72 dB	4		2.5840 GHz	2.5850 GHz	430.0 kHz	2.585000000 GHz	-27.43 dBm	-17.43 dB	5		2.5850 GHz	2.5850 GHz	430.0 kHz	2.588100000 GHz	-18.28 dBm	-11.72 dB	6		2.6050 GHz	2.6060 GHz	430.0 kHz	2.605100000 GHz	-49.86 dBm	-39.86 dB	7		2.6060 GHz	2.6100 GHz	1.000 MHz	2.606066667 GHz	-62.35 dBm	-52.35 dB
Spur	Range	Start Freq	Stop Freq	RBW	Frequency	Amplitude	ALimit																																																																																																																												
1		2.5300 GHz	2.5500 GHz	1.000 MHz	2.569333333 GHz	-55.16 dBm	-27.16 dB																																																																																																																												
2		2.5300 GHz	2.5500 GHz	1.000 MHz	2.561900000 GHz	-45.23 dBm	-32.33 dB																																																																																																																												
3		2.5650 GHz	2.5650 GHz	1.000 MHz	2.569300000 GHz	-46.71 dBm	-36.71 dB																																																																																																																												
4		2.5650 GHz	2.5650 GHz	430.0 kHz	2.569916667 GHz	-26.17 dBm	-16.17 dB																																																																																																																												
5		2.5700 GHz	2.5700 GHz	430.0 kHz	2.571066667 GHz	-18.23 dBm	-11.72 dB																																																																																																																												
6		2.5900 GHz	2.5910 GHz	430.0 kHz	2.590768333 GHz	-43.01 dBm	-38.01 dB																																																																																																																												
7		2.5910 GHz	2.5920 GHz	1.000 MHz	2.591066667 GHz	-61.93 dBm	-51.93 dB																																																																																																																												
Spur	Range	Start Freq	Stop Freq	RBW	Frequency	Amplitude	ALimit																																																																																																																												
1		2.5450 GHz	2.5650 GHz	1.000 MHz	2.565600000 GHz	-53.18 dBm	-28.18 dB																																																																																																																												
2		2.5650 GHz	2.5800 GHz	1.000 MHz	2.579325000 GHz	-42.46 dBm	-29.46 dB																																																																																																																												
3		2.5800 GHz	2.5840 GHz	1.000 MHz	2.584000000 GHz	-45.72 dBm	-36.72 dB																																																																																																																												
4		2.5840 GHz	2.5850 GHz	430.0 kHz	2.585000000 GHz	-27.43 dBm	-17.43 dB																																																																																																																												
5		2.5850 GHz	2.5850 GHz	430.0 kHz	2.588100000 GHz	-18.28 dBm	-11.72 dB																																																																																																																												
6		2.6050 GHz	2.6060 GHz	430.0 kHz	2.605100000 GHz	-49.86 dBm	-39.86 dB																																																																																																																												
7		2.6060 GHz	2.6100 GHz	1.000 MHz	2.606066667 GHz	-62.35 dBm	-52.35 dB																																																																																																																												
Channel 516000 (2580.0MHz) $\pi/2$ BPSK 1 RB / 24 RB Offset		Channel 519000 (2595.0MHz) $\pi/2$ BPSK 1 RB / 24 RB Offset																																																																																																																																	
 <table border="1"> <thead> <tr> <th>Spur</th> <th>Range</th> <th>Start Freq</th> <th>Stop Freq</th> <th>RBW</th> <th>Frequency</th> <th>Amplitude</th> <th>ALimit</th> </tr> </thead> <tbody> <tr><td>1</td><td></td><td>2.5300 GHz</td><td>2.5500 GHz</td><td>1.000 MHz</td><td>2.533333333 GHz</td><td>-53.31 dBm</td><td>-28.31 dB</td></tr> <tr><td>2</td><td></td><td>2.5300 GHz</td><td>2.5500 GHz</td><td>1.000 MHz</td><td>2.563750000 GHz</td><td>-50.26 dBm</td><td>-37.26 dB</td></tr> <tr><td>3</td><td></td><td>2.5650 GHz</td><td>2.5650 GHz</td><td>1.000 MHz</td><td>2.564433333 GHz</td><td>-50.42 dBm</td><td>-38.42 dB</td></tr> <tr><td>4</td><td></td><td>2.5650 GHz</td><td>2.5650 GHz</td><td>430.0 kHz</td><td>2.569400000 GHz</td><td>-49.93 dBm</td><td>-38.93 dB</td></tr> <tr><td>5</td><td></td><td>2.5700 GHz</td><td>2.5700 GHz</td><td>430.0 kHz</td><td>2.583333333 GHz</td><td>-18.42 dBm</td><td>-11.88 dB</td></tr> <tr><td>6</td><td></td><td>2.5900 GHz</td><td>2.5910 GHz</td><td>430.0 kHz</td><td>2.590300000 GHz</td><td>-26.71 dBm</td><td>-16.71 dB</td></tr> <tr><td>7</td><td></td><td>2.5910 GHz</td><td>2.5920 GHz</td><td>1.000 MHz</td><td>2.591066667 GHz</td><td>-46.57 dBm</td><td>-36.57 dB</td></tr> </tbody> </table>		Spur	Range	Start Freq	Stop Freq	RBW	Frequency	Amplitude	ALimit	1		2.5300 GHz	2.5500 GHz	1.000 MHz	2.533333333 GHz	-53.31 dBm	-28.31 dB	2		2.5300 GHz	2.5500 GHz	1.000 MHz	2.563750000 GHz	-50.26 dBm	-37.26 dB	3		2.5650 GHz	2.5650 GHz	1.000 MHz	2.564433333 GHz	-50.42 dBm	-38.42 dB	4		2.5650 GHz	2.5650 GHz	430.0 kHz	2.569400000 GHz	-49.93 dBm	-38.93 dB	5		2.5700 GHz	2.5700 GHz	430.0 kHz	2.583333333 GHz	-18.42 dBm	-11.88 dB	6		2.5900 GHz	2.5910 GHz	430.0 kHz	2.590300000 GHz	-26.71 dBm	-16.71 dB	7		2.5910 GHz	2.5920 GHz	1.000 MHz	2.591066667 GHz	-46.57 dBm	-36.57 dB	 <table border="1"> <thead> <tr> <th>Spur</th> <th>Range</th> <th>Start Freq</th> <th>Stop Freq</th> <th>RBW</th> <th>Frequency</th> <th>Amplitude</th> <th>ALimit</th> </tr> </thead> <tbody> <tr><td>1</td><td></td><td>2.5450 GHz</td><td>2.5650 GHz</td><td>1.000 MHz</td><td>2.556966667 GHz</td><td>-53.32 dBm</td><td>-28.32 dB</td></tr> <tr><td>2</td><td></td><td>2.5650 GHz</td><td>2.5800 GHz</td><td>1.000 MHz</td><td>2.578350000 GHz</td><td>-51.21 dBm</td><td>-38.21 dB</td></tr> <tr><td>3</td><td></td><td>2.5800 GHz</td><td>2.5840 GHz</td><td>1.000 MHz</td><td>2.582780000 GHz</td><td>-51.83 dBm</td><td>-38.83 dB</td></tr> <tr><td>4</td><td></td><td>2.5840 GHz</td><td>2.5850 GHz</td><td>430.0 kHz</td><td>2.584300000 GHz</td><td>-49.88 dBm</td><td>-38.88 dB</td></tr> <tr><td>5</td><td></td><td>2.5850 GHz</td><td>2.5850 GHz</td><td>430.0 kHz</td><td>2.603900000 GHz</td><td>-18.18 dBm</td><td>-11.82 dB</td></tr> <tr><td>6</td><td></td><td>2.6050 GHz</td><td>2.6060 GHz</td><td>430.0 kHz</td><td>2.605633333 GHz</td><td>-29.36 dBm</td><td>-19.36 dB</td></tr> <tr><td>7</td><td></td><td>2.6060 GHz</td><td>2.6100 GHz</td><td>1.000 MHz</td><td>2.607333333 GHz</td><td>-47.20 dBm</td><td>-37.20 dB</td></tr> </tbody> </table>		Spur	Range	Start Freq	Stop Freq	RBW	Frequency	Amplitude	ALimit	1		2.5450 GHz	2.5650 GHz	1.000 MHz	2.556966667 GHz	-53.32 dBm	-28.32 dB	2		2.5650 GHz	2.5800 GHz	1.000 MHz	2.578350000 GHz	-51.21 dBm	-38.21 dB	3		2.5800 GHz	2.5840 GHz	1.000 MHz	2.582780000 GHz	-51.83 dBm	-38.83 dB	4		2.5840 GHz	2.5850 GHz	430.0 kHz	2.584300000 GHz	-49.88 dBm	-38.88 dB	5		2.5850 GHz	2.5850 GHz	430.0 kHz	2.603900000 GHz	-18.18 dBm	-11.82 dB	6		2.6050 GHz	2.6060 GHz	430.0 kHz	2.605633333 GHz	-29.36 dBm	-19.36 dB	7		2.6060 GHz	2.6100 GHz	1.000 MHz	2.607333333 GHz	-47.20 dBm	-37.20 dB
Spur	Range	Start Freq	Stop Freq	RBW	Frequency	Amplitude	ALimit																																																																																																																												
1		2.5300 GHz	2.5500 GHz	1.000 MHz	2.533333333 GHz	-53.31 dBm	-28.31 dB																																																																																																																												
2		2.5300 GHz	2.5500 GHz	1.000 MHz	2.563750000 GHz	-50.26 dBm	-37.26 dB																																																																																																																												
3		2.5650 GHz	2.5650 GHz	1.000 MHz	2.564433333 GHz	-50.42 dBm	-38.42 dB																																																																																																																												
4		2.5650 GHz	2.5650 GHz	430.0 kHz	2.569400000 GHz	-49.93 dBm	-38.93 dB																																																																																																																												
5		2.5700 GHz	2.5700 GHz	430.0 kHz	2.583333333 GHz	-18.42 dBm	-11.88 dB																																																																																																																												
6		2.5900 GHz	2.5910 GHz	430.0 kHz	2.590300000 GHz	-26.71 dBm	-16.71 dB																																																																																																																												
7		2.5910 GHz	2.5920 GHz	1.000 MHz	2.591066667 GHz	-46.57 dBm	-36.57 dB																																																																																																																												
Spur	Range	Start Freq	Stop Freq	RBW	Frequency	Amplitude	ALimit																																																																																																																												
1		2.5450 GHz	2.5650 GHz	1.000 MHz	2.556966667 GHz	-53.32 dBm	-28.32 dB																																																																																																																												
2		2.5650 GHz	2.5800 GHz	1.000 MHz	2.578350000 GHz	-51.21 dBm	-38.21 dB																																																																																																																												
3		2.5800 GHz	2.5840 GHz	1.000 MHz	2.582780000 GHz	-51.83 dBm	-38.83 dB																																																																																																																												
4		2.5840 GHz	2.5850 GHz	430.0 kHz	2.584300000 GHz	-49.88 dBm	-38.88 dB																																																																																																																												
5		2.5850 GHz	2.5850 GHz	430.0 kHz	2.603900000 GHz	-18.18 dBm	-11.82 dB																																																																																																																												
6		2.6050 GHz	2.6060 GHz	430.0 kHz	2.605633333 GHz	-29.36 dBm	-19.36 dB																																																																																																																												
7		2.6060 GHz	2.6100 GHz	1.000 MHz	2.607333333 GHz	-47.20 dBm	-37.20 dB																																																																																																																												
Channel 516000 (2580.0MHz) $\pi/2$ BPSK 51 RB / 0 RB Offset		Channel 519000 (2595.0MHz) $\pi/2$ BPSK 51 RB / 0 RB Offset																																																																																																																																	
 <table border="1"> <thead> <tr> <th>Spur</th> <th>Range</th> <th>Start Freq</th> <th>Stop Freq</th> <th>RBW</th> <th>Frequency</th> <th>Amplitude</th> <th>ALimit</th> </tr> </thead> <tbody> <tr><td>1</td><td></td><td>2.5300 GHz</td><td>2.5500 GHz</td><td>1.000 MHz</td><td>2.546100000 GHz</td><td>-44.04 dBm</td><td>-19.04 dB</td></tr> <tr><td>2</td><td></td><td>2.5300 GHz</td><td>2.5500 GHz</td><td>1.000 MHz</td><td>2.563700000 GHz</td><td>-35.10 dBm</td><td>-22.10 dB</td></tr> <tr><td>3</td><td></td><td>2.5650 GHz</td><td>2.5650 GHz</td><td>1.000 MHz</td><td>2.568746667 GHz</td><td>-35.88 dBm</td><td>-24.88 dB</td></tr> <tr><td>4</td><td></td><td>2.5650 GHz</td><td>2.5650 GHz</td><td>430.0 kHz</td><td>2.569966667 GHz</td><td>-35.62 dBm</td><td>-25.62 dB</td></tr> <tr><td>5</td><td></td><td>2.5700 GHz</td><td>2.5700 GHz</td><td>430.0 kHz</td><td>2.582566667 GHz</td><td>-23.72 dBm</td><td>-27.19 dB</td></tr> <tr><td>6</td><td></td><td>2.5900 GHz</td><td>2.5910 GHz</td><td>430.0 kHz</td><td>2.590066667 GHz</td><td>-38.01 dBm</td><td>-38.01 dB</td></tr> <tr><td>7</td><td></td><td>2.5910 GHz</td><td>2.5920 GHz</td><td>1.000 MHz</td><td>2.591333333 GHz</td><td>-38.33 dBm</td><td>-28.33 dB</td></tr> </tbody> </table>		Spur	Range	Start Freq	Stop Freq	RBW	Frequency	Amplitude	ALimit	1		2.5300 GHz	2.5500 GHz	1.000 MHz	2.546100000 GHz	-44.04 dBm	-19.04 dB	2		2.5300 GHz	2.5500 GHz	1.000 MHz	2.563700000 GHz	-35.10 dBm	-22.10 dB	3		2.5650 GHz	2.5650 GHz	1.000 MHz	2.568746667 GHz	-35.88 dBm	-24.88 dB	4		2.5650 GHz	2.5650 GHz	430.0 kHz	2.569966667 GHz	-35.62 dBm	-25.62 dB	5		2.5700 GHz	2.5700 GHz	430.0 kHz	2.582566667 GHz	-23.72 dBm	-27.19 dB	6		2.5900 GHz	2.5910 GHz	430.0 kHz	2.590066667 GHz	-38.01 dBm	-38.01 dB	7		2.5910 GHz	2.5920 GHz	1.000 MHz	2.591333333 GHz	-38.33 dBm	-28.33 dB	 <table border="1"> <thead> <tr> <th>Spur</th> <th>Range</th> <th>Start Freq</th> <th>Stop Freq</th> <th>RBW</th> <th>Frequency</th> <th>Amplitude</th> <th>ALimit</th> </tr> </thead> <tbody> <tr><td>1</td><td></td><td>2.5450 GHz</td><td>2.5650 GHz</td><td>1.000 MHz</td><td>2.562600000 GHz</td><td>-43.38 dBm</td><td>-18.38 dB</td></tr> <tr><td>2</td><td></td><td>2.5650 GHz</td><td>2.5800 GHz</td><td>1.000 MHz</td><td>2.570150000 GHz</td><td>-36.76 dBm</td><td>-22.76 dB</td></tr> <tr><td>3</td><td></td><td>2.5800 GHz</td><td>2.5840 GHz</td><td>1.000 MHz</td><td>2.583666667 GHz</td><td>-35.16 dBm</td><td>-25.16 dB</td></tr> <tr><td>4</td><td></td><td>2.5840 GHz</td><td>2.5850 GHz</td><td>430.0 kHz</td><td>2.584933333 GHz</td><td>-36.30 dBm</td><td>-26.30 dB</td></tr> <tr><td>5</td><td></td><td>2.5850 GHz</td><td>2.5850 GHz</td><td>430.0 kHz</td><td>2.589566667 GHz</td><td>-1.97 dBm</td><td>-20.02 dB</td></tr> <tr><td>6</td><td></td><td>2.6050 GHz</td><td>2.6060 GHz</td><td>430.0 kHz</td><td>2.605033333 GHz</td><td>-37.03 dBm</td><td>-27.03 dB</td></tr> <tr><td>7</td><td></td><td>2.6060 GHz</td><td>2.6100 GHz</td><td>1.000 MHz</td><td>2.606466667 GHz</td><td>-38.48 dBm</td><td>-28.48 dB</td></tr> </tbody> </table>		Spur	Range	Start Freq	Stop Freq	RBW	Frequency	Amplitude	ALimit	1		2.5450 GHz	2.5650 GHz	1.000 MHz	2.562600000 GHz	-43.38 dBm	-18.38 dB	2		2.5650 GHz	2.5800 GHz	1.000 MHz	2.570150000 GHz	-36.76 dBm	-22.76 dB	3		2.5800 GHz	2.5840 GHz	1.000 MHz	2.583666667 GHz	-35.16 dBm	-25.16 dB	4		2.5840 GHz	2.5850 GHz	430.0 kHz	2.584933333 GHz	-36.30 dBm	-26.30 dB	5		2.5850 GHz	2.5850 GHz	430.0 kHz	2.589566667 GHz	-1.97 dBm	-20.02 dB	6		2.6050 GHz	2.6060 GHz	430.0 kHz	2.605033333 GHz	-37.03 dBm	-27.03 dB	7		2.6060 GHz	2.6100 GHz	1.000 MHz	2.606466667 GHz	-38.48 dBm	-28.48 dB
Spur	Range	Start Freq	Stop Freq	RBW	Frequency	Amplitude	ALimit																																																																																																																												
1		2.5300 GHz	2.5500 GHz	1.000 MHz	2.546100000 GHz	-44.04 dBm	-19.04 dB																																																																																																																												
2		2.5300 GHz	2.5500 GHz	1.000 MHz	2.563700000 GHz	-35.10 dBm	-22.10 dB																																																																																																																												
3		2.5650 GHz	2.5650 GHz	1.000 MHz	2.568746667 GHz	-35.88 dBm	-24.88 dB																																																																																																																												
4		2.5650 GHz	2.5650 GHz	430.0 kHz	2.569966667 GHz	-35.62 dBm	-25.62 dB																																																																																																																												
5		2.5700 GHz	2.5700 GHz	430.0 kHz	2.582566667 GHz	-23.72 dBm	-27.19 dB																																																																																																																												
6		2.5900 GHz	2.5910 GHz	430.0 kHz	2.590066667 GHz	-38.01 dBm	-38.01 dB																																																																																																																												
7		2.5910 GHz	2.5920 GHz	1.000 MHz	2.591333333 GHz	-38.33 dBm	-28.33 dB																																																																																																																												
Spur	Range	Start Freq	Stop Freq	RBW	Frequency	Amplitude	ALimit																																																																																																																												
1		2.5450 GHz	2.5650 GHz	1.000 MHz	2.562600000 GHz	-43.38 dBm	-18.38 dB																																																																																																																												
2		2.5650 GHz	2.5800 GHz	1.000 MHz	2.570150000 GHz	-36.76 dBm	-22.76 dB																																																																																																																												
3		2.5800 GHz	2.5840 GHz	1.000 MHz	2.583666667 GHz	-35.16 dBm	-25.16 dB																																																																																																																												
4		2.5840 GHz	2.5850 GHz	430.0 kHz	2.584933333 GHz	-36.30 dBm	-26.30 dB																																																																																																																												
5		2.5850 GHz	2.5850 GHz	430.0 kHz	2.589566667 GHz	-1.97 dBm	-20.02 dB																																																																																																																												
6		2.6050 GHz	2.6060 GHz	430.0 kHz	2.605033333 GHz	-37.03 dBm	-27.03 dB																																																																																																																												
7		2.6060 GHz	2.6100 GHz	1.000 MHz	2.606466667 GHz	-38.48 dBm	-28.48 dB																																																																																																																												

Channel Bandwidth: 20MHz

Channel 522000 (2610.0MHz) $\pi/2$ BPSK 1 RB / 0 RB Offset

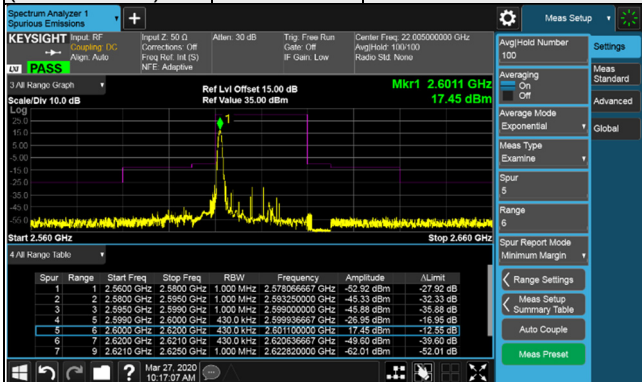

Channel 522000 (2610.0MHz) $\pi/2$ BPSK 1 RB / 24 RB Offset

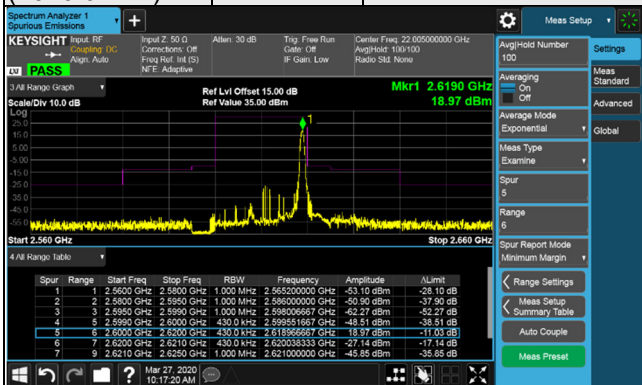

Channel 522000 (2610.0MHz) $\pi/2$ BPSK 51 RB / 0 RB Offset

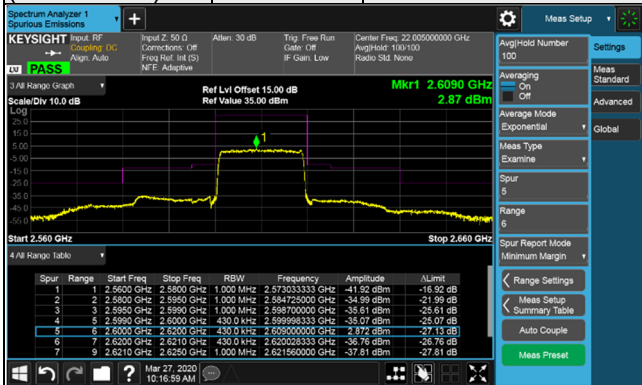

4.6 Peak to Average Ratio

4.6.1 Limits of Peak to Average Ratio Measurement

In measuring transmissions in this band using an average power technique, the peak to-average ratio (PAR) of the transmission may not exceed 13 dB

4.6.2 Test Setup

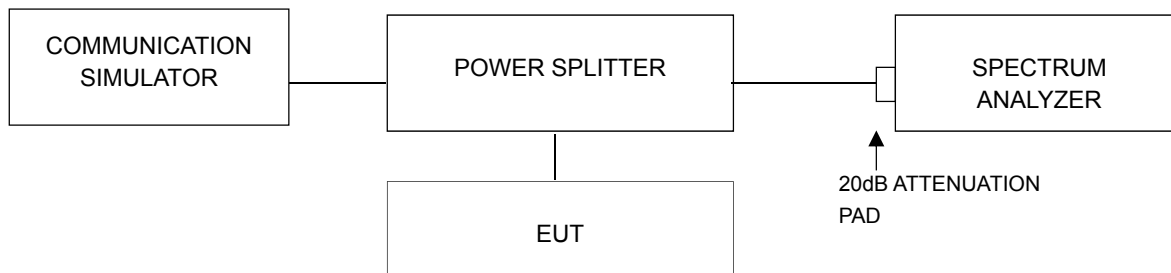

4.6.3 Test Procedures

- Set resolution/measurement bandwidth \geq signal's occupied bandwidth;
- Set the number of counts to a value that stabilizes the measured CCDF curve;
- Record the maximum PAPR level associated with a probability of 0.1%.

4.6.4 Test Results

n38

n38, Channel Bandwidth 20MHz						
Channel	Frequency (MHz)	26dB Bandwidth (MHz)				
		$\pi/2$ BPSK	QPSK	16QAM	64QAM	256QAM
516000	2580.0	4.57	4.08	6.42	6.22	6.42
519000	2595.0	4.63	4.30	6.68	5.67	6.13
522000	2610.0	4.71	4.17	6.17	6.06	6.75

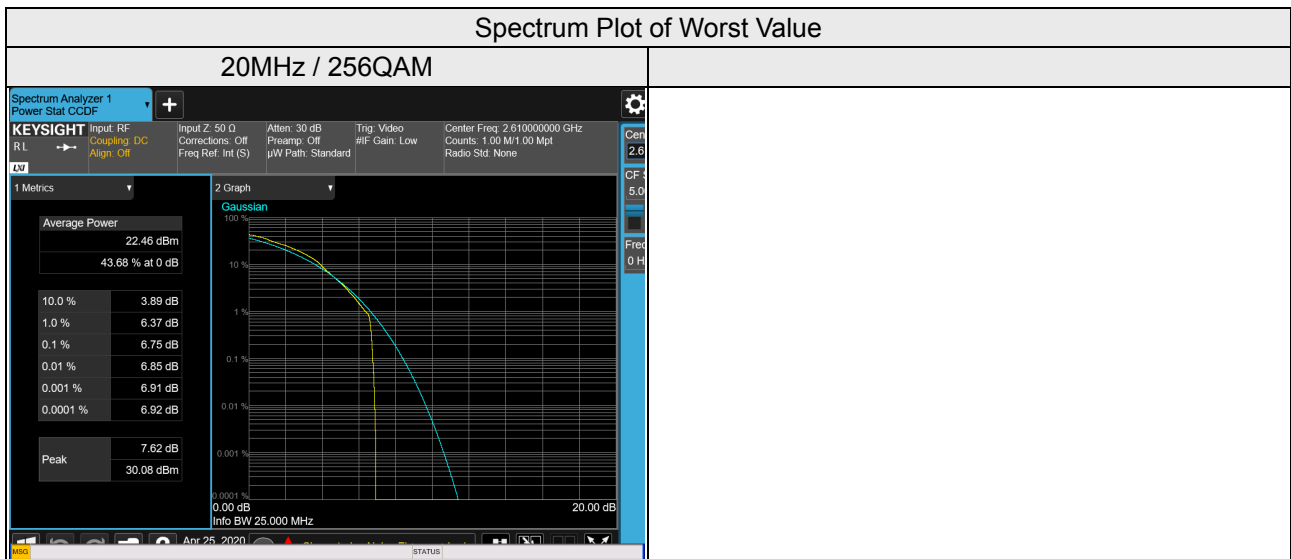

4.7 Conducted Spurious Emissions

4.7.1 Limits of Conducted Spurious Emissions Measurement

In the FCC 27.53(m)(4), On any frequency outside a licensee's frequency block, The power of any emission shall be attenuated below the transmitter power (P) by at least $55 + 10 \log (P)$ dB. The emission limit equal to -25dBm .

4.7.2 Test Setup

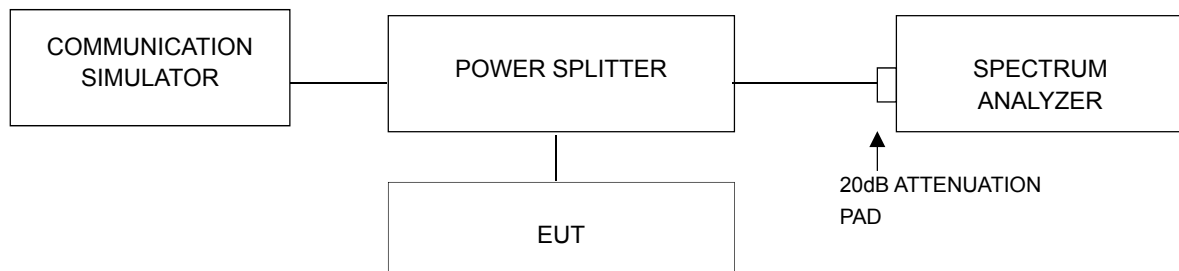

4.7.3 Test Procedure

- All measurements were done at 3 channels: low, middle and high operational frequency range.
- When the spectrum scanned from 9kHz to 27GHz, it shall be connected to the attenuator with the carried frequency.

4.7.4 Test Results

n38

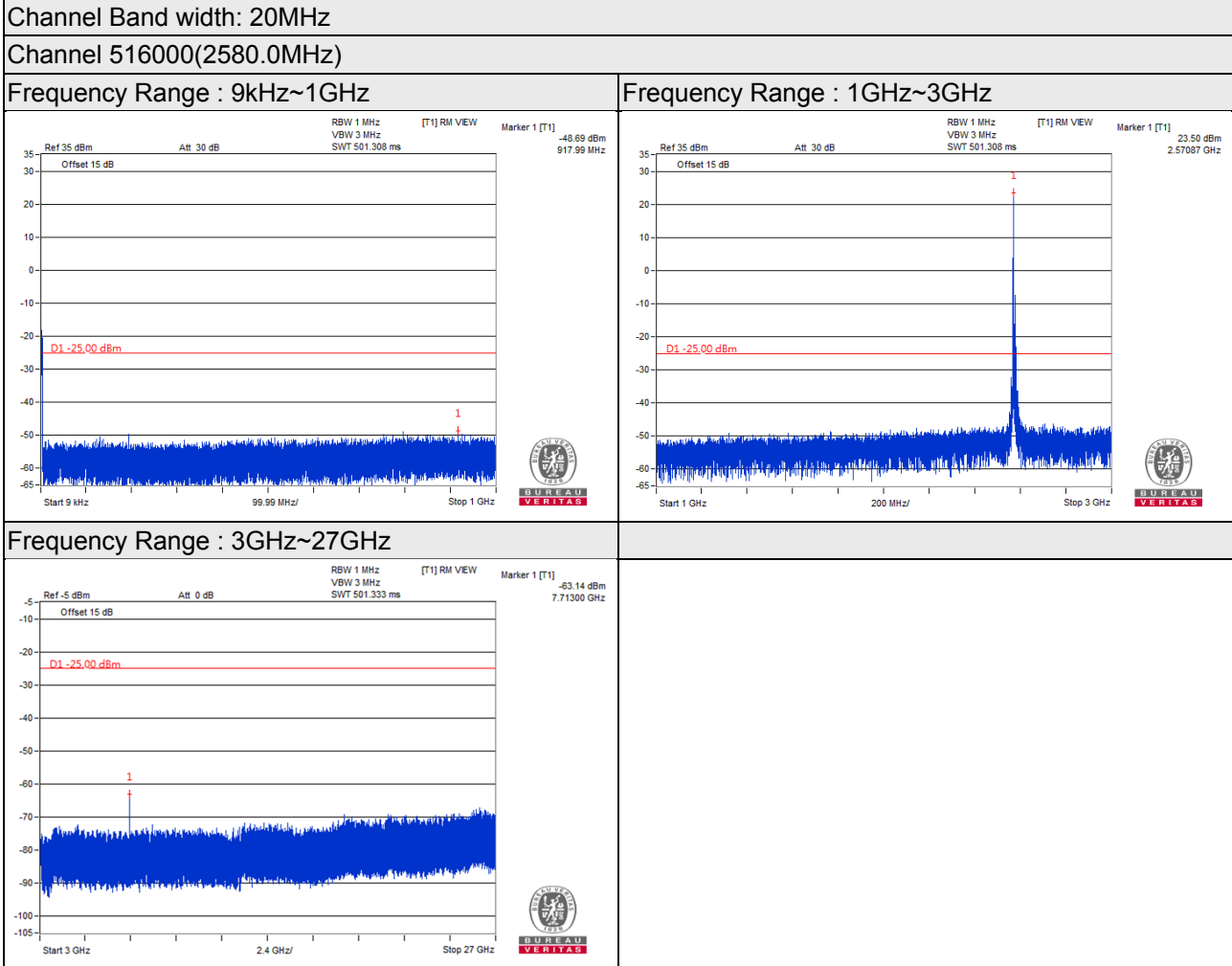

*The 9kHz signal over the limit is from Spectrum.

Channel Band width: 20MHz

Channel 519000(2595.0MHz)

Frequency Range : 9kHz~1GHz

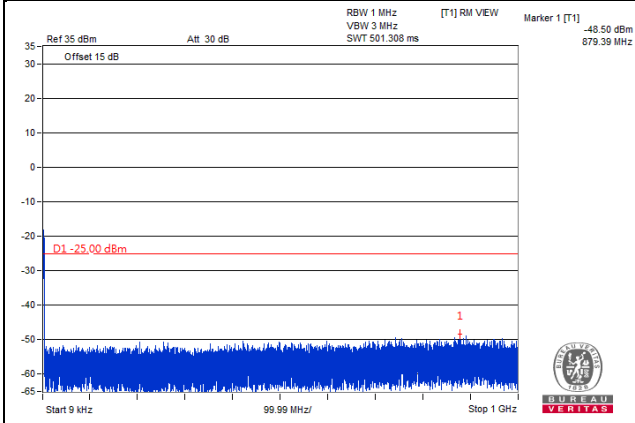

Frequency Range : 1GHz~3GHz

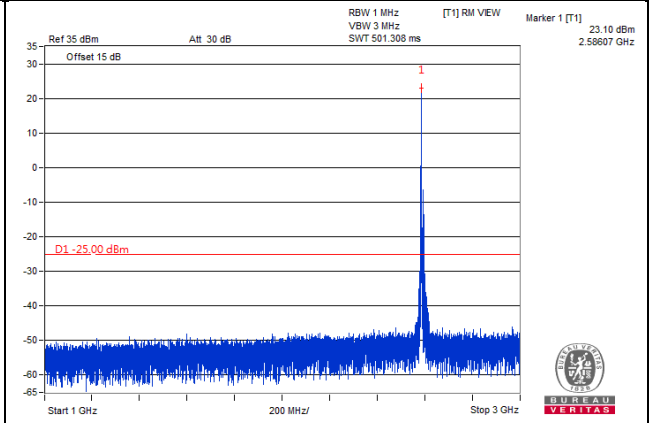

Frequency Range : 3GHz~27GHz

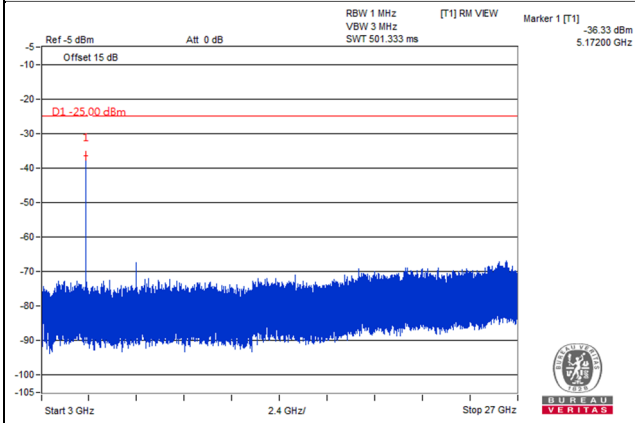

*The 9kHz signal over the limit is from Spectrum.

Channel Band width: 20MHz

Channel 522000(2610.0MHz)

Frequency Range : 9kHz~1GHz

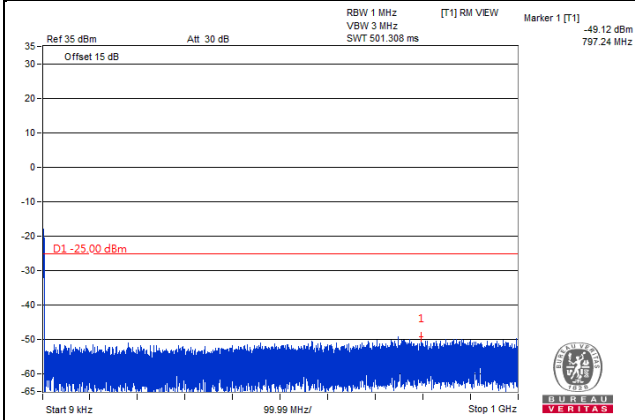

Frequency Range : 1GHz~3GHz

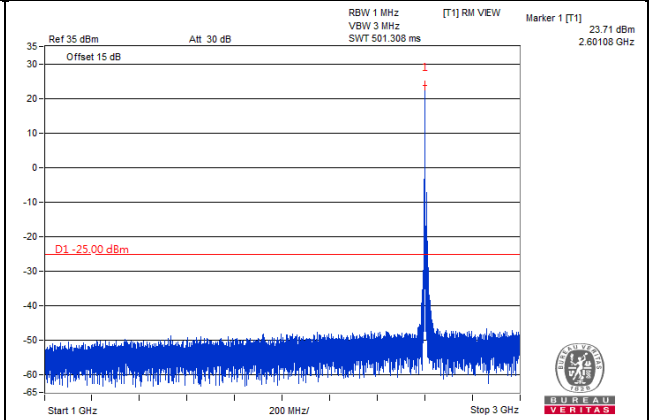

Frequency Range : 3GHz~27GHz

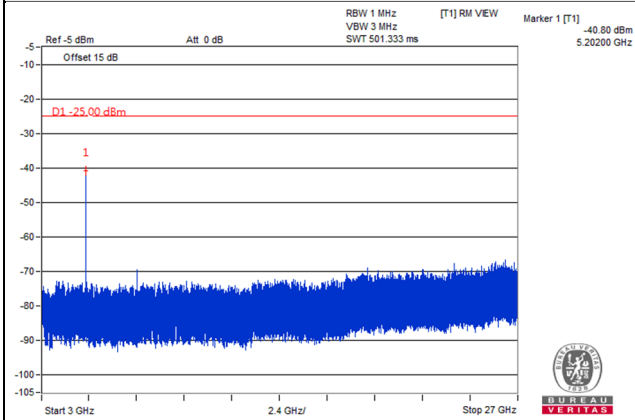

*The 9kHz signal over the limit is from Spectrum.

4.8 Radiated Emission Measurement

4.8.1 Limits of Radiated Emission Measurement

In the FCC 27.53(m)(4), On any frequency outside a licensee's frequency block, The power of any emission shall be attenuated below the transmitter power (P) by at least $55 + 10 \log (P)$ dB. The emission limit equal to -25dBm .

4.8.2 Test Procedure

- a. The power was measured with R&S Spectrum Analyzer. All measurements were done at 3 channels (low, middle and high channel of operational frequency range.)
- b. Substitution method is used for E.I.R.P measurement. In the semi-anechoic chamber, EUT placed on the 0.8m (below or equal 1 GHz) and/or 1.5 m (above 1 GHz) height of Turn Table, rotated the table around 360 degrees to search the maximum radiation power and receiver antenna shall be rotated vertical and horizontal polarization and moved height from 1m to 4m to find the maximum polar radiated power. The "Read Value" is the spectrum reading the maximum power value.
- c. The substitution antenna is substituted for EUT at the same position and signals generator export the CW signal to the substitution antenna via a TX cable. Rotated the Turn Table and moved receiving antenna to find the maximum radiation power. Adjust output power level of S.G to get a Value of spectrum reading equal to "Read Value" of step b. Record the power level of S.G
- d. $\text{EIRP} = \text{Output power level of S.G} - \text{TX cable loss} + \text{Antenna gain of substitution antenna}$.

Note: The resolution bandwidth and video bandwidth of test receiver/spectrum analyzer is 1MHz/3MHz.

4.8.3 Deviation from Test Standard

No deviation.

4.8.4 Test Setup

For radiated emission 30MHz to 1GHz

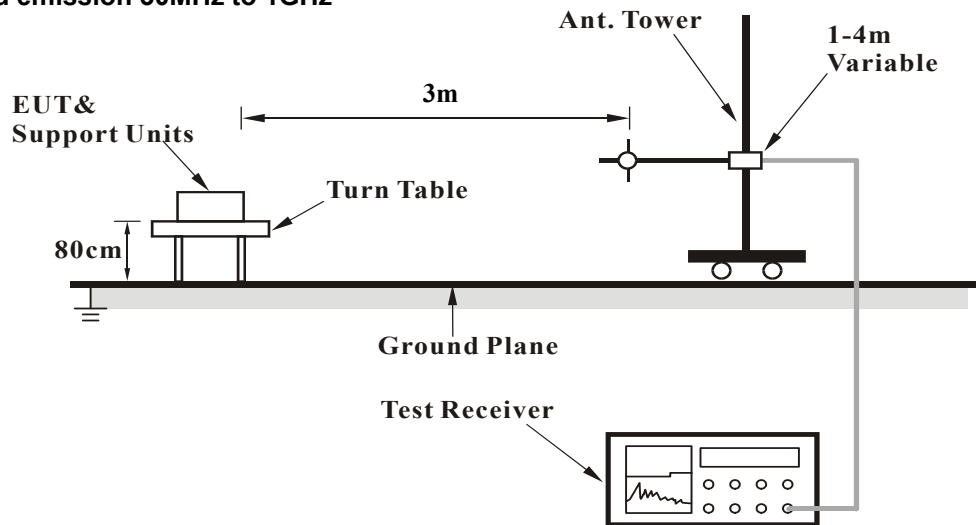

For radiated emission above 1GHz

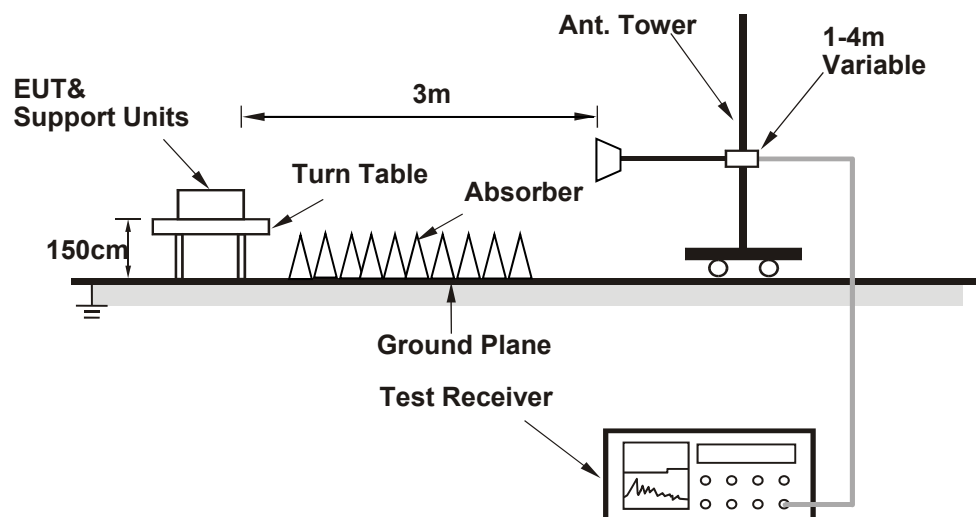

For the actual test configuration, please refer to the attached file (Test Setup Photo).

4.8.5 Test Results

Below 1GHz

n38, Channel Bandwidth: 20MHz

Mode	TX channel 519000 (2595.0MHz)	Frequency Range	Below 1000 MHz
Environmental Conditions	22deg. C, 68%RH	Input Power	120Vac, 60Hz
Tested By	Greg Lin		

Antenna Polarity & Test Distance: Horizontal at 3 M

No.	Freq. (MHz)	Reading (dBm)	S.G Power Value (dBm)	Correction Factor (dB)	EIRP (dBm)	Limit (dBm)	Margin (dB)
1	30.00	-46.5	-25.2	-19.4	-44.6	-25.0	-19.6
2	82.38	-45.8	-53.7	0.4	-53.3	-25.0	-28.3
3	256.98	-58.9	-64.7	-1.5	-66.2	-25.0	-41.2
4	409.27	-68.2	-73.9	3.2	-70.7	-25.0	-45.7
5	743.92	-70.5	-72.4	3.7	-68.7	-25.0	-43.7
6	922.40	-71.0	-68.7	3.6	-65.1	-25.0	-40.1

Remarks:

- ERP (dBm) = S.G Value (dBm) + Correction Factor (dB).
- Correction Factor (dB) = Substitution Antenna Gain (dB) - Cable Loss (dB) + 2.15dB.

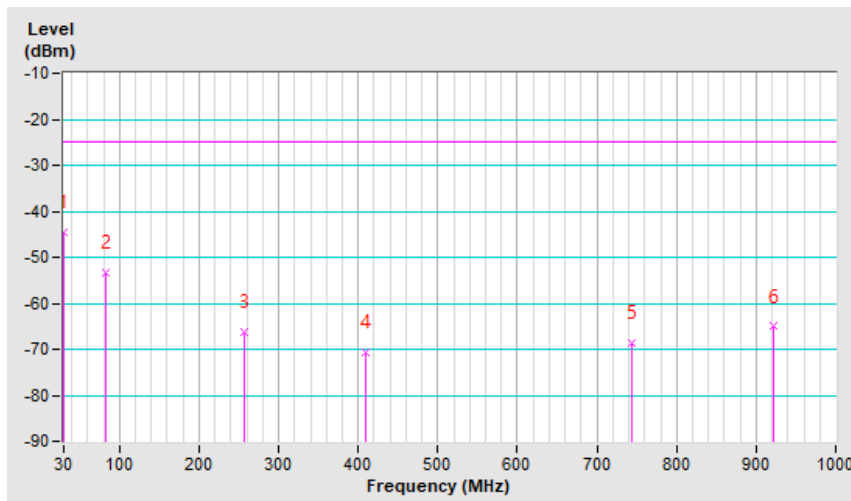

Mode	TX channel 519000 (2595.0MHz)	Frequency Range	Below 1000 MHz
Environmental Conditions	22deg. C, 68%RH	Input Power	120Vac, 60Hz
Tested By	Greg Lin		

Antenna Polarity & Test Distance: Vertical at 3 M							
No.	Freq. (MHz)	Reading (dBm)	S.G Power Value (dBm)	Correction Factor (dB)	EIRP (dBm)	Limit (dBm)	Margin (dB)
1	44.55	-44.5	-44.1	-10.9	-55.0	-25.0	-30.0
2	96.93	-43.0	-51.9	-1.2	-53.1	-25.0	-28.1
3	264.74	-59.4	-58.9	-1.6	-60.5	-25.0	-35.5
4	389.87	-64.0	-70.1	3.4	-66.7	-25.0	-41.7
5	652.74	-69.9	-70.0	3.6	-66.4	-25.0	-41.4
6	996.12	-71.2	-66.6	3.3	-63.3	-25.0	-38.3

Remarks:

1. ERP (dBm) = S.G Value (dBm) + Correction Factor (dB).
2. Correction Factor (dB) = Substitution Antenna Gain (dB) - Cable Loss (dB) + 2.15dB.

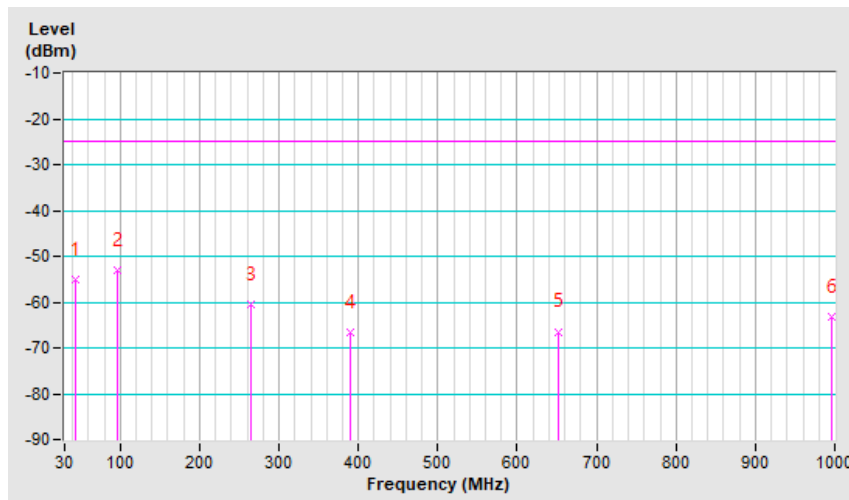

Above 1GHz

n38, Channel Bandwidth: 20MHz

Mode	TX channel 516000 (2580.0MHz)	Frequency Range	1GHz ~ 27GHz
Environmental Conditions	22deg. C, 68%RH	Input Power	120Vac, 60Hz
Tested By	Greg Lin		

Antenna Polarity & Test Distance: Horizontal at 3 M

No.	Freq. (MHz)	Reading (dBm)	S.G Power Value (dBm)	Correction Factor (dB)	EIRP (dBm)	Limit (dBm)	Margin (dB)
1	5160.00	-61.8	-49.8	1.4	-48.4	-25.0	-23.4

Antenna Polarity & Test Distance: Vertical at 3 M

No.	Freq. (MHz)	Reading (dBm)	S.G Power Value (dBm)	Correction Factor (dB)	EIRP (dBm)	Limit (dBm)	Margin (dB)
1	5160.00	-59.1	-47.1	1.4	-45.7	-25.0	-20.7

Remarks:

1. EIRP (dBm) = S.G Value (dBm) + Correction Factor (dB).
2. Correction Factor (dB) = Substitution Antenna Gain (dB) - Cable Loss (dB).

Mode	TX channel 519000 (2595.0MHz)	Frequency Range	1GHz ~ 27GHz
Environmental Conditions	22deg. C, 68%RH	Input Power	120Vac, 60Hz
Tested By	Greg Lin		

Antenna Polarity & Test Distance: Horizontal at 3 M

No.	Freq. (MHz)	Reading (dBm)	S.G Power Value (dBm)	Correction Factor (dB)	EIRP (dBm)	Limit (dBm)	Margin (dB)
1	5190.00	-61.6	-49.9	1.4	-48.5	-25.0	-23.5

Antenna Polarity & Test Distance: Vertical at 3 M

No.	Freq. (MHz)	Reading (dBm)	S.G Power Value (dBm)	Correction Factor (dB)	EIRP (dBm)	Limit (dBm)	Margin (dB)
1	5190.00	-59.4	-47.2	1.4	-45.8	-25.0	-20.8

Remarks:

1. EIRP (dBm) = S.G Value (dBm) + Correction Factor (dB).
2. Correction Factor (dB) = Substitution Antenna Gain (dB) - Cable Loss (dB).

Mode	TX channel 522000 (2610.0MHz)	Frequency Range	1GHz ~ 27GHz
Environmental Conditions	22deg. C, 68%RH	Input Power	120Vac, 60Hz
Tested By	Greg Lin		

Antenna Polarity & Test Distance: Horizontal at 3 M							
No.	Freq. (MHz)	Reading (dBm)	S.G Power Value (dBm)	Correction Factor (dB)	EIRP (dBm)	Limit (dBm)	Margin (dB)
1	5220.00	-62.0	-50.3	1.4	-48.9	-25.0	-23.9
Antenna Polarity & Test Distance: Vertical at 3 M							
No.	Freq. (MHz)	Reading (dBm)	S.G Power Value (dBm)	Correction Factor (dB)	EIRP (dBm)	Limit (dBm)	Margin (dB)
1	5220.00	-59.2	-47.1	1.4	-45.7	-25.0	-20.7

Remarks:

1. EIRP (dBm) = S.G Value (dBm) + Correction Factor (dB).
2. Correction Factor (dB) = Substitution Antenna Gain (dB) - Cable Loss (dB).

5 Pictures of Test Arrangements

Please refer to the attached file (Test Setup Photo).

Appendix – Information of the Testing Laboratories

We, Bureau Veritas Consumer Products Services (H.K.) Ltd., Taoyuan Branch, were founded in 1988 to provide our best service in EMC, Radio, Telecom and Safety consultation. Our laboratories are FCC recognized accredited test firms and accredited and approved according to ISO/IEC 17025.

If you have any comments, please feel free to contact us at the following:

Lin Kou EMC/RF Lab

Tel: 886-2-26052180

Fax: 886-2-26051924

Hsin Chu EMC/RF/Telecom Lab

Tel: 886-3-6668565

Fax: 886-3-6668323

Hwa Ya EMC/RF/Safety Lab

Tel: 886-3-3183232

Fax: 886-3-3270892

Email: service.adt@tw.bureauveritas.com

Web Site: www.bureauveritas-adt.com

The address and road map of all our labs can be found in our web site also.

--- END ---