

FCC Test Report (5GNR n78)

Report No.: RFBHQC-WTW-P21100439

FCC ID: 2AQ68RPQN7801

Test Model: RPQN-7801E, RPQN-7801I

Received Date: Sep. 11, 2021

Test Date: Sep. 11 ~ Sep. 16, 2021

Dec. 06, 2021

Issued Date: Dec. 06, 2021

Applicant: Hon Lin Technology Co., Ltd.

Address: 11F, No. 32, Jihu Rd., Neihu Dist., Taipei City 114, Taiwan R.O.C.

Issued By: Bureau Veritas Consumer Products Services (H.K.) Ltd., Taoyuan Branch
Lin Kou Laboratories

Lab Address: No. 47-2, 14th Ling, Chia Pau Vil., Lin Kou Dist., New Taipei City, Taiwan

Test Location: No. 19, Hwa Ya 2nd Rd., Wen Hwa Vil., Kwei Shan Dist., Taoyuan City
33383, Taiwan

**FCC Registration /
Designation Number:** 788550 / TW0003



This report is for your exclusive use. Any copying or replication of this report to or for any other person or entity, or use of our name or trademark, is permitted only with our prior written permission. This report sets forth our findings solely with respect to the test samples identified herein. The results set forth in this report are not indicative or representative of the quality or characteristics of the lot from which a test sample was taken or any similar or identical product unless specifically and expressly noted. Our report includes all of the tests requested by you and the results thereof based upon the information that you provided to us. You have 60 days from date of issuance of this report to notify us of any material error or omission caused by our negligence, provided, however, that such notice shall be in writing and shall specifically address the issue you wish to raise. A failure to raise such issue within the prescribed time shall constitute your unqualified acceptance of the completeness of this report, the tests conducted and the correctness of the report contents. Unless specific mention, the uncertainty of measurement has been explicitly taken into account to declare the compliance or non-compliance to the specification.

Table of Contents

Release Control Record	4
1 Certificate of Conformity	5
2 Summary of Test Results	6
2.1 Measurement Uncertainty.....	6
2.2 Test Site and Instruments.....	7
3 General Information	8
3.1 General Description of EUT.....	8
3.2 Configuration of System under Test.....	9
3.2.1 Description of Support Units.....	9
3.3 Test Mode Applicability and Tested Channel Detail.....	10
3.4 EUT Operating Conditions.....	11
3.5 General Description of Applied Standards and References.....	11
4 Test Types and Results	12
4.1 Output Power Measurement.....	12
4.1.1 Limits of Output Power Measurement.....	12
4.1.2 Test Procedures.....	12
4.1.3 Test Setup.....	12
4.1.4 Test Results.....	13
4.2 Modulation Characteristics Measurement.....	14
4.2.1 Limits of Modulation Characteristics.....	14
4.2.2 Test Procedure.....	14
4.2.3 Test Setup.....	14
4.2.4 Test Results.....	14
4.3 Frequency Stability Measurement.....	15
4.3.1 Limits of Frequency Stability Measurement.....	15
4.3.2 Test Procedure.....	15
4.3.3 Test Instruments.....	15
4.3.4 Test Setup.....	15
4.3.5 Test Results.....	16
4.4 Emission Bandwidth Measurement.....	18
4.4.1 Test Procedure.....	18
4.4.2 Test Procedure.....	18
4.4.3 Test Setup.....	18
4.4.4 Test Result.....	19
4.5 Channel Edge / Out-of-Band Emission Measurement.....	20
4.5.1 Limits of Channel Edge / Out-of-Band Emission Measurement.....	20
4.5.2 Test Setup.....	20
4.5.3 Test Procedures.....	20
4.5.4 Test Results.....	21
4.6 Peak to Average Ratio.....	23
4.6.1 Limits of Peak to Average Ratio Measurement.....	23
4.6.2 Test Setup.....	23
4.6.3 Test Procedures.....	23
4.6.4 Test Results.....	24
4.7 Conducted Spurious Emissions.....	25
4.7.1 Limits of Conducted Spurious Emissions Measurement.....	25
4.7.2 Test Setup.....	25
4.7.3 Test Procedure.....	25
4.7.4 Test Results.....	26
4.8 Radiated Emission Measurement.....	30
4.8.1 Limits of Radiated Emission Measurement.....	30
4.8.2 Test Procedure.....	30
4.8.3 Deviation from Test Standard.....	30

4.8.4 Test Setup.....	31
4.8.5 Test Results	32
5 Pictures of Test Arrangements.....	38
Appendix – Information of the Testing Laboratories	39

Release Control Record

Issue No.	Description	Date Issued
RFBHQC-WTW-P21100439	Original release	Dec. 06, 2021

1 Certificate of Conformity

Product: 5G NR indoor O-RU S4 RPQN-7801

Brand: Foxconn

Test Model: RPQN-7801E, RPQN-7801I

Sample Status: Mass Production

Applicant: Hon Lin Technology Co., Ltd.

Test Date: Sep. 11 ~ Sep. 16, 2021
Dec. 06, 2021

Standards: FCC Part 27, Subpart C, O

The above equipment has been tested by **Bureau Veritas Consumer Products Services (H.K.) Ltd., Taoyuan Branch**, and found compliance with the requirement of the above standards. The test record, data evaluation & Equipment Under Test (EUT) configurations represented herein are true and accurate accounts of the measurements of the sample's RF characteristics under the conditions specified in this report.

Prepared by : Pettie Chen, **Date:** Dec. 06, 2021
Pettie Chen / Senior Specialist

Approved by : Jeremy Lin, **Date:** Dec. 06, 2021
Jeremy Lin / Senior Engineer

2 Summary of Test Results

For 5GNR n78:

Applied Standard: FCC Part 27 & Part 2			
FCC Clause	Test Item	Result	Remarks
2.1046 27.50 (j)	Equivalent Radiated Power	Pass	Meet the requirement of limit.
2.1047	Modulation Characteristics	Pass	Meet the requirement
2.1055 27.54	Frequency Stability Stay with the authorized bands of operation	Pass	Meet the requirement of limit.
2.1049	Occupied Bandwidth	Pass	Meet the requirement of limit.
2.1051 27.53(l)	Band Edge / Out of Band Emissions Measurements	Pass	Meet the requirement of limit.
----	Peak To Average Ratio	Pass	Meet the requirement of limit.
2.1051 27.53(l)	Conducted Spurious Emissions	Pass	Meet the requirement of limit.
2.1053 27.53(l)	Radiated Spurious Emissions	Pass	Meet the requirement of limit. Minimum passing margin is -15.82dB at 30.97MHz.

Note: Determining compliance based on the results of the compliance measurement, not taking into account measurement instrumentation uncertainty.

2.1 Measurement Uncertainty

Where relevant, the following measurement uncertainty levels have been estimated for tests performed on the EUT as specified in CISPR 16-4-2:

Measurement	Frequency	Expanded Uncertainty (k=2) (\pm)
Radiated Emissions up to 1 GHz	9kHz ~ 30MHz	3.04 dB
	30MHz ~ 200MHz	3.59 dB
	200MHz ~ 1000MHz	3.60 dB
Radiated Emissions above 1 GHz	1GHz ~ 18GHz	2.29 dB
	18GHz ~ 40GHz	2.29 dB

2.2 Test Site and Instruments

Test Date: Sep. 11 ~ Sep. 16, 2021

Description & Manufacturer	Model No.	Serial No.	Cal. Date	Cal. Due
Test Receiver KEYSIGHT	N9038A	MY55420137	Apr. 09, 2021	Apr. 08, 2022
Spectrum Analyzer ROHDE & SCHWARZ	FSP40	100039	Jun. 10, 2021	Jun. 09, 2022
BILOG Antenna SCHWARZBECK	VULB9168	9168-160	Nov. 06, 2020	Nov. 05, 2021
HORN Antenna SCHWARZBECK	BBHA 9120 D	9120D-1169	Nov. 22, 2020	Nov. 21, 2021
HORN Antenna SCHWARZBECK	BBHA 9170	BBHA9170241	Nov. 22, 2020	Nov. 21, 2021
Preamplifier Agilent (Below 1GHz)	8447D	2944A10638	Jun. 05, 2021	Jun. 04, 2022
Preamplifier Agilent (Above 1GHz)	8449B	3008A02367	Feb. 17, 2021	Feb. 16, 2022
RF signal cable HUBER+SUHNER&EMCI	SUCOFLEX 104 & EMC104-SM-SM8000	CABLE-CH9-02 (248780+171006)	Jan. 16, 2021	Jan. 15, 2022
RF signal cable HUBER+SUHNER	SUCOFLEX 104	CABLE-CH9- (250795/4)	Jan. 16, 2021	Jan. 15, 2022
RF signal cable Woken	8D-FB	Cable-CH9-01	Jun. 05, 2021	Jun. 04, 2022
Software BV ADT	ADT_Radiated_ V7.6.15.9.5	NA	NA	NA
Antenna Tower & Turn BV ADT	AT100	AT93021705	NA	NA
Turn Table BV ADT	TT100	TT93021705	NA	NA
Turn Table Controller BV ADT	SC100	SC93021705	NA	NA
Boresight Antenna Fixture	FBA-01	FBA-SIP01	NA	NA
WIT Standard Temperature And Humidity Chamber	TH-4S-C	W981030	Jun. 01, 2021	May 31, 2022
JFW 20dB attenuation	50HF-020-SMA	NA	NA	NA
PXA Signal Analyzer KEYSIGHT	N9030B	MY57140938	Mar. 09, 2021	Mar. 08, 2022

- Note: 1. The calibration interval of the above test instruments is 12 months and the calibrations are traceable to NML/ROC and NIST/USA.
 2. The test was performed in HwaYa Chamber 9.

Test Date: Dec. 06, 2021

Description & Manufacturer	Model No.	Serial No.	Cal. Date	Cal. Due
PXA Signal Analyzer KEYSIGHT	N9030B	MY57140938	Mar. 09, 2021	Mar. 08, 2022

- Note: 1. The calibration interval of the above test instruments is 12 months and the calibrations are traceable to NML/ROC and NIST/USA.
 2. The test was performed in HwaYa Chamber 9.

3 General Information

3.1 General Description of EUT

Product	5G NR indoor O-RU S4 RPQN-7801				
Brand	Foxconn				
Test Model	RPQN-7801E, RPQN-7801I				
Sample Status	Mass Production				
Power Supply Rating	12 Vdc (Adapter)				
Modulation Type	QPSK, 16QAM, 64QAM, 256QAM				
Operating Band	n78 (3700-3800MHz)				
Operating Frequency	n78 (Channel Bandwidth 100MHz)	3750.00MHz			
Max. EIRP Power	n78 (Channel Bandwidth 100MHz)	QPSK	16QAM	64QAM	256QAM
		15100.80154 mW (41.79 dBm/MHz)	14621.77174 mW (41.65 dBm/MHz)	15066.07066 mW (41.78 dBm/MHz)	15031.41966 mW (41.77 dBm/MHz)
Emission Designator	n78 (Channel Bandwidth 100MHz)	QPSK	16QAM	64QAM	256QAM
		94M3G7D	93M9D7W	94M3D7W	94M3D7W
Antenna Type	Refer to Note as below				
Antenna Connector	Refer to Note as below				
Accessory Device	Refer to Note as below				
Cable Supplied	Refer to Note as below				

Note:

1. All models are listed as below.

Brand	Model	Difference
Foxconn	RPQN-7801E	With external antenna
	RPQN-7801I	With internal antenna

2. The EUT uses following adapter.

Brand	Model	Specification
DVE	DSA-60PFE-12 1 120500	AC Input: 100-240Vac, 50/60Hz, 2.0A DC Output: 12Vdc/5A DC Output Cable: 1.2 m with 1 core

3. The following antennas were provided to the EUT.

Antenna No.	Brand	Model	Antenna Net Gain(dBi)	Antenna Type	Connector Type
1. External	Whayu	C107-511850-A	5.15	Dipole	SMA
2. Internal	Grand Tek	103EG00000030	5.3	PIFA	i-peX(MHF)

3.2 Configuration of System under Test

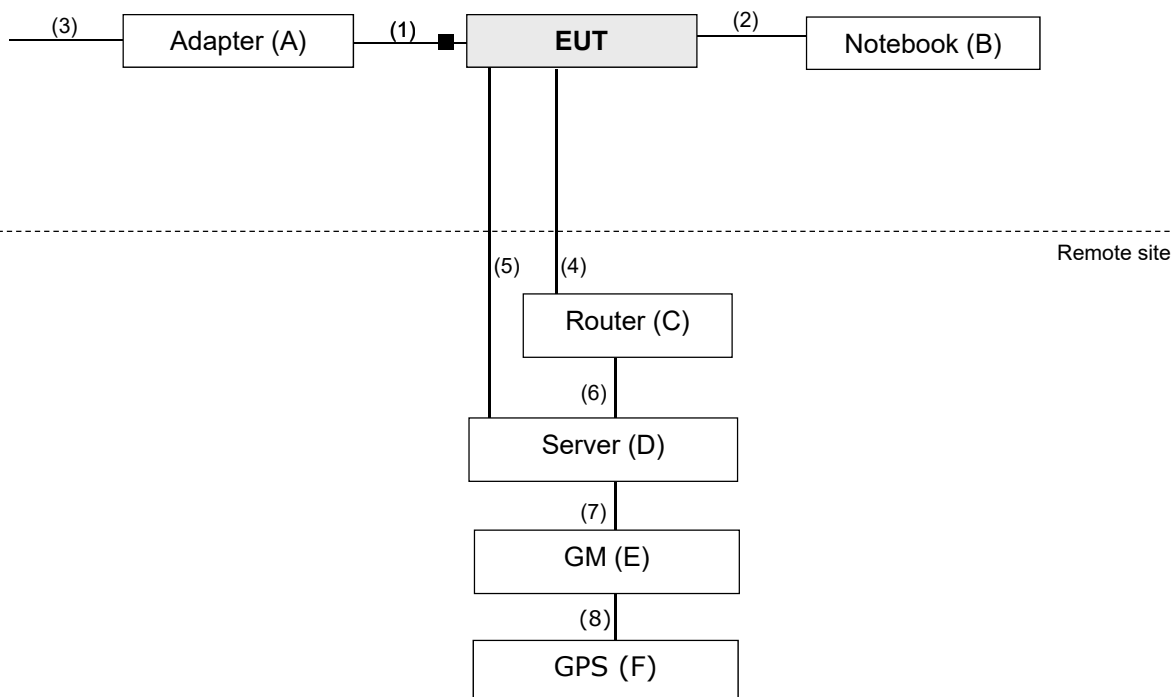

3.2.1 Description of Support Units

The EUT has been tested as an independent unit together with other necessary accessories or support units. The following support units or accessories were used to form a representative test configuration during the tests.

ID	Product	Brand	Model No.	Serial No.	FCC ID	Remarks
A.	Adapter	LITEON	PA-1050-39	NA	NA	Accessory
B.	Notebook	HP	11-u018TU	8CG70505V9	FCC DoC Approved	Provided by client.
C.	Wireless Broadband Router	Netgear	R7000P	4TJ1737FA0811	NA	-
D.	Server	NA	NA	NA	NA	Provided by client.
E.	GM	NA	NA	NA	NA	Provided by client.
F.	GPS	NA	NA	NA	NA	Provided by client.

Note:

1. All power cords of the above support units are non-shielded (1.8m).
2. Item C~E acted as a communication partner to transfer data.

ID	Descriptions	Qty.	Length (m)	Shielding (Yes/No)	Cores (Qty.)	Remarks
1.	DC cable	1	1.2	N	1	Accessory
2.	USB cable	1	1.0	Y	0	-
3.	AC cable	1	1.8	N	0	Provided by client.
4.	RJ45 Cable	1	10	N	0	Provided by client.
5.	Fiber cable	1	30	N	0	Provided by client.
6.	RJ45 Cable	1	1.0	N	0	-
7.	RJ45 Cable	1	1.0	N	0	-
8.	BNC cable	1	15	N	0	Provided by client.

3.3 Test Mode Applicability and Tested Channel Detail

Pre-Scan has been conducted to determine the worst-case mode from all possible combinations between available modulations, data rates, XYZ axis and antenna ports. The worst case was found when positioned as the table below. Following channel(s) was (were) selected for the final test as listed below:

Band	Radiated Emission
5G NR n78	X-plane

For radiated emission test, the EUT has been tested under following test modes. For other tests, test mode A was with the maximum gain for final tests.

Test Mode	EUT Model
A	RPQN-7801I
B	RPQN-7801E

5G NR n78

EUT Configure Mode	Test item	Available channel	Tested channel	Channel Bandwidth	Modulation	Mode
A	EIRP	650000	650000 (3750.00MHz)	100MHz	QPSK / 16QAM / 64QAM / 256QAM	Full RB
A	Modulation Characteristics	650000	650000 (3750.00MHz)	100MHz	QPSK / 16QAM / 64QAM / 256QAM	Full RB
A	Frequency Stability	650000	650000 (3750.00MHz)	100MHz	QPSK	Full RB
A	Emission Bandwidth	650000	650000 (3750.00MHz)	100MHz	QPSK / 16QAM / 64QAM / 256QAM	Full RB
A	Band Edge	650000	650000 (3750.00MHz)	100MHz	QPSK	Full RB
A	Peak to Average Ratio	650000	650000 (3750.00MHz)	100MHz	QPSK / 16QAM / 64QAM / 256QAM	Full RB
A	Conducted Emission	650000	650000 (3750.00MHz)	100MHz	QPSK	Full RB
A, B	Radiated Emission Below 1GHz	650000	650000 (3750.00MHz)	100MHz	QPSK	Full RB
A, B	Radiated Emission Above 1GHz	650000	650000 (3750.00MHz)	100MHz	QPSK	Full RB

Note: Only output power, modulation characteristics, occupied bandwidth and Peak to average ratio items had been tested under QPSK, 16QAM, 64QAM and 256QAM modes, the other test items were performed under worst mode according to the maximum output power.

Test Condition:

Test Item	Environmental Conditions	Input Power (system)	Tested By
EIRP	25deg. C, 60%RH	120Vac, 60Hz	James Yang
Modulation characteristics	25deg. C, 60%RH	120Vac, 60Hz	James Yang
Frequency Stability	25deg. C, 60%RH	120Vac, 60Hz	James Yang
Occupied Bandwidth	25deg. C, 60%RH	120Vac, 60Hz	James Yang
Band Edge	25deg. C, 60%RH	120Vac, 60Hz	James Yang
Peak To Average Ratio	25deg. C, 60%RH	120Vac, 60Hz	James Yang
Conducted Emission	25deg. C, 60%RH	120Vac, 60Hz	James Yang
Radiated Emission	21deg. C, 66%RH	120Vac, 60Hz	Rex Wang

3.4 EUT Operating Conditions

The EUT makes a call to the communication simulator. The communication simulator station system controlled a EUT to export maximum output power under transmission mode and specific channel frequency

3.5 General Description of Applied Standards and References

The EUT is a RF Product. According to the specifications of the manufacturer, it must comply with the requirements of the following standards and References:

Test Standard:

FCC 47 CFR Part 2

FCC 47 CFR Part 27

ANSI/TIA/EIA-603-E 2016

ANSI 63.26-2015

All test items have been performed and recorded as per the above standards.

References Test Guidance:

KDB 971168 D01 Power Meas License Digital Systems v03r01

KDB 971168 D02 Misc Rev Approv License Devices v02r01

All test items have been performed as a reference to the above KDB test guidance.

4 Test Types and Results

4.1 Output Power Measurement

4.1.1 Limits of Output Power Measurement

The power of each fixed or base station transmitting in the 3700-3980 MHz band and situated in any geographic location other than that described in paragraph (j)(1) of this section is limited to an EIRP of 1640 Watts/MHz. This limit applies to the aggregate power of all antenna elements in any given sector of a base station.

4.1.2 Test Procedures

Conducted Power Measurement:

The EUT was set up for the maximum power with 5GNR link data modulation and link up with Spectrum Analyzer. Set the EUT to transmit under low, middle and high channel and record the power level shown on Spectrum Analyzer.

Maximum EIRP / ERP

The relevant equation for determining the maximum ERP or EIRP from the measured RF output power is

given in Equation as follows:

$$\text{EIRP} = P_{\text{Meas}} + G_{\text{T}}$$

$$\text{ERP} = P_{\text{Meas}} + G_{\text{T}} - 2.15$$

where

ERP or EIRP effective radiated power or equivalent isotropically radiated power, respectively
(expressed in the same units as P_{Meas} , e.g., dBm or dBW)

P_{Meas} measured transmitter output power or PSD, in dBm or dBW

G_{T} gain of the transmitting antenna, in dBd (ERP) or dBi (EIRP)

4.1.3 Test Setup

Conducted Power Measurement:



4.1.4 Test Results

Conducted Output Power (dBm)

5GNR n78:

Channel Number	Freq. (MHz)	QPSK									PASS /FAIL
		Conducted Average Power (dBm/MHz)					Directional gain (dBi)	EIRP (dBm /MHz)	EIRP (W/MHz)	Limit (W/MHz)	
		Ant.0	Ant. 1	Ant.2	Ant.3	Total					
650000	3750	24.11	24.24	24.67	24.73	30.47	11.32	41.79	15.10	1640.00	PASS

Channel Number	Freq. (MHz)	16QAM									PASS /FAIL
		Conducted Average Power (dBm/MHz)					Directional gain (dBi)	EIRP (dBm /MHz)	EIRP (W/MHz)	Limit (W/MHz)	
		Ant.0	Ant. 1	Ant.2	Ant.3	Total					
650000	3750	23.84	24.10	24.72	24.51	30.33	11.32	41.65	14.62	1640.00	PASS

Channel Number	Freq. (MHz)	64QAM									PASS /FAIL
		Conducted Average Power (dBm/MHz)					Directional gain (dBi)	EIRP (dBm /MHz)	EIRP (W/MHz)	Limit (W/MHz)	
		Ant.0	Ant. 1	Ant.2	Ant.3	Total					
650000	3750	23.93	24.15	24.94	24.65	30.46	11.32	41.78	15.07	1640.00	PASS

Channel Number	Freq. (MHz)	256QAM									PASS /FAIL
		Conducted Average Power (dBm/MHz)					Directional gain (dBi)	EIRP (dBm /MHz)	EIRP (W/MHz)	Limit (W/MHz)	
		Ant.0	Ant. 1	Ant.2	Ant.3	Total					
650000	3750	23.92	24.13	24.87	24.74	30.45	11.32	41.77	15.03	1640.00	PASS

*Directional gain=5.3 dBi +Array Gain(6.02)= 11.32 dBi

*EIRP = Conducted + Directional gain (11.32 dBi)

*The antenna gain was declared by client.

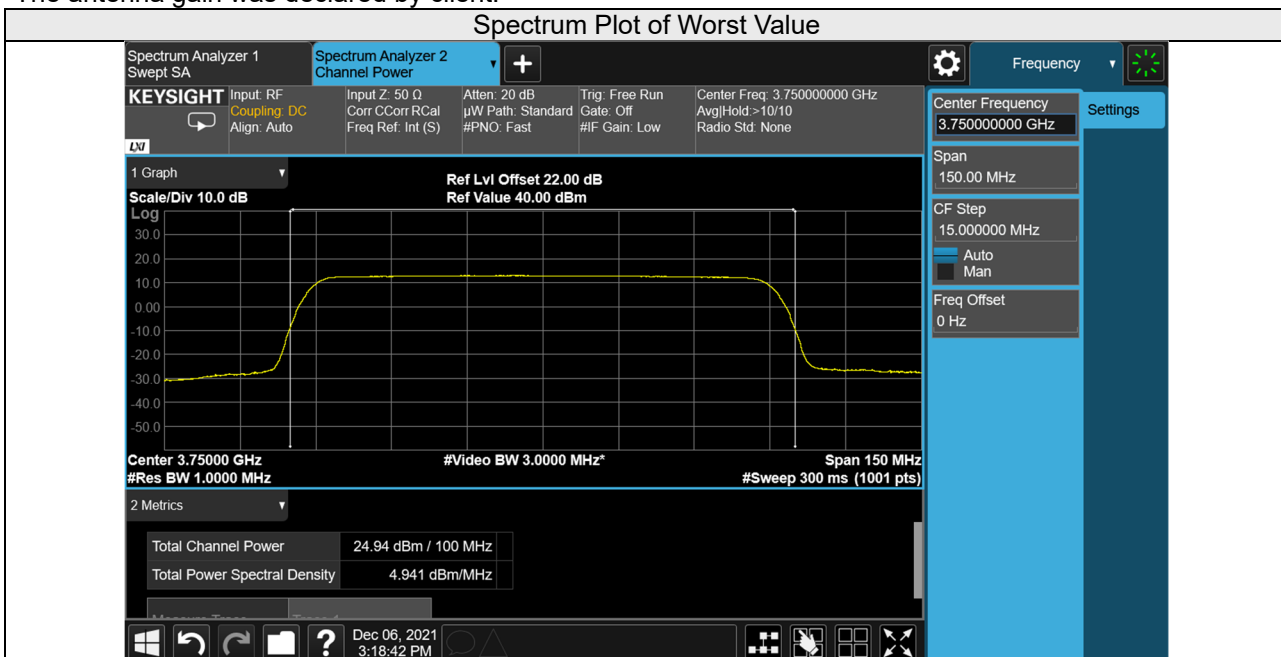

4.2 Modulation Characteristics Measurement

4.2.1 Limits of Modulation Characteristics

N/A

4.2.2 Test Procedure

Connect the EUT to Spectrum Analyzer via the antenna connector, the frequency band is set as EUT supported Modulation and Channels, the EUT output is matched with 50 ohm load, the waveform quality and constellation of the EUT was tested.

4.2.3 Test Setup

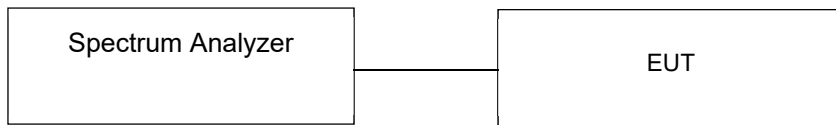

4.2.4 Test Results

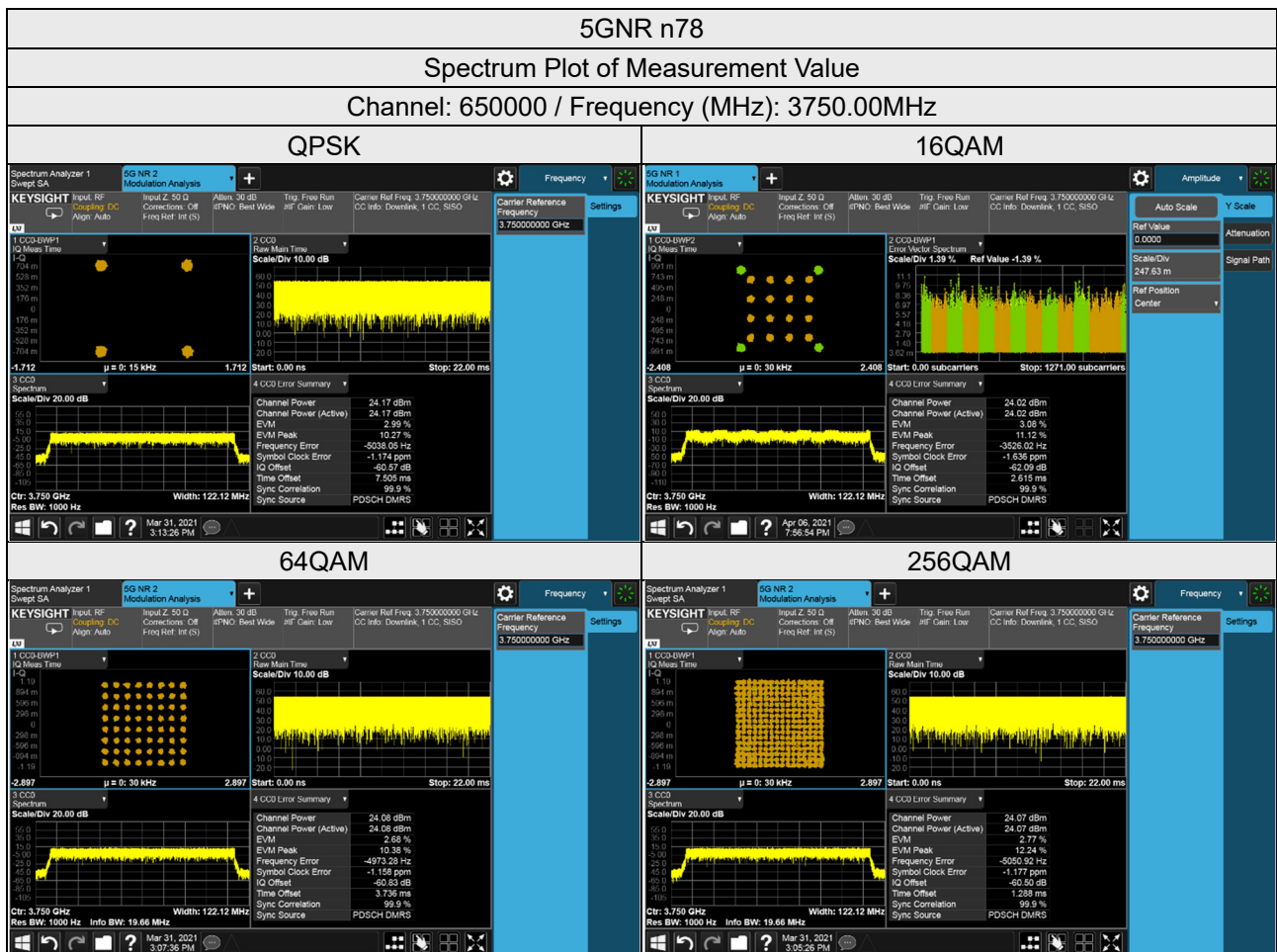

4.3 Frequency Stability Measurement

4.3.1 Limits of Frequency Stability Measurement

The frequency stability shall be sufficient to ensure that the fundamental emissions stay within the authorized bands of operation.

According to the FCC part 2.1055 shall be tested the frequency stability. The rule is defined that "The frequency stability shall be sufficient to ensure that the fundamental emission stays within the authorized frequency block." The test extreme voltage is according to the 2.1055(d)(1) Vary primary supply voltage from 85 to 115 percent of the nominal value for other than hand carried battery equipment and the extreme temperature rule is comply with specification of EUT $-30^{\circ}\text{C} \sim 50^{\circ}\text{C}$.

4.3.2 Test Procedure

- Device is placed at the oven room. The oven room could control the temperatures and humidity. Power warm up is at least 15 min and power applied should perform before recording frequency error.
- EUT is connected the external power supply to control the AC input power. The test voltage range is from minimum to maximum working voltage. Each step shall be record the frequency error rate.
- The temperature range step is 10 degrees in this test items. All temperature levels shall be hold the $\pm 0.5^{\circ}\text{C}$ during the measurement testing. The each temperature step shall be at least 0.5 hours, consider the EUT could be test under the stability condition.

Note: The frequency error was recorded frequency error from the communication simulator.

4.3.3 Test Instruments

Description & Manufacturer	Model No.	Serial No.	Cal. Date	Cal. Due
PXA Signal Analyzer KEYSIGHT	N9030B	MY57140938	Mar. 09, 2021	Mar. 08, 2022
Temperature & Humidity Chamber TERCHY	HRM-120RF	931022	Dec. 24, 2020	Dec. 23, 2021
Digital Multimeter Fluke	87-III	70360742	Jun. 24, 2021	Jun. 23, 2022
AC Power Supply Extech	CFW-105	E000603	NA	NA

Note: 1. The calibration interval of the above test instruments is 12 months and the calibrations are traceable to NML/ROC and NIST/USA.

4.3.4 Test Setup

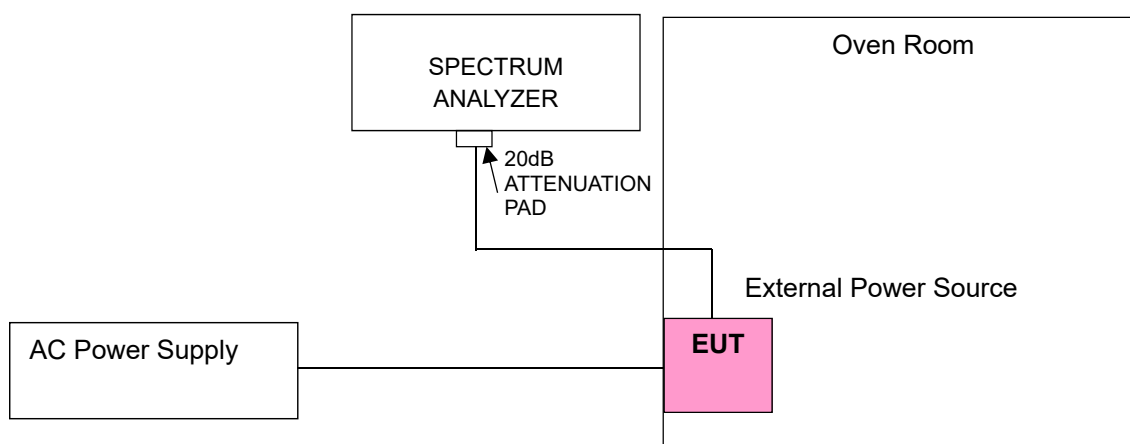

4.3.5 Test Results

Frequency Error vs. Voltage

Voltage (Vac)	5GNR n78			
	Channel Bandwidth 100 MHz			
	Ant. TX 0		Ant. TX 1	
	Frequency (MHz)	Frequency Error (ppm)	Frequency (MHz)	Frequency Error (ppm)
120.00	3750.000037	0.010	3750.000026	0.007
102.00	3750.000025	0.007	3750.000026	0.007
138.00	3750.000024	0.006	3750.000020	0.005

Note: The applicant defined the normal working voltage is from 102Vac to 138Vac.

Frequency Error vs. Temperature

Temp. (°C)	5GNR n78			
	Channel Bandwidth 100 MHz			
	Ant. TX 0		Ant. TX 1	
	Frequency (MHz)	Frequency Error (ppm)	Frequency (MHz)	Frequency Error (ppm)
-30	3750.000029	0.008	3750.000025	0.007
-20	3750.000034	0.009	3750.000032	0.009
-10	3750.000040	0.011	3750.000014	0.004
0	3750.000040	0.011	3750.000011	0.003
10	3750.000037	0.010	3750.000032	0.009
20	3749.999976	-0.006	3749.999976	-0.006
30	3749.999969	-0.008	3749.999973	-0.007
40	3749.999989	-0.003	3749.999977	-0.006
50	3749.999966	-0.009	3749.999976	-0.006

Frequency Error vs. Voltage

Voltage (Vac)	5GNR n78			
	Channel Bandwidth 100 MHz			
	Ant. TX 2		Ant. TX 3	
	Frequency (MHz)	Frequency Error (ppm)	Frequency (MHz)	Frequency Error (ppm)
120.00	3750.000034	0.009	3750.000014	0.004
102.00	3750.000025	0.007	3750.000030	0.008
138.00	3750.000014	0.004	3750.000036	0.010

Note: The applicant defined the normal working voltage is from 102Vac to 138Vac.

Frequency Error vs. Temperature

Temp. (°C)	5GNR n78			
	Channel Bandwidth 100 MHz			
	Ant. TX 2		Ant. TX 3	
	Frequency (MHz)	Frequency Error (ppm)	Frequency (MHz)	Frequency Error (ppm)
-30	3750.000028	0.007	3750.000037	0.010
-20	3750.000037	0.010	3750.000034	0.009
-10	3750.000025	0.007	3750.000019	0.005
0	3750.000023	0.006	3750.000021	0.006
10	3750.000037	0.010	3750.000029	0.008
20	3749.999975	-0.007	3749.999988	-0.003
30	3749.999984	-0.004	3749.999961	-0.010
40	3749.999984	-0.004	3749.999979	-0.006
50	3749.999969	-0.008	3749.999970	-0.008

4.4 Emission Bandwidth Measurement

4.4.1 Test Procedure

According to FCC 2.1049, the occupied bandwidth, that is the frequency bandwidth such that, below its lower and above its upper frequency limits, the mean powers radiated are each equal to 0.5 % of the total mean power radiated by a given emission.

For the 26dBc bandwidth measurement method, please refer to section 5.4.3 of ANSI C63.26.

4.4.2 Test Procedure

For the 26dBc bandwidth measurement method, please refer to section 5.4.3 of ANSI C63.26.

- a) The spectrum analyzer center frequency is set to the nominal EUT channel center frequency. The span range for the spectrum analyzer shall be wide enough to see sufficient roll off of the signal to make the measurement.
- b) The nominal RBW shall be in the range of 1% to 5% of the anticipated OBW, and the VBW shall be set $\geq 3 \times$ RBW.
- c) Set the reference level of the instrument as required to prevent the signal amplitude from exceeding the maximum spectrum analyzer input mixer level for linear operation. See guidance provided in 4.2.3.
- d) The dynamic range of the spectrum analyzer at the selected RBW shall be more than 10 dB below the target “-X dB” requirement, i.e., if the requirement calls for measuring the -26 dB OBW, the spectrum analyzer noise floor at the selected RBW shall be at least 36 dB below the reference level.
- e) Set spectrum analyzer detection mode to peak, and the trace mode to max hold.
- f) Determine the following reference values: Set the EUT to transmit a modulated signal. Allow the trace to stabilize. Set the spectrum analyzer marker to the highest level of the displayed trace (this is the reference value).
- g) Determine the “-X dB amplitude” as equal to (Reference Value - X). Alternatively, this calculation can be performed on the spectrum analyzer using the delta-marker measurement function.
- h) Place two markers, one at the lowest and the other at the highest frequency of the envelope of the spectral display such that each marker is at or slightly below the “-X dB amplitude” determined in step f). If a marker is below this “-X dB amplitude” value it should be as close as possible to this value. The OBW is the positive frequency difference between the two markers.
- i) The OBW shall be reported by providing plot(s) of the measuring instrument display, to include markers depicting the relevant frequency and amplitude information (e.g., marker table). The frequency and amplitude axis and scale shall be clearly labeled. Tabular data may be reported in addition to the plot(s).

For the occupied bandwidth measurement method, please refer to section 5.4.4 of ANSI C63.26.

4.4.3 Test Setup

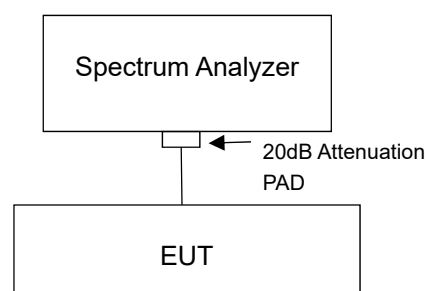

4.4.4 Test Result

Occupied Bandwidth

Channel Number	Freq. (MHz)	99% Occupied Bandwidth (MHz)															
		Ant. TX0				Ant. TX1				Ant. TX2				Ant. TX3			
		QPSK	16QAM	64QAM	256QAM	QPSK	16QAM	64QAM	256QAM	QPSK	16QAM	64QAM	256QAM	QPSK	16QAM	64QAM	256QAM
650000	3750	94.21	93.76	94.22	94.21	94.34	93.91	94.30	94.28	94.25	93.81	94.28	94.26	94.23	93.83	94.25	94.23

26dB Bandwidth

Channel Number	Freq. (MHz)	26dB Bandwidth (MHz)															
		Ant. TX0				Ant. TX1				Ant. TX2				Ant. TX3			
		QPSK	16QAM	64QAM	256QAM	QPSK	16QAM	64QAM	256QAM	QPSK	16QAM	64QAM	256QAM	QPSK	16QAM	64QAM	256QAM
650000	3750	99.75	99.56	99.65	99.64	99.77	99.57	99.69	99.66	99.75	99.56	99.67	99.66	99.76	99.57	99.67	99.65

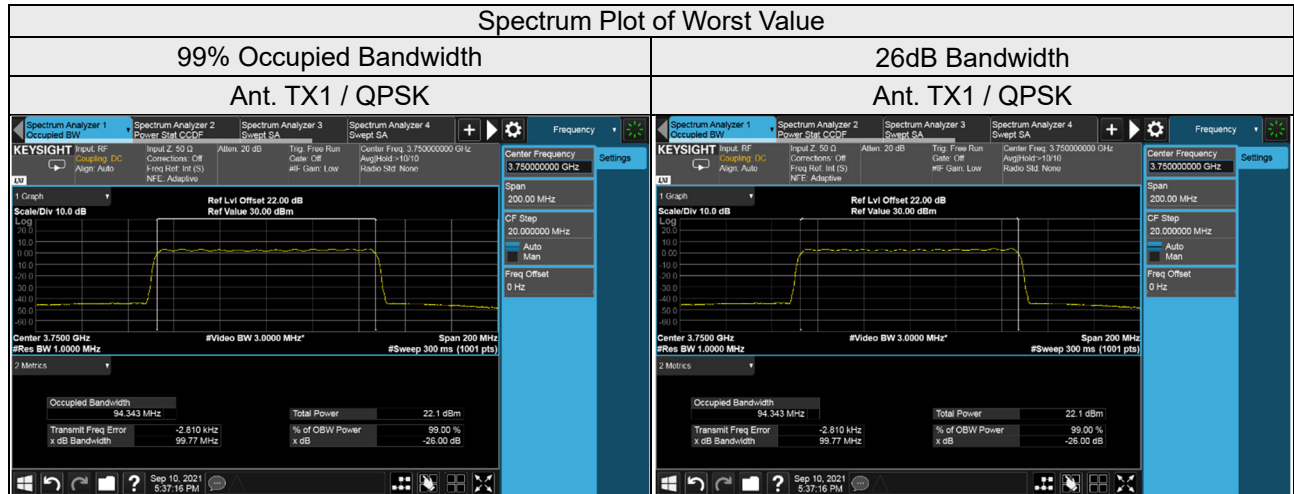

4.5 Channel Edge / Out-of-Band Emission Measurement

4.5.1 Limits of Channel Edge / Out-of-Band Emission Measurement

For base station operations in the 3700-3980 MHz band, the conducted power of any emission outside the licensee's authorized bandwidth shall not exceed -13 dBm/MHz. Compliance with this paragraph (I)(1) is based on the use of measurement instrumentation employing a resolution bandwidth of 1 megahertz or greater. However, in the 1 megahertz bands immediately outside and adjacent to the licensee's frequency block, a resolution bandwidth of at least one percent of the emission bandwidth of the fundamental emission of the transmitter may be employed. The emission bandwidth is defined as the width of the signal between two points, one below the carrier center frequency and one above the carrier center frequency, outside of which all emissions are attenuated at least 26 dB below the transmitter power.

Note:

This device can be implement MIMO function, so the limit of spurious emissions needs to be reduced by $10\log(\text{NumbersAnt})$ according to FCC KDB 662911 D01 guidance.
(4TX: The limit is adjusted to $-13\text{dBm} - 10*\log(4) = -19.02\text{dBm}$.)

4.5.2 Test Setup

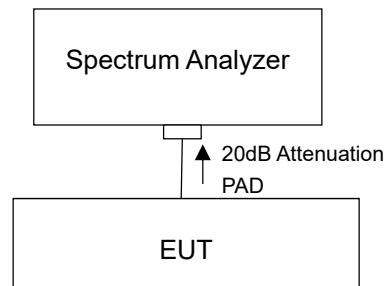

4.5.3 Test Procedures

- The EUT was set up for the rated peak power. The power was measured with Spectrum Analyzer. All measurements were done at 2 channels: low and high operational frequency range.
- Measurement refer to ANSI C63.26 section 5.7.2 and FCC Part 27 section 27.53.
- Record the max trace plot into the test report.

4.5.4 Test Results

Out-of-Band Emission

5GNR n78:

Ant. TX 0

5GNR n78, Channel Bandwidth 100MHz

Channel 650000 (3750.00MHz)

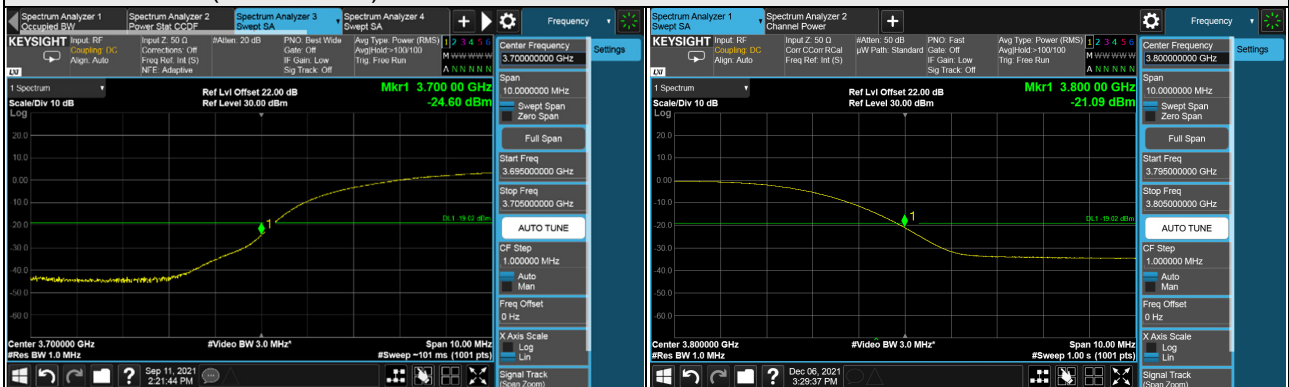

Ant. TX 1

5GNR n78, Channel Bandwidth 100MHz

Channel 650000 (3750.00MHz)

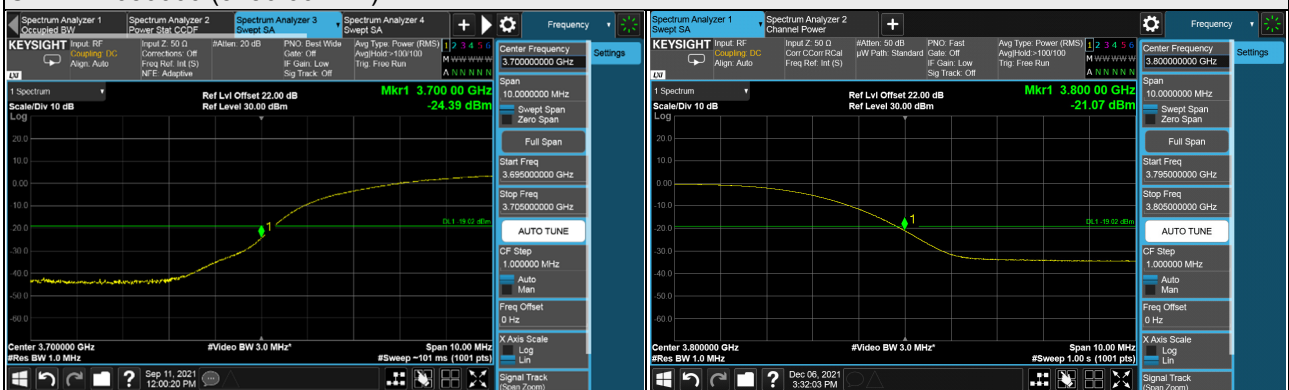

Ant. TX 2

5GNR n78, Channel Bandwidth 100MHz

Channel 650000 (3750.00MHz)

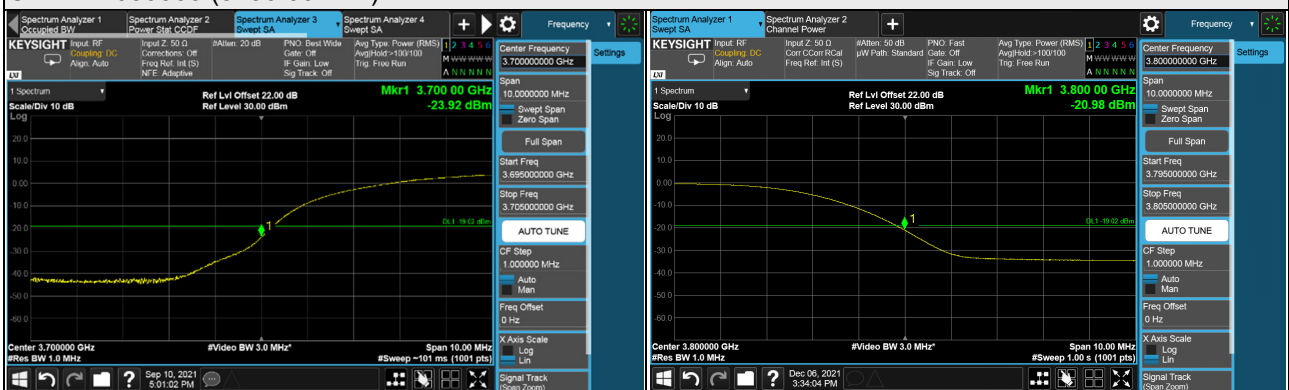

Ant. TX 3

5GNR n78, Channel Bandwidth 100MHz

Channel 650000 (3750.00MHz)

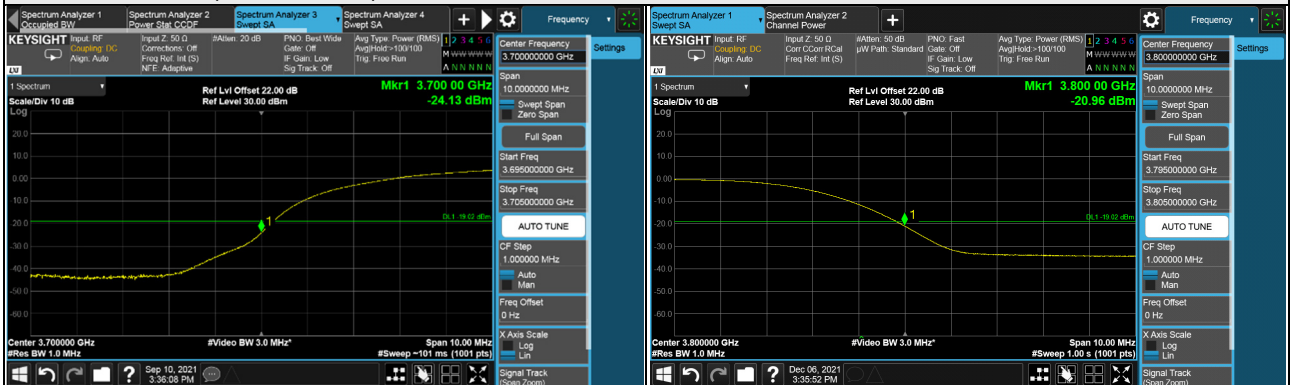

4.6 Peak to Average Ratio

4.6.1 Limits of Peak to Average Ratio Measurement

In measuring transmissions in this band using an average power technique, the peak to-average ratio (PAR) of the transmission may not exceed 13 dB

4.6.2 Test Setup

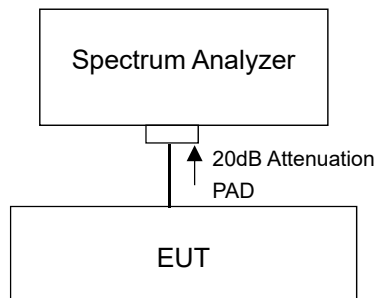

4.6.3 Test Procedures

- Set resolution/measurement bandwidth \geq signal's occupied bandwidth;
- Set the number of counts to a value that stabilizes the measured CCDF curve;
- Record the maximum PAPR level associated with a probability of 0.1%.

4.6.4 Test Results

5GNR n78:

Channel Number	Freq. (MHz)	Peak To Average Ratio (dB)															
		Ant. TX0				Ant. TX1				Ant. TX2				Ant. TX3			
		QPSK	16QAM	64QAM	256QAM	QPSK	16QAM	64QAM	256QAM	QPSK	16QAM	64QAM	256QAM	QPSK	16QAM	64QAM	256QAM
650000	3750	8.27	8.48	8.36	8.37	8.28	8.44	8.35	8.35	8.28	8.43	8.36	8.35	8.46	8.45	8.38	8.35

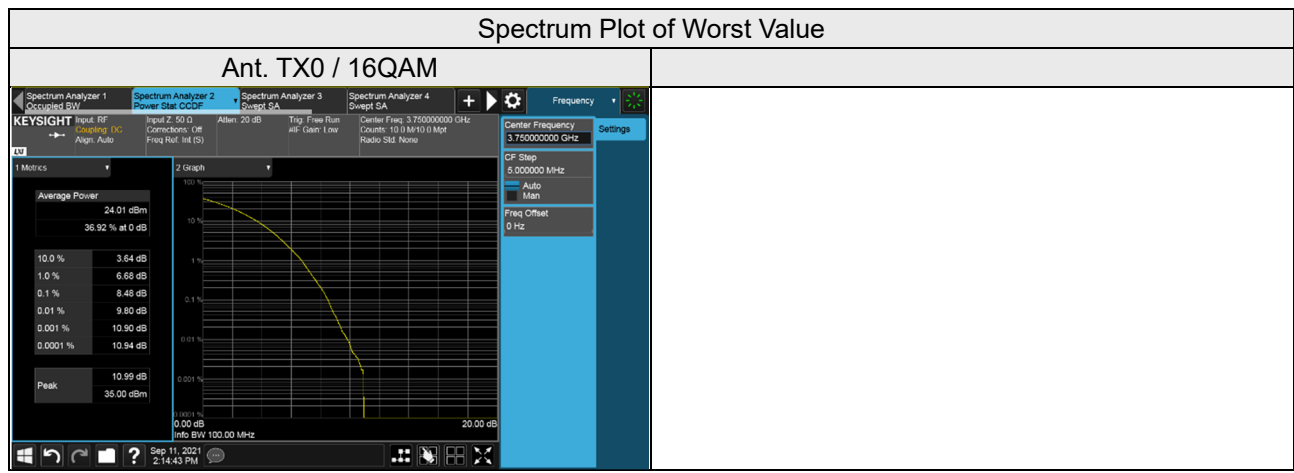

4.7 Conducted Spurious Emissions

4.7.1 Limits of Conducted Spurious Emissions Measurement

According to FCC 27.53(l), for operations in the 3700-3980 MHz band, the conducted power of any emission outside the licensee's authorized bandwidth shall not exceed -13 dBm/MHz.

Note:

This device can be implement MIMO function, so the limit of spurious emissions needs to be reduced by $10\log(\text{NumbersAnt})$ according to FCC KDB 662911 D01 guidance.

(4TX: The limit is adjusted to $-13\text{dBm} - 10*\log(4) = -19.02\text{dBm}$.)

4.7.2 Test Setup

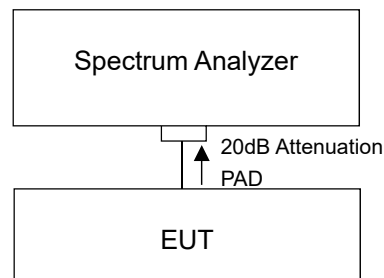

4.7.3 Test Procedure

- Measuring frequency range is from 9 kHz up to 40GHz, whichever is lower. 20dB attenuation pad is connected with spectrum.
- The spectrum set RBW = 1MHz, VBW = 3MHz.
- Measurement refer to ANSI C63.26 section 5.7.3.

4.7.4 Test Results

5G NR n78:

Ant. TX 0

5G NR n78, Channel Bandwidth 100MHz

Channel 650000 (3750MHz)

Frequency Range : 9kHz ~ 1GHz

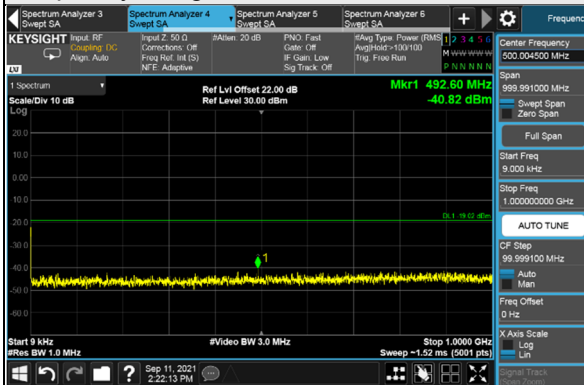

Frequency Range : 1GHz ~ 26GHz

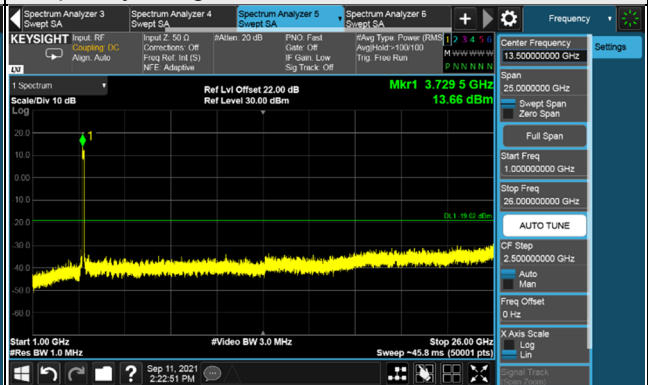

Frequency Range : 26GHz ~ 40GHz

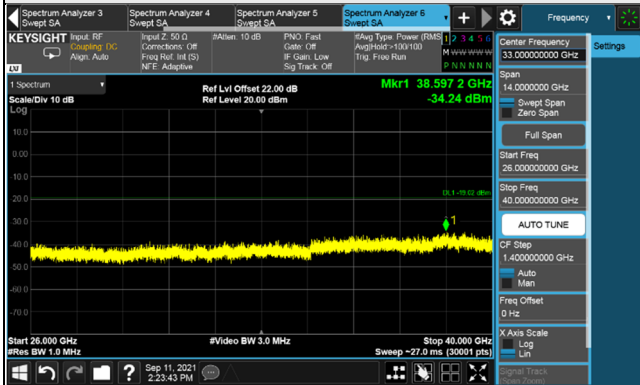

*The 9 kHz tone is from the spectrum analyzer.

Ant. TX 1

5GNR n78, Channel Bandwidth 100MHz

Channel 650000 (3750MHz)

Frequency Range : 9kHz ~ 1GHz

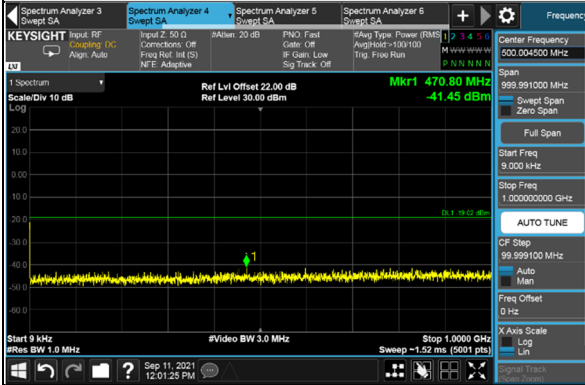

Frequency Range : 1GHz ~ 26GHz

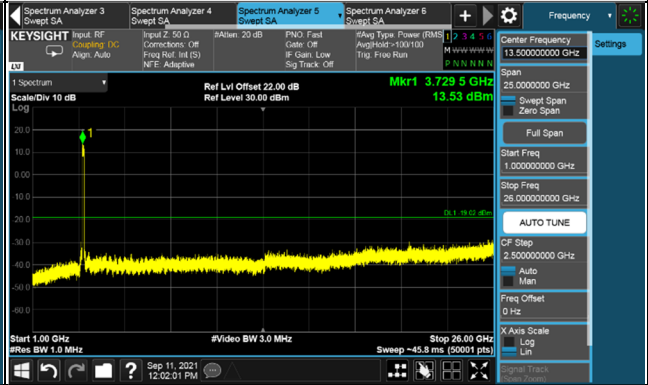

Frequency Range : 26GHz ~ 40GHz

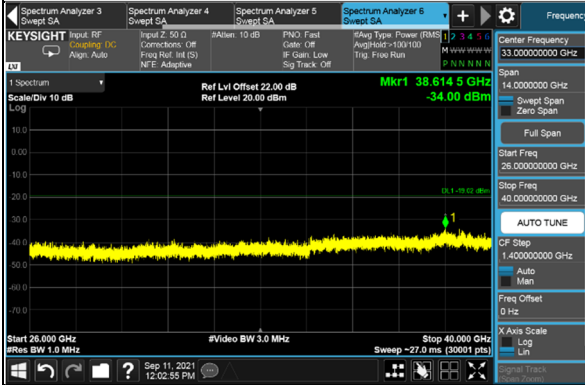

*The 9 kHz tone is from the spectrum analyzer.