

LTE band 7 - Low CH QPSK-20

LTE band 7 - Low CH 16QAM-20

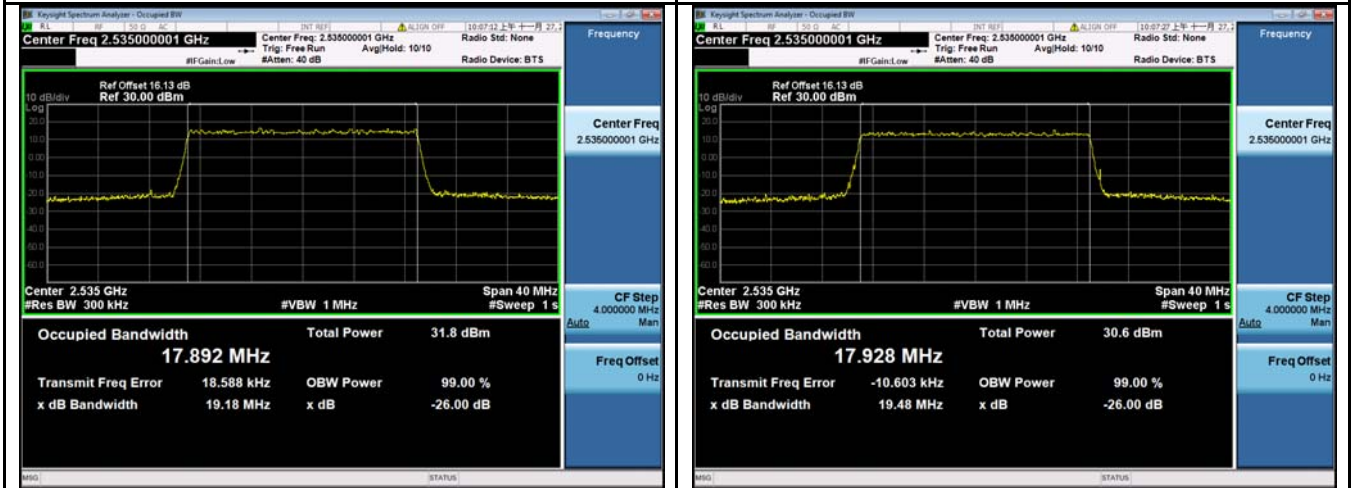

LTE band 7 - Middle CH QPSK-20

LTE band 7 - Middle CH 16QAM-20

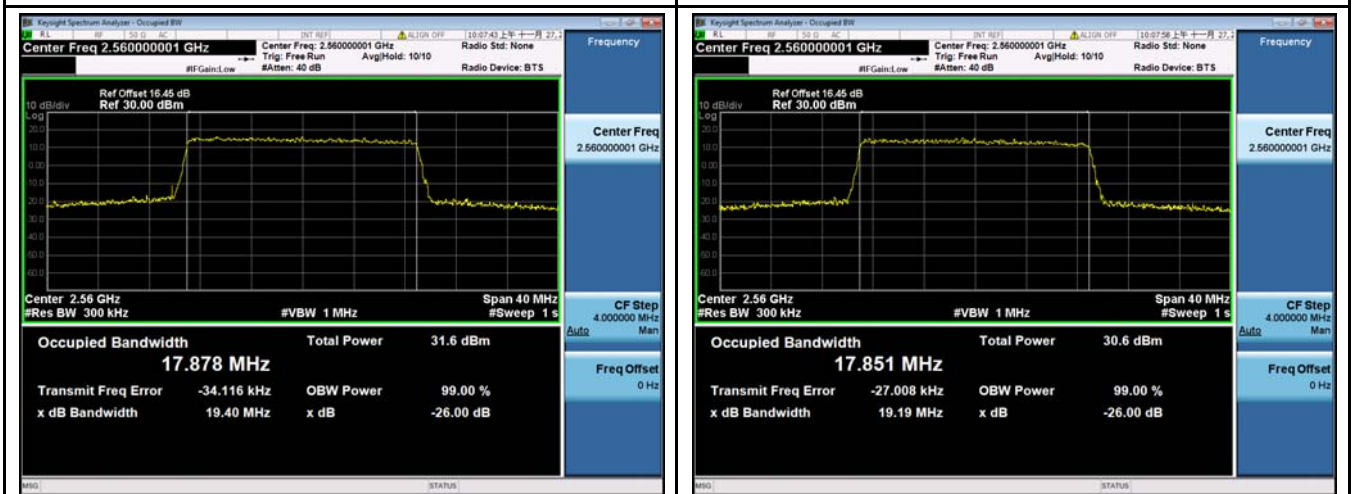

LTE band 7 - High CH QPSK-20

LTE band 7 - High CH 16QAM-20

LTE Band 12 (Part 27)

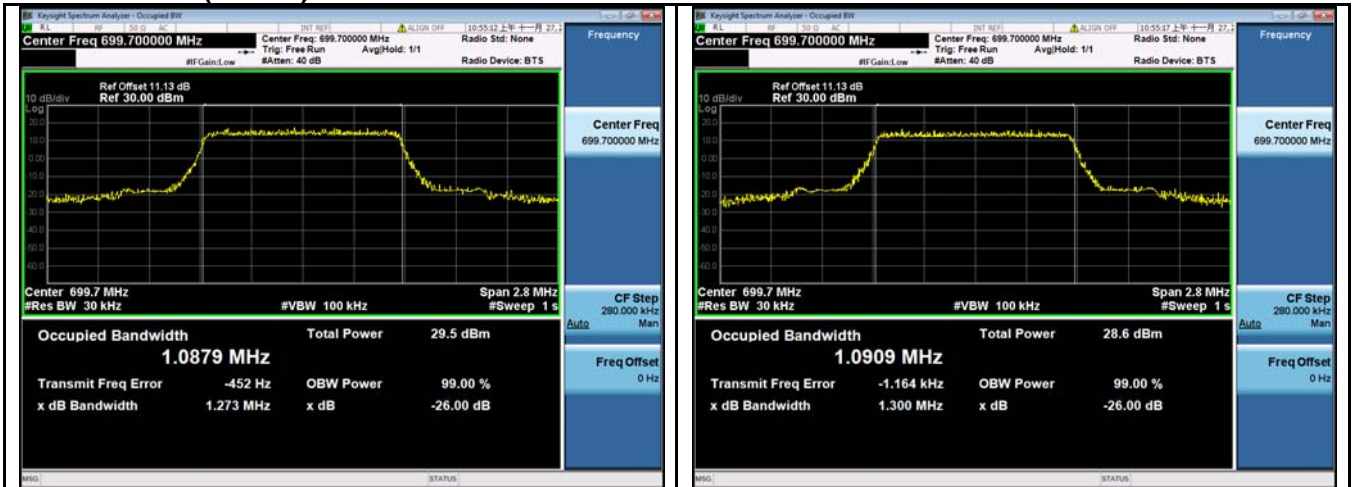

LTE band 12 - Low CH QPSK-1.4

LTE band 12 - Low CH 16QAM-1.4

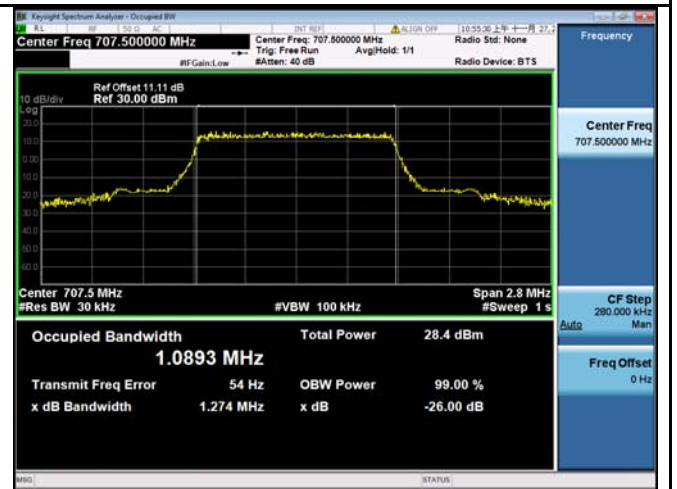

LTE band 12 - Middle CH QPSK-1.4

LTE band 12 - Middle CH 16QAM-1.4

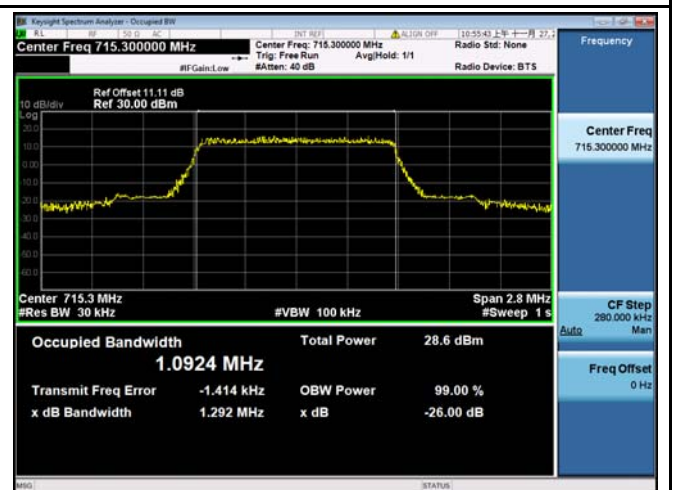
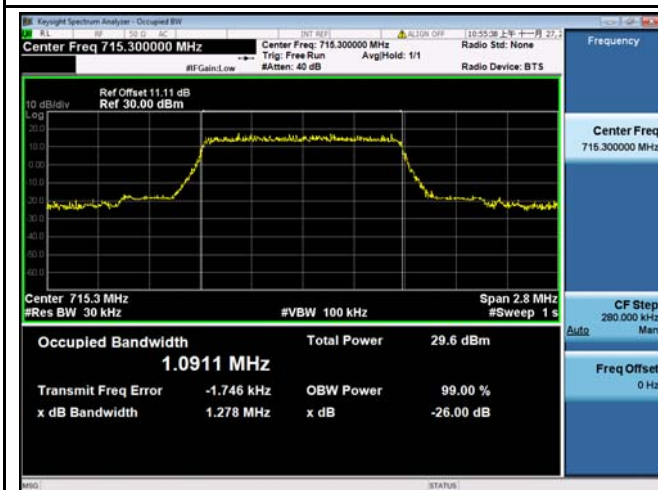

LTE band 12 - High CH QPSK-1.4

LTE band 12 - High CH 16QAM-1.4



LTE band 12 - Low CH QPSK-3

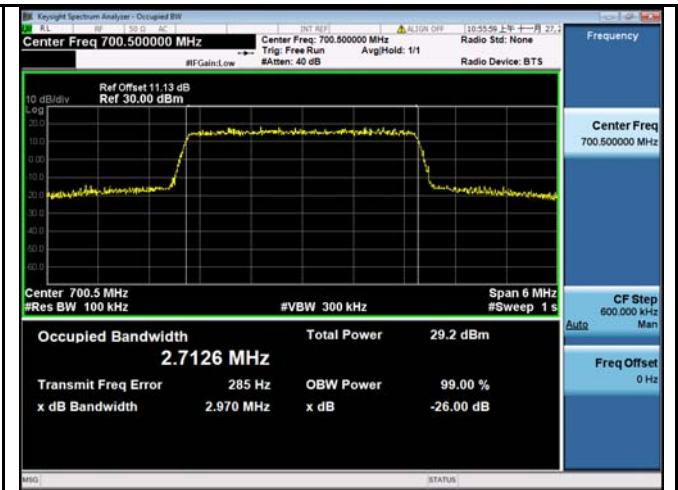

LTE band 12 - Low CH 16QAM-3

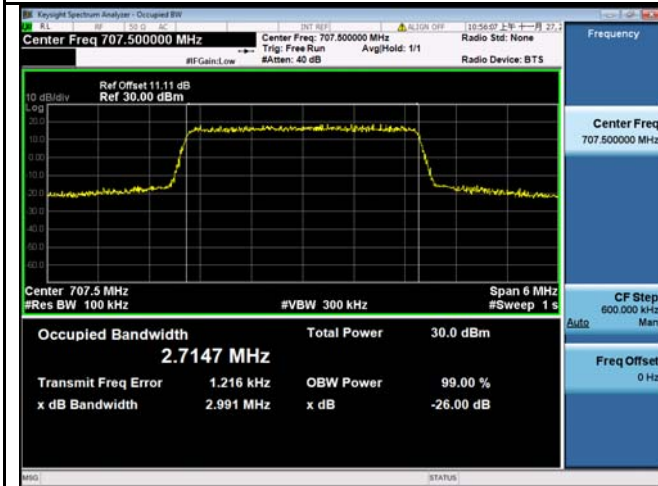

LTE band 12 - Middle CH QPSK-3



LTE band 12 - Middle CH 16QAM-3

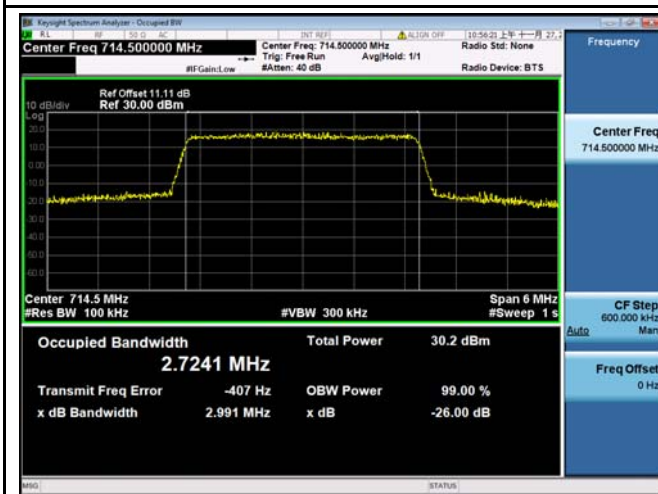

LTE band 12 - High CH QPSK-3

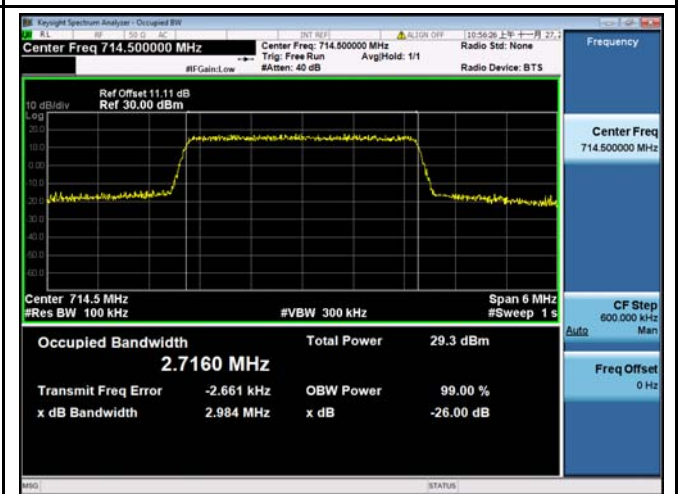

LTE band 12 - High CH 16QAM-3



LTE band 12 - Low CH QPSK-5

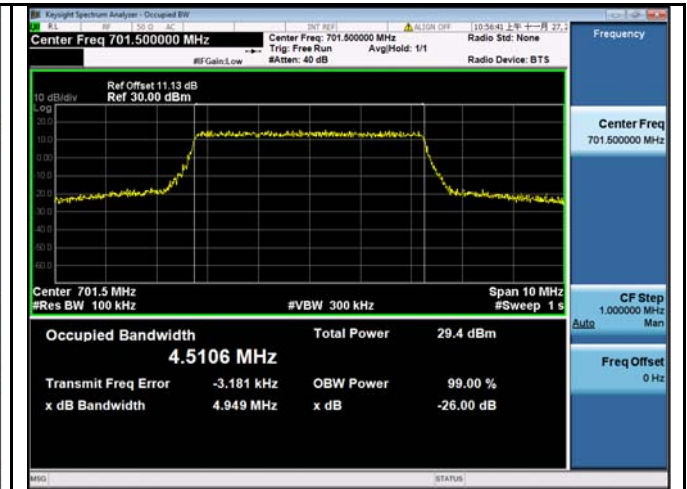

LTE band 12 - Low CH 16QAM-5



LTE band 12 - Middle CH QPSK-5



LTE band 12 - Middle CH 16QAM-15

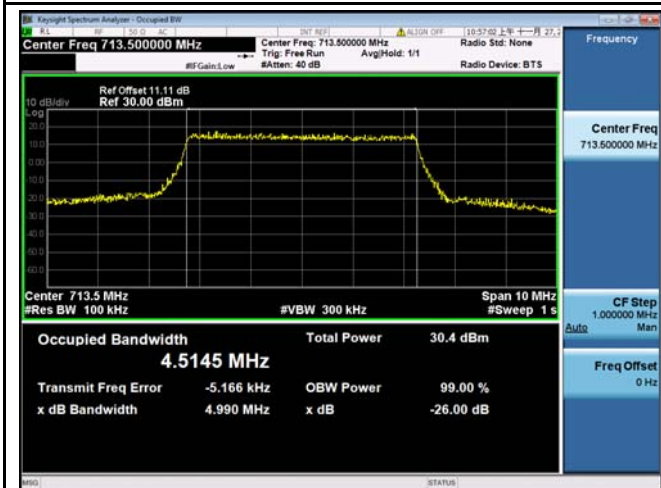

LTE band 12 - High CH QPSK-55



LTE band 12 - High CH 16QAM-5

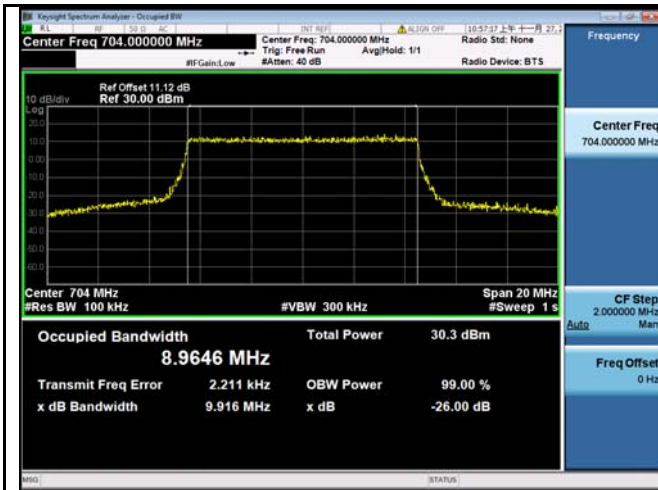

LTE band 12 - Low CH QPSK-10

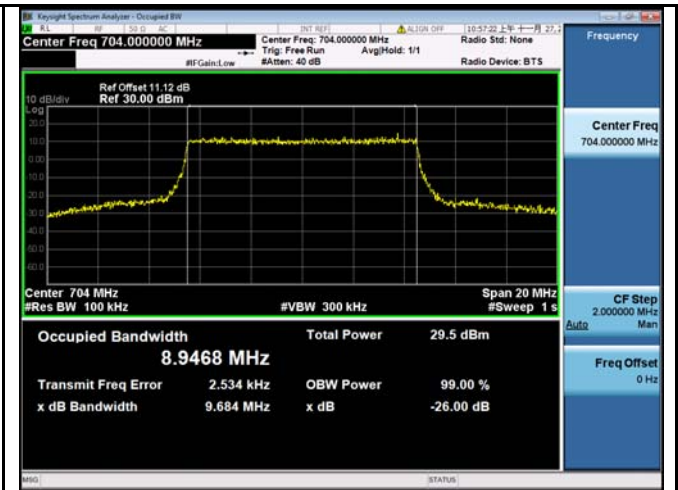

LTE band 12 - Low CH 16QAM-10



LTE band 12 - Middle CH QPSK-10



LTE band 12 - Middle CH 16QAM-10

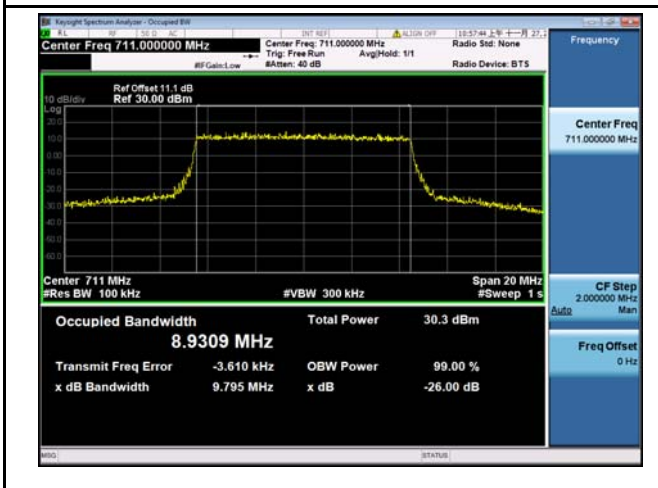

LTE band 7 - High CH QPSK-10

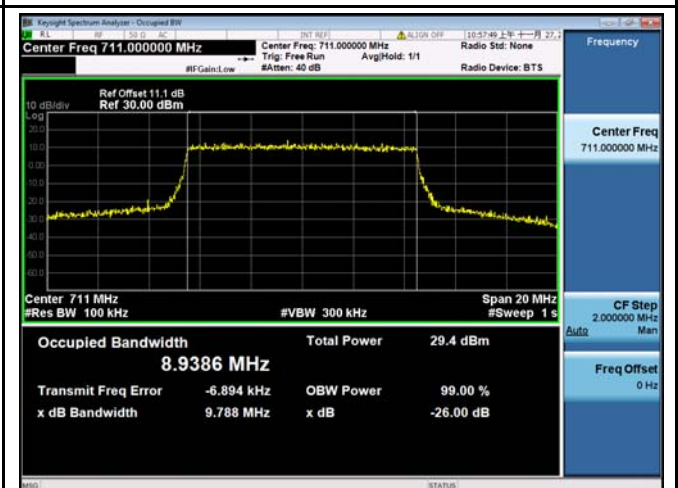

LTE band 7 - High CH 16QAM-10

LTE Band 17 (Part 27)

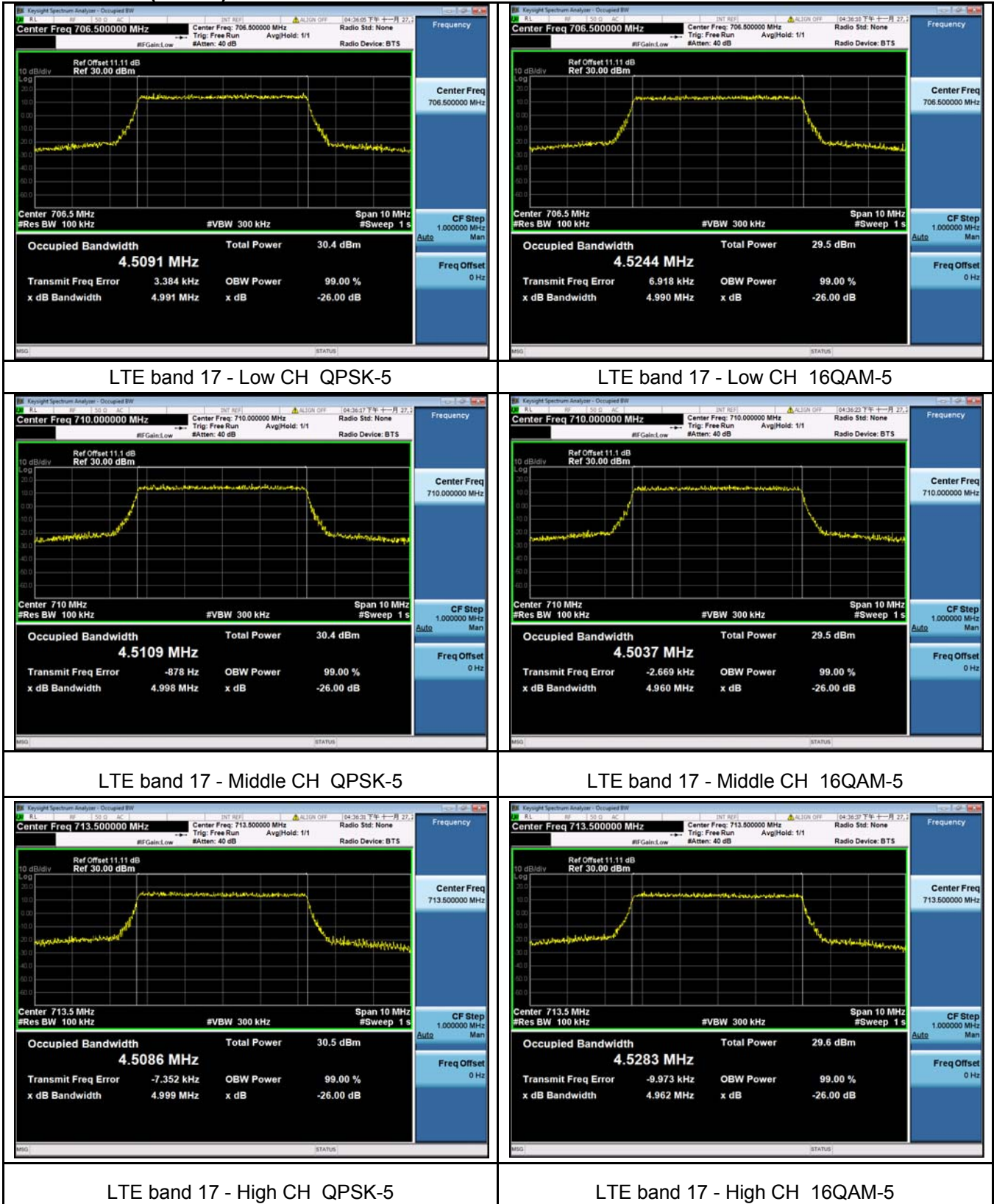

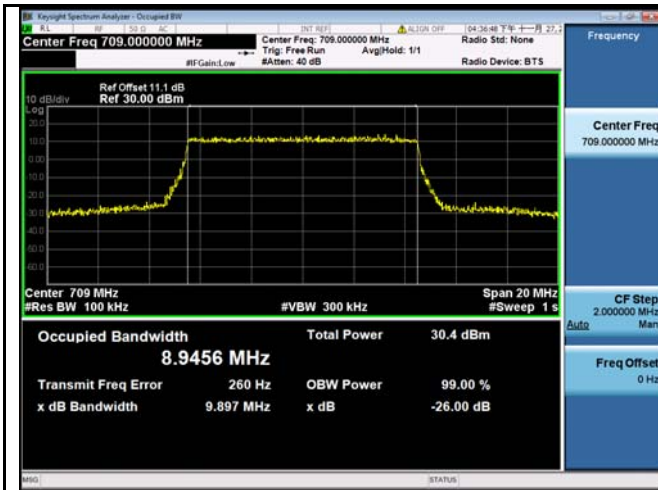

LTE band 17 - Low CH QPSK-10

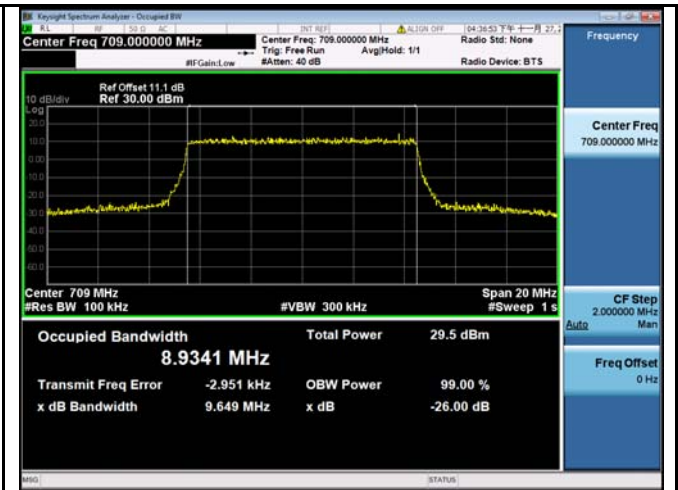

LTE band 17 - Low CH 16QAM-10



LTE band 17 - Middle CH QPSK-10

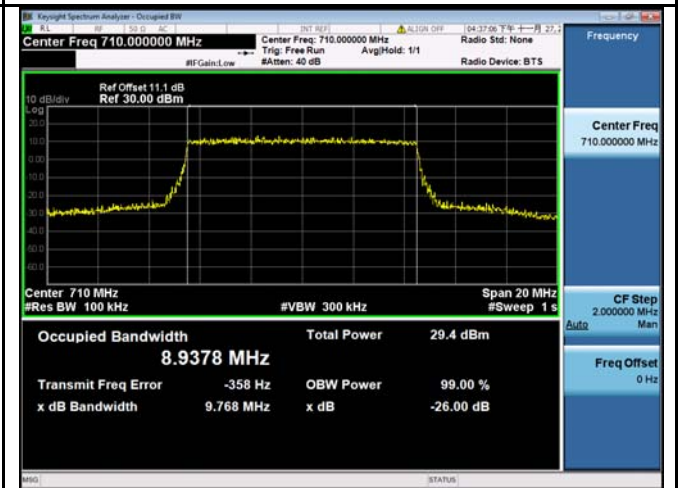

LTE band 17 - Middle CH 16QAM-10

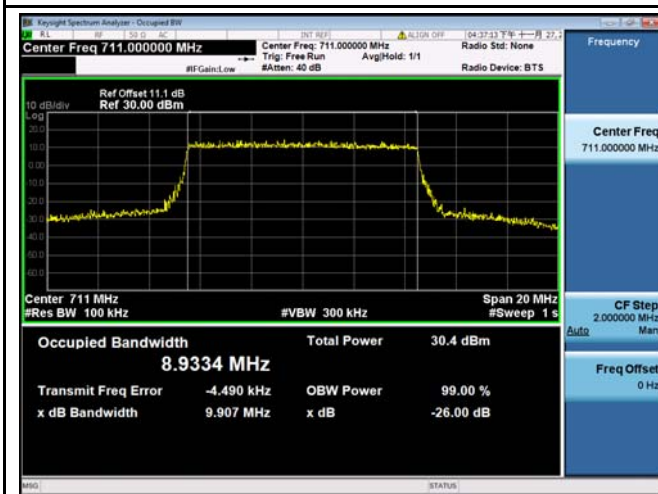

LTE band 17 - High CH QPSK-10

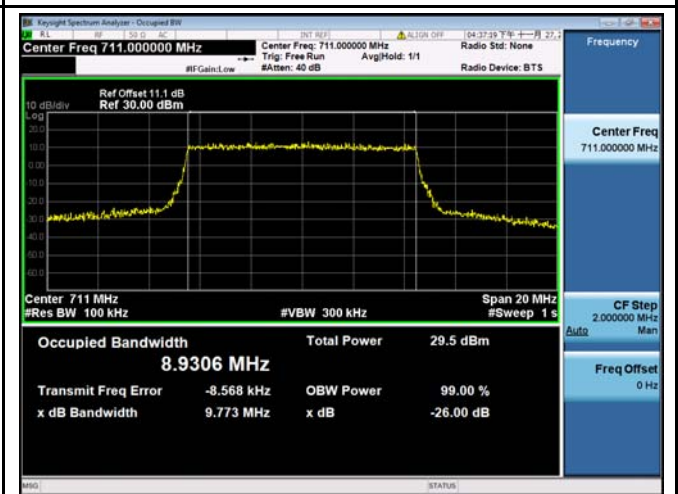

LTE band 17 - High CH 16QAM-10

11 SPURIOUS EMISSIONS AT ANTENNA TERMINALS

| | |
|-------------------|--|
| Test Requirement: | FCC Part 2.1051, 22.917(a), 24.238(a), 27.53(h), 27.53(m)(4) |
| Test Method: | TIA/EIA-603-D:2010 KDB971168 D01 v03 |
| Test Mode: | TX transmitting |

11.1 EUT Operation

Operating Environment :

| | |
|-----------------------|-----------|
| Temperature: | 23.5 °C |
| Humidity: | 52.1 % RH |
| Atmospheric Pressure: | 101.3kPa |

11.2 Test Procedure

The RF output of the transceiver was connected to a spectrum analyzer and simulator through appropriate attenuation. The resolution bandwidth of the spectrum analyzer was set at 1MHz. Sufficient scans were taken to show any out of band emissions up to 10th harmonics.

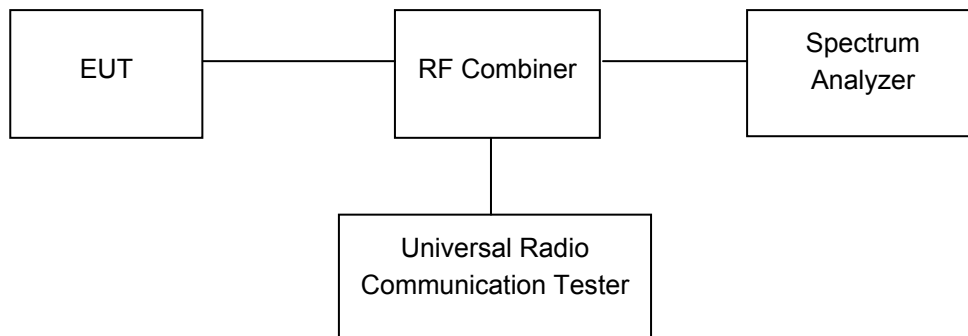

11.3 Test Result

PASS

LTE Band

Please refer to the Annex C. LTE Transmitter Spurious Emissions for LTE Band 2/4/5/7/12/17.

12 SPURIOUS RADIATED EMISSIONS

| | |
|-------------------|--|
| Test Requirement: | FCC Part 2.1053, 22.917, 24.238, 27.53(h), 27.53(m)(4) |
| Test Method: | TIA/EIA-603-D:2010 KDB971168 D01 v03 |
| Test Mode: | TX transmitting |

12.1 EUT Operation

| | |
|-------------------------|-----------|
| Operating Environment : | |
| Temperature: | 23.5 °C |
| Humidity: | 52.1 % RH |
| Atmospheric Pressure: | 101.2kPa |

12.2 Test Setup

The radiated emission tests were performed in the 3m Semi- Anechoic Chamber test site. The test setup for emission measurement from 30 MHz to 1 GHz.

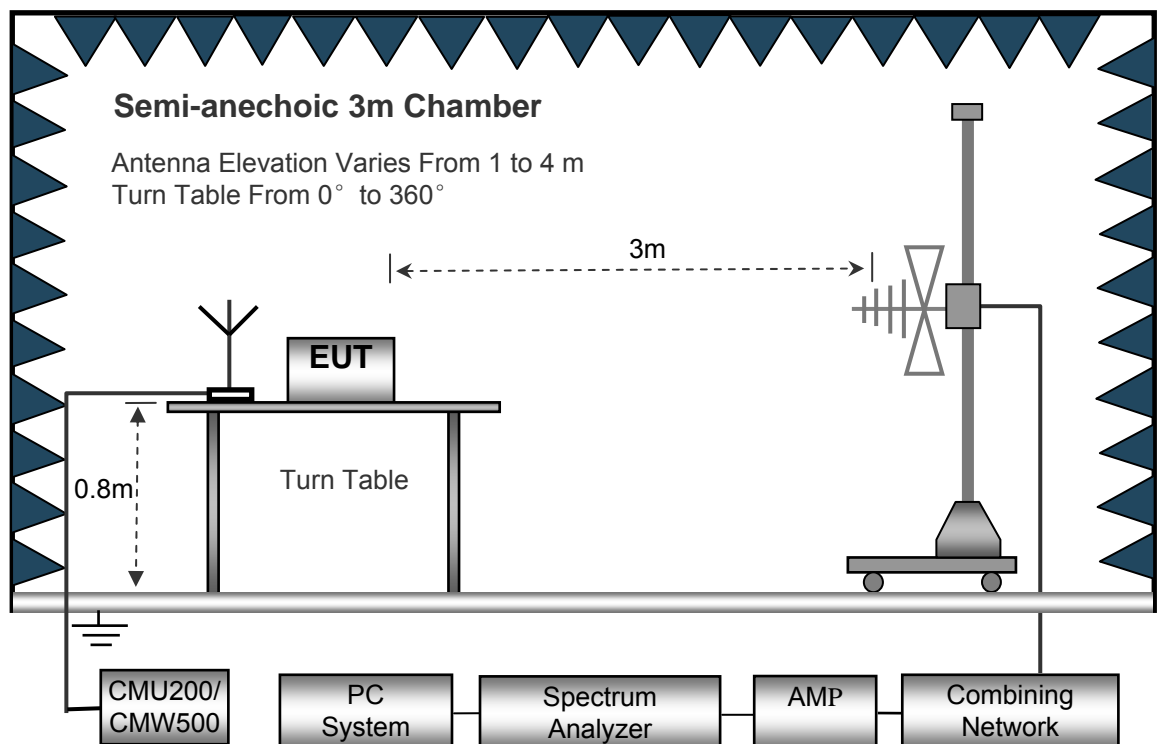

The test setup for emission measurement above 1 GHz.

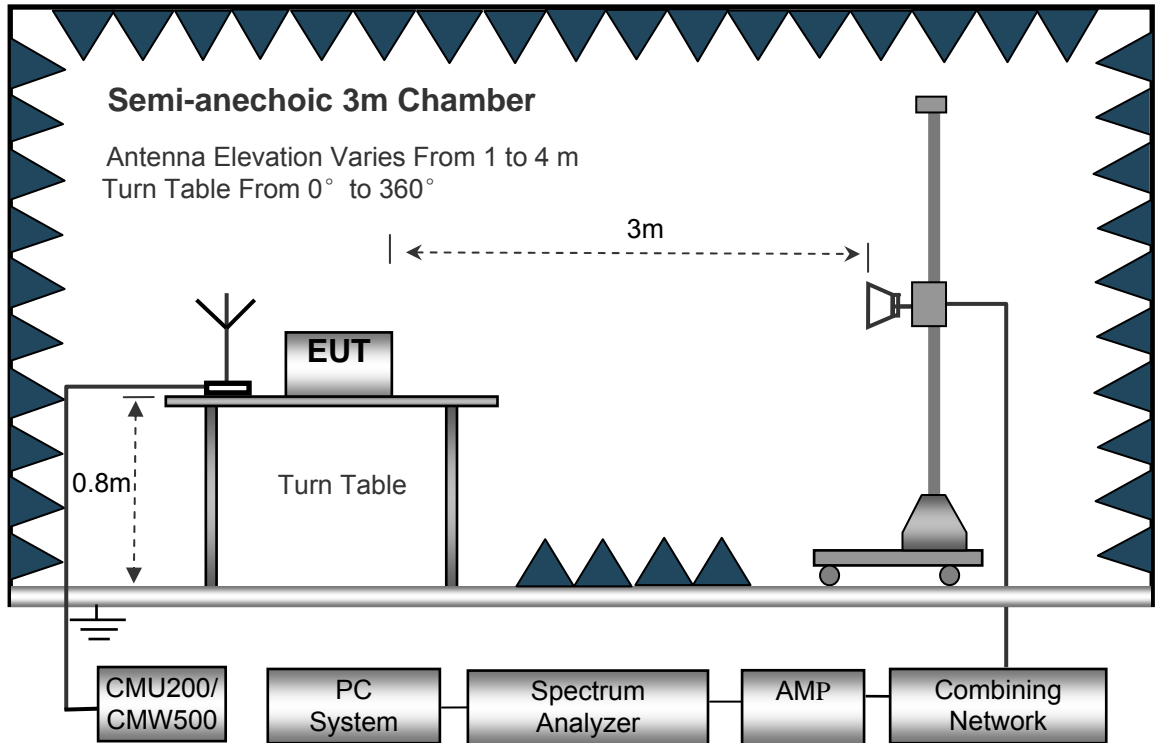

12.3 Spectrum Analyzer Setup

30MHz ~ 1GHz

Sweep Speed Auto
 Detector PK
 Resolution Bandwidth..... 100kHz
 Video Bandwidth..... 300kHz

Above 1GHz

Sweep Speed Auto
 Detector PK
 Resolution Bandwidth..... 1MHz
 Video Bandwidth..... 3MHz
 Detector Ave.
 Resolution Bandwidth..... 1MHz
 Video Bandwidth..... 10Hz

12.4 Test Procedure

1. The EUT is placed on a turntable, which is 0.8m above ground plane.
2. The turntable shall be rotated for 360 degrees to determine the position of maximum emission level.
3. EUT is set 3m away from the receiving antenna, which is moved from 1m to 4m to find out the maximum emissions. The spectrum was investigated from 30MHz up to the tenth harmonic of the highest fundamental frequency.
4. Maximum procedure was performed on the six highest emissions to ensure EUT compliance.
5. And also, each emission was to be maximized by changing the polarization of receiving antenna both horizontal and vertical.
6. The radiation measurements are tested under 3-axes(X,Y,Z) position(X denotes lying on the table, Y denotes side stand and Z denotes vertical stand), After pre-test, It was found that the worse radiation emission was get at the Z position. So the data shown was the Z position only.
7. Remove the EUT and replace it with substitution antenna. A signal generator was connected to the substitution antenna by a non-radiating cable. The absolute levels of the spurious emissions were measured by the substitution.
Spurious emissions in dB = $10 \lg (\text{TXpwr in Watts}/0.001)$ – the absolute level
Spurious attenuation limit in dB = $43 + 10 \text{Log}10 (\text{power out in Watts})$
8. Repeat above procedures until the measurements for all frequencies are completed.

12.5 Summary of Test Results

Remark: Test performed from 30MHz to 10th harmonics with low/middle/high channels, only the worst data were recorded.

LTE Band 2

| Frequency | Receiver Reading | Turn table Angle | RX Antenna | | Substituted | | | Absolute Level | Result | |
|--------------------------|------------------|------------------|------------|-------|-------------|-------|--------------|----------------|--------|--------|
| | | | Height | Polar | SG Level | Cable | Antenna Gain | | Limit | Margin |
| (MHz) | (dBμV) | Degree | (m) | (H/V) | (dBm) | (dB) | (dB) | (dBm) | (dBm) | (dB) |
| LTE BAND 2 Channel 18607 | | | | | | | | | | |
| 223.12 | 47.56 | 183 | 1.6 | H | -62.96 | 0.15 | 0.00 | -63.11 | -13.00 | -50.11 |
| 223.12 | 37.33 | 148 | 1.8 | V | -70.26 | 0.15 | 0.00 | -70.41 | -13.00 | -57.41 |
| 3701.40 | 65.95 | 288 | 2.0 | H | -45.59 | 2.37 | 12.50 | -35.46 | -13.00 | -22.46 |
| 3701.40 | 59.98 | 11 | 1.6 | V | -49.83 | 2.37 | 12.50 | -39.70 | -13.00 | -26.70 |
| 5552.10 | 53.58 | 130 | 2.2 | H | -56.06 | 2.86 | 12.90 | -46.02 | -13.00 | -33.02 |
| 5552.10 | 44.73 | 211 | 1.7 | V | -64.15 | 2.86 | 12.90 | -54.11 | -13.00 | -41.11 |
| LTE BAND 2 Channel 18900 | | | | | | | | | | |
| 223.12 | 47.09 | 286 | 1.2 | H | -63.42 | 0.15 | 0.00 | -63.57 | -13.00 | -50.57 |
| 223.12 | 36.98 | 201 | 1.9 | V | -70.61 | 0.15 | 0.00 | -70.76 | -13.00 | -57.76 |
| 3760.00 | 59.31 | 146 | 1.1 | H | -52.23 | 2.37 | 12.50 | -42.10 | -13.00 | -29.10 |
| 3760.00 | 53.89 | 41 | 2.1 | V | -55.92 | 2.37 | 12.50 | -45.79 | -13.00 | -32.79 |
| 5640.00 | 47.24 | 51 | 1.9 | H | -62.37 | 2.86 | 12.90 | -52.33 | -13.00 | -39.33 |
| 5640.00 | 38.52 | 85 | 1.2 | V | -70.36 | 2.86 | 12.90 | -60.32 | -13.00 | -47.32 |
| LTE BAND 2 Channel 19193 | | | | | | | | | | |
| 223.12 | 46.20 | 112 | 1.3 | H | -64.31 | 0.15 | 0.00 | -64.46 | -13.00 | -51.46 |
| 223.12 | 36.37 | 322 | 1.4 | V | -71.22 | 0.15 | 0.00 | -71.37 | -13.00 | -58.37 |
| 3818.60 | 52.39 | 62 | 1.6 | H | -58.46 | 2.37 | 12.60 | -48.23 | -13.00 | -35.23 |
| 3818.60 | 46.85 | 220 | 1.2 | V | -62.46 | 2.37 | 12.60 | -52.23 | -13.00 | -39.23 |
| 5727.90 | 40.67 | 145 | 1.0 | H | -68.68 | 2.86 | 12.90 | -58.64 | -13.00 | -45.64 |
| 5727.90 | 30.68 | 49 | 1.5 | V | -77.82 | 2.86 | 12.90 | -67.78 | -13.00 | -54.78 |

LTE Band 4

| Frequency | Receiver Reading | Turn table Angle | RX Antenna | | Substituted | | | Absolute Level | Result | |
|--------------------------|------------------|------------------|------------|-------|-------------|-------|--------------|----------------|--------|--------|
| | | | Height | Polar | SG Level | Cable | Antenna Gain | | Limit | Margin |
| (MHz) | (dBμV) | Degree | (m) | (H/V) | (dBm) | (dB) | (dB) | (dBm) | (dBm) | (dB) |
| LTE BAND 4 Channel 19957 | | | | | | | | | | |
| 223.12 | 40.80 | 154 | 1.3 | H | -69.72 | 0.15 | 0.00 | -69.87 | -13.00 | -56.87 |
| 223.12 | 31.63 | 328 | 1.2 | V | -75.96 | 0.15 | 0.00 | -76.11 | -13.00 | -63.11 |
| 3421.40 | 65.95 | 36 | 1.4 | H | -47.10 | 2.34 | 12.40 | -37.04 | -13.00 | -24.04 |
| 3421.40 | 59.98 | 8 | 2.1 | V | -51.18 | 2.34 | 12.40 | -41.12 | -13.00 | -28.12 |
| 5132.10 | 53.58 | 282 | 1.5 | H | -55.83 | 2.79 | 12.70 | -45.92 | -13.00 | -32.92 |
| 5132.10 | 44.73 | 241 | 1.2 | V | -64.05 | 2.79 | 12.70 | -54.14 | -13.00 | -41.14 |
| LTE BAND 4 Channel 20175 | | | | | | | | | | |
| 223.12 | 41.69 | 281 | 2.2 | H | -68.82 | 0.15 | 0.00 | -68.97 | -13.00 | -55.97 |
| 223.12 | 31.33 | 94 | 1.7 | V | -76.26 | 0.15 | 0.00 | -76.41 | -13.00 | -63.41 |
| 3465.00 | 59.80 | 303 | 1.8 | H | -53.25 | 2.37 | 12.50 | -43.12 | -13.00 | -30.12 |
| 3465.00 | 52.88 | 73 | 2.0 | V | -58.27 | 2.37 | 12.50 | -48.14 | -13.00 | -35.14 |
| 5197.50 | 47.23 | 110 | 1.7 | H | -62.18 | 2.79 | 12.70 | -52.27 | -13.00 | -39.27 |
| 5197.50 | 37.67 | 15 | 2.2 | V | -71.10 | 2.79 | 12.70 | -61.19 | -13.00 | -48.19 |
| LTE BAND 4 Channel 20393 | | | | | | | | | | |
| 223.12 | 42.23 | 144 | 2.2 | H | -68.28 | 0.15 | 0.00 | -68.43 | -13.00 | -55.43 |
| 223.12 | 31.96 | 335 | 1.1 | V | -75.63 | 0.15 | 0.00 | -75.78 | -13.00 | -62.78 |
| 3508.60 | 52.88 | 6 | 1.3 | H | -59.76 | 2.37 | 12.50 | -49.63 | -13.00 | -36.63 |
| 3508.60 | 45.85 | 51 | 1.1 | V | -64.88 | 2.37 | 12.50 | -54.75 | -13.00 | -41.75 |
| 5262.90 | 40.82 | 350 | 1.9 | H | -68.76 | 2.81 | 12.80 | -58.77 | -13.00 | -45.77 |
| 5262.90 | 30.66 | 14 | 1.4 | V | -78.14 | 2.81 | 12.80 | -68.15 | -13.00 | -55.15 |

LTE Band 5

| frequency | Receiver Reading | Turn table Angle | RX Antenna | | Substituted | | | Absolute Level | Result | |
|--------------------------|------------------|------------------|------------|-------|-------------|-------|--------------|----------------|--------|--------|
| | | | Height | Polar | SG Level | Cable | Antenna Gain | | Limit | Margin |
| (MHz) | (dBμV) | Degree | (m) | (H/V) | (dBm) | (dB) | (dB) | (dBm) | (dBm) | (dB) |
| LTE BAND 5 Channel 20407 | | | | | | | | | | |
| 223.12 | 39.09 | 314 | 2.1 | H | -71.42 | 0.15 | 0.00 | -71.57 | -13.00 | -58.57 |
| 223.12 | 29.69 | 116 | 1.7 | V | -77.89 | 0.15 | 0.00 | -78.04 | -13.00 | -65.04 |
| 1649.40 | 65.95 | 73 | 1.0 | H | -47.10 | 2.34 | 12.40 | -37.04 | -13.00 | -24.04 |
| 1649.40 | 59.98 | 62 | 1.1 | V | -51.17 | 2.34 | 12.40 | -41.11 | -13.00 | -28.11 |
| 2474.10 | 53.58 | 221 | 1.5 | H | -55.83 | 2.79 | 12.70 | -45.92 | -13.00 | -32.92 |
| 2474.10 | 44.73 | 61 | 1.1 | V | -64.04 | 2.79 | 12.70 | -54.13 | -13.00 | -41.13 |
| LTE BAND 5 Channel 20525 | | | | | | | | | | |
| 223.12 | 39.68 | 293 | 1.8 | H | -70.90 | 0.15 | 0.00 | -71.05 | -13.00 | -58.05 |
| 223.12 | 29.84 | 319 | 1.4 | V | -77.75 | 0.15 | 0.00 | -77.90 | -13.00 | -64.90 |
| 1673.00 | 58.49 | 262 | 2.0 | H | -54.56 | 2.37 | 12.50 | -44.43 | -13.00 | -31.43 |
| 1673.00 | 52.92 | 304 | 1.4 | V | -58.23 | 2.37 | 12.50 | -48.10 | -13.00 | -35.10 |
| 2509.50 | 46.46 | 335 | 1.5 | H | -62.96 | 2.79 | 12.70 | -53.05 | -13.00 | -40.05 |
| 2509.50 | 38.37 | 297 | 1.1 | V | -70.40 | 2.79 | 12.70 | -60.49 | -13.00 | -47.49 |
| LTE BAND 5 Channel 20643 | | | | | | | | | | |
| 223.12 | 40.03 | 182 | 2.1 | H | -70.48 | 0.15 | 0.00 | -70.63 | -13.00 | -57.63 |
| 223.12 | 30.34 | 110 | 1.8 | V | -77.25 | 0.15 | 0.00 | -77.40 | -13.00 | -64.40 |
| 1696.60 | 50.68 | 235 | 1.9 | H | -61.96 | 2.37 | 12.50 | -51.83 | -13.00 | -38.83 |
| 1696.60 | 45.03 | 181 | 2.0 | V | -65.70 | 2.37 | 12.50 | -55.57 | -13.00 | -42.57 |
| 2544.90 | 38.98 | 125 | 2.2 | H | -70.60 | 2.81 | 12.80 | -60.61 | -13.00 | -47.61 |
| 2544.90 | 31.79 | 97 | 2.2 | V | -77.01 | 2.81 | 12.80 | -67.02 | -13.00 | -54.02 |

LTE Band 7

| Frequency | Receiver Reading | Turn table Angle | RX Antenna | | Substituted | | | Absolute Level | Result | |
|--------------------------|------------------|------------------|------------|-------|-------------|-------|--------------|----------------|--------|--------|
| | | | Height | Polar | SG Level | Cable | Antenna Gain | | Limit | Margin |
| (MHz) | (dBμV) | Degree | (m) | (H/V) | (dBm) | (dB) | (dB) | (dBm) | (dBm) | (dB) |
| LTE BAND 7 Channel 20775 | | | | | | | | | | |
| 223.12 | 38.38 | 183 | 2.0 | H | -72.13 | 0.15 | 0.00 | -72.28 | -25.00 | -47.28 |
| 223.12 | 32.23 | 346 | 1.0 | V | -75.35 | 0.15 | 0.00 | -75.50 | -25.00 | -50.50 |
| 5005.00 | 65.95 | 254 | 1.5 | H | -43.29 | 2.79 | 12.70 | -33.38 | -25.00 | -8.38 |
| 5005.00 | 59.98 | 297 | 1.4 | V | -48.78 | 2.79 | 12.70 | -38.87 | -25.00 | -13.87 |
| 7507.50 | 53.58 | 282 | 1.6 | H | -52.96 | 3.12 | 11.50 | -44.58 | -25.00 | -19.58 |
| 7507.50 | 44.73 | 273 | 1.7 | V | -60.72 | 3.12 | 11.50 | -52.34 | -25.00 | -27.34 |
| LTE BAND 7 Channel 21100 | | | | | | | | | | |
| 223.12 | 38.16 | 212 | 1.5 | H | -72.35 | 0.15 | 0.00 | -72.50 | -25.00 | -47.50 |
| 223.12 | 31.45 | 109 | 2.1 | V | -76.14 | 0.15 | 0.00 | -76.29 | -25.00 | -51.29 |
| 5070.00 | 58.92 | 43 | 2.0 | H | -50.30 | 2.37 | 12.50 | -40.17 | -25.00 | -15.17 |
| 5070.00 | 53.37 | 339 | 2.1 | V | -55.40 | 2.37 | 12.50 | -45.27 | -25.00 | -20.27 |
| 7605.00 | 46.95 | 137 | 1.3 | H | -59.59 | 3.12 | 11.50 | -51.21 | -25.00 | -26.21 |
| 7605.00 | 37.33 | 332 | 1.2 | V | -68.10 | 3.12 | 11.50 | -59.72 | -25.00 | -34.72 |
| LTE BAND 7 Channel 21425 | | | | | | | | | | |
| 223.12 | 38.55 | 127 | 2.1 | H | -71.96 | 0.15 | 0.00 | -72.11 | -25.00 | -47.11 |
| 223.12 | 32.32 | 144 | 2.1 | V | -75.27 | 0.15 | 0.00 | -75.42 | -25.00 | -50.42 |
| 5135.00 | 52.15 | 295 | 1.2 | H | -57.26 | 2.37 | 12.50 | -47.13 | -25.00 | -22.13 |
| 5135.00 | 45.85 | 238 | 1.4 | V | -62.92 | 2.37 | 12.50 | -52.79 | -25.00 | -27.79 |
| 7702.50 | 40.83 | 287 | 1.8 | H | -64.40 | 3.12 | 11.50 | -56.02 | -25.00 | -31.02 |
| 7702.50 | 29.80 | 283 | 1.6 | V | -75.09 | 3.12 | 11.50 | -66.71 | -25.00 | -41.71 |

LTE Band 12

| Frequency | Receiver Reading | Turn table Angle | RX Antenna | | Substituted | | | Absolute Level | Result | |
|---------------------------|------------------|------------------|------------|-------|-------------|-------|--------------|----------------|--------|--------|
| | | | Height | Polar | SG Level | Cable | Antenna Gain | | Limit | Margin |
| (MHz) | (dBμV) | Degree | (m) | (H/V) | (dBm) | (dB) | (dB) | (dBm) | (dBm) | (dB) |
| LTE BAND 12 Channel 23017 | | | | | | | | | | |
| 223.12 | 38.89 | 11 | 1.5 | H | -71.62 | 0.15 | 0.00 | -71.77 | -25.00 | -46.77 |
| 223.12 | 30.75 | 262 | 1.5 | V | -76.83 | 0.15 | 0.00 | -76.98 | -25.00 | -51.98 |
| 5005.00 | 65.95 | 56 | 2.2 | H | -43.33 | 2.79 | 12.70 | -33.42 | -25.00 | -8.42 |
| 5005.00 | 59.98 | 18 | 1.6 | V | -48.78 | 2.79 | 12.70 | -38.87 | -25.00 | -13.87 |
| 7507.50 | 53.58 | 273 | 2.1 | H | -52.96 | 3.12 | 11.50 | -44.58 | -25.00 | -19.58 |
| 7507.50 | 44.73 | 221 | 1.6 | V | -60.72 | 3.12 | 11.50 | -52.34 | -25.00 | -27.34 |
| LTE BAND 12 Channel 23095 | | | | | | | | | | |
| 223.12 | 38.38 | 78 | 1.2 | H | -72.13 | 0.15 | 0.00 | -72.28 | -25.00 | -47.28 |
| 223.12 | 31.66 | 236 | 1.3 | V | -75.93 | 0.15 | 0.00 | -76.08 | -25.00 | -51.08 |
| 5070.00 | 58.55 | 40 | 1.1 | H | -50.74 | 2.37 | 12.50 | -40.61 | -25.00 | -15.61 |
| 5070.00 | 53.62 | 308 | 2.1 | V | -55.15 | 2.37 | 12.50 | -45.02 | -25.00 | -20.02 |
| 7605.00 | 46.11 | 341 | 1.8 | H | -60.43 | 3.12 | 11.50 | -52.05 | -25.00 | -27.05 |
| 7605.00 | 36.77 | 132 | 1.7 | V | -68.66 | 3.12 | 11.50 | -60.28 | -25.00 | -35.28 |
| LTE BAND 12 Channel 23173 | | | | | | | | | | |
| 223.12 | 38.25 | 161 | 2.0 | H | -72.26 | 0.15 | 0.00 | -72.41 | -25.00 | -47.41 |
| 223.12 | 30.80 | 114 | 2.0 | V | -76.79 | 0.15 | 0.00 | -76.94 | -25.00 | -51.94 |
| 5135.00 | 52.14 | 104 | 2.1 | H | -57.30 | 2.37 | 12.50 | -47.17 | -25.00 | -22.17 |
| 5135.00 | 46.61 | 119 | 1.3 | V | -62.16 | 2.37 | 12.50 | -52.03 | -25.00 | -27.03 |
| 7702.50 | 39.57 | 270 | 2.0 | H | -65.66 | 3.12 | 11.50 | -57.28 | -25.00 | -32.28 |
| 7702.50 | 28.87 | 278 | 1.3 | V | -76.02 | 3.12 | 11.50 | -67.64 | -25.00 | -42.64 |

LTE Band 17

| Frequency | Receiver Reading | Turn table Angle | RX Antenna | | Substituted | | | Absolute Level | Result | |
|---------------------------|------------------|------------------|------------|-------|-------------|-------|--------------|----------------|--------|--------|
| | | | Height | Polar | SG Level | Cable | Antenna Gain | | Limit | Margin |
| (MHz) | (dBμV) | Degree | (m) | (H/V) | (dBm) | (dB) | (dB) | (dBm) | (dBm) | (dB) |
| LTE BAND 17 Channel 23755 | | | | | | | | | | |
| 223.12 | 38.91 | 131 | 1.3 | H | -71.60 | 0.15 | 0.00 | -71.75 | -13.00 | -58.75 |
| 223.12 | 30.43 | 104 | 1.5 | V | -77.12 | 0.15 | 0.00 | -77.27 | -13.00 | -64.27 |
| 1413.00 | 65.95 | 52 | 2.0 | H | -44.29 | 2.79 | 12.70 | -34.38 | -13.00 | -21.38 |
| 1413.00 | 59.98 | 267 | 1.1 | V | -51.77 | 2.79 | 12.70 | -41.86 | -13.00 | -28.86 |
| 2119.50 | 53.58 | 13 | 1.7 | H | -58.96 | 3.12 | 11.50 | -50.58 | -13.00 | -37.58 |
| 2119.50 | 44.73 | 356 | 1.7 | V | -68.70 | 3.12 | 11.50 | -60.32 | -13.00 | -47.32 |
| LTE BAND 17 Channel 23790 | | | | | | | | | | |
| 223.12 | 37.95 | 204 | 1.2 | H | -72.56 | 0.15 | 0.00 | -72.71 | -13.00 | -59.71 |
| 223.12 | 29.76 | 201 | 1.7 | V | -77.79 | 0.15 | 0.00 | -77.94 | -13.00 | -64.94 |
| 1420.00 | 58.04 | 289 | 1.5 | H | -52.20 | 2.37 | 12.50 | -42.07 | -13.00 | -29.07 |
| 1420.00 | 52.87 | 58 | 1.2 | V | -58.87 | 2.37 | 12.50 | -48.74 | -13.00 | -35.74 |
| 2130.00 | 46.41 | 303 | 1.8 | H | -66.13 | 3.12 | 11.50 | -57.75 | -13.00 | -44.75 |
| 2130.00 | 37.77 | 342 | 1.7 | V | -75.65 | 3.12 | 11.50 | -67.27 | -13.00 | -54.27 |
| LTE BAND 17 Channel 23825 | | | | | | | | | | |
| 223.12 | 37.33 | 28 | 1.0 | H | -73.18 | 0.15 | 0.00 | -73.33 | -13.00 | -60.33 |
| 223.12 | 29.47 | 146 | 1.2 | V | -78.12 | 0.15 | 0.00 | -78.27 | -13.00 | -65.27 |
| 1427.00 | 50.08 | 116 | 1.1 | H | -60.16 | 2.37 | 12.50 | -50.03 | -13.00 | -37.03 |
| 1427.00 | 46.53 | 107 | 1.7 | V | -65.24 | 2.37 | 12.50 | -55.11 | -13.00 | -42.11 |
| 2140.50 | 39.52 | 10 | 1.3 | H | -73.02 | 3.12 | 11.50 | -64.64 | -13.00 | -51.64 |
| 2140.50 | 30.15 | 155 | 1.4 | V | -83.28 | 3.12 | 11.50 | -74.90 | -13.00 | -61.90 |

Note: 1) Absolute Level = SG Level - Cable loss + Antenna Gain

2) Margin = Absolute Level - Limit

13 Band Edge Measurement

| | |
|-------------------|--|
| Test Requirement: | FCC Part 2.1051, 22.917(a), 24.238(a), 27.53(h), 27.53(m)(4) |
| Test Method: | TIA/EIA-603-D:2010 KDB971168 D01 v03 |
| Test Mode: | TX transmitting |

13.1 EUT Operation

Operating Environment :

| | |
|-----------------------|-----------|
| Temperature: | 23.5 °C |
| Humidity: | 52.3 % RH |
| Atmospheric Pressure: | 101.3kPa |

13.2 Test Procedure

The RF output of the transmitter was connected to the input of the spectrum analyzer through sufficient attenuation.

According to FCC Part 22.917(a), the power of any emissions outside of the authorized operating frequency ranges must be attenuated below the TX transmitting power (P) by a factor of at least $43 + 10 \log(P)$ dB.

According to FCC Part 24.238(a), the power of any emissions outside of the authorized operating frequency ranges must be attenuated below the TX transmitting power (P) by a factor of at least $43 + 10 \log(P)$ dB.

According to FCC Part 27.53(h), Except as otherwise specified below, for operations in the 1695-1710 MHz, 1710-1755 MHz, 1755-1780 MHz, 1915-1920 MHz, 1995-2000 MHz, 2000-2020 MHz, 2110-2155 MHz, 2155-2180 MHz, and 2180-2200 bands, the power of any emission outside a licensee's frequency block shall be attenuated below the transmitter power (P) in watts by at least $43 + 10 \log_{10}(P)$ dB.

According to FCC Part 27.53(m)(4), For mobile digital stations, the attenuation factor shall be not less than $40 + 10 \log(P)$ dB on all frequencies between the channel edge and 5 megahertz from the channel edge, $43 + 10 \log(P)$ dB on all frequencies between 5 megahertz and X megahertz from the channel edge, and $55 + 10 \log(P)$ dB on all frequencies more than X megahertz from the channel edge, where X is the greater of 6 megahertz or the actual emission bandwidth as defined in paragraph (m)(6) of this section. In addition, the attenuation factor shall not be less than $43 + 10 \log(P)$ dB on all frequencies between 2490.5 MHz and 2496 MHz and $55 + 10 \log(P)$ dB at or below 2490.5 MHz. Mobile Satellite Service licensees operating on frequencies below 2495 MHz may also submit a documented interference complaint against BRS licensees operating on channel BRS Channel 1 on the same terms and conditions as adjacent channel BRS or EBS licensees.

The center of the spectrum analyzer was set to block edge frequency
Waltek Services (Shenzhen) Co.,Ltd.
<http://www.waltek.com.cn>

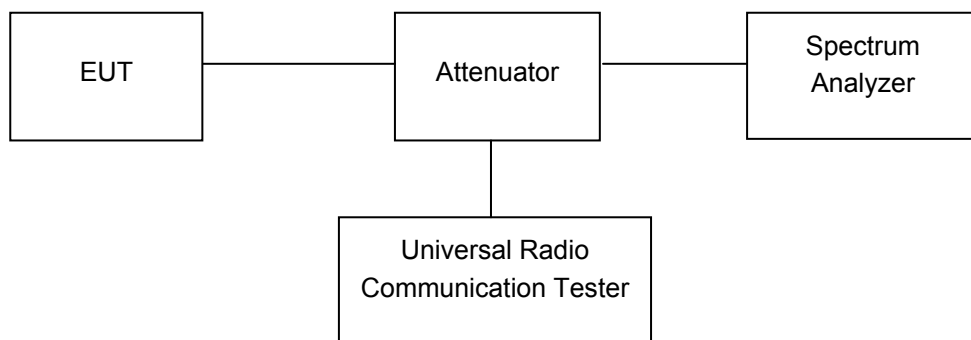

13.3 Test Result

PASS

LTE Band

Please refer to the Annex E. LTE Band Edge for LTE Band 2/4/5/7/12/17.

14 FREQUENCY STABILITY

| | |
|-------------------|--|
| Test Requirement: | FCC Part 2.1055, 22.355, 24.235, 27.5(h),27.54 |
| Test Method: | TIA/EIA-603-D:2010 KDB971168 D01 v03 |
| Test Mode: | TX transmitting |

14.1 EUT Operation

| | |
|-------------------------|-----------|
| Operating Environment : | |
| Temperature: | 22.9 °C |
| Humidity: | 52.0 % RH |
| Atmospheric Pressure: | 101.3kPa |

14.2 Test Procedure

Frequency Stability vs. Temperature: The equipment under test was connected to an external DC power supply and the RF output was connected to communication test set via feed-through attenuators. The EUT was placed inside the temperature chamber. The DC leads and RF output cable exited the chamber through an opening made for the purpose.

After the temperature stabilized for approximately 20 minutes, the frequency output was recorded from the communication test set.

Frequency Stability vs. Voltage: For hand carried, battery powered equipment; reduce primary supply voltage to the battery operating end point which shall be specified by the manufacturer.

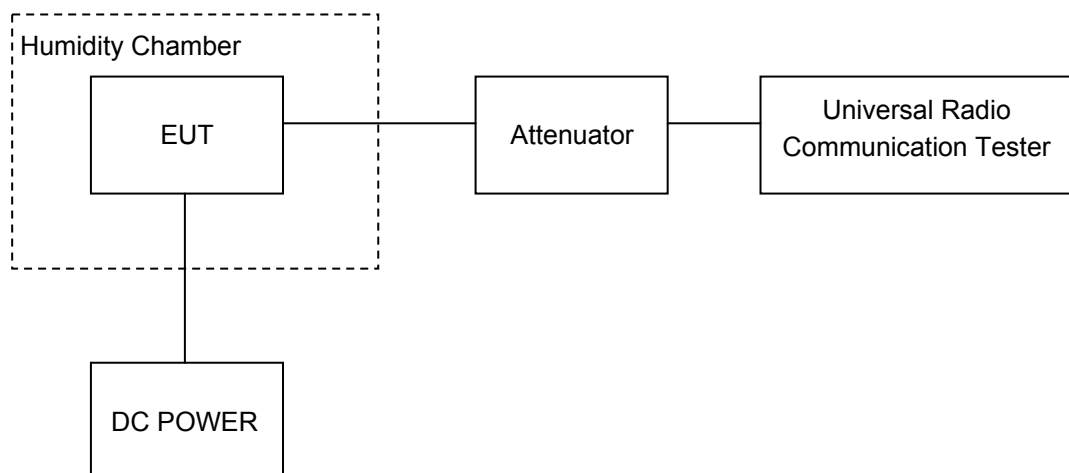

14.3 Test Result

LTE Band 2

| Test Frequency:1880.0MHz QPSK 1.4MHz | | | | |
|--------------------------------------|--------------------|----------------------|-----------------------|-------------|
| Temperature (°C) | Power Supply (VDC) | Frequency Error (Hz) | Frequency Error (ppm) | Limit (ppm) |
| 50 | 3.8 | -9 | -0.0052 | 2.5 |
| 40 | | -3 | -0.0017 | 2.5 |
| 30 | | 2 | 0.0012 | 2.5 |
| 20 | | -3 | -0.0017 | 2.5 |
| 10 | | -7 | -0.0040 | 2.5 |
| 0 | | 5 | 0.0029 | 2.5 |
| -10 | | -3 | -0.0017 | 2.5 |
| -20 | | -2 | -0.0012 | 2.5 |
| -30 | | 5 | 0.0029 | 2.5 |
| 20 | | 3.3 | -5 | -0.0029 |
| 20 | 4.2 | -12 | -0.0069 | 2.5 |

| T Test Frequency:1880.0MHz 16QAM 1.4MHz | | | | |
|---|--------------------|----------------------|-----------------------|-------------|
| Temperature (°C) | Power Supply (VDC) | Frequency Error (Hz) | Frequency Error (ppm) | Limit (ppm) |
| 50 | 3.8 | 3 | 0.0016 | 2.5 |
| 40 | | 11 | 0.0059 | 2.5 |
| 30 | | 3 | 0.0016 | 2.5 |
| 20 | | 7 | 0.0037 | 2.5 |
| 10 | | 5 | 0.0027 | 2.5 |
| 0 | | 8 | 0.0043 | 2.5 |
| -10 | | 3 | 0.0016 | 2.5 |
| -20 | | 11 | 0.0059 | 2.5 |
| -30 | | 14 | 0.0074 | 2.5 |
| 20 | | 3.3 | 0 | 0.0000 |
| 20 | 4.2 | 0 | 0.0000 | 2.5 |

LTE Band 2

| Test Frequency:1880.0MHz QPSK 3MHz | | | | |
|------------------------------------|--------------------|----------------------|-----------------------|-------------|
| Temperature (°C) | Power Supply (VDC) | Frequency Error (Hz) | Frequency Error (ppm) | Limit (ppm) |
| 50 | 3.8 | -5 | -0.0029 | 2.5 |
| 40 | | -8 | -0.0046 | 2.5 |
| 30 | | -13 | -0.0075 | 2.5 |
| 20 | | -5 | -0.0029 | 2.5 |
| 10 | | -9 | -0.0052 | 2.5 |
| 0 | | -4 | -0.0023 | 2.5 |
| -10 | | 0 | 0.0000 | 2.5 |
| -20 | | 1 | 0.0006 | 2.5 |
| -30 | | -11 | -0.0063 | 2.5 |
| 20 | | 3.3 | 0 | 0.0000 |
| 20 | 4.2 | -12 | -0.0069 | 2.5 |

| Test Frequency:1880.0MHz 16QAM 3MHz | | | | |
|-------------------------------------|--------------------|----------------------|-----------------------|-------------|
| Temperature (°C) | Power Supply (VDC) | Frequency Error (Hz) | Frequency Error (ppm) | Limit (ppm) |
| 50 | 3.8 | 3 | 0.0017 | 2.5 |
| 40 | | -9 | -0.0052 | 2.5 |
| 30 | | -13 | -0.0075 | 2.5 |
| 20 | | -6 | -0.0035 | 2.5 |
| 10 | | -14 | -0.0081 | 2.5 |
| 0 | | -5 | -0.0029 | 2.5 |
| -10 | | -12 | -0.0069 | 2.5 |
| -20 | | -4 | -0.0023 | 2.5 |
| -30 | | -9 | -0.0052 | 2.5 |
| 20 | | 3.3 | -15 | -0.0087 |
| 20 | 4.2 | -14 | -0.0081 | 2.5 |

LTE Band 2

| Test Frequency:1880.0MHz QPSK 5MHz | | | | |
|------------------------------------|--------------------|----------------------|-----------------------|-------------|
| Temperature (°C) | Power Supply (VDC) | Frequency Error (Hz) | Frequency Error (ppm) | Limit (ppm) |
| 50 | 3.8 | 5 | 0.0027 | 2.5 |
| 40 | | 9 | 0.0048 | 2.5 |
| 30 | | 9 | 0.0048 | 2.5 |
| 20 | | 8 | 0.0037 | 2.5 |
| 10 | | 10 | 0.0053 | 2.5 |
| 0 | | 1 | 0.0005 | 2.5 |
| -10 | | -2 | -0.0011 | 2.5 |
| -20 | | 2 | 0.0011 | 2.5 |
| -30 | | 14 | 0.0074 | 2.5 |
| 20 | | 3.3 | -1 | -0.0005 |
| 20 | 4.2 | 1 | 0.0005 | 2.5 |

| Test Frequency:1880.0MHz 16QAM 5MHz | | | | |
|-------------------------------------|--------------------|----------------------|-----------------------|-------------|
| Temperature (°C) | Power Supply (VDC) | Frequency Error (Hz) | Frequency Error (ppm) | Limit (ppm) |
| 50 | 3.8 | 3 | 0.0016 | 2.5 |
| 40 | | -4 | -0.0021 | 2.5 |
| 30 | | -1 | -0.0005 | 2.5 |
| 20 | | -3 | -0.0021 | 2.5 |
| 10 | | 1 | 0.0005 | 2.5 |
| 0 | | -4 | -0.0021 | 2.5 |
| -10 | | -6 | -0.0032 | 2.5 |
| -20 | | 4 | 0.0021 | 2.5 |
| -30 | | 1 | 0.0005 | 2.5 |
| 20 | | 3.3 | -12 | -0.0064 |
| 20 | 4.2 | 5 | 0.0027 | 2.5 |

LTE Band 2

| Test Frequency:1880.0MHz QPSK 10MHz | | | | |
|-------------------------------------|--------------------|----------------------|-----------------------|-------------|
| Temperature (°C) | Power Supply (VDC) | Frequency Error (Hz) | Frequency Error (ppm) | Limit (ppm) |
| 50 | 3.8 | 4 | 0.0021 | 2.5 |
| 40 | | -6 | -0.0032 | 2.5 |
| 30 | | 0 | 0.0000 | 2.5 |
| 20 | | 4 | 0.0011 | 2.5 |
| 10 | | 10 | 0.0053 | 2.5 |
| 0 | | -4 | -0.0021 | 2.5 |
| -10 | | 5 | 0.0027 | 2.5 |
| -20 | | 2 | 0.0011 | 2.5 |
| -30 | | 8 | 0.0043 | 2.5 |
| 20 | | 3.3 | -4 | -0.0021 |
| 20 | 4.2 | 4 | 0.0021 | 2.5 |

| Test Frequency:1880.0MHz 16QAM 10MHz | | | | |
|--------------------------------------|--------------------|----------------------|-----------------------|-------------|
| Temperature (°C) | Power Supply (VDC) | Frequency Error (Hz) | Frequency Error (ppm) | Limit (ppm) |
| 50 | 3.8 | 17 | 0.0098 | 2.5 |
| 40 | | 5 | 0.0029 | 2.5 |
| 30 | | 7 | 0.0040 | 2.5 |
| 20 | | 9 | 0.0052 | 2.5 |
| 10 | | 11 | 0.0063 | 2.5 |
| 0 | | 8 | 0.0046 | 2.5 |
| -10 | | 10 | 0.0058 | 2.5 |
| -20 | | 5 | 0.0029 | 2.5 |
| -30 | | 9 | 0.0052 | 2.5 |
| 20 | | 3.3 | 9 | 0.0052 |
| 20 | 4.2 | 9 | 0.0052 | 2.5 |

LTE Band 2

| Test Frequency:1880.0MHz QPSK 15MHz | | | | |
|-------------------------------------|--------------------|----------------------|-----------------------|-------------|
| Temperature (°C) | Power Supply (VDC) | Frequency Error (Hz) | Frequency Error (ppm) | Limit (ppm) |
| 50 | 3.8 | 9 | 0.0048 | 2.5 |
| 40 | | -2 | -0.0011 | 2.5 |
| 30 | | 3 | 0.0016 | 2.5 |
| 20 | | 2 | 0.0011 | 2.5 |
| 10 | | -3 | -0.0016 | 2.5 |
| 0 | | 10 | 0.0053 | 2.5 |
| -10 | | 2 | 0.0011 | 2.5 |
| -20 | | 4 | 0.0021 | 2.5 |
| -30 | | 5 | 0.0027 | 2.5 |
| 20 | | 3.3 | 4 | 0.0021 |
| 20 | 4.2 | -4 | -0.0021 | 2.5 |

| Test Frequency:1880.0MHz 16QAM 15MHz | | | | |
|--------------------------------------|--------------------|----------------------|-----------------------|-------------|
| Temperature (°C) | Power Supply (VDC) | Frequency Error (Hz) | Frequency Error (ppm) | Limit (ppm) |
| 50 | 3.8 | -7 | -0.0037 | 2.5 |
| 40 | | -1 | -0.0005 | 2.5 |
| 30 | | -4 | -0.0021 | 2.5 |
| 20 | | 1 | 0.0005 | 2.5 |
| 10 | | -3 | -0.0016 | 2.5 |
| 0 | | 3 | 0.0016 | 2.5 |
| -10 | | 0 | 0.0000 | 2.5 |
| -20 | | -6 | -0.0032 | 2.5 |
| -30 | | -3 | -0.0016 | 2.5 |
| 20 | | 3.3 | 6 | 0.0032 |
| 20 | 4.2 | -8 | -0.0043 | 2.5 |

LTE Band 2

| Test Frequency:1880.0MHz QPSK 20MHz | | | | |
|-------------------------------------|--------------------|----------------------|-----------------------|-------------|
| Temperature (°C) | Power Supply (VDC) | Frequency Error (Hz) | Frequency Error (ppm) | Limit (ppm) |
| 50 | 3.8 | 0 | 0.0000 | 2.5 |
| 40 | | 12 | 0.0069 | 2.5 |
| 30 | | 13 | 0.0075 | 2.5 |
| 20 | | 8 | 0.0046 | 2.5 |
| 10 | | 10 | 0.0058 | 2.5 |
| 0 | | 3 | 0.0017 | 2.5 |
| -10 | | 1 | 0.0006 | 2.5 |
| -20 | | 11 | 0.0063 | 2.5 |
| -30 | | 13 | 0.0075 | 2.5 |
| 20 | | 3.3 | -1 | -0.0006 |
| 20 | 4.2 | 9 | 0.0052 | 2.5 |

| Test Frequency:1880.0MHz 16QAM 20MHz | | | | |
|--------------------------------------|--------------------|----------------------|-----------------------|-------------|
| Temperature (°C) | Power Supply (VDC) | Frequency Error (Hz) | Frequency Error (ppm) | Limit (ppm) |
| 50 | 3.8 | 7 | 0.0037 | 2.5 |
| 40 | | -3 | -0.0016 | 2.5 |
| 30 | | 7 | 0.0037 | 2.5 |
| 20 | | 0 | 0.0000 | 2.5 |
| 10 | | 5 | 0.0027 | 2.5 |
| 0 | | -4 | -0.0021 | 2.5 |
| -10 | | -3 | -0.0016 | 2.5 |
| -20 | | 8 | 0.0043 | 2.5 |
| -30 | | 1 | 0.0005 | 2.5 |
| 20 | | 3.3 | 8 | 0.0043 |
| 20 | 4.2 | 5 | 0.0027 | 2.5 |

LTE Band 4

| Test Frequency:1732.5MHz QPSK 1.4MHz | | | | |
|--------------------------------------|--------------------|----------------------|-----------------------|-------------|
| Temperature (°C) | Power Supply (VDC) | Frequency Error (Hz) | Frequency Error (ppm) | Limit (ppm) |
| 50 | 3.8 | -6 | -0.0035 | 2.5 |
| 40 | | -6 | -0.0035 | 2.5 |
| 30 | | 5 | 0.0029 | 2.5 |
| 20 | | 2 | 0.0010 | 2.5 |
| 10 | | 2 | 0.0012 | 2.5 |
| 0 | | 3 | 0.0017 | 2.5 |
| -10 | | -6 | -0.0035 | 2.5 |
| -20 | | 0 | 0.0000 | 2.5 |
| -30 | | 11 | 0.0063 | 2.5 |
| 20 | | 3.3 | 10 | 0.0058 |
| 20 | 4.2 | -6 | -0.0035 | 2.5 |

| Test Frequency:1732.5MHz 16QAM 1.4MHz | | | | |
|---------------------------------------|--------------------|----------------------|-----------------------|-------------|
| Temperature (°C) | Power Supply (VDC) | Frequency Error (Hz) | Frequency Error (ppm) | Limit (ppm) |
| 50 | 3.8 | 1 | 0.0006 | 2.5 |
| 40 | | 14 | 0.0081 | 2.5 |
| 30 | | 12 | 0.0069 | 2.5 |
| 20 | | 7 | 0.0040 | 2.5 |
| 10 | | 13 | 0.0075 | 2.5 |
| 0 | | 11 | 0.0063 | 2.5 |
| -10 | | 14 | 0.0081 | 2.5 |
| -20 | | 2 | 0.0012 | 2.5 |
| -30 | | 10 | 0.0058 | 2.5 |
| 20 | | 3.3 | 4 | 0.0023 |
| 20 | 4.2 | 6 | 0.0035 | 2.5 |

LTE Band 4

| Test Frequency:1732.5MHz QPSK 3MHz | | | | |
|------------------------------------|--------------------|----------------------|-----------------------|-------------|
| Temperature (°C) | Power Supply (VDC) | Frequency Error (Hz) | Frequency Error (ppm) | Limit (ppm) |
| 50 | 3.8 | 2 | 0.0012 | 2.5 |
| 40 | | -1 | -0.0006 | 2.5 |
| 30 | | 1 | 0.0006 | 2.5 |
| 20 | | 4 | 0.0023 | 2.5 |
| 10 | | -1 | -0.0006 | 2.5 |
| 0 | | -3 | -0.0017 | 2.5 |
| -10 | | -2 | -0.0012 | 2.5 |
| -20 | | 7 | 0.0040 | 2.5 |
| -30 | | 4 | 0.0023 | 2.5 |
| 20 | | 3.3 | -4 | -0.0023 |
| 20 | 4.2 | -3 | -0.0017 | 2.5 |

| Test Frequency:1732.5MHz 16QAM 3MHz | | | | |
|-------------------------------------|--------------------|----------------------|-----------------------|-------------|
| Temperature (°C) | Power Supply (VDC) | Frequency Error (Hz) | Frequency Error (ppm) | Limit (ppm) |
| 50 | 3.8 | 9 | 0.0052 | 2.5 |
| 40 | | 9 | 0.0052 | 2.5 |
| 30 | | -6 | -0.0035 | 2.5 |
| 20 | | 2 | 0.0012 | 2.5 |
| 10 | | 4 | 0.0023 | 2.5 |
| 0 | | 11 | 0.0063 | 2.5 |
| -10 | | 0 | 0.0000 | 2.5 |
| -20 | | 9 | 0.0052 | 2.5 |
| -30 | | -2 | -0.0012 | 2.5 |
| 20 | | 3.3 | 3 | 0.0017 |
| 20 | 4.2 | 2 | 0.0012 | 2.5 |

LTE Band 4

| Test Frequency:1732.5MHz QPSK 5MHz | | | | |
|------------------------------------|--------------------|----------------------|-----------------------|-------------|
| Temperature (°C) | Power Supply (VDC) | Frequency Error (Hz) | Frequency Error (ppm) | Limit (ppm) |
| 50 | 3.8 | -3 | -0.0017 | 2.5 |
| 40 | | -7 | -0.0040 | 2.5 |
| 30 | | 2 | 0.0012 | 2.5 |
| 20 | | 2 | 0.0012 | 2.5 |
| 10 | | -6 | -0.0035 | 2.5 |
| 0 | | -6 | -0.0035 | 2.5 |
| -10 | | -7 | -0.0040 | 2.5 |
| -20 | | -2 | -0.0012 | 2.5 |
| -30 | | -2 | -0.0012 | 2.5 |
| 20 | | 3.3 | 5 | 0.0029 |
| 20 | 4.2 | 10 | 0.0058 | 2.5 |

| Test Frequency:1732.5MHz 16QAM 5MHz | | | | |
|-------------------------------------|--------------------|----------------------|-----------------------|-------------|
| Temperature (°C) | Power Supply (VDC) | Frequency Error (Hz) | Frequency Error (ppm) | Limit (ppm) |
| 50 | 3.8 | 0 | 0.0000 | 2.5 |
| 40 | | 9 | 0.0052 | 2.5 |
| 30 | | 9 | 0.0052 | 2.5 |
| 20 | | 5 | 0.0029 | 2.5 |
| 10 | | 4 | 0.0023 | 2.5 |
| 0 | | 6 | 0.0035 | 2.5 |
| -10 | | 6 | 0.0035 | 2.5 |
| -20 | | 5 | 0.0029 | 2.5 |
| -30 | | 9 | 0.0052 | 2.5 |
| 20 | | 3.3 | -2 | -0.0012 |
| 20 | 4.2 | 12 | 0.0069 | 2.5 |

LTE Band 4

| Test Frequency:1732.5MHz QPSK 10MHz | | | | |
|-------------------------------------|--------------------|----------------------|-----------------------|-------------|
| Temperature (°C) | Power Supply (VDC) | Frequency Error (Hz) | Frequency Error (ppm) | Limit (ppm) |
| 50 | 3.8 | -6 | -0.0035 | 2.5 |
| 40 | | -3 | -0.0017 | 2.5 |
| 30 | | -4 | -0.0023 | 2.5 |
| 20 | | 3 | 0.0017 | 2.5 |
| 10 | | 7 | 0.0040 | 2.5 |
| 0 | | -2 | -0.0012 | 2.5 |
| -10 | | 3 | 0.0017 | 2.5 |
| -20 | | -2 | -0.0012 | 2.5 |
| -30 | | 5 | 0.0029 | 2.5 |
| 20 | | 3.3 | -1 | -0.0006 |
| 20 | 4.2 | 0 | 0.0000 | 2.5 |

| Test Frequency:1732.5MHz 16QAM 10MHz | | | | |
|--------------------------------------|--------------------|----------------------|-----------------------|-------------|
| Temperature (°C) | Power Supply (VDC) | Frequency Error (Hz) | Frequency Error (ppm) | Limit (ppm) |
| 50 | 3.8 | 11 | 0.0063 | 2.5 |
| 40 | | 2 | 0.0012 | 2.5 |
| 30 | | 11 | 0.0063 | 2.5 |
| 20 | | 3 | 0.0017 | 2.5 |
| 10 | | 2 | 0.0012 | 2.5 |
| 0 | | -1 | -0.0006 | 2.5 |
| -10 | | 12 | 0.0069 | 2.5 |
| -20 | | -5 | -0.0029 | 2.5 |
| -30 | | 11 | 0.0063 | 2.5 |
| 20 | | 3.3 | -4 | -0.0023 |
| 20 | 4.2 | 8 | 0.0046 | 2.5 |

LTE Band 4

| Test Frequency:1732.5MHz QPSK 15MHz | | | | |
|-------------------------------------|--------------------|----------------------|-----------------------|-------------|
| Temperature (°C) | Power Supply (VDC) | Frequency Error (Hz) | Frequency Error (ppm) | Limit (ppm) |
| 50 | 3.8 | -3 | -0.0016 | 2.5 |
| 40 | | 4 | 0.0021 | 2.5 |
| 30 | | 3 | 0.0016 | 2.5 |
| 20 | | 4 | 0.0021 | 2.5 |
| 10 | | -3 | -0.0016 | 2.5 |
| 0 | | 0 | 0.0000 | 2.5 |
| -10 | | -1 | -0.0005 | 2.5 |
| -20 | | 9 | 0.0048 | 2.5 |
| -30 | | 9 | 0.0048 | 2.5 |
| 20 | | 3.3 | 8 | 0.0043 |
| 20 | 4.2 | 8 | 0.0043 | 2.5 |

| Test Frequency:1732.5MHz 16QAM 15MHz | | | | |
|--------------------------------------|--------------------|----------------------|-----------------------|-------------|
| Temperature (°C) | Power Supply (VDC) | Frequency Error (Hz) | Frequency Error (ppm) | Limit (ppm) |
| 50 | 3.8 | 20 | 0.0106 | 2.5 |
| 40 | | 20 | 0.0106 | 2.5 |
| 30 | | 11 | 0.0059 | 2.5 |
| 20 | | 14 | 0.0074 | 2.5 |
| 10 | | 9 | 0.0048 | 2.5 |
| 0 | | 8 | 0.0043 | 2.5 |
| -10 | | 21 | 0.0112 | 2.5 |
| -20 | | 17 | 0.0090 | 2.5 |
| -30 | | 7 | 0.0037 | 2.5 |
| 20 | | 3.3 | 21 | 0.0112 |
| 20 | 4.2 | 9 | 0.0048 | 2.5 |

LTE Band 4

| Test Frequency:1732.5MHz QPSK 20MHz | | | | |
|-------------------------------------|--------------------|----------------------|-----------------------|-------------|
| Temperature (°C) | Power Supply (VDC) | Frequency Error (Hz) | Frequency Error (ppm) | Limit (ppm) |
| 50 | 3.8 | 21 | 0.0112 | 2.5 |
| 40 | | 13 | 0.0069 | 2.5 |
| 30 | | 5 | 0.0027 | 2.5 |
| 20 | | 13 | 0.0069 | 2.5 |
| 10 | | 6 | 0.0032 | 2.5 |
| 0 | | 7 | 0.0037 | 2.5 |
| -10 | | 7 | 0.0037 | 2.5 |
| -20 | | 9 | 0.0048 | 2.5 |
| -30 | | 10 | 0.0053 | 2.5 |
| 20 | | 3.3 | 20 | 0.0106 |
| 20 | 4.2 | 21 | 0.0112 | 2.5 |

| Test Frequency:1732.5MHz 16QAM 20MHz | | | | |
|--------------------------------------|--------------------|----------------------|-----------------------|-------------|
| Temperature (°C) | Power Supply (VDC) | Frequency Error (Hz) | Frequency Error (ppm) | Limit (ppm) |
| 50 | 3.8 | 2 | 0.0011 | 2.5 |
| 40 | | 8 | 0.0043 | 2.5 |
| 30 | | -4 | -0.0021 | 2.5 |
| 20 | | 2 | 0.0011 | 2.5 |
| 10 | | 6 | 0.0032 | 2.5 |
| 0 | | -2 | -0.0011 | 2.5 |
| -10 | | 11 | 0.0059 | 2.5 |
| -20 | | 6 | 0.0032 | 2.5 |
| -30 | | -1 | -0.0005 | 2.5 |
| 20 | | 3.3 | 6 | 0.0032 |
| 20 | 4.2 | 8 | 0.0043 | 2.5 |

LTE Band 5

| Test Frequency:836.5MHz QPSK 1.4MHz | | | | |
|-------------------------------------|--------------------|----------------------|-----------------------|-------------|
| Temperature (°C) | Power Supply (VDC) | Frequency Error (Hz) | Frequency Error (ppm) | Limit (ppm) |
| 50 | 3.8 | 3 | 0.0016 | 2.5 |
| 40 | | 7 | 0.0037 | 2.5 |
| 30 | | 16 | 0.0085 | 2.5 |
| 20 | | 8 | 0.0043 | 2.5 |
| 10 | | 10 | 0.0053 | 2.5 |
| 0 | | 16 | 0.0085 | 2.5 |
| -10 | | 2 | 0.0011 | 2.5 |
| -20 | | 12 | 0.0064 | 2.5 |
| -30 | | 2 | 0.0011 | 2.5 |
| 20 | | 3.3 | 15 | 0.0080 |
| 20 | 4.2 | 1 | 0.0005 | 2.5 |

| Test Frequency:836.5MHz 16QAM 1.4MHz | | | | |
|--------------------------------------|--------------------|----------------------|-----------------------|-------------|
| Temperature (°C) | Power Supply (VDC) | Frequency Error (Hz) | Frequency Error (ppm) | Limit (ppm) |
| 50 | 3.8 | -11 | -0.0059 | 2.5 |
| 40 | | -12 | -0.0064 | 2.5 |
| 30 | | -5 | -0.0027 | 2.5 |
| 20 | | -9 | -0.0048 | 2.5 |
| 10 | | -2 | -0.0011 | 2.5 |
| 0 | | -6 | -0.0032 | 2.5 |
| -10 | | -6 | -0.0032 | 2.5 |
| -20 | | -2 | -0.0011 | 2.5 |
| -30 | | -15 | -0.0080 | 2.5 |
| 20 | | 3.3 | 0 | 0.0000 |
| 20 | 4.2 | -7 | -0.0037 | 2.5 |

LTE Band 5

| Test Frequency:836.5MHz QPSK 3MHz | | | | |
|-----------------------------------|--------------------|----------------------|-----------------------|-------------|
| Temperature (°C) | Power Supply (VDC) | Frequency Error (Hz) | Frequency Error (ppm) | Limit (ppm) |
| 50 | 3.8 | -7 | -0.0037 | 2.5 |
| 40 | | 4 | 0.0021 | 2.5 |
| 30 | | -3 | -0.0016 | 2.5 |
| 20 | | -1 | -0.0005 | 2.5 |
| 10 | | -6 | -0.0032 | 2.5 |
| 0 | | -7 | -0.0037 | 2.5 |
| -10 | | -6 | -0.0032 | 2.5 |
| -20 | | 0 | 0.0000 | 2.5 |
| -30 | | 6 | 0.0032 | 2.5 |
| 20 | | 3.3 | -7 | -0.0037 |
| 20 | 4.2 | -7 | -0.0037 | 2.5 |

| Test Frequency:836.5MHz 16QAM 3MHz | | | | |
|------------------------------------|--------------------|----------------------|-----------------------|-------------|
| Temperature (°C) | Power Supply (VDC) | Frequency Error (Hz) | Frequency Error (ppm) | Limit (ppm) |
| 50 | 3.8 | 14 | 0.0074 | 2.5 |
| 40 | | -3 | -0.0016 | 2.5 |
| 30 | | 11 | 0.0059 | 2.5 |
| 20 | | 5 | 0.0027 | 2.5 |
| 10 | | -3 | -0.0016 | 2.5 |
| 0 | | -2 | -0.0011 | 2.5 |
| -10 | | 10 | 0.0053 | 2.5 |
| -20 | | 13 | 0.0069 | 2.5 |
| -30 | | -2 | -0.0011 | 2.5 |
| 20 | | 3.3 | 10 | 0.0053 |
| 20 | 4.2 | -3 | -0.0016 | 2.5 |

LTE Band 5

| Test Frequency:836.5MHz QPSK 5MHz | | | | |
|-----------------------------------|--------------------|----------------------|-----------------------|-------------|
| Temperature (°C) | Power Supply (VDC) | Frequency Error (Hz) | Frequency Error (ppm) | Limit (ppm) |
| 50 | 3.8 | 13 | 0.0069 | 2.5 |
| 40 | | -2 | -0.0011 | 2.5 |
| 30 | | 10 | 0.0053 | 2.5 |
| 20 | | 6 | 0.0032 | 2.5 |
| 10 | | 10 | 0.0053 | 2.5 |
| 0 | | 3 | 0.0016 | 2.5 |
| -10 | | 8 | 0.0043 | 2.5 |
| -20 | | 7 | 0.0037 | 2.5 |
| -30 | | 3 | 0.0016 | 2.5 |
| 20 | | 3.3 | 4 | 0.0021 |
| 20 | 4.2 | -3 | -0.0016 | 2.5 |

| Test Frequency:836.5MHz 16QAM 5MHz | | | | |
|------------------------------------|--------------------|----------------------|-----------------------|-------------|
| Temperature (°C) | Power Supply (VDC) | Frequency Error (Hz) | Frequency Error (ppm) | Limit (ppm) |
| 50 | 3.8 | 0 | 0.0000 | 2.5 |
| 40 | | -12 | -0.0064 | 2.5 |
| 30 | | -5 | -0.0027 | 2.5 |
| 20 | | -7 | -0.0037 | 2.5 |
| 10 | | -14 | -0.0074 | 2.5 |
| 0 | | -1 | -0.0005 | 2.5 |
| -10 | | 2 | 0.0011 | 2.5 |
| -20 | | -10 | -0.0053 | 2.5 |
| -30 | | -14 | -0.0074 | 2.5 |
| 20 | | 3.3 | -12 | -0.0064 |
| 20 | 4.2 | -14 | -0.0074 | 2.5 |

LTE Band 5

| Test Frequency:836.5MHz QPSK 10MHz | | | | |
|------------------------------------|--------------------|----------------------|-----------------------|-------------|
| Temperature (°C) | Power Supply (VDC) | Frequency Error (Hz) | Frequency Error (ppm) | Limit (ppm) |
| 50 | 3.8 | -6 | -0.0032 | 2.5 |
| 40 | | -11 | -0.0059 | 2.5 |
| 30 | | -10 | -0.0053 | 2.5 |
| 20 | | -11 | -0.0059 | 2.5 |
| 10 | | -8 | -0.0043 | 2.5 |
| 0 | | -18 | -0.0096 | 2.5 |
| -10 | | -9 | -0.0048 | 2.5 |
| -20 | | -13 | -0.0069 | 2.5 |
| -30 | | -14 | -0.0074 | 2.5 |
| 20 | | 3.3 | -4 | -0.0021 |
| 20 | 4.2 | -5 | -0.0027 | 2.5 |

| Test Frequency:836.5MHz 16QAM 10MHz | | | | |
|-------------------------------------|--------------------|----------------------|-----------------------|-------------|
| Temperature (°C) | Power Supply (VDC) | Frequency Error (Hz) | Frequency Error (ppm) | Limit (ppm) |
| 50 | 3.8 | 2 | 0.0011 | 2.5 |
| 40 | | -1 | -0.0005 | 2.5 |
| 30 | | 3 | 0.0016 | 2.5 |
| 20 | | -1 | -0.0005 | 2.5 |
| 10 | | 5 | 0.0027 | 2.5 |
| 0 | | 7 | 0.0037 | 2.5 |
| -10 | | 5 | 0.0027 | 2.5 |
| -20 | | -3 | -0.0016 | 2.5 |
| -30 | | 5 | 0.0027 | 2.5 |
| 20 | | 3.3 | 0 | 0.0000 |
| 20 | 4.2 | -1 | -0.0005 | 2.5 |

LTE Band 7

| Test Frequency:2535MHz QPSK 5MHz | | | | |
|----------------------------------|--------------------|----------------------|-----------------------|-------------|
| Temperature (°C) | Power Supply (VDC) | Frequency Error (Hz) | Frequency Error (ppm) | Limit (ppm) |
| 50 | 3.8 | -15 | -0.0080 | 2.5 |
| 40 | | -4 | -0.0021 | 2.5 |
| 30 | | -9 | -0.0048 | 2.5 |
| 20 | | -7 | -0.0037 | 2.5 |
| 10 | | -14 | -0.0074 | 2.5 |
| 0 | | -10 | -0.0053 | 2.5 |
| -10 | | 0 | 0.0000 | 2.5 |
| -20 | | -3 | -0.0016 | 2.5 |
| -30 | | -1 | -0.0005 | 2.5 |
| 20 | | 3.3 | 2 | 0.0011 |
| 20 | 4.2 | -3 | -0.0016 | 2.5 |

| Test Frequency:2535MHz 16QAM 5MHz | | | | |
|-----------------------------------|--------------------|----------------------|-----------------------|-------------|
| Temperature (°C) | Power Supply (VDC) | Frequency Error (Hz) | Frequency Error (ppm) | Limit (ppm) |
| 50 | 3.8 | -1 | -0.0005 | 2.5 |
| 40 | | -12 | -0.0064 | 2.5 |
| 30 | | -5 | -0.0027 | 2.5 |
| 20 | | -8 | -0.0043 | 2.5 |
| 10 | | -13 | -0.0069 | 2.5 |
| 0 | | -7 | -0.0037 | 2.5 |
| -10 | | -8 | -0.0043 | 2.5 |
| -20 | | -8 | -0.0043 | 2.5 |
| -30 | | -10 | -0.0053 | 2.5 |
| 20 | | 3.3 | -6 | -0.0032 |
| 20 | 4.2 | -6 | -0.0032 | 2.5 |

LTE Band 7

| Test Frequency:2535MHz QPSK 10MHz | | | | |
|-----------------------------------|--------------------|----------------------|-----------------------|-------------|
| Temperature (°C) | Power Supply (VDC) | Frequency Error (Hz) | Frequency Error (ppm) | Limit (ppm) |
| 50 | 3.8 | (Hz) | (ppm) | (ppm) |
| 40 | | -15 | -0.0080 | 2.5 |
| 30 | | 0 | 0.0000 | 2.5 |
| 20 | | -1 | -0.0005 | 2.5 |
| 10 | | -6 | -0.0032 | 2.5 |
| 0 | | 0 | 0.0000 | 2.5 |
| -10 | | 2 | 0.0011 | 2.5 |
| -20 | | -4 | -0.0021 | 2.5 |
| -30 | | -13 | -0.0069 | 2.5 |
| 20 | | 3.3 | -8 | -0.0043 |
| 20 | 4.2 | -3 | -0.0016 | 2.5 |

| Test Frequency:2535MHz 16QAM 10MHz | | | | |
|------------------------------------|--------------------|----------------------|-----------------------|-------------|
| Temperature (°C) | Power Supply (VDC) | Frequency Error (Hz) | Frequency Error (ppm) | Limit (ppm) |
| 50 | 3.8 | 1 | 0.0005 | 2.5 |
| 40 | | 2 | 0.0011 | 2.5 |
| 30 | | 8 | 0.0043 | 2.5 |
| 20 | | 9 | 0.0048 | 2.5 |
| 10 | | 3 | 0.0016 | 2.5 |
| 0 | | 7 | 0.0037 | 2.5 |
| -10 | | 16 | 0.0085 | 2.5 |
| -20 | | 9 | 0.0048 | 2.5 |
| -30 | | 14 | 0.0074 | 2.5 |
| 20 | | 3.3 | 4 | 0.0021 |
| 20 | 4.2 | 14 | 0.0074 | 2.5 |

LTE Band 7

| Test Frequency:2535MHz QPSK 15MHz | | | | |
|-----------------------------------|--------------------|----------------------|-----------------------|-------------|
| Temperature (°C) | Power Supply (VDC) | Frequency Error (Hz) | Frequency Error (ppm) | Limit (ppm) |
| 50 | 3.8 | -3 | -0.0016 | 2.5 |
| 40 | | -7 | -0.0037 | 2.5 |
| 30 | | 5 | 0.0027 | 2.5 |
| 20 | | 1 | 0.0005 | 2.5 |
| 10 | | -4 | -0.0021 | 2.5 |
| 0 | | 9 | 0.0048 | 2.5 |
| -10 | | -5 | -0.0027 | 2.5 |
| -20 | | 2 | 0.0011 | 2.5 |
| -30 | | -8 | -0.0043 | 2.5 |
| 20 | | 3.3 | 1 | 0.0005 |
| 20 | 4.2 | -7 | -0.0037 | 2.5 |

| Test Frequency:2535MHz 16QAM 15MHz | | | | |
|------------------------------------|--------------------|----------------------|-----------------------|-------------|
| Temperature (°C) | Power Supply (VDC) | Frequency Error (Hz) | Frequency Error (ppm) | Limit (ppm) |
| 50 | 3.8 | -9 | -0.0048 | 2.5 |
| 40 | | 2 | 0.0011 | 2.5 |
| 30 | | 4 | 0.0021 | 2.5 |
| 20 | | 0 | 0.0000 | 2.5 |
| 10 | | 3 | 0.0016 | 2.5 |
| 0 | | -3 | -0.0016 | 2.5 |
| -10 | | -2 | -0.0011 | 2.5 |
| -20 | | 5 | 0.0027 | 2.5 |
| -30 | | 3 | 0.0016 | 2.5 |
| 20 | | 3.3 | -6 | -0.0032 |
| 20 | 4.2 | -1 | -0.0005 | 2.5 |

LTE Band 7

| Test Frequency:2535MHz QPSK 20MHz | | | | |
|-----------------------------------|--------------------|----------------------|-----------------------|-------------|
| Temperature (°C) | Power Supply (VDC) | Frequency Error (Hz) | Frequency Error (ppm) | Limit (ppm) |
| 50 | 3.8 | 0 | 0.0000 | 2.5 |
| 40 | | -5 | -0.0027 | 2.5 |
| 30 | | -3 | -0.0016 | 2.5 |
| 20 | | -3 | -0.0016 | 2.5 |
| 10 | | -10 | -0.0053 | 2.5 |
| 0 | | 3 | 0.0016 | 2.5 |
| -10 | | -3 | -0.0016 | 2.5 |
| -20 | | -3 | -0.0016 | 2.5 |
| -30 | | 4 | 0.0021 | 2.5 |
| 20 | | 3.3 | -6 | -0.0032 |
| 20 | 4.2 | 2 | 0.0011 | 2.5 |

| Test Frequency:2535MHz 16QAM 20MHz | | | | |
|------------------------------------|--------------------|----------------------|-----------------------|-------------|
| Temperature (°C) | Power Supply (VDC) | Frequency Error (Hz) | Frequency Error (ppm) | Limit (ppm) |
| 50 | 3.8 | -13 | -0.0069 | 2.5 |
| 40 | | -6 | -0.0032 | 2.5 |
| 30 | | -13 | -0.0069 | 2.5 |
| 20 | | -5 | -0.0027 | 2.5 |
| 10 | | -3 | -0.0016 | 2.5 |
| 0 | | -11 | -0.0059 | 2.5 |
| -10 | | -8 | -0.0043 | 2.5 |
| -20 | | -4 | -0.0021 | 2.5 |
| -30 | | -13 | -0.0069 | 2.5 |
| 20 | | 3.3 | -8 | -0.0043 |
| 20 | 4.2 | -9 | -0.0048 | 2.5 |

LTE Band 12

| Test Frequency:7.7.5MHz QPSK 1.4MHz | | | | |
|-------------------------------------|--------------------|----------------------|-----------------------|-------------|
| Temperature (°C) | Power Supply (VDC) | Frequency Error (Hz) | Frequency Error (ppm) | Limit (ppm) |
| 50 | 3.8 | 12 | 0.0064 | 2.5 |
| 40 | | 6 | 0.0032 | 2.5 |
| 30 | | 16 | 0.0085 | 2.5 |
| 20 | | 7 | 0.0037 | 2.5 |
| 10 | | 4 | 0.0021 | 2.5 |
| 0 | | 6 | 0.0032 | 2.5 |
| -10 | | 2 | 0.0011 | 2.5 |
| -20 | | 3 | 0.0016 | 2.5 |
| -30 | | 12 | 0.0064 | 2.5 |
| 20 | | 3.3 | 3 | 0.0016 |
| 20 | 4.2 | 0 | 0.0000 | 2.5 |

| Test Frequency:707.5MHz 16QAM 1.4MHz | | | | |
|--------------------------------------|--------------------|----------------------|-----------------------|-------------|
| Temperature (°C) | Power Supply (VDC) | Frequency Error (Hz) | Frequency Error (ppm) | Limit (ppm) |
| 50 | 3.8 | 2 | 0.0011 | 2.5 |
| 40 | | -1 | -0.0005 | 2.5 |
| 30 | | -1 | -0.0005 | 2.5 |
| 20 | | 0 | 0.0000 | 2.5 |
| 10 | | 4 | 0.0021 | 2.5 |
| 0 | | -4 | -0.0021 | 2.5 |
| -10 | | -3 | -0.0016 | 2.5 |
| -20 | | 9 | 0.0048 | 2.5 |
| -30 | | 1 | 0.0005 | 2.5 |
| 20 | | 3.3 | -4 | -0.0021 |
| 20 | 4.2 | 3 | 0.0016 | 2.5 |

LTE Band 12

| Test Frequency:707.5MHz QPSK 3MHz | | | | |
|-----------------------------------|--------------------|----------------------|-----------------------|-------------|
| Temperature (°C) | Power Supply (VDC) | Frequency Error (Hz) | Frequency Error (ppm) | Limit (ppm) |
| 50 | 3.8 | 7 | 0.0037 | 2.5 |
| 40 | | -6 | -0.0032 | 2.5 |
| 30 | | 1 | 0.0005 | 2.5 |
| 20 | | 1 | 0.0005 | 2.5 |
| 10 | | -6 | -0.0032 | 2.5 |
| 0 | | -6 | -0.0032 | 2.5 |
| -10 | | 8 | 0.0043 | 2.5 |
| -20 | | 4 | 0.0021 | 2.5 |
| -30 | | -7 | -0.0037 | 2.5 |
| 20 | | 3.3 | -2 | -0.0011 |
| 20 | 4.2 | -3 | -0.0016 | 2.5 |

| Test Frequency:707.5MHz 16QAM 3MHz | | | | |
|------------------------------------|--------------------|----------------------|-----------------------|-------------|
| Temperature (°C) | Power Supply (VDC) | Frequency Error (Hz) | Frequency Error (ppm) | Limit (ppm) |
| 50 | 3.8 | 6 | 0.0032 | 2.5 |
| 40 | | -4 | -0.0021 | 2.5 |
| 30 | | 3 | 0.0016 | 2.5 |
| 20 | | 2 | 0.0011 | 2.5 |
| 10 | | 2 | 0.0011 | 2.5 |
| 0 | | 7 | 0.0037 | 2.5 |
| -10 | | -1 | -0.0005 | 2.5 |
| -20 | | 10 | 0.0053 | 2.5 |
| -30 | | -4 | -0.0021 | 2.5 |
| 20 | | 3.3 | 6 | 0.0032 |
| 20 | 4.2 | -7 | -0.0037 | 2.5 |

LTE Band 12

| Test Frequency:707.5MHz QPSK 5MHz | | | | |
|-----------------------------------|--------------------|----------------------|-----------------------|-------------|
| Temperature (°C) | Power Supply (VDC) | Frequency Error (Hz) | Frequency Error (ppm) | Limit (ppm) |
| 50 | 3.8 | -5 | -0.0027 | 2.5 |
| 40 | | -6 | -0.0032 | 2.5 |
| 30 | | -5 | -0.0027 | 2.5 |
| 20 | | 3 | 0.0016 | 2.5 |
| 10 | | 6 | 0.0032 | 2.5 |
| 0 | | 12 | 0.0064 | 2.5 |
| -10 | | 12 | 0.0064 | 2.5 |
| -20 | | 10 | 0.0053 | 2.5 |
| -30 | | 12 | 0.0064 | 2.5 |
| 20 | | 3.3 | 3 | 0.0016 |
| 20 | 4.2 | 4 | 0.0021 | 2.5 |

| Test Frequency:707.5MHz 16QAM 5MHz | | | | |
|------------------------------------|--------------------|----------------------|-----------------------|-------------|
| Temperature (°C) | Power Supply (VDC) | Frequency Error (Hz) | Frequency Error (ppm) | Limit (ppm) |
| 50 | 3.8 | 13 | 0.0069 | 2.5 |
| 40 | | 0 | 0.0000 | 2.5 |
| 30 | | 5 | 0.0027 | 2.5 |
| 20 | | 4 | 0.0021 | 2.5 |
| 10 | | 12 | 0.0064 | 2.5 |
| 0 | | 1 | 0.0005 | 2.5 |
| -10 | | 9 | 0.0048 | 2.5 |
| -20 | | 6 | 0.0032 | 2.5 |
| -30 | | 9 | 0.0048 | 2.5 |
| 20 | | 3.3 | 1 | 0.0005 |
| 20 | 4.2 | 8 | 0.0043 | 2.5 |

LTE Band 12

| Test Frequency:707.5MHz QPSK 10MHz | | | | |
|------------------------------------|--------------------|----------------------|-----------------------|-------------|
| Temperature (°C) | Power Supply (VDC) | Frequency Error (Hz) | Frequency Error (ppm) | Limit (ppm) |
| 50 | 3.8 | 5 | 0.0027 | 2.5 |
| 40 | | -4 | -0.0021 | 2.5 |
| 30 | | -1 | -0.0005 | 2.5 |
| 20 | | 5 | 0.0027 | 2.5 |
| 10 | | -1 | -0.0005 | 2.5 |
| 0 | | 14 | 0.0074 | 2.5 |
| -10 | | -3 | -0.0016 | 2.5 |
| -20 | | 9 | 0.0048 | 2.5 |
| -30 | | -1 | -0.0005 | 2.5 |
| 20 | | 3.3 | 5 | 0.0027 |
| 20 | 4.2 | -4 | -0.0021 | 2.5 |

| Test Frequency:707.5MHz 16QAM 10MHz | | | | |
|-------------------------------------|--------------------|----------------------|-----------------------|-------------|
| Temperature (°C) | Power Supply (VDC) | Frequency Error (Hz) | Frequency Error (ppm) | Limit (ppm) |
| 50 | 3.8 | 4 | 0.0021 | 2.5 |
| 40 | | 4 | 0.0021 | 2.5 |
| 30 | | 15 | 0.0080 | 2.5 |
| 20 | | 8 | 0.0043 | 2.5 |
| 10 | | 14 | 0.0074 | 2.5 |
| 0 | | 8 | 0.0043 | 2.5 |
| -10 | | 16 | 0.0085 | 2.5 |
| -20 | | 1 | 0.0005 | 2.5 |
| -30 | | 1 | 0.0005 | 2.5 |
| 20 | | 3.3 | 14 | 0.0074 |
| 20 | 4.2 | 14 | 0.0074 | 2.5 |

LTE Band 17

| Test Frequency: 710.0MHz QPSK 5MHz | | | | |
|------------------------------------|--------------------|----------------------|-----------------------|-------------|
| Temperature (°C) | Power Supply (VDC) | Frequency Error (Hz) | Frequency Error (ppm) | Limit (ppm) |
| 50 | 3.8 | 7 | 0.0037 | 2.5 |
| 40 | | 12 | 0.0064 | 2.5 |
| 30 | | -1 | -0.0005 | 2.5 |
| 20 | | 7 | 0.0037 | 2.5 |
| 10 | | 10 | 0.0053 | 2.5 |
| 0 | | 9 | 0.0048 | 2.5 |
| -10 | | 4 | 0.0021 | 2.5 |
| -20 | | 13 | 0.0069 | 2.5 |
| -30 | | 9 | 0.0048 | 2.5 |
| 20 | | 3.3 | 9 | 0.0048 |
| 20 | 4.2 | 5 | 0.0027 | 2.5 |

| Test Frequency: 710.0MHz 16QAM 5MHz | | | | |
|-------------------------------------|--------------------|----------------------|-----------------------|-------------|
| Temperature (°C) | Power Supply (VDC) | Frequency Error (Hz) | Frequency Error (ppm) | Limit (ppm) |
| 50 | 3.8 | 1 | 0.0005 | 2.5 |
| 40 | | 8 | 0.0043 | 2.5 |
| 30 | | 6 | 0.0032 | 2.5 |
| 20 | | 3 | 0.0016 | 2.5 |
| 10 | | -5 | -0.0027 | 2.5 |
| 0 | | 9 | 0.0048 | 2.5 |
| -10 | | 2 | 0.0011 | 2.5 |
| -20 | | -2 | -0.0011 | 2.5 |
| -30 | | 8 | 0.0043 | 2.5 |
| 20 | | 3.3 | 8 | 0.0043 |
| 20 | 4.2 | 4 | 0.0021 | 2.5 |

LTE Band 17

| Test Frequency: 710.0MHz QPSK 10MHz | | | | |
|-------------------------------------|--------------------|----------------------|-----------------------|-------------|
| Temperature (°C) | Power Supply (VDC) | Frequency Error (Hz) | Frequency Error (ppm) | Limit (ppm) |
| 50 | 3.8 | 13 | 0.0069 | 2.5 |
| 40 | | 12 | 0.0064 | 2.5 |
| 30 | | 5 | 0.0027 | 2.5 |
| 20 | | 6 | 0.0032 | 2.5 |
| 10 | | 10 | 0.0053 | 2.5 |
| 0 | | 14 | 0.0074 | 2.5 |
| -10 | | 13 | 0.0069 | 2.5 |
| -20 | | 5 | 0.0027 | 2.5 |
| -30 | | -2 | -0.0011 | 2.5 |
| 20 | | 3.3 | 4 | 0.0021 |
| 20 | 4.2 | 8 | 0.0043 | 2.5 |

| Test Frequency: 710.0MHz 16QAM 10MHz | | | | |
|--------------------------------------|--------------------|----------------------|-----------------------|-------------|
| Temperature (°C) | Power Supply (VDC) | Frequency Error (Hz) | Frequency Error (ppm) | Limit (ppm) |
| 50 | 3.8 | -4 | -0.0021 | 2.5 |
| 40 | | 3 | 0.0016 | 2.5 |
| 30 | | -4 | -0.0021 | 2.5 |
| 20 | | 2 | 0.0011 | 2.5 |
| 10 | | 6 | 0.0032 | 2.5 |
| 0 | | 0 | 0.0000 | 2.5 |
| -10 | | 7 | 0.0037 | 2.5 |
| -20 | | -7 | -0.0037 | 2.5 |
| -30 | | 10 | 0.0053 | 2.5 |
| 20 | | 3.3 | 3 | 0.0016 |
| 20 | 4.2 | -6 | -0.0032 | 2.5 |

15 RF Exposure

Remark: Please refer to SAR test report: WTS18S11129613-1W.

