

Band 13, UL Channel 23205, UL Frequency 779.5, BW 5.0, NO. RB 25, RB POS. Low, 16-QAM

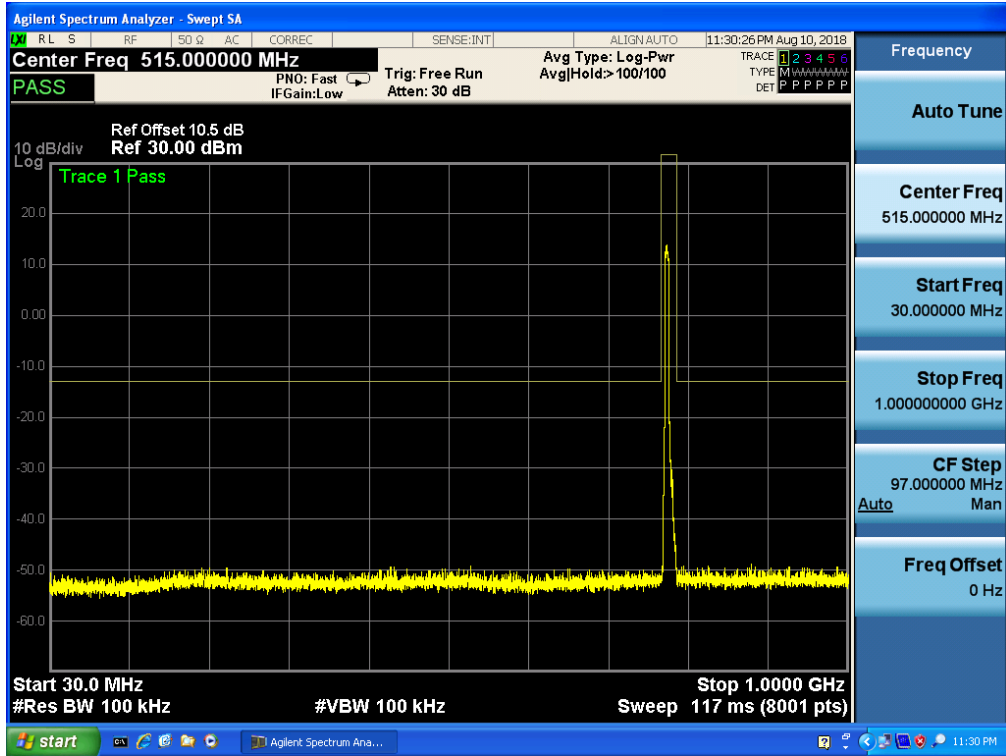

Band 13, UL Channel 23205, UL Frequency 779.5, BW 5.0, NO. RB 25, RB POS. Low, 16-QAM

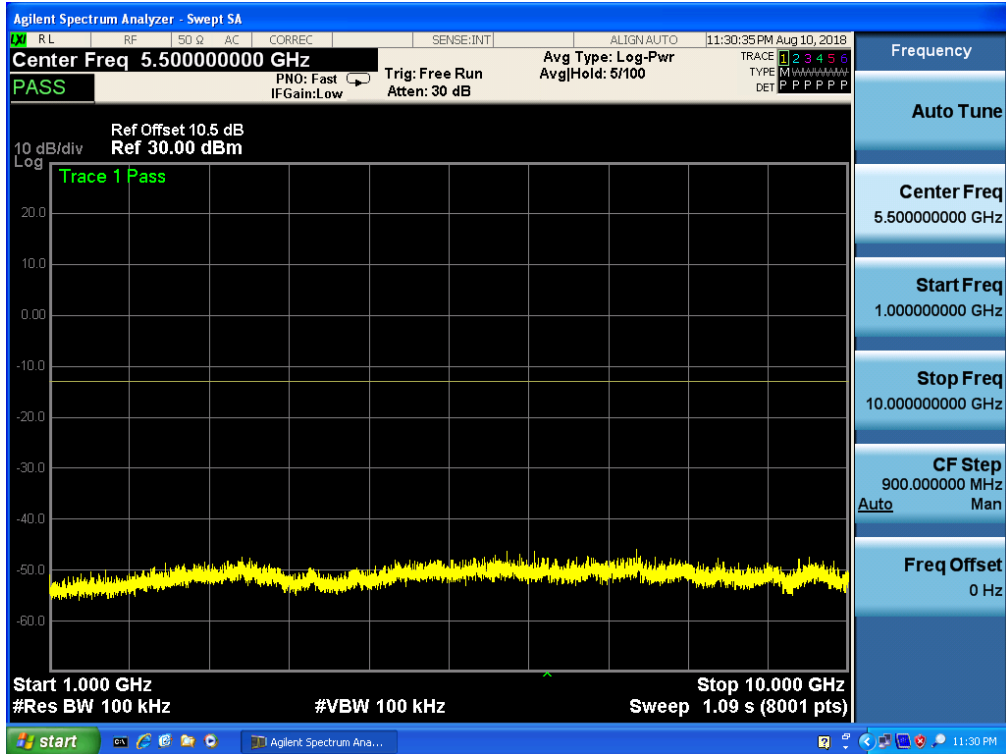

Band 13, UL Channel 23255, UL Frequency 784.5, BW 5.0, NO. RB 25, RB POS. Low, QPSK

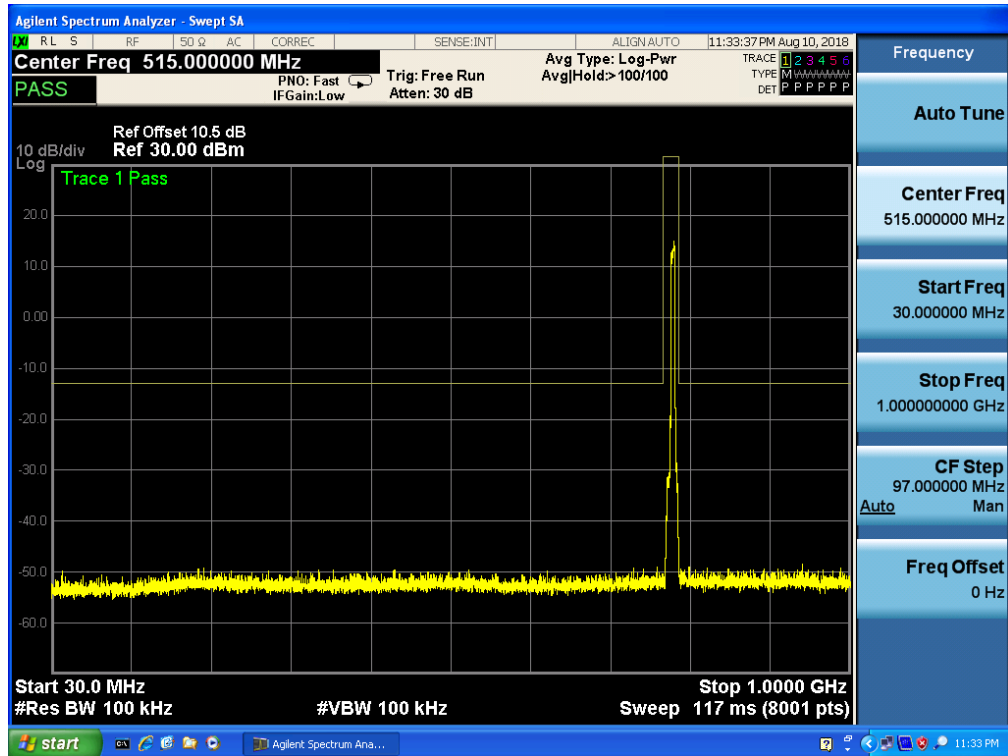

Band 13, UL Channel 23255, UL Frequency 784.5, BW 5.0, NO. RB 25, RB POS. Low, QPSK

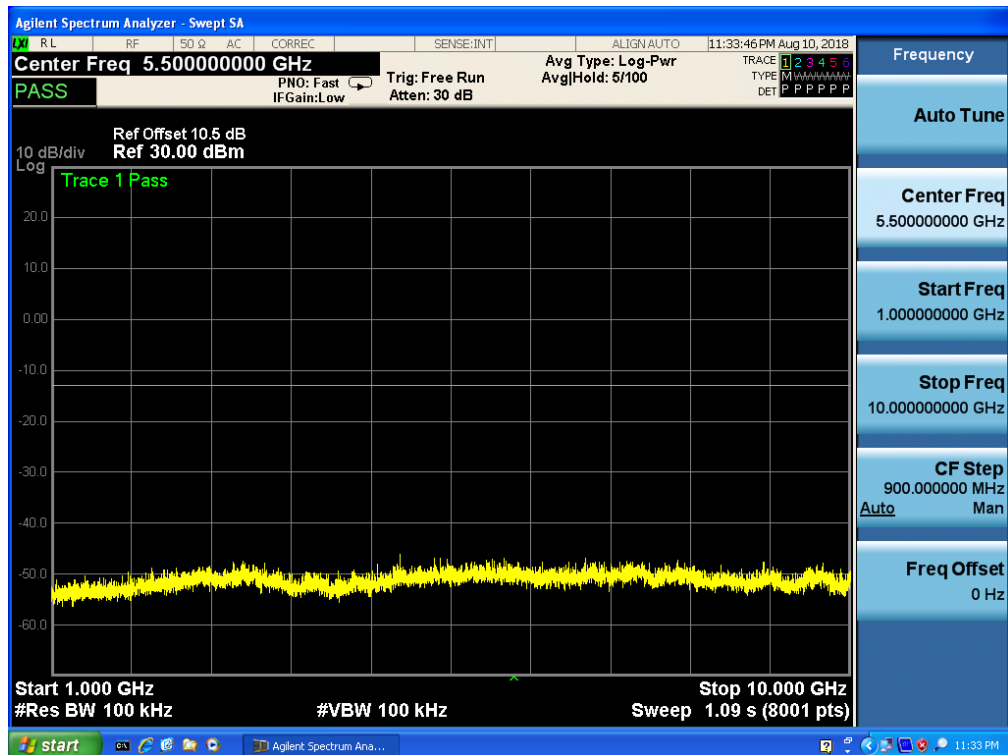

Band 13, UL Channel 23255, UL Frequency 784.5, BW 5.0, NO. RB 25, RB POS. Low, 16-QAM

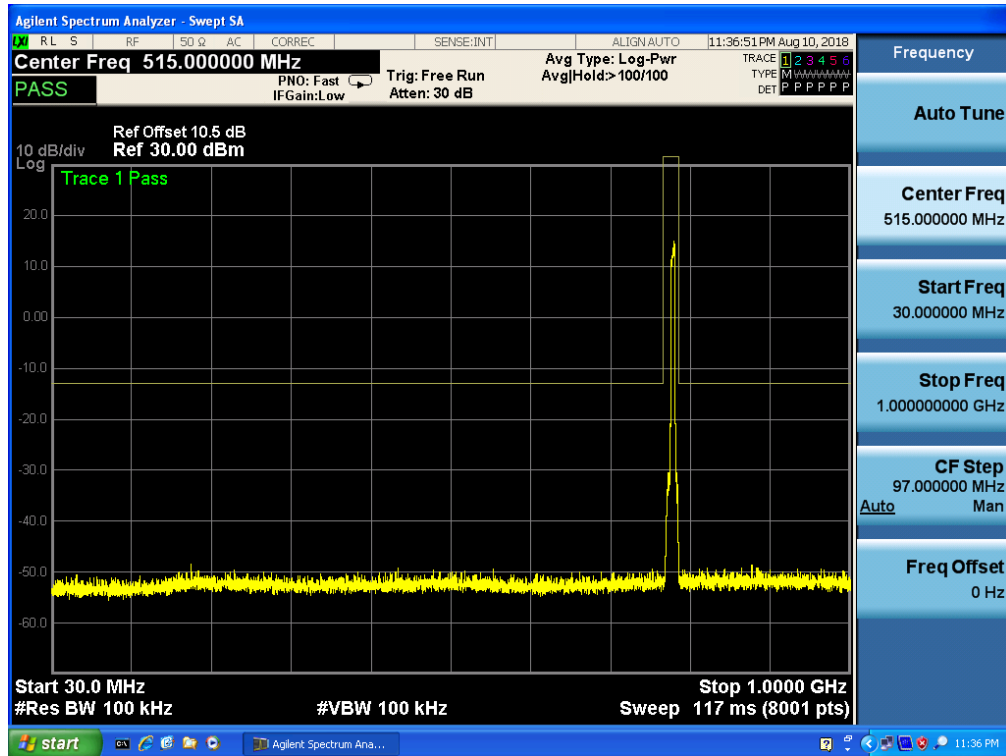

Band 13, UL Channel 23255, UL Frequency 784.5, BW 5.0, NO. RB 25, RB POS. Low, 16-QAM

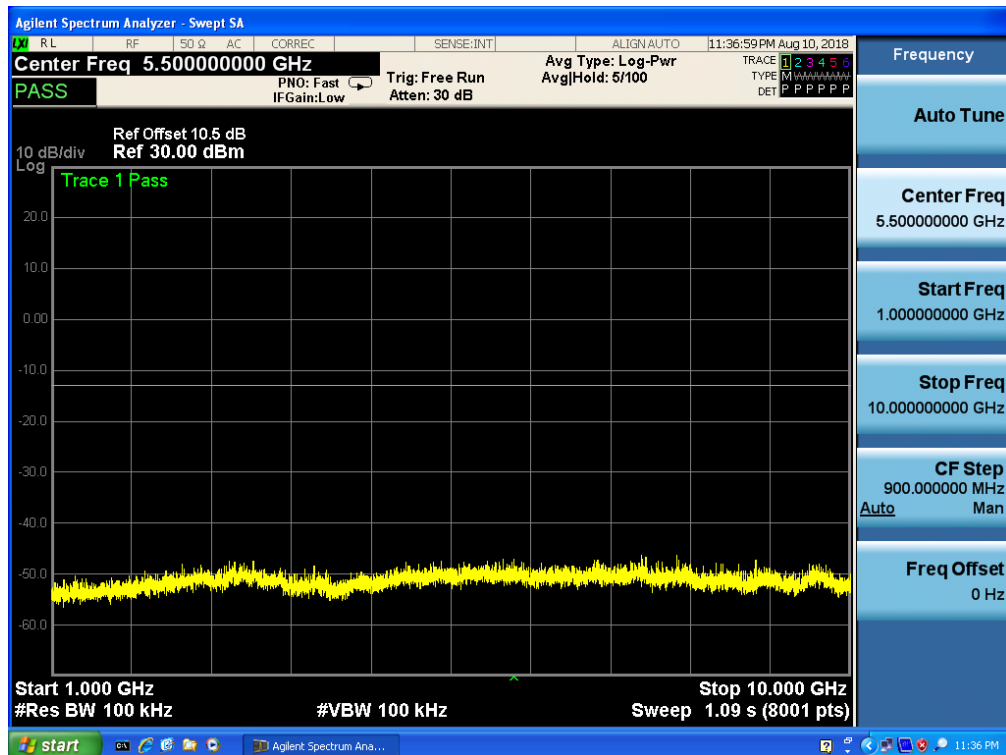

Band 13, UL Channel 23230, UL Frequency 782.0, BW 10.0, NO. RB 50, RB POS. Low, QPSK

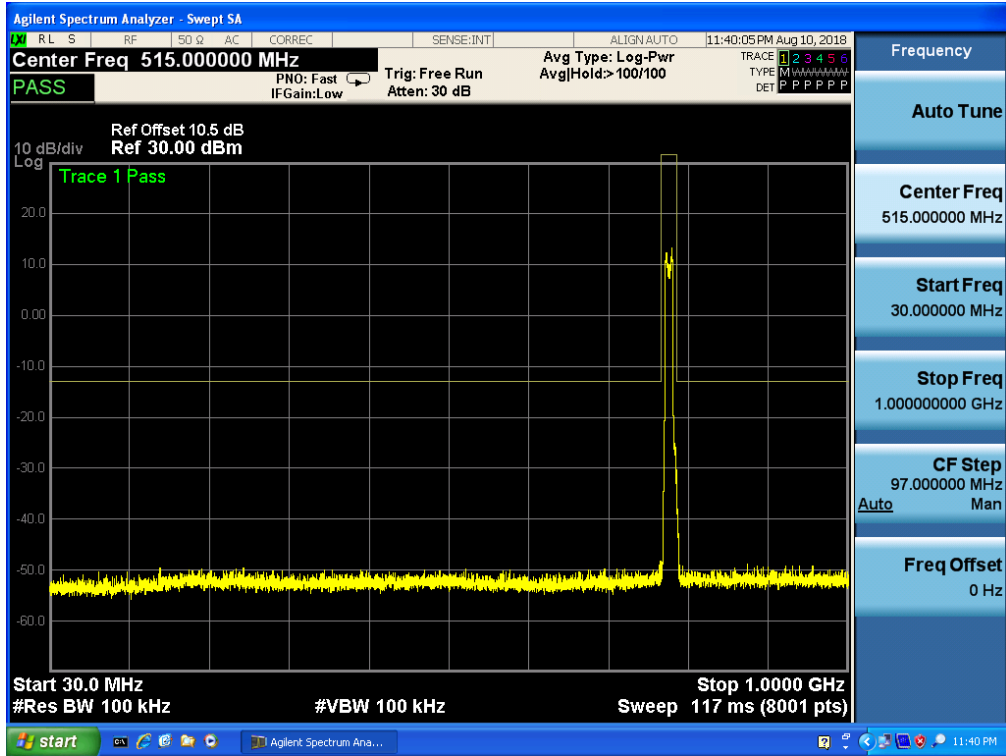

Band 13, UL Channel 23230, UL Frequency 782.0, BW 10.0, NO. RB 50, RB POS. Low, QPSK

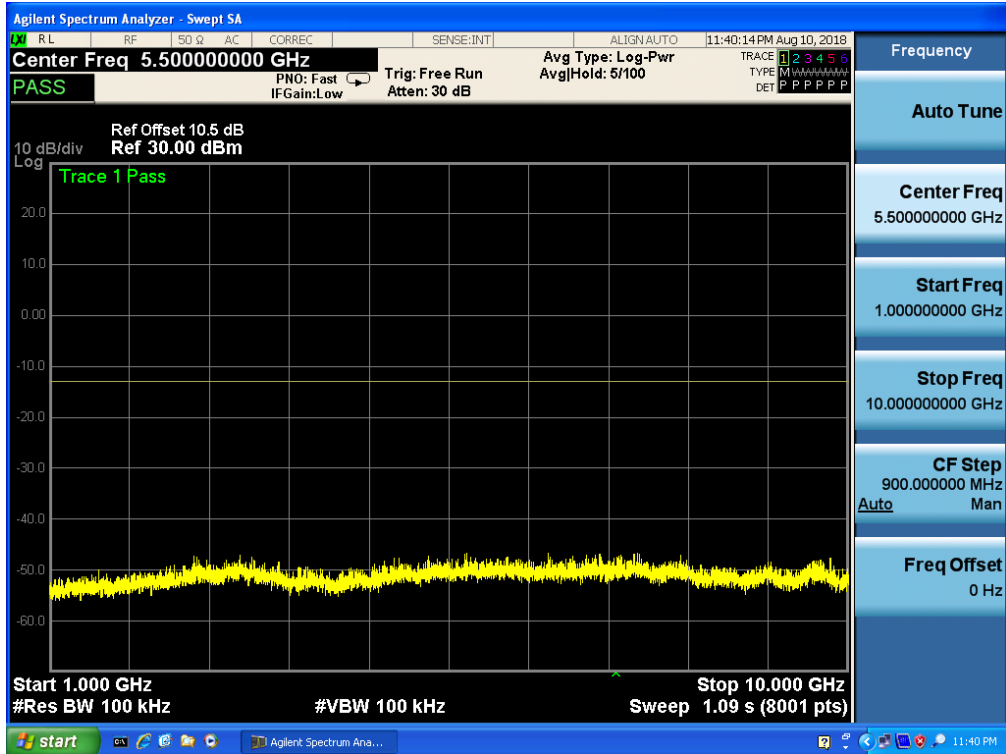

Band 13, UL Channel 23230, UL Frequency 782.0, BW 10.0, NO. RB 50, RB POS. Low, 16-QAM

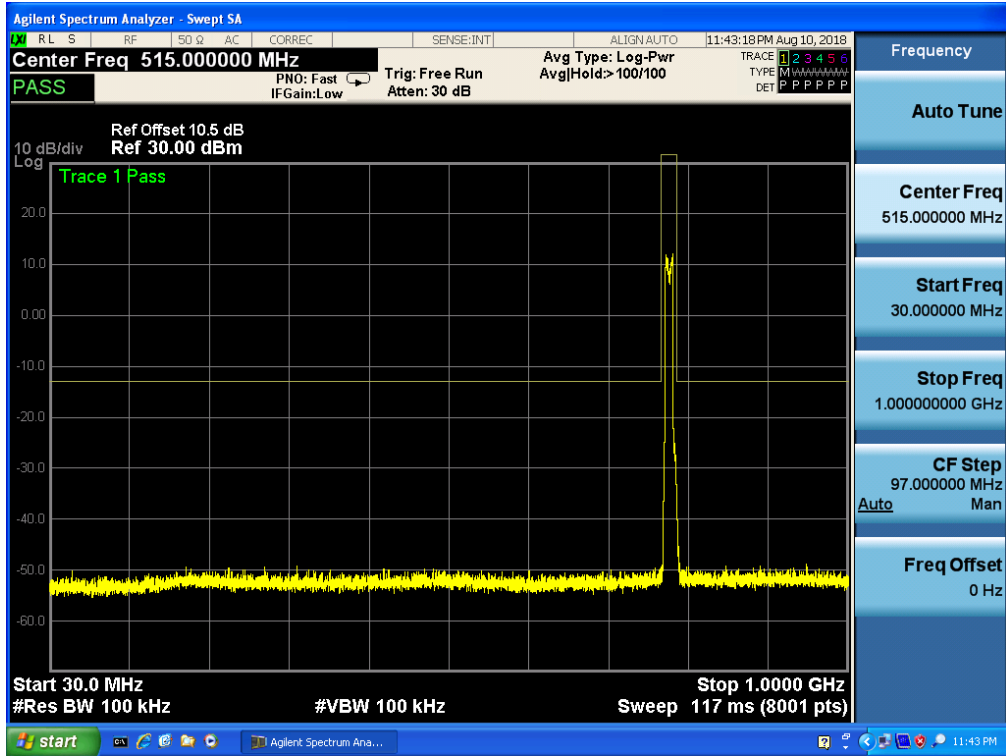

Band 13, UL Channel 23230, UL Frequency 782.0, BW 10.0, NO. RB 50, RB POS. Low, 16-QAM

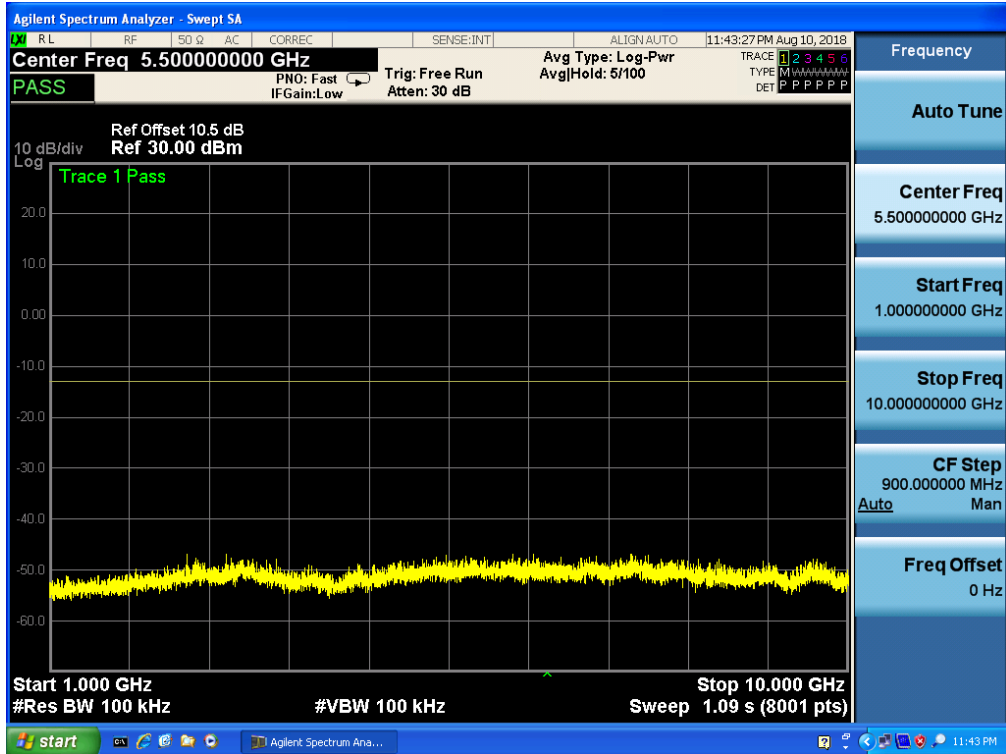

Band 13, UL Channel 23230, UL Frequency 782.0, BW 10.0, NO. RB 50, RB POS. Low, QPSK

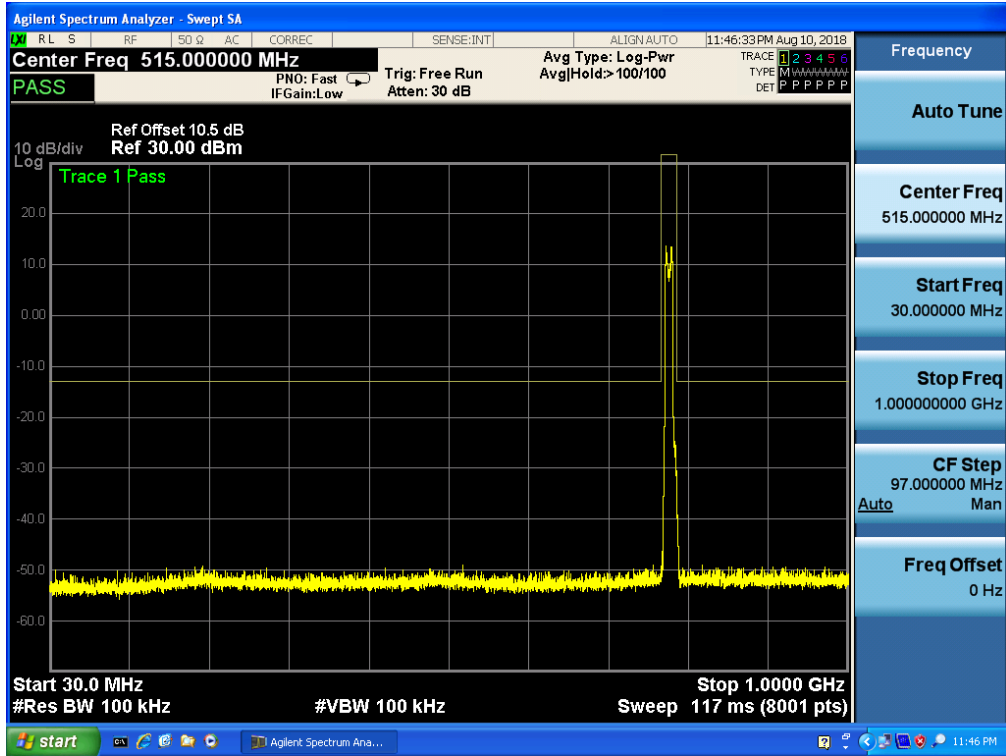

Band 13, UL Channel 23230, UL Frequency 782.0, BW 10.0, NO. RB 50, RB POS. Low, QPSK

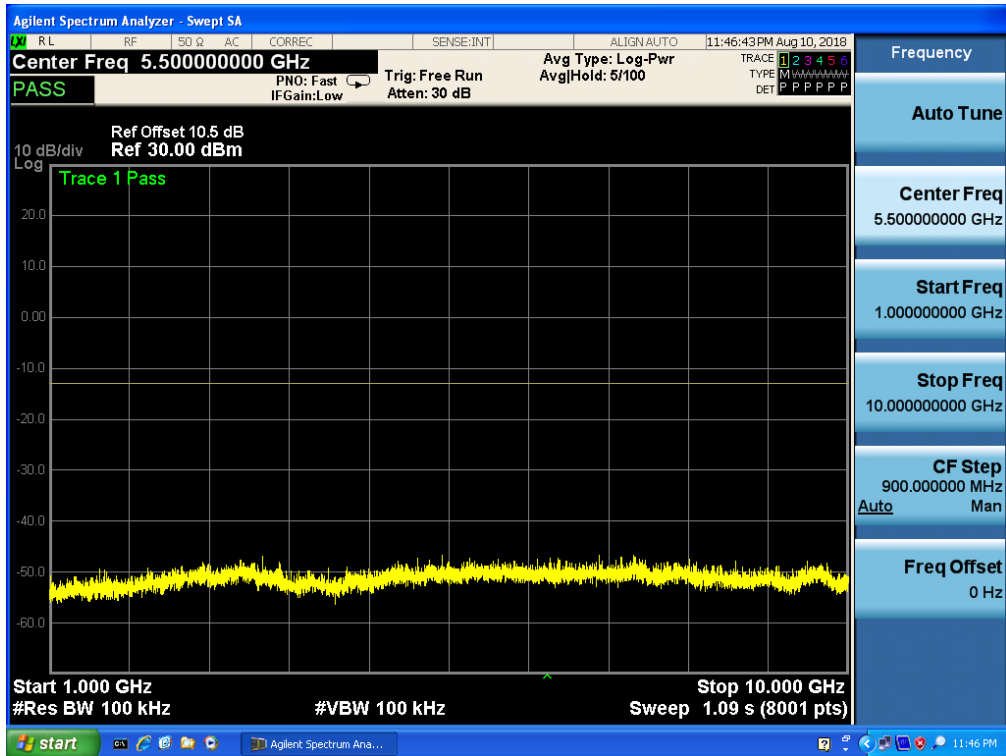

Band 13, UL Channel 23230, UL Frequency 782.0, BW 10.0, NO. RB 50, RB POS. Low, 16-QAM

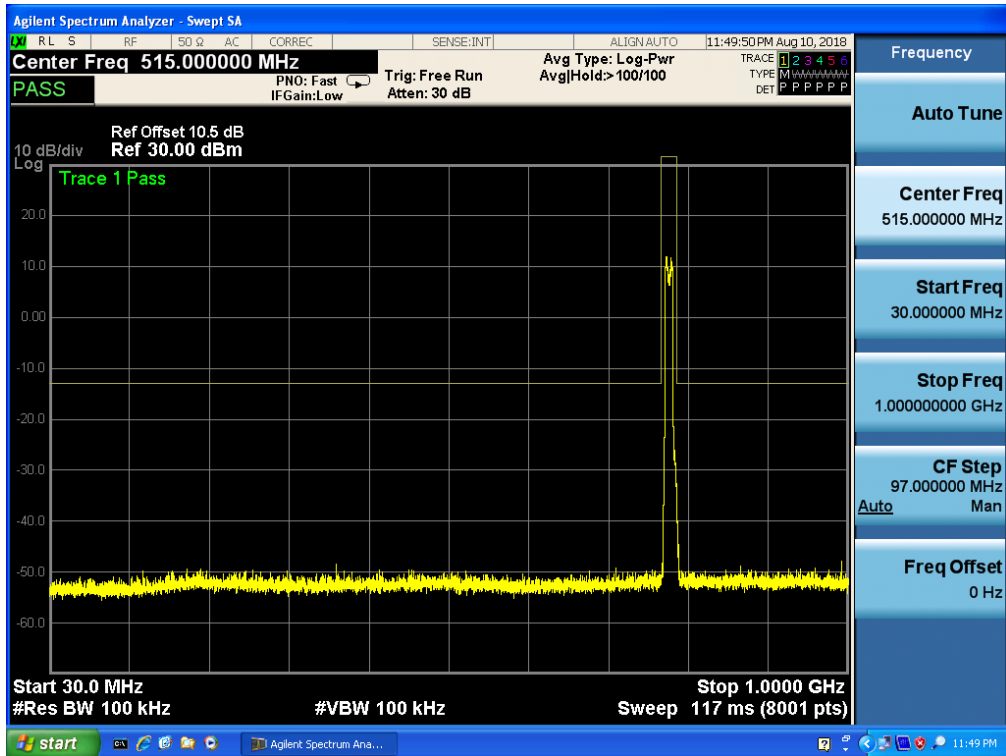

Band 13, UL Channel 23230, UL Frequency 782.0, BW 10.0, NO. RB 50, RB POS. Low, 16-QAM

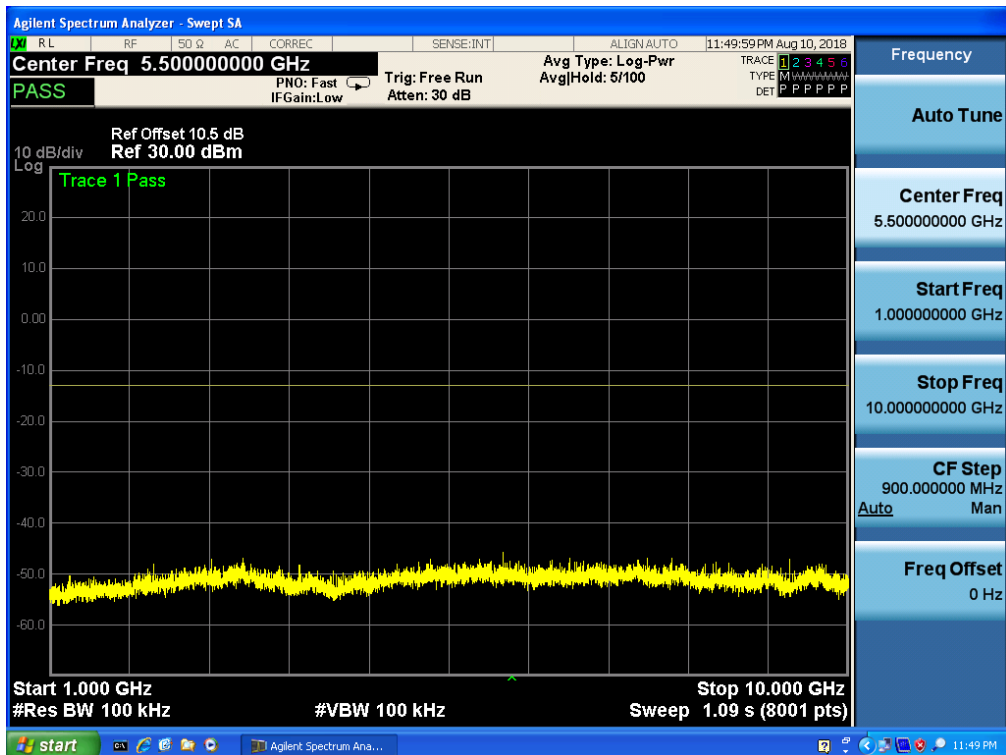



## 8. Radiated Spurious Emission

### 8.1. RADIATED POWER (ERP & EIRP)

#### RULE PART(S)

FCC: §2.1046, §22.913, §24.232 and §27.50

#### LIMITS:

22.913(a) - The ERP of mobile transmitters and auxiliary test transmitters must not exceed 7 Watts.

27.50 (c) (10) the following power and antenna height requirements apply to stations transmitting in the 698–746 MHz band, the portable stations (hand-held devices) are limited to 3 watts ERP.

27.50 (b)(10) Portable stations (hand-held devices) transmitting in the 746–757 MHz, 758–763 MHz, 776–793 MHz, and 805–806 MHz bands are limited to 3 watts ERP.

27.50 (d)(4) The following power and antenna height requirements apply to stations transmitting in the 1710–1755 MHz and 2110–2155 MHz bands: Fixed, mobile, and portable (hand-held) stations operating in the 1710–1755 MHz band are limited to 1 watt EIRP.

#### TEST PROCEDURE

ANSI/TIA-603-E Clause 2.2.17

KDB 971168 v02r01 RF power output using broadband peak and average power meter method.

KDB 971168 D01 Power Meas License Digital Systems v02r01, "Measurement Guidance for Certification of Licensed Digital Transmitters"

#### MODES TESTED

LTE Band 2

LTE Band 4

LTE Band 13

#### RESULTS



8.2 LTE BAND 2

Radiated Power (EIRP) for Band 2										
Mode	RB/RB SIZE	Frequency	Result						Polarization Of Max. ERP	Conclusion
			SG Level (dBm)	Cable Loss (dBm)	Antenna Gain (dB)	Max. EIRP Average (dBm)	Max. EIRP Average (mW)			
1.4MHz Band. QPSK	6/0	1850.7	-1.49	3.76	28.24	22.85	199.104	Vertical	Pass	
		1880	-1.29	3.91	28.22	23.02	200.233	Vertical	Pass	
		1909.3	-1.00	3.93	28.20	23.27	212.453	Vertical	Pass	
1.4MHz Band. 16 QAM	6/0	1850.7	-2.88	3.76	28.24	21.60	144.609	Vertical	Pass	
		1880	-2.03	3.91	28.22	22.28	168.934	Vertical	Pass	
		1909.3	-2.50	3.93	28.20	21.77	150.390	Vertical	Pass	
3.0MHz Band. QPSK	15/0	1851.5	-0.85	3.77	28.23	23.61	229.465	Vertical	Pass	
		1880	-1.51	3.91	28.24	22.82	191.613	Vertical	Pass	
		1908.5	-1.62	3.94	28.25	22.69	185.940	Vertical	Pass	
3.0MHz Band. 16 QAM	15/0	1851.5	-1.70	3.77	28.23	22.76	189.005	Vertical	Pass	
		1880	-2.81	3.91	28.24	21.52	141.785	Vertical	Pass	
		1908.5	-1.46	3.94	28.25	22.85	192.562	Vertical	Pass	
5.0MHz Band. QPSK	25/0	1852.5	-0.73	3.77	28.31	23.81	240.430	Vertical	Pass	
		1880	-0.67	3.91	28.22	23.64	231.049	Vertical	Pass	
		1907.5	-1.07	3.94	28.20	23.19	208.364	Vertical	Pass	
5.0MHz Band. 16 QAM	25/0	1852.5	-1.75	3.77	28.31	22.79	190.212	Vertical	Pass	
		1880	-1.60	3.91	28.22	22.71	186.476	Vertical	Pass	
		1907.5	-2.25	3.94	28.20	22.01	158.729	Vertical	Pass	
10.0MHz Band. QPSK	50/0	1855	-1.99	3.79	28.33	22.55	179.931	Vertical	Pass	
		1880	-1.45	3.95	28.22	22.82	191.223	Vertical	Pass	
		1905	-0.06	3.97	28.19	24.16	260.459	Vertical	Pass	
10.0MHz Band. 16 QAM	50/0	1855	-2.98	3.79	28.33	21.56	143.300	Vertical	Pass	
		1880	-2.26	3.95	28.22	22.01	158.945	Vertical	Pass	
		1905	-2.14	3.97	28.19	22.08	161.302	Vertical	Pass	
15.0MHz Band. QPSK	75/0	1857.5	-1.22	3.79	28.34	23.33	215.343	Vertical	Pass	
		1880	-0.68	3.95	28.22	23.59	228.412	Vertical	Pass	
		1902.5	0.16	3.97	28.18	24.37	273.331	Vertical	Pass	
15.0MHz Band. 16 QAM	75/0	1857.5	-1.95	3.79	28.34	22.60	182.047	Vertical	Pass	
		1880	-1.66	3.95	28.22	22.61	182.326	Vertical	Pass	
		1902.5	-1.42	3.97	28.18	22.79	189.906	Vertical	Pass	

20.0MHz Band. QPSK	100/0	1860	-1.98	3.81	28.35	22.56	180.103	Vertical	Pass
		1880	-0.65	3.96	28.22	23.61	229.687	Vertical	Pass
		1900	-0.86	4.00	28.16	23.30	213.580	Vertical	Pass
20.0MHz Band. 16 QAM	100/0	1860	-3.06	3.81	28.35	21.48	140.548	Vertical	Pass
		1880	-2.08	3.96	28.22	22.18	165.084	Vertical	Pass
		1900	-1.89	4.00	28.16	22.27	168.657	Vertical	Pass

Note:

SG Level= Signal generator output

Max. EIRP Average (dBm)= Antenna Gain(dB)+ SG Level (dBm)- Cable Loss(dBm)

Radiated Power (EIRP) for Band 2									
Mode	RB/RB SIZE	Frequency	Result						Conclusion
			SG Level (dBm)	Cable Loss (dBm)	Antenna Gain (dB)	Max. EIRP Average (dBm)	Max. EIRP Average (mW)	Polarization Of Max. ERP	
1.4MHz Band. QPSK	6/0	1850.7	-2.44	3.76	28.24	22.04	159.956	Horizontal	Pass
		1880	-2.24	3.91	28.22	22.07	161.065	Horizontal	Pass
		1909.3	-2.38	3.93	28.20	21.89	154.525	Horizontal	Pass
1.4MHz Band. 16 QAM	6/0	1850.7	-3.47	3.76	28.24	21.01	126.183	Horizontal	Pass
		1880	-3.44	3.91	28.22	20.87	122.180	Horizontal	Pass
		1909.3	-3.53	3.93	28.20	20.74	118.577	Horizontal	Pass
3.0MHz Band. QPSK	15/0	1851.5	-2.43	3.77	28.23	22.03	159.588	Horizontal	Pass
		1880	-2.36	3.91	28.24	21.97	157.398	Horizontal	Pass
		1908.5	-2.26	3.94	28.25	22.05	160.325	Horizontal	Pass
3.0MHz Band. 16 QAM	15/0	1851.5	-3.29	3.77	28.23	21.17	130.918	Horizontal	Pass
		1880	-3.48	3.91	28.24	20.85	121.619	Horizontal	Pass
		1908.5	-3.62	3.94	28.25	20.69	117.220	Horizontal	Pass
5.0MHz Band. QPSK	25/0	1852.5	-2.51	3.77	28.31	22.03	159.588	Horizontal	Pass
		1880	-2.43	3.91	28.22	21.88	154.170	Horizontal	Pass
		1907.5	-2.34	3.94	28.20	21.92	155.597	Horizontal	Pass
5.0MHz Band. 16 QAM	25/0	1852.5	-3.63	3.77	28.31	20.91	123.310	Horizontal	Pass
		1880	-3.16	3.91	28.22	21.15	130.317	Horizontal	Pass
		1907.5	-3.21	3.94	28.20	21.05	127.350	Horizontal	Pass
10.0MHz Band. QPSK	50/0	1855	-2.57	3.79	28.33	21.97	157.398	Horizontal	Pass
		1880	-2.26	3.95	28.22	22.01	158.855	Horizontal	Pass
		1905	-2.09	3.97	28.19	22.13	163.305	Horizontal	Pass
10.0MHz Band. 16 QAM	50/0	1855	-3.69	3.79	28.33	20.85	121.619	Horizontal	Pass
		1880	-3.48	3.95	28.22	20.79	119.950	Horizontal	Pass
		1905	-3.39	3.97	28.19	20.83	121.060	Horizontal	Pass
15.0MHz Band. QPSK	75/0	1857.5	-2.81	3.79	28.34	21.74	149.279	Horizontal	Pass
		1880	-2.73	3.95	28.22	21.54	142.561	Horizontal	Pass
		1902.5	-2.35	3.97	28.18	21.86	153.462	Horizontal	Pass
15.0MHz Band. 16 QAM	75/0	1857.5	-3.47	3.79	28.34	21.08	128.233	Horizontal	Pass
		1880	-3.69	3.95	28.22	20.58	114.288	Horizontal	Pass
		1902.5	-3.44	3.97	28.18	20.77	119.399	Horizontal	Pass
20.0MHz Band. QPSK	100/0	1860	-3.96	3.81	28.35	20.58	114.288	Horizontal	Pass
		1880	-2.62	3.96	28.22	21.64	145.881	Horizontal	Pass
		1900	-3.02	4.00	28.16	21.14	130.017	Horizontal	Pass

20.0MHz	100/0	1860	-3.59	3.81	28.35	20.95	124.451	Horizontal	Pass
Band. 16		1880	-3.58	3.96	28.22	20.68	116.950	Horizontal	Pass
QAM		1900	-3.43	4.00	28.16	20.73	118.304	Horizontal	Pass

Note:

SG Level= Signal generator output

Max. EIRP Average (dBm)= Antenna Gain(dB)+ SG Level (dBm)- Cable Loss(dBm)

8.3 LTE BAND 4

Radiated Power (EIRP) for Band 4									
Mode	RB/ RB SIZE	Frequency	Result						Conclusion
			SG Level (dBm )	Cable Loss (dBm)	Anten na Gain (dB)	Max. EIRP Averag e (dBm)	Max. EIRP Averag e (mW)	Polarizati on Of Max. ERP	
1.4MHz Band. QPSK	6/0	1710.7	-1.38	3.12	27.58	23.08	203.074	Vertical	Pass
		1732.5	-1.45	3.27	27.61	22.89	194.661	Vertical	Pass
		1754.3	-1.56	3.29	27.63	22.78	189.825	Vertical	Pass
1.4MHz Band. 16 QAM	6/0	1710.7	-2.26	3.12	27.58	22.20	165.944	Vertical	Pass
		1732.5	-2.75	3.27	27.61	21.59	144.174	Vertical	Pass
		1754.3	-2.92	3.29	27.63	21.42	138.827	Vertical	Pass
3.0MHz Band. QPSK	15/0	1711.5	-1.14	3.13	27.61	23.34	215.991	Vertical	Pass
		1732.5	-1.41	3.27	27.61	22.93	196.165	Vertical	Pass
		1753.5	-1.08	3.30	27.62	23.24	211.029	Vertical	Pass
3.0MHz Band. 16 QAM	15/0	1711.5	-2.12	3.13	27.61	22.36	172.306	Vertical	Pass
		1732.5	-1.81	3.27	27.61	22.53	178.921	Vertical	Pass
		1753.5	-2.12	3.30	27.62	22.20	165.854	Vertical	Pass
5.0MHz Band. QPSK	25/0	1712.5	-1.31	3.13	27.63	23.19	208.513	Vertical	Pass
		1732.5	-1.92	3.27	27.61	22.42	174.764	Vertical	Pass
		1752.5	-2.03	3.30	27.60	22.27	168.740	Vertical	Pass
5.0MHz Band. 16 QAM	25/0	1712.5	-2.33	3.13	27.63	22.17	164.792	Vertical	Pass
		1732.5	-3.10	3.27	27.61	21.24	132.955	Vertical	Pass
		1752.5	-2.31	3.30	27.60	21.99	158.284	Vertical	Pass
10.0MHz Band. QPSK	50/0	1715	-1.69	3.15	27.64	22.80	190.376	Vertical	Pass
		1732.5	-2.20	3.31	27.61	22.10	162.214	Vertical	Pass
		1750	-1.60	3.33	27.59	22.66	184.300	Vertical	Pass
10.0MHz Band. 16 QAM	50/0	1715	-2.59	3.15	27.64	21.90	154.960	Vertical	Pass
		1732.5	-1.89	3.31	27.61	22.41	174.199	Vertical	Pass
		1750	-2.68	3.33	27.59	21.58	143.734	Vertical	Pass
15.0MHz Band. QPSK	75/0	1717.5	-1.68	3.15	27.65	22.82	191.227	Vertical	Pass
		1732.5	-1.45	3.31	27.61	22.85	192.541	Vertical	Pass
		1747.5	-1.01	3.33	27.57	23.23	210.178	Vertical	Pass
15.0MHz Band. 16 QAM	75/0	1717.5	-2.30	3.15	27.65	22.20	165.798	Vertical	Pass
		1732.5	-2.10	3.31	27.61	22.20	166.062	Vertical	Pass
		1747.5	-2.13	3.33	27.57	22.11	162.416	Vertical	Pass

20.0MHz Band. QPSK	100/ 0	1720	-1.42	3.17	27.66	23.07	202.887	Vertical	Pass
		1732.5	-1.66	3.32	27.61	22.63	183.161	Vertical	Pass
		1745	-1.86	3.36	27.56	22.34	171.541	Vertical	Pass
20.0MHz Band. 16 QAM	100/ 0	1720	-2.84	3.17	27.66	21.65	146.138	Vertical	Pass
		1732.5	-2.77	3.32	27.61	21.52	141.787	Vertical	Pass
		1745	-2.00	3.36	27.56	22.20	165.889	Vertical	Pass

Note:

SG Level= Signal generator output

Max. EIRP Average (dBm)= Antenna Gain(dB)+ SG Level (dBm)- Cable Loss(dBm)

Radiated Power (EIRP) for Band 4									
Mode	RB/RB SIZE	Frequency	Result						Conclusion
			SG Level (dBm)	Cable Loss (dBm)	Antenna Gain (dB)	Max. EIRP Average (dBm)	Max. EIRP Average (mW)	Polarization Of Max. ERP	
1.4MHz Band. QPSK	6/0	1710.7	-2.01	3.12	27.58	22.45	175.737	Horizontal	Pass
		1732.5	-2.42	3.27	27.61	21.92	155.428	Horizontal	Pass
		1754.3	-1.05	3.29	27.63	23.29	213.074	Horizontal	Pass
1.4MHz Band. 16 QAM	6/0	1710.7	-2.79	3.12	27.58	21.67	147.035	Horizontal	Pass
		1732.5	-2.27	3.27	27.61	22.07	160.963	Horizontal	Pass
		1754.3	-2.78	3.29	27.63	21.56	143.321	Horizontal	Pass
3.0MHz Band. QPSK	15/0	1711.5	-2.03	3.13	27.61	22.45	175.685	Horizontal	Pass
		1732.5	-1.10	3.27	27.61	23.24	210.654	Horizontal	Pass
		1753.5	-1.81	3.30	27.62	22.51	178.097	Horizontal	Pass
3.0MHz Band. 16 QAM	15/0	1711.5	-2.89	3.13	27.61	21.59	144.335	Horizontal	Pass
		1732.5	-2.63	3.27	27.61	21.71	148.167	Horizontal	Pass
		1753.5	-2.20	3.30	27.62	22.12	162.886	Horizontal	Pass
5.0MHz Band. QPSK	25/0	1712.5	-1.03	3.13	27.63	23.47	222.371	Horizontal	Pass
		1732.5	-1.96	3.27	27.61	22.38	172.908	Horizontal	Pass
		1752.5	-1.44	3.30	27.60	22.86	193.317	Horizontal	Pass
5.0MHz Band. 16 QAM	25/0	1712.5	-2.74	3.13	27.63	21.76	149.916	Horizontal	Pass
		1732.5	-2.73	3.27	27.61	21.61	144.983	Horizontal	Pass
		1752.5	-1.68	3.30	27.60	22.62	182.948	Horizontal	Pass
10.0MHz Band. QPSK	50/0	1715	-1.53	3.15	27.64	22.96	197.902	Horizontal	Pass
		1732.5	-1.19	3.31	27.61	23.11	204.529	Horizontal	Pass
		1750	-0.92	3.33	27.59	23.34	215.585	Horizontal	Pass
10.0MHz Band. 16 QAM	50/0	1715	-3.21	3.15	27.64	21.28	134.420	Horizontal	Pass
		1732.5	-2.96	3.31	27.61	21.34	136.244	Horizontal	Pass
		1750	-1.84	3.33	27.59	22.42	174.513	Horizontal	Pass
15.0MHz Band. QPSK	75/0	1717.5	-1.89	3.15	27.65	22.61	182.548	Horizontal	Pass
		1732.5	-1.52	3.31	27.61	22.78	189.593	Horizontal	Pass
		1747.5	-1.41	3.33	27.57	22.83	191.651	Horizontal	Pass
15.0MHz Band. 16 QAM	75/0	1717.5	-3.28	3.15	27.65	21.22	132.542	Horizontal	Pass
		1732.5	-2.64	3.31	27.61	21.66	146.609	Horizontal	Pass
		1747.5	-1.93	3.33	27.57	22.31	170.138	Horizontal	Pass
20.0MHz Band. QPSK	100/0	1720	-1.55	3.17	27.66	22.94	196.972	Horizontal	Pass
		1732.5	-1.31	3.32	27.61	22.98	198.388	Horizontal	Pass
		1745	-0.44	3.36	27.56	23.76	237.779	Horizontal	Pass



20.0MHz Band. 16 QAM	100/0	1720	-2.65	3.17	27.66	21.84	152.735	Horizontal	Pass
		1732.5	-2.96	3.32	27.61	21.33	135.957	Horizontal	Pass
		1745	-1.98	3.36	27.56	22.22	166.811	Horizontal	Pass

Note:

SG Level= Signal generator output

Max. EIRP Average (dBm)= Antenna Gain(dB)+ SG Level (dBm)- Cable Loss(dBm)

8.4 LTE BAND 13

Radiated Power (ERP) for Band 13									
Mode	RB/ RB SIZE	Frequency	Result						Conclusion
			SG Level (dBm )	Cabl e Loss (dBm )	Antenn a Gain (dB)	Max. EIRP Averag e (dBm)	Max. EIRP Averag e (mW)	Polarizatio n Of Max. ERP	
5.0MHz Band. QPSK	25/0	779.5	3.47	2.01	19.76	21.22	132.497	Vertical	Pass
		782	2.72	2.01	19.75	20.46	111.230	Vertical	Pass
		784.5	3.94	2.02	19.73	21.65	146.273	Vertical	Pass
5.0MHz Band. 16 QAM	25/0	779.5	1.95	2.01	19.76	19.70	93.416	Vertical	Pass
		782	2.21	2.01	19.75	19.95	98.877	Vertical	Pass
		784.5	2.79	2.02	19.73	20.50	112.179	Vertical	Pass
10.0MHz Band. QPSK	50/0	782	3.16	2.01	19.74	20.89	122.763	Vertical	Pass
10.0MHz Band. 16 QAM	50/0	782	2.01	2.01	19.74	19.74	94.174	Vertical	Pass

Note:

SG Level= Signal generator output

Max. EIRP Average (dBm)= Antenna Gain(dB)+ SG Level (dBm)- Cable Loss(dBm)

Radiated Power (EIRP) for Band 13									
Mode	RB/RB SIZE	Frequency	Result						Conclusion
			SG Level (dBm)	Cable Loss (dBm)	Antenna Gain (dB)	Max. EIRP Average (dBm)	Max. EIRP Average (mW)	Polarization Of Max. ERP	
5.0MHz Band. QPSK	25/0	779.5	3.07	2.01	19.76	20.82	120.712	Horizontal	Pass
		782	3.43	2.01	19.75	21.17	130.815	Horizontal	Pass
		784.5	4.16	2.02	19.73	21.87	153.643	Horizontal	Pass
5.0MHz Band. 16 QAM	25/0	779.5	2.04	2.01	19.76	19.79	95.239	Horizontal	Pass
		782	2.59	2.01	19.75	20.33	107.871	Horizontal	Pass
		784.5	1.98	2.02	19.73	19.69	93.017	Horizontal	Pass
10.0MHz Band. QPSK	50/0	782	2.92	2.01	19.74	20.65	116.137	Horizontal	Pass
10.0MHz Band. 16 QAM	50/0	782	3.06	2.01	19.74	20.79	119.968	Horizontal	Pass

Note:

SG Level= Signal generator output

Max. EIRP Average (dBm)= Antenna Gain(dB)+ SG Level (dBm)- Cable Loss(dBm)

## 9. FIELD STRENGTH OF SPURIOUS RADIATION

### RULE PART(S)

FCC: §2.1053, §22.917, §24.238 and §27.53

### LIMIT

§22.917 (e) and §24.238 (a): Out of band emissions. The power of any emission outside of the authorized operating frequency ranges must be attenuated below the transmitting power (P) by a factor of at least  $43 + 10 \log (P)$  dB.

§27.53 (g) For operations in the 698–746 MHz band, the power of any emission outside a licensee's frequency band(s) of operation shall be attenuated below the transmitter power (P) within the licensed band(s) of operation, measured in watts, by at least  $43 + 10 \log (P)$  dB.

§27.53 (h) For operations in the 1710–1755 MHz and 2110–2155 MHz bands, the power of any emission outside a licensee's frequency block shall be attenuated below the transmitter power (P) by at least  $43 + 10 \log_{10}(P)$  dB.

### TEST PROCEDURE

For Cellular equipment - Compliance with these rules is based on the use of measurement instrumentation employing a resolution bandwidth of 100 kHz or greater. In the 1 MHz bands immediately outside and adjacent to the frequency block a resolution bandwidth of at least one percent of the emission bandwidth of the fundamental emission of the transmitter may be employed. A narrower resolution bandwidth is permitted in all cases to improve measurement accuracy provided the measured power is integrated over the full required measurement bandwidth (i.e. 100 kHz or 1 percent of emission bandwidth, as specified). The emission bandwidth is defined as the width of the signal between two points, one below the carrier center frequency and one above the carrier center frequency, outside of which all emissions are attenuated at least 26 dB below the transmitter power.

For PCS equipment - Compliance with these rules is based on the use of measurement instrumentation employing a resolution bandwidth of 1 MHz or greater. However, in the 1 MHz bands immediately outside and adjacent to the frequency block a resolution bandwidth of at least one percent of the emission bandwidth of the fundamental emission of the transmitter may be employed. A narrower resolution bandwidth is permitted in all cases to improve measurement accuracy provided the measured power is integrated over the full required measurement bandwidth ( i.e. 1 MHz or 1 percent of emission bandwidth, as specified). The emission bandwidth is defined as the width of the signal between two points, one below the carrier center frequency and one above the carrier center frequency, outside of which all emissions are attenuated at least 26 dB below the transmitter power.

The unwanted emission power shall be measured with a resolution bandwidth of at least 1% of the occupied bandwidth in the 1 MHz band immediately outside and adjacent to the channel edge of the equipment. Beyond the 1 MHz band immediately outside the channel edge of the equipment, a resolution bandwidth of 1 MHz shall be employed. A narrower resolution bandwidth is allowed to be used provided that the measured power is integrated over the full required measurement bandwidth of 1 MHz or 1% of the occupied bandwidth as applicable.

The power of any unwanted emissions measured from the channel edge of the equipment shall be attenuated below the transmitter power, P (dBW), as follows:

- a. for base station and subscriber equipment, other than mobile subscriber equipment, the attenuation shall not be less than  $43 + 10 \text{ Log}_{10} (p)$ , dB; and
- b. for mobile subscriber equipment, the attenuation shall not be less than  $43 + 10 \text{ Log}_{10} (p)$ , dB at the channel edges and  $55 + 10 \text{ Log}_{10} (p)$  at 5.5 MHz away and beyond the channel edges where p in (a) and (b) is the transmitter power measured in watts.

**MODES TESTED**

- LTE Band 2
- LTE Band 4
- LTE Band 13

**RESULTS**

PASS

9.1 LTE BAND 2

**QPSK EIRP POWER FOR LTE BAND 2 (1.4MHZ BANDWIDTH)**

Test Results for Low Channel 1710.7MHz							
Frequency(MHz)	SG Level(dBm)	Cable Loss(dB)	Antenna Gain(dB)	Absolute Level(dBm)	Limit (dBm)	Margin(dBm)	Polarity
3701.4	-56.38	4.04	33.51	-26.91	-13	-13.91	Horizontal
3701.4	-55.68	4.04	33.51	-26.21	-13	-13.21	Vertical
5552.1	-55.46	5.24	35.84	-24.86	-13	-11.86	Vertical
5552.1	-59.64	5.24	35.84	-29.04	-13	-16.04	Horizontal
Test Results for Mid Channel 1732.5MHz							
3760.0	-53.64	4.04	33.56	-24.12	-13	-11.12	Horizontal
3760.0	-57.43	4.04	33.56	-27.91	-13	-14.91	Vertical
5640.0	-55.28	5.24	35.91	-24.61	-13	-11.61	Vertical
5640.0	-56.37	5.24	35.91	-25.70	-13	-12.70	Horizontal
Test Results for High Channel 1754.3MHz							
3818.6	-54.67	4.04	34.00	-24.71	-13	-11.71	Horizontal
3818.6	-53.59	4.04	34.00	-23.63	-13	-10.63	Vertical
5727.9	-58.49	5.24	36.04	-27.69	-13	-14.69	Vertical
5727.9	-56.57	5.24	36.04	-25.77	-13	-12.77	Horizontal

**QPSK EIRP POWER FOR LTE BAND 2 (20.0MHZ BANDWIDTH)**

Test Results for Low Channel 1710.7MHz							
Frequency(MHz)	SG Level(dBm)	Cable Loss(dB)	Antenna Gain(dB)	Absolute Level(dBm)	Limit (dBm)	Margin(dBm)	Polarity
3720	-57.33	4.07	33.54	-27.86	-13	-14.86	Horizontal
3720	-54.51	4.07	33.54	-25.04	-13	-12.04	Vertical
5580	-57.49	5.28	35.86	-26.91	-13	-13.91	Vertical
5580	-56.37	5.28	35.86	-25.79	-13	-12.79	Horizontal
Test Results for Mid Channel 1732.5MHz							
3760	-55.68	4.04	33.56	-26.16	-13	-13.16	Horizontal
3760	-54.26	4.04	33.56	-24.74	-13	-11.74	Vertical
5640	-56.38	5.24	35.91	-25.71	-13	-12.71	Vertical
5640	-57.48	5.24	35.91	-26.81	-13	-13.81	Horizontal
Test Results for High Channel 1754.3MHz							
3800	-57.42	4.04	34.00	-27.46	-13	-14.46	Horizontal
3800	-57.45	4.04	34.00	-27.49	-13	-14.49	Vertical
5700	-57.39	5.24	36.04	-26.59	-13	-13.59	Vertical
5700	-57.61	5.24	36.04	-26.81	-13	-13.81	Horizontal

Note: P<sub>Mea</sub>(dBm)= Power(dBm)+ ARpl (dBm)

. Over Limit= : P<sub>Mea</sub>(dBm)-Limit(dBm)

. We test both H direction and V direction, recorded worst case direction.

9.2 LTE BAND 4

**QPSK EIRP POWER FOR LTE BAND 4 (1.4MHZ BANDWIDTH)**

Test Results for Low Channel 1710.7MHz							
Frequency(MHz)	SG Level(dBm)	Cable Loss(dB)	Antenna Gain(dB)	Absolute Level(dBm)	Limit (dBm)	Margin(dBm)	Polarity
3421.4	-53.65	4.02	29.80	-27.87	-13	-14.87	Horizontal
3421.4	-56.33	4.02	29.80	-30.55	-13	-17.55	Vertical
5132.1	-57.46	5.24	35.84	-26.86	-13	-13.86	Vertical
5132.1	-56.19	5.24	35.84	-25.59	-13	-12.59	Horizontal
Test Results for Mid Channel 1732.5MHz							
3465.0	-53.37	4.03	30.00	-27.40	-13	-14.40	Horizontal
3465.0	-53.28	4.03	30.00	-27.31	-13	-14.31	Vertical
5197.5	-57.49	5.25	35.86	-26.88	-13	-13.88	Vertical
5197.5	-55.83	5.25	35.86	-25.22	-13	-12.22	Horizontal
Test Results for High Channel 1754.3MHz							
3508.6	-54.66	4.05	30.01	-28.70	-13	-15.70	Horizontal
3508.6	-56.39	4.05	30.01	-30.43	-13	-17.43	Vertical
5262.9	-53.29	5.26	35.86	-22.69	-13	-9.69	Vertical
5262.9	-52.44	5.26	35.86	-21.84	-13	-8.84	Horizontal

**QPSK EIRP POWER FOR LTE BAND 4 (20.0MHZ BANDWIDTH)**

Test Results for Low Channel 1710.7MHz							
Frequency(MHz)	SG Level(dBm)	Cable Loss(dB)	Antenna Gain(dB)	Absolute Level(dBm)	Limit (dBm)	Margin(dBm)	Polarity
3440.0	-54.41	4.02	29.80	-28.63	-13	-15.63	Horizontal
3440.0	-53.67	4.02	29.80	-27.89	-13	-14.89	Vertical
5160.0	-59.57	5.24	35.84	-28.97	-13	-15.97	Vertical
5160.0	-57.68	5.24	35.84	-27.08	-13	-14.08	Horizontal
Test Results for Mid Channel 1732.5MHz							
3465.0	-52.34	4.03	30.00	-26.37	-13	-13.37	Horizontal
3465.0	-55.43	4.03	30.00	-29.46	-13	-16.46	Vertical
5197.5	-56.39	5.25	35.86	-25.78	-13	-12.78	Vertical
5197.5	-54.27	5.25	35.86	-23.66	-13	-10.66	Horizontal
Test Results for High Channel 1754.3MHz							
2490.0	-52.43	2.91	27.68	-27.66	-13	-14.66	Horizontal
3490.0	-53.18	2.91	27.68	-28.41	-13	-15.41	Vertical
5235.0	-54.67	5.26	35.86	-24.07	-13	-11.07	Vertical
5235.0	-55.38	5.26	35.86	-24.78	-13	-11.78	Horizontal

Note: P<sub>Mea</sub>(dBm)= Power(dBm)+ ARpl (dBm)

Over Limit= : P<sub>Mea</sub>(dBm)-Limit(dBm)

We test both H direction and V direction, recorded worst case direction.



9.3 LTE BAND 13

**QPSK EIRP POWER FOR LTE BAND 13 (5.0MHZ BANDWIDTH)**

Test Results for Low Channel 779.5MHz							
Frequency(MHz)	SG Level(dBm)	Cable Loss(dB)	Antenna Gain(dB)	Absolute Level(dBm)	Limit (dBm)	Margin(dBm)	Polarity
1559.0	-53.62	2.62	27.3	-23.04	-13	-10.04	Horizontal
1559.0	-51.11	2.62	27.3	-20.53	-13	-7.53	Vertical
2338.5	-54.46	2.87	27.62	-23.28	-13	-10.28	Vertical
2338.5	-53.92	2.87	27.62	-22.74	-13	-9.74	Horizontal
Test Results for Mid Channel 782MHz							
1564.0	-53.74	2.64	27.33	-23.15	-13	-10.15	Horizontal
1564.0	-54.49	2.64	27.33	-23.90	-13	-10.90	Vertical
2346.0	-55.52	2.88	27.67	-24.34	-13	-11.34	Vertical
2346.0	-56.82	2.88	27.67	-25.64	-13	-12.64	Horizontal
Test Results for High Channel 784.5MHz							
1569.0	-56.29	2.64	27.33	-25.70	-13	-12.70	Horizontal
1569.0	-53.61	2.64	27.33	-23.02	-13	-10.02	Vertical
2353.5	-54.47	2.88	27.67	-23.28	-13	-10.28	Vertical
2353.5	-58.13	2.88	27.67	-26.94	-13	-13.94	Horizontal

**QPSK EIRP POWER FOR LTE BAND 13 (10.0MHZ BANDWIDTH)**

Test Results for Channel 782MHz							
Frequency(MHz)	SG Level(dBm)	Cable Loss(dB)	Antenna Gain(dB)	Absolute Level(dBm)	Limit (dBm)	Margin(dBm)	Polarity
1564.0	-57.23	2.64	27.33	-26.64	-13	-13.64	Horizontal
1564.0	-56.39	2.64	27.33	-25.80	-13	-12.80	Vertical
2346.0	-56.48	2.88	27.67	-25.29	-13	-12.29	Vertical
2346.0	-52.67	2.88	27.67	-21.48	-13	-8.48	Horizontal

Note: P<sub>Mea</sub>(dBm)= Power(dBm)+ ARpl (dBm)

. Over Limit= : P<sub>Mea</sub>(dBm)-Limit(dBm)

. We test both H direction and V direction, recorded worst case direction.

## 10. FREQUENCY STABILITY

### RULE PART(S)

FCC: §2.1055, §22.355, §24.235, §27.54

### LIMITS

§22.355 - The carrier frequency shall not depart from the reference frequency in excess of  $\pm 2.5$  ppm for mobile stations.

§24.235 - The frequency stability shall be sufficient to ensure that the fundamental emission stays within the authorized frequency block.

### TEST PROCEDURE

Use CMW 500 with Frequency Error measurement capability.

Temp. =  $-30^{\circ}$  to  $+50^{\circ}\text{C}$

Voltage = low voltage, DC 3.23V, Normal, DC 3.8V and High voltage, DC 4.37V.

### Frequency Stability vs Temperature:

The EUT is placed inside a temperature chamber. The temperature is set to  $-30^{\circ}\text{C}$  and allowed to stabilize. After sufficient soak time, the transmitting frequency error is measured. The temperature is increased by 10 degrees, allowed to stabilize and soak, and then the measurement is repeated. This is repeated until  $+50^{\circ}\text{C}$  is reached.

### Frequency Stability vs Voltage:

The peak frequency error is recorded (worst-case).

### MODES TESTED

LTE Band 2

LTE Band 4

LTE Band 13

## RESULTS

See the following pages.

10.1 LTE BAND 2

QPSK, (20MHz BANDWIDTH)

**Frequency error vs. Voltage**

Voltage [Vdc]	Frequency [MHz]	Frequency* Error[Hz]	Frequency Error[ppm]	Limit [ppm]
<b>BAND 2 QPSK, (CH 18900 RB size 100 RB Offset 0 20MHz BANDWIDTH)</b>				
3.23	1880	-10.5	-0.005585	2.5
3.8	1880	-16.5	-0.008777	2.5
4.37	1880	-11.2	-0.005957	2.5

**Frequency error vs. Temperature**

Temperature [° C]	Frequency [MHz]	Frequency* Error[Hz]	Frequency Error[ppm]	Limit [ppm]
<b>BAND 2 QPSK, (CH 18900 RB size 100 RB Offset 0 20MHz BANDWIDTH)</b>				
Normal (25C)	1880	-10.3	-0.005479	2.5
Extreme (50C)	1880	-7.6	-0.004043	2.5
Extreme (40C)	1880	-9.6	-0.005106	2.5
Extreme (30C)	1880	-12.5	-0.006649	2.5
Extreme (10C)	1880	-11.4	-0.006064	2.5
Extreme (0C)	1880	-10.6	-0.005638	2.5
Extreme (-10C)	1880	-10.2	-0.005426	2.5
Extreme (-20C)	1880	-6.7	-0.003564	2.5
Extreme (-30C)	1880	-10.7	-0.005691	2.5

**16QAM, (20MHz BANDWIDTH)**

**Frequency error vs. Voltage**

Voltage [Vdc]	Frequency [MHz]	Frequency* Error[Hz]	Frequency Error[ppm]	Limit [ppm]
<b>BAND 2 16QAM, (CH 18900 RB size 100 RB Offset 0 20MHz BANDWIDTH)</b>				
3.23	1880	-10.5	-0.005585	2.5
3.8	1880	-15.4	-0.008191	2.5
4.37	1880	-12.7	-0.006755	2.5

**Frequency error vs. Temperature**

Temperature [° C]	Frequency [MHz]	Frequency* Error[Hz]	Frequency Error[ppm]	Limit [ppm]
<b>BAND 2 16QAM, (CH 18900 RB size 100 RB Offset 0 20MHz BANDWIDTH)</b>				
Normal (25C)	1880	-11.2	-0.005957	2.5
Extreme (50C)	1880	-10.3	-0.005479	2.5
Extreme (40C)	1880	-12.6	-0.006702	2.5
Extreme (30C)	1880	-9.6	-0.005106	2.5
Extreme (10C)	1880	-10.4	-0.005532	2.5
Extreme (0C)	1880	-12.5	-0.006649	2.5
Extreme (-10C)	1880	-8.6	-0.004574	2.5
Extreme (-20C)	1880	-10.7	-0.005691	2.5
Extreme (-30C)	1880	-9.9	-0.005266	2.5

\*Note: Frequency error measurements were made by using the build-in capability of the Wireless Communication Test Set.

10.2 LTE BAND 4

QPSK, (10MHz BANDWIDTH)

**Frequency error vs. Voltage**

Voltage [Vdc]	Frequency [MHz]	Frequency* Error[Hz]	Frequency Error[ppm]	Limit [ppm]
<b>BAND 4 QPSK, (CH 20175 RB size 100 RB Offset 0 20MHz BANDWIDTH)</b>				
3.23	1732.5	-11.6	-0.006696	2.5
3.8	1732.5	-16.0	-0.009235	2.5
4.37	1732.5	-13.4	-0.007734	2.5

**Frequency error vs. Temperature**

Temperature [°C]	Frequency [MHz]	Frequency* Error[Hz]	Frequency Error[ppm]	Limit [ppm]
<b>BAND 4 QPSK, (CH 20175 RB size 100 RB Offset 0 20MHz BANDWIDTH)</b>				
Normal (25C)	1732.5	-11.4	-0.006580	2.5
Extreme (50C)	1732.5	-15.3	-0.008831	2.5
Extreme (40C)	1732.5	-15.7	-0.009062	2.5
Extreme (30C)	1732.5	-13.4	-0.007734	2.5
Extreme (10C)	1732.5	-12.8	-0.007388	2.5
Extreme (0C)	1732.5	-15.6	-0.009004	2.5
Extreme (-10C)	1732.5	-15.4	-0.008889	2.5
Extreme (-20C)	1732.5	-13.8	-0.007965	2.5
Extreme (-30C)	1732.5	-13.6	-0.007850	2.5

**16QAM, (20MHz BANDWIDTH)**

**Frequency error vs. Voltage**

Voltage [Vdc]	Frequency [MHz]	Frequency* Error[Hz]	Frequency Error[ppm]	Limit [ppm]
<b>BAND 4 16QAM, (CH 20175 RB size 100 RB Offset 0 20MHz BANDWIDTH)</b>				
3.23	1732.5	-12.6	-0.007273	2.5
3.8	1732.5	-13.4	-0.007734	2.5
4.37	1732.5	-10.8	-0.006234	2.5

**Frequency error vs. Temperature**

Temperature [°C]	Frequency [MHz]	Frequency* Error[Hz]	Frequency Error[ppm]	Limit [ppm]
<b>BAND 4 16QAM, (CH 20175 RB size 100 RB Offset 0 20MHz BANDWIDTH)</b>				
Normal (25C)	1732.5	-12.5	-0.007215	2.5
Extreme (50C)	1732.5	-11.6	-0.006696	2.5
Extreme (40C)	1732.5	-11.9	-0.006869	2.5
Extreme (30C)	1732.5	-9.3	-0.005368	2.5
Extreme (10C)	1732.5	-13.7	-0.007908	2.5
Extreme (0C)	1732.5	-11.4	-0.006580	2.5
Extreme (-10C)	1732.5	-12.6	-0.007273	2.5
Extreme (-20C)	1732.5	-13.2	-0.007619	2.5
Extreme (-30C)	1732.5	-12.9	-0.007446	2.5

**\*Note:** Frequency error measurements were made by using the build-in capability of the Wireless Communication Test Set.

10.3 LTE BAND 13

QPSK, (10MHz BANDWIDTH)

**Frequency error vs. Voltage**

Voltage [Vdc]	Frequency [MHz]	Frequency* Error[Hz]	Frequency Error[ppm]	Limit [ppm]
<b>BAND 13 QPSK, (CH 23230 RB size 50 RB Offset 0 10MHz BANDWIDTH)</b>				
3.23	782.0	9.4	0.003708	2.5
3.8	782.0	12.3	0.004852	2.5
4.37	782.0	8.6	0.003393	2.5

**Frequency error vs. Temperature**

Temperature [° C]	Frequency [MHz]	Frequency* Error[Hz]	Frequency Error[ppm]	Limit [ppm]
<b>BAND 13 QPSK, (CH 23230 RB size 50 RB Offset 0 10MHz BANDWIDTH)</b>				
Normal (25C)	782.0	9.5	0.003748	2.5
Extreme (50C)	782.0	10.2	0.004024	2.5
Extreme (40C)	782.0	8.3	0.003274	2.5
Extreme (30C)	782.0	11.7	0.004615	2.5
Extreme (10C)	782.0	9.6	0.003787	2.5
Extreme (0C)	782.0	10.3	0.004063	2.5
Extreme (-10C)	782.0	9.8	0.003866	2.5
Extreme (-20C)	782.0	9.1	0.003590	2.5
Extreme (-30C)	782.0	11.5	0.004536	2.5



**16QAM, (10MHz BANDWIDTH)**

**Frequency error vs. Voltage**

Voltage [Vdc]	Frequency [MHz]	Frequency* Error[Hz]	Frequency Error[ppm]	Limit [ppm]
<b>BAND 13 16QAM, (CH 23230 RB size 50 RB Offset 0 10MHz BANDWIDTH)</b>				
3.23	782.0	9.6	0.003787	2.5
3.8	782.0	7.8	0.003077	2.5
4.37	782.0	10.0	0.003945	2.5

**Frequency error vs. Temperature**

Temperature [° C]	Frequency [MHz]	Frequency* Error[Hz]	Frequency Error[ppm]	Limit [ppm]
<b>BAND 13 16QAM, (CH 23230 RB size 50 RB Offset 0 10MHz BANDWIDTH)</b>				
Normal (25C)	782.0	9.8	0.003866	2.5
Extreme (50C)	782.0	9.4	0.003708	2.5
Extreme (40C)	782.0	11.4	0.004497	2.5
Extreme (30C)	782.0	5.2	0.002051	2.5
Extreme (10C)	782.0	6.7	0.002643	2.5
Extreme (0C)	782.0	4.9	0.001933	2.5
Extreme (-10C)	782.0	10.1	0.003984	2.5
Extreme (-20C)	782.0	8.8	0.003471	2.5
Extreme (-30C)	782.0	8.3	0.003274	2.5

\***Note:** Frequency error measurements were made by using the build-in capability of the Wireless Communication Test Set.

## 11. Peak-to-Average Ratio

### 11.1 Description of the PAR Measurement

The peak-to-average ratio (PAR) of the transmission may not exceed 13 dB.

### 11.2 Measuring Instruments

See list of measuring instruments of this test report.

### 11.3 Test Procedures

1. The EUT was connected to Spectrum Analyzer and Base Station via power divider.
2. The RF output of EUT was connected to the spectrum analyzer by RF cable and attenuator. The path loss was compensated to the results for each measurement.
3. For GSM/EGPRS operating modes:
  - a. Set the RBW = 1MHz, VBW = 1MHz, Peak detector in spectrum analyzer.
  - b. Set EUT in maximum power output, and triggered the burst signal.
  - c. Measured respectively the Peak level and Mean level, and the deviation was recorded as Peak to Average Ratio.
4. For UMTS operating modes:
  - a. Set the CCDF (Complementary Cumulative Distribution Function) option in spectrum analyzer.
  - b. The highest RF powers were measured and recorded the maximum PAPR level associated with a probability of 0.1 %.

### 11.4 Test Setup

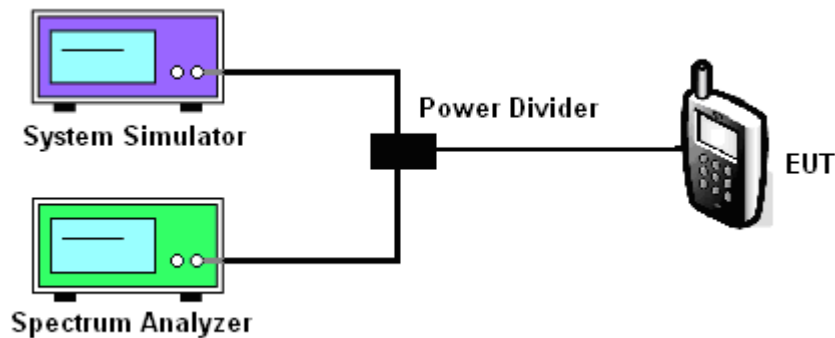

#### MODES TESTED

- LTE Band 2
- LTE Band 4
- LTE Band 13

BAND	CHANNEL	Frequency [MHz]	BANDWIDTH	NO. RB	RB POS.	MODULATION	PAR [dB]
2	18900	1880.0	1.4	1	Low	QPSK	2.21
2	18900	1880.0	1.4	1	Low	16-QAM	2.55
2	18900	1880.0	3.0	1	Low	QPSK	0.80
2	18900	1880.0	3.0	1	Low	16-QAM	1.40
2	18900	1880.0	5.0	1	Low	QPSK	0.72
2	18900	1880.0	5.0	1	Low	16-QAM	0.87
2	18900	1880.0	10.0	1	Low	QPSK	0.51
2	18900	1880.0	10.0	1	Low	16-QAM	0.57
2	18900	1880.0	15.0	1	Low	QPSK	0.43
2	18900	1880.0	15.0	1	Low	16-QAM	0.70
2	18900	1880.0	20.0	1	Low	QPSK	0.56
2	18900	1880.0	20.0	1	Low	16-QAM	0.69
4	20175	1732.5	1.4	1	Low	QPSK	2.29
4	20175	1732.5	1.4	1	Low	16-QAM	2.48
4	20175	1732.5	3.0	1	Low	QPSK	0.78
4	20175	1732.5	3.0	1	Low	16-QAM	1.55
4	20175	1732.5	5.0	1	Low	QPSK	0.77
4	20175	1732.5	5.0	1	Low	16-QAM	0.97
4	20175	1732.5	10.0	1	Low	QPSK	0.65
4	20175	1732.5	10.0	1	Low	16-QAM	0.58

4	20175	1732.5	15.0	1	Low	QPSK	0.44
4	20175	1732.5	15.0	1	Low	16-QAM	0.57
4	20175	1732.5	20.0	1	Low	QPSK	0.53
4	20175	1732.5	20.0	1	Low	16-QAM	0.59
13	23230	782.0	5.0	1	Low	QPSK	0.88
13	23230	782.0	5.0	1	Low	16-QAM	1.14
13	23230	782.0	10.0	1	Low	QPSK	1.17
13	23230	782.0	10.0	1	Low	16-QAM	1.24

11.5 LTE BAND 2

Band 2, UL Channel 18900, UL Frequency 1880.0, BW 1.4, NO. RB 1, RB POS. Low, QPSK

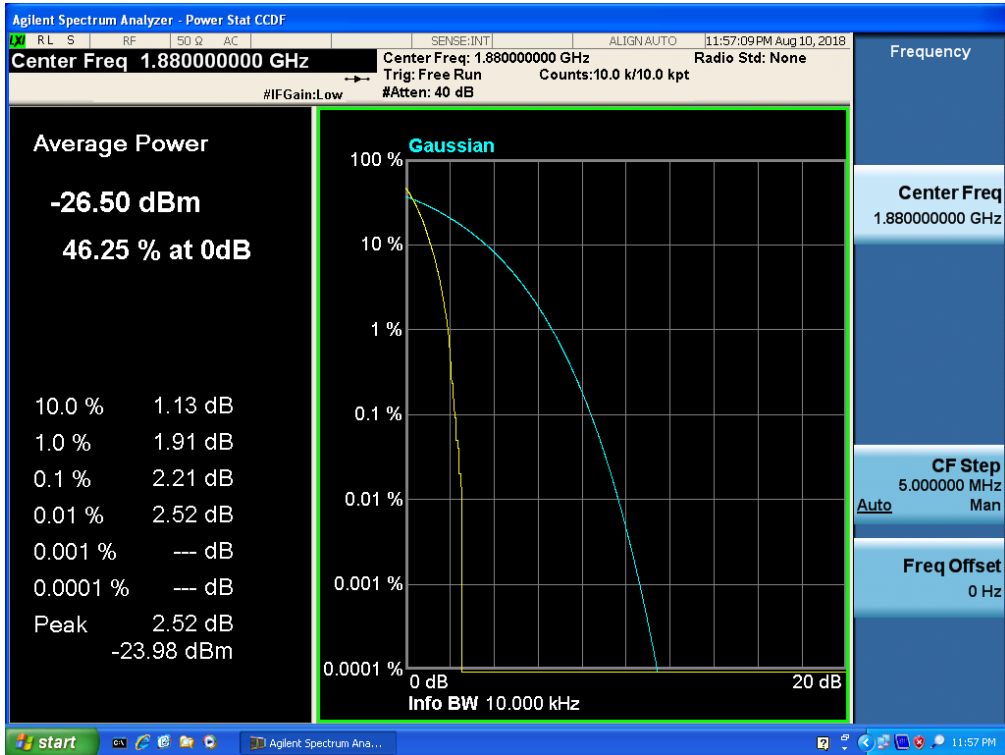

Band 2, UL Channel 18900, UL Frequency 1880.0, BW 1.4, NO. RB 1, RB POS. Low, 16-QAM

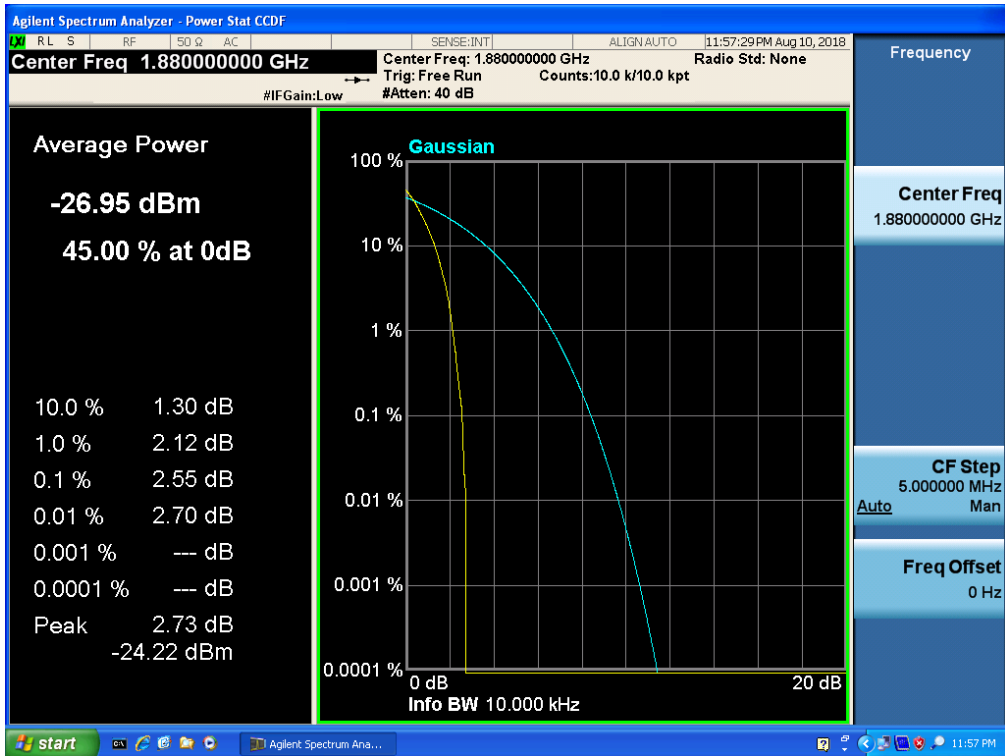

Band 2, UL Channel 18900, UL Frequency 1880.0, BW 3.0, NO. RB 1, RB POS. Low, QPSK

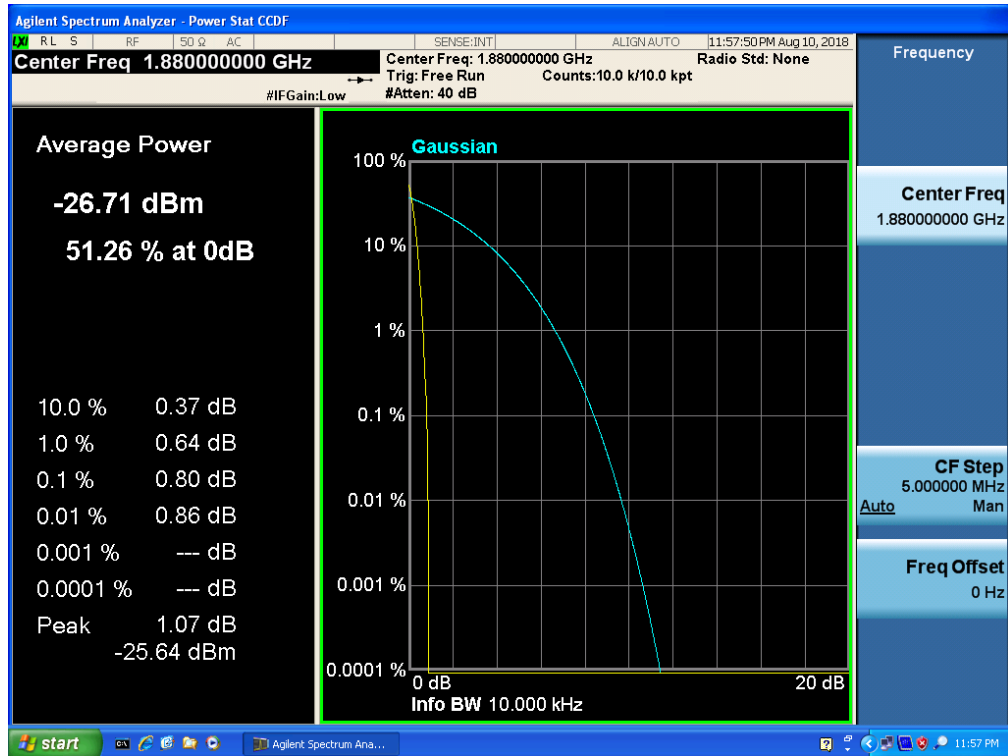

Band 2, UL Channel 18900, UL Frequency 1880.0, BW 3.0, NO. RB 1, RB POS. Low, 16-QAM

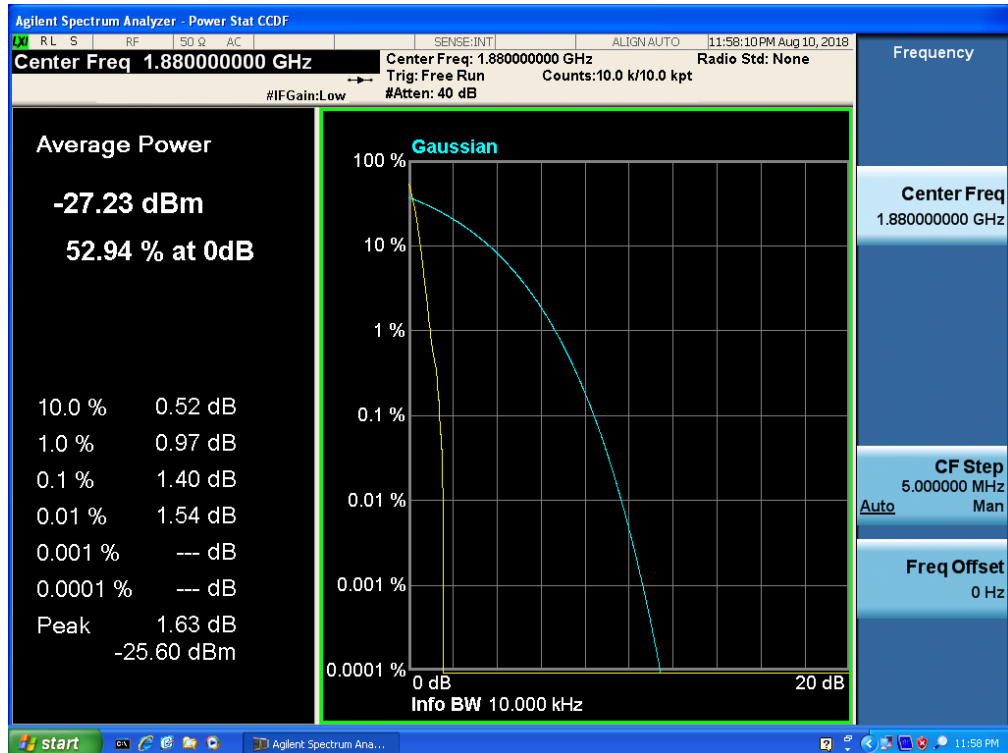

Band 2, UL Channel 18900, UL Frequency 1880.0, BW 5.0, NO. RB 1, RB POS. Low, QPSK

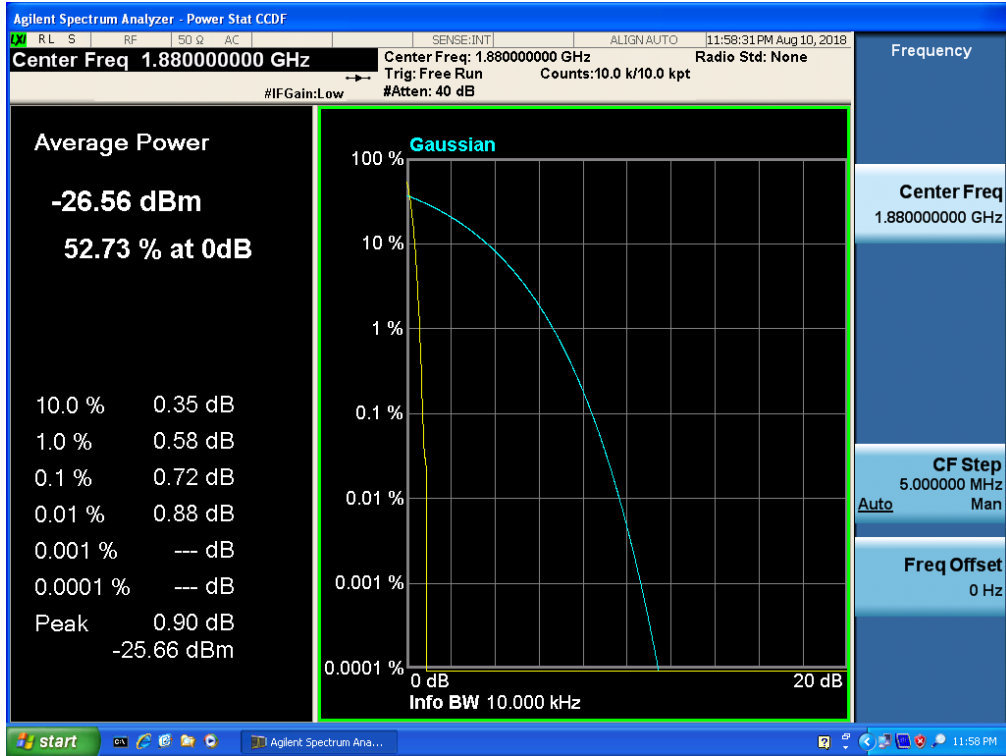

Band 2, UL Channel 18900, UL Frequency 1880.0, BW 5.0, NO. RB 1, RB POS. Low, 16-QAM

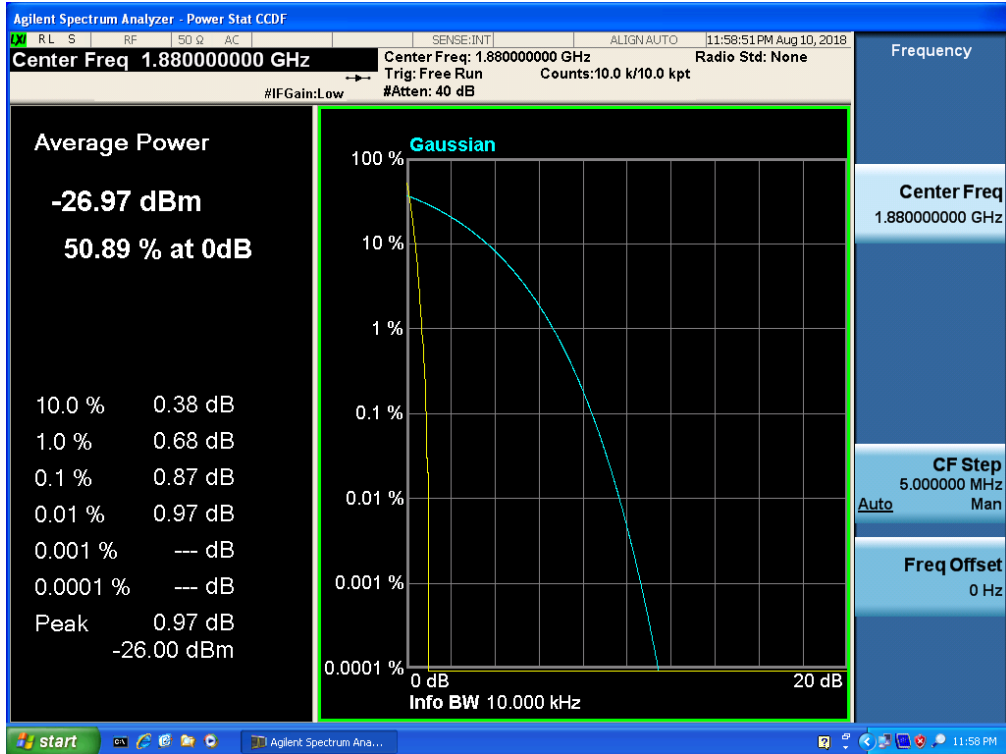

Band 2, UL Channel 18900, UL Frequency 1880.0, BW 10.0, NO. RB 1, RB POS. Low, QPSK

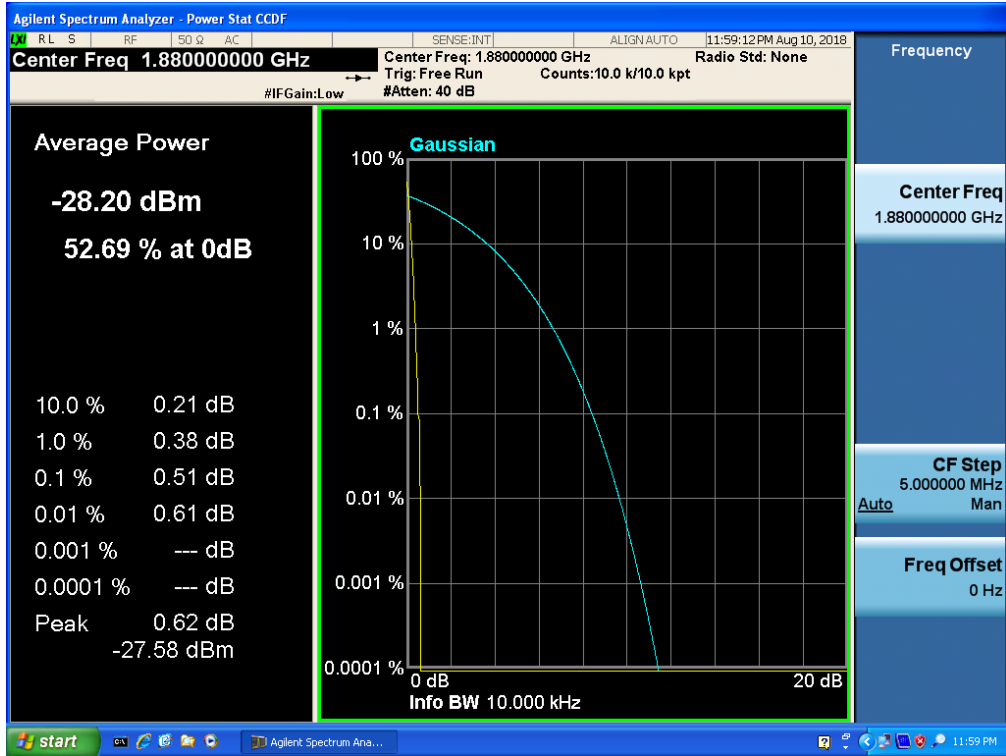

Band 2, UL Channel 18900, UL Frequency 1880.0, BW 10.0, NO. RB 1, RB POS. Low, 16-QAM

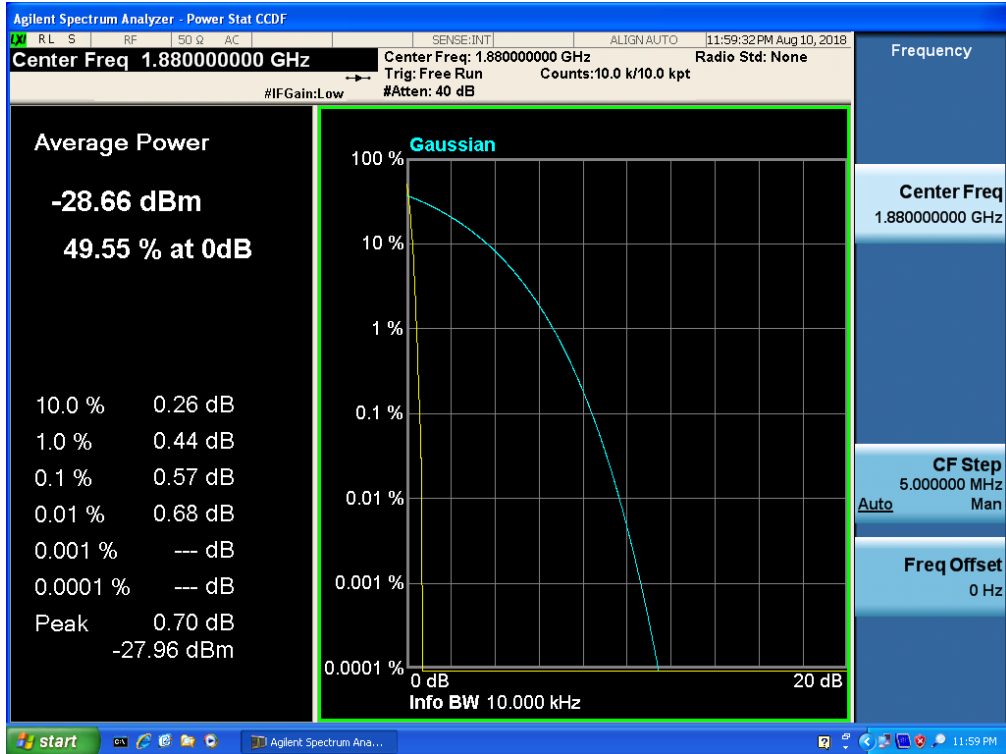



Band 2, UL Channel 18900, UL Frequency 1880.0, BW 15.0, NO. RB 1, RB POS. Low, QPSK

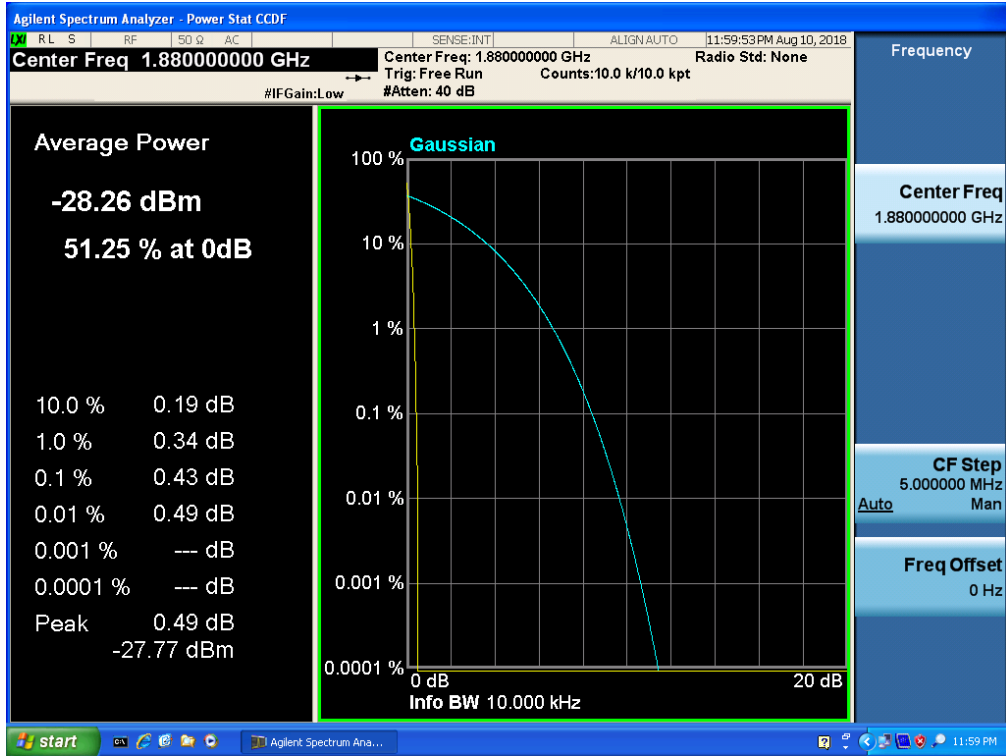

Band 2, UL Channel 18900, UL Frequency 1880.0, BW 15.0, NO. RB 1, RB POS. Low, 16-QAM

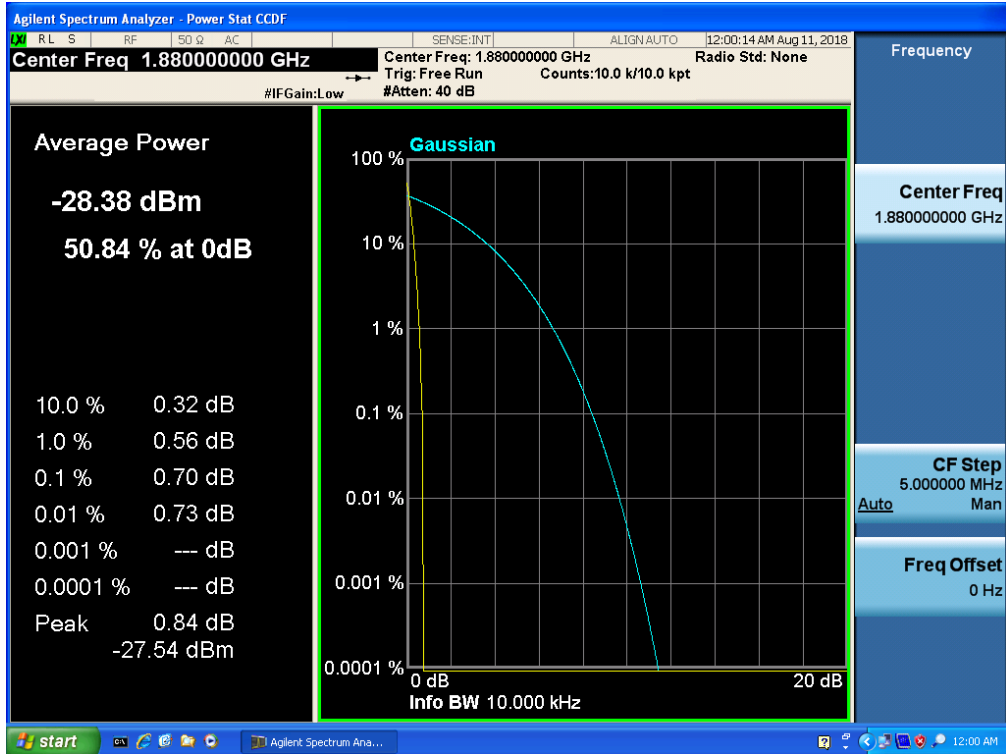

Band 2, UL Channel 18900, UL Frequency 1880.0, BW 20.0, NO. RB 1, RB POS. Low, QPSK

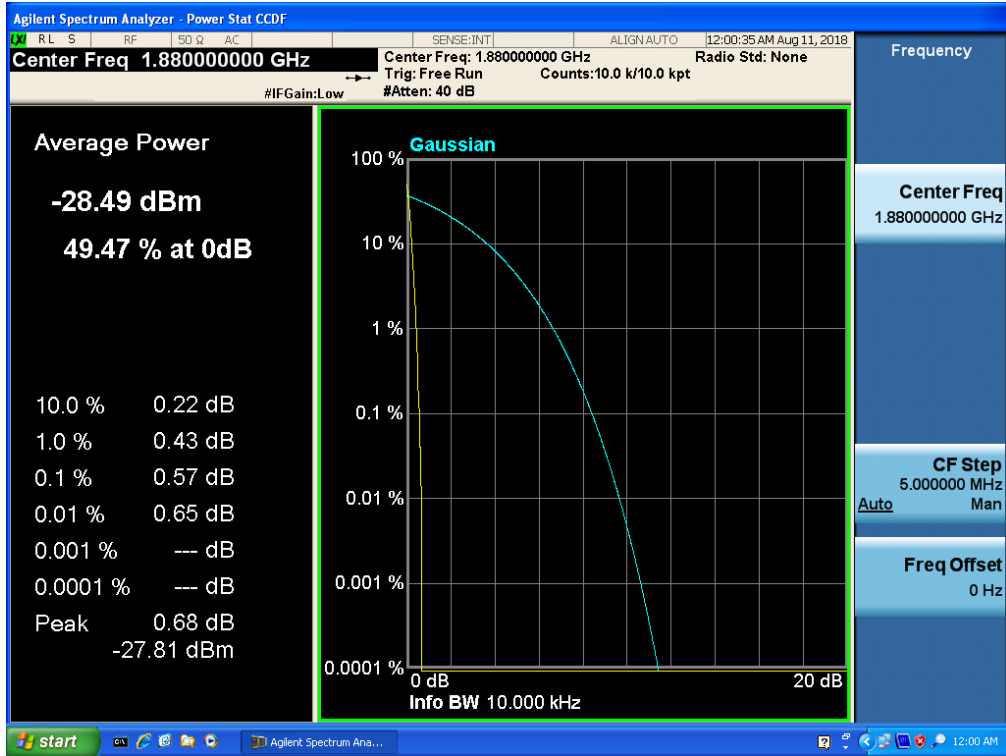

Band 2, UL Channel 18900, UL Frequency 1880.0, BW 20.0, NO. RB 1, RB POS. Low, 16-QAM

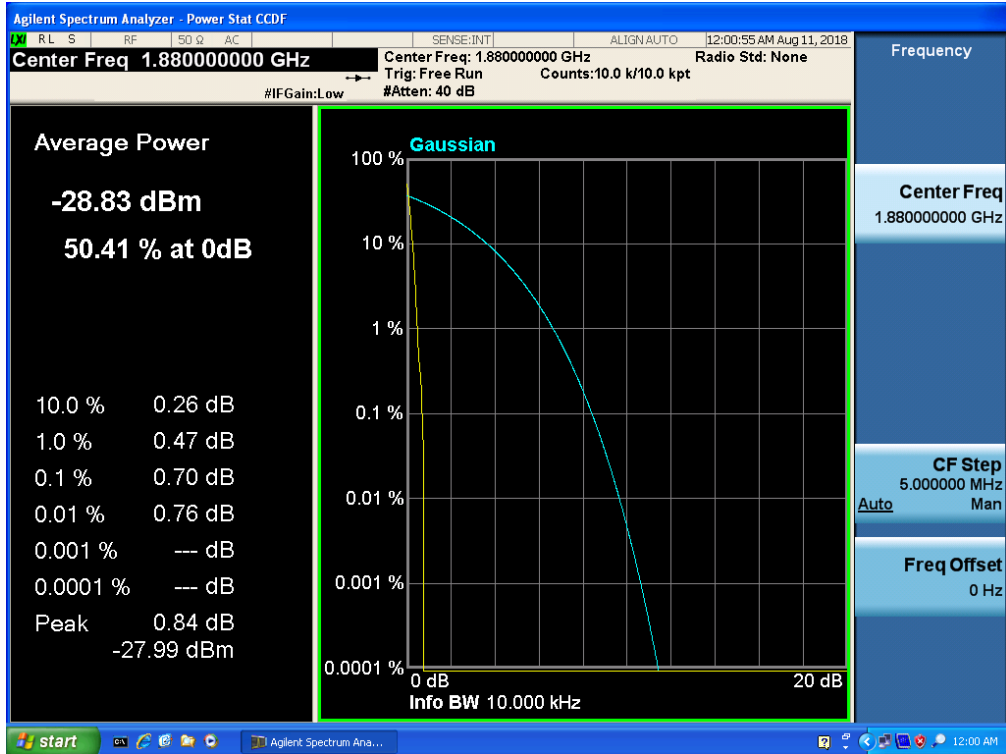

**11.6 LTE BAND 4**

*Band 4, UL Channel 20175, UL Frequency 1732.5, BW 1.4, NO. RB 1, RB POS. Low, QPSK*

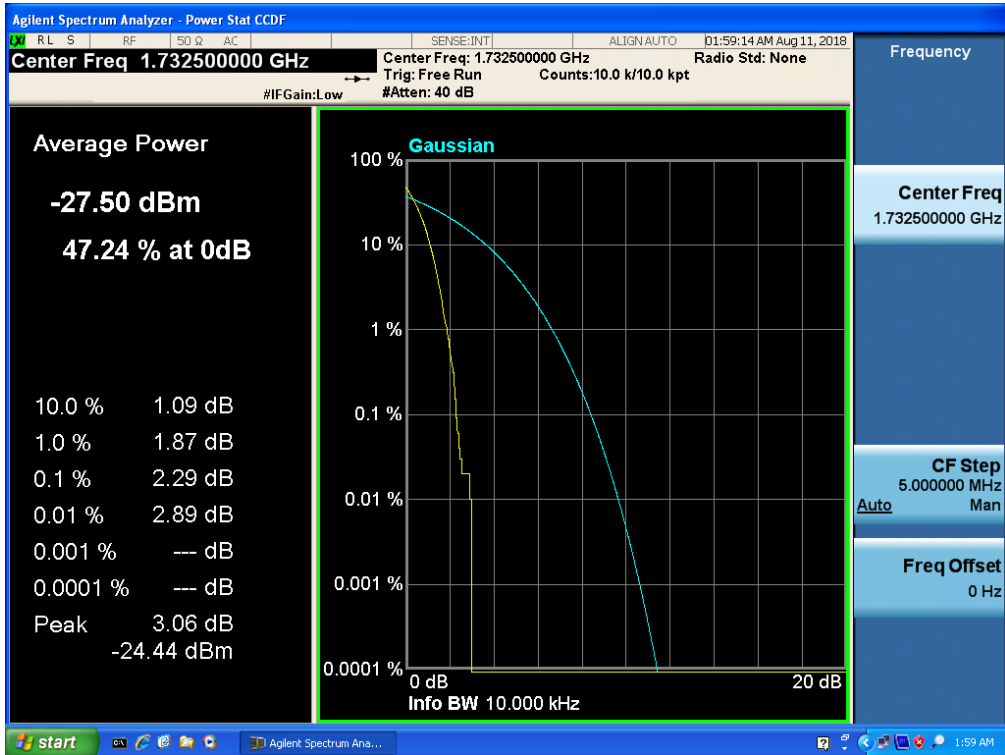

*Band 4, UL Channel 20175, UL Frequency 1732.5, BW 1.4, NO. RB 1, RB POS. Low, 16-QAM*

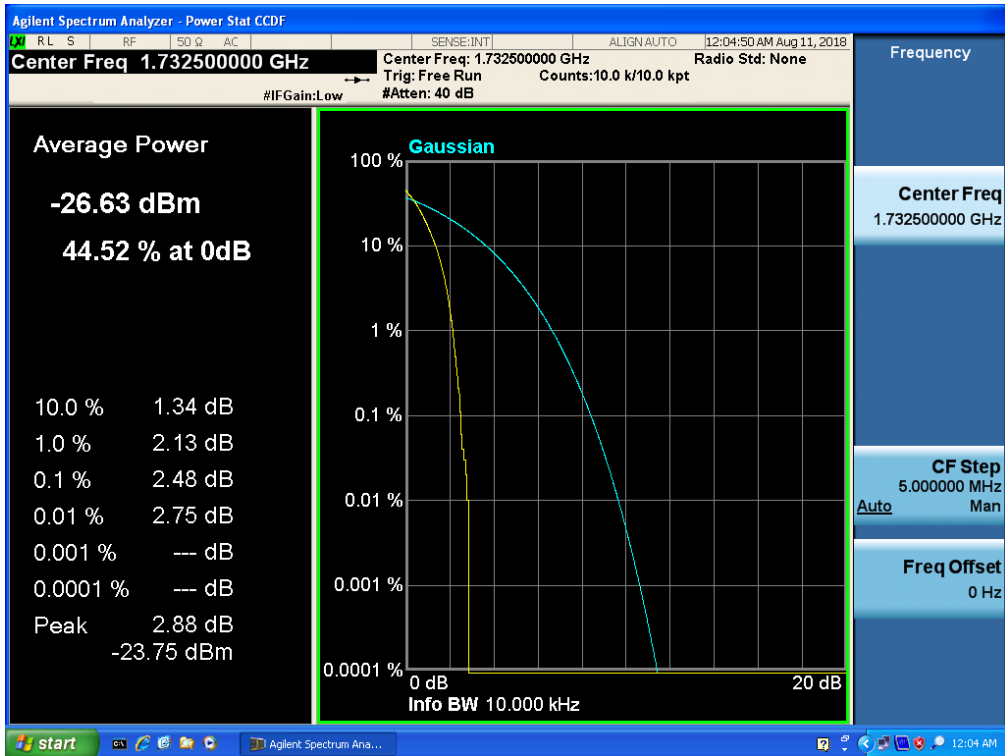

Band 4, UL Channel 20175, UL Frequency 1732.5, BW 3.0, NO. RB 1, RB POS. Low, QPSK

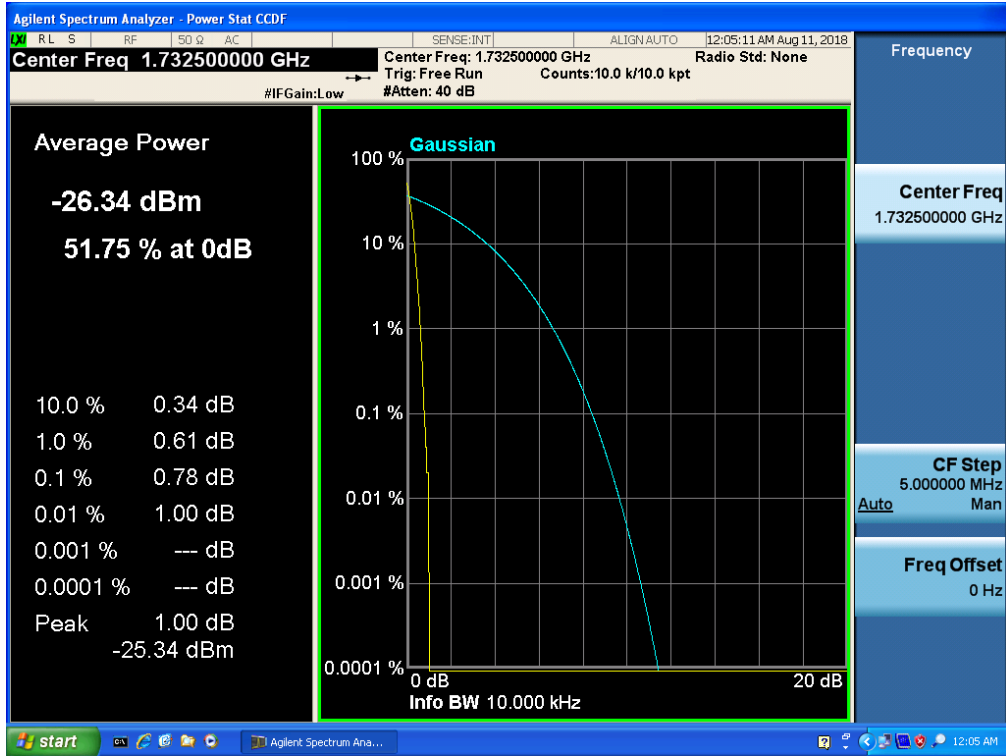

Band 4, UL Channel 20175, UL Frequency 1732.5, BW 3.0, NO. RB 1, RB POS. Low, 16-QAM

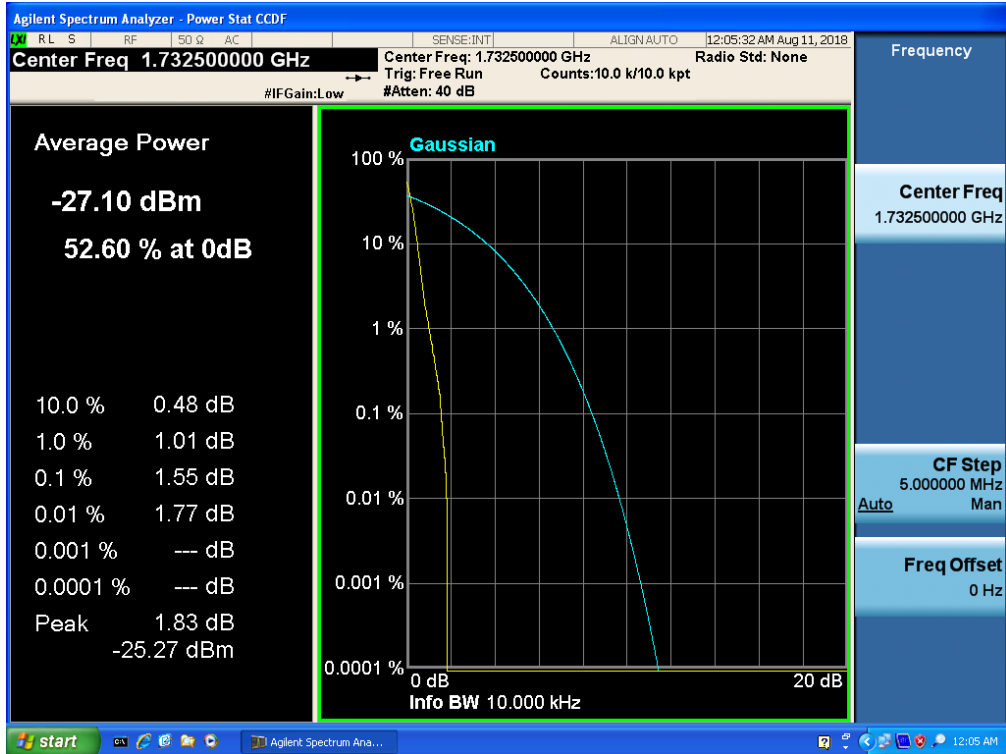

Band 4, UL Channel 20175, UL Frequency 1732.5, BW 5.0, NO. RB 1, RB POS. Low, QPSK

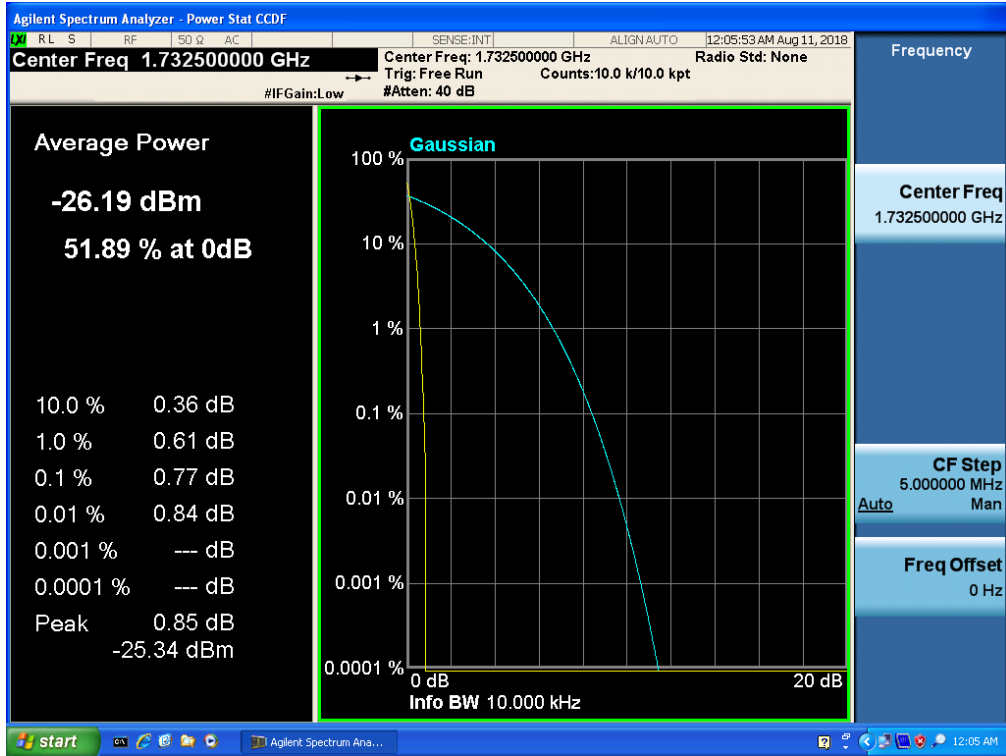

Band 4, UL Channel 20175, UL Frequency 1732.5, BW 5.0, NO. RB 1, RB POS. Low, 16-QAM

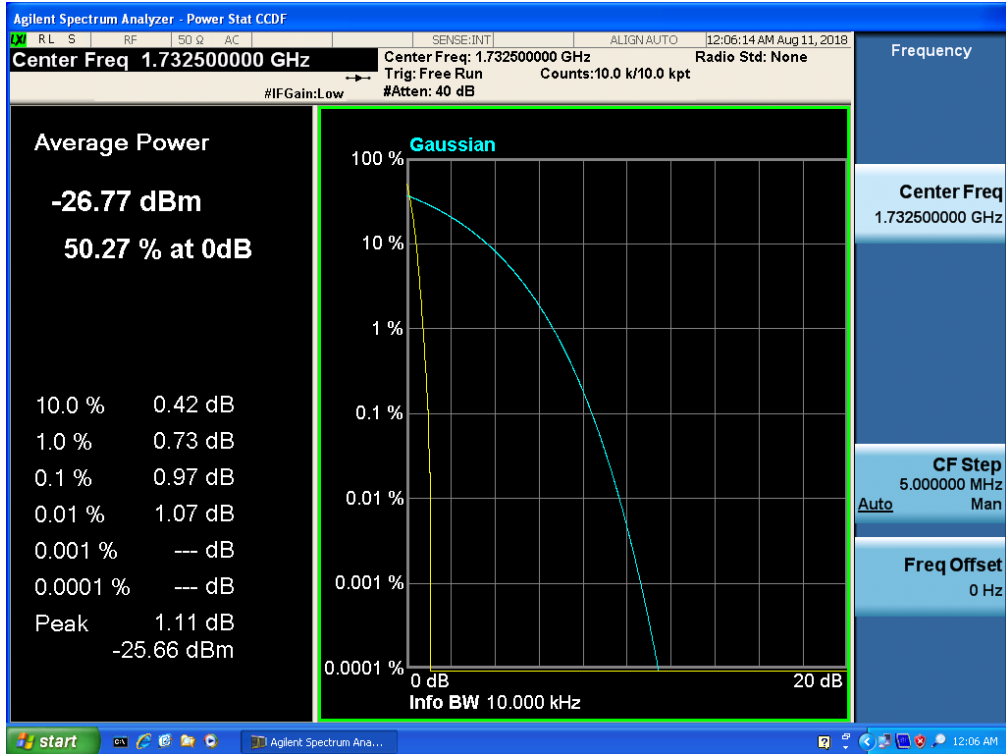

Band 4, UL Channel 20175, UL Frequency 1732.5, BW 10.0, NO. RB 1, RB POS. Low, QPSK

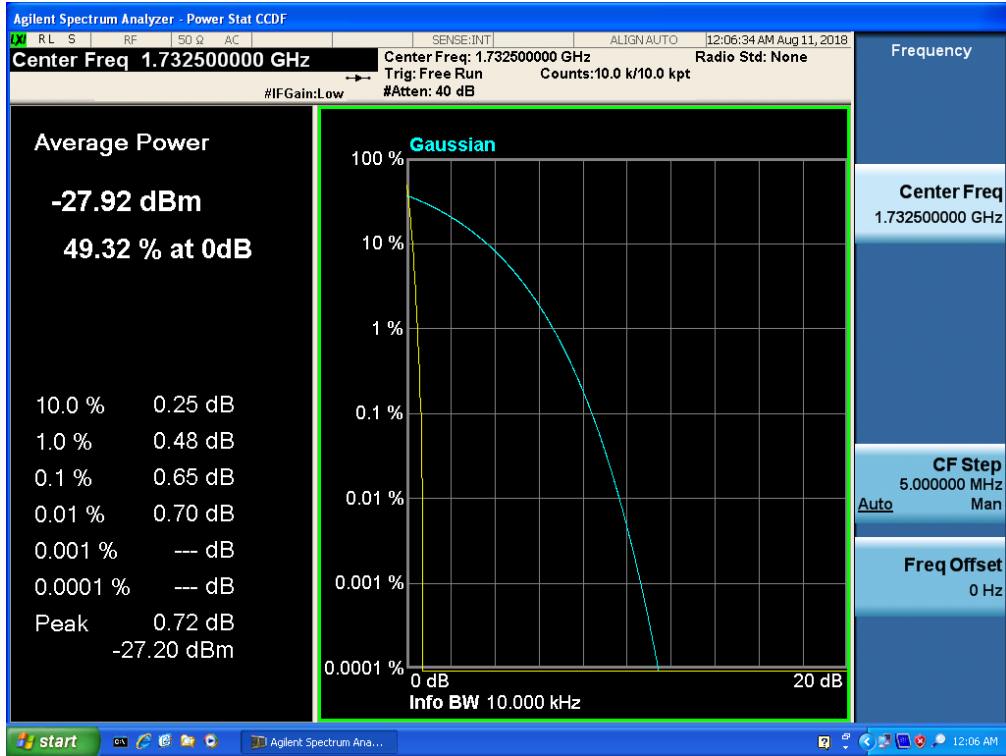

Band 4, UL Channel 20175, UL Frequency 1732.5, BW 10.0, NO. RB 1, RB POS. Low, 16-QAM

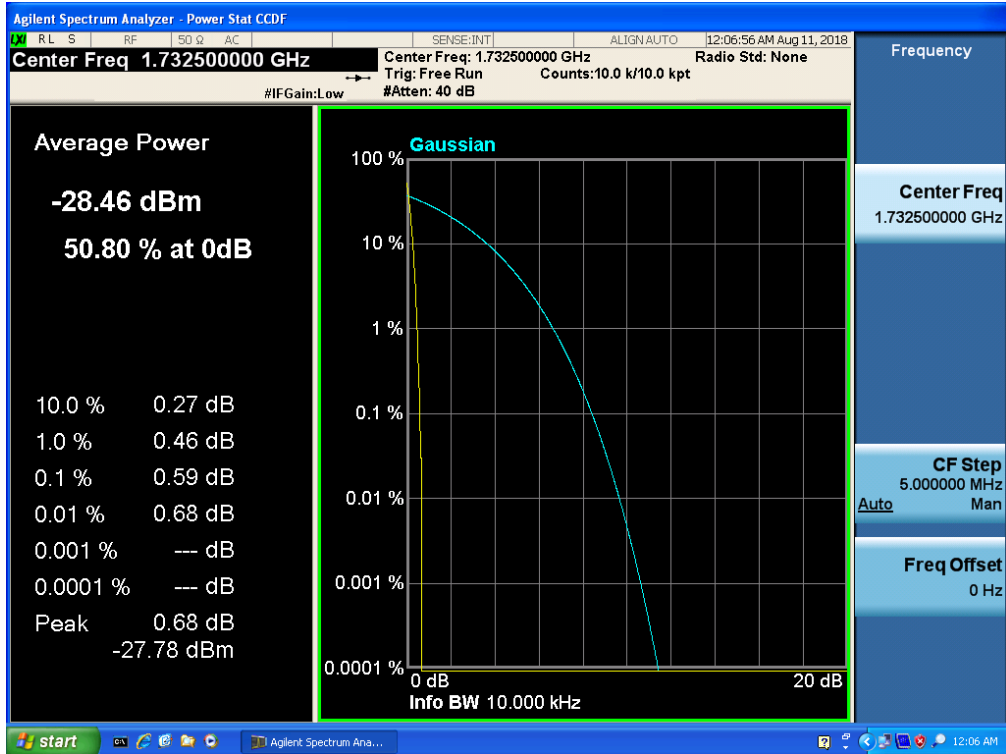

Band 4, UL Channel 20175, UL Frequency 1732.5, BW 15.0, NO. RB 1, RB POS. Low, QPSK

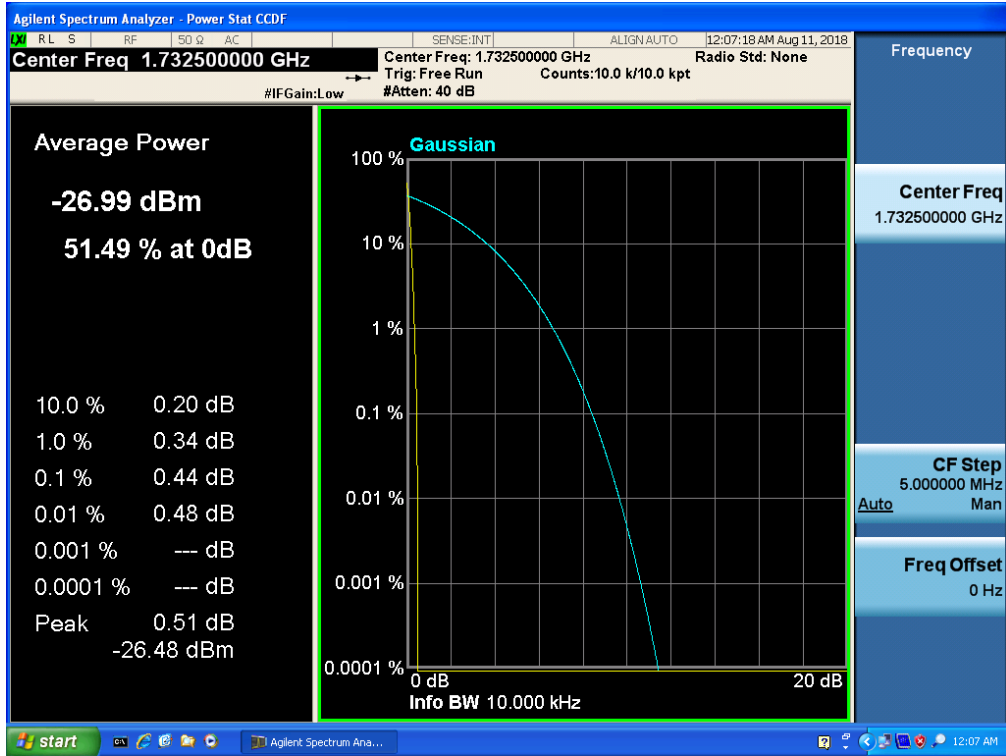

Band 4, UL Channel 20175, UL Frequency 1732.5, BW 15.0, NO. RB 1, RB POS. Low, 16-QAM

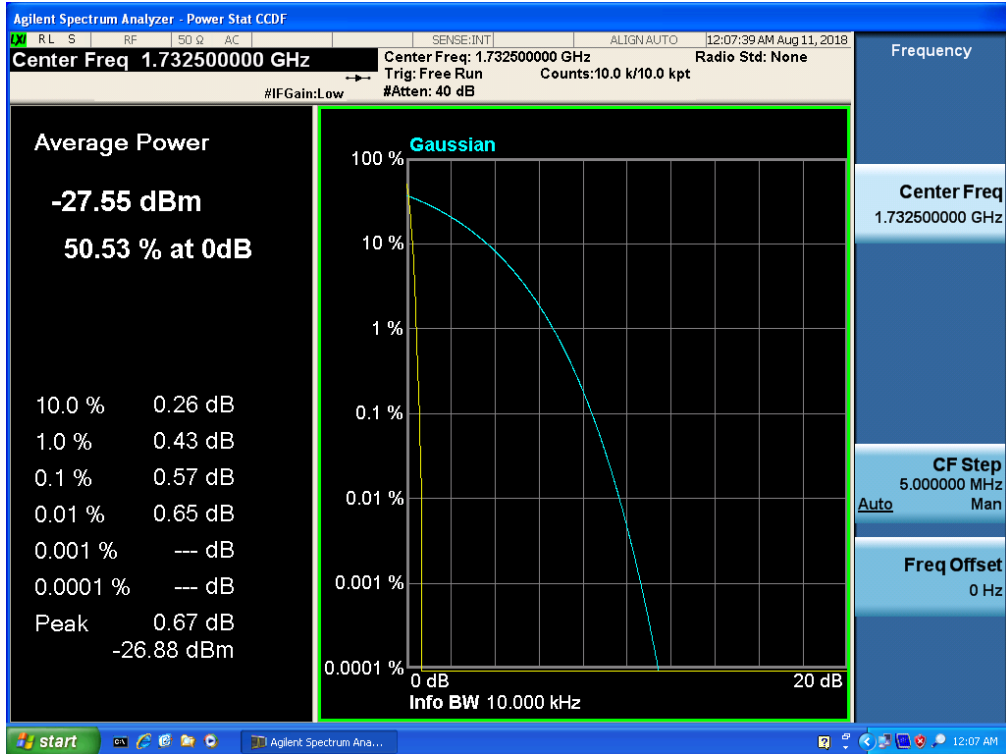



Band 4, UL Channel 20175, UL Frequency 1732.5, BW 20.0, NO. RB 1, RB POS. Low, QPSK

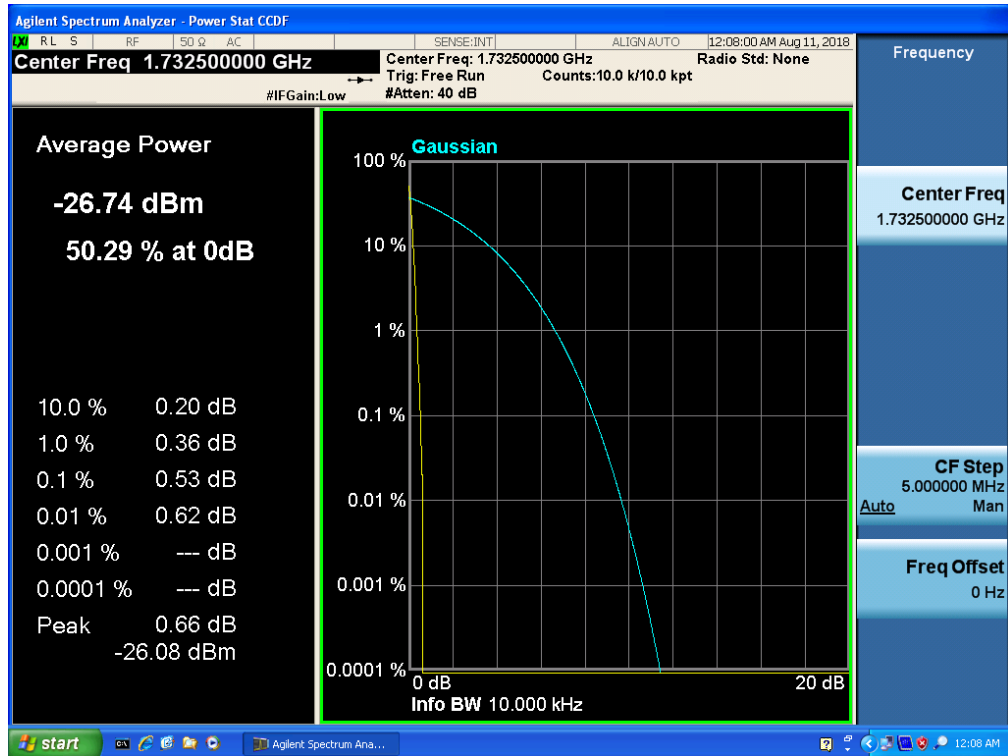

Band 4, UL Channel 20175, UL Frequency 1732.5, BW 20.0, NO. RB 1, RB POS. Low, 16-QAM

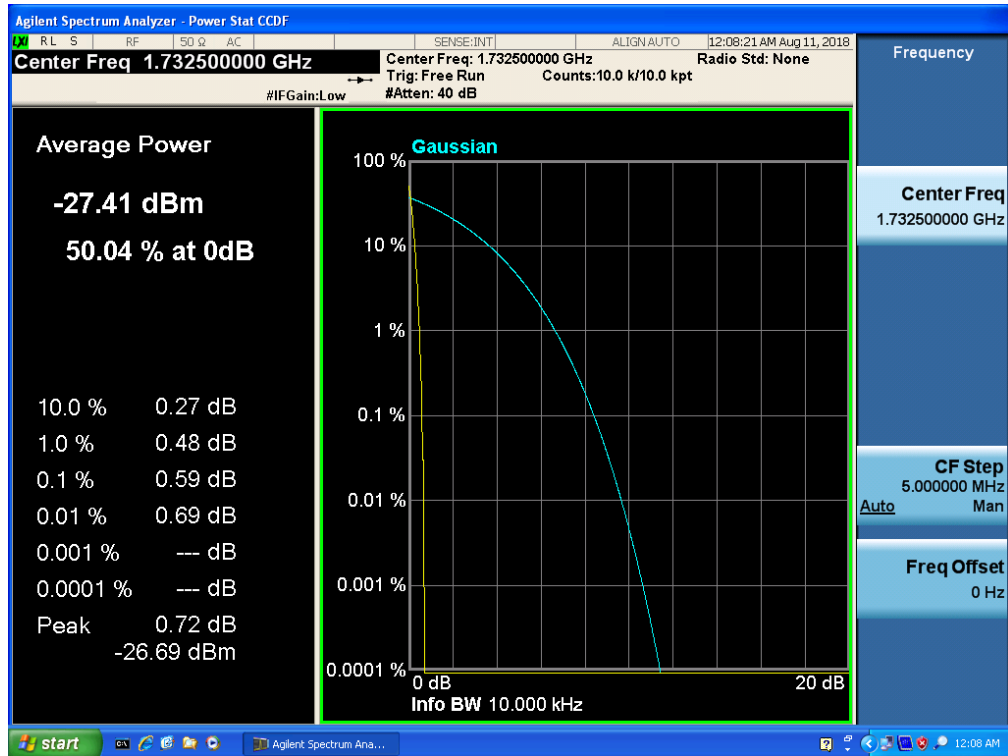



### 11.7 LTE BAND 13

*Band 13, UL Channel 23230, UL Frequency 782.0, BW 5.0, NO. RB 1, RB POS. Low, QPSK*

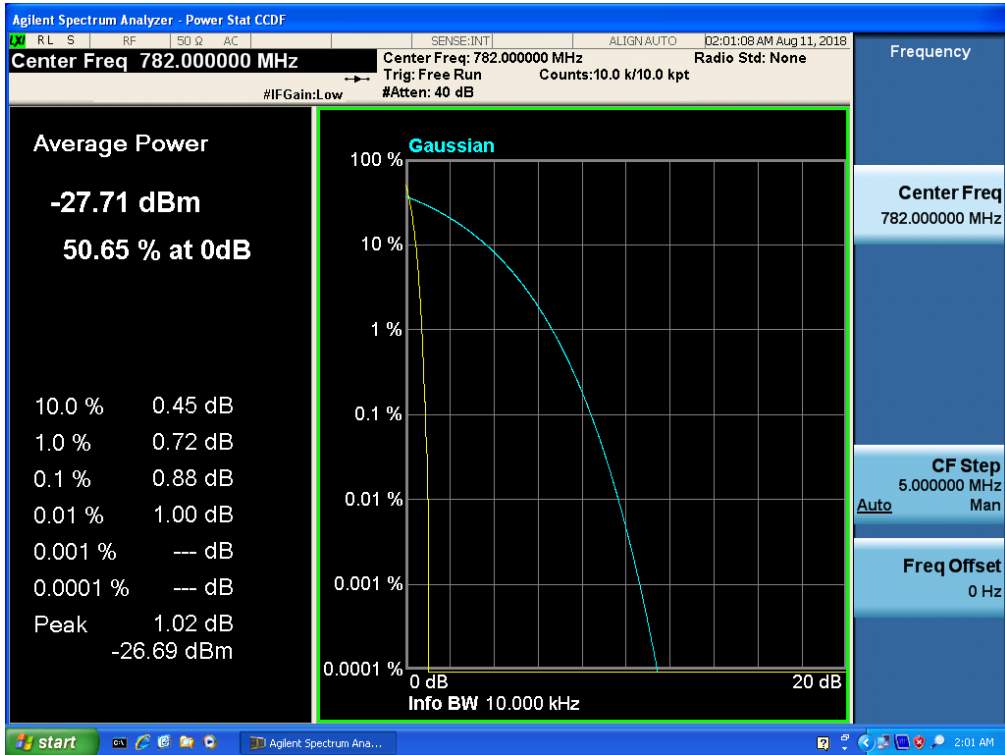

*Band 13, UL Channel 23230, UL Frequency 782.0, BW 5.0, NO. RB 1, RB POS. Low, 16-QAM*



Band 13, UL Channel 23230, UL Frequency 782.0, BW 10.0, NO. RB 1, RB POS. Low, QPSK

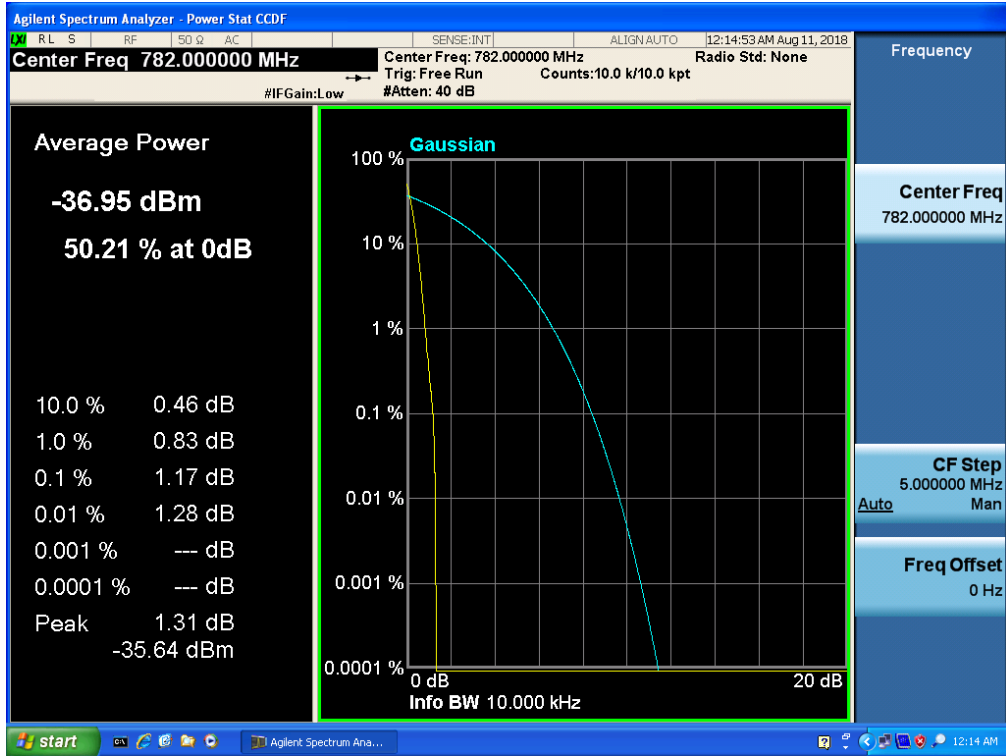

Band 13, UL Channel 23230, UL Frequency 782.0, BW 10.0, NO. RB 1, RB POS. Low, 16-QAM

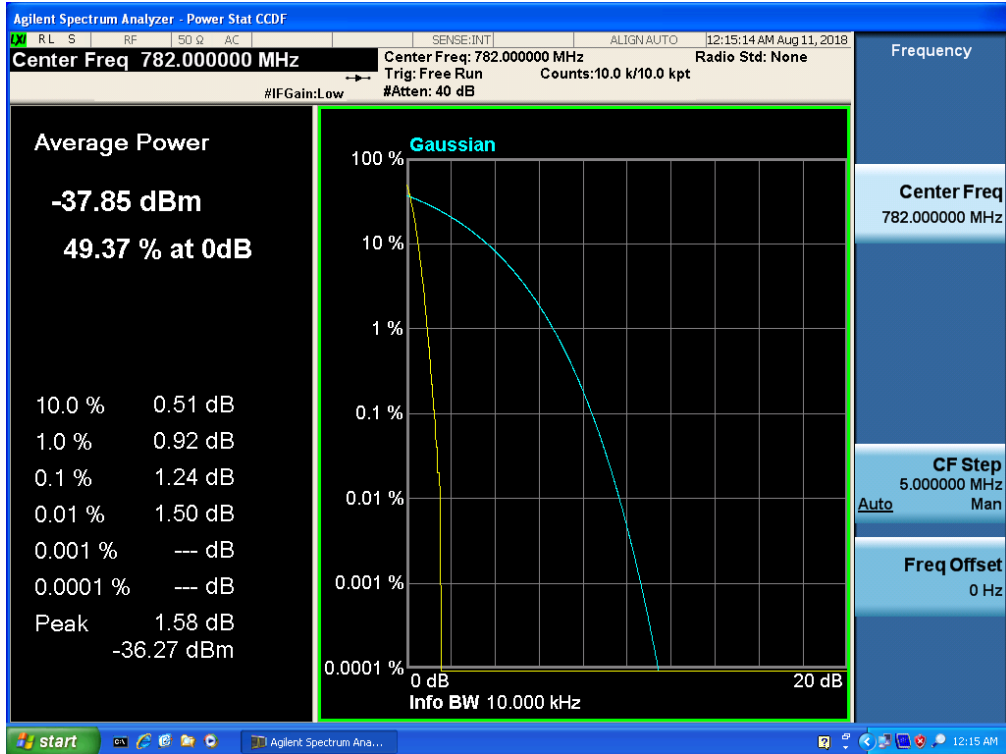

----END OF REPORT----