

HP-H020

INSTRUCTIONS

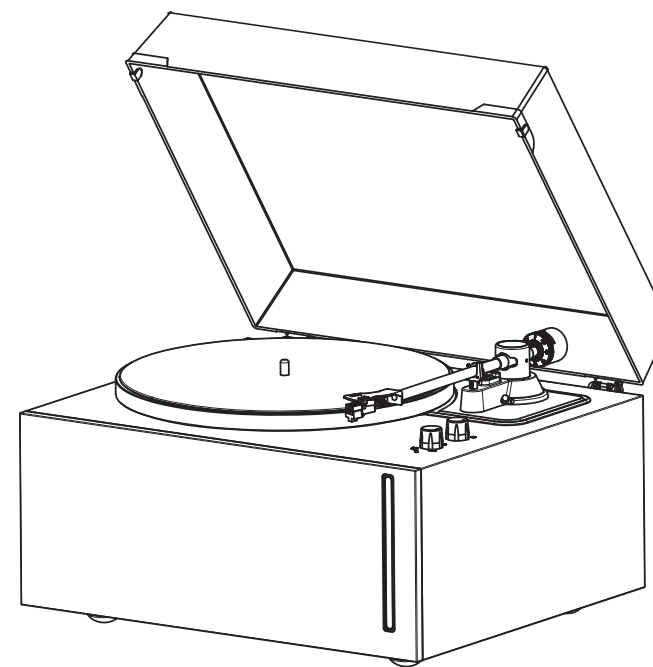

Introduction

Thank you for purchasing this High Fidelity Belt Drive Turntable. This instruction manual contains important information about safety, usage and disposal. Use the product as described and keep this manual for future reference. If you sell this turntable or pass it on, also give this manual to the new owner.

Safety Instructions

Read and understand this entire manual before using this product. Keep these instructions for future reference.

1. Do not use the turntable near water.
2. Only connect the turntable to a power outlet type as indicated on the marking label or in the "Specifications" section of this instruction manual.
3. The turntable has a polarized plug (one pin is wider than the other). To reduce the risk of electric shock, this plug is intended to fit into a polarized outlet in only one orientation. If the plug does not fit fully into the outlet, reverse the plug. If it still does not fit, contact a qualified electrician. Do not attempt to modify the plug in any way.
4. Protect the power cord from being walked on or pinched, particularly at the power plug, at the point of connection between the plug and outlet and at the point of connection between the power cable and speaker.
5. Do not overload wall outlets or extension cords as this will be a fire hazard and may cause electric shock.
6. Never push objects of any kind into the turntable through openings as they may touch dangerous voltage points or short out parts that could result in a fire or electric shock. Never spill liquid of any kind on the product.
7. Do not attempt to service the turntable yourself as opening or removing body panels may expose you to dangerous voltage or other hazards. Refer all servicing to qualified service personnel.
8. Changes or modifications to the turntable not expressly approved by the party responsible for compliance could void the user's authority to operate the product.
9. Do not use attachments not recommended by the manufacturer as they may cause hazards.
10. Only place on a flat, sturdy table or use with the cart, stand, tripod or bracket as specified by the manufacturer or sold with the turntable. When a cart is used, use caution when moving the cart/turntable combination to avoid injury from tip-over.



11. Slots and openings in the cabinet are provided for ventilation and to ensure reliable operation of the product and to protect it from overheating. Do not block or cover these openings.

12. Unplug the product during lightning storms or when unused for long periods of time.

COMPLIANCE WITH FCC REGULATIONS

This device complies with Part 15 of FCC rules. Operation is subject to the following two conditions:

- (1) This device may not cause harmful interference, and
- (2) This device must accept any interference received, including interference that may cause undesired operation.

This equipment has been tested and found to comply with the limits for a Class B digital device, pursuant to Part 15 of the FCC rules. These limits are designed to provide reasonable protection against harmful interference in a residential installation.

This equipment generates, uses and can radiate radio frequency energy and, if not installed and used in accordance with the instructions, may cause harmful interference to radio communications. However, there is no guarantee that interference will not occur in a particular installation.

If this equipment does cause harmful interference to radio or television reception, which can be determined by turning the equipment off and on, the user is encouraged to try to correct the interference by one or more of the following measures:

- Reorient or relocate the receiving antenna.
- Increase the separation between the equipment and receiver.
- Connect the equipment into an outlet on a circuit different from that to which the receiver is connected.
- Consult the dealer or an experienced radio/TV technician for help.

WARNING: Changes or modifications to this unit not expressly approved by the party responsible for compliance could void the user's authority to operate the equipment.

This equipment complies with FCC radiation exposure limits set forth for uncontrolled environment. This equipment should be installed and operated with minimum distance 20cm between the radiator & your body.

Product Description

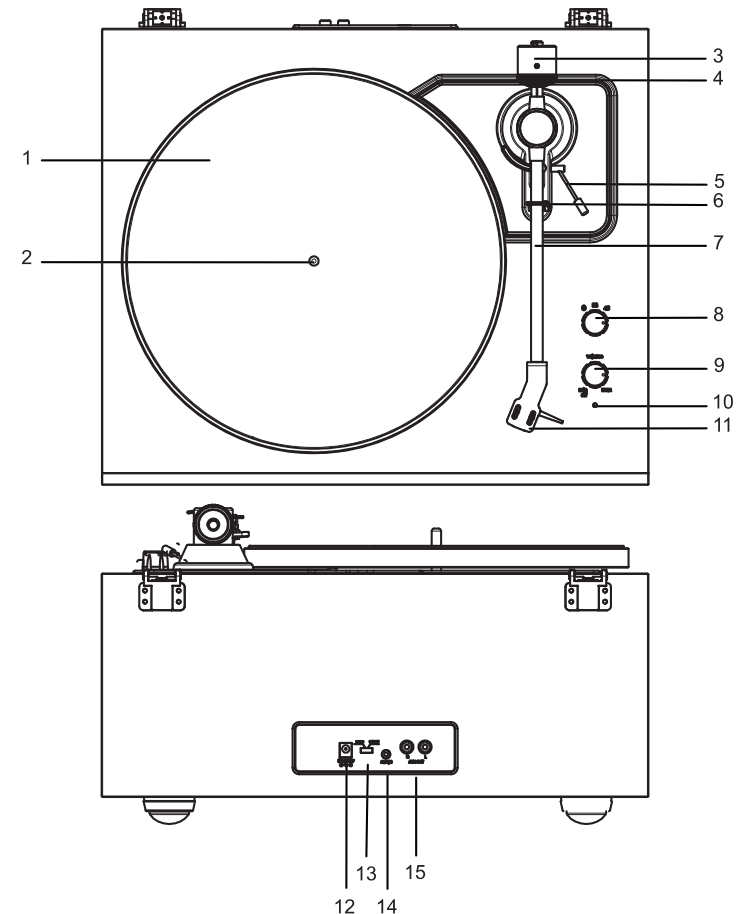

- | | |
|----------------------------------|----------------------------------|
| 1. Turntable Platter | 10. Indicator |
| 2. Turntable Spindle | 11. Cartridge |
| 3. Counterweight | 12. Power Jack |
| 4. Tracking Force Dial | 13. Phono & AUX OUT Switch |
| 5. Tonearm Lift Lever | 14. AUX IN Jack |
| 6. Tonearm Clip | 15. RCA Jacks of Phono & AUX OUT |
| 7. Tonearm | |
| 8. Function Knob | |
| 9. Power ON/ OFF and Volume Knob | |

Included Items

Before installing the turntable, check the package contents to ensure all parts below are included and free of visible damage. Please retain the original packaging materials for exchange or return purposes.

- 1) Turntable Unit
- 2) Power Adapter
- 3) Slip Mat
- 4) Platter with Belt
- 5) Counterweight
- 6) 45 RPM Adapter
- 7) Instruction Manual
- 8) Dust cover

Installing the turntable

- Mount the turntable on a level surface.
- To avoid the effects of vibrations and acoustic pressure, do not mount the turntable next to items such as speakers.
- The turntable may pick up radio static if placed next to a radio. Therefore, try to keep the turntable away from radios.
- If the turntable is near equipment (cell phone, etc.) that emits strong radio waves, noise may occur.

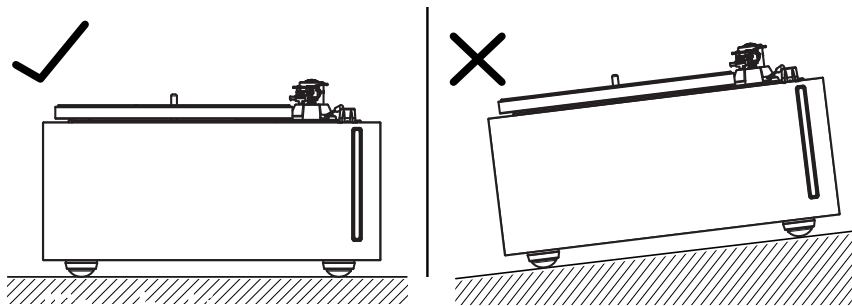

Turntable Platter and Belt Setup

1. Turn the platter over and check the belt position.

Make sure that the drive belt is looped in the middle of the circle. The drive belt located too high or too low in this circle may cause the drive belt to fall off or speed to be unstable.

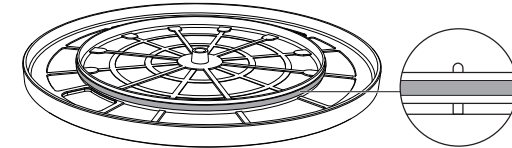

2. Set the platter on the spindle.

Make sure the platter is fully seated on the spindle.

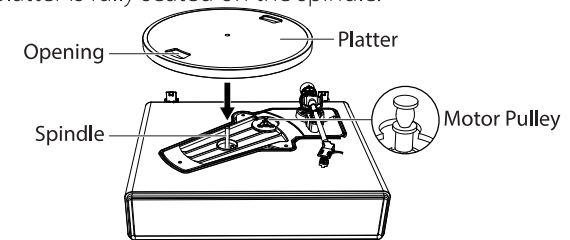

3. Place the belt on the motor pulley.

Align one of the platter openings with the motor pulley, and while pulling both ends of the red ribbon that comes attached to the belt, place the belt on the motor pulley, as per the diagram. When doing this, be careful not to twist the belt.

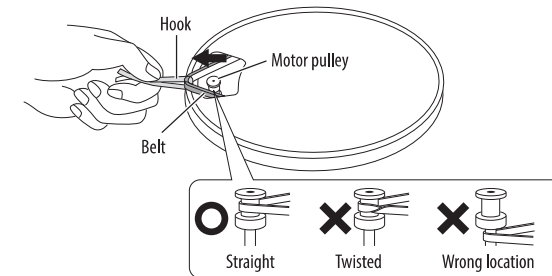

4. Remove the red ribbon from the belt.

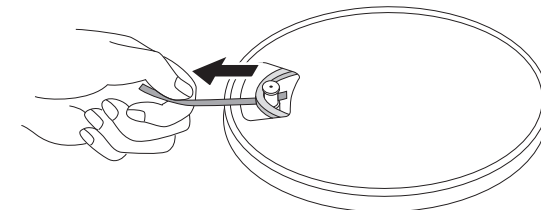

Rotating the Platter

1. Using your hands, slowly rotate the platter ten times in a clockwise direction (Figure 1).
2. This step is for resetting the auto mechanism, getting rid of any twists in the belt and making sure the belt rides smoothly along the drive rim on the underside of the platter.
3. Place the slip mat on top of the platter. Make sure the logo on the mat is facing up (Figure 2).

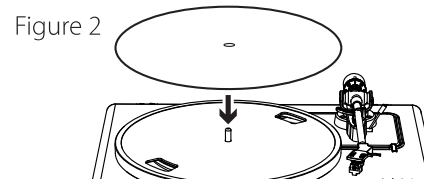
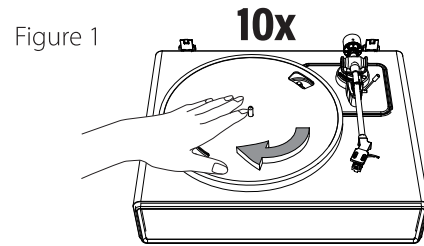

Cartridge Tracking Force Adjustment

The supplied Counterweight is suitable for cartridges weighing between 3.0-6.0g.

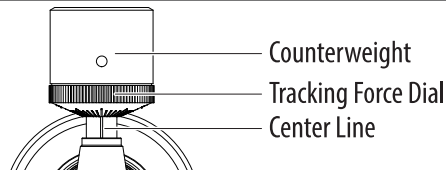

1. Gently push and turn the counterweight onto the rear of the tonearm (with the dial facing toward the front of the turntable).

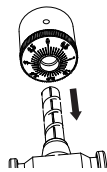

2. Pull the protector straight forward to remove it.

NOTE: Applying a downward force may cause the stylus to come off the body. Only low volume is output if the stylus has come off, or is about to come off, so refer to "Replacing the stylus" to reattach the stylus correctly.

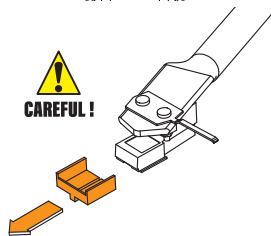

3. Remove the tie-wrap and unlock the tonearm.
4. Lower the tonearm lift lever and position the cartridge in the space between the tonearm rest and platter.

5. Carefully rotate the counterweight until the tonearm achieves a neutral balance. The tonearm should return to this balanced position if it is moved up or down. This adjustment must be done carefully.

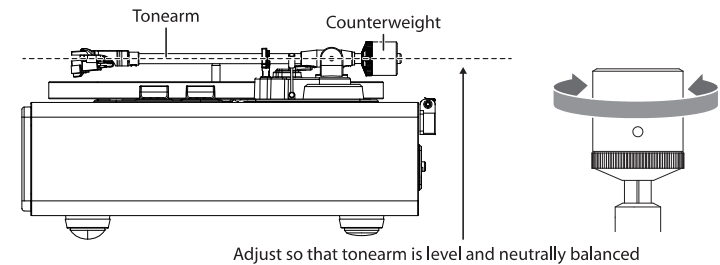

6. Once the tonearm is correctly balanced, return the tonearm to its rest. Without moving the position of the counterweight, gently rotate the tracking force dial until the zero is in line with black center line on the rear of the tonearm. Check to make sure the tonearm is still neutrally balanced.

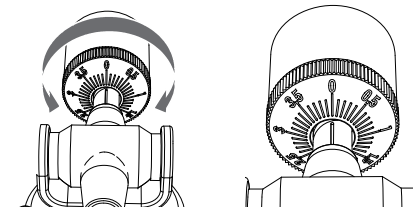

7. Finally, rotate the counterweight and tracking force dial together counterclockwise (as seen from the front) to adjust the tracking force according to the cartridge manufacturer's recommendations.

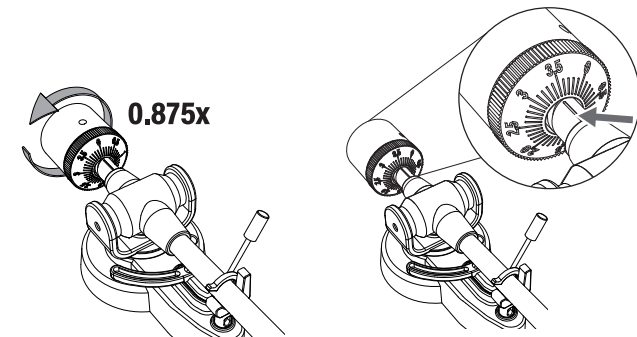

Note: Each mark on the scale represents 0.1g. The recommended tracking force for the factory-installed cartridge is $3.5g \pm 0.5g$. Carefully rotate the tracking force dial. When "3.5" is centered over the black line on the top of the tonearm please stop.

Connection to External Speaker with RCA Audio Cable

This turntable includes 4 built-in speakers and a built-in phono amplifier.

If you wish to use your own amplifier or speakers, please follow the instructions below:

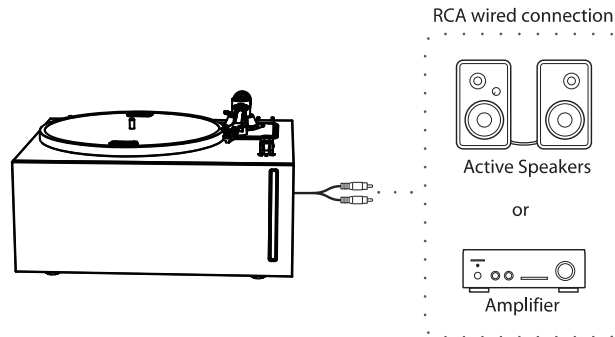

NOTE: In order to achieve the best sound, it is advised to set the turntable volume to a minimal level. Then the turntable's audio will be played back through your own amplifier, speakers, etc.

1. Setting pre-amplifier selector switch

This product has a built-in phono amplifier. You can use the product even if you do not have a phono amplifier or connectable equipment with a built-in phono amplifier.

Use the pre-amplifier selector switch to set the output, as shown below.

Connectable equipment being used	Position of pre-amplifier selector switch	Where to connect RCA audio cable
Device with phono input	PHONO	Phono input jack and ground (earth) terminal of connectable equipment
Device without phono input	LINE	AUX or line input jack of connectable equipment

NOTE: The RCA Jacks are not designed to be connected directly to the passive/unpowered speakers on LINE mode. If connected to the passive speakers, there will be no sound.

2. Connecting the device

Align the settings for the pre-amplifier selector switch and connect the RCA audio cable to an input jack that is compatible with the connectable equipment you are using (amplifier, active speakers, etc.).

- The RCA audio cable's red jack is for the right (R) channel, and the white jack is for the left (L) channel.

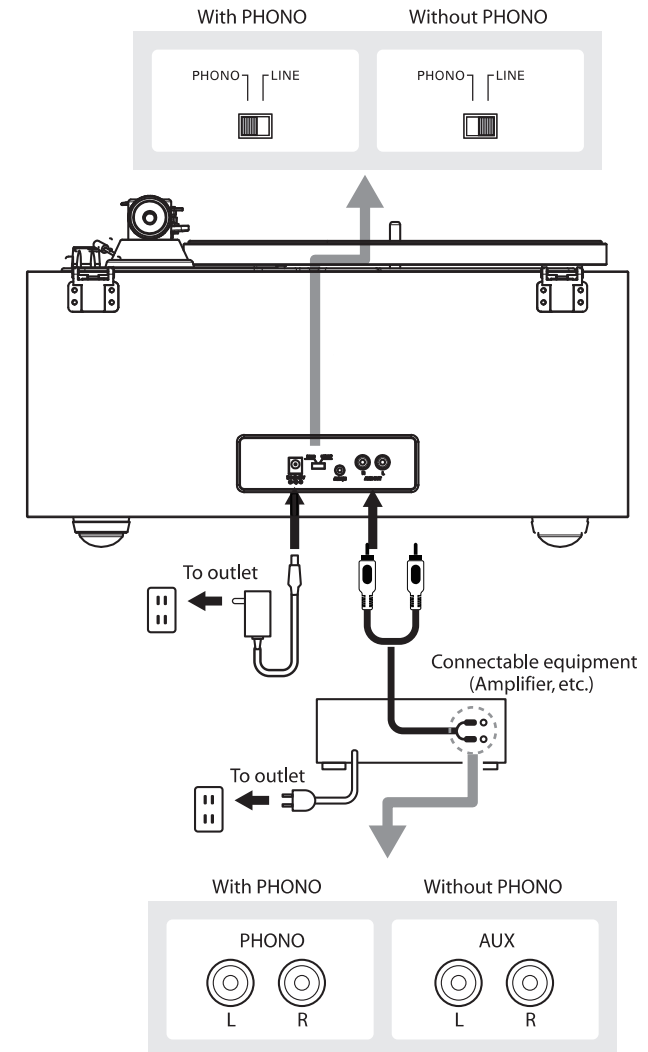

Main Power Connection

1. Insert the DC plug of the AC adapter cord into the DC INPUT Jack at the back of the turntable.
2. Plug the AC adapter into a normal power outlet.

NOTE: Do not plug the AC power adapter into a power outlet before all turntable assembly is completed. Before turning on turntable power, recheck all connections to make sure they are correct and secure. Always turn off the turntable before connecting or disconnecting from power.

Power Management Function

The turntable will automatically go into standby mode after 20 minutes of inactivity. To resume operation, POWER OFF and ON again.

Playing a Record

1. Before playing a record

- 1.1 Pull the protector straight forward to remove it.

NOTE: Applying a downward force may cause the stylus to come off the body. Only low volume is output if the stylus has come off, or is about to come off, so refer to "Replacing the stylus" to reattach the stylus correctly.

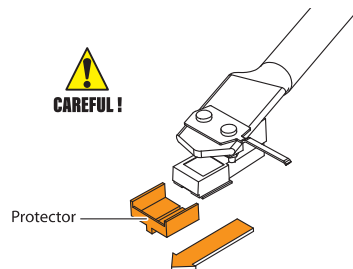

- 1.2 Place the record on the felt mat so that the center hole aligns with the spindle.

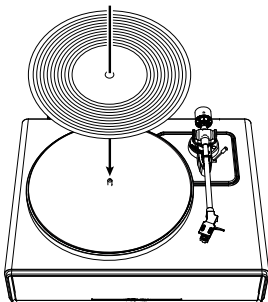

2. Turntable Operation

Sufficiently lower the volume of the amplifier and speakers first.

- 2.1 Connect the included power adapter to the turntable, power on this unit by the volume knob. The indicator will light in red.
- 2.2 Remove the stylus protector from the stylus.
- 2.3 Place the record on the slip mat.
- 2.4 Switch the function knob to choose the 33 and 45 RPM speeds according to the type of record.
- 2.5 Unlock the tonearm clip and set the tonearm lift lever to the up position.
- 2.6 Position the tonearm over the desired location (groove) on the record, the platter will start turning automatically.
- 2.7 Carefully lower the tonearm on the record.
- 2.8 Turn up the volume of the turntable as needed.
- 2.9 When you are finished playing the record, raise the tonearm, return it to rest on the arm clip and turn off the turntable.
- 2.10 The platter will stop turning if there is no sound output from the speakers in 3 minutes.

Bluetooth Operation

1. Connect the included power adapter to the turntable and **power on this unit by the volume knob**, the indicator light turns red.
2. **Switch the function knob to Bluetooth mode**. The indicator light turns blue and flash quickly. You will hear an activation sound from the turntable.
3. Turn on the Bluetooth feature of your media device and search for and select “HP-H020” to pair the media device and turntable.
4. Once your media device is successfully paired with the turntable, the turntable will play a short confirmation sound.
5. Play and stream music from your media device to the turntable. The indicator light will become solid.

Note: Bluetooth version: 5.0

AUX-IN Operation

This turntable includes an auxiliary audio signal input jack for connecting external audio devices like MP3 players, CD players, and older, non-dockable iPods so you can listen to your external source through the turntable's speakers.

1. Use an audio cable (not included) with one 3.5 mm stereo connection on each end of the cable.
2. Plug one end into the AUX-IN jack on the turntable and the other end to the Line Out jack of the audio device.
3. Power on the turntable and audio device. The indicator light of turntable is red.
4. The volume level can be controlled through the turntable. Operate all the functions on the auxiliary device as usual.
5. Please note that AUX-IN function is a first-priority function. Even if the indicator light for PHONO/BT is on, these functions won't work while the AUX-IN function is in use. Please unplug the AUX-IN cable before using the PHONO/BT functions.

NOTE:

1. Make sure the tone arm is securely locked to avoid any damage.
2. When you are done, don't forget to turn off the power on the turntable and your external device.

Care

Turntable Body

- When the turntable body is dirty or dusty, first disconnect the AC adapter and then wipe off the dirt and dust with a soft, dry cloth.
- Do not use benzenes, thinners, etc.
- When storing the product for a long time, disconnect the AC adapter from the outlet and wrap the product in plastic; do not allow it to become damp; the drive belt should be removed to prevent unequal stretching.

Stylus Tip

- If dirt and grime are stuck to the stylus tip, clean it with a commercially sold brush.
- We recommend using a stylus cleaner (not included) if the stylus tip is considerably dirty. Clean the stylus tip by moving the brush from the rear to the front of the stylus tip.

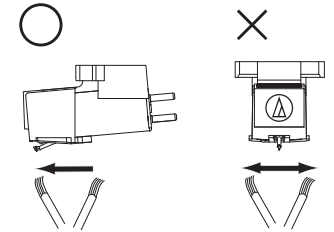

Replacing the Stylus

It's suggested to replace the stylus after 400 hours of use.

Removing the Stylus

- In addition to the deterioration of sound quality, records may also be damaged as the cartridge's stylus tip wears down.
- Be sure to disconnect the product's AC adapter from the outlet.
- When replacing the stylus, hold the headshell and the cartridge body tightly. Rotate the front of the stylus in a forward and down motion.

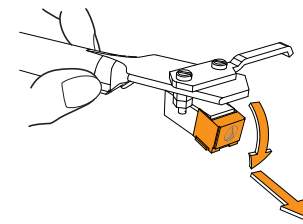

Installing a New Replacement Stylus

1. Mount the new replacement stylus to the cartridge.

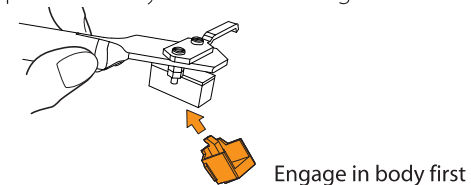

2. Lift the stylus up until you hear a click.

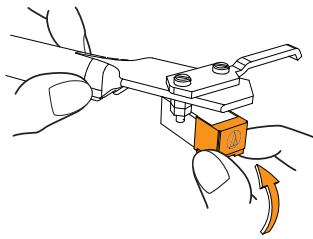

3. Make sure there is no gap between the headshell and the cartridge.

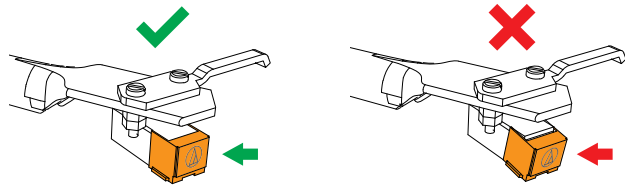

Replacing the Belt

- The belt is a consumable part. Replace the belt if the speed of playback slows down or irregular rotation occurs. As a rule of thumb, we suggest replacing the belt once a year.
- Before replacing the belt, be sure to disconnect the product's AC adapter from the outlet.

1. Remove the slip mat.

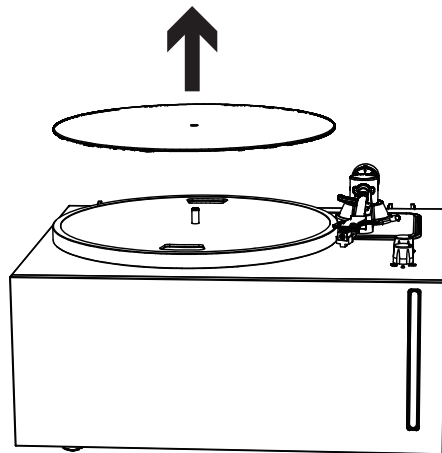

2. Remove the belt from the motor pulley.

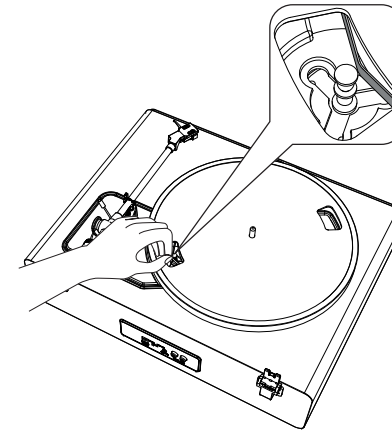

3. Remove the main platter and then remove the old belt.

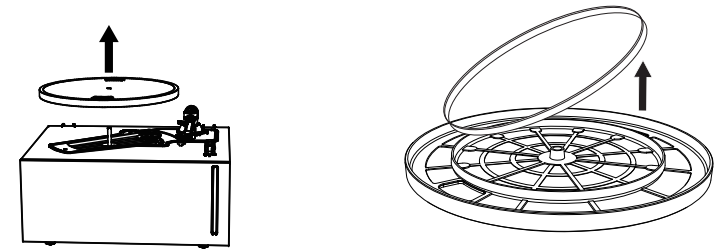

4. Turn the platter over and you will see a raised circle. Loop the new belt along the middle circle.

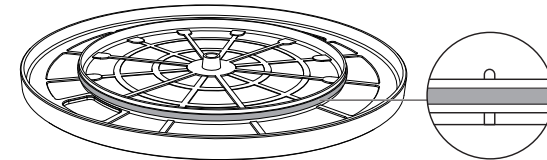

5. Attach the platter.

Align one of the openings with the position of the brass-colored motor pulley.

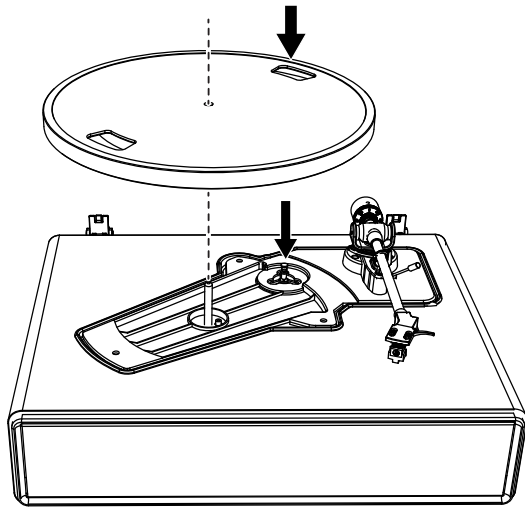

6. Place the belt on the brass-colored motor pulley

Grasp the belt that was attached in step 4 and, while pulling it, place it on the brass motor pulley.

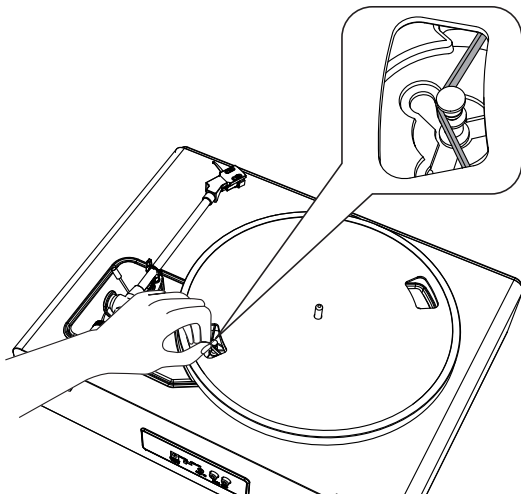

7. Using your hands, slowly rotate the platter ten times in a clockwise direction as shown by the arrow below.

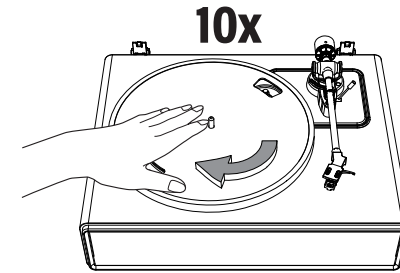

When the Turntable is Moved

Using the product's original packing materials, wrap the turntable in the reverse order from when you unwrapped it. If you do not have the packaging materials, take the following measures:

- After disconnecting the AC adapter from the outlet, remove the felt mat and platter, and then wrap them so that they do not get damaged.
- Attach the protector to the cartridge.
- Use a string or something similar to tie the tonearm to the rest so that it does not become dislodged.
- Wrap the turntable body with paper or a soft cloth so that it does not get damaged.

Troubleshooting

Problem	Solution
The platter does not spin.	<ul style="list-style-type: none"> • Is the AC adapter connected to the outlet? -Connect the AC adapter to the outlet. • What's the status of the indicator light? -The indicator light is blue. That means the turntable is in Bluetooth mode. Please switch the function knob to Turntable mode. -The red indicator light will indicate Turntable mode. • Has the belt slipped from the platter? -Correctly place the belt on the platter. • Is the belt placed on the motor pulley? -Check that the belt is placed on the motor pulley (brass-colored) correctly. • Has the belt been damaged? -Replace it with a new belt. • Is the AUX-IN cable plugged in? -AUX-IN function is a first-priority function. Please unplug the AUX-IN cable before using the PHONO/BT functions.
The platter spins, but there is no sound from the turntable?	<ul style="list-style-type: none"> • Is the stylus damaged? -Check the stylus and replace it, if necessary. It's suggested to replace the stylus after 400 hours of use. • Is the stylus placed correctly on the body of the cartridge? -Check the cartridge and adjust it, if necessary.
The stylus skips.	<ul style="list-style-type: none"> • Is the record warped? -Check the record. • Is the record scratched? -Check the record. • Is the stylus pressure correct? -Refer to "Cartridge Tracking Force Adjustment" to readjust the tracking force.

The turntable is making a strange 'howling' sound.	<ul style="list-style-type: none"> • Is the product picking up excessive vibrations from the floor, surfaces of the walls, or nearby speakers? -Decrease the vibrations or mount the product on a surface that is not subject to the effects of vibrations. • Is the product mounted on an unstable surface? -Check whether the surface on which the product is mounted is suitable.
There is noise when the record is playing.	<ul style="list-style-type: none"> • Is there dust on the cartridge's stylus tip? -If dust is stuck to the stylus tip, clean it with a commercially sold brush.
The sound when the record is playing is either too fast or too slow.	<ul style="list-style-type: none"> • Are the speed settings for this product correct? -Please select the correct speed for the type of record being played.
Playback speed slows down or there is irregular rotation.	<ul style="list-style-type: none"> • Is the belt stretched out? -Replace with a new belt. • Is the belt installed correct? -Refer to "Turntable Platter and Belt Setup" to setup the belt.

Specifications

Turntable

Power Supply	AC100-240V, DC output 15V 2400mA
Power Consumption	70W
Turntable Speed	33 1/3, 45 RPM
Output Power (RMS)	4Ω 25W X 2(BT) , 5W X 2(PH)
Dimensions (L x W x H)	420 x 353 x 263mm
Weight	7.72kg

Stylus

Model	Audio-Technica AT3600L
Frequency Response	20Hz - 20kHz
Channel Balance	<2.5dB
Channel Separation	>18dB
Output Voltage	2.5mV
Recommended Load Resistance	47kΩ
Amplifier Connection	MM (Moving Magnet) - input
Recommended Tracking Force	3.5±0.5g
Weight	0.18oz (5.1g)

Note: Design and specifications are subject to change without notice.

Disposal

Disposal of the Product



Under no circumstances should you dispose of this product in normal domestic waste.

This product is subject to the provisions of European Directive 2012/19/EU.

Dispose of this product via an approved disposal company or your municipal waste facility. Please observe currently applicable regulations.

Please contact your waste disposal center if you need any further information.



This product's packaging is made from environmentally friendly material and can be disposed of at your local recycling plant.