



FCC PART 15 SUBPART C TEST REPORT

FCC PART 15.407

Report Reference No......: **GTSR18080199-WLAN02**

FCC ID.....: **2AQ4K-L8**

Compiled by
 (position+printed name+signature)..: File administrators Jimmy Wang

Supervised by
 (position+printed name+signature)..: Test Engineer Aaron Tan

Approved by
 (position+printed name+signature)..: Manager Jason Hu

Date of issue.....: Sep.12, 2018

Representative Laboratory Name .: **Shenzhen Global Test Service Co.,Ltd.**
 Address.....: No.7-101 and 8A-104, Building 7 and 8, DCC Cultural and Creative Garden, No.98, Pingxin North Road, Shangmugu Community, Pinghu Street, Longgang District, Shenzhen, Guangdong, China

Applicant's name.....: **Shandong Praytech Optoelectronic Technology Co.,Ltd.**
 Address: F2,Blue Venture Valley,South of Keji Road,East of Longhai Road,Nanghai New District, Weihai City,Shandong Province, China

Test specification:
 Standard: **FCC Part 15.407**
 TRF Originator.....: Shenzhen Global Test Service Co.,Ltd.
 Master TRF.....: Dated 2014-12

Shenzhen Global Test Service Co.,Ltd. All rights reserved.
 This publication may be reproduced in whole or in part for non-commercial purposes as long as the Shenzhen Global Test Service Co.,Ltd. is acknowledged as copyright owner and source of the material. Shenzhen Global Test Service Co.,Ltd. takes no responsibility for and will not assume liability for damages resulting from the reader's interpretation of the reproduced material due to its placement and context.

Test item description: Smart Cube projector
 Trade Mark: /
 Manufacturer: Shandong Praytech Optoelectronic Technology Co.,Ltd.
 Model/Type reference.....: L8
 Listed Models: H5
 Difference: All the same except the model number
 Modulation Type: IEEE 802.11a /802.11ac/ 802.11n
 Operation Frequency.....: From 5745-5825 MHz
 Hardware Version: V4
 Software Version: V017
 Rating: DC 3.8V from Battery or DC 5V from adapter
 Result.....: **PASS**

TEST REPORT

Test Report No. :	GTSR18080199-WLAN02	Sep. 12, 2018
		Date of issue

Equipment under Test : **Smart Cube projector**

Model /Type : **L8**

Listed Models : **H5**

Applicant : **Shandong Praytech Optoelectronic Technology Co.,Ltd.**

Address : F2,Blue Venture Valley,South of Keji Road,East of Longhai Road,Nanghai New District, Weihai City,Shandong Province, China

Manufacturer : **Shandong Praytech Optoelectronic Technology Co.,Ltd.**

Address : F2,Blue Venture Valley,South of Keji Road,East of Longhai Road,Nanghai New District, Weihai City,Shandong Province, China

Test Result:	PASS
---------------------	-------------

The test report merely corresponds to the test sample.
 It is not permitted to copy extracts of these test result without the written permission of the test laboratory.

Contents

<u>1.</u>	<u>TEST STANDARDS</u>	<u>4</u>
<u>2.</u>	<u>SUMMARY</u>	<u>5</u>
2.1.	General Remarks	5
2.2.	Product Description	5
2.3.	Equipment Under Test	5
2.4.	Short description of the Equipment under Test (EUT)	5
2.5.	EUT operation mode	5
2.6.	Block Diagram of Test Setup	6
2.7.	Special Accessories	6
2.8.	Related Submittal(s) / Grant (s)	6
2.9.	Modifications	6
<u>3.</u>	<u>TEST ENVIRONMENT</u>	<u>7</u>
3.1.	Address of the test laboratory	7
3.2.	Test Facility	7
3.3.	Environmental conditions	7
3.4.	Test Description	8
3.5.	Statement of the measurement uncertainty	9
3.6.	Equipments Used during the Test	10
<u>4.</u>	<u>TEST CONDITIONS AND RESULTS.....</u>	<u>11</u>
4.1.	AC Power Conducted Emission	11
4.2.	Radiated Emission.....	16
4.3.	Duty Cycle	23
4.4.	Maximum Average Output Power	25
4.5.	Power Spectral Density	27
4.6.	6dB Bandwidth	35
4.7.	26dBc Bandwidth.....	43
4.8.	Band Edge Compliance	44
4.9.	Frequency Stability	54
4.10.	Antenna Requirement.....	56
<u>5.</u>	<u>TEST SETUP PHOTOS OF THE EUT</u>	<u>57</u>
<u>6.</u>	<u>EXTERNAL AND INTERNAL PHOTOS OF THE EUT</u>	<u>58</u>

1. TEST STANDARDS

The tests were performed according to following standards:

[FCC Rules Part 15.407](#): UNLICENSED NATIONAL INFORMATION INFRASTRUCTURE DEVICES.

[ANSI C63.10-2013](#): American National Standard for Testing Unlicensed Wireless Devices

[KDB 789033 D02](#): GUIDELINES FOR COMPLIANCE TESTING OF UNLICENSED NATIONAL INFORMATION INFRASTRUCTURE (U-NII) DEVICES PART 15, SUBPART E

[KDB 662911 D01 Multiple Transmitter Output v02r01](#): Emissions Testing of Transmitters with Multiple Outputs in the Same Band

2. SUMMARY

2.1. General Remarks

Date of receipt of test sample	:	Sep. 1, 2018
Testing commenced on	:	Sep. 1, 2018
Testing concluded on	:	Sep. 12, 2018

2.2. Product Description

Name of EUT	Smart Cube projector
Trade Mark:	/
Model Number	L8
Listed Models	H5
Power Supply	DC 3.8V from Battery or DC 5V from adapter
WLAN	Supported 802.11a/ 802.11ac/802.11n
Modulation Type	IEEE 802.11ac: OFDM(64QAM, 16QAM, QPSK, BPSK) IEEE 802.11a: OFDM(64QAM, 16QAM, QPSK, BPSK) IEEE 802.11n HT20: OFDM (64QAM, 16QAM, QPSK,BPSK) IEEE 802.11n HT40: OFDM (64QAM, 16QAM, QPSK,BPSK)
Operation frequency	IEEE 802.11a/ac VHT20/ n HT20: 5745MHz-5825MHz IEEE 802.11n HT40 /ac CHT 40:2422-2452MHz/5755-5795 MHz
Directional gain	@2.4G GANT $+10\log(N)\text{dbi} = 0.96+10\log 2 = 3.97\text{dbi} < 6\text{dbi}$ @5G GANT $+10\log(N)\text{dbi} = 2.23+10\log 2 = 5.24\text{dbi} < 6\text{dbi}$
Antenna Type	internal antenna
Antenna gain	0.96 dBi@2.4G , 2.23 dBi@5G

2.3. Equipment Under Test

Power supply system utilised

Power supply voltage	:	<input type="radio"/> 230V / 50 Hz	<input type="radio"/> 120V / 60Hz
		<input type="radio"/> 12 V DC	<input type="radio"/> 24 V DC
		<input checked="" type="radio"/> Other (specified in blank below)	

DC 3.8V

2.4. Short description of the Equipment under Test (EUT)

This is a Smart Cube projector.

For more details, refer to the user's manual of the EUT.

2.5. EUT operation mode

The application provider specific test software(Realtek MPtool) to control sample in continuous TX and RX.

IEEE 802.11a/IEEE 802.11ac(20MHz)/IEEE 802.11n(20MHz):

UNII-3	
Channel	Frequency (MHz)
149	5745

153	5765
157	5785
161	5805
165	5825

IEEE 802.11ac(40MHz)/IEEE 802.11n(40MHz):

UNII-3	
Channel	Frequency (MHz)
151	5755
159	5795

2.6. Block Diagram of Test Setup

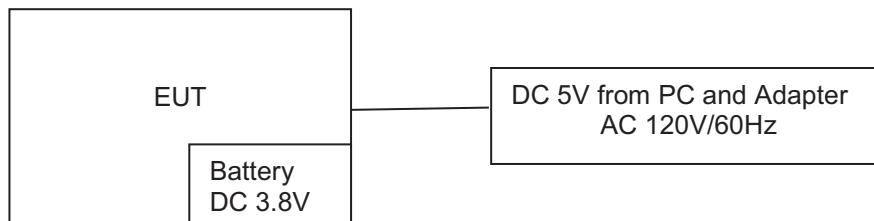

2.7. Special Accessories

Manufacturer	Description	Model	Serial Number	Certificate
TOSHIBA	Tablet PC	Satellite S40Dt-A	D26T	DOC

2.8. Related Submittal(s) / Grant (s)

This submittal(s) (test report) is intended for **FCC ID: 2AQ4K-L8** filing to comply with Section 15.407 of the FCC Part 15, Subpart E Rules.

2.9. Modifications

No modifications were implemented to meet testing criteria.

3. TEST ENVIRONMENT

3.1. Address of the test laboratory

Shenzhen Global Test Service Co.,Ltd.

1F, Building No. 13A, Zhonghaixin Science and Technology City, No.12,6 Road, Ganli Industrial Park, Buji Street, Longgang District, Shenzhen, Guangdong

3.2. Test Facility

The test facility is recognized, certified, or accredited by the following organizations:

FCC-Registration No.: 165725

Shenzhen Global Test Service Co.,Ltd EMC Laboratory has been registered and fully described in a report filed with the (FCC) Federal Communications Commission. The acceptance letter from the FCC is maintained in our files.

A2LA-Lab Cert. No.: 4758.01

Shenzhen Global Test Service Co.,Ltd. EMC Laboratory has been accredited by A2LA for technical competence in the field of electrical testing, and proved to be in compliance with ISO/IEC 17025: 2005 General Requirements for the Competence of Testing and Calibration Laboratories and any additional program requirements in the identified field of testing.

CNAS-Lab Code: L8169

Shenzhen Global Test Service Co.,Ltd. has been assessed and proved to be in compliance with CNAS-CL01 Accreditation Criteria for Testing and Calibration Laboratories (identical to ISO/IEC 17025: 2005 General Requirements) for the Competence of Testing and Calibration Laboratories. Date of Registration: Dec. 11, 2015. Valid time is until Dec. 10, 2018.

3.3. Environmental conditions

During the measurement the environmental conditions were within the listed ranges:

Temperature:	15-35 ° C
Humidity:	30-60 %
Atmospheric pressure:	950-1050mbar

3.4. Test Description

Test Specification clause	Test case	Test Mode	Test Channel	Recorded In Report		Pass	Fail	NA	NP	Remark
§15.203	Antenna gain	802.11ac	<input checked="" type="checkbox"/> Lowest <input checked="" type="checkbox"/> Middle <input checked="" type="checkbox"/> Highest	802.11a	<input checked="" type="checkbox"/> Lowest <input checked="" type="checkbox"/> Middle <input checked="" type="checkbox"/> Highest	<input checked="" type="checkbox"/>	<input type="checkbox"/>	<input type="checkbox"/>	<input type="checkbox"/>	complies
§15.407(a)	Power spectral density	802.11ac 802.11n HT20	<input checked="" type="checkbox"/> Lowest <input checked="" type="checkbox"/> Middle <input checked="" type="checkbox"/> Highest	802.11a 802.11ac 802.11n	<input checked="" type="checkbox"/> Lowest <input checked="" type="checkbox"/> Middle <input checked="" type="checkbox"/> Highest	<input checked="" type="checkbox"/>	<input type="checkbox"/>	<input type="checkbox"/>	<input type="checkbox"/>	complies
§15.407(a)	Spectrum bandwidth – 26 dB bandwidth	-/-	-/-	-/-	-/-	<input type="checkbox"/>	<input type="checkbox"/>	<input checked="" type="checkbox"/>	<input type="checkbox"/>	complies
§15.407(e)	Spectrum bandwidth – 6 dB bandwidth	802.11ac 802.11n HT20	<input checked="" type="checkbox"/> Lowest <input checked="" type="checkbox"/> Middle <input checked="" type="checkbox"/> Highest	802.11a 802.11ac 802.11n	<input checked="" type="checkbox"/> Lowest <input checked="" type="checkbox"/> Middle <input checked="" type="checkbox"/> Highest	<input checked="" type="checkbox"/> <input checked="" type="checkbox"/>	<input type="checkbox"/>	<input type="checkbox"/>	<input type="checkbox"/>	complies
§15.407(a)	Maximum output power	802.11ac 802.11n HT20	<input checked="" type="checkbox"/> Lowest <input checked="" type="checkbox"/> Middle <input checked="" type="checkbox"/> Highest	802.11a 802.11ac 802.11n	<input checked="" type="checkbox"/> Lowest <input checked="" type="checkbox"/> Middle <input checked="" type="checkbox"/> Highest	<input checked="" type="checkbox"/> <input checked="" type="checkbox"/> <input checked="" type="checkbox"/>	<input type="checkbox"/>	<input type="checkbox"/>	<input type="checkbox"/>	complies
§15.407(b)	Band edge compliance conducted	802.11ac 802.11n HT20	<input checked="" type="checkbox"/> Lowest <input checked="" type="checkbox"/> Highest	802.11a 802.11ac 802.11n	<input checked="" type="checkbox"/> Lowest <input checked="" type="checkbox"/> Highest	<input checked="" type="checkbox"/> <input checked="" type="checkbox"/>	<input type="checkbox"/>	<input type="checkbox"/>	<input type="checkbox"/>	complies
§15.407(b)	Band edge compliance radiated	802.11a 802.11ac 802.11n	<input checked="" type="checkbox"/> Lowest <input checked="" type="checkbox"/> Highest	802.11a	<input checked="" type="checkbox"/> Lowest <input checked="" type="checkbox"/> Highest	<input checked="" type="checkbox"/>	<input type="checkbox"/>	<input type="checkbox"/>	<input type="checkbox"/>	complies
§15.407(a)	TX spurious emissions conducted	-/-	-/-	-/-	-/-	<input type="checkbox"/>	<input type="checkbox"/>	<input checked="" type="checkbox"/>	<input type="checkbox"/>	complies
§15.407(a)	TX spurious emissions radiated	802.11a 802.11ac 802.11n	<input checked="" type="checkbox"/> Lowest <input checked="" type="checkbox"/> Middle <input checked="" type="checkbox"/> Highest	802.11a	<input checked="" type="checkbox"/> Lowest <input checked="" type="checkbox"/> Middle <input checked="" type="checkbox"/> Highest	<input checked="" type="checkbox"/>	<input type="checkbox"/>	<input type="checkbox"/>	<input type="checkbox"/>	complies
§15.407(g)	Frequency Stability	802.11a 802.11ac 802.11n	<input checked="" type="checkbox"/> Lowest <input checked="" type="checkbox"/> Highest	802.11a	<input checked="" type="checkbox"/> Lowest	<input checked="" type="checkbox"/>	<input type="checkbox"/>	<input type="checkbox"/>	<input type="checkbox"/>	complies
§15.109	RX spurious emissions radiated	-/-	-/-	-/-	-/-	<input type="checkbox"/>	<input type="checkbox"/>	<input checked="" type="checkbox"/>	<input type="checkbox"/>	complies
§15.209(a)	TX spurious Emissions radiated < 30 MHz	802.11a 802.11ac 802.11n	-/-	802.11a	-/-	<input checked="" type="checkbox"/>	<input type="checkbox"/>	<input type="checkbox"/>	<input type="checkbox"/>	complies
§15.107(a) §15.207	Conducted Emissions < 30 MHz	802.11a 802.11ac 802.11n	-/-	802.11a	-/-	<input checked="" type="checkbox"/>	<input type="checkbox"/>	<input type="checkbox"/>	<input type="checkbox"/>	complies

Remark:

1. The measurement uncertainty is not included in the test result.
2. NA = Not Applicable; NP = Not Performed

Preliminary tests were performed in different data rate to find the worst radiated emission. The data rate shown in the table below is the worst-case rate with respect to the specific test item. Investigation has been done on all the possible configurations for searching the worst cases. The following table is a list of the test modes shown in this test report.

Test Items	Mode	Data Rate
Maximum Peak Conducted Output Power	11ac/OFDM	6 Mbps
Power Spectral Density	11n/OFDM	6.5 Mbps
6dB Bandwidth		
26dB Bandwidth		
Spurious RF conducted emission		
Radiated Emission 9kHz~1GHz& Radiated Emission 1GHz~10 th Harmonic		
Band Edge	11ac/OFDM	6 Mbps
	11n/OFDM	6.5 Mbps

3.5. Statement of the measurement uncertainty

The data and results referenced in this document are true and accurate. The reader is cautioned that there may be errors within the calibration limits of the equipment and facilities. The measurement uncertainty was calculated for all measurements listed in this test report acc. to CISPR 16 - 4 „Specification for radio disturbance and immunity measuring apparatus and methods – Part 4: Uncertainty in EMC Measurements“ and is documented in the Shenzhen Global Test Service Co.,Ltd quality system acc. to DIN EN ISO/IEC 17025. Furthermore, component and process variability of devices similar to that tested may result in additional deviation. The manufacturer has the sole responsibility of continued compliance of the device.

Hereafter the best measurement capability for Shenzhen GTS laboratory is reported:

Test	Range	Measurement Uncertainty	Notes
Radiated Emission	30~1000MHz	4.10 dB	(1)
Radiated Emission	1~18GHz	4.32 dB	(1)
Radiated Emission	18-40GHz	5.54 dB	(1)
Conducted Disturbance	0.15~30MHz	3.12 dB	(1)

- (1) This uncertainty represents an expanded uncertainty expressed at approximately the 95% confidence level using a coverage factor of k=2.

3.6. Equipments Used during the Test

Test Equipment	Manufacturer	Model No.	Serial No.	Calibration Date	Calibration Due Date
LISN	R&S	ENV216	3560.6550.08	2017/09/20	2018/09/19
LISN	R&S	ESH2-Z5	893606/008	2017/09/20	2018/09/19
Bilog Antenna	Schwarzbeck	VULB9163	976	2016/09/20	2019/09/19
EMI Test Receiver	R&S	ESC17	101102	2017/09/20	2018/09/19
Spectrum Analyzer	Agilent	N9020A	MY48010425	2017/09/20	2018/09/19
Spectrum Analyzer	R&S	FSP40	100019	2018/06/05	2019/06/04
Controller	EM Electronics	Controller EM 1000	N/A	N/A	N/A
Horn Antenna	Schwarzbeck	BBHA 9120D	01622	2016/09/20	2019/09/19
Active Loop Antenna	SCHWARZBEC K	FMZB1519	1519-037	2016/09/20	2019/09/19
Broadband Horn Antenna	SCHWARZBEC K	BBHA 9170	971	2016/09/20	2019/09/19
Amplifier	Schwarzbeck	BBV 9743	#202	2017/09/20	2018/09/19
Amplifier	EMCI	EMC051845B	980355	2017/09/20	2018/09/19
Temperature/Humidity Meter	Gangxing	CTH-608	02	2017/09/20	2018/09/19
High-Pass Filter	K&L	9SH10-2700/X12750-O/O	KL142031	2017/09/20	2018/09/19
High-Pass Filter	K&L	41H10-1375/U12750-O/O	KL142032	2017/09/20	2018/09/19
RF Cable(below 1GHz)	HUBER+SUHNER	RG214	RE01	2017/09/20	2018/09/19
RF Cable(above 1GHz)	HUBER+SUHNER	RG214	RE02	2017/09/20	2018/09/19
Data acquisition card	Agilent	U2531A	TW53323507	2017/09/20	2018/09/19
Power Sensor	Agilent	U2021XA	MY5365004	2017/09/20	2018/09/19
EMI Test Software	R&S	ES-K1	V1.7.1	2017/09/20	2018/09/19
EMI Test Software	JS Tonscend	JS32-RE	2.0.1.5	2017/09/20	2018/09/19

Note: The Cal.Interval was one year.

4. TEST CONDITIONS AND RESULTS

4.1. AC Power Conducted Emission

TEST CONFIGURATION

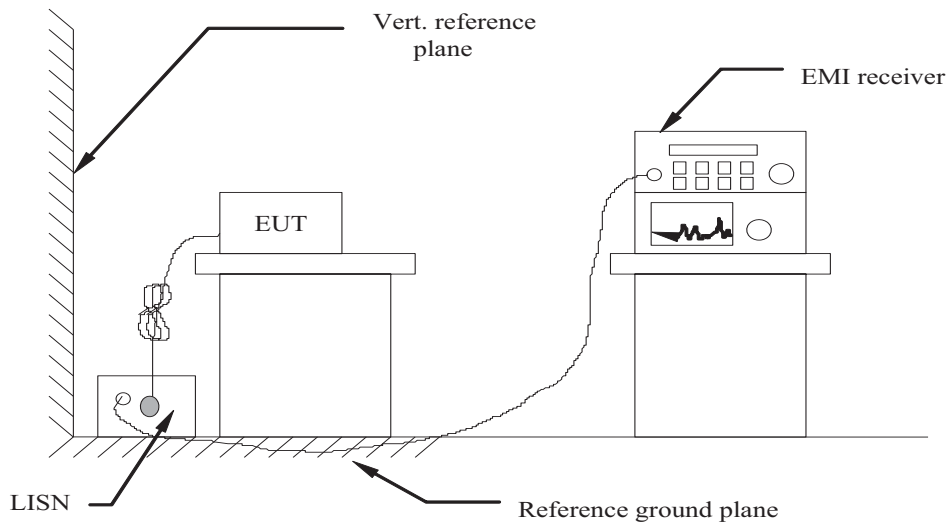

TEST PROCEDURE

- 1 The equipment was set up as per the test configuration to simulate typical actual usage per the user's manual. The EUT is a tabletop system, a wooden table with a height of 0.8 meters is used and is placed on the ground plane as per ANSI C63.10-2013.
- 2 Support equipment, if needed, was placed as per ANSI C63.10-2013
- 3 All I/O cables were positioned to simulate typical actual usage as per ANSI C63.10-2013
- 4 The EUT received DC 5V power from adapter, the adapter received AC120V/60Hz and AC 240V/60Hz power through a Line Impedance Stabilization Network (LISN) which supplied power source and was grounded to the ground plane.
- 5 All support equipments received AC power from a second LISN, if any.
- 6 The EUT test program was started. Emissions were measured on each current carrying line of the EUT using a spectrum Analyzer / Receiver connected to the LISN powering the EUT. The LISN has two monitoring points: Line 1 (Hot Side) and Line 2 (Neutral Side). Two scans were taken: one with Line 1 connected to Analyzer / Receiver and Line 2 connected to a 50 ohm load; the second scan had Line 1 connected to a 50 ohm load and Line 2 connected to the Analyzer / Receiver.
- 7 Analyzer / Receiver scanned from 150 KHz to 30MHz for emissions in each of the test modes.
- 8 During the above scans, the emissions were maximized by cable manipulation.

AC Power Conducted Emission Limit

For intentional device, according to § 15.207(a) AC Power Conducted Emission Limits is as following :

Frequency range (MHz)	Limit (dBuV)	
	Quasi-peak	Average
0.15-0.5	66 to 56*	56 to 46*
0.5-5	56	46
5-30	60	50

* Decreases with the logarithm of the frequency.

TEST RESULTS

Remark: We measured Conducted Emission at 802.11a/802.11n/802.11ac mode in AC 120V/60Hz and AC 240V/50Hz, Pre-test AC conducted emission at power from AC mains mode and at charge from PC mode, recorded worst case..

Power supply:

AC 120V/60Hz(adapter)

Polarization

L

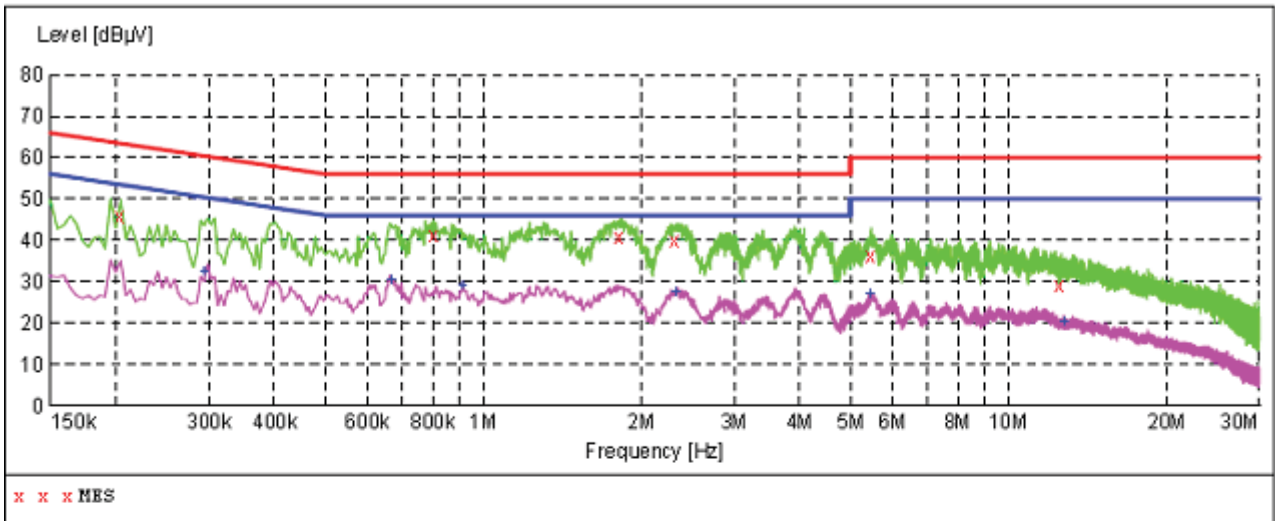

MEASUREMENT RESULT:

Frequency MHz	Level dBµV	Transd dB	Limit dBµV	Margin dB	Detector	Line	PE
0.204000	45.70	10.0	63	17.7	QP	L1	GND
0.802500	41.10	9.7	56	14.9	QP	L1	GND
1.810500	40.90	9.5	56	15.1	QP	L1	GND
2.319000	39.90	9.5	56	16.1	QP	L1	GND
5.469000	36.30	9.3	60	23.7	QP	L1	GND
12.565500	29.10	8.5	60	30.9	QP	L1	GND

MEASUREMENT RESULT:

Frequency MHz	Level dBµV	Transd dB	Limit dBµV	Margin dB	Detector	Line	PE
0.294000	32.40	9.9	50	18.0	AV	L1	GND
0.667500	30.40	9.7	46	15.6	AV	L1	GND
0.910500	29.10	9.6	46	16.9	AV	L1	GND
2.332500	27.60	9.5	46	18.4	AV	L1	GND
5.464500	26.90	9.3	50	23.1	AV	L1	GND
12.777000	20.10	8.5	50	29.9	AV	L1	GND

Power supply:

AC 120V/60Hz(adapter)

Polarization

N

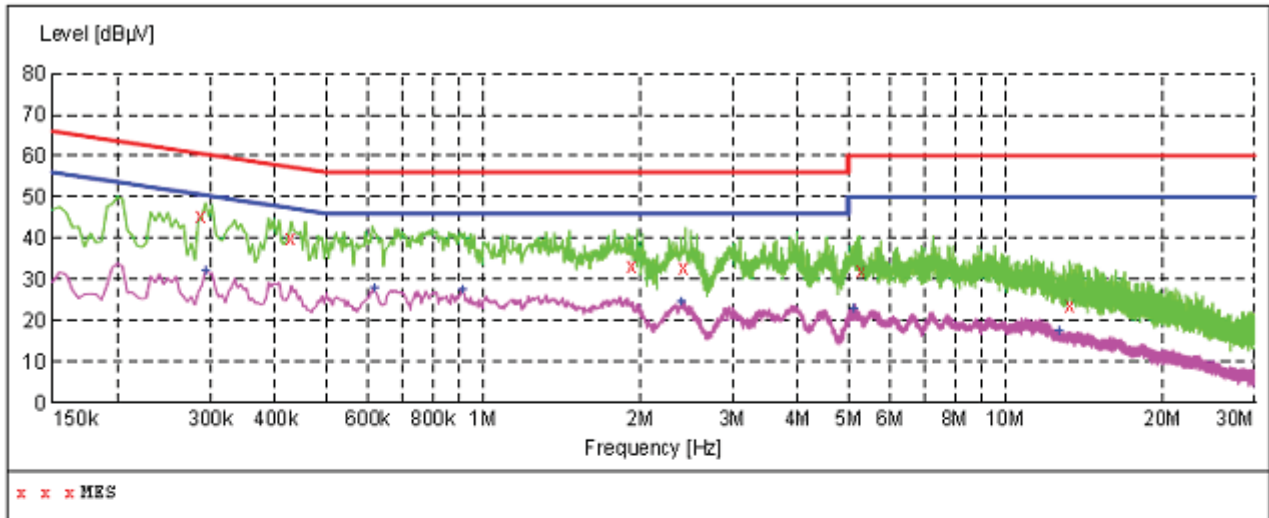

MEASUREMENT RESULT:

Frequency MHz	Level dBµV	Transd dB	Limit dBµV	Margin dB	Detector	Line	PE
0.289500	45.30	9.9	61	15.2	QP	N	GND
0.429000	40.10	9.8	57	17.2	QP	N	GND
1.932000	33.30	9.5	56	22.7	QP	N	GND
2.418000	33.00	9.5	56	23.0	QP	N	GND
5.293500	32.20	9.3	60	27.8	QP	N	GND
13.272000	23.60	8.4	60	36.4	QP	N	GND

MEASUREMENT RESULT:

Frequency MHz	Level dBµV	Transd dB	Limit dBµV	Margin dB	Detector	Line	PE
0.294000	32.10	9.9	50	18.3	AV	N	GND
0.618000	27.80	9.7	46	18.2	AV	N	GND
0.910500	27.60	9.6	46	18.4	AV	N	GND
2.395500	24.40	9.5	46	21.6	AV	N	GND
5.140500	22.80	9.3	50	27.2	AV	N	GND
12.642000	17.50	8.5	50	32.5	AV	N	GND

Power supply:

AC 240V/50Hz(adapter)

Polarization

L

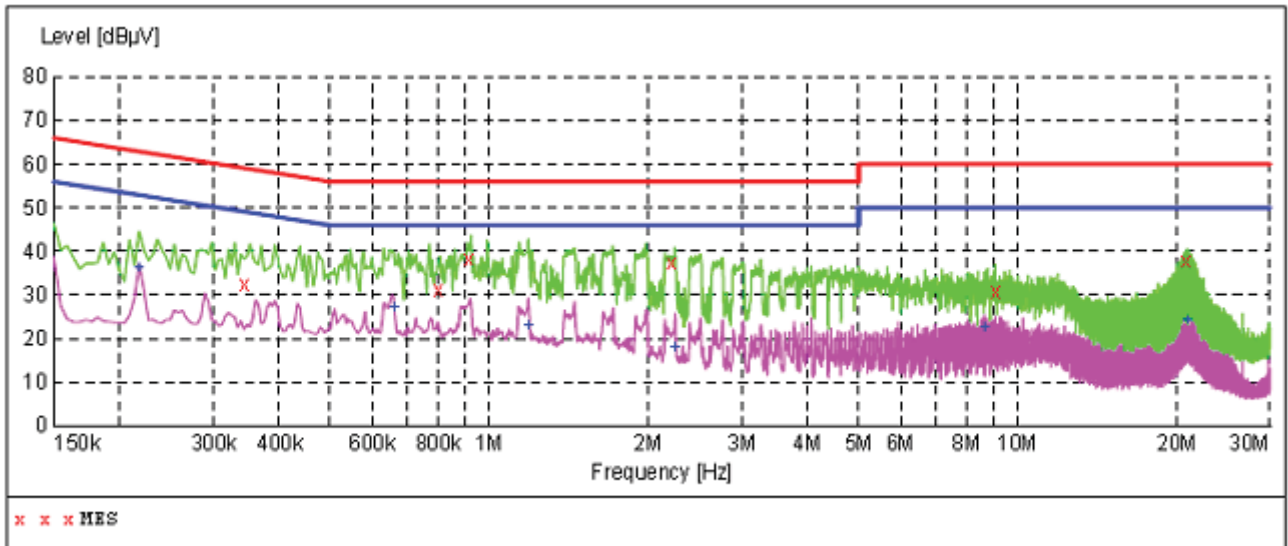

MEASUREMENT RESULT:

Frequency MHz	Level dBµV	Transd dB	Limit dBµV	Margin dB	Detector	Line	PE
0.343500	32.60	9.9	59	26.5	QP	L1	GND
0.802500	31.40	9.7	56	24.6	QP	L1	GND
0.919500	38.10	9.6	56	17.9	QP	L1	GND
2.224500	37.30	9.5	56	18.7	QP	L1	GND
9.073500	30.60	9.0	60	29.4	QP	L1	GND
20.899500	38.00	7.0	60	22.0	QP	L1	GND

MEASUREMENT RESULT:

Frequency MHz	Level dBµV	Transd dB	Limit dBµV	Margin dB	Detector	Line	PE
0.217500	36.00	10.0	53	16.9	AV	L1	GND
0.658500	26.90	9.7	46	19.1	AV	L1	GND
1.185000	23.00	9.6	46	23.0	AV	L1	GND
2.238000	18.00	9.5	46	28.0	AV	L1	GND
8.637000	22.50	9.0	50	27.5	AV	L1	GND
20.904000	24.10	7.0	50	25.9	AV	L1	GND

Power supply:

AC 240V/50Hz(adapter)

Polarization

N

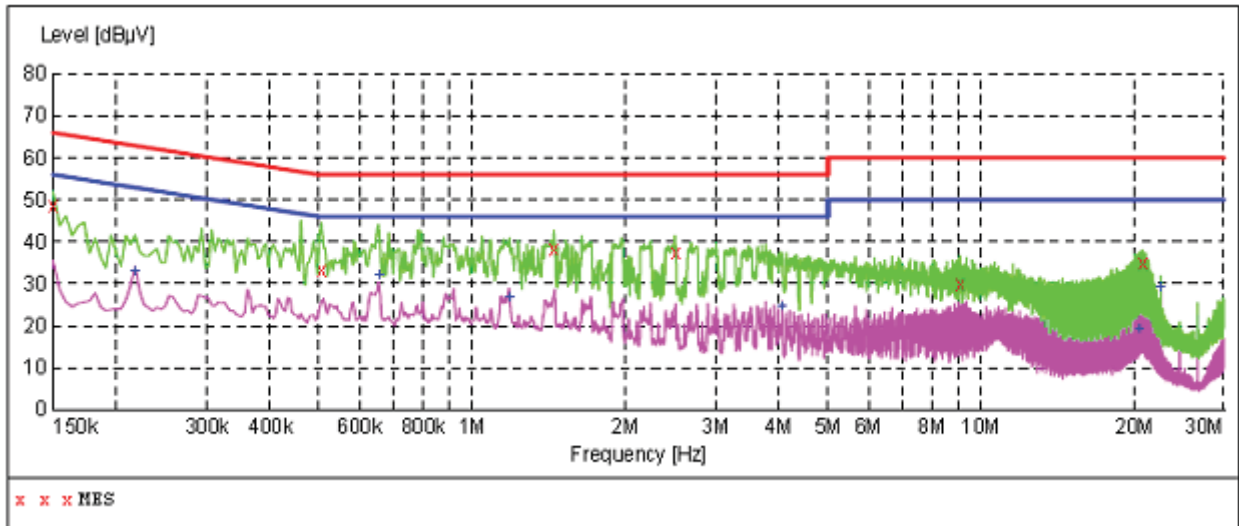

MEASUREMENT RESULT:

Frequency MHz	Level dBµV	Transd dB	Limit dBµV	Margin dB	Detector	Line	PE
0.150000	48.70	10.1	66	17.3	QP	N	GND
0.505500	33.20	9.8	56	22.8	QP	N	GND
1.450500	38.20	9.6	56	17.8	QP	N	GND
2.508000	37.30	9.5	56	18.7	QP	N	GND
9.078000	30.10	9.0	60	29.9	QP	N	GND
20.769000	35.00	7.0	60	25.0	QP	N	GND

MEASUREMENT RESULT:

Frequency MHz	Level dBµV	Transd dB	Limit dBµV	Margin dB	Detector	Line	PE
0.217500	32.90	10.0	53	20.0	AV	N	GND
0.654000	32.20	9.7	46	13.8	AV	N	GND
1.180500	26.80	9.6	46	19.2	AV	N	GND
4.065000	24.60	9.4	46	21.4	AV	N	GND
20.404500	19.40	7.0	50	30.6	AV	N	GND
22.528500	28.90	7.0	50	21.1	AV	N	GND

4.2. Radiated Emission

TEST CONFIGURATION

Frequency range 9 KHz – 30MHz

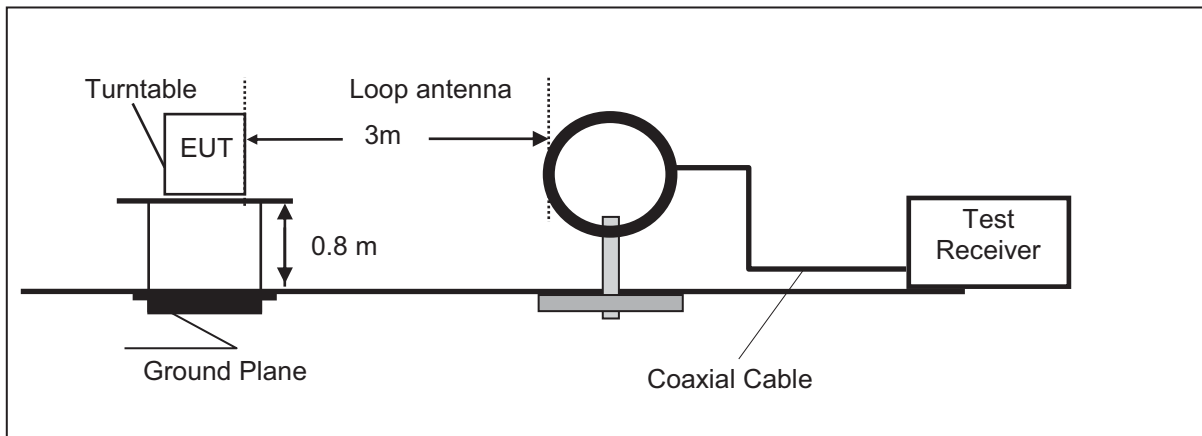

Frequency range 30MHz – 1000MHz

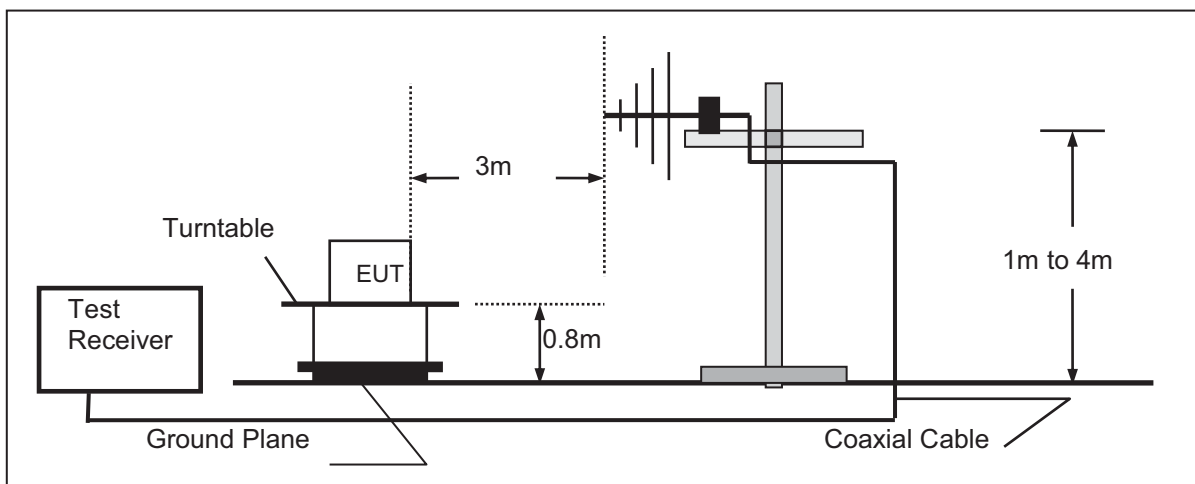

Frequency range above 1GHz

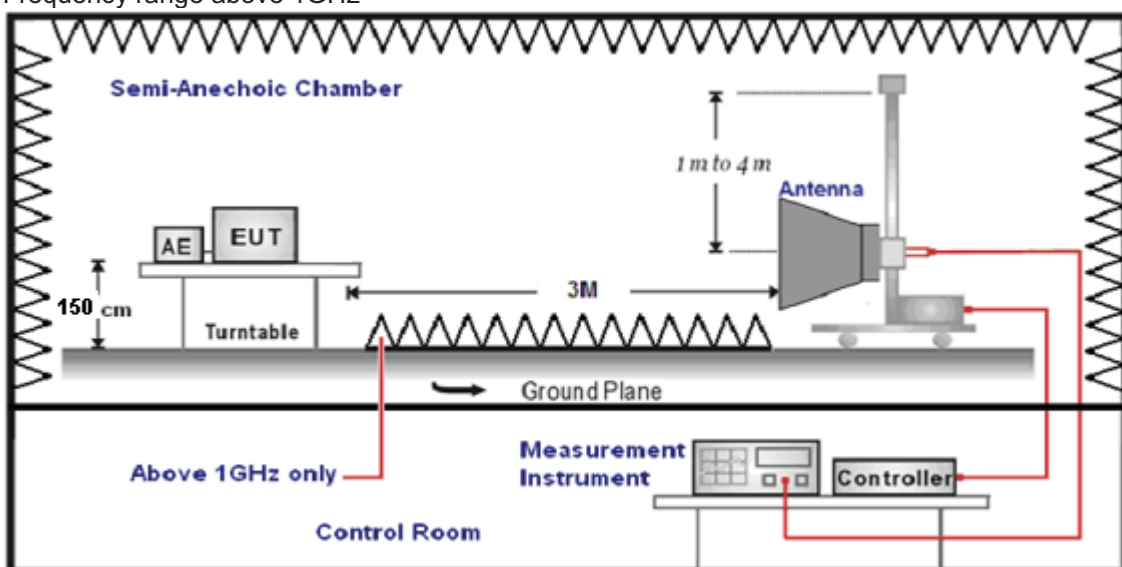

TEST PROCEDURE

1. The EUT was placed on a turn table which is 0.8m above ground plane when testing frequency range 9 KHz –1GHz;the EUT was placed on a turn table which is 1.5m above ground plane when testing above 1GHz.
2. Maximum procedure was performed by raising the receiving antenna from 1m to 4m and rotating the turn table from 0° to 360° to acquire the highest emissions from EUT.
3. And also, each emission was to be maximized by changing the polarization of receiving antenna both horizontal and vertical.
4. Repeat above procedures until all frequency measurements have been completed.
5. The EUT minimum operation frequency was 24MHz and maximum operation frequency was 5825MHz.so radiated emission test frequency band from 9KHz to 40GHz.
6. The distance between test antenna and EUT as following table states:

Test Frequency range	Test Antenna Type	Test Distance
9KHz-30MHz	Active Loop Antenna	3
30MHz-1GHz	Ultra-Broadband Antenna	3
1GHz-18GHz	Double Ridged Horn Antenna	3
18GHz-25GHz	Horn Antenna	1

7. Setting test receiver/spectrum as following table states:

Test Frequency range	Test Receiver/Spectrum Setting	Detector
9KHz-150KHz	RBW=200Hz/VBW=3KHz,Sweep time=Auto	QP
150KHz-30MHz	RBW=9KHz/VBW=100KHz,Sweep time=Auto	QP
30MHz-1GHz	RBW=120KHz/VBW=1000KHz,Sweep time=Auto	QP
1GHz-40GHz	Peak Value: RBW=1MHz/VBW=3MHz, Sweep time=Auto Average Value: RBW=1MHz/VBW=10Hz, Sweep time=Auto	Peak

Field Strength Calculation

The field strength is calculated by adding the Antenna Factor and Cable Factor and subtracting the Amplifier Gain and Duty Cycle Correction Factor(if any) from the measured reading. The basic equation with a sample calculation is as follows:

$$FS = RA + AF + CL - AG$$

Where FS = Field Strength	CL = Cable Attenuation Factor (Cable Loss)
RA = Reading Amplitude	AG = Amplifier Gain
AF = Antenna Factor	

$$Transd=AF +CL-AG$$

RADIATION LIMIT

According to §15.407 (b): Except as shown in paragraph (b)(7) of this section, the maximum emissions outside of the frequency bands of operation shall be attenuated in accordance with the following limits

Frequency (MHz)	EIRP Limit (dBm)	Equivalent Field Strength at 3m (dBµV/m)
5150-5250	-27	68.3
5250-5350	-27	68.3
5470-5725	-27	68.3
5725-5850	-27 (beyond 10MHz of the bandedge)	68.3
	-17 (within 10 MHz of band edge)	78.3

Frequency (MHz)	Distance (Meters)	Radiated (dBµV/m)	Radiated (µV/m)
0.009-0.49	3	20log(2400/F(KHz))+40log(300/3)	2400/F(KHz)
0.49-1.705	3	20log(24000/F(KHz))+ 40log(30/3)	24000/F(KHz)
1.705-30	3	20log(30)+ 40log(30/3)	30
30-88	3	40.0	100
88-216	3	43.5	150
216-960	3	46.0	200
Above 960	3	54.0	500

TEST RESULTS

Remark: We tested at 802.11ac/802.11ac/802.11n mode at the antenna single transmitting mode and the Mimo mode in AC 120V/60Hz, and recored the worst data at the Mimo mode of the 802.11a Mode.

For 9 KHz-30MHz

Freq.	Reading	Limit	Margin	State
(MHz)	(dBuV/m)	(dBuV/m)	(dB)	P/F
--	--	--	--	P
--	--	--	--	P

Note:

The amplitude of spurious emissions which are attenuated by more than 20dB below the permissible value has no need to be reported.

Distance extrapolation factor = $40 \log(\text{specific distance/test distance})$ (dB);

Limit line = specific limits(dBuv) + distance extrapolation factor.

For 30MHz-1GHz

Horizontal

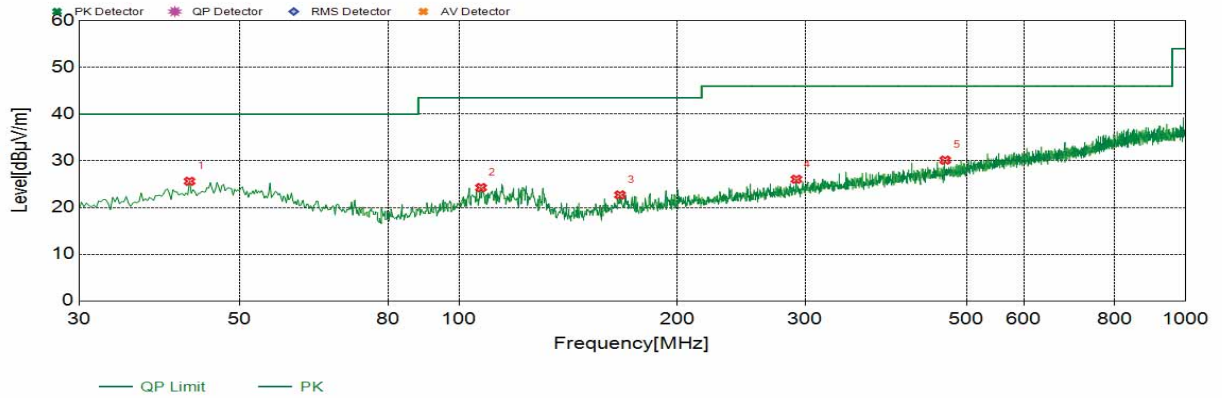

NO.	Freq. [MHz]	Result Level [dBµV/m]	Factor [dB]	Limit [dBµV]	Margin [dB]	Height [cm]	Angle[°]	Polarity
1	42.610	25.62	-14.38	40.00	14.38	100	136	Horizontal
2	107.358	24.27	-17.05	43.50	19.23	100	229	Horizontal
3	166.770	22.7	-19.10	43.50	20.80	100	176	Horizontal
4	291.658	26.05	-13.84	46.00	19.95	100	248	Horizontal
5	467.470	30.14	-10.17	46.00	15.86	100	288	Horizontal

Vertical

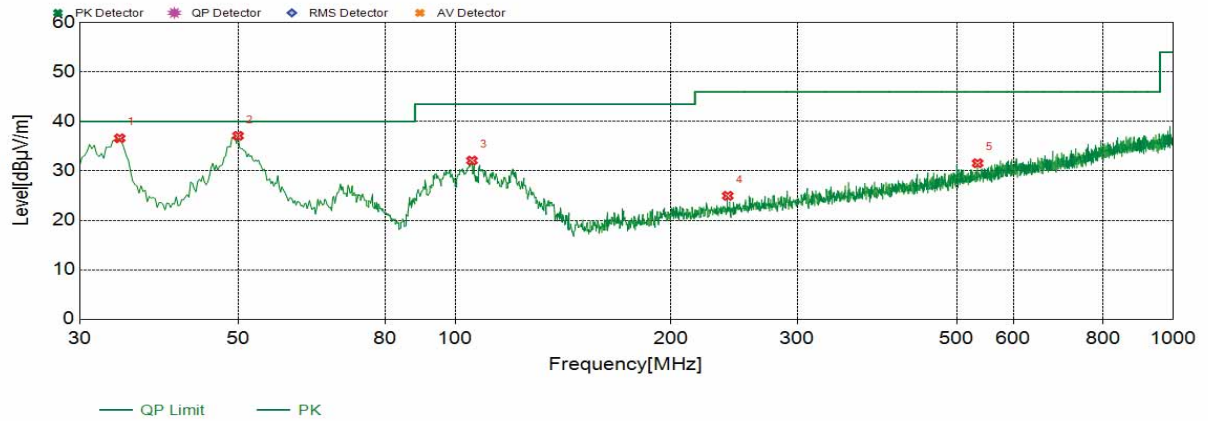

NO.	Freq. [MHz]	Result Level [dBµV/m]	Factor [dB]	Limit [dBµV]	Margin [dB]	Height [cm]	Angle[°]	Polarity
1	34.123	36.59	-16.36	40.00	3.41	100	187	Vertical
2	49.885	37.09	-14.06	40.00	3.11	100	202	Vertical
3	105.660	32.09	-17.04	43.50	11.41	100	255	Vertical
4	240.005	24.96	-15.20	46.00	21.04	100	11	Vertical
5	534.885	31.55	-8.78	46.00	14.45	100	356	Vertical

Note:

1. Pre-scan all modes and recorded the worst case results in this report (IEEE 802.11ac VHT20 mode (Middle Channel, Combined Antenna Chain1 and Antenna Chain2)).
2. Emission level (dBuV/m) = Meter Reading+ antenna Factor+ cable loss- preamp factor
3. Margin value = Emission level-Limits

For 1GHz to 40GHz

802.11a Mode Channel 149 5745 MHz

Item	Freq	Read Level	Antenna Factor	PRM	Cable Loss	Result Level	Limit Line	Margin	Detector	Polarization
(Mark)	(MHz)	(dB μ V)	(dB/m)	Factor	(dB)	(dB μ V/m)	(dB μ V/m)	(dB)		
1	11490	33.38	38.46	33.92	11.59	49.51	74	-24.49	Peak	Horizontal
2	11490	23.49	38.46	33.92	11.59	39.62	54	-14.38	AV	Horizontal
3	17235	29.86	43.11	37.11	13.94	49.8	74	-24.2	Peak	Horizontal
4	17235	19.64	43.11	37.11	13.94	39.58	54	-14.42	AV	Horizontal

Item	Freq	Read Level	Antenna Factor	PRM	Cable Loss	Result Level	Limit Line	Margin	Detector	Polarization
(Mark)	(MHz)	(dB μ V)	(dB/m)	Factor	(dB)	(dB μ V/m)	(dB μ V/m)	(dB)		
1	11490	33.85	38.46	33.92	11.59	49.98	74	-24.02	Peak	Vertical
2	11490	21.58	38.46	33.92	11.59	37.71	54	-16.29	AV	Vertical
3	17235	28.69	43.11	37.11	13.94	48.63	74	-25.37	Peak	Vertical
4	17235	19.61	43.11	37.11	13.94	39.55	54	-14.45	AV	Vertical

802.11a Mode Channel 157 5785 MHz

Item	Freq	Read Level	Antenna Factor	PRM	Cable Loss	Result Level	Limit Line	Margin	Detector	Polarization
(Mark)	(MHz)	(dB μ V)	(dB/m)	Factor	(dB)	(dB μ V/m)	(dB μ V/m)	(dB)		
1	11570	31.47	38.53	33.86	11.66	47.8	74	-26.2	Peak	Horizontal
2	11570	21.25	38.53	33.86	11.66	37.58	54	-16.42	AV	Horizontal
3	17355	26.59	43.2	37.15	14.02	46.66	74	-27.34	Peak	Horizontal
4	17355	19.97	43.2	37.15	14.02	40.04	54	-13.96	AV	Horizontal

Item	Freq	Read Level	Antenna Factor	PRM	Cable Loss	Result Level	Limit Line	Margin	Detector	Polarization
(Mark)	(MHz)	(dB μ V)	(dB/m)	Factor	(dB)	(dB μ V/m)	(dB μ V/m)	(dB)		
1	11570	32.09	38.53	33.86	11.66	48.42	74	-25.58	Peak	Vertical
2	11570	22.15	38.53	33.86	11.66	38.48	54	-15.52	AV	Vertical
3	17355	28.63	43.2	37.15	14.02	48.7	74	-25.3	Peak	Vertical
4	17355	19.48	43.2	37.15	14.02	39.55	54	-14.45	AV	Vertical

802.11a Mode Channel 165 5825 MHz

Item	Freq	Read Level	Antenna Factor	PRM	Cable Loss	Result Level	Limit Line	Margin	Detector	Polarization
(Mark)	(MHz)	(dB μ V)	(dB/m)	Factor	(dB)	(dB μ V/m)	(dB μ V/m)	(dB)		
1	11650	30.57	38.56	33.84	11.71	47	74	-27	Peak	Horizontal
2	11650	21.46	38.56	33.84	11.71	37.89	54	-16.11	AV	Horizontal
3	17475	29.53	43.23	37.17	14.18	49.77	74	-24.23	Peak	Horizontal
4	17475	20.49	43.23	37.17	14.18	40.73	54	-13.27	AV	Horizontal

Item	Freq	Read Level	Antenna Factor	PRM	Cable Loss	Result Level	Limit Line	Margin	Detector	Polarization
(Mark)	(MHz)	(dB μ V)	(dB/m)	Factor	(dB)	(dB μ V/m)	(dB μ V/m)	(dB)		
1	11650	33.14	38.56	33.84	11.71	49.57	74	-24.43	Peak	Vertical
2	11650	21.08	38.56	33.84	11.71	37.51	54	-16.49	AV	Vertical
3	17475	27.78	43.23	37.17	14.18	48.02	74	-25.98	Peak	Vertical
4	17475	18.65	43.23	37.17	14.18	38.89	54	-15.11	AV	Vertical

Note:

- 1). Measuring frequencies from 9 KHz ~ 40 GHz, No emission found between lowest internal used/generated frequency to 30MHz.
- 2). Radiated emissions measured in frequency range from 9 KHz ~ 40 GHz were made with an instrument using Peak detector mode.
- 3). 18~40GHz at least have 20dB margin. No recording in the test report.
- 4). Worst case data at 6Mbps at IEEE 802.11a; MCS0 at IEEE 802.11n HT20, IEEE 802.11n HT40, IEEE 802.11a VHT20 and IEEE 802.11ac VHT40;
- 5). Data of measurement within this frequency range shown "---" in the table above means the reading of emissions are attenuated more than 20dB below the permissible limits or the field strength is too small to be measured.
- 6). Pre-scan at Antenna1 and Antenna2 for IEEE 802.11a mode, pre-scan at Antenna1 and Antenna2 and Combined Antenna1 and Antenna2 for IEEE 802.11n and IEEE 802.11ac, recorded worst case.

4.3. Duty Cycle

TEST CONFIGURATION

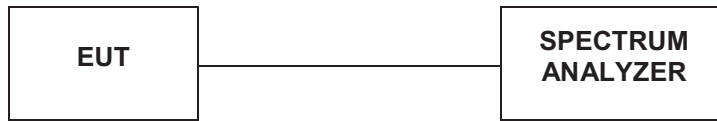

TEST PROCEDURE

According to KDB789033 D02 General UNII Test Procedures New Rules v01 B Duty Cycle (x), Transmission Duration (T):

- a. A diode detector and an oscilloscope that together have sufficiently short response time to permit accurate measurements of the on and off times of the transmitted signal
- b. The zero-span mode on a spectrum analyzer or EMI receiver, if the response time and spacing between bins on the sweep are sufficient to permit accurate measurements of the on and off times of the transmitted signal. Set the center frequency of the instrument to the center frequency of the transmission. Set $RBW \geq EBW$ if possible; otherwise, set RBW to the largest available value. Set $VBW \geq RBW$. Set detector = peak or average. The zerospan measurement method shall not be used unless both RBW and VBW are $> 50/T$, where T is defined in section II.B.1.a), and the number of sweep points across duration T exceeds 100. (For example, if VBW and/or RBW are limited to 3 MHz, then the zero-span method of measuring duty cycle shall not be used if $T \leq 16.7$ microseconds.)

The RF output of EUT was connected to the spectrum analyzer by RF cable and attenuator.

The path loss was compensated to the results for each measurement.

Set to the maximum power setting and enable the EUT transmit continuously.

The EUT was operating in controlled its channel.

Use the following spectrum analyzer settings:

Span = Zero Span

RBW = 1MHz

VBW = 1MHz

Number of points in Sweep > 100

Detector function = peak

Trace = Clear writeMeasure Ttotal and Ton

Calculate Duty Cycle = T_{on} / T_{total} and Duty Cycle Factor = $10 \cdot \log(1/Duty\ Cycle)$

TEST RESULTS

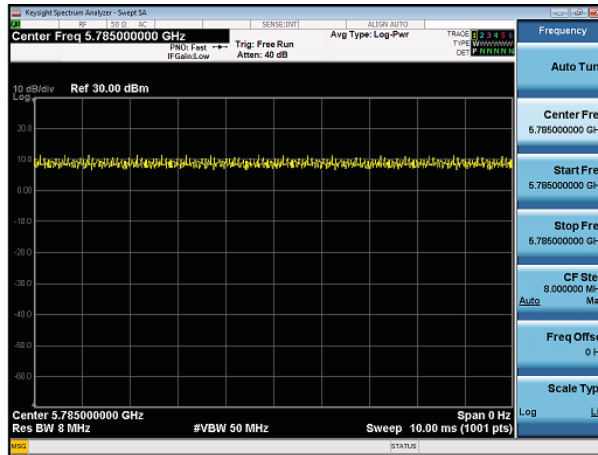

802.11a 5785MHz

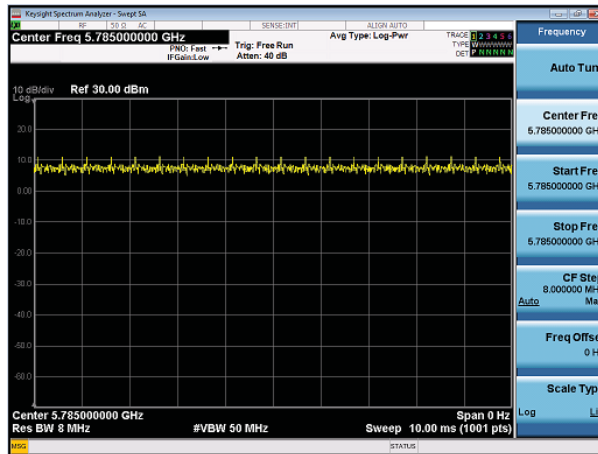

802.11n(HT20) 5785MHz

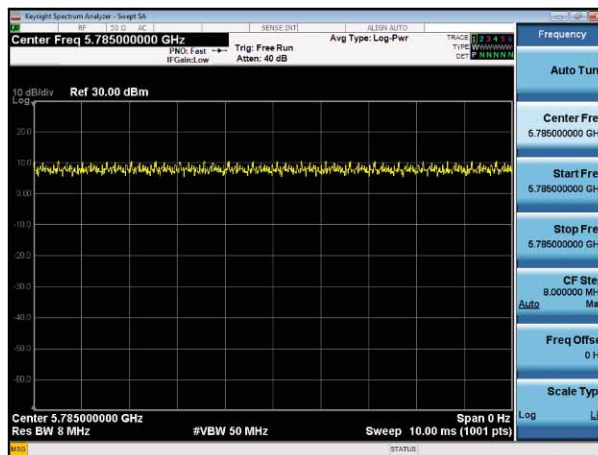

802.11ac(VHT20) 5785MHz

4.4. Maximum Average Output Power

TEST CONFIGURATION

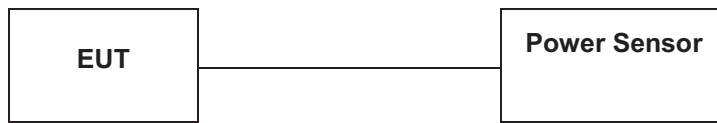

TEST PROCEDURE

According to KDB789033 D02 General UNII Test Procedures New Rules v01 Section E3 Measurement using a Power Meter (PM):

- a. Measurements may be performed using a wideband RF power meter with a thermocouple detector or equivalent if all of the conditions listed below are satisfied
 - 1. The EUT is configured to transmit continuously or to transmit with a constant duty cycle
 - 2. At all times when the EUT is transmitting, it must be transmitting at its maximum power control level.
 - 3. The integration period of the power meter exceeds the repetition period of the transmitted signal by at least a factor of five.
- b. If the transmitter does not transmit continuously, measure the duty cycle, x, of the transmitter output signal as described in section II.B
- c. Measure the average power of the transmitter. This measurement is an average over both the on and off periods of the transmitter.

Adjust the measurement in dBm by adding $10 \log(1/x)$ where x is the duty cycle (e.g., $10 \log(1/0.25)$ if the duty cycle is 25 percent).

LIMIT

According to §15.407(a): The maximum output power should be not exceed follow:

Frequency Range (MHz)	Limit
5150-5250	Fixed: 1 Watt (30dBm) Mobile and portable: 250mW (24dBm)
5250-5350	250mW (24dBm)
5470-5725	250mW (24dBm)
5725-5850	1 Watt (30dBm)

Note: The maximum e.i.r.p at any elevation angle above 30 degrees as measured from the horizon must not exceed 125mW(21dBm)

TEST RESULTS

	Frequency (MHz)	ANT 1 Average Output Power (dBm)	ANT 2 Average Output Power (dBm)	Total Average Output Power (dBm)	FCC Limit (dBm)	Result
802.11a	5745	7.06	7.05	/	30	Pass
	5785	6.23	6.21	/	30	Pass
	5825	7.15	6.98	/	30	Pass
802.11n (HT20)	5745	6.98	7.16	10.08	30	Pass
	5785	7.39	7.33	10.37	30	Pass
	5825	6.95	7.45	10.22	30	Pass
802.11ac (VHT20)	5745	6.55	6.62	9.60	30	Pass
	5785	6.48	7.05	9.78	30	Pass
	5825	5.55	6.36	8.98	30	Pass
802.11n (HT40)	5755	5.16	5.25	8.22	30	Pass
	5795	5.96	5.74	8.86	30	Pass
802.11ac (VHT40)	5755	5.02	5.12	8.08	30	Pass
	5795	5.91	5.86	8.90	30	Pass

Note:

1. Measured output power at difference data rate for each mode and recorded worst case for each mode.
2. Test results including cable loss;
3. Worst case data at 6Mbps at IEEE 802.11a; MCS0 at IEEE 802.11n HT20, IEEE 802.11n HT40, IEEE 802.11a VHT20 and IEEE 802.11ac VHT40;
4. Report conducted power = Measured conducted average power + Duty Cycle factor;
5. The EUT used two monopole antenna for WIFI TX/RX, the directional gain= $2.23+10\log 2=5.24\text{dBi}$. So the power limits of IEEE 802.11n HT20, IEEE 802.11 n HT40, IEEE 802.11 ac VHT20 and IEEE 802.11 ac VHT40 or MIMO with CDD technology should be reduced.

4.5. Power Spectral Density

TEST CONFIGURATION

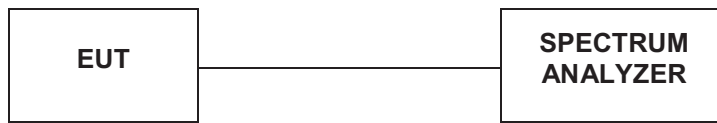

TEST PROCEDURE

According to KDB 789033 D02 General UNII Test Procedures New Rules v01 F: The rules requires “maximum power spectral density” measurements where the intent is to measure the maximum value of the time average of the power spectral density measured during a period of continuous transmission

- a. Create an average power spectrum for the EUT operating mode being tested by following the instructions in section II.E.2. for measuring maximum conducted output power using a spectrum analyzer or EMI receiver: select the appropriate test method (SA-1, SA-2, SA-3, or alternatives to each) and apply it up to, but not including, the step labeled, “Compute power...”. (This procedure is required even if the maximum conducted output power measurement was performed using a power meter, method PM.)
- b. Use the peak search function on the instrument to find the peak of the spectrum and record its value.
- c. Make the following adjustments to the peak value of the spectrum, if applicable:
 1. If Method SA-2 or SA-2 Alternative was used, add $10 \log(1/x)$, where x is the duty cycle, to the peak of the spectrum.
 2.) If Method SA-3 Alternative was used and the linear mode was used in step II.E.2.g)(viii), add 1 dB to the final result to compensate for the difference between linear averaging and power averaging.
- d. The result is the Maximum PSD over 1 MHz reference bandwidth.
- e. For devices operating in the bands 5.15-5.25 GHz, 5.25-5.35 GHz, and 5.47-5.725 GHz, the above procedures make use of 1 MHz RBW to satisfy directly the 1 MHz reference bandwidth specified in § 15.407(a)(5). For devices operating in the band 5.725-5.85 GHz, the rules specify a measurement bandwidth of 500 kHz. Many spectrum analyzers do not have 500 kHz RBW, thus a narrower RBW may need to be used. The rules permit the use of a RBWs less than 1 MHz, or 500 kHz, “provided that the measured power is integrated over the full reference bandwidth” to show the total power over the specified measurement bandwidth (i.e., 1 MHz, or 500 kHz). If measurements are performed using a reduced resolution bandwidth (< 1 MHz, or < 500 kHz) and integrated over 1 MHz, or 500 KHz bandwidth, the following adjustments to the procedures apply:
 1. Set $RBW \geq 1/T$, where T is defined in section II.B.I.a).
 2. Set $VBW \geq 3 RBW$.
 3. If measurement bandwidth of Maximum PSD is specified in 500 kHz, add $10\log(500kHz/RBW)$ to the measured result, whereas RBW (< 500 KHz) is the reduced resolution bandwidth of the spectrum analyzer set during measurement.
 4. If measurement bandwidth of Maximum PSD is specified in 1 MHz, add $10\log(1MHz/RBW)$ to the measured result, whereas RBW (< 1 MHz) is the reduced resolution bandwidth of spectrum analyzer set during measurement.
 5. Care must be taken to ensure that the measurements are performed during a period of continuous transmission or are corrected upward for duty cycle.

Note: As a practical matter, it is recommended to use reduced RBW of 100 KHz for the sections 5.c) and 5.d) above, since RBW=100 KHz is available on nearly all spectrum analyzers.
- f. Adjust the measurement in dBm by adding $10 \log(1/x)$ where x is the duty cycle (e.g., $10 \log(1/0.25)$ if the duty cycle is 25 percent).

LIMIT

According to §15.407(a): The maximum output power should be not exceed follow:

Frequency Range (MHz)	Limit
5150-5250	Other then Mobile and portable:17dBm/MHz Mobile and portable:11dBm/MHz
5250-5350	11dBm/MHz
5470-5725	11dBm/MHz
5725-5850	30dBm/500kHz

TEST RESULTS**5.8G**

Mode	Frequency (MHz)	Power Density(dBm/500KHz)		Total	FCC Limit (dBm/500KHz)
		Antenna 1	Antenna 2		
802.11a	5745	-0.446	-1.761	/	30
	5785	0.262	0.796	/	30
	5825	-2.033	-1.626	/	30
802.11n (HT20)	5745	-1.544	-1.463	1.507	30
	5785	1.121	0.944	4.044	30
	5825	-1.626	-1.654	1.370	30
802.11n (HT40)	5755	-3.881	-3.016	-0.417	30
	5795	-2.341	-2.565	0.559	30
802.11ac (VHT20)	5745	-1.197	-0.994	1.916	30
	5785	0.726	1.81	4.312	30
	5825	-2.658	-1.113	1.193	30
802.11ac (VHT40)	5755	-3.717	-2.963	-0.313	30
	5795	-2.363	-2.867	0.403	30

Note:

1. Measured power spectrum density at difference data rate for each mode and recorded worst case for each mode.
2. Test results including cable loss;
3. Worst case data at 6Mbps at IEEE 802.11a; MCS0 at IEEE 802.11n HT20, IEEE 802.11n HT40, IEEE 802.11a VHT20 and IEEE 802.11ac VHT40;
4. The EUT used two monopole antenna for WIFI TX/RX, the directional gain= $2.23+10\log 2=5.24\text{dBi}$. So the power spectrum density limits of IEEE 802.11n HT20, IEEE 802.11 n HT40, IEEE 802.11 ac VHT20 and IEEE 802.11 ac VHT40 for MIMO with CDD technology should be reduced.
5. Please refer to following test plots;

5.8G Antenna 1

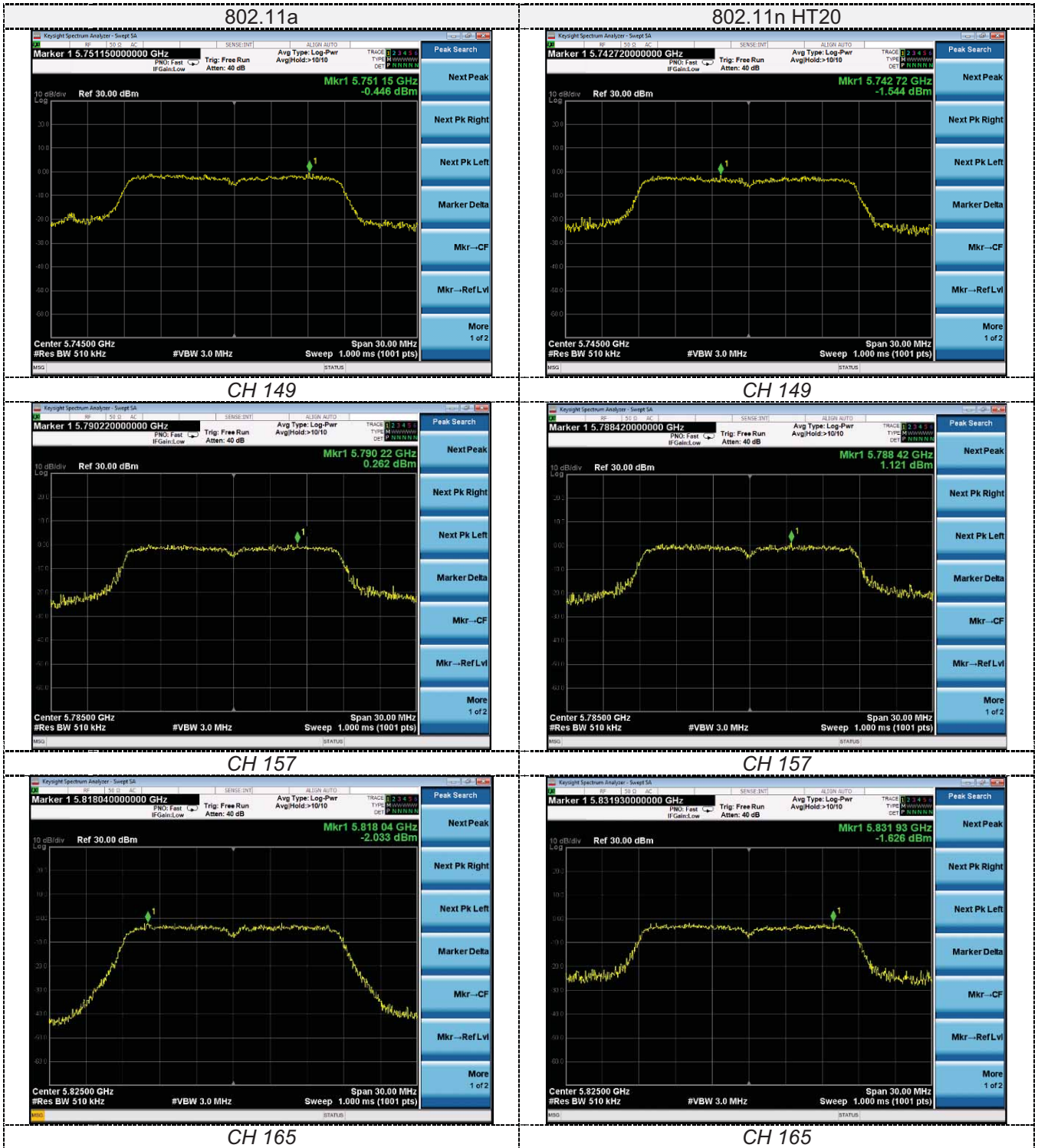

802.11ac VHT20



802.11n HT40



CH 149



CH 151



CH 157



CH 159



CH 165

802.11ac VHT40



CH 151



CH 159

5.8G Antenna 2

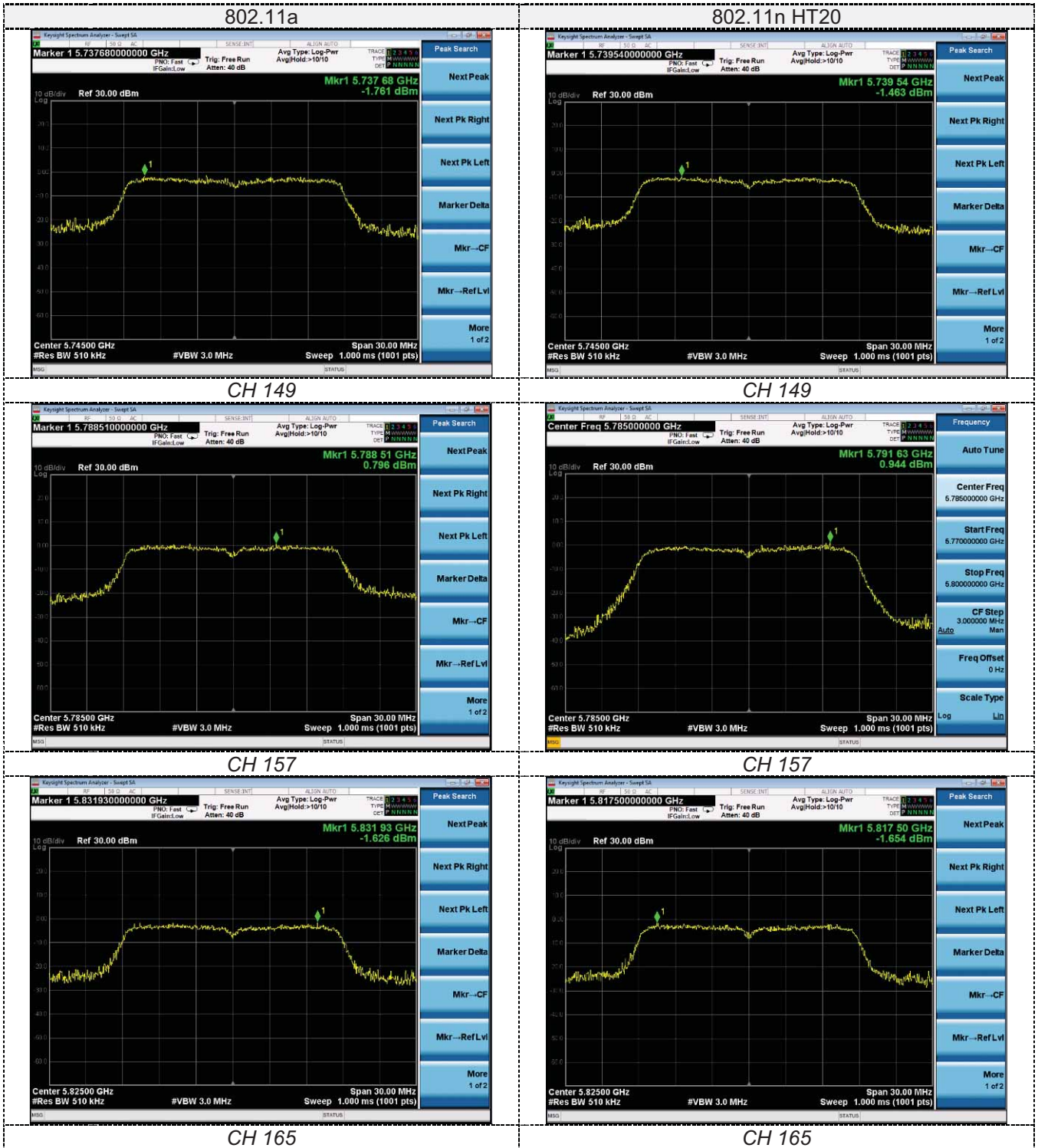

802.11ac VHT20



802.11n HT40



CH 149



CH 151



CH 157



CH 159

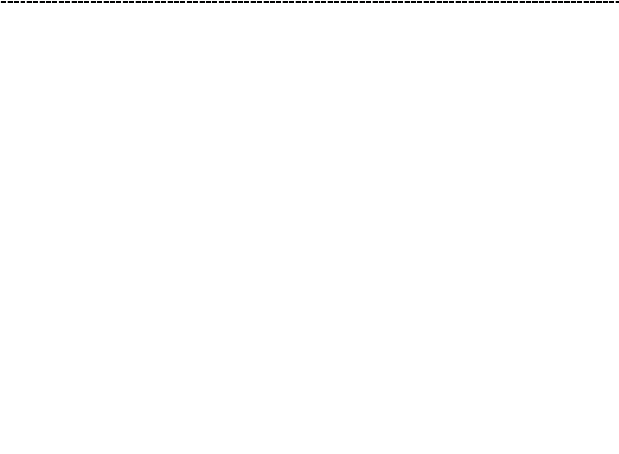

CH 165

802.11ac VHT40



CH 151



CH 159

4.6. 6dB Bandwidth

TEST CONFIGURATION

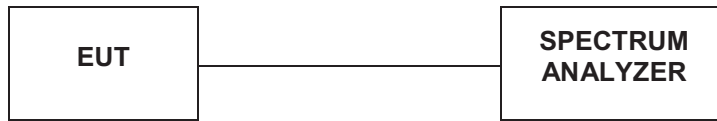

TEST PROCEDURE

According to KDB789033 D02 General UNII Test Procedures New Rules v01 for one of the following procedures may be used for section 15.407(e) specifies the minimum 6 dB emission bandwidth of at least 500 KHz for the band 5.715-5.85 GHz. The following procedure shall be used for measuring this bandwidth:

- a. Set RBW = 100 kHz.
- b. Set the video bandwidth (VBW) $\geq 3 \times$ RBW
- c. Detector = Peak.
- d. Trace mode = max hold.
- e. Sweep = auto couple.
- f. Allow the trace to stabilize
- g. Measure the maximum width of the emission that is constrained by the frequencies associated with the two outermost amplitude points (upper and lower frequencies) that are attenuated by 6 dB relative to the maximum level measured in the fundamental emission.

Note: The automatic bandwidth measurement capability of a spectrum analyzer or EMI receiver may be employed if it implements the functionality described above.

LIMIT

For Section 15.407(e) specifies the minimum 6 dB emission bandwidth of at least 500 KHz for the band 5.715-5.85 GHz

TEST RESULTS

Antenna 1

Type	Channel	6dB Bandwidth (MHz)	Limit (KHz)	Result
802.11ac	149	16.71	≥500	Pass
	157	17.32		
	165	17.57		
802.11n HT20	149	16.92	≥500	Pass
	157	17.60		
	165	16.98		
802.11ac VHT20	149	16.92	≥500	Pass
	157	17.55		
	165	17.57		
802.11n HT 40	151	36.35	≥500	Pass
	159	35.47		
802.11ac VHT40	151	36.35	≥500	Pass
	159	35.82		

Antenna 2

Type	Channel	6dB Bandwidth (MHz)	Limit (KHz)	Result
802.11ac	149	16.92	≥500	Pass
	157	16.91		
	165	15.57		
802.11n HT20	149	16.92	≥500	Pass
	157	17.27		
	165	17.04		
802.11ac VHT20	149	16.92	≥500	Pass
	157	17.27		
	165	17.22		
802.11n HT 40	151	36.38	≥500	Pass
	159	35.75		
802.11ac VHT40	151	36.38	≥500	Pass
	159	35.47		

Note:

1. Measured 6dB bandwidth at difference data rate for each mode and recorded worst case for each mode.
2. Test results including cable loss;
3. Worst case data at 6Mbps at IEEE 802.11a; MCS0 at IEEE 802.11n HT20, IEEE 802.11n HT40, IEEE 802.11a VHT20 and IEEE 802.11ac VHT40;
4. Please refer to following test plots;

Antenna 1

802.11a

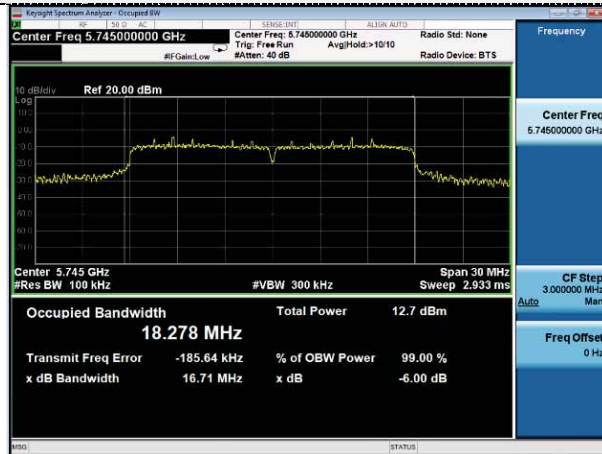

802.11n HT20

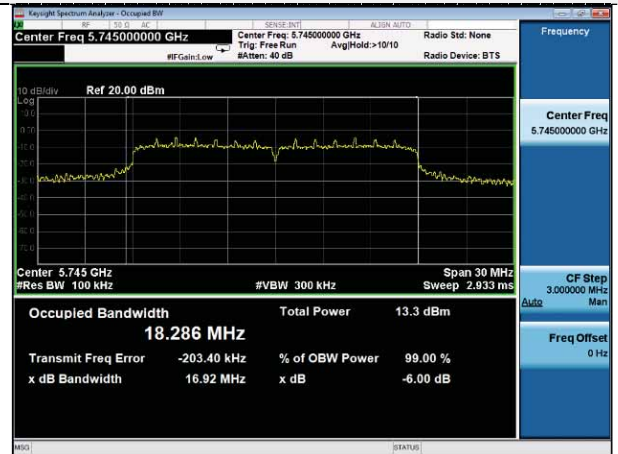

CH149



CH149



CH157



CH157

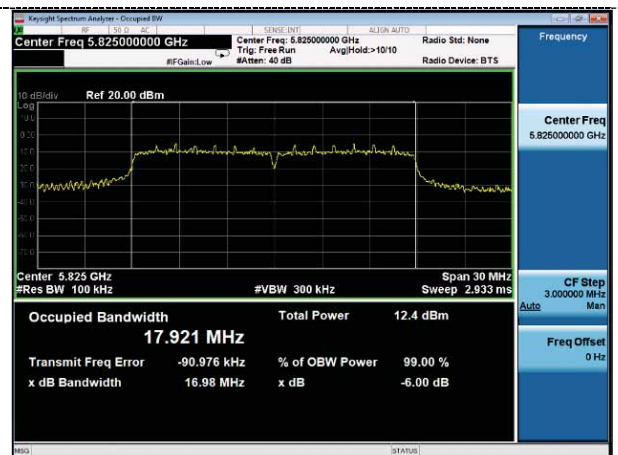

CH165



CH165



802.11ac VHT20

802.11n HT40

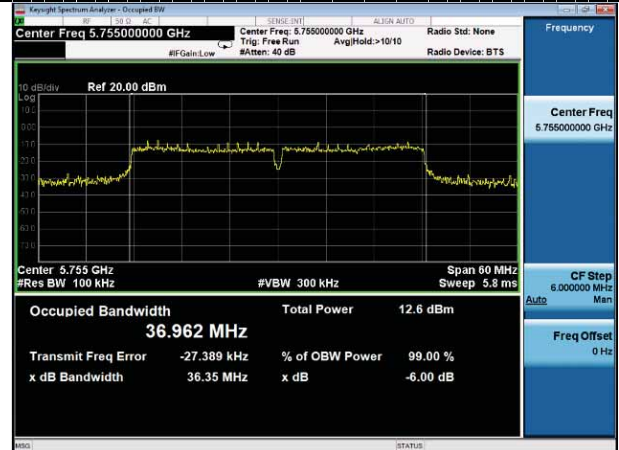
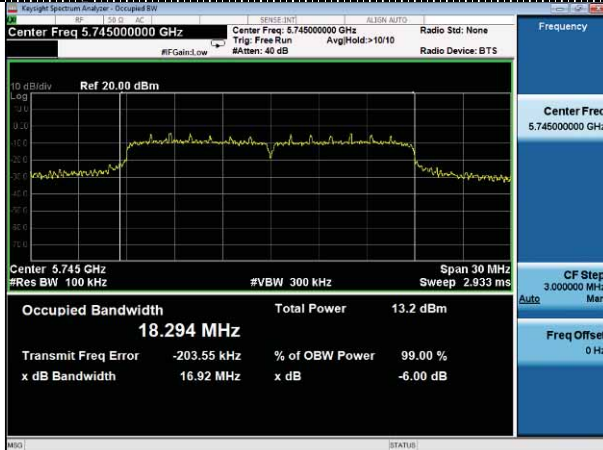

CH149

CH151



CH157

CH159

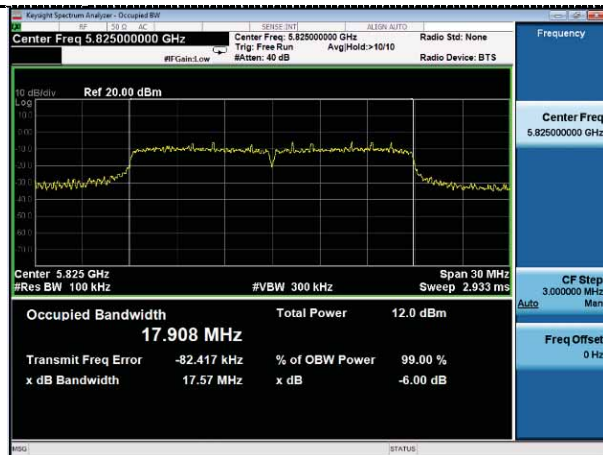

CH165

802.11ac VHT40

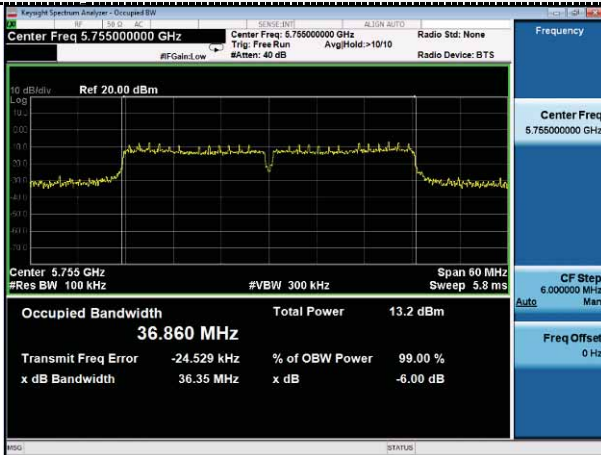

CH151



CH159

Antenna 2

802.11a

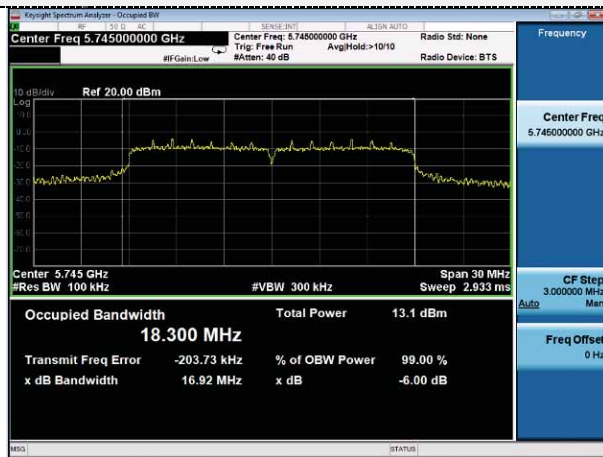

802.11n HT20

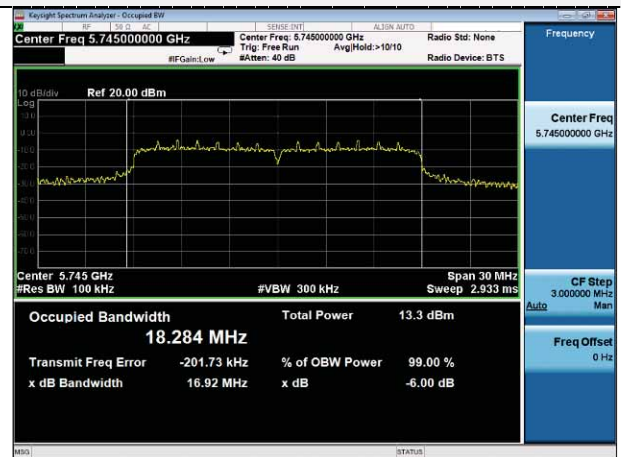

CH149

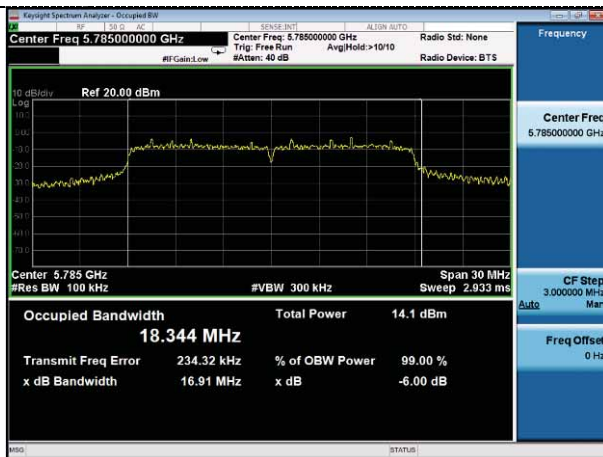

CH149



CH157



CH157

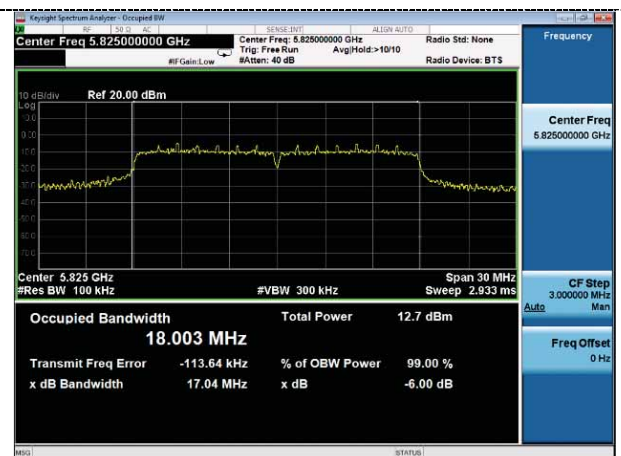

CH165

CH165

802.11ac VHT20

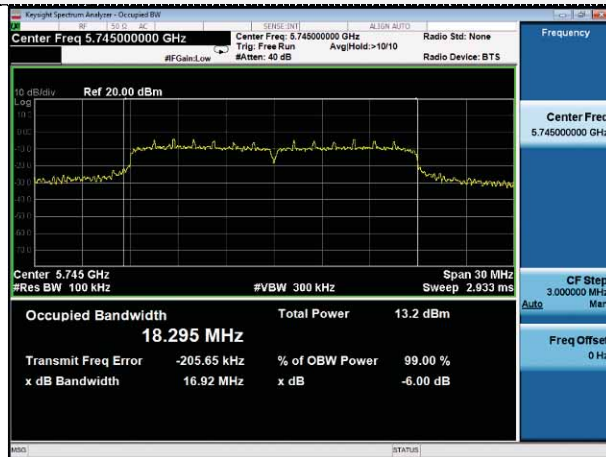

802.11n HT40



CH149



CH151

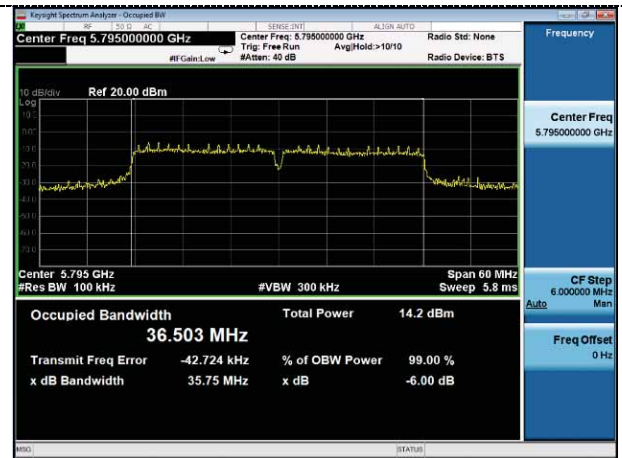

CH157

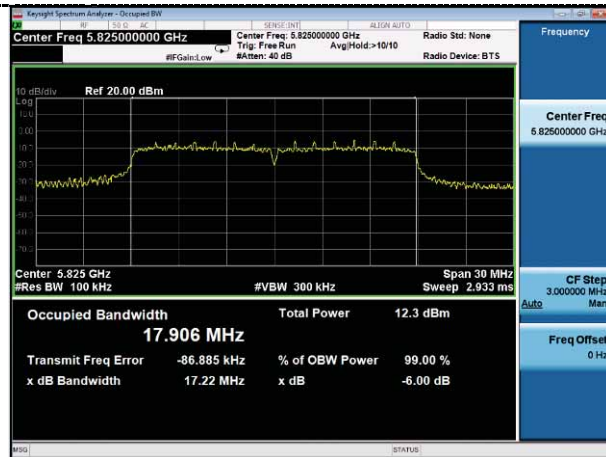

CH159

CH165

802.11ac VHT40

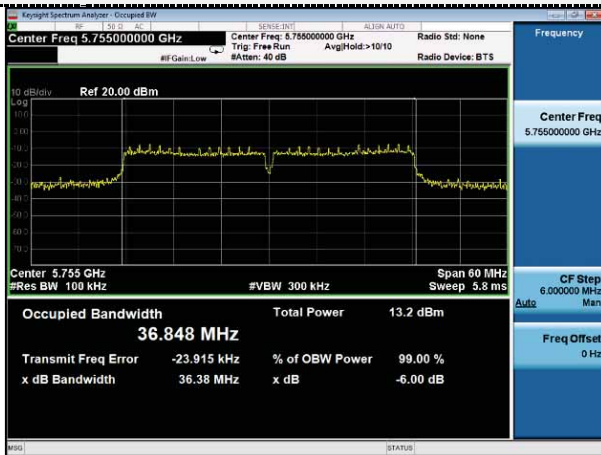

CH151



CH159

4.7. 26dBc Bandwidth

TEST CONFIGURATION

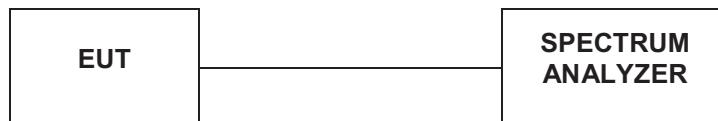

TEST PROCEDURE

Emission Bandwidth (EBW)

- a) Set RBW = approximately 1% of the emission bandwidth.
- b) Set the VBW > RBW.
- c) Detector = Peak.
- d) Trace mode = max hold.
- e) Measure the maximum width of the emission that is 26 dB down from the maximum of the emission.
Compare this with the RBW setting of the analyzer. Readjust RBW and repeat measurement as needed until the RBW/EBW ratio is approximately 1%.

LIMIT

No Limits for 26dBc Bandwidth

TEST RESULTS

This product is not applicable to this project.

4.8. Band Edge Compliance

TEST CONFIGURATION

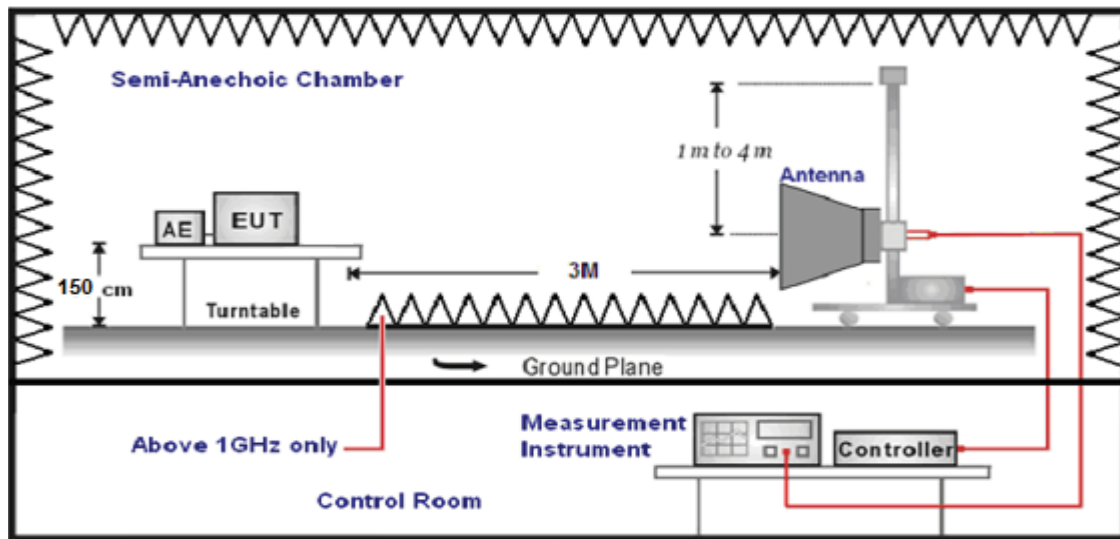

LIMIT

20dBc in any 100 kHz bandwidth outside the operating frequency band. In case the emission fall within the restricted band specified on 15.205(a), then the 15.209(a) limit in the table below has to be followed.

Frequency (MHz)	Distance (Meters)	Radiated (dBµV/m)	Radiated (µV/m)
0.009-0.49	3	$20\log(2400/F(\text{KHz}))+40\log(300/3)$	$2400/F(\text{KHz})$
0.49-1.705	3	$20\log(24000/F(\text{KHz}))+40\log(30/3)$	$24000/F(\text{KHz})$
1.705-30	3	$20\log(30)+40\log(30/3)$	30
30-88	3	40.0	100
88-216	3	43.5	150
216-960	3	46.0	200
Above 960	3	54.0	500

According to §15.407 (b):

For transmitters operating in the 5.15-5.25 GHz band: All emissions outside of the 5.15-5.35 GHz band shall not exceed an e.i.r.p. of -27 dBm/MHz.

For transmitters operating in the 5.25-5.35 GHz band: All emissions outside of the 5.15-5.35 GHz band shall not exceed an e.i.r.p. of -27 dBm/MHz.

For transmitters operating in the 5.47-5.725 GHz band: All emissions outside of the 5.47-5.725 GHz band shall not exceed an e.i.r.p. of -27 dBm/MHz.

For transmitters operating in the 5.725-5.85 GHz band:

All emissions shall be limited to a level of -27 dBm/MHz at 75 MHz or more above or below the band edge increasing linearly to 10 dBm/MHz at 25 MHz above or below the band edge, and from 25 MHz above or below the band edge increasing linearly to a level of 15.6 dBm/MHz at 5 MHz above or below the band edge, and from 5 MHz above or below the band edge increasing linearly to a level of 27 dBm/MHz at the band edge.

Frequency (MHz)		EIRP Limit (dBm)	Equivalent Field Strength at 3m (dBµV/m)
5150-5250		-27	68.3
5250-5350		-27	68.3
5470-5725		-27	68.3
5725-5850	Below 5650	-27	68.3
	5650-5700	-27~10	68.3~105.3
	5700-5720	10~15.6	105.3~110.9
	5720-5725	15.6~27	110.9~68.3
	5725-5850	27	122.3
	5850-5855	27~15.6	122.3~110.9
	5855-5875	15.6~10	110.9~105.3
	5875-5925	10~-27	105.3~68.3
	Above 5925	-27	68.3

TEST PROCEDURE

1. The EUT was placed on a turn table which is 1.5m above 1GHz.
2. Maximum procedure was performed by raising the receiving antenna from 1m to 4m and rotating the turn table from 0° to 360° to acquire the highest emissions from EUT.
3. And also, each emission was to be maximized by changing the polarization of receiving antenna both horizontal and vertical.
4. Repeat above procedures until all frequency measurements have been completed..
5. The distance between test antenna and EUT as following table states:

Test Frequency range	Test Antenna Type	Test Distance
1GHz-18GHz	Double Ridged Horn Antenna	3

6. Setting test receiver/spectrum as following table states:

Test Frequency range	Test Receiver/Spectrum Setting	Detector
1GHz-18GHz	Peak Value: RBW=1MHz/VBW=3MHz, Sweep time=Auto Average Value: RBW=1MHz/VBW=10Hz, Sweep time=Auto	Peak

Field Strength Calculation

The field strength is calculated by adding the Antenna Factor and Cable Factor and subtracting the Amplifier Gain and Duty Cycle Correction Factor(if any) from the measured reading. The basic equation with a sample calculation is as follows:

$$FS = RA + AF + CL - AG$$

Where FS = Field Strength	CL = Cable Attenuation Factor (Cable Loss)
RA = Reading Amplitude	AG = Amplifier Gain
AF = Antenna Factor	

TEST RESULTS

Remark: We tested at all modes at the antenna single transmitting mode and the Mimo mode, and recored the worst data at the Mimo mode of the 802.11a Mode.

For Antenna 1

IEEE 802.11a							
Frequency (MHz)	Conducted Power (dBm)	Antenna Gain (dBi)	EIRP (dBm/1MHz)	Detector	Limit (dBm/1MHz)	Over limit dB	Verdict
5650.000	-39.53	2.23	-37.3	Peak	-27	-10.3	PASS
5700.000	39.768	2.23	41.998	Peak	-27	68.998	PASS
5720.000	39.663	2.23	41.893	Peak	-17	58.893	PASS
5725.000	-35.806	2.23	-33.576	Peak	-17	-16.576	PASS
5850.000	-40.855	2.23	-38.625	Peak	-17	-21.625	PASS
5855.000	-41.48	2.23	-39.25	Peak	-17	-22.25	PASS
5875.000	-41.764	2.23	-39.534	Peak	-27	-12.534	PASS
5925.000	-40.331	2.23	-38.101	Peak	-27	-11.101	PASS

IEEE 802.11n HT20							
Frequency (MHz)	Conducted Power (dBm)	Antenna Gain (dBi)	EIRP (dBm/1MHz)	Detector	Limit (dBm/1MHz)	Over limit dB	Verdict
5650.000	-41.606	2.23	-39.376	Peak	-27	-12.376	PASS
5700.000	-40.644	2.23	-38.414	Peak	-27	-11.414	PASS
5720.000	-41.212	2.23	-38.982	Peak	-17	-21.982	PASS
5725.000	-41.184	2.23	-38.954	Peak	-17	-21.954	PASS
5850.000	-41.514	2.23	-39.284	Peak	-17	-22.284	PASS
5855.000	-41.087	2.23	-38.857	Peak	-17	-21.857	PASS
5875.000	-40.445	2.23	-38.215	Peak	-27	-11.215	PASS
5925.000	-41.481	2.23	-39.251	Peak	-27	-12.251	PASS

IEEE 802.11ac20							
Frequency (MHz)	Conducted Power (dBm)	Antenna Gain (dBi)	EIRP (dBm/1MHz)	Detector	Limit (dBm/1MHz)	Over limit dB	Verdict
5650.000	-43.197	2.23	-40.967	Peak	-27	-13.967	PASS
5700.000	-41.168	2.23	-38.938	Peak	-27	-11.938	PASS
5720.000	-42.553	2.23	-40.323	Peak	-17	-23.323	PASS
5725.000	-42.168	2.23	-39.938	Peak	-17	-22.938	PASS
5850.000	-41.787	2.23	-39.557	Peak	-17	-22.557	PASS
5855.000	-41.477	2.23	-39.247	Peak	-17	-22.247	PASS
5875.000	-41.809	2.23	-39.579	Peak	-27	-12.579	PASS
5925.000	-41.44	2.23	-39.21	Peak	-27	-12.21	PASS

IEEE 802.11n HT40							
Frequency (MHz)	Conducted Power (dBm)	Antenna Gain (dBi)	EIRP (dBm/1MHz)	Detector	Limit (dBm/1MHz)	Over limit dB	Verdict
5650.000	-40.902	2.23	-38.672	Peak	-27	-11.672	PASS
5700.000	-41.198	2.23	-38.968	Peak	-27	-11.968	PASS
5720.000	-41.637	2.23	-39.407	Peak	-17	-22.407	PASS
5725.000	-41.612	2.23	-39.382	Peak	-17	-22.382	PASS
5850.000	-39.018	2.23	-36.788	Peak	-17	-19.788	PASS
5855.000	-40.333	2.23	-38.103	Peak	-17	-21.103	PASS
5875.000	-42.351	2.23	-40.121	Peak	-27	-13.121	PASS
5925.000	-41.227	2.23	-38.997	Peak	-27	-11.997	PASS

IEEE 802.11ac40							
Frequency (MHz)	Conducted Power (dBm)	Antenna Gain (dBi)	EIRP (dBm/1MHz)	Detector	Limit (dBm/1MHz)	Over limit dB	Verdict
5650.000	-39.949	2.23	-37.719	Peak	-27	-10.719	PASS
5700.000	-41.19	2.23	-38.96	Peak	-27	-11.96	PASS
5720.000	-30.201	2.23	-27.971	Peak	-17	-10.971	PASS
5725.000	-29.863	2.23	-27.633	Peak	-17	-10.633	PASS
5850.000	-42.769	2.23	-40.539	Peak	-17	-23.539	PASS
5855.000	-42.335	2.23	-40.105	Peak	-17	-23.105	PASS
5875.000	-42.114	2.23	-39.884	Peak	-27	-12.884	PASS
5925.000	-42.075	2.23	-39.845	Peak	-27	-12.845	PASS

For Antenna 2

IEEE 802.11a							
Frequency (MHz)	Conducted Power (dBm)	Antenna Gain (dBi)	EIRP (dBm/1MHz)	Detector	Limit (dBm/1MHz)	Over limit dB	Verdict
5650.000	-42.086	2.23	-39.856	Peak	-27	-12.856	PASS
5700.000	-41.981	2.23	-39.751	Peak	-27	-12.751	PASS
5720.000	-39.793	2.23	-37.563	Peak	-17	-20.563	PASS
5725.000	-43.517	2.23	-41.287	Peak	-17	-24.287	PASS
5850.000	-41.295	2.23	-39.065	Peak	-17	-22.065	PASS
5855.000	-40.873	2.23	-38.643	Peak	-17	-21.643	PASS
5875.000	-41.257	2.23	-39.027	Peak	-27	-12.027	PASS
5925.000	-41.382	2.23	-39.152	Peak	-27	-12.152	PASS

IEEE 802.11n 20							
Frequency (MHz)	Conducted Power (dBm)	Antenna Gain (dBi)	EIRP (dBm/1MHz)	Detector	Limit (dBm/1MHz)	Over limit dB	Verdict
5650.000	-42.046	2.23	-39.816	Peak	-27	-12.816	PASS
5700.000	-41.753	2.23	-39.523	Peak	-27	-12.523	PASS
5720.000	-39.977	2.23	-37.747	Peak	-17	-20.747	PASS
5725.000	-41.338	2.23	-39.108	Peak	-17	-22.108	PASS
5850.000	-39.838	2.23	-37.608	Peak	-17	-20.608	PASS
5855.000	-41.975	2.23	-39.745	Peak	-17	-22.745	PASS
5875.000	-41.356	2.23	-39.126	Peak	-27	-12.126	PASS
5925.000	-42.046	2.23	-39.816	Peak	-27	-12.816	PASS

IEEE 802.11ac20							
Frequency (MHz)	Conducted Power (dBm)	Antenna Gain (dBi)	EIRP (dBm/1MHz)	Detector	Limit (dBm/1MHz)	Over limit dB	Verdict
5650.000	-41.178	2.23	-38.948	Peak	-27	-11.948	PASS
5700.000	-39.618	2.23	-37.388	Peak	-27	-10.388	PASS
5720.000	-39.977	2.23	-37.747	Peak	-17	-20.747	PASS
5725.000	-39.337	2.23	-37.107	Peak	-17	-20.107	PASS
5850.000	-41.177	2.23	-38.947	Peak	-17	-21.947	PASS
5855.000	-40.905	2.23	-38.675	Peak	-17	-21.675	PASS
5875.000	-41.722	2.23	-39.492	Peak	-27	-12.492	PASS
5925.000	-41.646	2.23	-39.416	Peak	-27	-12.416	PASS

IEEE 802.11n40							
Frequency (MHz)	Conducted Power (dBm)	Antenna Gain (dBi)	EIRP (dBm/1MHz)	Detector	Limit (dBm/1MHz)	Over limit dB	Verdict
5650.000	-42.508	2.23	-40.278	Peak	-27	-13.278	PASS
5700.000	-40.284	2.23	-38.054	Peak	-27	-11.054	PASS
5720.000	-34.61	2.23	-32.38	Peak	-17	-15.38	PASS
5725.000	-31.432	2.23	-29.202	Peak	-17	-12.202	PASS
5850.000	-39.934	2.23	-37.704	Peak	-17	-20.704	PASS
5855.000	-39.512	2.23	-37.282	Peak	-17	-20.282	PASS
5875.000	-40.279	2.23	-38.049	Peak	-27	-11.049	PASS
5925.000	-40.89	2.23	-38.66	Peak	-27	-11.66	PASS

IEEE 802.11ac40							
Frequency (MHz)	Conducted Power (dBm)	Antenna Gain (dBi)	EIRP (dBm/1MHz)	Detector	Limit (dBm/1MHz)	Over limit dB	Verdict
5650.000	-41.072	2.23	-38.842	Peak	-27	-11.842	PASS
5700.000	-42.013	2.23	-39.783	Peak	-27	-12.783	PASS
5720.000	-35.08	2.23	-32.85	Peak	-17	-15.85	PASS
5725.000	-31.276	2.23	-29.046	Peak	-17	-12.046	PASS
5850.000	-41.38	2.23	-39.15	Peak	-17	-22.15	PASS
5855.000	-39.512	2.23	-37.282	Peak	-17	-20.282	PASS
5875.000	-40.276	2.23	-38.046	Peak	-27	-11.046	PASS
5925.000	-40.89	2.23	-38.66	Peak	-27	-11.66	PASS

For Combined Antenna 1 and Antenna 2

IEEE 802.11n20									
Frequency (MHz)	Conducted Power (dBm)			Directional Gain (dB)	EIRP (dBm/1MHz)	Detector	Limit (dBm/1MHz)	Over limit dB	Verdict
	Antenna 0	Antenna 1	Sum						
5650.000	-41.606	-42.046	-38.810	5.24	-33.570	Peak	-27	-6.570	PASS
5700.000	-40.644	-41.753	-38.153	5.24	-32.913	Peak	-27	-5.913	PASS
5720.000	-41.212	-39.977	-37.540	5.24	-32.300	Peak	-17	-15.300	PASS
5725.000	-41.184	-41.338	-38.250	5.24	-33.010	Peak	-17	-16.010	PASS
5850.000	-41.514	-39.838	-37.585	5.24	-32.345	Peak	-17	-15.345	PASS
5855.000	-41.087	-41.975	-38.498	5.24	-33.258	Peak	-17	-16.258	PASS
5875.000	-40.445	-41.356	-37.866	5.24	-32.626	Peak	-27	-5.626	PASS
5925.000	-41.481	-43.654	-39.423	5.24	-34.183	Peak	-27	-7.183	PASS

IEEE 802.11ac20									
Frequency (MHz)	Conducted Power (dBm)			Directional Gain (dB)	EIRP (dBm/1MHz)	Detector	Limit (dBm/1MHz)	Over limit dB	Verdict
	Antenna 0	Antenna 1	Sum						
5650.000	-43.197	-41.178	-39.061	5.24	-33.821	Peak	-27	-6.821	PASS
5700.000	-41.168	-39.618	-37.314	5.24	-32.074	Peak	-27	-5.074	PASS
5720.000	-42.553	-39.977	-38.066	5.24	-32.826	Peak	-17	-15.826	PASS
5725.000	-42.168	-39.337	-37.515	5.24	-32.275	Peak	-17	-15.275	PASS
5850.000	-41.787	-41.177	-38.461	5.24	-33.221	Peak	-17	-16.221	PASS
5855.000	-41.477	-40.905	-38.171	5.24	-32.931	Peak	-17	-15.931	PASS
5875.000	-41.809	-41.722	-38.755	5.24	-33.515	Peak	-27	-6.515	PASS
5925.000	-41.44	-41.646	-38.531	5.24	-33.291	Peak	-27	-6.291	PASS

IEEE 802.11n40									
Frequency (MHz)	Conducted Power (dBm)			Directional Gain (dB)	EIRP (dBm/1MHz)	Detector	Limit (dBm/1MHz)	Over limit dB	Verdict
	Antenna 0	Antenna 1	Sum						
5650.000	-40.902	-42.508	-38.621	5.24	-33.381	Peak	-27	-6.381	PASS
5700.000	-41.198	-40.284	-37.707	5.24	-32.467	Peak	-27	-5.467	PASS
5720.000	-41.637	-34.61	-33.824	5.24	-28.584	Peak	-17	-11.584	PASS
5725.000	-41.612	-31.432	-31.034	5.24	-25.794	Peak	-17	-8.794	PASS
5850.000	-39.018	-39.934	-36.442	5.24	-31.202	Peak	-17	-14.202	PASS
5855.000	-40.333	-39.512	-36.893	5.24	-31.653	Peak	-17	-14.653	PASS
5875.000	-42.351	-40.279	-38.182	5.24	-32.942	Peak	-27	-5.942	PASS
5925.000	-41.227	-40.89	-38.045	5.24	-32.805	Peak	-27	-5.805	PASS

IEEE 802.11ac40									
Frequency (MHz)	Conducted Power (dBm)			Directional Gain (dB)	EIRP (dBm/1MHz)	Detector	Limit (dBm/1MHz)	Over limit dB	Verdict
	Antenna 0	Antenna 1	Sum						
5650.000	-39.949	-41.072	-37.464	5.24	-32.224	Peak	-27	-5.224	PASS
5700.000	-41.19	-42.013	-38.572	5.24	-33.332	Peak	-27	-6.332	PASS
5720.000	-30.201	-35.08	-28.978	5.24	-23.738	Peak	-17	-6.738	PASS
5725.000	-29.863	-31.276	-27.502	5.24	-22.262	Peak	-17	-5.262	PASS
5850.000	-42.769	-41.38	-39.009	5.24	-33.769	Peak	-17	-16.769	PASS
5855.000	-42.335	-39.512	-37.688	5.24	-32.448	Peak	-17	-15.448	PASS
5875.000	-42.114	-40.276	-38.088	5.24	-32.848	Peak	-27	-5.848	PASS
5925.000	-42.075	-40.89	-38.432	5.24	-33.192	Peak	-27	-6.192	PASS

Remark:

1. Measured unwanted emission at difference data rate for each mode and recorded worst case for each mode.
2. Test results including cable loss;
3. Worst case data at 6Mbps at IEEE 802.11a; MCS0 at IEEE 802.11n HT20, IEEE 802.11n HT40;
4. For MIMO with CCD technology device, The Directional Gain= Gain of individual transmit antennas (dBi) + Array gain;
Array gain = $10 \log (N_{ant})$, where N_{ant} is the number of transmit antennas.
5. $*5.24=2.23+10*\log(2)$.
6. E.I.R.P = Conducted power + Directional Gain
7. Please refer to following test plots;

5.8G Antenna 1

802.11a



5745

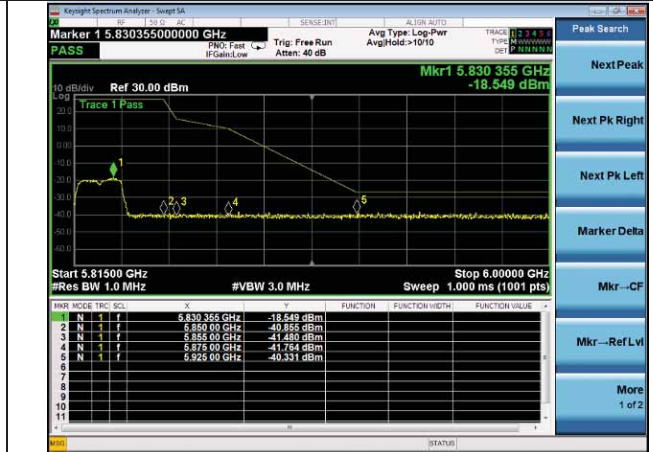

5825

802.11n HT20



5745

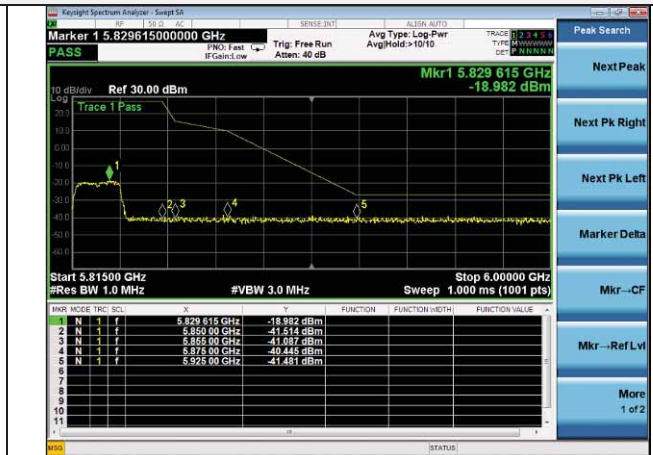

5825

802.11ac VHT20

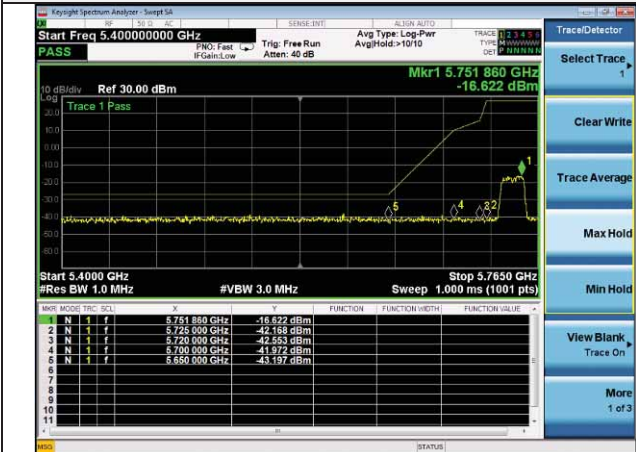

5745

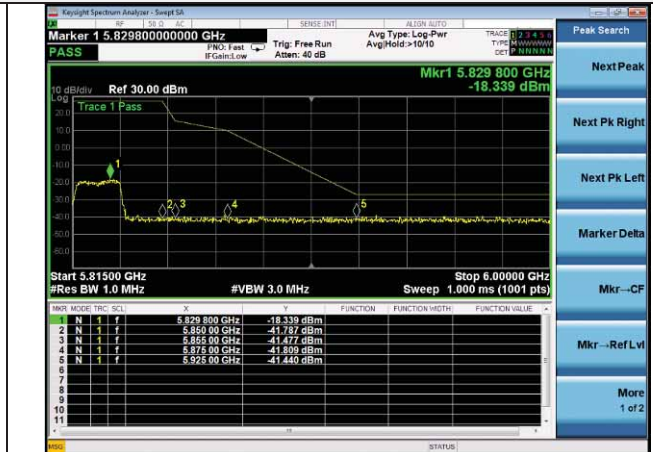

5825

802.11n HT40

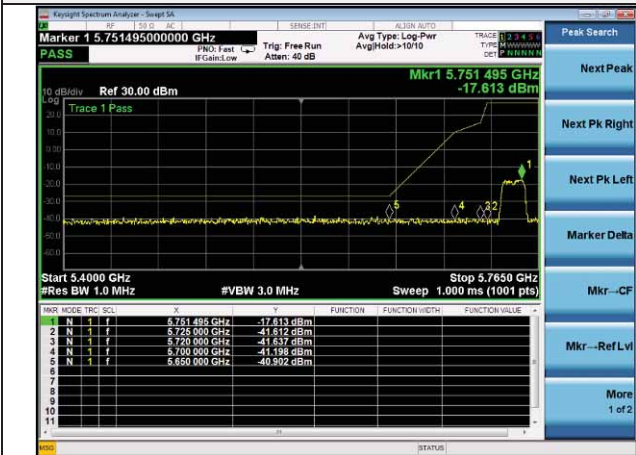

5755



5795

802.11ac VHT40



5755

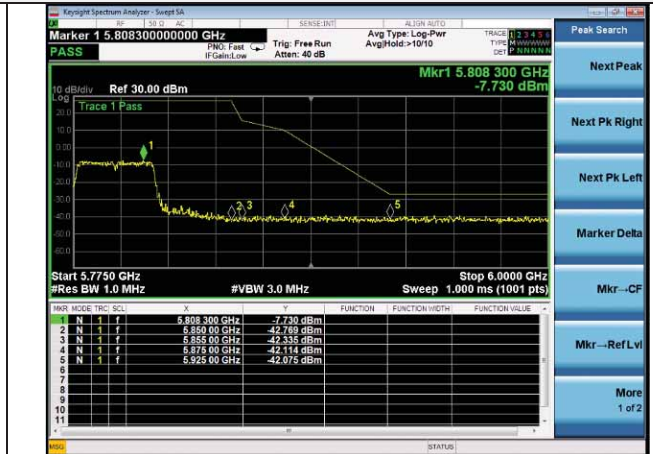

5795

5.8G Antenna 2

802.11a

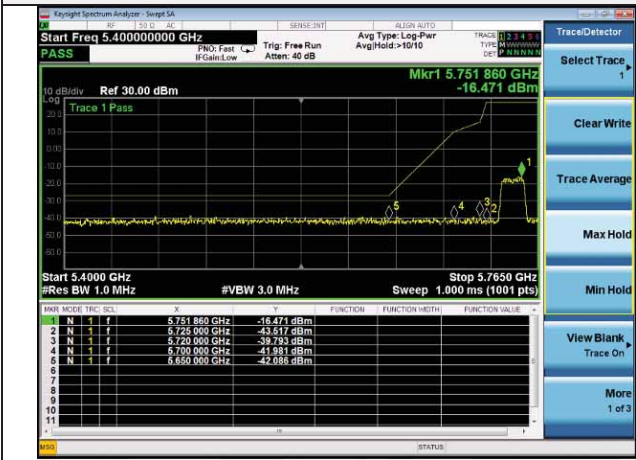

5745

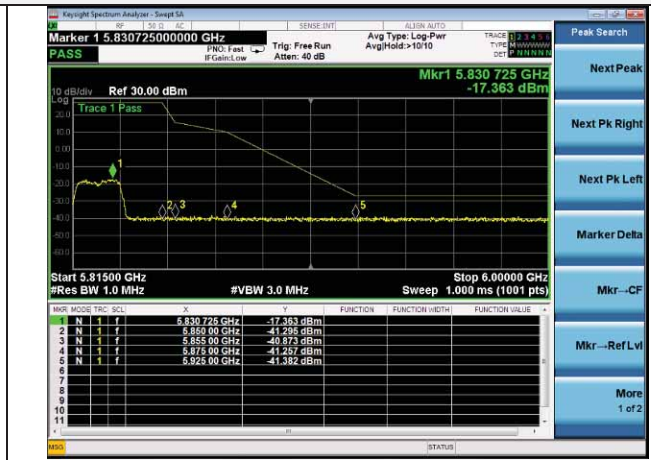

5825

802.11n HT20

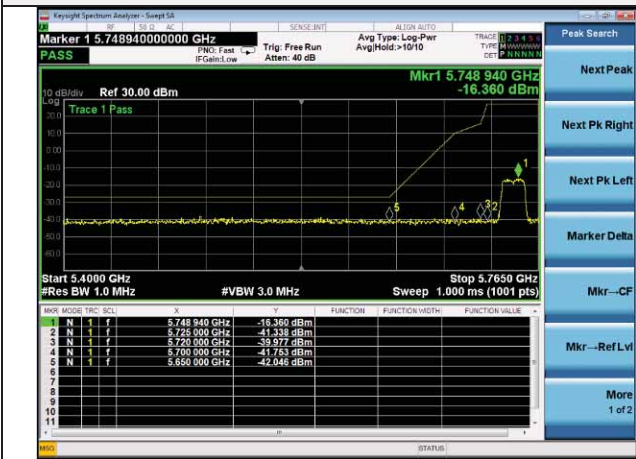

5745

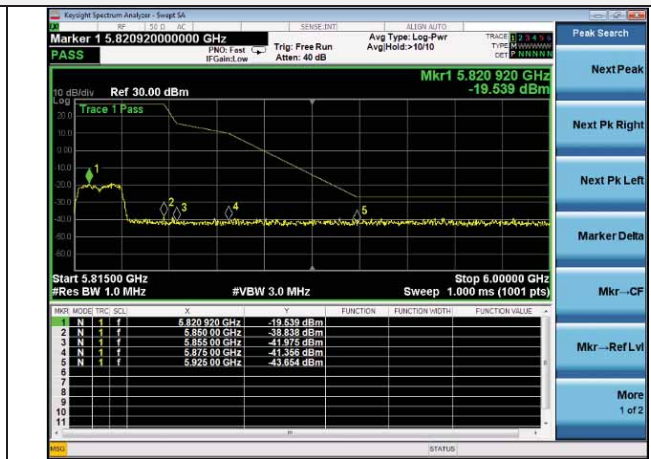

5825

802.11ac VHT20

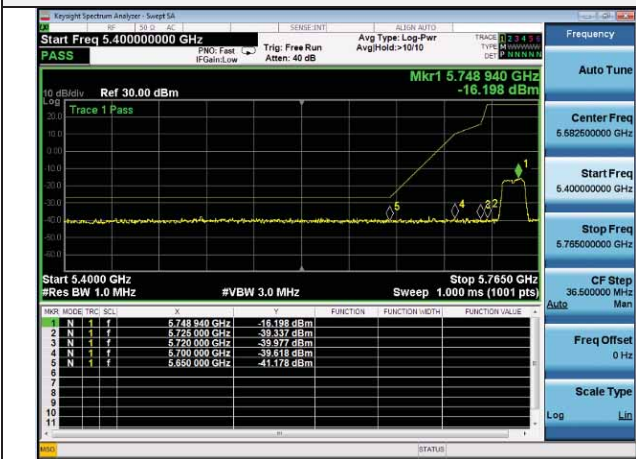

5745

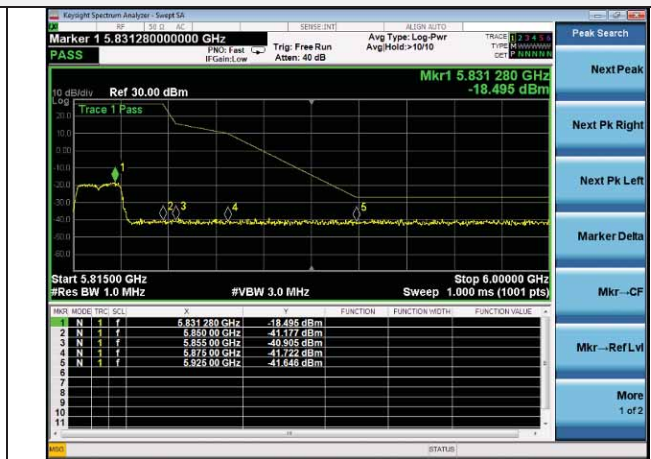

5825

802.11n HT40



5755

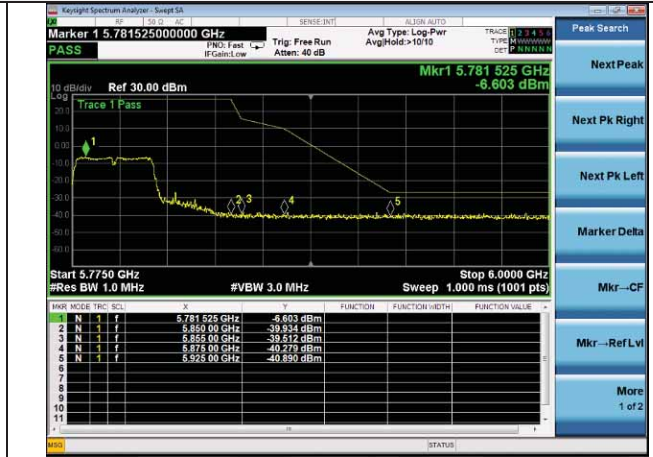

5795

802.11ac VHT40

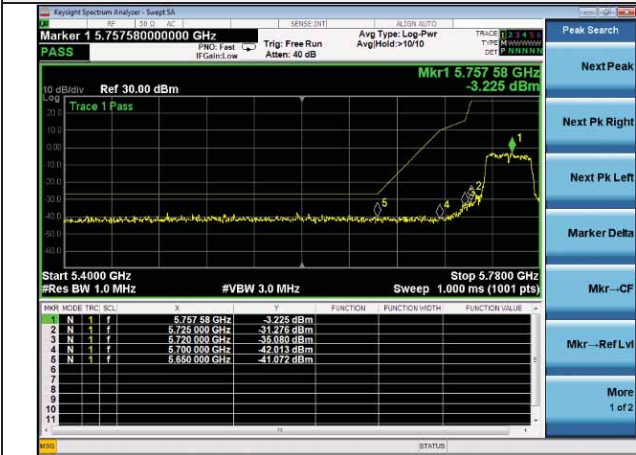

5755

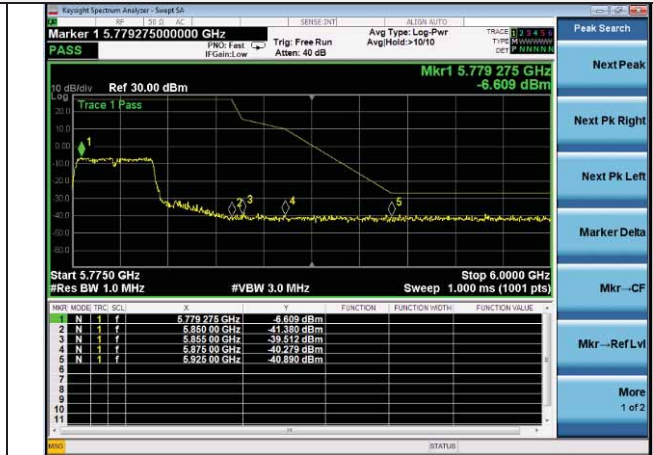

5795

4.9. Frequency Stability

TEST CONFIGURATION

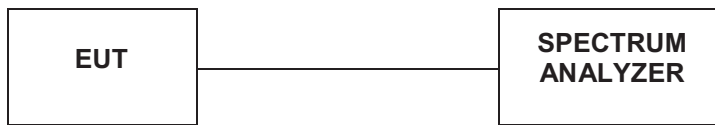

TEST PROCEDURE

- a. The EUT was directly connected to the spectrum analyzer and antenna output port
- b. Spectrum setting as follows:
 RBW=10KHz
 VBW=30KHz
 Span= Entire absence of modulation emissionsbandwidth
 Sweep Time= Auto
 Attenuation= Auto
- c. The test extreme voltage is to change the primary supply voltage from 85 to 115 percent of the nominal value.

LIMIT

Frequency Range (MHz)	Limit
5150-5250	Specified in the user's manual
5250-5350	
5470-5725	
5725-5850	

TEST RESULTS

Antenna 1

802.11 a/ Channel 149: 5745MHz

Voltage. Frequency Stability

Voltage (V)	Measurement Frequency (MHz)
4.2	5745.000017
3.8	5745.000012
3.3	5745.000018
Maximum Deviation (MHz)	0.000018
Maximum Deviation (ppm)	0.0031

Temperature. Frequency Stability

Temperature (°C)	Measurement Frequency (MHz)
-10	5745.000019
5	5745.000012
15	5745.000018
25	5745.000017
35	5745.000020
45	5745.000016
55	5745.000015
Maximum Deviation (MHz)	0.000020
Maximum Deviation (ppm)	0.0035

Antenna 2

802.11 a/ Channel 149: 5745MHz

Voltage. Frequency Stability

Voltage (V)	Measurement Frequency (MHz)
13.8	5745.000018
12.0	5745.000015
10.2	5745.000019
Maximum Deviation (MHz)	0.000019
Maximum Deviation (ppm)	0.0033

Temperature. Frequency Stability

Temperature (°C)	Measurement Frequency (MHz)
-10	5745.000021
5	5745.000013
15	5745.000018
25	5745.000022
35	5745.000018
45	5745.000020
55	5745.000016
Maximum Deviation (MHz)	0.000022
Maximum Deviation (ppm)	0.0038

4.10. Antenna Requirement

Standard Applicable

For intentional device, according to FCC 47 CFR Section 15.203, an intentional radiator shall be designed to ensure that no antenna other than that furnished by the responsible party shall be used with the device.

And according to FCC 47 CFR Section 15.407 (a), if transmitting antennas of directional gain greater than 6dBi are used, the power shall be reduced by the amount in dB that the directional gain of the antenna exceeds 6dBi.

Test Result

The antenna used for this product is internal Antenna and that no antenna other than that furnished by the responsible party shall be used with the device, the maximum peak gain of the transmit antenna is only 2.23dBi.

5. Test Setup Photos of the EUT

Radiated Emission Test



Conducted Emission

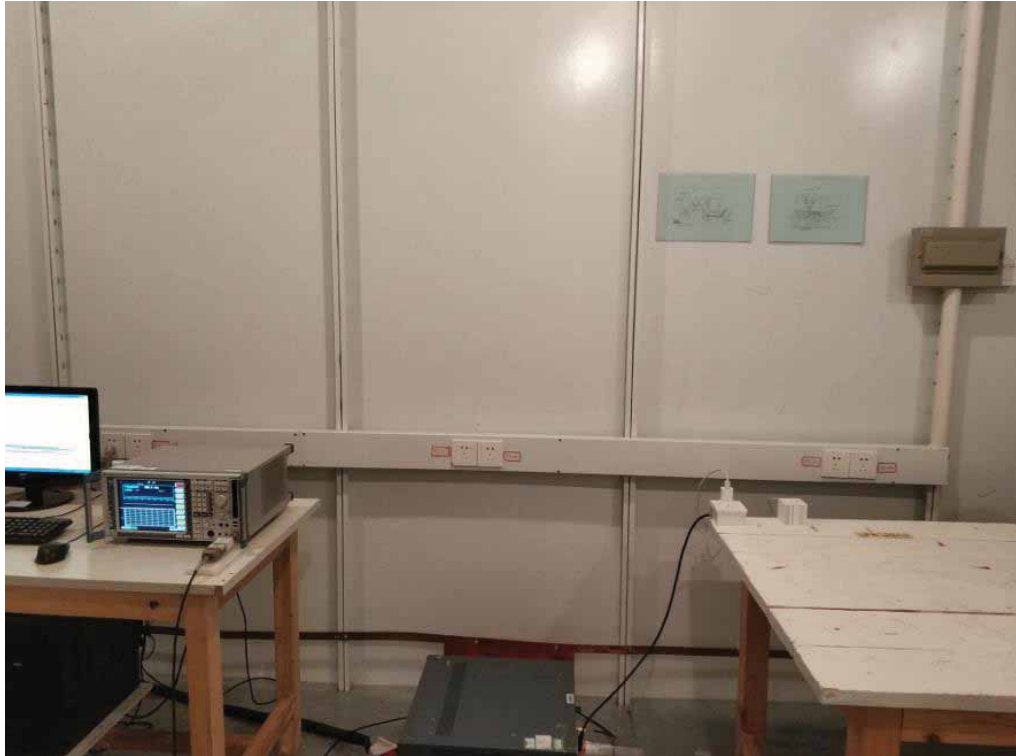

6. External and Internal Photos of the EUT

Reference to the test report No. GTSR18080199-WLAN01.

.....**End of Report**.....