

TEST REPORT

FCC ID: 2AQ4G-SSB5118R

Product: Mobile phone

Model No.: SSB5118R

Additional Model No.: AMS5118R, LM5118R

Trade Mark: MAZE SPEED, SOHO STYLE, LUSH MINT

Report No.: TCT190605E008

Issued Date: Jul. 02, 2019

Issued for:

Shenzhen Link Win Technology Co., Ltd
9F, Zhengqilong Industrial Building, 1st Rd Gushu, Xixiang, Bao'an,
Shenzhen, China

Issued By:

Shenzhen Tongce Testing Lab.
1B/F., Building 1, Yibaolai Industrial Park, Qiaotou, Fuyong, Baoan District,
Shenzhen, Guangdong, China
TEL: +86-755-27673339
FAX: +86-755-27673332

Note: *This report shall not be reproduced except in full, without the written approval of Shenzhen Tongce Testing Lab.*

This document may be altered or revised by Shenzhen Tongce Testing Lab. personnel only, and shall be noted in the revision section of the document. The test results in the report only apply to the tested sample.

TABLE OF CONTENTS

1. Test Certification	3
2. Test Result Summary	4
3. EUT Description.....	5
4. General Information.....	7
4.1. Test environment and mode.....	7
4.2. Test Mode.....	9
4.3. Description of Support Units.....	10
4.4. Configuration of Tested System	11
4.5. Measurement Results Explanation Example.....	11
5. Facilities and Accreditations	12
5.1. Facilities	12
5.2. Location	12
5.3. Measurement Uncertainty.....	12
6. Test Results and Measurement Data	13
6.1. Conducted Output Power Measurement	13
6.2. Peak to Average Ratio.....	16
6.3. 99% Occupied Bandwidth and 26dB Bandwidth Measurement	26
6.4. Band Edge and Conducted Spurious Emission Measurement	36
6.5. Effective Radiated Power and Effective Isotropic Radiated Power Measurement	55
6.6. Field Strength of Spurious Radiation Measurement	62
6.7. Frequency Stability Measurement	71

Appendix A: Photographs of Test Setup

Appendix B: Photographs of EUT

1. Test Certification

Product:	Mobile phone
Model No.:	SSB5118R
Additional Model No.:	AMS5118R, LM5118R
Trade Mark:	MAZE SPEED, SOHO STYLE, LUSH MINT
Applicant:	Shenzhen Link Win Technology Co., Ltd
Address:	9F, Zhengqilong Industrial Building, 1st Rd Gushu, Xixiang, Bao'an, Shenzhen, China
Manufacturer:	Shenzhen Link Win Technology Co., Ltd
Address:	9F, Zhengqilong Industrial Building, 1st Rd Gushu, Xixiang, Bao'an, Shenzhen, China
Date of Test:	Jun. 06, 2019 – Jul. 01, 2019
Applicable Standards:	FCC CFR Title 47 Part 2 FCC CFR Title 47 Part22 FCC CFR Title 47 Part24 FCC CFR Title 47 Part27

The above equipment has been tested by Shenzhen Tongce Testing Lab. and found compliance with the requirements set forth in the technical standards mentioned above. The results of testing in this report apply only to the product/system, which was tested. Other similar equipment will not necessarily produce the same results due to production tolerance and measurement uncertainties.

Tested By: Jin Wang **Date:** Jul. 01, 2019

Jin Wang

Reviewed By: Beryl Zhao **Date:** Jul. 02, 2019

Beryl Zhao

Approved By: Tomsin **Date:** Jul. 02, 2019

Tomsin

2. Test Result Summary

Requirement	CFR 47 Section	Result
Conducted Output Power	§22.913; §2.1046 §24.232; §27.50(d)	PASS
Peak-to-Average Ratio	§2.1046; §22.913; §24.232(d); §27.50(d)	PASS
Effective Radiated Power	§2.1046; §22.913(a) §24.232; §27.50(d)	PASS
Equivalent Isotropic Radiated Power	§2.1046; §22.913(a) §24.232; §27.50(d)	PASS
Occupied Bandwidth	§2.1049	PASS
Band Edge	§2.1051 §22.917(a) §24.238(a) §27.53(g)	PASS
Conducted Spurious Emission	§2.1051; §22.917 §24.238; §27.53(h)	PASS
Field Strength of Spurious Radiation	§2.1053; §22.917(a) §24.238; §27.53(g)	PASS
Frequency Stability for Temperature & Voltage	§2.1055; §22.355 §24.235; §27.54	PASS

Note:

1. PASS: Test item meets the requirement.
2. Fail: Test item does not meet the requirement.
3. N/A: Test case does not apply to the test object.
4. The test result judgment is decided by the limit of test standard.

3. EUT Description

Product:	Mobile phone
Model No.:	SSB5118R
Additional Model No.:	AMS5118R, LM5118R
Trade Mark:	MAZE SPEED, SOHO STYLE, LUSH MINT
3G Version:	WCDMA: R99 HSDPA: Release 5 HSUPA: Release 6
Tx Frequency:	GSM/GPRS850: 824.2MHz ~ 848.8MHz GSM/GPRS1900: 1850.2MHz ~ 1909.8MHz WCDMA Band V: 826.4MHz ~ 846.6MHz WCDMA Band IV: 1712.4 MHz ~ 1752.6 MHz WCDMA Band II: 1852.4MHz ~ 1907.6MHz
Rx Frequency:	GSM/GPRS850: 869.2MHz ~ 893.8MHz GSM/GPRS1900: 1930.2MHz ~ 1989.8MHz WCDMA Band V: 871.4MHz ~ 891.6MHz WCDMA Band IV: 2112.4 MHz ~ 2152.6 MHz WCDMA Band II: 1932.4MHz ~ 1987.6MHz
Maximum Output Power to Antenna:	GSM850: 32.9dBm GSM1900: 30.0dBm GPRS850: 32.84dBm GPRS1900: 29.81dBm WCDMA Band V: 23.31dBm WCDMA Band IV: 23.91dBm WCDMA Band II: 23.85dBm
99% Occupied Bandwidth:	GSM850: 245KGXW GSM1900: 247KGXW GPRS850 Class 8:246KGXW GPRS1900 Class 8: 248KGXW WCDMA Band V RMC 12.2Kbps: 4M16F9W WCDMA Band IV RMC 12.2Kbps: 4M18F9W WCDMA Band II RMC 12.2Kbps: 4M16F9W
Type of Modulation:	GSM/GPRS: GMSK WCDMA/HSDPA/HSUPA: QPSK
Antenna Type:	Internal Antenna
Antenna Gain:	GSM/GPRS850: -0.8dBi GSM/GPRS1900: 0.5dBi WCDMA Band V: -0.8dBi WCDMA Band IV: 0.5dBi WCDMA Band II: 0.5dBi
Power Supply:	Rechargeable Li-ion Battery DC 3.7V

AC adapter:	Adapter Information1: MODEL: SSB-LW-001 INPUT: AC 100-240V, 50/60Hz OUTPUT: DC 5.0V, 1000mA Adapter Information2: MODEL: SSB-LW-002 INPUT: AC 100-240V, 50/60Hz OUTPUT: DC 5.0V, 1000mA Adapter Information3: MODEL: SSB-LW-003 INPUT: AC 100-240V, 50/60Hz OUTPUT: DC 5.0V, 1000mA
Remark:	All models above are identical in interior structure, electrical circuits and components, just colors and trade mark are different for the marketing requirement.

4. General Information

4.1. Test environment and mode

Operating Environment:	
Temperature:	25.0 °C
Humidity:	56 % RH
Atmospheric Pressure:	1010 mbar
Test Mode:	
Operation mode:	Keep the EUT in communication with CMU200 and select channel with modulation
Remark: This product has a built-in rechargeable battery, so in an independent test, the EUT battery was fully-charged. SIM1 supports GSM, WCDMA function, SIM2 only supports GSM function.	
The sample was placed (0.8m below 1GHz, 1.5m above 1GHz) above the ground plane of 3m chamber. Measurements in both horizontal and vertical polarities were performed. During the test, each emission was maximized by: having the EUT continuously working, investigated all operating modes, rotated about all 3 axis (X, Y & Z) and considered typical configuration to obtain worst position, manipulating interconnecting cables, rotating the turntable, varying antenna height from 1m to 4m in both horizontal and vertical polarizations. The emissions worst-case (Z axis) are shown in Test Results of the following pages.	

Description Operation Frequency

GSM 850		PCS1900	
Channel:	Frequency (MHz)	Channel:	Frequency (MHz)
128	824.20	512	1850.20
129	824.40	513	1850.40
....
189	836.40	660	1879.80
190	836.60	661	1880.00
191	836.80	662	1880.20
...
250	848.60	809	1909.60
251	848.80	810	1909.80

WCDMA Band IV		WCDMA Band V		WCDMA Band II	
Channel:	Frequency (MHz)	Channel:	Frequency (MHz)	Channel:	Frequency (MHz)
1312	1712.4	4132	826.40	9262	1852.40
....	4133	826.60	9263	1852.60
....
....	4182	836.40	9399	1879.80
1413	1732.6	4183	836.60	9400	1880.00
....	4184	836.80	9401	1880.20
....
1513	1752.6	4233	846.60	9538	1907.60

4.2. Test Mode

Antenna port conducted and radiated test items were performed according to KDB 971168 D01 Power Meas. License Digital Systems v03r01 with maximum output power. Radiated measurements were performed with rotating EUT in different three orthogonal test planes to find the maximum emission.

Radiated emissions were investigated as following frequency range:

1. 30 MHz to 10000 MHz for GSM850 and WCDMA Band V.
2. 30 MHz to 20000 MHz for PCS1900, WCDMA Band II and WCDMA Band IV.

All modes and data rates and positions were investigated.

Test modes are chosen to be reported as the worst case configuration below:

Test Mode		
Band	Radiated TCs	Conducted TCs
GSM 850	GSM Link GPRS class 12 Link	GSM Link GPRS class 12 Link
PCS 1900	GSM Link GPRS class 12 Link	GSM Link GPRS class 12 Link
WCDMA Band V	RMC 12.2Kbps Link	RMC 12.2Kbps Link
WCDMA Band IV	RMC 12.2Kbps Link	RMC 12.2Kbps Link
WCDM Band II	RMC 12.2Kbps Link	RMC 12.2Kbps Link

Note: The maximum power levels are chosen to test as the worst case configuration as follows:
GPRS multi-slot class 12 mode for GMSK modulation. RMC 12.2Kbps mode for WCDMA band V, WCDMA band IV and WCDMA band II, only these modes were used for all tests. In addition to above worst-case test, below investigating on all data rates and all modes are compliance with each FCC test case which has specific test limits. For spurious emissions at antenna port, the EUT was investigated the band edges on low and high channels, and the unwanted spurious emissions on middle channel for all modes, the results are PASS, then only the worst-results were reported in the test report. The Radiated Spurious emissions for GPRS modes were investigated on the middle channel and the PASS results were not worst than those data tested from the highest power channels.

4.3. Description of Support Units

The EUT has been tested as an independent unit together with other necessary accessories or support units. The following support units or accessories were used to form a representative test configuration during the tests.

Equipment	Model No.	Serial No.	FCC ID	Trade Name
/	/	/	/	/

Note:

1. All the equipment/cables were placed in the worst-case configuration to maximize the emission during the test.
2. Grounding was established in accordance with the manufacturer's requirements and conditions for the intended use.

4.4. Configuration of Tested System

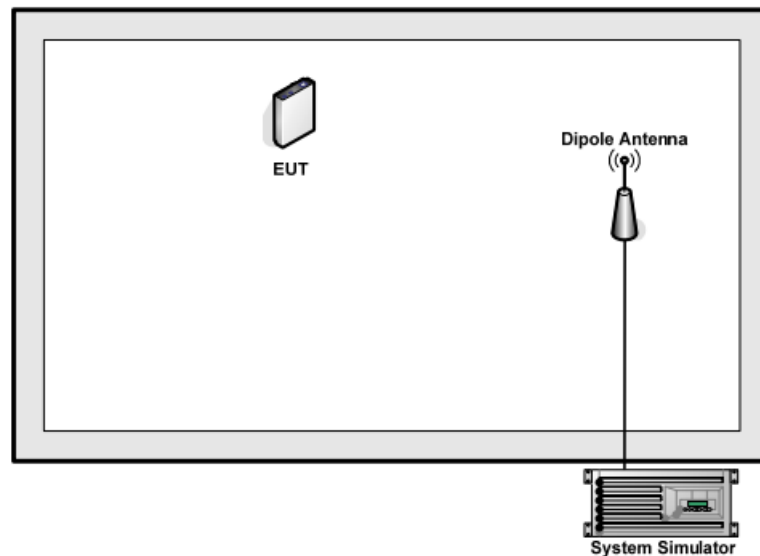

4.5. Measurement Results Explanation Example

For all conducted test items:

The offset level is set in the spectrum analyzer to compensate the RF cable loss and attenuator factor between RF conducted output port and spectrum analyzer. With the offset compensation, the spectrum analyzer reading level will be exactly the RF output level. The spectrum analyzer offset is derived from RF cable loss and attenuator factor.

Offset = RF cable loss + attenuator factor.

The following shows an offset computation example with RF cable loss 3 dB and a 5dB attenuator.

Example: $Offset (dB) = RF\ cable\ loss (dB) + attenuator\ factor (dB)$
 $= 8(dB)$

5. Facilities and Accreditations

5.1. Facilities

The test facility is recognized, certified, or accredited by the following organizations:

- FCC - Registration No.: 645098

Shenzhen Tongce Testing Lab

The 3m Semi-anechoic chamber has been registered and fully described in a report with the (FCC) Federal Communications Commission. The acceptance letter from the FCC is maintained in our files.

- IC - Registration No.: 10668A-1

The 3m Semi-anechoic chamber of Shenzhen TCT Testing Technology Co., Ltd. has been registered by Certification and Engineering Bureau of Industry Canada for radio equipment testing

5.2. Location

Shenzhen Tongce Testing Lab

Address: 1B/F., Building 1, Yibaolai Industrial Park, Qiaotou, Fuyong, Baoan District, Shenzhen, Guangdong, China

TEL: +86-755-27673339

5.3. Measurement Uncertainty

The reported uncertainty of measurement $y \pm U$, where expanded uncertainty U is based on a standard uncertainty multiplied by a coverage factor of $k=2$, providing a level of confidence of approximately 95 %.

No.	Item	MU
1	Conducted Emission	$\pm 2.56\text{dB}$
2	RF power, conducted	$\pm 0.12\text{dB}$
3	Spurious emissions, conducted	$\pm 0.11\text{dB}$
4	All emissions, radiated(<1G)	$\pm 3.92\text{dB}$
5	All emissions, radiated(>1G)	$\pm 4.28\text{dB}$
6	Temperature	$\pm 0.1^\circ\text{C}$
7	Humidity	$\pm 1.0\%$

6. Test Results and Measurement Data

6.1. Conducted Output Power Measurement

6.1.1. Test Specification

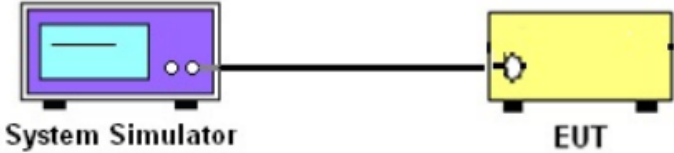
Test Requirement:	FCC part 22.913(a) and FCC part 24.232(b) FCC part 27.50(d);
Test Method:	FCC KDB 971168 D01 v03r01
Operation mode:	Refer to item 4.1
Limits:	GSM 850: 7W PCS 1900: 2W WCDMA Band V:7W WCDMA Band II: 2W WCDMA Band IV:1W
Test Setup:	 <p>The diagram illustrates the test setup. On the left is a purple box labeled 'System Simulator' with a screen and two buttons. A black line representing a cable connects it to a yellow box on the right labeled 'EUT' (Equipment Under Test).</p>
Test Procedure:	<ol style="list-style-type: none"> 1. The transmitter output port was connected to the system simulator. 2. Set EUT at maximum power through system simulator. 3. Select lowest, middle, and highest channels for each band and different modulation. 4. Measure the maximum burst average power for GSM and maximum average power for other modulation signal.
Test Result:	PASS

6.1.2. Test Instruments

Equipment	Manufacturer	Model	Serial Number	Calibration Due
System simulator	R&S	CMU200	111382	Sep. 20, 2019
RF cable (9kHz-40GHz)	TCT	RE-05	N/A	Sep. 20, 2019
Antenna Connector	TCT	RFC-02	N/A	Sep. 20, 2019

Note: The calibration interval of the above test instruments is 12 months and the calibrations are traceable to international system unit (SI).

6.1.3. Test data

Conducted Power Measurement Results:

Average Conducted Power (*Unit: dBm)						
Band	GSM850			PCS 1900		
Channel	128	190	251	512	661	810
Frequency(MHz)	824.2	836.6	848.8	1850.2	1880.0	1909.8
GSM	32.8	32.9	32.9	30.0	29.8	29.7
GPRS class8	32.75	32.83	32.84	29.81	29.71	29.63
GPRS class10	32.02	32.11	32.10	29.72	29.55	29.50
GPRS class11	29.90	29.97	29.88	28.02	28.01	28.05
GPRS class12	28.68	28.70	28.51	26.80	26.92	27.08
Average Conducted Power (*Unit: dBm)						
Band	WCDMA Band V			WCDMA Band II		
Channel	4132	4183	4233	9262	9400	9538
Frequency(MHz)	826.4	836.6	846.6	1852.4	1880.0	1907.6
WCDMA RMC 12.2K	23.04	23.31	23.22	23.85	23.38	23.63
HSDPA Subtest-1	22.13	22.48	22.33	22.91	22.56	22.75
HSDPA Subtest-2	21.80	21.95	21.87	22.35	22.01	22.27
HSDPA Subtest-3	21.31	21.54	21.42	21.85	21.46	21.50
HSDPA Subtest-4	20.83	20.98	20.90	21.61	21.04	21.23
HSUPA Subtest-1	22.10	22.24	22.18	22.63	22.44	22.58
HSUPA Subtest-2	21.61	21.78	21.84	22.14	22.08	22.15
HSUPA Subtest-3	21.48	21.55	21.45	21.63	21.51	21.72
HSUPA Subtest-4	21.03	21.17	21.14	21.16	21.03	21.20
HSUPA Subtest-5	20.78	20.84	20.85	20.92	20.71	20.84

Conducted Power (*Unit: dBm)			
Band	WCDMA Band IV		
Channel	1312	1413	1513
Frequency(MHz)	1712.4	1732.6	1752.6
RMC 12.2K	23.91	23.18	23.78
HSDPA Subtest-1	23.05	22.31	22.82
HSDPA Subtest-2	22.68	22.03	22.43
HSDPA Subtest-3	22.10	21.35	21.84
HSDPA Subtest-4	21.76	21.03	21.28
HSUPA Subtest-1	22.91	22.35	22.76
HSUPA Subtest-2	22.22	22.08	22.13
HSUPA Subtest-3	21.84	21.51	21.62
HSUPA Subtest-4	21.41	21.04	21.21
HSUPA Subtest-5	21.17	20.82	21.07

6.2. Peak to Average Ratio

6.2.1. Test Specification

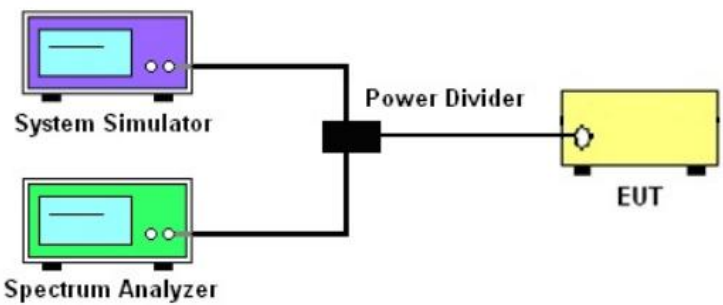
Test Requirement:	FCC part 24.232(d) ; FCC part 22.913; FCC part 27.50(d);
Test Method:	FCC KDB 971168 D01v03r01
Operation mode:	Refer to item 4.1
Limit:	The peak-to-average ratio (PAR) of the transmission may not exceed 13 dB.
Test Setup:	 <p>The diagram illustrates the test setup. A System Simulator (purple box) and a Spectrum Analyzer (green box) are connected to a Power Divider (black box). The Power Divider is then connected to the EUT (Equipment Under Test, yellow box).</p>
Test Procedure:	<ol style="list-style-type: none"> 1. The testing follows FCC KDB 971168 D01v03r01 Section 5.7.1. 2. The EUT was connected to spectrum analyzer and system simulator via a power divider. 3. Set EUT to transmit at maximum output power. 4. For GSM/EGPRS operating modes, signal gating is implemented on the spectrum analyzer by triggering from the system simulator. 5. Set the CCDF (Complementary Cumulative Distribution Function) option of the spectrum analyzer. Record the maximum PAPR level associated with a probability of 0.1%.
Test Result:	PASS

6.2.2. Test Instruments

Equipment	Manufacturer	Model	Serial Number	Calibration Due
System simulator	R&S	CMU200	111382	Sep. 20, 2019
Spectrum Analyzer	R&S	FSU	200054	Sep. 20, 2019
RF cable (9kHz-40GHz)	TCT	RE-05	N/A	Sep. 20, 2019
Antenna Connector	TCT	RFC-02	N/A	Sep. 20, 2019

Note: The calibration interval of the above test instruments is 12 months and the calibrations are traceable to international system unit (SI).

6.2.3. Test Data

Cellular Band			
Mode	GSM 850		
Channel	128	189	251
Frequency (MHz)	824.2	836.6	848.8
Peak-to-Average Ratio (dB)	7.69	7.69	7.69

PCS Band			
Mode	GSM 1900		
Channel	512	661	810
Frequency (MHz)	1850.2	1880	1909.8
Peak-to-Average Ratio (dB)	7.63	7.60	7.60

Cellular Band			
Mode	GPRS 850		
Channel	128	189	251
Frequency (MHz)	824.2	836.6	848.8
Peak-to-Average Ratio (dB)	7.66	7.69	7.66

PCS Band			
Mode	GPRS 1900		
Channel	512	661	810
Frequency (MHz)	1850.2	1880	1909.8
Peak-to-Average Ratio (dB)	7.63	7.63	7.63

Cellular Band									
Mode	WCDMA Band V (RMC 12.2Kbps)			WCDMA Band IV (RMC 12.2Kbps)			WCDMA Band II (RMC 12.2Kbps)		
Channel	4132	4183	4233	1312	1413	1513	9262	9400	9538
Frequency (MHz)	826.4	836.6	846.6	1712.4	1732.6	1752.6	1852.4	1880	1907.6
Peak-to-Average Ratio (dB)	2.82	2.95	2.79	1.41	1.28	0.93	2.76	2.88	2.76

Test plots as follows:

GSM 850

Peak-to-Average Ratio on Channel 128

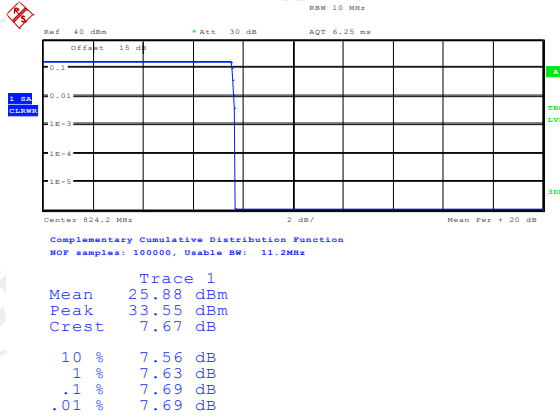

Date: 19 JUN 2019 17:00:22

Peak-to-Average Ratio on Channel 190

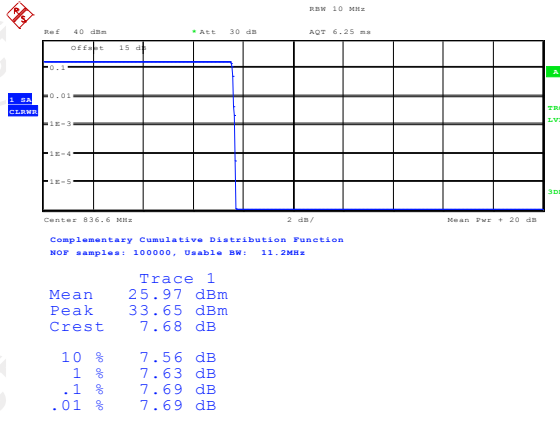

Date: 19 JUN 2019 17:00:38

Peak-to-Average Ratio on Channel 251

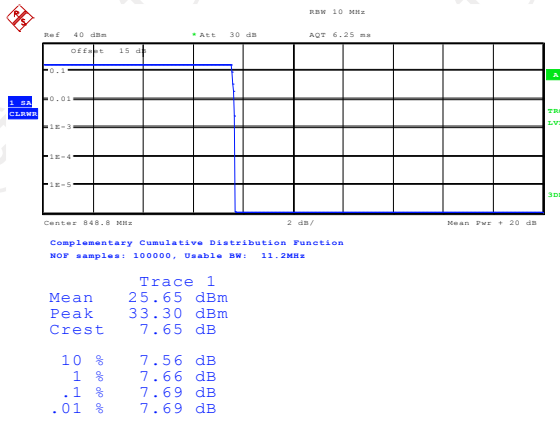

Date: 19 JUN 2019 17:01:05

Peak-to-Average Ratio on Channel 512

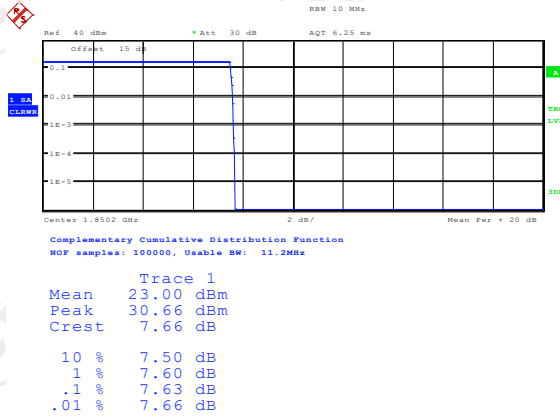

Date: 19.JUN.2019, 17:05:35

Peak-to-Average Ratio on Channel 661

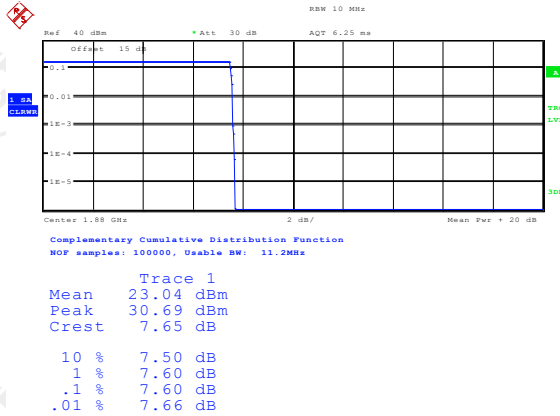

Date: 19.JUN.2019 17:05:53

Peak-to-Average Ratio on Channel 810

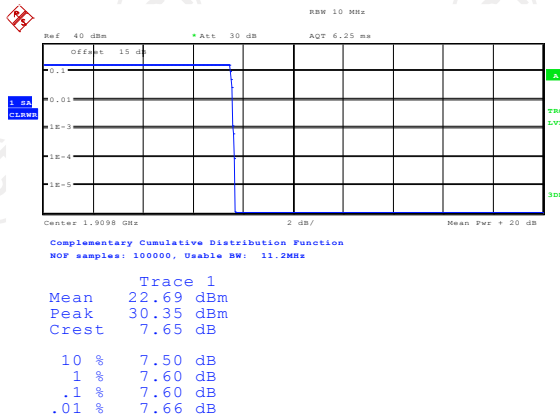

Date: 19.JUN.2019 17:06:14

GPRS 850

Peak-to-Average Ratio on Channel 128

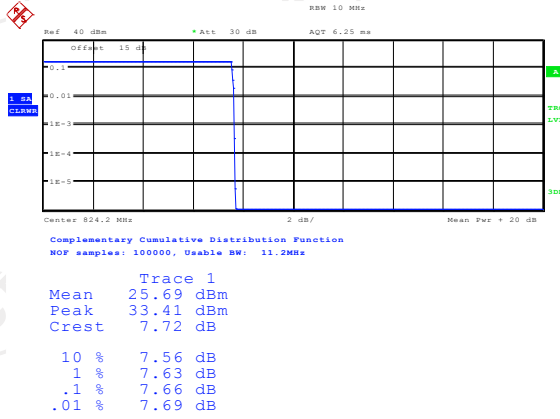

Peak-to-Average Ratio on Channel 190

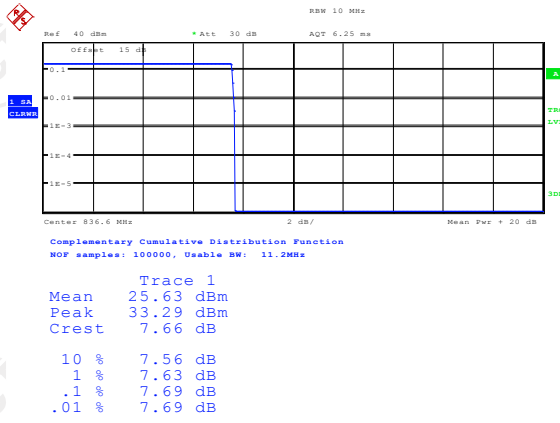

Peak-to-Average Ratio on Channel 251

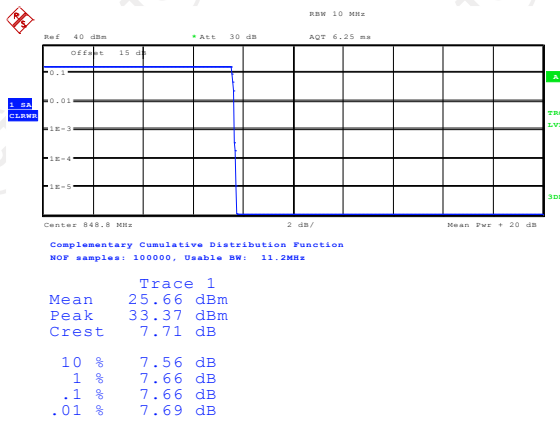

Peak-to-Average Ratio on Channel 512

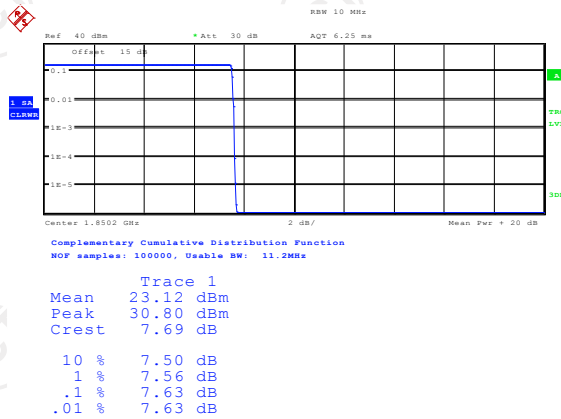

Date: 19.JUN.2019, 17:07:42

Peak-to-Average Ratio on Channel 661

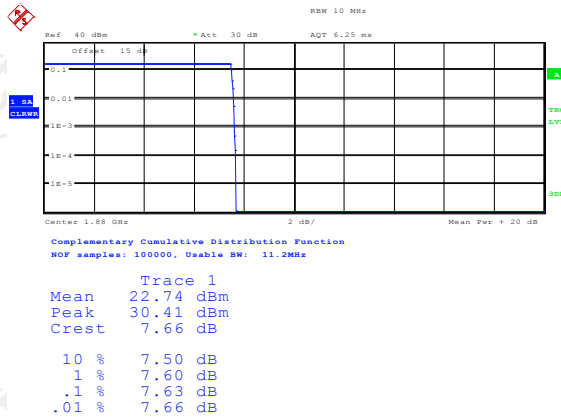

Date: 19.JUN.2019 17:08:04

Peak-to-Average Ratio on Channel 810

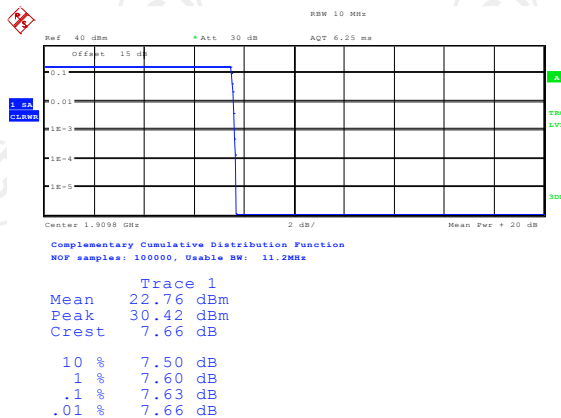

Date: 19.JUN.2019 17:08:18

Peak-to-Average Ratio on Channel 4132

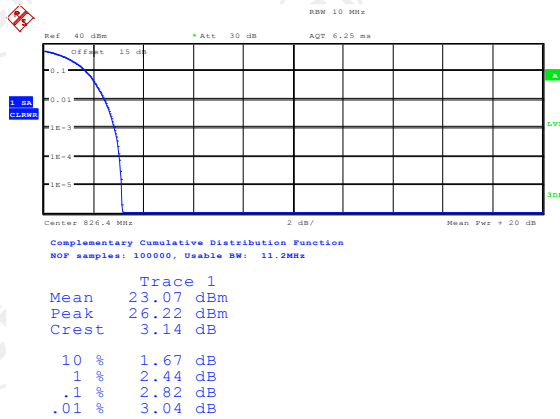

Date: 19.JUN.2019, 17:11:14

Peak-to-Average Ratio on Channel 4183

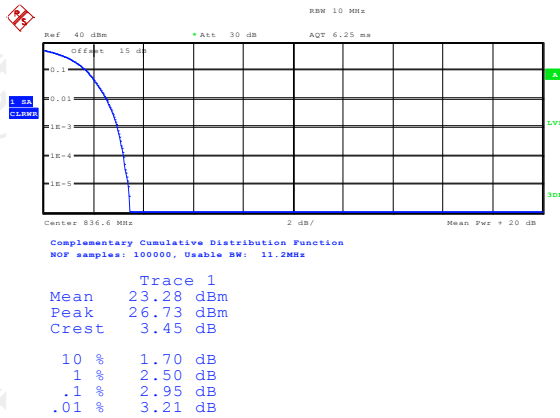

Date: 19.JUN.2019 17:11:29

Peak-to-Average Ratio on Channel 4233

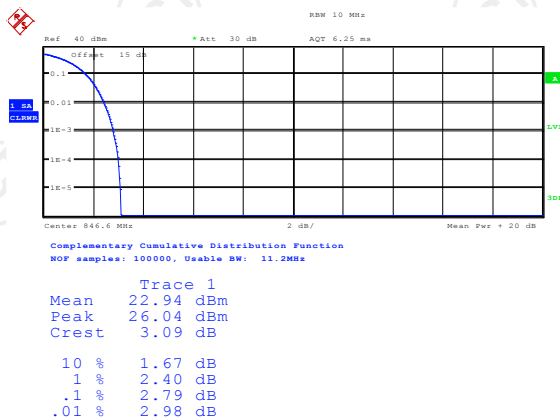

Date: 19.JUN.2019 17:11:43

Peak-to-Average Ratio on Channel 1312

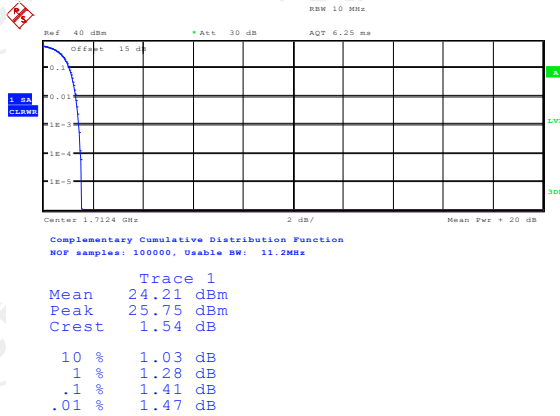

Date: 19.JUN.2019, 17:13:29

Peak-to-Average Ratio on Channel 1413

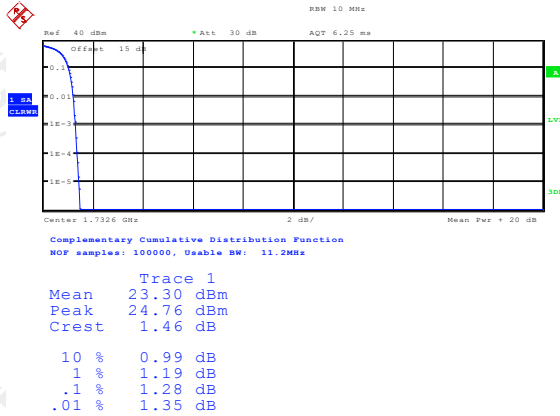

Date: 19.JUN.2019 17:13:55

Peak-to-Average Ratio on Channel 1513

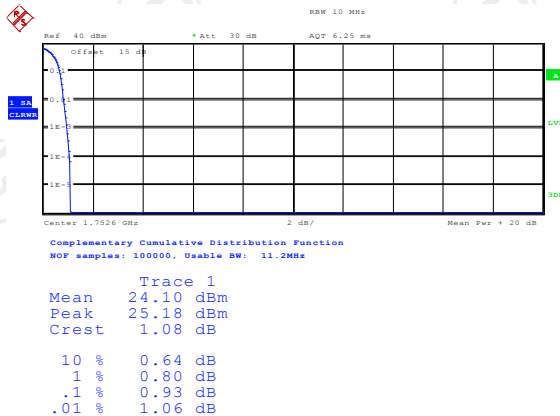

Date: 19.JUN.2019 17:14:09

Peak-to-Average Ratio on Channel 9262

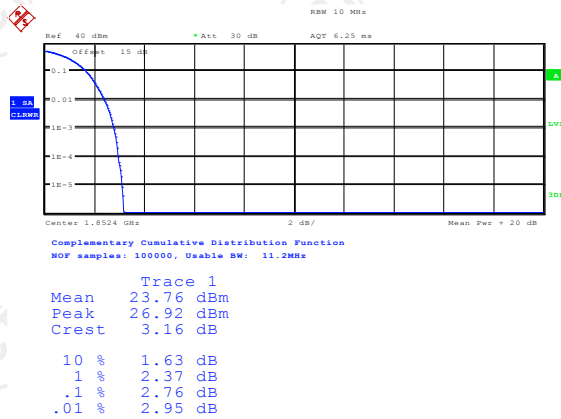

Date: 19.JUN.2019, 17:12:07

Peak-to-Average Ratio on Channel 9400

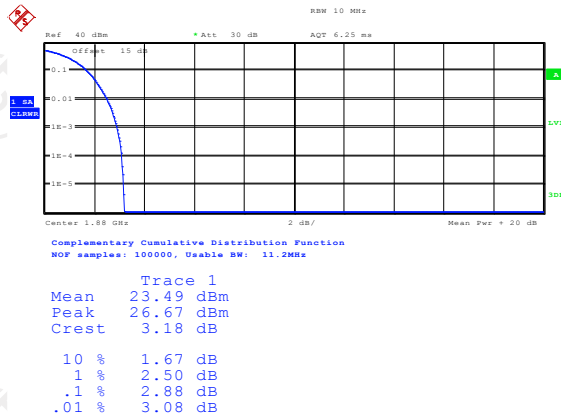

Date: 19.JUN.2019 17:12:21

Peak-to-Average Ratio on Channel 9538

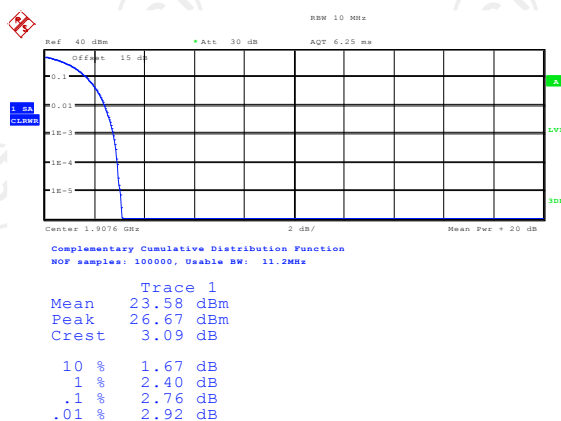

Date: 19.JUN.2019 17:12:37

6.3. 99% Occupied Bandwidth and 26dB Bandwidth Measurement

6.3.1. Test Specification

Test Requirement:	FCC part 2.1049
Test Method:	FCC KDB 971168 D01v03r01
Operation mode:	Refer to item 4.1
Limit:	N/A
Test Setup:	
Test Procedure:	<ol style="list-style-type: none"> 1. The testing follows FCC KDB 971168 D01v03r01 Section 4.2. 2. The EUT was connected to the spectrum analyzer and system simulator via a power divider. 3. The RF output of the EUT was connected to the spectrum analyzer by RF cable and attenuator. The path loss was compensated to the results for each measurement. 4. The 99% occupied bandwidth were measured, set RBW= 1% of span, VBW= 3*RBW, sample detector, trace maximum hold. 5. The 26dB bandwidth were measured, set RBW= 1% of EBW, VBW= 3*RBW, peak detector, trace maximum hold.
Test Result:	PASS

6.3.2. Test Instruments

Equipment	Manufacturer	Model	Serial Number	Calibration Due
System simulator	R&S	CMU200	111382	Sep. 20, 2019
Spectrum Analyzer	R&S	FSU	200054	Sep. 20, 2019
RF cable (9kHz-40GHz)	TCT	RE-05	N/A	Sep. 20, 2019
Antenna Connector	TCT	RFC-02	N/A	Sep. 20, 2019

Note: The calibration interval of the above test instruments is 12 months and the calibrations are traceable to international system unit (SI).

6.3.3. Test data

Cellular Band			
Mode	GSM 850		
Channel	128	190	251
Frequency (MHz)	824.2	836.6	848.8
99% OBW (kHz)	245.00	243.00	245.00
26dB BW (kHz)	315.71	317.31	320.51

Cellular Band			
Mode	GSM1900		
Channel	512	661	810
Frequency (MHz)	1850.2	1880.0	1909.8
99% OBW (kHz)	244.00	247.00	245.00
26dB BW (kHz)	322.12	310.90	318.91

Cellular Band			
Mode	GPRS 850		
Channel	128	190	251
Frequency (MHz)	824.2	836.6	848.8
99% OBW (kHz)	245.00	246.00	243.00
26dB BW (kHz)	323.99	320.51	323.72

Cellular Band			
Mode	GPRS 1900		
Channel	512	661	810
Frequency (MHz)	1850.2	1880.0	1909.8
99% OBW (kHz)	246.00	248.00	246.00
26dB BW (kHz)	323.72	322.12	320.51

Cellular Band			
Mode	WCDMA Band V (RMC 12.2Kbps)		
Channel	4132	4183	4233
Frequency (MHz)	826.4	836.6	846.6
99% OBW (MHz)	4.16	4.16	4.16
26dB BW (MHz)	4.70	4.70	4.71

Cellular Band			
Mode	WCDMA Band IV (RMC 12.2Kbps)		
Channel	1312	1413	1513
Frequency (MHz)	1712.4	1732.6	1752.6
99% OBW (MHz)	4.18	4.18	4.18
26dB BW (MHz)	4.71	4.74	4.71

Cellular Band			
Mode	WCDMA Band II (RMC 12.2Kbps)		
Channel	9262	9400	9538
Frequency (MHz)	1852.4	1880	1907.6
99% OBW (MHz)	4.16	4.15	4.15
26dB BW (MHz)	4.70	4.71	4.70

Test plots as follows:

Band:	GSM 850	Test Mode:	GSM Link (GMSK)
-------	---------	------------	-----------------

26dB&99% Occupied Bandwidth Plot on Channel 128

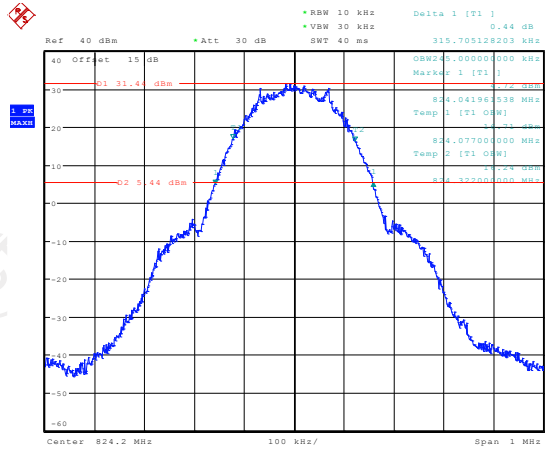

Date: 19.JUN.2019 17:31:11

26dB&99% Occupied Bandwidth Plot on Channel 190

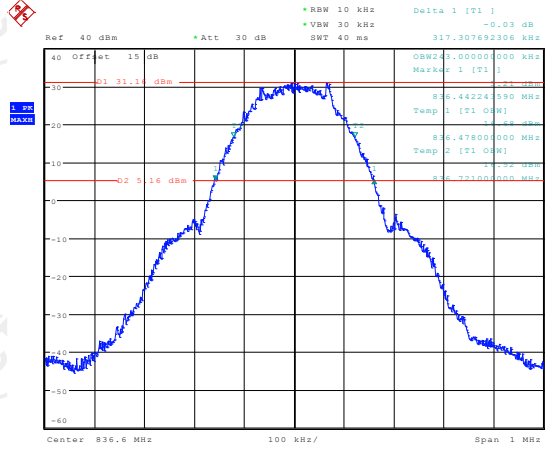

Date: 19.JUN.2019 17:32:41

26dB&99% Occupied Bandwidth Plot on Channel 251

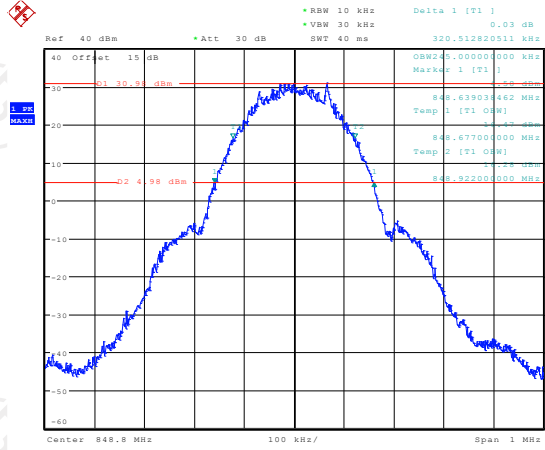

Date: 19.JUN.2019 17:33:55

Band:	GSM 1900	Test Mode:	GSM Link (GMSK)
-------	----------	------------	-----------------

26dB&99% Occupied Bandwidth Plot on Channel 512

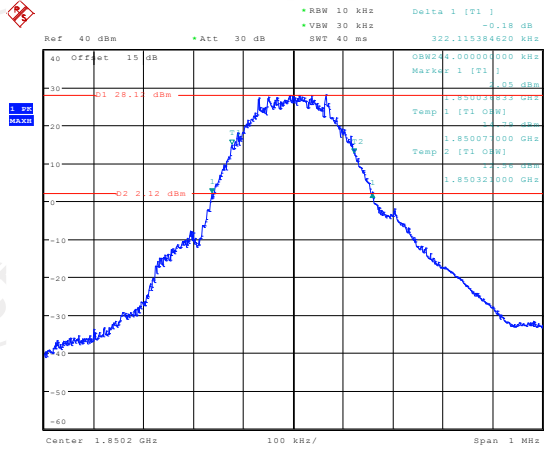

Date: 19.JUN.2019 17:40:43

26dB&99% Occupied Bandwidth Plot on Channel 661

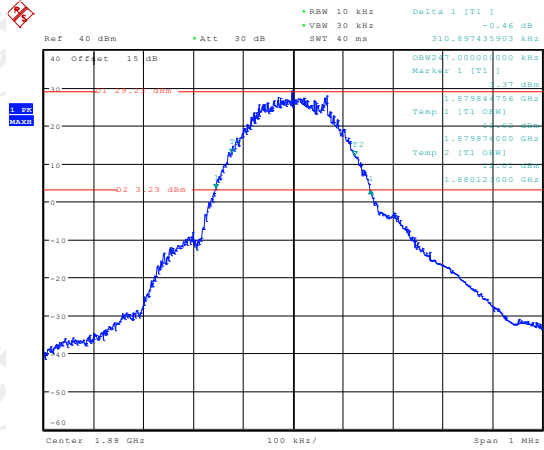

Date: 19.JUN.2019 17:41:44

26dB&99% Occupied Bandwidth Plot on Channel 810

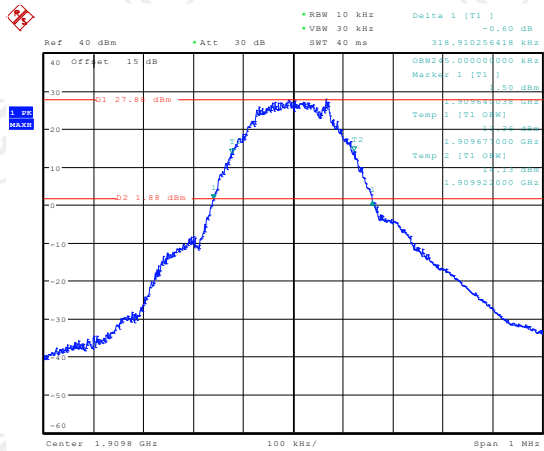

Date: 19.JUN.2019 17:43:12

Band:	GPRS 850	Test Mode:	GSM Link (GMSK)
--------------	-----------------	-------------------	------------------------

26dB&99% Occupied Bandwidth Plot on Channel 128

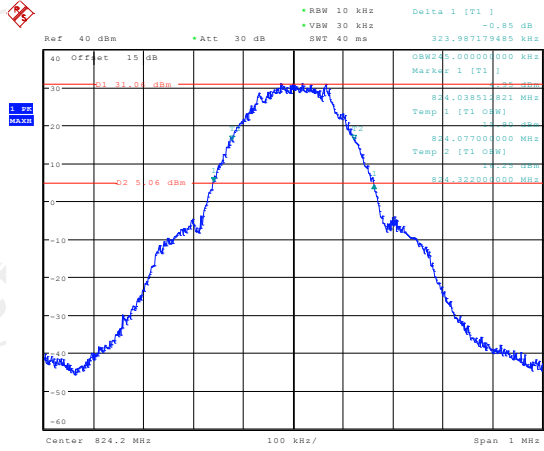

Date: 19.JUN.2019 17:36:05

26dB&99% Occupied Bandwidth Plot on Channel 190

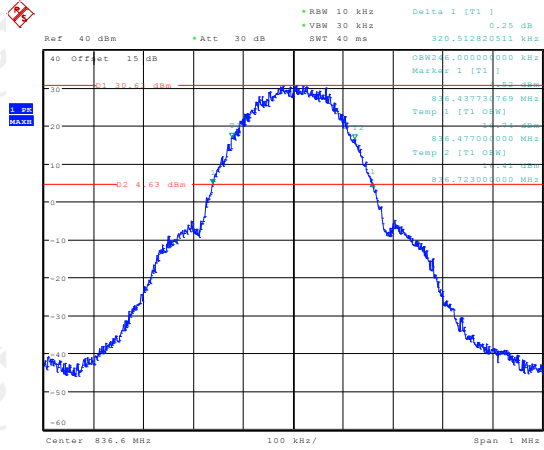

Date: 19.JUN.2019 17:37:07

26dB&99% Occupied Bandwidth Plot on Channel 251

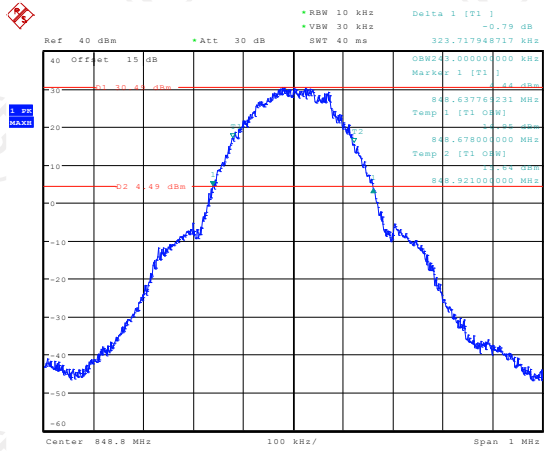

Date: 19.JUN.2019 17:38:09

Band:	GPRS 1900	Test Mode:	GSM Link (GMSK)
-------	-----------	------------	-----------------

26dB&99% Occupied Bandwidth Plot on Channel 512

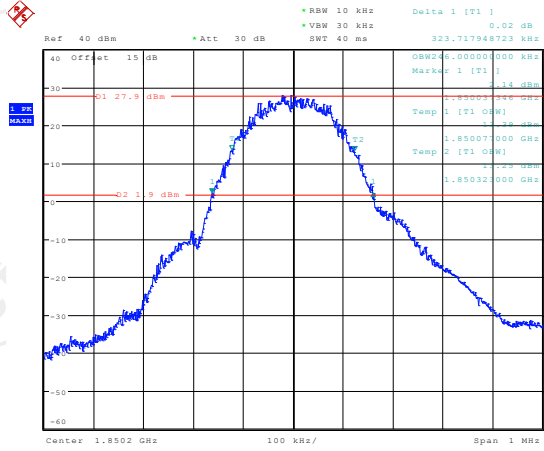

Date: 19.JUN.2019 17:45:22

26dB&99% Occupied Bandwidth Plot on Channel 661

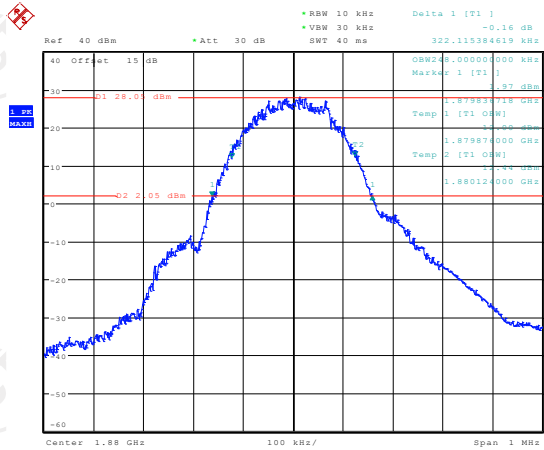

Date: 19.JUN.2019 17:46:14

26dB&99% Occupied Bandwidth Plot on Channel 810

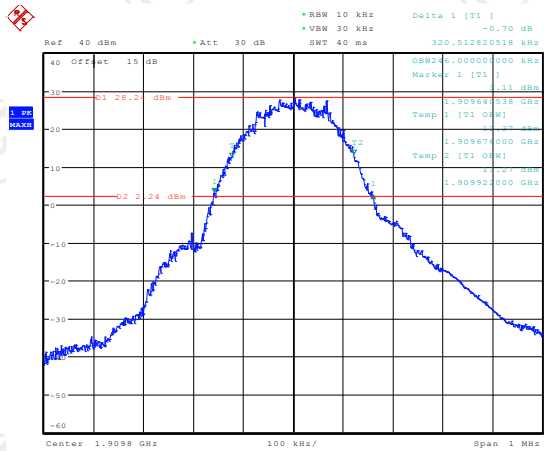

Date: 19.JUN.2019 17:47:09

Band:	WCDMA Band V	Test Mode:	RMC 12.2Kbps Link (QPSK)
-------	--------------	------------	--------------------------

26dB&99% Occupied Bandwidth Plot on Channel 4132

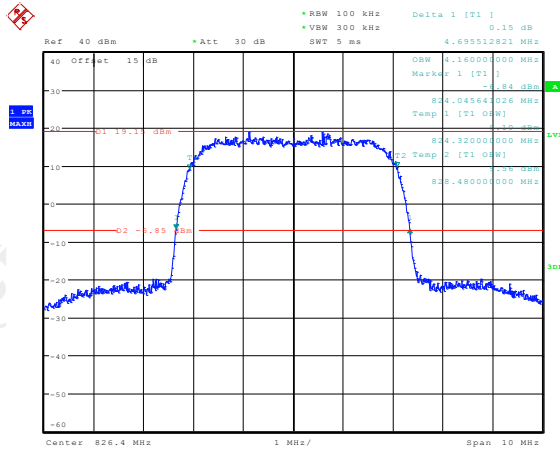

Date: 19.JUN.2019 17:17:40

26dB&99% Occupied Bandwidth Plot on Channel 4183

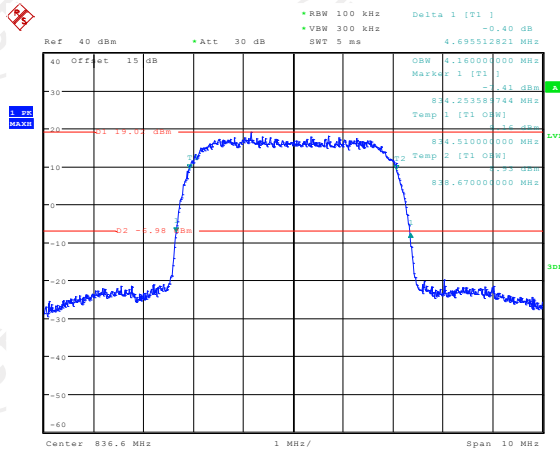

Date: 19.JUN.2019 17:19:18

26dB&99% Occupied Bandwidth Plot on Channel 4233

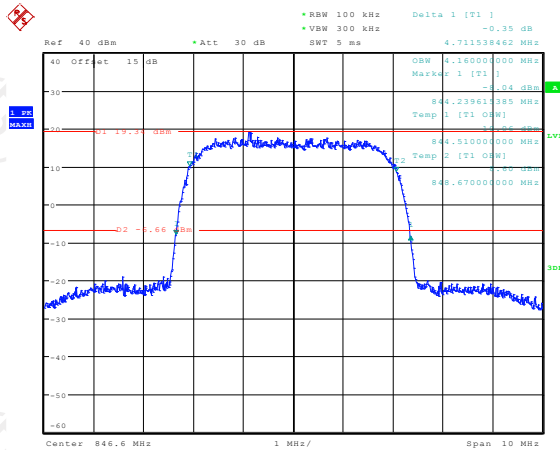

Date: 19.JUN.2019 17:20:29

Band:	WCDMA Band IV	Test Mode:	RMC 12.2Kbps Link (QPSK)
-------	---------------	------------	--------------------------

26dB&99% Occupied Bandwidth Plot on Channel 1312

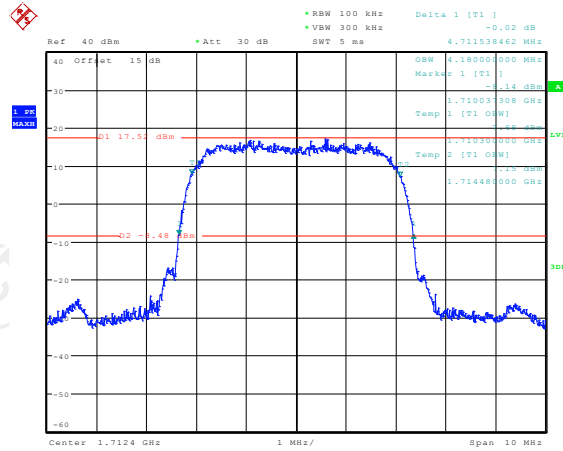

Date: 20 JUN 2019 16:48:24

26dB&99% Occupied Bandwidth Plot on Channel 1413

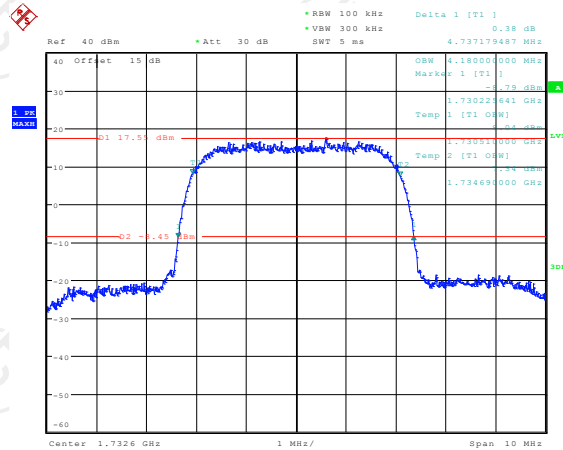

Date: 20 JUN 2019 16:49:23

26dB&99% Occupied Bandwidth Plot on Channel 1513

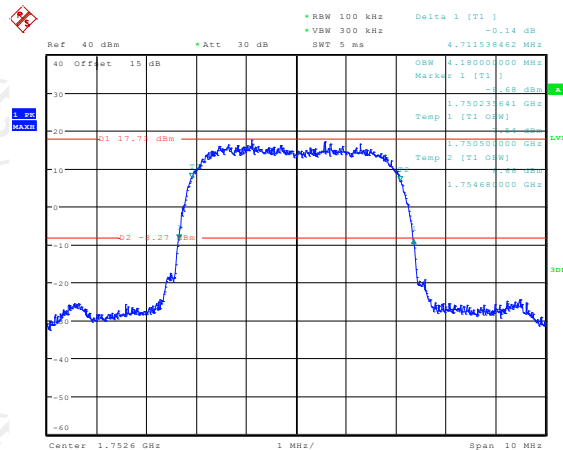

Date: 20 JUN 2019 16:50:39

Band:	WCDMA Band II	Test Mode:	RMC 12.2Kbps Link (QPSK)
-------	---------------	------------	--------------------------

26dB&99% Occupied Bandwidth Plot on Channel 9262

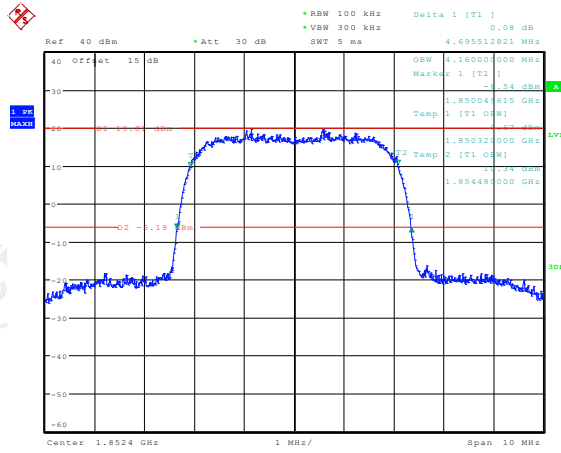

Date: 19.JUN.2019 17:21:51

26dB&99% Occupied Bandwidth Plot on Channel 9400

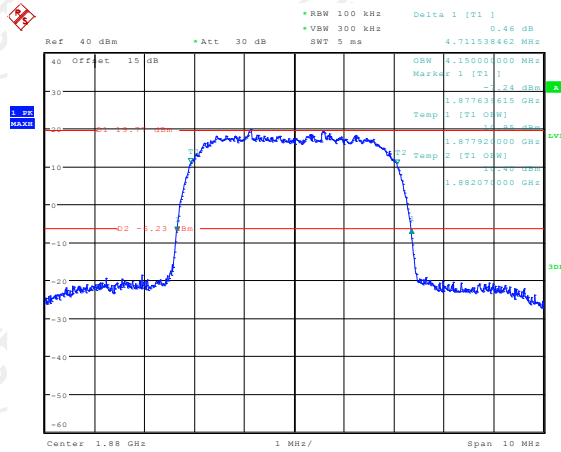

Date: 19.JUN.2019 17:23:26

26dB&99% Occupied Bandwidth Plot on Channel 9538

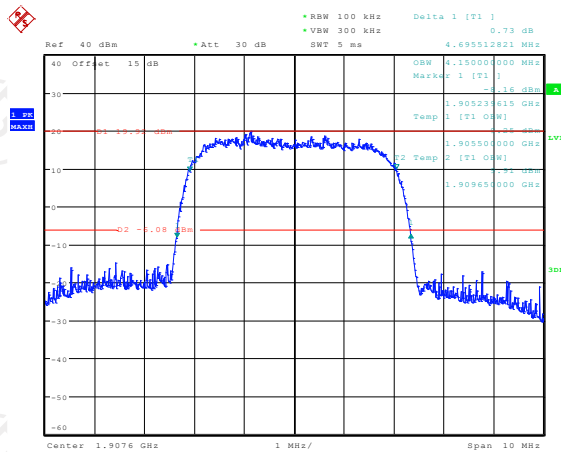

Date: 19.JUN.2019 17:25:11

6.4. Band Edge and Conducted Spurious Emission Measurement

6.4.1. Test Specification

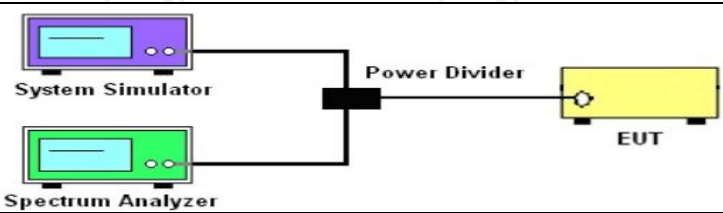
Test Requirement:	FCC part22.917(a), FCC part24.238(a), FCC part27.53(g)
Test Method:	FCC KDB 971168 D01v03r01
Operation mode:	Refer to item 4.1
Limit:	-13dBm
Test Setup:	
Test Procedure:	<ol style="list-style-type: none"> 1. The testing follows FCC KDB 971168 D01v03r01 Section 6.0. 2. The EUT was connected to the spectrum analyzer and system simulator via a power divider. 3. The RF output of EUT was connected to the spectrum analyzer by an RF cable and attenuator. The path loss was compensated to the results for each measurement. 4. The band edges of low and high channels for the highest RF powers were measured. 5. The conducted spurious emission for the whole frequency range was taken. 6. The RF fundamental frequency should be excluded against the limit line in the operating frequency band. 7. The limit line is derived from $43 + 10\log(P)$ dB below the transmitter power $P(\text{Watts}) = P(\text{W}) - [43 + 10\log(P)] (\text{dB}) = [30 + 10\log(P)] (\text{dBm}) - [43 + 10\log(P)] (\text{dB}) = -13\text{dBm}$.
Test Result:	PASS

6.4.2. Test Instruments

Equipment	Manufacturer	Model	Serial Number	Calibration Due
System simulator	R&S	CMU200	111382	Sep. 20, 2019
Spectrum Analyzer	R&S	FSU	200054	Sep. 20, 2019
RF cable (9kHz-40GHz)	TCT	RE-05	N/A	Sep. 20, 2019
Antenna Connector	TCT	RFC-02	N/A	Sep. 20, 2019

Note: The calibration interval of the above test instruments is 12 months and the calibrations are traceable to international system unit (SI).

6.4.3. Test data

Test plots as follows:

Band:	GSM 850	Test Mode:	GSM Link (GMSK)
-------	---------	------------	-----------------

Lower Band Edge Plot on Channel 128

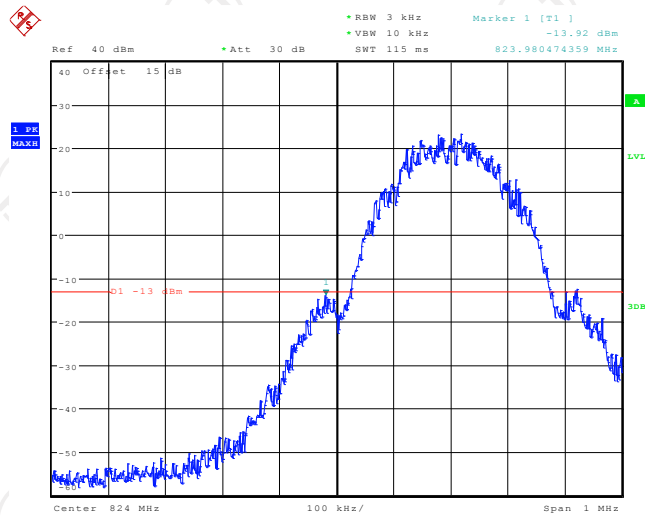

Date: 20.JUN.2019 17:08:46

Higher Band Edge Plot on Channel 251

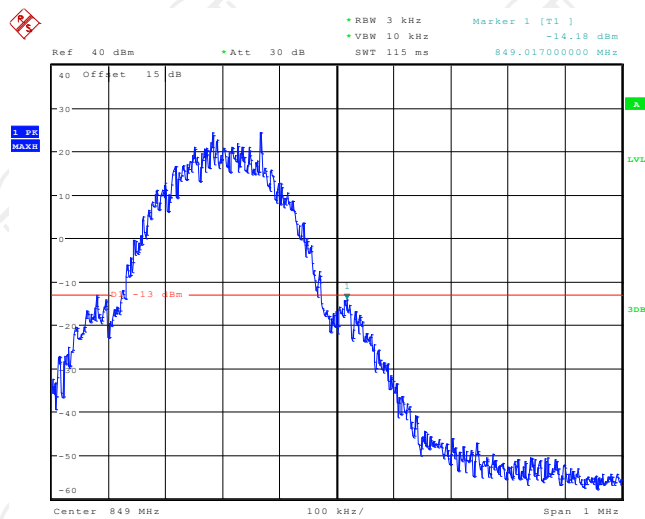

Date: 20.JUN.2019 17:11:36

Band:	GSM 1900	Test Mode:	GSM Link (GMSK)
-------	----------	------------	-----------------

Lower Band Edge Plot on Channel 512

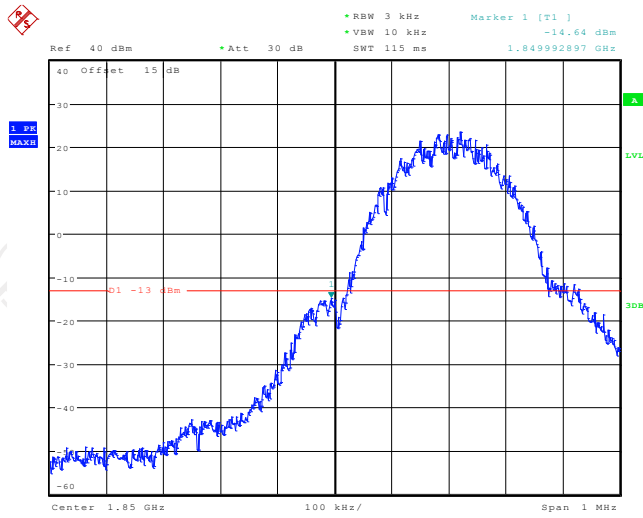

Date: 21 JUN 2019 10:30:53

Higher Band Edge Plot on Channel 810

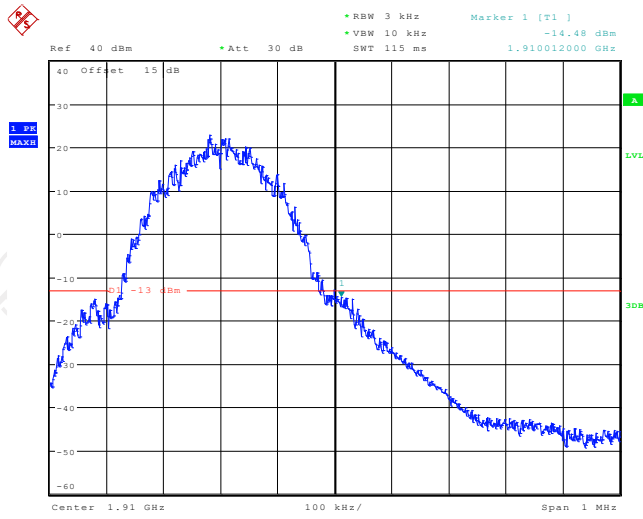

Date: 21 JUN 2019 10:32:19

Band:	GPRS 850	Test Mode:	GSM Link (GMSK)
-------	----------	------------	-----------------

Lower Band Edge Plot on Channel 128

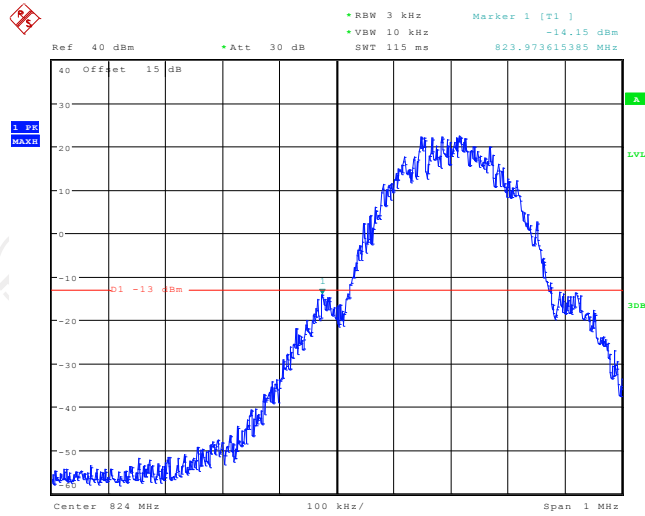

Date: 20 JUN 2019 17:12:11

Higher Band Edge Plot on Channel 251

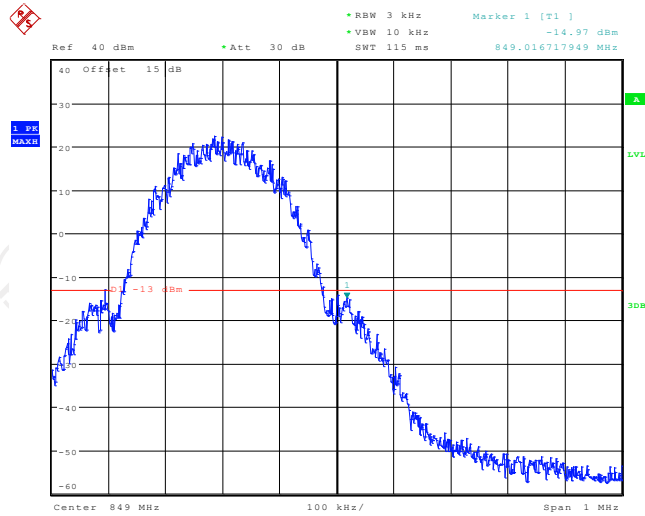

Date: 20 JUN 2019 17:12:56

Band:	GPRS1900	Test Mode:	GSM Link (GMSK)
-------	----------	------------	-----------------

Lower Band Edge Plot on Channel 512

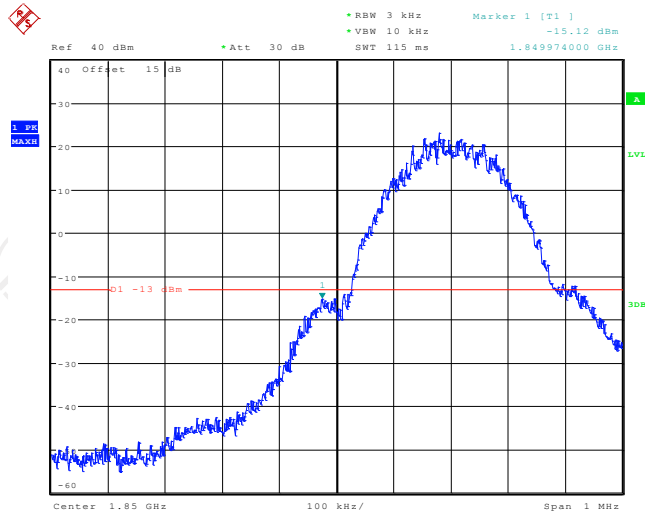

Date: 21 JUN 2019 10:34:01

Higher Band Edge Plot on Channel 810

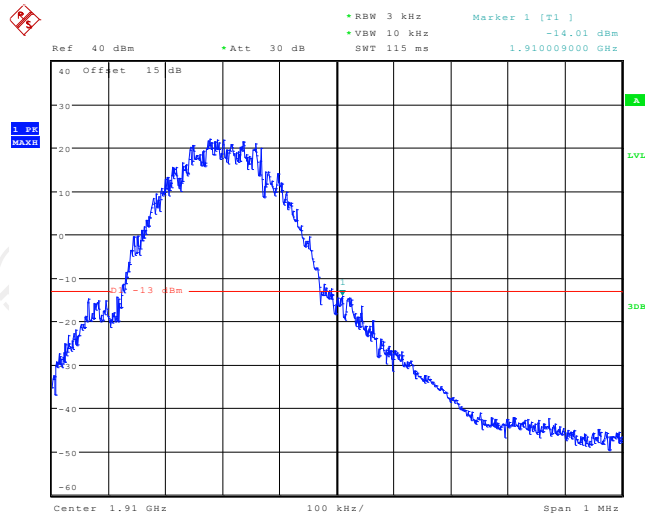

Date: 21 JUN 2019 10:34:56

Band:	WCDMA Band V	Test Mode:	RMC 12.2Kbps Link (QPSK)
-------	--------------	------------	--------------------------

Lower Band Edge Plot on Channel 4132

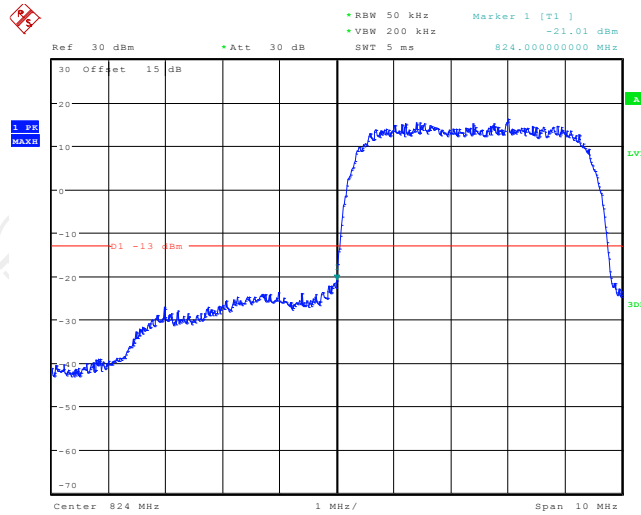

Date: 20.JUN.2019 17:01:45

Higher Band Edge Plot on Channel 4233

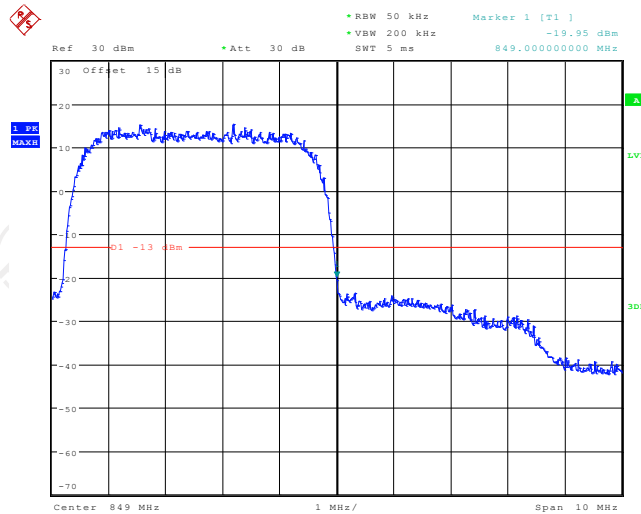

Date: 20.JUN.2019 17:02:13

Band:	WCDMA Band IV	Test Mode:	RMC 12.2Kbps Link (QPSK)
-------	---------------	------------	--------------------------

Lower Band Edge Plot on Channel 1312

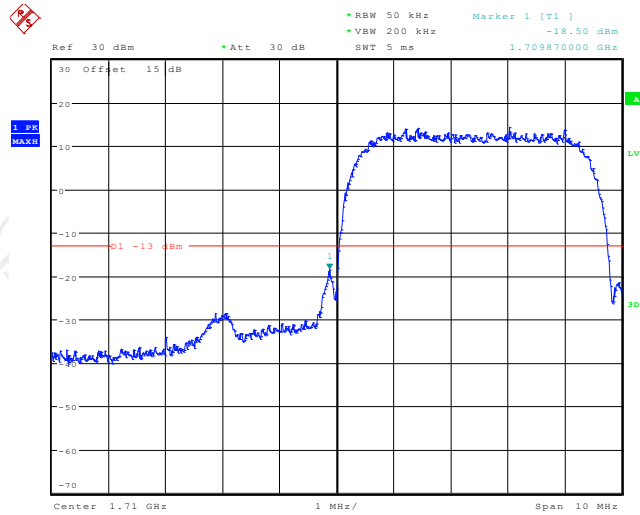

Date: 20.JUN.2019 16:53:28

Higher Band Edge Plot on Channel 1513

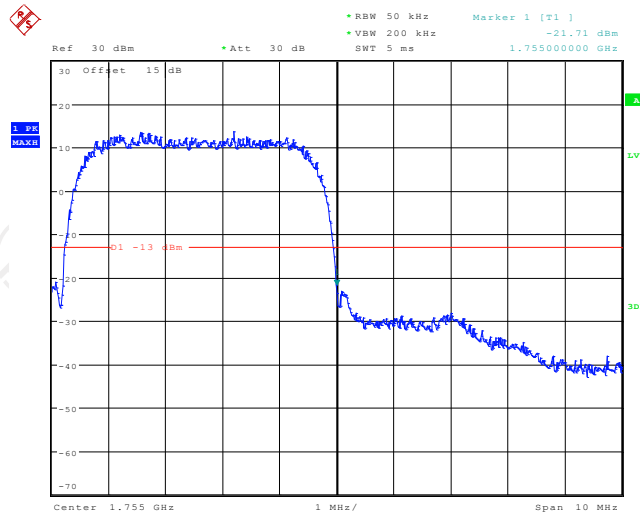

Date: 20.JUN.2019 16:52:28

Band:	WCDMA Band II	Test Mode:	RMC 12.2Kbps Link (QPSK)
-------	---------------	------------	--------------------------

Lower Band Edge Plot on Channel 9262

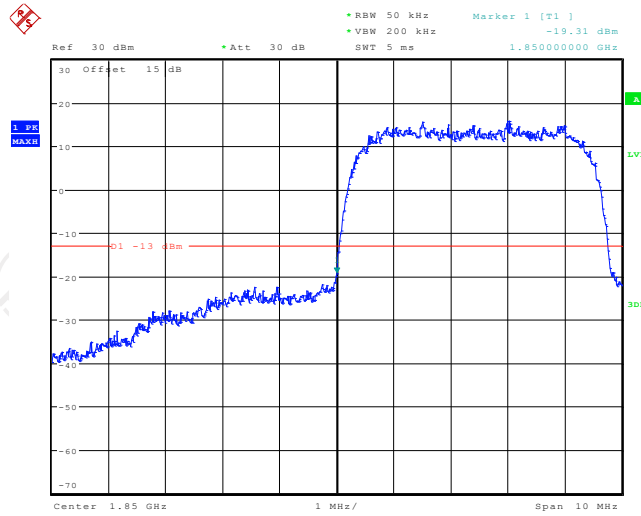

Date: 20 JUN 2019 17:02:47

Higher Band Edge Plot on Channel 9538

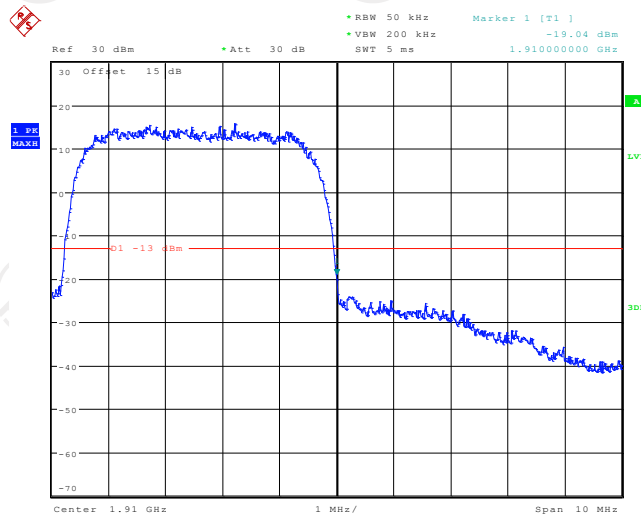

Date: 20 JUN 2019 17:03:19

Band: GSM 850 Test Mode: GSM Link (GMSK)

Conducted Spurious Emission on Channel 128

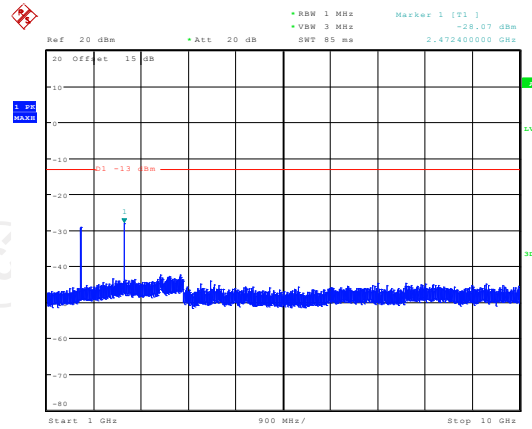
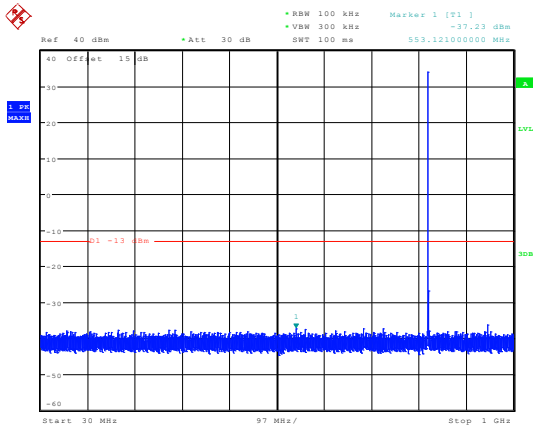

Date: 20.JUN.2019 17:16:15

Date: 20.JUN.2019 17:17:52

Conducted Spurious Emission on Channel 190

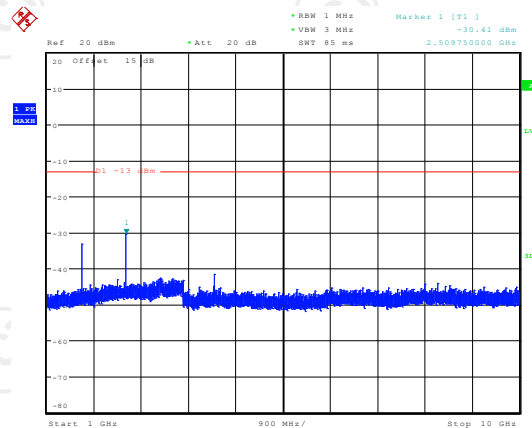
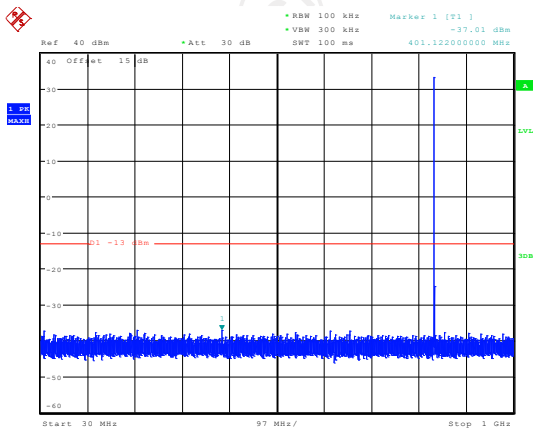

Date: 20.JUN.2019 17:16:44

Date: 20.JUN.2019 17:18:20

Conducted Spurious Emission on Channel 251

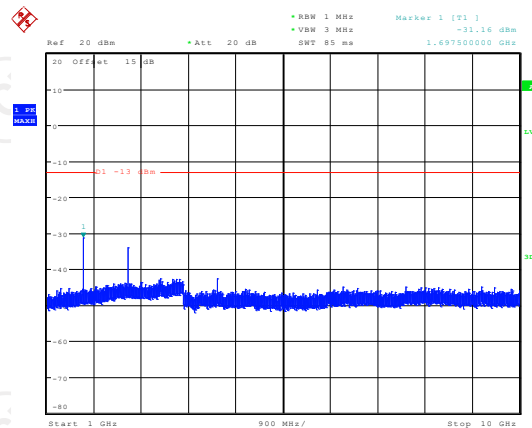
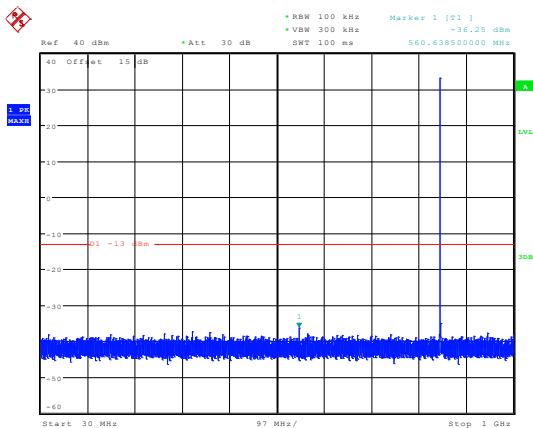

Date: 20.JUN.2019 17:17:06

Date: 20.JUN.2019 17:18:50

Band:	GSM 1900	Test Mode:	GSM Link (GMSK)
-------	----------	------------	-----------------

Conducted Spurious Emission on Channel 512

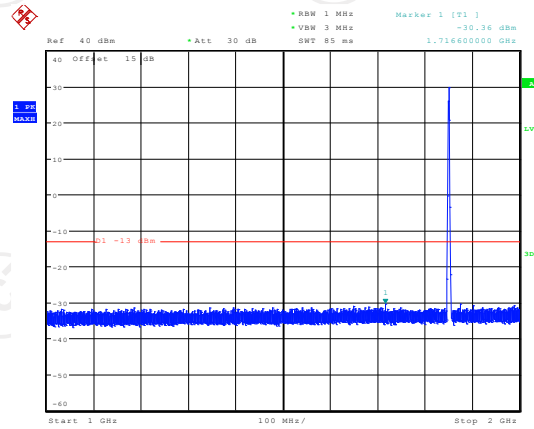
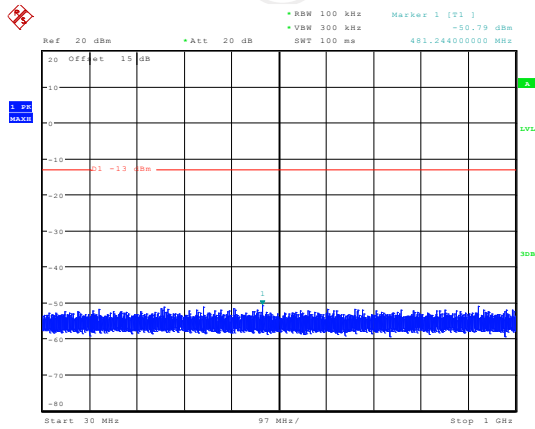

Date: 20.JUN.2019 17:24:54

Date: 20.JUN.2019 17:28:22

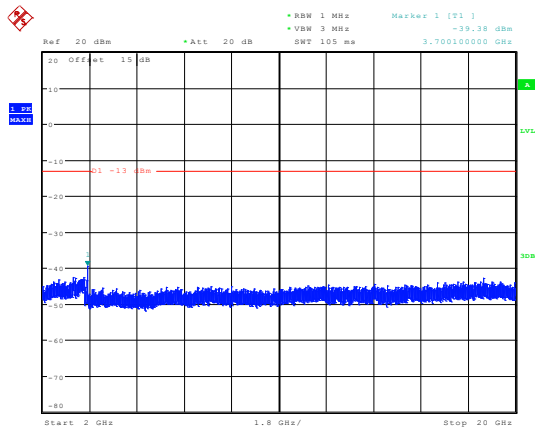

Date: 20.JUN.2019 17:30:45

Conducted Spurious Emission on Channel 661

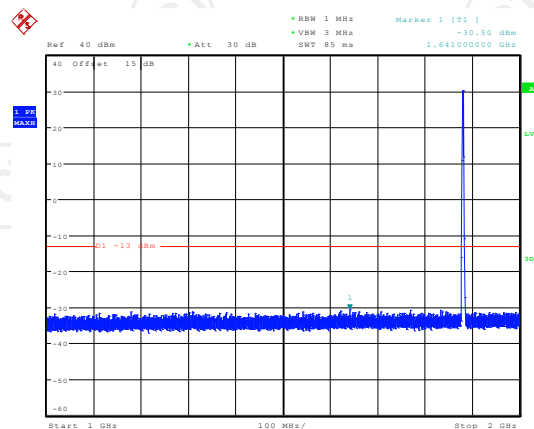
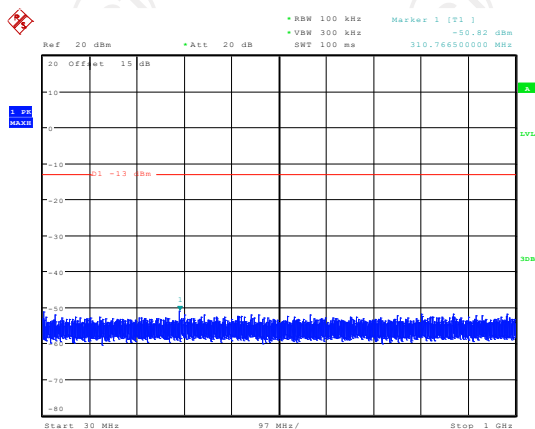

Date: 20.JUN.2019 17:25:10

Date: 20.JUN.2019 17:28:46

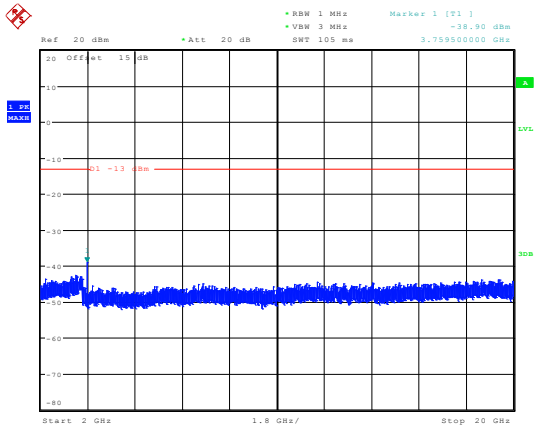

Date: 20.JUN.2019 17:31:04

Conducted Spurious Emission on Channel 810

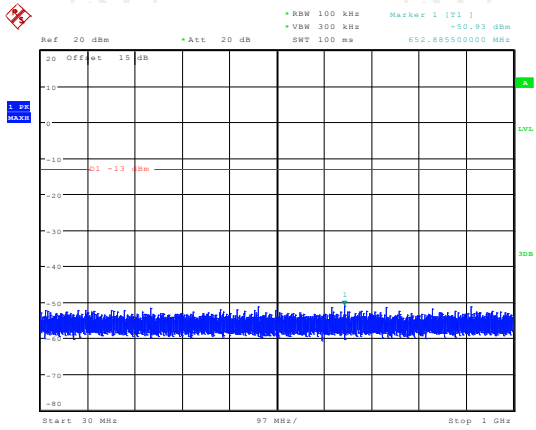

Date: 20.JUN.2019 17:25:27

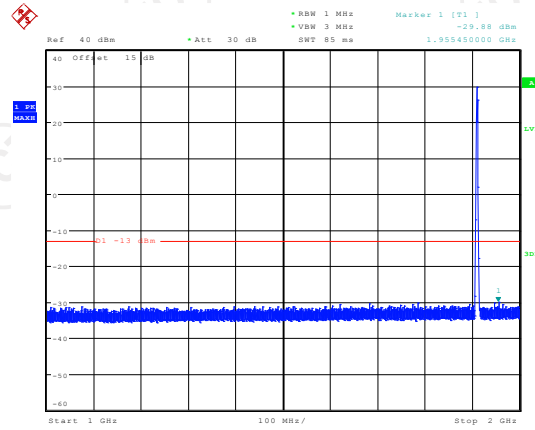

Date: 20.JUN.2019 17:29:38

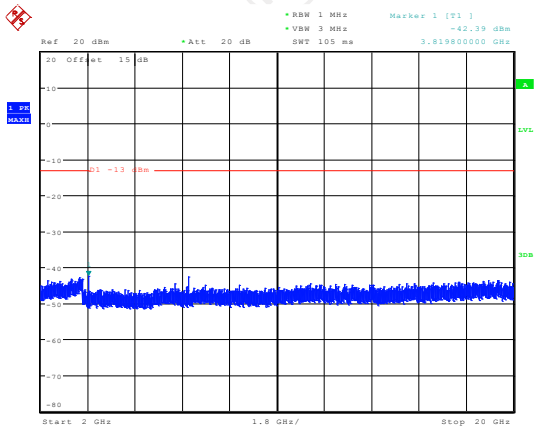

Date: 20.JUN.2019 17:31:33

Band:	GPRS 850	Test Mode:	GSM Link (GMSK)
--------------	-----------------	-------------------	------------------------

Conducted Spurious Emission on Channel 128

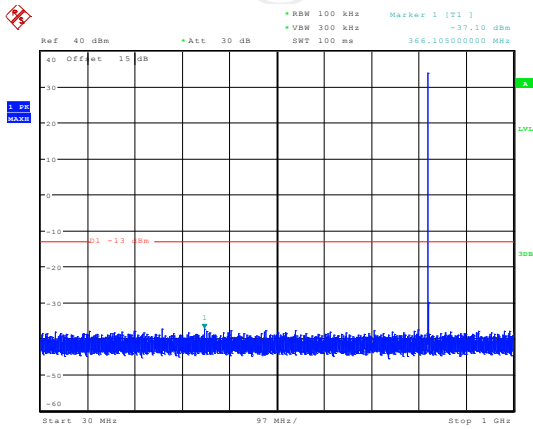

Date: 20 JUN 2019 17:20:31

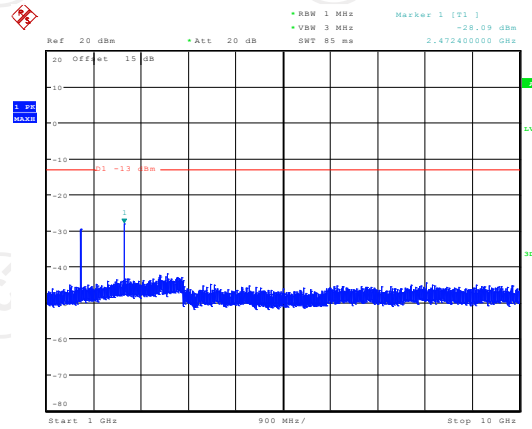

Date: 20 JUN 2019 17:22:13

Conducted Spurious Emission on Channel 190

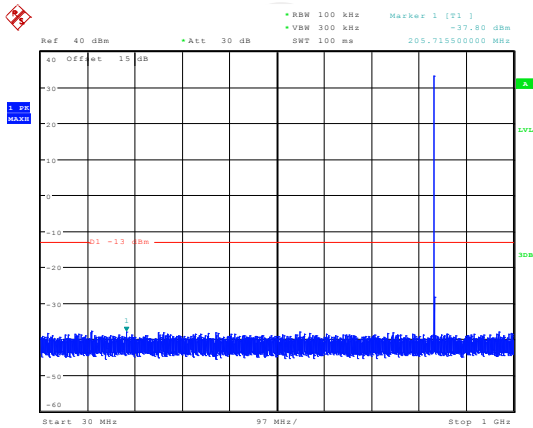

Date: 20 JUN 2019 17:20:55

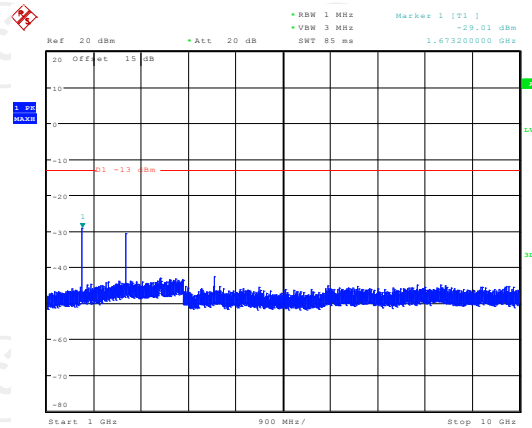

Date: 20 JUN 2019 17:22:38

Conducted Spurious Emission on Channel 251

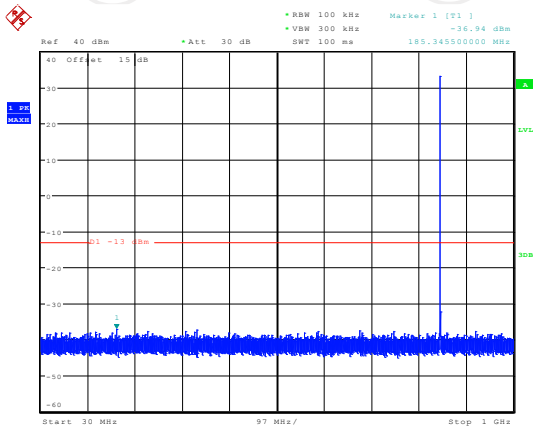

Date: 20 JUN 2019 17:21:26

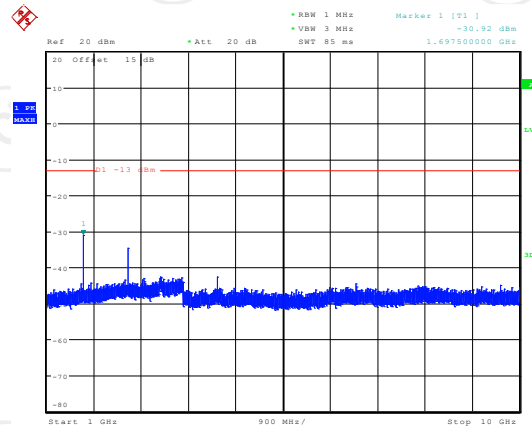

Date: 20 JUN 2019 17:23:05

Band:	GPRS 1900	Test Mode:	GSM Link (GMSK)
-------	-----------	------------	-----------------

Conducted Spurious Emission on Channel 512

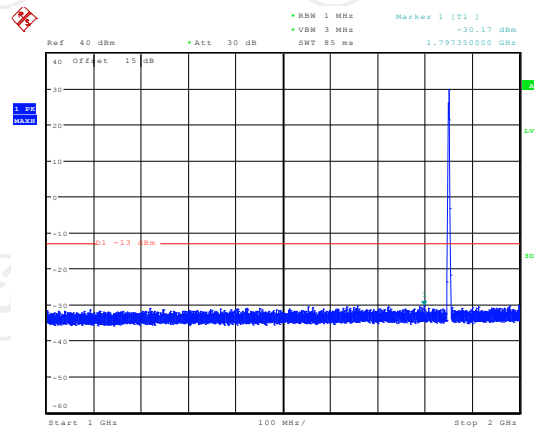
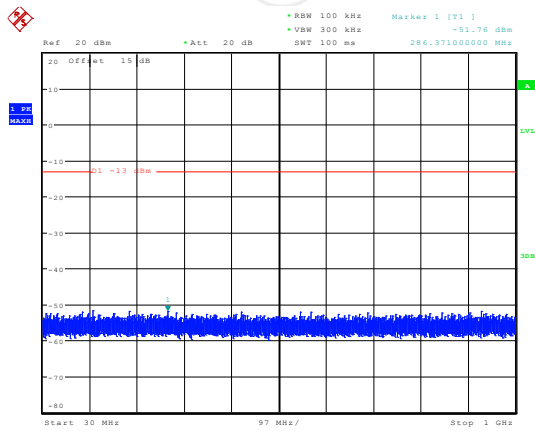

Date: 20.JUN.2019 17:25:46

Date: 20.JUN.2019 17:32:56

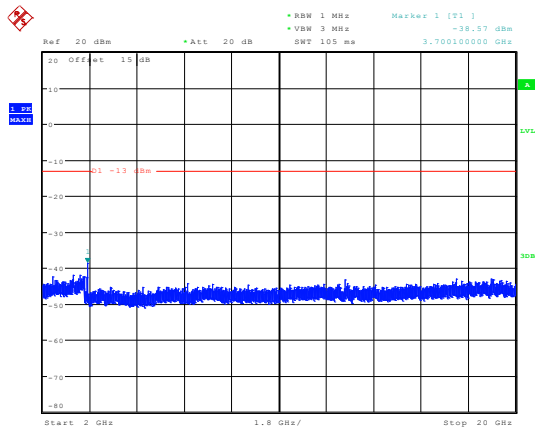

Date: 20.JUN.2019 17:34:51

Conducted Spurious Emission on Channel 661

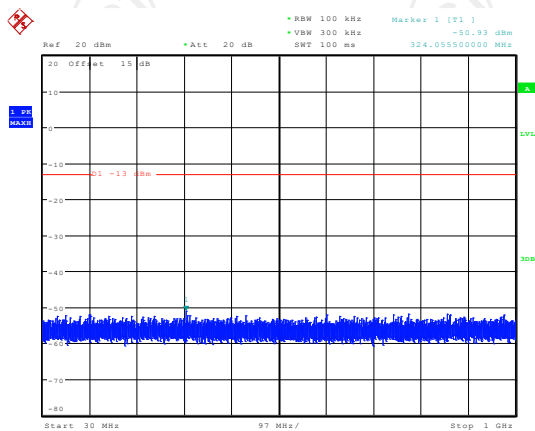

Date: 20.JUN.2019 17:26:00

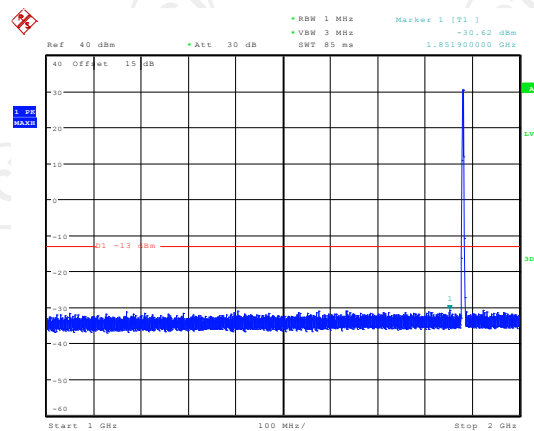

Date: 20.JUN.2019 17:33:19

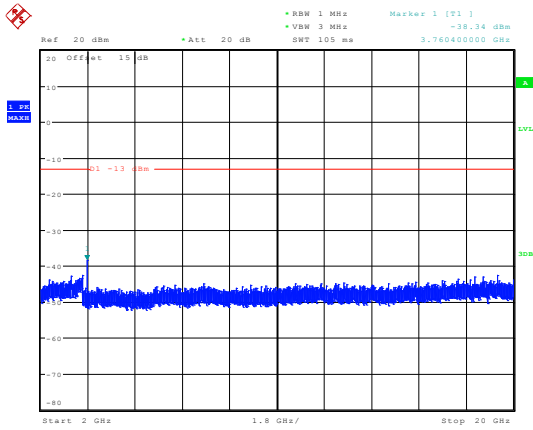

Date: 20.JUN.2019 17:35:08

Conducted Spurious Emission on Channel 810

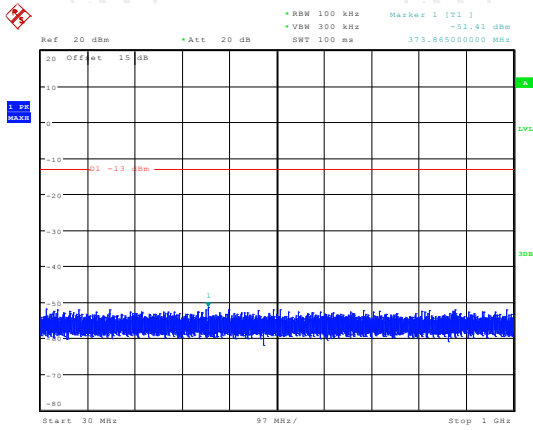

Date: 20.JUN.2019 17:26:15

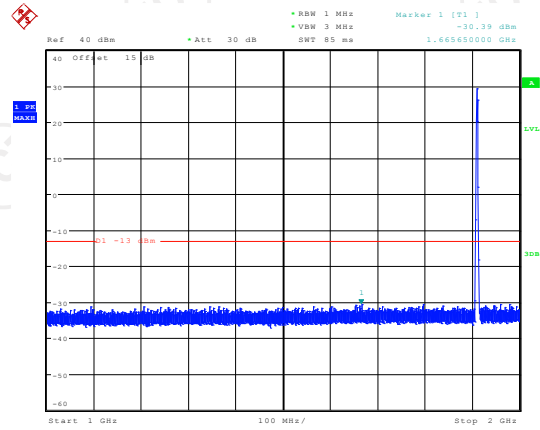

Date: 20.JUN.2019 17:33:43

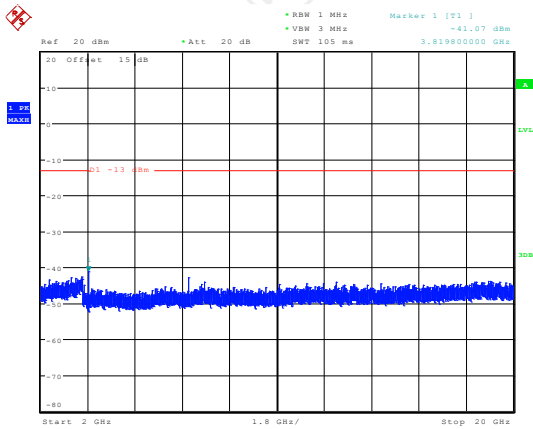

Date: 20.JUN.2019 17:35:50

Band:	WCDMA Band V	Test Mode:	RMC 12.2Kbps Link (QPSK)
-------	--------------	------------	--------------------------

Conducted Spurious Emission on Channel 4132

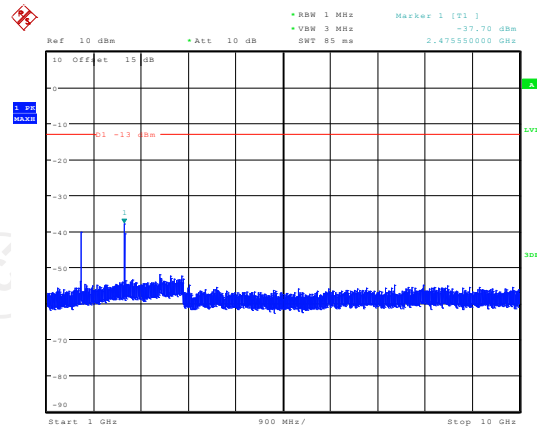
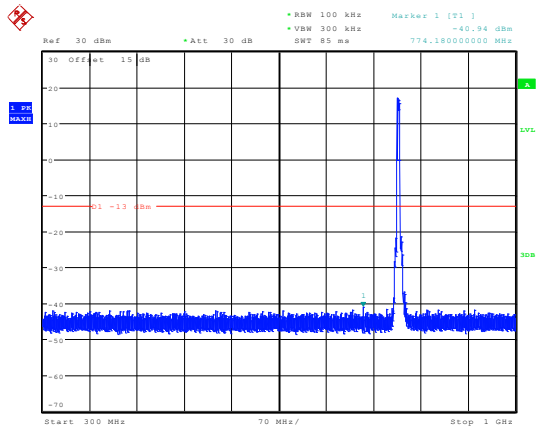

Date: 20.JUN.2019 17:37:51

Date: 20.JUN.2019 17:39:47

Conducted Spurious Emission on Channel 4183

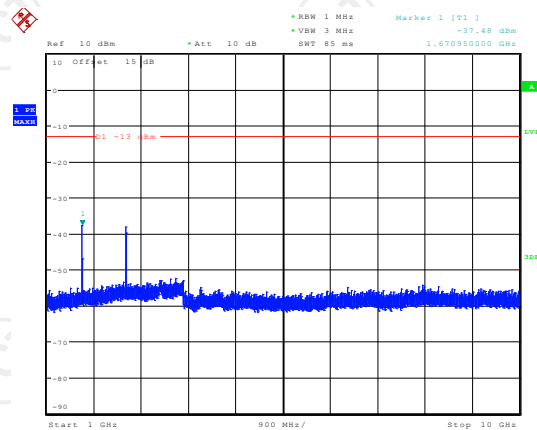
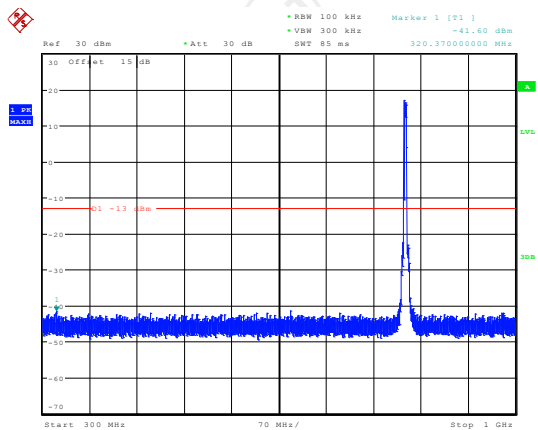

Date: 20.JUN.2019 17:38:26

Date: 20.JUN.2019 17:40:13

Conducted Spurious Emission on Channel 4233

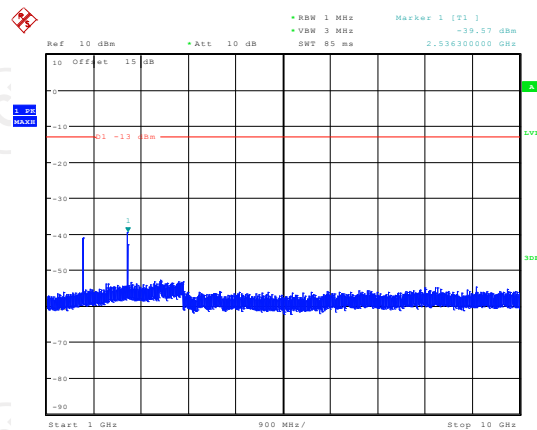
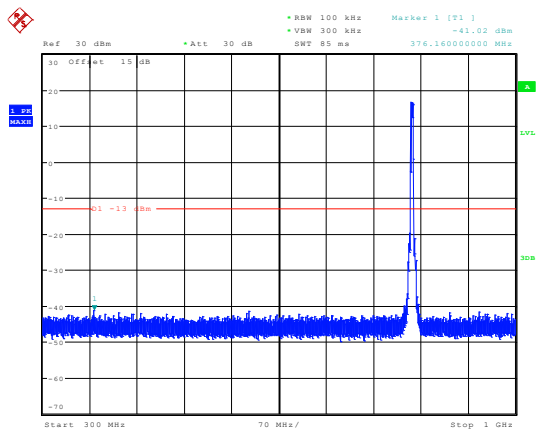

Date: 20.JUN.2019 17:38:52

Date: 20.JUN.2019 17:40:38

Band:	WCDMA Band IV	Test Mode:	RMC 12.2Kbps Link (QPSK)
-------	---------------	------------	--------------------------

Conducted Spurious Emission on Channel 1312

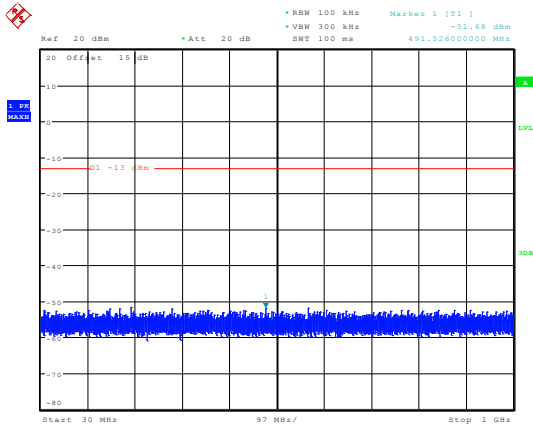

Date: 20.JUN.2019 17:46:50

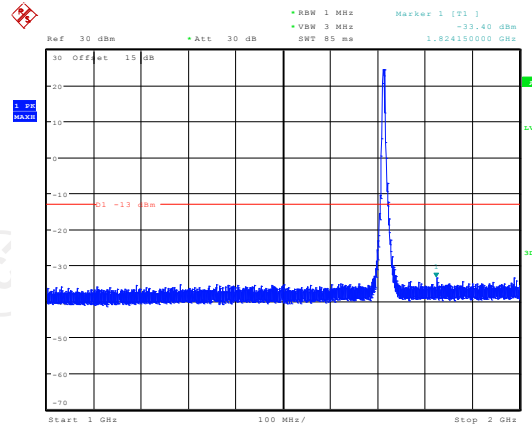

Date: 20.JUN.2019 17:48:40

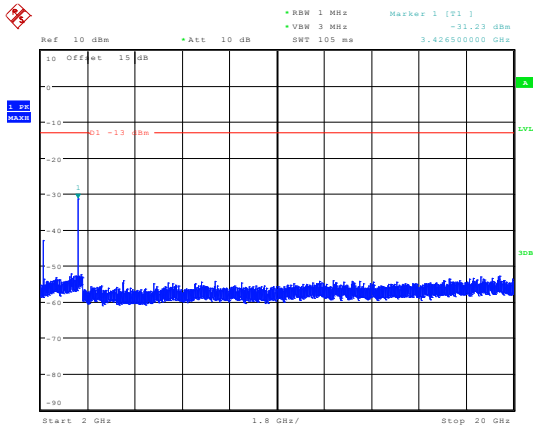

Date: 20.JUN.2019 17:52:49

Conducted Spurious Emission on Channel 1413

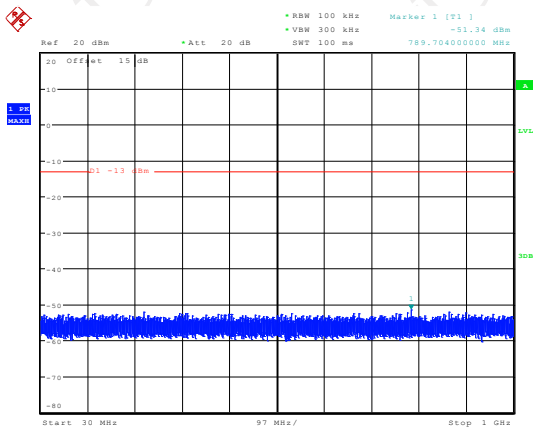

Date: 20.JUN.2019 17:47:07

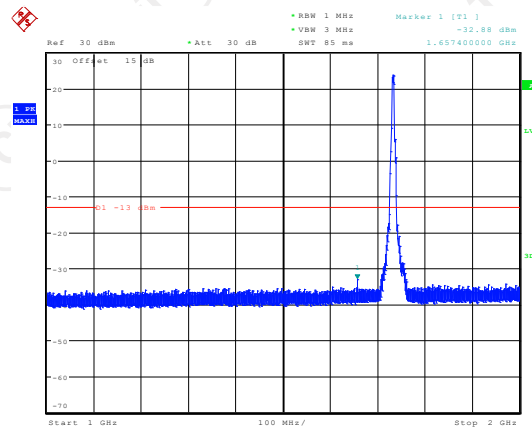

Date: 20.JUN.2019 17:49:22

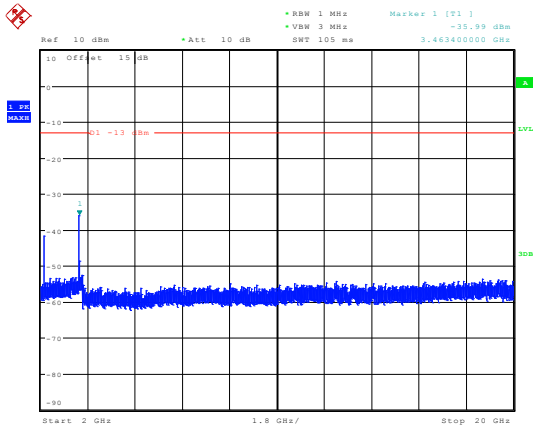

Date: 20.JUN.2019 17:53:09

Conducted Spurious Emission on Channel 1513

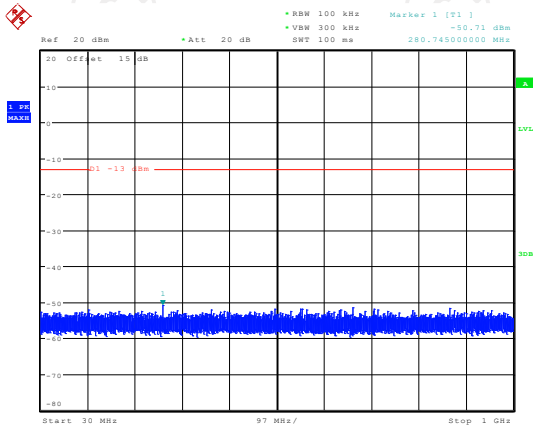

Date: 20.JUN.2019 17:47:28

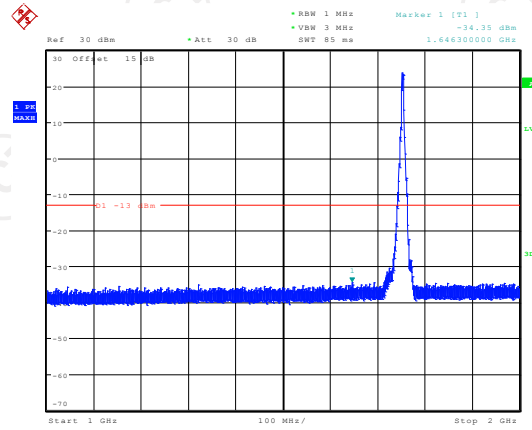

Date: 20.JUN.2019 17:49:56

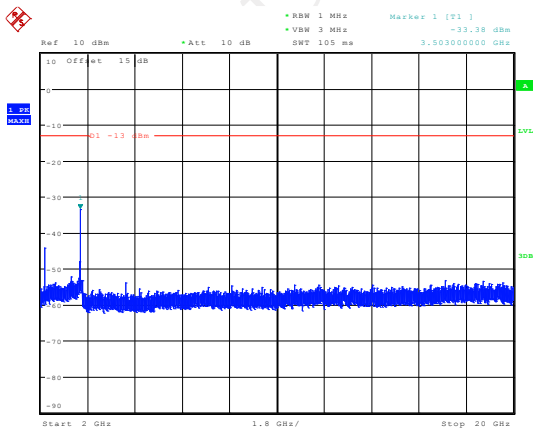

Date: 20.JUN.2019 17:53:30

Band:	WCDMA Band II	Test Mode:	RMC 12.2Kbps Link (QPSK)
-------	---------------	------------	--------------------------

Conducted Spurious Emission on Channel 9262

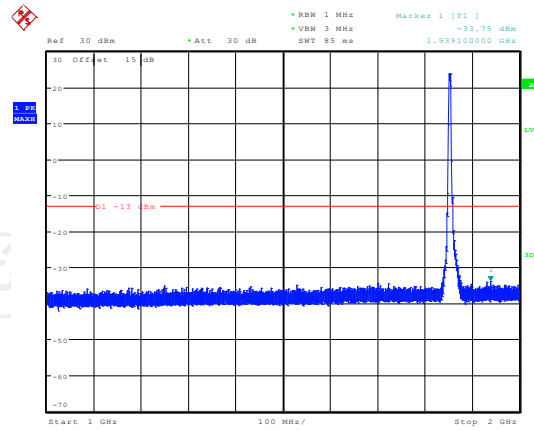
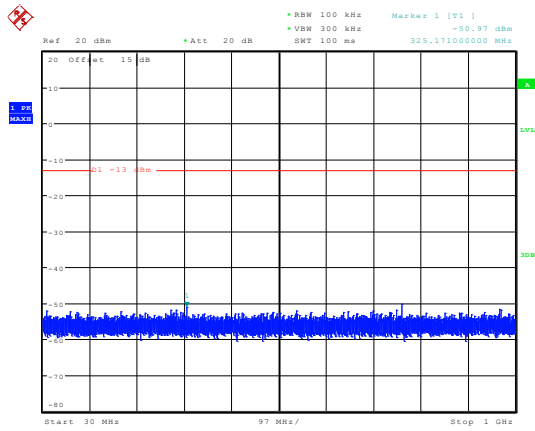

Date: 20.JUN.2019 17:41:54

Date: 20.JUN.2019 17:43:27

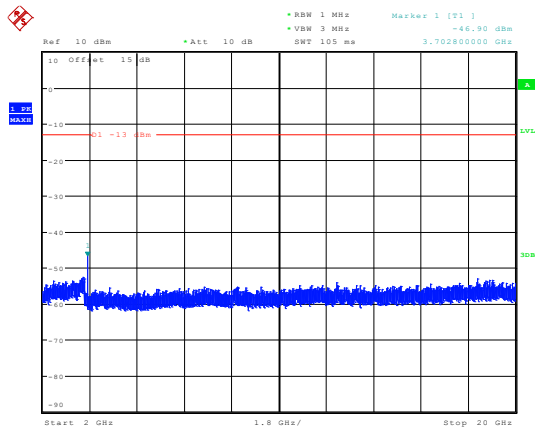

Date: 20.JUN.2019 17:45:12

Conducted Spurious Emission on Channel 9400

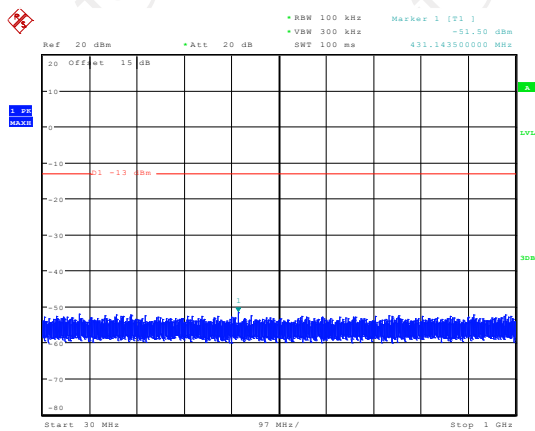

Date: 20.JUN.2019 17:42:09

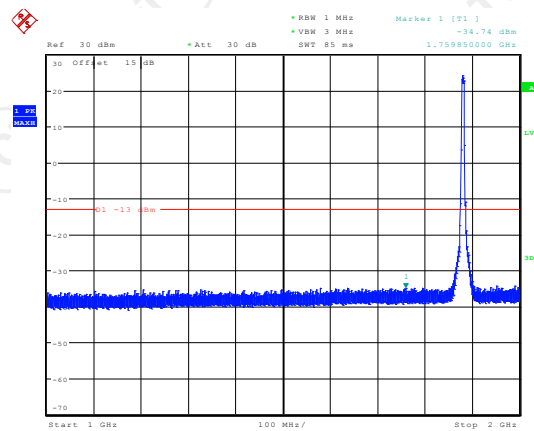

Date: 20.JUN.2019 17:44:06

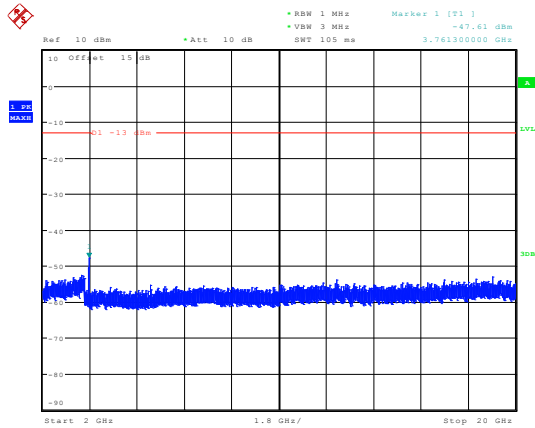

Date: 20.JUN.2019 17:45:31

Conducted Spurious Emission on Channel 9538

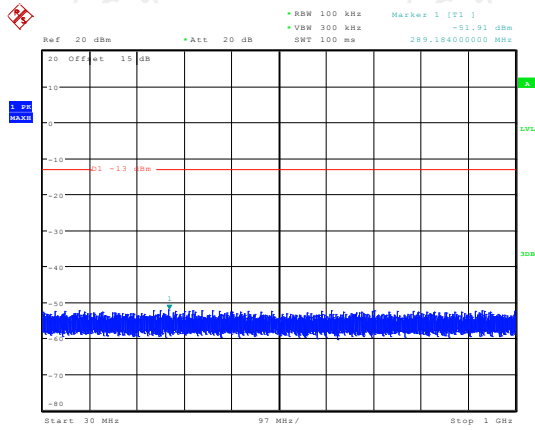

Date: 20.JUN.2019 17:42:27

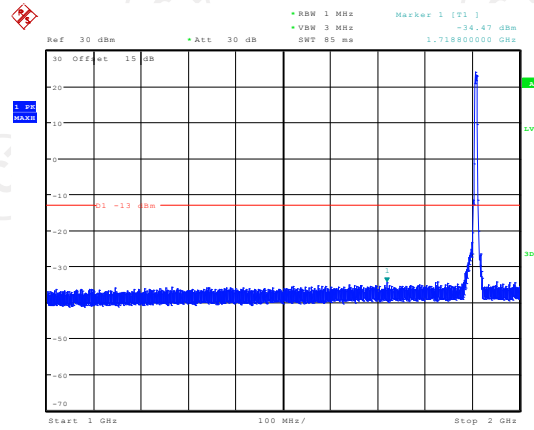

Date: 20.JUN.2019 17:44:36

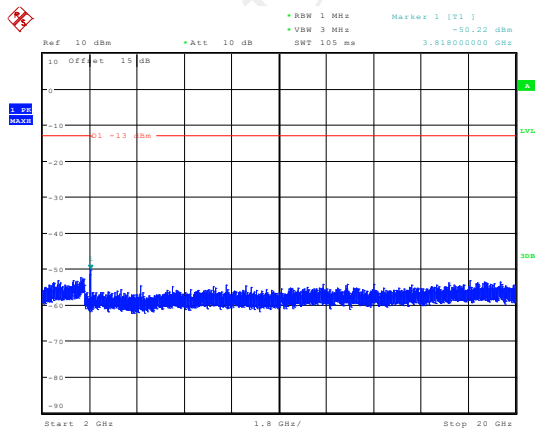

Date: 20.JUN.2019 17:45:52

6.5. Effective Radiated Power and Effective Isotropic Radiated Power Measurement

6.5.1. Test Specification

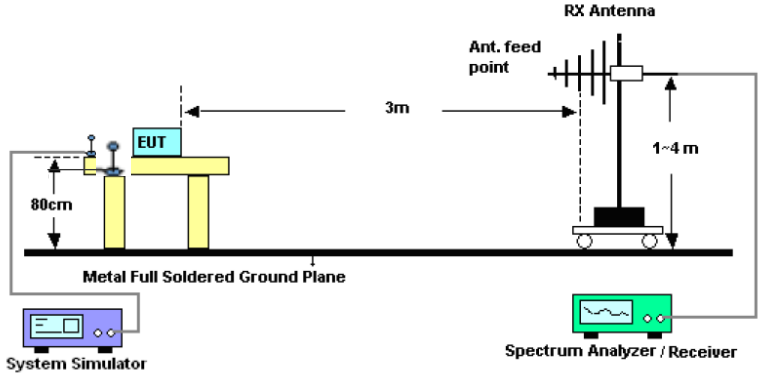
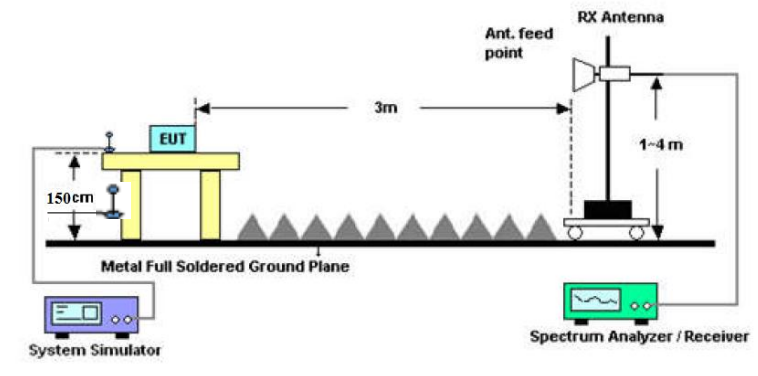
Test Requirement:	FCC part 22.913(a), FCC part 24.232(c), FCC part 27.50(d)																								
Test Method:	FCC KDB 971168 D01v03r01																								
Receiver Setup:	<table border="1"> <thead> <tr> <th></th> <th>GSM/GPRS</th> <th>WCDMA/HSPA</th> </tr> </thead> <tbody> <tr> <td>SPAN</td> <td>500kHz</td> <td>10MHz</td> </tr> <tr> <td>RBW</td> <td>10kHz</td> <td>100kHz</td> </tr> <tr> <td>VBW</td> <td>30kHz</td> <td>300kHz</td> </tr> <tr> <td>Detector</td> <td>RMS</td> <td>RMS</td> </tr> <tr> <td>Trace</td> <td>Average</td> <td>Average</td> </tr> <tr> <td>Average Type</td> <td>Power</td> <td>Power</td> </tr> <tr> <td>Sweep Count</td> <td>100</td> <td>100</td> </tr> </tbody> </table>		GSM/GPRS	WCDMA/HSPA	SPAN	500kHz	10MHz	RBW	10kHz	100kHz	VBW	30kHz	300kHz	Detector	RMS	RMS	Trace	Average	Average	Average Type	Power	Power	Sweep Count	100	100
		GSM/GPRS	WCDMA/HSPA																						
	SPAN	500kHz	10MHz																						
	RBW	10kHz	100kHz																						
	VBW	30kHz	300kHz																						
	Detector	RMS	RMS																						
	Trace	Average	Average																						
Average Type	Power	Power																							
Sweep Count	100	100																							
Limit:	GSM850: 7W ERP PCS1900: 2W EIRP WCDMA Band V: 7W ERP WCDMA Band II: 2W EIRP WCDMA Band IV: 1W EIRP																								
Test Setup:	From 30MHz to 1GHz  Above 1GHz 																								

Test Procedure:

1. The testing follows FCC KDB 971168 D01v03r01 Section 5.8. and ANSI / TIA-603-D-2010 Section 2.2.17.
2. The EUT was placed on a non-conductive rotating platform 0.8 meters high in a semi-anechoic chamber. The radiated emission at the fundamental frequency was measured at 3 m with a test antenna and a spectrum analyzer with RMS detector per section 5. of KDB 971168 D01v03.
3. Key the transmitter, then rotate the EUT 360° azimuthally and record spectrum analyzer power level (LVL) measurements at angular increments that are sufficiently small to permit resolution of all peaks. If a standard radiation test site is used, raise and lower the test antenna to obtain a maximum reading at each angular increment.
4. Replace the transmitter under test with a substitution antenna. The center of the antenna should be at the same location as the center of the antenna under test.
5. Connect the antenna to a signal generator with a known output power and record the path loss (in dB) as LOSS. If a standard radiation test site is used, raise and lower the test antenna to obtain a maximum reading.
LOSS = Generator Output Power (dBm) - Analyzer reading (dBm)
6. Determine the effective radiated output power at each angular position from the readings in steps 3) and 5) using the following equation:
ERP (dBm) = LVL (dBm) + LOSS (dB)
7. The maximum ERP is the maximum value determined in the preceding step.
8. Calculating ERP:
ERP (dBm) = Output Power (dBm) - Losses (dB) + Antenna Gain (dBd)
Antenna Gain (dBd) = Antenna Gain (dBi) - 2.15
EIRP = ERP - 2.15

Test results:

PASS

6.5.2. Test Instruments

Radiated Emission Test Site (966)				
Name of Equipment	Manufacturer	Model	Serial Number	Calibration Due
System simulator	R&S	CMU200	111382	Sep. 20, 2019
Spectrum Analyzer	ROHDE&SCHW ARZ	R&S	FSQ40	Sep. 20, 2019
Signal Generator	HP	83623B	3614A00396	Sep. 16, 2019
Broadband Antenna	Schwarzbeck	VULB9163	340	Sep. 02, 2019
Horn Antenna	Schwarzbeck	BBHA 9120D	631	Oct. 20, 2019
Broadband Antenna	Schwarzbeck	VULB9163	412	Sep. 02, 2019
Horn Antenna	Schwarzbeck	BBHA 9120D	1201	Oct. 20, 2019
Horn Antenna	A-INFO	LB-180400-KF	J211020657	Sep. 16, 2019
Dipole Antenna	TCT	TCT-RF	N/A	Sep. 20, 2019
Coax cable (9kHz-1GHz)	TCT	RE-low-01	N/A	Sep. 16, 2019
Coax cable (9kHz-40GHz)	TCT	RE-high-02	N/A	Sep. 16, 2019
Coax cable (9kHz-1GHz)	TCT	RE-low-03	N/A	Sep. 16, 2019
Coax cable (9kHz-40GHz)	TCT	RE-High-04	N/A	Sep. 16, 2019
Antenna Mast	Keleto	RE-AM	N/A	N/A
EMI Test Software	Shurple Technology	EZ-EMC	N/A	N/A

Note: The calibration interval of the above test instruments is 12 months and the calibrations are traceable to international system unit (SI).

6.5.3. Test Data

Test Result of ERP

GSM850 (GSM) Radiated Power ERP					
Horizontal Polarization (Antenna Pol.)					
Frequency (MHz)	(EUT Pol.)	LVL (dBm)	Correction Factor (dB)	ERP (dBm)	ERP (W)
824.2	H	10.52	21.66	32.18	1.65
836.6	H	11.74	21.54	33.28	2.13
848.8	H	11.24	21.46	32.70	1.86
Vertical Polarization (Antenna Pol.)					
Frequency (MHz)	(EUT Pol.)	LVL (dBm)	Correction Factor (dB)	ERP (dBm)	ERP (W)
824.2	H	8.61	21.66	30.27	1.06
836.6	H	8.83	21.54	30.37	1.09
848.8	H	8.09	21.46	29.55	0.90

GPRS 850 (1-slot) Radiated Power ERP					
Horizontal Polarization (Antenna Pol.)					
Frequency (MHz)	(EUT Pol.)	LVL (dBm)	Correction Factor (dB)	ERP (dBm)	ERP (W)
824.2	H	9.45	21.66	31.11	1.29
836.6	H	9.96	21.54	31.50	1.41
848.8	H	9.33	21.46	30.79	1.12
Vertical Polarization (Antenna Pol.)					
Frequency (MHz)	(EUT Pol.)	LVL (dBm)	Correction Factor (dB)	ERP (dBm)	ERP (W)
824.2	H	6.76	21.66	28.42	0.70
836.6	H	6.28	21.54	27.82	0.61
848.8	H	6.51	21.46	27.97	0.63

Note: All GPRS slot have been tested, but only the worst GPRS 1-slot show in this test item.

WCDMA Band V (RMC 12.2Kbps) Radiated Power ERP					
Horizontal Polarization (Antenna Pol.)					
Frequency (MHz)	(EUT Pol.)	LVL (dBm)	Correction Factor (dB)	ERP (dBm)	ERP (W)
826.4	H	2.73	21.62	24.35	0.27
836.6	H	3.15	21.54	24.69	0.29
846.6	H	2.88	21.44	24.32	0.27
Vertical Polarization (Antenna Pol.)					
Frequency (MHz)	(EUT Pol.)	LVL (dBm)	Correction Factor (dB)	ERP (dBm)	ERP (W)
826.4	H	0.34	21.62	21.96	0.16
836.6	H	0.56	21.54	22.10	0.16
846.6	H	0.69	21.44	22.13	0.16

* ERP = LVL (dBm) + Correction Factor (dB) - 2.15

Correction Factor = S.G. Power - Cable loss + Antenna Gain - SPA. Reading

Test Result of EIRP

GSM1900 (GSM) Radiated Power EIRP					
Horizontal Polarization (Antenna Pol.)					
Frequency (MHz)	(EUT Pol.)	LVL (dBm)	Correction Factor (dB)	ERP (dBm)	ERP (W)
1850.2	H	7.73	21.66	29.39	0.87
1880.0	H	7.57	21.54	29.11	0.81
1909.8	H	7.21	21.46	28.67	0.74
Vertical Polarization (Antenna Pol.)					
Frequency (MHz)	(EUT Pol.)	LVL (dBm)	Correction Factor (dB)	ERP (dBm)	ERP (W)
1850.2	H	5.82	21.66	27.48	0.56
1880.0	H	5.49	21.54	27.03	0.50
1909.8	H	5.92	21.46	27.38	0.55

GPRS1900 (1-slot) Radiated Power EIRP					
Horizontal Polarization (Antenna Pol.)					
Frequency (MHz)	(EUT Pol.)	LVL (dBm)	Correction Factor (dB)	ERP (dBm)	ERP (W)
1850.2	H	7.44	21.66	29.10	0.81
1880.0	H	7.25	21.54	28.79	0.76
1909.8	H	7.16	21.46	28.62	0.73
Vertical Polarization (Antenna Pol.)					
Frequency (MHz)	(EUT Pol.)	LVL (dBm)	Correction Factor (dB)	ERP (dBm)	ERP (W)
1850.2	H	5.55	21.66	27.21	0.53
1880.0	H	5.36	21.54	26.90	0.49
1909.8	H	5.79	21.46	27.25	0.53

Note: All GPRS slot have been tested, but only the worst GPRS 1-slot show in this test item

WCDMA Band IV (RMC 12.2Kbps) Radiated Power EIRP					
Horizontal Polarization (Antenna Pol.)					
Frequency (MHz)	(EUT Pol.)	LVL (dBm)	Correction Factor (dB)	EIRP (dBm)	EIRP (W)
1712.4	H	3.40	18.33	21.73	0.15
1732.6	H	3.52	18.15	21.67	0.15
1752.6	H	3.61	18.24	21.85	0.15
Vertical Polarization (Antenna Pol.)					
Frequency (MHz)	(EUT Pol.)	LVL (dBm)	Correction Factor (dB)	EIRP (dBm)	EIRP (W)
1712.4	H	1.22	18.33	19.55	0.09
1732.6	H	1.49	18.15	19.64	0.09
1752.6	H	1.53	18.24	19.77	0.09

* EIRP = LVL (dBm) + Correction Factor (dB)

Correction Factor= S.G. Power - Cable loss + Antenna Gain- SPA. Reading

WCDMA Band II (RMC 12.2Kbps) Radiated Power EIRP					
Horizontal Polarization (Antenna Pol.)					
Frequency (MHz)	(EUT Pol.)	LVL (dBm)	Correction Factor (dB)	ERP (dBm)	ERP (W)
1852.4	H	2.33	21.62	23.95	0.25
1880.0	H	2.56	21.54	24.10	0.26
1907.6	H	2.89	21.48	24.37	0.27
Vertical Polarization (Antenna Pol.)					
Frequency (MHz)	(EUT Pol.)	LVL (dBm)	Correction Factor (dB)	ERP (dBm)	ERP (W)
1852.4	H	0.25	21.62	21.87	0.15
1880.0	H	0.08	21.54	21.62	0.15
1907.6	H	0.74	21.48	22.22	0.17

* EIRP = LVL (dBm) + Correction Factor (dB)

Correction Factor= S.G. Power - Cable loss + Substitution Antenna Gain- SPA. Reading

6.6. Field Strength of Spurious Radiation Measurement

6.6.1. Test Specification

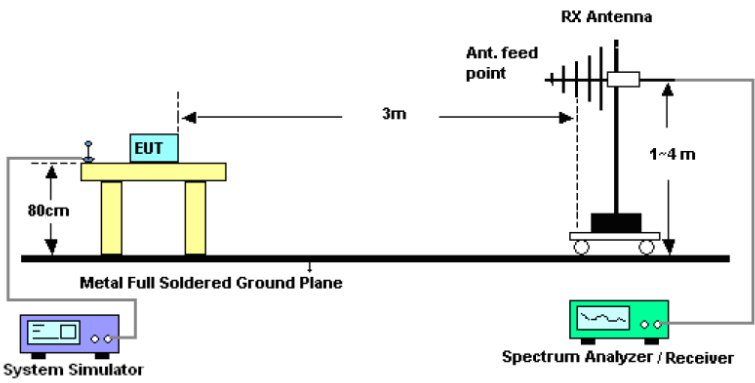
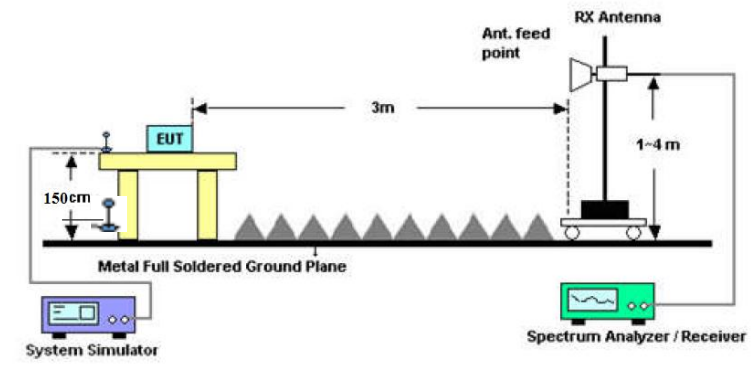
Test Requirement:	FCC part 22.917(a), FCC part 24.238(a), FCC part 27.53(g)
Test Method:	FCC KDB 971168 D01v03r01
Operation mode:	Refer to item 4.1
Limit:	-13dBm
Test setup:	<p>For 30MHz~1GHz</p>  <p>Above 1GHz</p> 
Test Procedure:	<ol style="list-style-type: none"> 1. The testing follows FCC KDB 971168 D01v03r01 Section 6 and ANSI / TIA-603-D-2010 Section 2.2.12. 2. The EUT was placed on a rotatable wooden table 0.8 meters above the ground. 3. The EUT was set 3 meters from the receiving antenna, which was mounted on the antenna tower. 4. The table was rotated 360 degrees to determine the position of the highest spurious emission. 5. The height of the receiving antenna is varied between one meter and four meters to search for the maximum spurious emission for both horizontal and vertical polarizations. 6. Make the measurement with the spectrum analyzer's

	<p>RBW = 1MHz, VBW = 3MHz, taking record of maximum spurious emission.</p> <p>7. A horn antenna was substituted in place of the EUT and was driven by a signal generator.</p> <p>8. Tune the output power of signal generator to the same emission level with EUT maximum spurious emission.</p> <p>9. Taking the record of output power at antenna port.</p> <p>10. Repeat step 7 to step 8 for another polarization.</p> <p>11. EIRP (dBm) = S.G. Power – Tx Cable Loss + Tx Antenna Gain</p> <p>12. ERP (dBm) = EIRP - 2.15</p> <p>13. The RF fundamental frequency should be excluded against the limit line in the operating frequency band.</p> <p>14. The limit line is derived from 43 + 10log(P) dB below the transmitter power P(Watts)</p> <p>= P(W) - [43 + 10log(P)] (dB)</p> <p>= [30 + 10log(P)] (dBm) - [43 + 10log(P)] (dB)</p> <p>= -13dBm.</p>
Test results:	PASS
Remark:	All modulations have been tested, but only the worst modulation show in this test item.

6.6.2. Test Instruments

Radiated Emission Test Site (966)				
Name of Equipment	Manufacturer	Model	Serial Number	Calibration Due
System simulator	R&S	CMU200	111382	Sep. 20, 2019
Spectrum Analyzer	ROHDE&SCHW ARZ	R&S	FSQ40	Sep. 20, 2019
Signal Generator	HP	83623B	3614A00396	Sep. 16, 2019
Broadband Antenna	Schwarzbeck	VULB9163	340	Sep. 02, 2019
Horn Antenna	Schwarzbeck	BBHA 9120D	631	Oct. 20, 2019
Broadband Antenna	Schwarzbeck	VULB9163	412	Sep. 02, 2019
Horn Antenna	Schwarzbeck	BBHA 9120D	1201	Oct. 20, 2019
Horn Antenna	A-INFO	LB-180400-KF	J211020657	Sep. 16, 2019
Dipole Antenna	TCT	TCT-RF	N/A	Sep. 20, 2019
Coax cable (9kHz-1GHz)	TCT	RE-low-01	N/A	Sep. 16, 2019
Coax cable (9kHz-40GHz)	TCT	RE-high-02	N/A	Sep. 16, 2019
Coax cable (9kHz-1GHz)	TCT	RE-low-03	N/A	Sep. 16, 2019
Coax cable (9kHz-40GHz)	TCT	RE-High-04	N/A	Sep. 16, 2019
Antenna Mast	Keleto	RE-AM	N/A	N/A
EMI Test Software	Shurple Technology	EZ-EMC	N/A	N/A

Note: The calibration interval of the above test instruments is 12 months and the calibrations are traceable to international system unit (SI).

6.6.3. Test Data

Frequency Range (9 kHz-30MHz)

Frequency (MHz)	Level@3m (dB μ V/m)	Limit@3m (dB μ V/m)
--	--	--
--	--	--
--	--	--
--	--	--

Note: 1. Emission Level=Reading+ Cable loss+Antenna factor-Amp factor

2. The emission levels are 20 dB below the limit value, which are not reported. It is deemed to comply with the requirement

Band	GSM 850		Test channel:	Lowest
Test mode:			Temperature :	25°C
			Relative Humidity:	56%
Note:	Spurious emissions within 30-1000MHz were found more than 20dB below limit line.			
Frequency (MHz)	Spurious Emission		Limit (dBm)	Result
	Polarization	Level (dBm)		
1648.40	Vertical	-33.65	-13.00	PASS
2472.60	V	-38.72		
3296.80	V	-52.13		
1648.40	Horizontal	-31.58		
2472.60	H	-37.26		
3296.80	H	-50.79		
Band	GSM 850		Test channel:	Middle
Test mode:			Temperature :	25°C
			Relative Humidity:	56%
Note:	Spurious emissions within 30-1000MHz were found more than 20dB below limit line.			
Frequency (MHz)	Spurious Emission		Limit (dBm)	Result
	Polarization	Level (dBm)		
1673.20	Vertical	-32.77	-13.00	PASS
2509.80	V	-43.18		
3346.40	V	-51.91		
1673.20	Horizontal	-30.65		
2509.80	H	-38.55		
3346.40	H	-51.36		
Band	GSM 850		Test channel:	Highest
Test mode:			Temperature :	25°C
			Relative Humidity:	56%
Note:	Spurious emissions within 30-1000MHz were found more than 20dB below limit line.			
Frequency (MHz)	Spurious Emission		Limit (dBm)	Result
	Polarization	Level (dBm)		
1697.60	Vertical	-34.82	-13.00	PASS
2546.40	V	-43.47		
3395.20	V	-51.88		
1697.60	Horizontal	-30.11		
2546.40	H	-39.07		
3395.20	H	-53.14		

Band	PCS 1900		Test channel:	Lowest
Test mode:			Temperature :	25°C
			Relative Humidity:	56%
Note:	Spurious emissions within 30-1000MHz were found more than 20dB below limit line.			
Frequency (MHz)	Spurious Emission		Limit (dBm)	Result
	Polarization	Level (dBm)		
3700.40	Vertical	-38.46	-13.00	PASS
5550.60	V	-46.12		
7400.80	V	-53.37		
3700.40	Horizontal	-35.25		
5550.60	H	-41.87		
7400.80	H	-51.53		
Test mode:	PCS 1900		Test channel:	Middle
Test mode:			Temperature :	25°C
			Relative Humidity:	56%
Note:	Spurious emissions within 30-1000MHz were found more than 20dB below limit line.			
Frequency (MHz)	Spurious Emission		Limit (dBm)	Result
	Polarization	Level (dBm)		
3760.00	Vertical	-38.91	-13.00	PASS
5640.00	V	-48.54		
7520.00	V	-46.07		
3760.00	Horizontal	-35.75		
5640.00	H	-47.77		
7520.00	H	-52.18		
Test mode:	PCS 1900		Test channel:	Highest
Test mode:			Temperature :	25°C
			Relative Humidity:	56%
Note:	Spurious emissions within 30-1000MHz were found more than 20dB below limit line.			
Frequency (MHz)	Spurious Emission		Limit (dBm)	Result
	Polarization	Level (dBm)		
3819.60	Vertical	-36.22	-13.00	PASS
5729.40	V	-45.68		
7639.20	V	-52.43		
3819.60	Horizontal	-34.09		
5729.40	H	-41.15		
7639.20	H	-52.54		

Band	WCDMA Band V		Test channel:	Lowest
Test mode:	RMC 12.2Kbps Link (QPSK)		Temperature :	25°C
			Relative Humidity:	56%
Note:	Spurious emissions within 30-1000MHz were found more than 20dB below limit line.			
Frequency (MHz)	Spurious Emission		Limit (dBm)	Result
	Polarization	Level (dBm)		
1652.80	Vertical	-43.33	-13.00	PASS
2479.20	V	-52.68		
3305.60	V	-51.74		
1652.80	Horizontal	-41.29		
2479.20	H	-51.66		
3305.60	H	-53.87		
Test mode:	WCDMA Band V		Test channel:	Middle
Test mode:	RMC 12.2Kbps Link (QPSK)		Temperature :	25°C
			Relative Humidity:	56%
Note:	Spurious emissions within 30-1000MHz were found more than 20dB below limit line.			
Frequency (MHz)	Spurious Emission		Limit (dBm)	Result
	Polarization	Level (dBm)		
1673.20	Vertical	-42.45	-13.00	PASS
2509.80	V	-51.01		
3346.40	V	-51.52		
1673.20	Horizontal	-40.64		
2509.80	H	-54.06		
3346.40	H	-52.49		
Test mode:	WCDMA Band V		Test channel:	Highest
Test mode:	RMC 12.2Kbps Link (QPSK)		Temperature :	25°C
			Relative Humidity:	56%
Note:	Spurious emissions within 30-1000MHz were found more than 20dB below limit line.			
Frequency (MHz)	Spurious Emission		Limit (dBm)	Result
	Polarization	Level (dBm)		
1693.20	Vertical	-45.60	-13.00	PASS
2539.80	V	-52.32		
3386.40	V	-57.75		
1693.20	Horizontal	-42.19		
2539.80	H	-52.25		
3386.40	H	-55.86		

Band	WCDMA Band IV		Test channel:	Lowest
Test mode:	RMC 12.2Kbps Link (QPSK)		Temperature :	23~24°C
			Relative Humidity:	46~48%
Note:	Spurious emissions within 30-1000MHz were found more than 20dB below limit line.			
Frequency (MHz)	Spurious Emission		Limit (dBm)	Result
	Polarization	Level (dBm)		
2452.3	Vertical	-53.81	-13.00	PASS
3424.8	V	-52.26		
5137.2	V	-54.51		
2452.3	Horizontal	-52.50		
3424.8	H	-53.09		
5137.2	H	-51.12		
Test mode:	WCDMA Band IV		Test channel:	Middle
Test mode:	RMC 12.2Kbps Link (QPSK)		Temperature :	23~24°C
			Relative Humidity:	46~48%
Note:	Spurious emissions within 30-1000MHz were found more than 20dB below limit line.			
Frequency (MHz)	Spurious Emission		Limit (dBm)	Result
	Polarization	Level (dBm)		
2641.3	Vertical	-53.98	-13.00	PASS
3465.2	V	-51.43		
5197.8	V	-54.81		
2641.3	Horizontal	-51.56		
3465.2	H	-56.37		
5197.8	H	-53.64		
Test mode:	WCDMA Band IV		Test channel:	Highest
Test mode:	RMC 12.2Kbps Link (QPSK)		Temperature :	23~24°C
			Relative Humidity:	46~48%
Note:	Spurious emissions within 30-1000MHz were found more than 20dB below limit line.			
Frequency (MHz)	Spurious Emission		Limit (dBm)	Result
	Polarization	Level (dBm)		
3102.2	Vertical	-51.99	-13.00	PASS
3505.2	V	-52.25		
5257.8	V	-49.66		
3102.2	Horizontal	-53.79		
3505.2	H	-51.59		
5257.8	H	-55.85		

Band	WCDMA Band II		Test channel:	Lowest
Test mode:	RMC 12.2Kbps Link (QPSK)		Temperature :	25°C
			Relative Humidity:	56%
Note:	Spurious emissions within 30-1000MHz were found more than 20dB below limit line.			
Frequency (MHz)	Spurious Emission		Limit (dBm)	Result
	Polarization	Level (dBm)		
3704.80	Vertical	-41.02	-13.00	PASS
5557.20	V	-53.65		
7409.60	V	-57.21		
3704.80	Horizontal	-43.86		
5557.20	H	-51.79		
7409.60	H	-56.34		
Test mode:	WCDMA Band II		Test channel:	Middle
Test mode:	RMC 12.2Kbps Link (QPSK)		Temperature :	25°C
			Relative Humidity:	56%
Note:	Spurious emissions within 30-1000MHz were found more than 20dB below limit line.			
Frequency (MHz)	Spurious Emission		Limit (dBm)	Result
	Polarization	Level (dBm)		
3760.00	Vertical	-43.98	-13.00	PASS
5640.00	V	-52.52		
7520.00	V	-55.14		
3760.00	Horizontal	-44.97		
5640.00	H	-50.84		
7520.00	H	-58.13		
Test mode:	WCDMA Band II		Test channel:	Highest
Test mode:	RMC 12.2Kbps Link (QPSK)		Temperature :	25°C
			Relative Humidity:	56%
Note:	Spurious emissions within 30-1000MHz were found more than 20dB below limit line.			
Frequency (MHz)	Spurious Emission		Limit (dBm)	Result
	Polarization	Level (dBm)		
3815.20	Vertical	-45.05	-13.00	PASS
5722.80	V	-55.74		
7630.40	V	-58.23		
3815.20	Horizontal	-42.35		
5722.80	H	-51.71		
7630.40	H	-59.06		

6.7. Frequency Stability Measurement

6.7.1. Test Specification

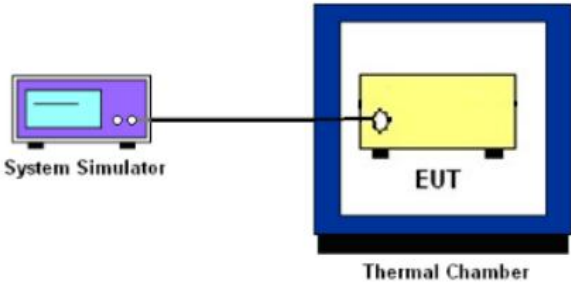
Test Requirement:	FCC Part 2.1055; FCC Part 22.355; FCC Part 24.235; FCC Part 27.54
Test Method:	FCC KDB 971168 D01v03r01
Operation mode:	Refer to item 4.1
Limit:	FCC Part 22.355 & Part 27.54 : ± 2.5 ppm FCC Part 24.235 : The frequency stability shall be sufficient to ensure that the fundamental emission stays within the authorized frequency block.
Test Setup:	 <p>The diagram illustrates the test setup. On the left is a 'System Simulator' represented by a purple box with a screen. A black line connects it to a yellow box labeled 'EUT' (Equipment Under Test) which is placed inside a blue-bordered 'Thermal Chamber'.</p>
Test Procedure:	<p>Test Procedures for Temperature Variation</p> <ol style="list-style-type: none"> 1. The testing follows FCC KDB 971168 D01v03r01 Section 9.0. 2. The EUT was set up in the thermal chamber and connected with the system simulator. 3. With power OFF, the temperature was decreased to -30°C and the EUT was stabilized before testing. Power was applied and the maximum change in frequency was recorded within one minute. 4. With power OFF, the temperature was raised in 10°C steps up to 50°C. The EUT was stabilized at each step for at least half an hour. Power was applied and the maximum frequency change was recorded within one minute. <p>Test Procedures for Voltage Variation</p> <ol style="list-style-type: none"> 1. The testing follows FCC KDB 971168 D01v03r01 Section 9.0. 2. The EUT was placed in a temperature chamber at $25\pm 5^{\circ}\text{C}$ and connected with the system simulator. 3. The power supply voltage to the EUT was varied from BEP to 115% of the nominal value measured at the input to the EUT. 4. The variation in frequency was measured for the worst case.
Test Result:	PASS
Remark:	All three channels of all modulations have been tested, but only the worst channel and the worst modulation show in this test item.

6.7.2. Test Instruments

Equipment	Manufacturer	Model	Serial Number	Calibration Due
System simulator	R&S	CMU200	111382	Sep. 20, 2019
Programable tempratuce and humidity chamber	JQ	JQ-2000	N/A	Sep. 16, 2019
DC power supply	Kingrang	KR3005K	N/A	Sep. 16, 2019
RF cable (9kHz-40GHz)	TCT	RE-04	N/A	Sep. 20, 2019
Antenna Connector	TCT	RFC-03	N/A	Sep. 20, 2019

Note: The calibration interval of the above test instruments is 12 months and the calibrations are traceable to international system unit (SI).

6.7.3. Test Data

Test Result of Temperature Variation

Band :	GSM 850	Channel:	190
Limit (ppm) :	2.5	Frequency:	836.6MHz
Temperature (°C)	Deviation (ppm)		Result
50	0.010		PASS
40	0.015		
30	0.017		
20	0.008		
10	0.013		
0	0.018		
-10	0.009		
-20	0.012		
-30	0.013		

Band :	GSM 1900	Channel:	661
Limit (ppm) :	Note	Frequency:	1880MHz
Temperature (°C)	Deviation (ppm)		Result
50	0.022		PASS
40	0.018		
30	0.015		
20	0.017		
10	0.018		
0	0.021		
-10	0.018		
-20	0.015		
-30	0.021		

Note: The frequency fundamental emissions stay within the authorized frequency block based on the frequency deviation measured is small.

Band :	WCDMA Band V	Channel:	4183
Limit (ppm) :	2.5ppm	Frequency:	836.6MHz
Temperature (°C)	RMC 12.2Kbps Deviation (ppm)		Result
50	0.017		PASS
40	0.015		
30	0.008		
20	0.010		
10	0.014		
0	0.013		
-10	0.018		
-20	0.013		
-30	0.012		

Band :	WCDMA Band IV	Channel:	1413
Limit (ppm) :	2.5ppm	Frequency:	1732.6
Temperature (°C)	RMC 12.2Kbps Deviation (ppm)		Result
50	0.013		PASS
40	0.015		
30	0.017		
20	0.011		
10	0.008		
0	0.012		
-10	0.011		
-20	0.014		
-30	0.015		

Band :	WCDMA Band II	Channel:	9400
Limit (ppm) :	Note	Frequency:	1880MHz
Temperature (°C)	RMC 12.2Kbps Deviation (ppm)		Result
50	0.014		PASS
40	0.021		
30	0.014		
20	0.019		
10	0.017		
0	0.025		
-10	0.018		
-20	0.019		
-30	0.020		

Note: The frequency fundamental emissions stay within the authorized frequency block based on the frequency deviation measured is small.

Test Result of Voltage Variation

Band & Channel	Mode	Voltage (Volt)	Deviation (ppm)	Limit (ppm)	Result
GSM 850 CH190	GSM	4.2	+0.019	2.5	PASS
		3.8	+0.012		
		BEP	+0.010		
GSM 1900 CH661	GSM	4.2	+0.021	(Note 3.)	
		3.8	+0.022		
		BEP	+0.017		
WCDMA Band IV CH1413	RMC 12.2Kbps	4.2	-0.009	2.5	
		3.8	-0.010		
		BEP	-0.014		
WCDMA Band V CH4182	RMC 12.2Kbps	4.2	-0.021	(Note 3.)	
		3.7	-0.018		
		BEP	-0.019		
WCDMA Band II CH9400	RMC 12.2Kbps	4.2	-0.014	(Note 3.)	
		3.7	-0.018		
		BEP	-0.020		

Note:

1. Normal Voltage = 3.7V.
2. Battery End Point (BEP) = 3.40 V.
3. The frequency fundamental emissions stay within the authorized frequency block based on the frequency deviation measured is small.

Appendix A: Photographs of Test Setup

Refer to the test report No. TCT190605E005

Appendix B: Photographs of EUT

Refer to the test report No. TCT190605E005

*******END OF REPORT*******