

S5C Elite

■ Camera Drone

FOR AGES
14+

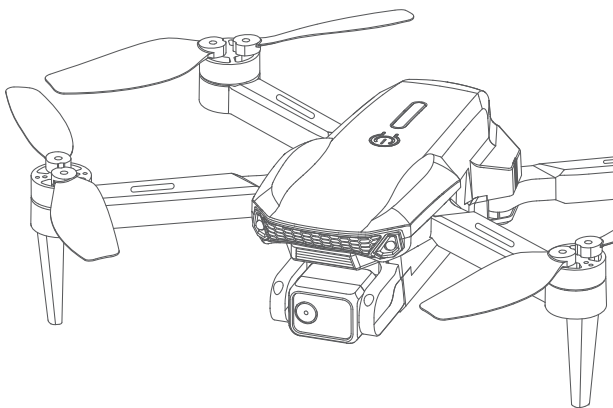

USER MANUAL

Please read this manual carefully before flying and keep it for future use.

V1.01

- For your safety, please follow the rules and safety guidelines whether you're a beginner or an expert at flying drones.
- According to the relevant laws and regulations in US, all drones must be registered, except those that weigh 0.55 pounds or less (less than 250 grams) and are flown exclusively under the Exception for Recreational Flyers. Please log in to the website of <https://faadronezone-access.faa.gov/#/> to complete the registration. The maximum take-off weight will be more than 249g if the drone is used with the Intelligent Flight Battery. Make sure to observe local laws and regulations about the take-off weight. If the buyer does not register timely, SNAPTAIN will not be responsible for any losses, penalties and injuries caused by illegal flights.
- To meet the electromagnetic requirements of aviation on the radio station, it is forbidden to fly drones within 6.21 miles(10km) on both sides of the runway centerline, or within 12.43 miles(20km) of both ends of the runway. It is also prohibited to fly a drone on the route of an airline. In the area that is prohibited by the relevant authority or department of your country, stop using all flying models and unmanned quadrotors.
- Please download the B4UFLY App from Google Play or App Store, which provides real-time information about airspace restrictions and other flying requirements based on your GPS location.
- Beginning September 16, 2023, all drone pilots who are required to register their UAS must operate in accordance with the rule on Remote ID.

ENGLISH



AIM HIGH FLY HIGH

Thank you for choosing our product and putting your trust in us.

Contact us via email at

support@snaptain.com or call us **(415)991-6646(Mon-Fri)**

if you have questions or concerns about the product.

We hope our products will make flying a whole new experience for you!

Please read the manual carefully for the best use of this product.

CONTENTS

FLY SAFELY	01
BATTERY SAFETY	02
WHAT'S INCLUDED	03
PRODUCT OVERVIEW	04
Drone	04
Remote	06
FIRST-TIME USE	07
Flight Preparation	07
Connect the SNAPTAIN FPV App with Your Drone	11
FUNCTION OVERVIEW	12
Flight Control	12
Functions	14
EXPLANATION OF DRONE' S LED INDICATORS	20
BEEPS EXPLANATION	21
SPECIFICATIONS	22
Drone	22
Camera	23
Remote	23

FLIGHT SAFETY

* Please fly the drone indoors or in a windless open area. The maximum flight height is limited to 164 ft (50 m), and the maximum flight distance is limited to 328 ft (100 m). Before your first flight, please read the **User Manual** and **Quick Guide** carefully. For detailed operations, refer to the **Flight Control** section.

1. For the safety of your property, keep the drone within your visual range during flight.
2. The drone is made of materials including metal, fiber, plastic, and electronic components. Avoid prolonged exposure to direct sunlight and keep them away from any heat sources. Excessive heat can cause deformation and damage.
3. The drone consists of various precision electronic and mechanical parts. Therefore, make sure that moisture and water do not enter the drone to prevent mechanical or electronic component failures that could lead to accidents.
4. The performance of the drone and battery can be affected by environmental factors such as air density and temperature. Exercise caution when flying at altitudes above 3281 ft (1000 m) above sea level, as the performance of the battery and drone may be reduced.
5. To avoid interference between the drone and other wireless devices, please turn off other wireless devices while using the drone.
6. Avoid flying in areas where magnetic or radio interference may occur, such as near Wi-Fi hotspots, routers, Bluetooth devices, high-voltage power lines, high-voltage power transmission stations, mobile base stations, or broadcast towers. Flying in areas where interference can disrupt communication between the drone and remote may adversely affect flight direction and positioning accuracy, possibly resulting in loss of control. Interference can also cause errors in the video downlink connection.

7. Be cautious around children. Avoid placing fingers in the rotating propellers.
8. Inside the packaging are small accessories. Do not swallow them. Seek immediate medical help if accidentally ingested.
9. Secure valuable items during indoor flights to prevent accidental damage due to operational errors.

BATTERY SAFETY

- RISK OF EXPLOSION BATTERY IS REPLACED BY AN INCORRECT TYPE
- DISPOSE OF USED BATTERIES ACCORDING TO THE INSTRUCTIONS
- BATTERY MUST BE RECYCLED OR DISPOSED OF PROPERLY
- Under no circumstances should the battery touch any liquids. Avoid using the battery in rainy or wet conditions, as it may catch fire or explode unexpectedly.
- It is not allowed to use batteries that are not provided by the manufacturer. Additionally, it is advisable to use the package-included USB charging cable for charging the batteries.
- Batteries that are swollen, leaking, or damaged are strictly forbidden.
- It is recommended to use the battery between -10°C and 40°C ; overheating may lead to a fire or explosion. A battery's performance can be adversely affected by extremely low temperatures.
- Do not insert or puncture the battery with any sharp object.
- Battery liquid is highly corrosive, so stay away if it leaks. If skin or eyes are contacted, rinse immediately with plenty of water and seek medical attention.
- Please keep the battery out of children's reach. Immediately seek medical attention if a child swallows parts.
- After being dropped or impacted, the battery should not be used again.

- Place the battery away from heat sources, such as a car in direct sunlight or on a hot day, a fire or a stove.
- To prevent a battery from entering an over-discharged state, avoid storing it for extended periods of time once it has been fully discharged. If a battery is over-discharged, the battery cell will be damaged and unable to be recharged.

WHAT'S INCLUDED



Drone x1

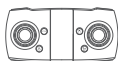

Remote x1



Battery x2

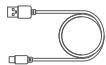

USB Cable for Charging x1



Spare Propellers
(A x4 B x4)



Screwdriver x1



Screws x10



Storage Bag x1



User Manual x1



Quick Guide x1

PRODUCT OVERVIEW

Drone

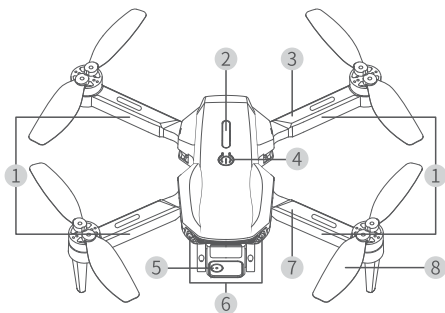

- | | | |
|----------------------|------------------------|-------------|
| 1 Arm LED Indicators | 4 Power Button | 7 Front Arm |
| 2 Top LED Indicator | 5 Camera | 8 Propeller |
| 3 Rear Arm | 6 Front LED Indicators | |

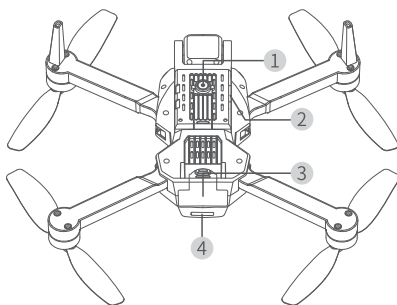

- | | |
|-----------------------|----------------------|
| 1 Optical Flow Sensor | 3 Battery |
| 2 Memory Card Slot | 4 Rear LED Indicator |

*Replace the Propeller (Optional)

The marks on the propellers (A/B) should match the marks on the drone arms when you replace the propellers.

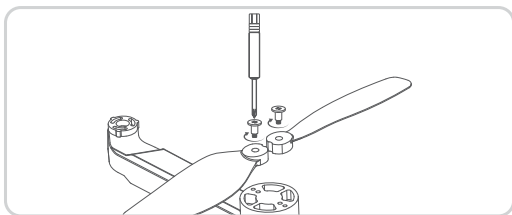
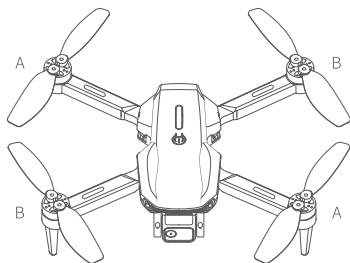

A propellers: Starting with letter A, like A1, A2, etc.



B propellers: Starting with letter B, like B1, B2, etc.

Remote

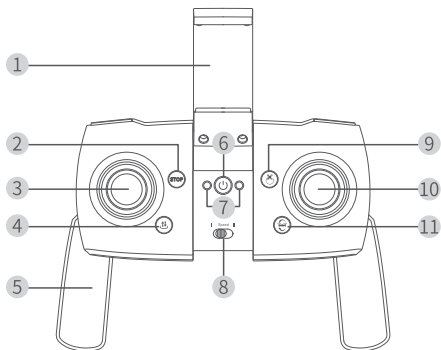

- | | |
|--------------------------------|------------------------|
| 1 Phone Holder | 7 Status Indicators |
| 2 Emergency Stop | 8 Speed Switch |
| 3 Left Control Stick | 9 Circle Fly |
| 4 One Key Take-off and Landing | 10 Right Control Stick |
| 5 Handle | 11 3D Flip |
| 6 Power Button | |

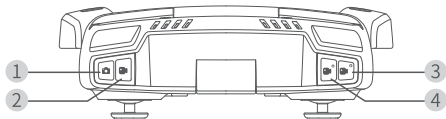

- | | |
|----------------|---------------|
| 1 Take Photo | 3 Camera Up |
| 2 Record Video | 4 Camera Down |

FIRST-TIME USE

Flight Preparation

1. The propellers and arms of the drone are folded for packaging purposes. Please unfold the front arms, then the rear arms.

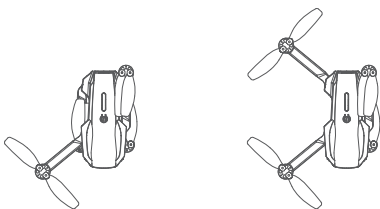

2. Charge the battery with the USB charging cable provided in the box. The cable can connect to a plug with a maximum output of 5V 3A.

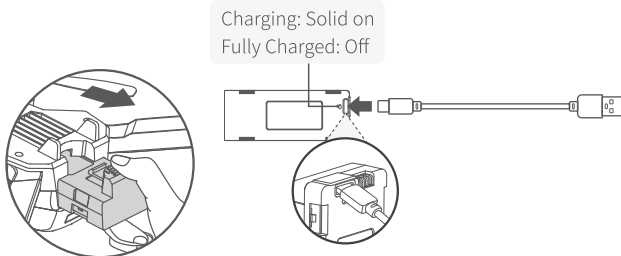

When the battery gets low, the rear and top LED indicators on the drone will flash quickly.

Notes

- ① It's not recommended to charge the battery using the USB port of a PC.
- ② Please note that when flying in low-temperature environments, the flight time of the drone may be reduced.

3. Install the battery into the drone after it's fully charged.

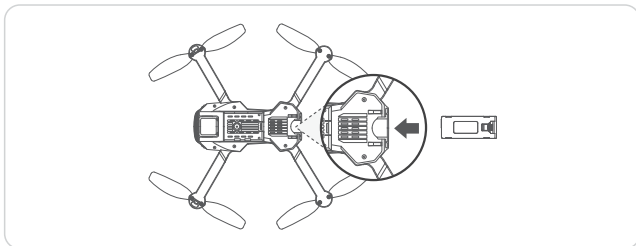

4. Insert a memory card into the drone. (Memory cards must be purchased separately. However, you can still use the drone's camera even if a memory card is not inserted, although the resulting videos and pictures may not be in high-definition quality.)

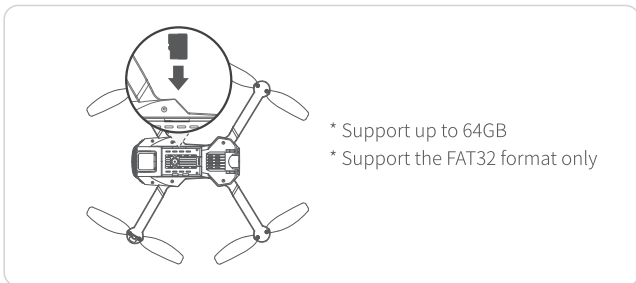

5. Insert 3 AAA batteries into the remote and tighten the screw.

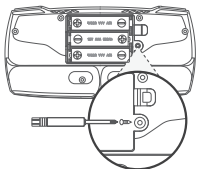

1.5V AAA Battery x3
(not included)

Loosen

Tighten

Low Battery:

The LED indicators on the remote flash alternatively at a slow pace.

6. Unfold the phone holder and handles. Then mount your mobile phone to the phone holder.

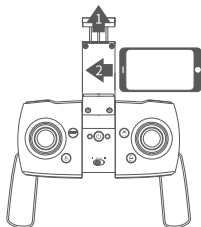
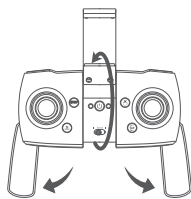

Note

The phone holder can accommodate smartphones with a width up to 3.15 inches (80.01mm).

7. Please remove the protective film on the lens before flying.

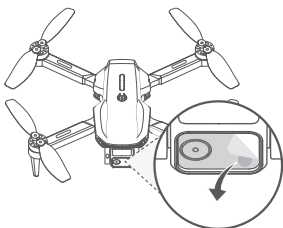

8. Place the drone on a flat and level surface, then press and hold the power button on the drone for 3s to power it on.

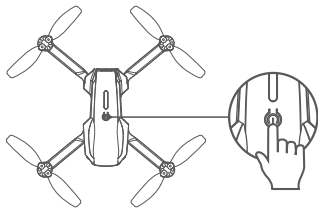

9. Press and hold the power button on the remote for 3s to power it on. The drone will automatically pair with the remote. If the pairing fails, please power off the remote and drone and then try again.

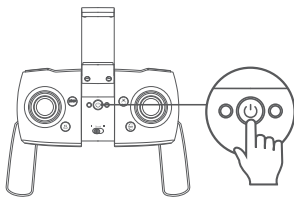

* **Pairing:** All arm LED indicators on the drone keep flashing quickly.

* **Successfully Paired:** All LED indicators on the drone turn solid on.

Connect the SNAPTAIN FPV App with Your Drone

Step 1:

Download and install SNAPTAIN FPV from Google Play™/App Store™ or scan the QR codes below.



For Android 8.0 and later



For iOS 8.0 and later

Step 2:

Simply navigate to the WiFi setting of your mobile phone and search for SNAPTAIN-S5C Elite-XXXXXX WiFi to connect.

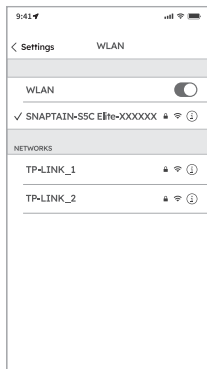

Step 3:

Launch the SNAPTAIN FPV app, then tap **FUNCTION DISPLAY** to enter the main page to see the live preview.

FUNCTION OVERVIEW

Flight Control

1. Take-off

Option 1:

Unlock the drone by simultaneously pushing the **Left Control Stick** to the lower right at 45° and the **Right Control Stick** to the lower left at 45° (or **Left Control Stick** to the lower left and **Right Control Stick** to the lower right) until the propellers start rotating. Then, push the **Left Control Stick** forward.

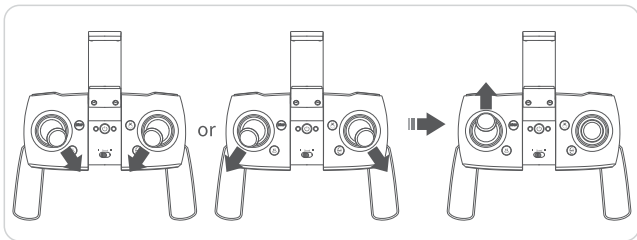

Option 2:

Press and hold the **One Key Take-off** button for 1s.

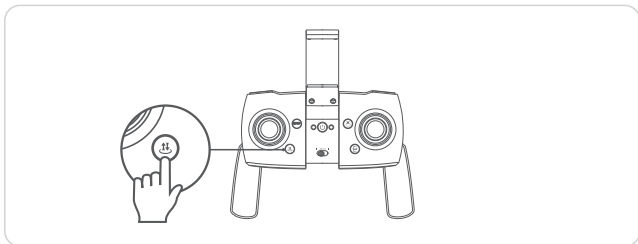

Tip:

Before taking off, ensure the drone is on a level surface and the surrounding area is obstacle-free.

2. Flight Directions

The default remote mode is Mode 1 (used for manual illustration). To switch the remote mode: with the remote turned off, press and hold the **Take Photo** button; while holding the **Take Photo** button, press and hold the **Power** button for 3s until the remote is turned on.

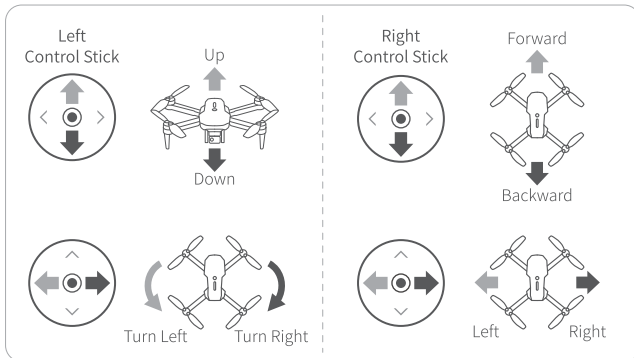
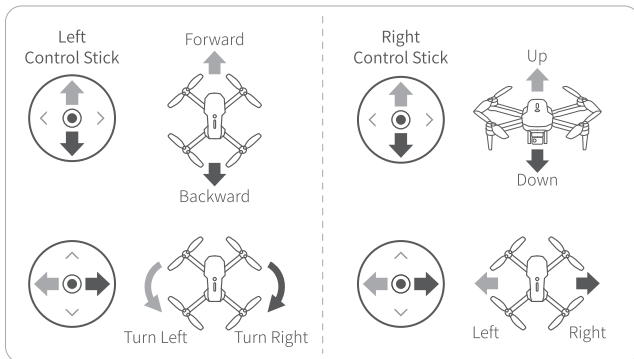
Mode 1Mode 2

Functions

One Key Take-off and Landing

* Take-off: Place the drone on a flat and level surface without any obstacles then press and hold the  button for 1s to make it ascend and hover at a height of 3.9ft (1.2m).

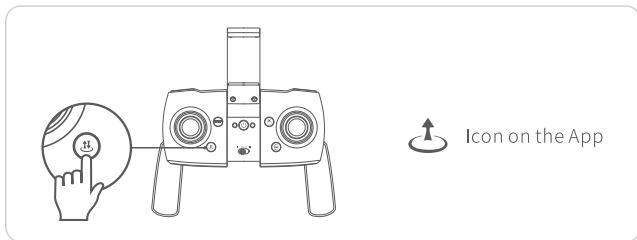

* Land: When the drone hovers in the air without any obstacles, press and hold the  button for 1s to make it descend and land until the propellers stop rotating.

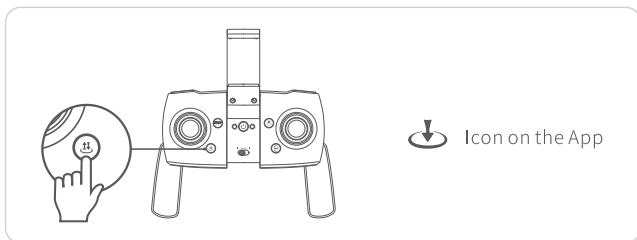

Circle Fly

If there are no obstacles within a radius of 5 meters (recommended) around the drone, press the  button on the remote to make the drone fly in a circular pattern.

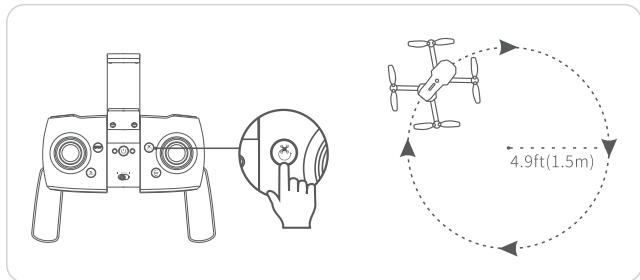

Press the  button again to disable this function.

To perform this function, the drone must have enough power.

Trajectory Flight

- ① Open the app and navigate to the main page.
- ② Tap on the "  " (Trajectory Flight) icon and adjust the scale by sliding the scale bar. The default scale is set to 1:1.
- ③ Use your finger to draw a desired flight path on the blank area of the screen.
- ④ The drone will follow the trajectory path without changing its flight height, but the length of the trajectory will vary based on the selected scale.

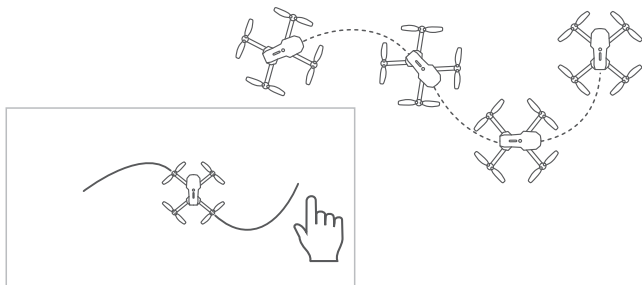

3D Flip

After flying the drone in an obstacle-free area, press the  button to activate the 360° flip function, and then use the **Right Control Stick** to perform flips. Push the stick forward, backward, leftward, or rightward to execute a 360° flip in the corresponding direction. If no flip operation is executed within 10s after activating the function, the drone will automatically exit standby mode.

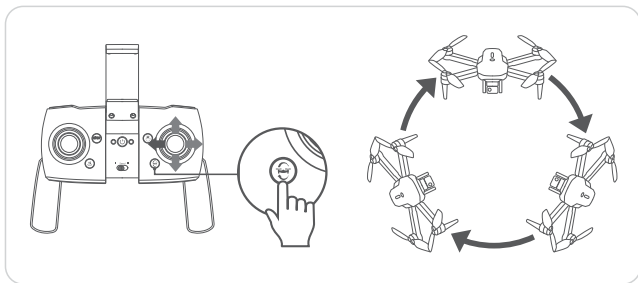

To perform this function, the drone must have enough power.

Emergency Stop

If an abnormal situation occurs, you can press and hold the **STOP** button on the remote for 3s to make an emergency stop. When this function is activated, the drone's motor and propellers will stop rotating, causing it to fall from the sky and potentially pose risks of damage. Use this function with caution.

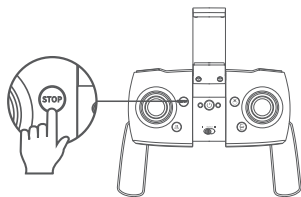



Please make an emergency stop when the drone's flight height is below 9.8ft (3m). If the drone's flight height is above 9.8ft (3m), carefully descend it to a height below 9.8ft (3m) before performing the emergency stop. After an emergency stop, if you intend to fly the drone again, please restart both the drone and the remote control.

Note

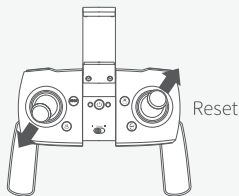
After an emergency stop, if you intend to fly the drone again, please reset the drone.





Find Your Drone

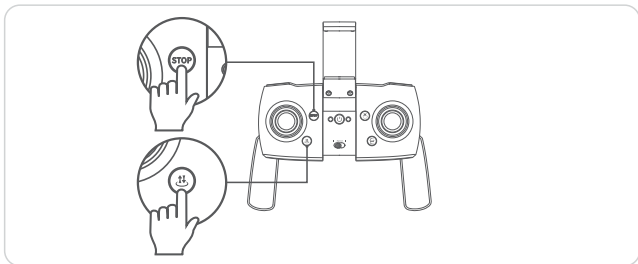

When the drone is accidentally lost during flight, simultaneously press and hold the  and  buttons on the remote for 3s to try to locate it. In response, the drone will emit rapid beeps and the LED indicators will keep flashing rapidly. To exit this state, you can either repeat the above operation or briefly press the  button on the drone.





To perform this function, the drone must be connected to the remote and have enough power.

Camera

Take Photos: Press the button  on the remote or tap  on the app to take a photo. The photo will be saved both on your mobile phone and the memory card.

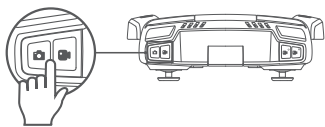
Record Videos: Press the button  on the remote or tap  on the app to start recording a video. Press the same button or tap the same icon on the app again to stop recording. The video will be saved both on your mobile phone and the memory card. (Please note that the drone cannot capture photos while it is recording a video.)



 Take Photo

 Record Video

ICON ON APP

To adjust the camera tilt angle, press the **Camera Up** and **Camera Down** buttons on the remote. The adjustment range is from 0° to 90°.

Note

Please pay attention to the remaining capacity on your memory card when taking photos or recording videos to avoid storage failures.

Speed Switch

Slide the switch toggle to the left for a slower speed or to the right for a faster speed.

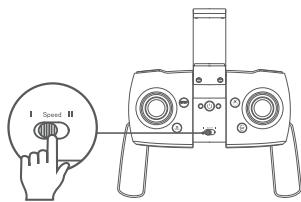

EXPLANATION OF DRONE' S LED INDICATORS

Status	Front LED Indicators (White)	Rear & Top LED Indicators (Blue)	Arm LED Indicators (Front: blue; Rear: red)
Powering on	Light up	Light up	Light up
Pairing	Solid on	Solid on	Flash quickly
Ready to fly / During flight	Solid on	Solid on	Solid on
Reset	Flash quickly	Solid on	Off (light up after successful reset)
Fail to execute commands	Flash once	Solid on	Flash once
Emergency Stop	Flash quickly and continuously	Solid on	Flash quickly and continuously
Low Battery	Solid on	Flash quickly and continuously	Solid on
Powered off	Off	Off	Off
Find Your Drone	Flash three times in a loop	Flash three times in a loop	Flash three times in a loop

BEEPS EXPLANATION

Status	Beep(s)
Powering on the drone	On/off sound
Powering on the remote	1 short beep
Powering off the drone	On/off sound
Powering off the remote	2 short beeps
Command executed successfully	1 short beep
Error	2 short beeps
Emergency Stop	6 short beeps
Low Battery	2 short beeps every 2s
Find Your Drone	Repeated on/off sounds

SPECIFICATIONS

Drone

Model	DR-STE51B
Weight(with battery installed)	≈145g
Max. Flight Time	15 minutes
Operating Temperature	32°F-104°F
Dimensions	7.21*6.25*2.13 inches
Horizontal Flight Speed (no wind)	Slow: 9.84 ft/s (3m/s) Fast: 16.4 ft/s (5m/s)
Max. Relative Flight Height	164 ft (50m)
Max. Flight Distance	328 ft (100m)
Battery Capacity	3.7V 1200mAh Lithium Battery
Charging Time	≈160 minutes (depending on the power of the charger)
Input Voltage	5V

Camera

FOV	≈70°
Photo Resolution	1920x1080 Pixels
Video Resolution	1920x1080 Pixels @25fps
Operating Frequency	2412-2462MHz
Protocol Supported	802.11 b/g/n

Remote

Operating Frequency	2440MHz to 2475MHz
Max. Operating Distance	328ft (100m)
Battery Capacity	1.5V AAA Battery x 3 (not included)
Applicable Mobile Phone Size	Up to 3.15 inches
Operating Temperature	32°F-104°F

FCC Caution:

Any Changes or modifications not expressly approved by the party responsible for compliance could void the user's authority to operate the equipment.

This device complies with part 15 of the FCC Rules. Operation is subject to the following two conditions:

(1) This device may not cause harmful interference, and (2) this device must accept any interference received, including interference that may cause undesired operation.

Note: This equipment has been tested and found to comply with the limits for a Class B digital device, pursuant to part 15 of the FCC Rules. These limits are designed to provide reasonable protection against harmful interference in a residential installation.

This equipment generates, uses and can radiate radio frequency energy and, if not installed and used in accordance with the instructions, may cause harmful interference to radio communications. However, there is no guarantee that interference will not occur in a particular installation. If this equipment does cause harmful interference to radio or television reception, which can be determined by turning the equipment off and on, the user is encouraged to try to correct the interference by one or more of the following measures:

- Reorient or relocate the receiving antenna.
- Increase the separation between the equipment and receiver.
- Connect the equipment into an outlet on a circuit different from that to which the receiver is connected.
- Consult the dealer or an experienced radio/TV technician for help.

For Remote:

This equipment complies with FCC radiation exposure limits set forth for an uncontrolled environment.

For R/C QUADCOPTER:

This equipment complies with FCC radiation exposure limits set forth for an uncontrolled environment.

This equipment should be installed and operated with minimum distance 20cm between the radiator& your body.

This transmitter must not be co-located or operating in conjunction with any other antenna or transmitter.