

**SNAPTAIN** 

---

# SP650

4-AXIS DRONE

---

INSTRUCTIONS

V6.04

**14<sup>+</sup>**  
FOR AGES

## DISCLAIMER AND SAFETY GUIDELINES

---

1. DO NOT look directly into the drone light.
2. DO NOT treat the product as household waste.
3. DO NOT fly above or near obstacles, crowds, open water, public road, high voltage power lines or trees.
4. DO NOT use the drone in severe weather conditions. These include wind, snow, rain, smog, hail, lightning, tornadoes or hurricanes.
5. Stay away from the rotating propellers and motors to avoid some tiny objects (e.g. hair) to get into them.
6. This product is not a toy and is not recommended for users under age 14.
7. Please maintain line of sight of your drone at all times. Please do not only rely on first person view camera to control your drone.
8. This drone does not come with a GPS module. Please fly the drone within the control range.
9. This product is not applicable to the professional aerial drone photography.
10. Be sure to observe all local regulations, obtain appropriate authorizations and understand risks. Please note it is solely your responsibility to comply with all flight regulations.

SNAPTAIN accepts no liability for damage, injury or any legal responsibility incurred directly or indirectly from the use of this product. The user shall observe safe and lawful practices including, but not limited to, those set forth in these Safety Guidelines. SNAPTAIN reserves the right to update this user manual.

## MAINTENANCE AND CARE

---

1. Thoroughly check the drone after crash or violent impact.
2. Do not charge battery before it cools down.
3. Remove the batteries if the products will not be in use for a long time.
4. Do not over charge the battery. Unplug the charger once it's fully charged.
5. Store the drone and remote in a cool, dry place away from direct sunlight.
6. Avoid direct contact of the camera with water or other liquids. Wipe dry with a soft absorbent cloth if it gets wet.
7. Do not charge the battery next to inflammables, such as carpet, timber floor etc., or on the surface of electro-conductive objects. Please always keep an eye on the battery while charging.

8. Please use the original battery provided. Use an incorrect type of battery may lead to fire hazards.
9. Do not dispose of the battery in fire or a hot oven, cut or mechanically crush the battery, as this may cause explosions.
10. Do not leave the battery in an extremely high-temperature environment that can result in an explosion or the leakage of flammable liquid or gas.
11. Do not expose the battery to the extremely low air pressure, as this may result in an explosion or the leakage of flammable liquid or gas.

## PRODUCT OVERVIEW

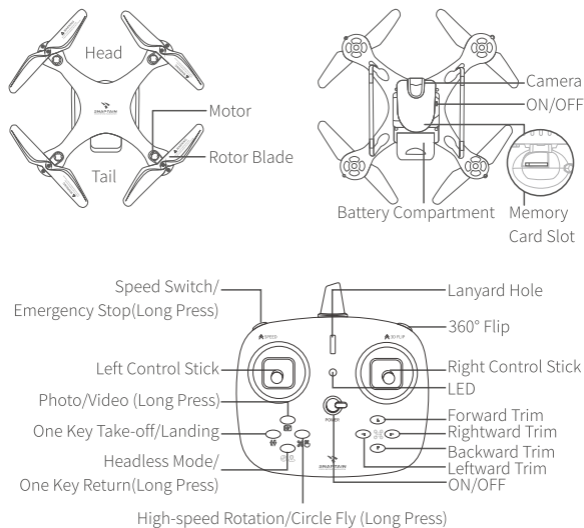

# FLIGHT PREPARATION

1. Install the remote batteries.

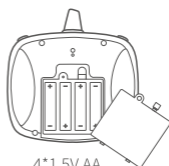
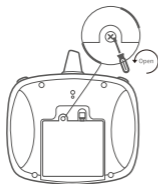

4\*1.5V AA  
(batteries not included)

Make sure the batteries have enough power.

2. Install the landing skids to the bottom of the drone, then tighten the screws.

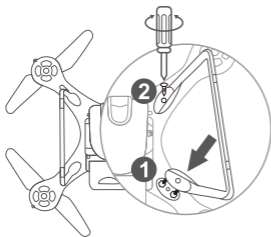

3. Install the propeller protectors into the drone, then tighten the screws.



4. Install the drone battery after it's fully charged.



Charging: Red LED  
Fully Charged: Green LED

## FLIGHT PREPARATION

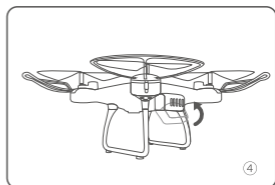
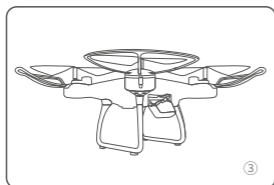
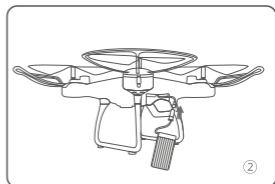
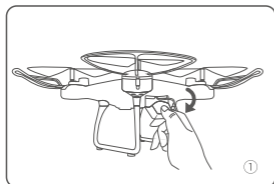

### Tips:

1. For your safety, please use the original battery and USB cable.
2. Flight time of the battery may be reduced when flying in cold weather.
3. Free the battery of any sharp objects that could puncture into the battery to avoid risks of explosion and fire.
4. There is continuous beeping sound from the remote when the battery of the drone is low during flight.
5. To extend the battery's lifespan, recharge it at least once every three months if not using it for long periods of time.

## FLIGHT OPERATION GUIDE

### Fly the Drone with the Remote

#### Important:

- \*Make sure you power on the drone first, then the remote in each flight.
- \*Do repeat the pairing procedure each time when the drone or remote is restarted.
- \*For all flight functions and modes, the operator and tail of the drone must be aligned.
- \*Fly the drone in the open air after you have a plenty of experience.

# FLIGHT OPERATION GUIDE

## Pair the Remote with the Drone

### Step 1:

Turn on the drone, then the remote. LEDs on the drone start to flash, then put the drone on a flat surface with the head forward.

### Step 2:

Push the **Left Control Stick** forward to the top, then pull it backward till the bottom. Pairing is successful when the LEDs on the drone turn to solid on from quick flash.

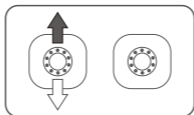

## Flight Calibration

Move both control sticks to lower right in 45° and hold for 2-3 sec after the pairing. The calibration completes when the LEDs on the drone turn to solid on from quick flash.

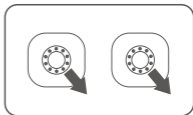



## Instructions of the Remote

### Left Control Stick

|  |  |  |
|--|--|--|
|  |  | <p>Push the Left Control Stick forward and the drone will ascend; pull it backward and the drone will descend.</p>                           |
|  |  | <p>Pull the Left Control Stick leftward and the drone will rotate to the left; pull it rightward and the drone will rotate to the right.</p> |

# FLIGHT OPERATION GUIDE

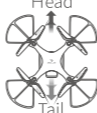

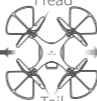

## Right Control Stick

|   |   |   |
|---|---|---|
|  |  | <p>Push the Right Control Stick forward and the drone will fly forward; pull it backward and the drone will fly backward.</p>     |
|  |  | <p>Pull the Right Control Stick leftward and the drone will fly leftward; pull it rightward and the drone will fly rightward.</p> |

## Altitude Hold/Hover

This is one of the default settings in the drone. When you release the **Left Control Stick** after the ascending/descending action, the drone will hover at the current flight height. For a stable flight, press the trim buttons to adjust accordingly.

## Flight Trimming

|   |   |   |
|---|---|---|
|   |   | <p>If the drone drifts forward or backward when hovering, slightly press the Backward Trim button or the Forward Trim button to adjust.</p>     |
|  |  | <p>If the drone drifts leftward or rightward when hovering, slightly press the Rightward Trim button or the Leftward Trim button to adjust.</p> |

# FLIGHT OPERATION GUIDE

## Take-off

**Option 1:** Press the  button to take off.

**Option 2:** Move the **Left Control Stick** to lower left in 45° and the **Right Control Stick** to lower right in 45° at the same time until four rotor blades start rotating, then slowly push the **Left Control Stick** forward to take off.

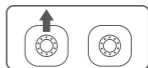
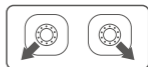

## Landing

**Option 1:** Press the  button to land during the flight.

**Option 2:** Pull the **Left Control Stick** backward to the bottom to land the drone, and hold it for 3s at least until all the rotor blades stop rotating.

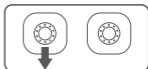

## 360° Flip

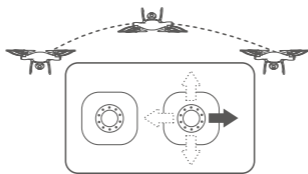

Fly the drone to a height over 2 meters, press the **360° Flip** button and move the **Right Control Stick** forward/backward/leftward/rightward to flip the drone 360° accordingly.







## FLIGHT OPERATION GUIDE

### One Key Return & Headless Mode

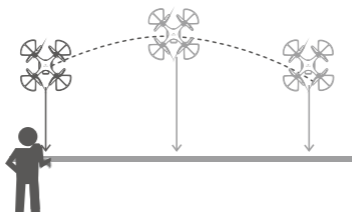
Long press the /  button, the drone will fly toward its back following a path that parallels with its original take-off path. Long press the button again or push the **Right Control Stick** forward to cancel **One Key Return** mode.



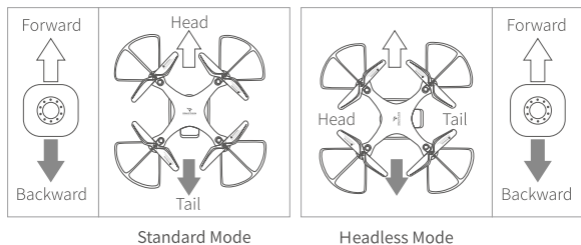

Press the /  button to activate the **Headless Mode**. In this mode, the drone will fly following the direction of the **Right Control Stick** regardless of the position of your drone's head or tail. Press the same button again to exit **Headless Mode**.



## FLIGHT OPERATION GUIDE

### High-speed Rotation & Circle Fly

Press the  button to rotate the drone with high speed. Press the button again or move the **Right Control Stick** to any direction to exit the **High-speed Rotation** mode.

In the case of barrier-free within 5M radius around the drone, long press the  button to make the drone flying in circles; long press the button again or move the **Right Control Stick** to any direction to exit the **Circle Fly** mode.

### Speed Switch

The drone is set to low speed by default. Press the **Speed Switch** button once for medium speed, press again for high speed; a third press will get back to low speed.

### Fly the Drone with the App

#### App Download and Installation

Download and install **Snaptain Nova** into your mobile device from **App store/Google Play** or by scanning the QR code below.



For Android 4.6 and later





For iOS 8.0 and later

# FLIGHT OPERATION GUIDE

---

## Pair the Drone with the App



1. Power on the drone and the LEDs will flash.
2. Go to the Wifi setting of the mobile device and connect to the Wifi **Snaptain-SP650-xxxxxx**.
3. Open **Snaptain Nova** App, select **SP650** and tap **Start**, then tap **ON/OFF** button to **ON**. LEDs on the drone turn solid on after a successful pairing.
4. Tap , then tap  to calibrate the drone.

### Notes:

1. If the **Snaptain-SP650-xxxxxx** Wifi is not listed in your Wifi list or the App does not show the preview image, restart the drone.
2. Make sure the **Snaptain-SP650-xxxxxx** Wifi is only connected to one mobile device.
3. The drone's Wifi has no Internet access. Please turn off cellular data to prevent your mobile device from automatically switching to cellular data and disconnecting with the drone's Wifi.

# FLIGHT OPERATION GUIDE

## Function Overview of the App

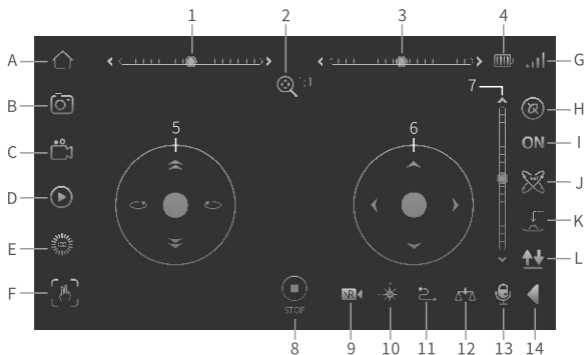

A. Home

B. Photo

C. Video

D. Media Gallery

E. Speed Switch

F. Gestures for Photo/Video

1. Trim Clockwise/Anticlockwise

2. Scale (available only after tapping )

3. Trim Leftward /Rightward

4. Battery Status

5. Turn Left/Turn Right/Ascend/Descend

6. Forward/Backward/Leftward/Rightward

7. Trim Forward/Backward

G. Wifi Signal

H. G-Sensor

I. App ON/OFF

J. 360° Flip

K. One Key Return

L. One Key Take-off/Landing

8. Emergency Stop

9. VR Mode

10. Headless Mode













11. Trajectory Flight

12. Calibrate

13. Voice Control

14. More

## FLIGHT OPERATION GUIDE

- \* **Photo:** Tap  once to take one photo.
- \* **Video:** Tap  once to start recording, tap again to end and save the video.
- \* **Media Gallery:** Tap  to check the photos and videos saved to the mobile device.
- \* **Gestures for Photo/Video:** Tap  to activate this function. When you face the camera and make a  gesture within a distance of 2-3M between you and the camera, the camera takes one photo; when you make a  gesture, the camera starts recording; when you make a  gesture again, the camera ends recording and saves the video.
- \* **Battery Status:** check the battery status of the drone.
- \* **Wifi Signal:** check the Wifi signal strength of the drone to avoid losing control. When it drops to 1 of 4 bars(  ), please fly the drone back immediately.
- \* **G-Sensor Mode:** Tap  to activate this mode. The drone will fly following the inclines of your mobile device in its landscape orientation.
- \* **More:** Tap  to hide or display icons from 9 to 13.
- \* **VR Mode:** VR device (not included) is required to activate VR Mode.
- \* **Trajectory Flight:** Tap  to activate the **Trajectory Flight** mode. Draw a path in the blank area on the screen and the drone will fly following the path. Tap  to modify flight distance and time accordingly. Tap  again to exit this mode.



- \* **Calibrate:** Tap  to calibrate the drone directly.
- \* **Voice Control:** Forward, Backward, Left, Right, Take off, Land and Stop.

Please refer to the instructions of the remote for the other functions.

### Notes:

1. To fly the drone with the remote while see the image through your mobile device in the App operation mode, tap the ON/OFF icon to turn off the App, then pair the drone and remote.
2. Please turn off the remote when using the App to fly the drone.

## LED INDICATORS DESCRIPTION

| Drone Status        | Red LED   | Green LED   |
|---------------------|---|---|
| Uncontrol/Unlink    | Flash slowly  | Flash slowly  |
| Linked              | Solid   | Solid   |
| Photo               | Solid   | Flash once when taking one photo                    |
| Video               | Solid   | Recording: Flash slowly<br>End the recording: Solid |
| Headless Mode       | Solid   | Flash quickly                                       |
| Calibration         | Calibrating: Flash quickly<br>Calibrated: Solid                         | Calibrating: Flash quickly<br>Calibrated: Solid     |
| Low Battery Warning | Flash quickly   | Flash quickly                                       |
| One Key Return      | Returning: the Red and Green LED flash alternatively<br>Returned: Solid |   |

## TROUBLESHOOTING GUIDE

### Q1. How to avoid losing my drone?

- \* Make sure the distance between the drone and the remote/App is effective.
- \* We recommend flying the drone on windless days. If you insist on flying the drone in the wind, we recommend flying at HIGH speed.
- \* It's essential to calibrate the drone before flying.

### Q2. Drone LEDs do not light up.

- \* Press power button on the drone.
- \* Replace or charge your drone battery.
- \* Make sure the connectors of the battery are plugged in firmly.

## TROUBLESHOOTING GUIDE

---

**Q3. Drone LEDs keep flashing, but the drone never responds to any command from the remote.**

- \* Pair the drone and remote again.
- \* Replace or charge the battery of drone.
- \* Make sure the batteries of the remote have enough power.

**Q4. The flight is not stable.**

- \* Return the drone and restart to do a flight calibration as instructed.
- \* Make the flight trimming accordingly.
- \* Fly the drone when the weather is good.

**Q5. The response from the drone to the control is not sensitive.**

- \* Make sure the distance between the drone and the remote is effective.
- \* Turn off the remote, and the drone will automatically land. Use the App to fly the drone. If the drone is responsive to the control of the App, then the remote may be defective. Please contact us for help.

**Q6. Connection between the drone and the App is frequently lost.**

- \* Make sure the distance between the drone and the mobile device is effective.
- \* Make sure your mobile device is not connected to another network.

**Q7. The App doesn't respond to voice commands.**

- \* Ensure the drone App has access to the audio function of your mobile device.

**Q8. Some of the functions don't work in the App.**

- \* Make sure the switch for the App is ON.

**Q9. The drone will fly beyond the control range.**

- \* Activate the **Headless Mode**, then move the **Right Control Stick** to fly the drone back.

**Q10. Replace the rotor blades.**

- \* The rotor blades and motors are marked A and B. Please pair them when replacing the rotor blades.

## FCC Caution

Any Changes or modifications not expressly approved by the party responsible for compliance could void the user's authority to operate the equipment. This device complies with part 15 of the FCC Rules. Operation is subject to the following two conditions: (1) This device may not cause harmful interference, and (2) this device must accept any interference received, including interference that may cause undesired operation.

### NOTE:

This equipment has been tested and found to comply with the limits for a Class B digital device, pursuant to part 15 of the FCC Rules. These limits are designed to provide reasonable protection against harmful interference in a residential installation. This equipment generates, uses and can radiate radio frequency energy and, if not installed and used in accordance with the instructions, may cause harmful interference to radio communications. However, there is no guarantee that interference will not occur in a particular installation. If this equipment does cause harmful interference to radio or television reception, which can be determined by turning the equipment off and on, the user is encouraged to try to correct the interference by one or more of the following measures:

- Reorient or relocate the receiving antenna.
- Increase the separation between the equipment and receiver.
- Connect the equipment into an outlet on a circuit different from that to which the receiver is connected.
- Consult the dealer or an experienced radio/TV technician for help.

### For R/C QUADCOPTER

This equipment complies with FCC radiation exposure limits set forth for an uncontrolled environment . This equipment should be installed and operated with minimum distance 20cm between the radiator& your body.

This transmitter must not be co-located or operating in conjunction with any other antenna or transmitter.

## ISED Warning

This device complies with Industry Canada licence-exempt RSS standard(s). Operation is subject to the following two conditions:

- (1) this device may not cause interference, and
- (2) this device must accept any interference, including interference that may cause undesired operation of the device.

Le présent appareil est conforme aux CNR d'Industrie Canada applicables aux appareils radio exempts de licence. L'exploitation est autorisée aux deux conditions suivantes:

- (1) l'appareil ne doit pas produire de brouillage, et
- (2) l'utilisateur de l'appareil doit accepter tout brouillage radioélectrique subi, même si le brouillage est susceptible d'en compromettre le fonctionnement.



## For R/C QUADCOPTER

The device is compliance with RF exposure guidelines, users can obtain Canadian information on RF exposure and compliance. The minimum distance from body to use the device is 20cm.

Le présent appareil est conforme

Après examen de ce matériel aux conformité ou aux limites d'intensité de champ RF, les utilisateurs peuvent sur l'exposition aux radiofréquences et la conformité and compliance d'acquérir les informations correspondantes. La distance minimale du corps à utiliser le dispositif est de 20cm.

## CAUTION

RISK OF EXPLOSION IF BATTERY IS REPLACED BY AN INCORRECT TYPE  
DISPOSE OF USED BATTERIES ACCORDING TO THE INSTRUCTIONS

 The symbol indicates DC voltage

 RECYCLING

This product bears the selective sorting symbol for Waste electrical and electronic equipment (WEEE). This means that this product must be handled pursuant to European directive 2012/19/EU in order to be recycled or dismantled to minimize its impact on the environment.

User has the choice to give his product to a competent recycling organization or to the retailer when he buys a new electrical or electronic equipment. This product can be used across EU member states.

 BATTERY MUST BE RECYCLED OR DISPOSED OF PROPERLY

 Refer to the user manual and relevant text.

 Operate the product according to the instructions.

## Manufacturer

Shenzhen VanTop Technology & Innovation Co., Ltd.

Manufacturer address:

502, 5th Flr. BLDG 4, MinQi Technology Park, No. 65 Lishan Road, Taoyuan Street, Nanshan District, Shenzhen, China

EC REP

BellaCocool GmbH  
Pettenkofenstraße 18, 10247,  
Berlin, Germany  
info@bellacocool.de

## SNAPTAIN SUPPORT

US [support@snaptain.com](mailto:support@snaptain.com)

CA [support@snaptain.com](mailto:support@snaptain.com)

UK [support.uk@snaptain.com](mailto:support.uk@snaptain.com)



[www.snaptain.com](http://www.snaptain.com)



[@snaptainofficial](https://www.facebook.com/snaptainofficial)



[@snaptain\\_official](https://www.instagram.com/snaptain_official)