

# Test Report

FCC ID: 2AQ2W-Q96

Date of issue: Aug. 31, 2018

Report Number: MTi180830E134

Sample Description: WIRELESS CHARGER

Model(s): Q96

Applicant: Shenzhen Doageas Technology Co., Ltd.

Address: 5/F, 4th Bldg, Hedian Industrial Park, Guanlan, Longhua,  
Shenzhen, Guangdong 518110, China.

Date of Test: Aug. 17, 2018 – Aug. 31, 2018

**Shenzhen Microtest Co., Ltd.**  
<http://www.mtitest.com>

## Table of Contents

<b>1</b>	<b>GENERAL INFORMATION .....</b>	<b>4</b>
1.1	FEATURE OF EQUIPMENT UNDER TEST (EUT).....	4
1.2	TEST MODE .....	4
1.3	EUT TEST SETUP.....	4
1.4	ANCILLARY EQUIPMENT .....	4
1.5	MEASUREMENT UNCERTAINTY .....	4
<b>2</b>	<b>SUMMARY OF TEST RESULT .....</b>	<b>5</b>
2.1	OPERATION CHANNEL LIST .....	5
2.2	TEST CHANNEL .....	5
<b>3</b>	<b>TEST FACILITIES AND ACCREDITATIONS .....</b>	<b>6</b>
3.1	TEST LABORATORY .....	6
3.2	ENVIRONMENTAL CONDITIONS .....	6
3.3	MEASUREMENT UNCERTAINTY.....	6
3.4	TEST SOFTWARE .....	6
<b>4</b>	<b>LIST OF TEST EQUIPMENT .....</b>	<b>7</b>
<b>5</b>	<b>TEST RESULTS.....</b>	<b>8</b>
5.1	ANTENNA REQUIREMENT .....	8
5.1.1	<i>Standard requirement</i> .....	8
5.1.2	<i>EUT Antenna</i> .....	8
5.2	CONDUCTED EMISSION .....	9
5.2.1	<i>Limits</i> .....	9
5.2.2	<i>Test Procedures</i> .....	9
5.2.3	<i>Test Setup</i> .....	9
5.2.4	<i>Test Result</i> .....	9
5.3	RADIATED EMISSION.....	14
5.3.1	<i>Limits</i> .....	14
5.3.2	<i>Test Procedures</i> .....	15
5.3.3	<i>Test Setup</i> .....	16
5.3.4	<i>Test Result</i> .....	16
5.4	OCCUPIED BANDWIDTH.....	21
5.4.1	<i>Test method</i> .....	21
5.4.2	<i>Test result</i> .....	21
	<b>PHOTOGRAPHS OF THE TEST SETUP.....</b>	<b>22</b>
	<b>PHOTOGRAPHS OF THE EUT.....</b>	<b>24</b>

## Test Result Certification

Applicant's name: Shenzhen Doageas Technology Co., Ltd.

Address: 5/F, 4th Bldg, Hedian Industrial Park, Guanlan, Longhua, Shenzhen, Guangdong 518110, China.

Manufacture's name: Shenzhen Doageas Technology Co., Ltd.

Address: 5/F, 4th Bldg, Hedian Industrial Park, Guanlan, Longhua, Shenzhen, Guangdong 518110, China.

Product name: WIRELESS CHARGER

Trademark: DGLS

Model name: Q96

Standards: FCC Part 15C

Test Procedure: ANSI C63.10-2013

*This device described above has been tested by Shenzhen Microtest Co., Ltd. and the test results show that the equipment under test (EUT) is in compliance with the FCC requirements. And it is applicable only to the tested sample identified in the report.*

Tested by:



Demi Mu

Aug. 31, 2018

Reviewed by:



Blue Zheng

Aug. 31, 2018

Approved by:



Smith Chen

Aug. 31, 2018

## 1 GENERAL INFORMATION

### 1.1 Feature of equipment under test (EUT)

Product name:	WIRELESS CHARGER
Model name:	Q96
Operation frequency:	115–205 kHz
Modulation type:	Load modulation
Antenna type:	Coil Antenna
Power supply:	DC 5V from adapter
Battery:	N/A
Adapter information:	N/A
Model difference:	N/A

### 1.2 Test mode

To investigate the maximum EMI emission characteristics generates from EUT, the test system was pre-scanning tested base on the consideration of following EUT operation mode or test configuration mode which possible have effect on EMI emission level. Each of these EUT operation mode(s) or test configuration mode(s) mentioned above was evaluated respectively.

Test mode	Description
Mode 1	Charging

Note: The test modes were carried out for all operation modes. The final test mode of the EUT was the worst test mode for EMI, and its test data was showed.

### 1.3 EUT test setup

See photographs of the test setup in the report for the actual setup and connections between EUT and support equipment.

### 1.4 Ancillary equipment

Equipment	Model	S/N	Manufacturer
Adapter	HW-050100E01	/	/

### 1.5 Measurement Uncertainty

Measurement Uncertainty for a Level of Confidence of 95 %,  $U=2xUc(y)$

Conducted emission(150kHz~30MHz)	± 2.5 dB
Radiated emission(30MHz~1GHz)	± 4.2 dB
Radiated emission (above 1GHz)	± 4.3 dB
Temperature	±1 degree
Humidity	± 5 %

## 2 SUMMARY OF TEST RESULT

Item	FCC Part No.	Description of Test	Result
1	FCC PART 15.203	Antenna requirement	Pass
2	FCC PART 15.207	Conducted emission	Pass
3	FCC PART 15.209	Radiated emission	Pass
4	FCC Part 15.215	20dB bandwidth	Pass

### 2.1 Operation channel list

#### Channel List

Channel	Frequency (kHz)
Low	115
Middle	160
High	205

### 2.2 Test channel

Channel	Frequency (kHz)
Middle	160

### 3 TEST FACILITIES AND ACCREDITATIONS

#### 3.1 Test laboratory

Test Laboratory	Shenzhen Microtest Co., Ltd
Location	No.102A & 302A, East Block, Hengfang Industrial Park, Xingye Road, Xixiang, Bao'an District, Shenzhen, Guangdong, China
FCC Registration No.:	448573

#### 3.2 Environmental conditions

Temperature:	20°C~30°C
Humidity	30%~70%
Atmospheric pressure	98kPa~101kPa

#### 3.3 Measurement uncertainty

Measurement Uncertainty for a Level of Confidence of 95 %,  $U=2xUc(y)$

RF frequency	$1 \times 10^{-7}$
RF power, conducted	$\pm 1$ dB
Conducted emission(150kHz~30MHz)	$\pm 2.5$ dB
Radiated emission(30MHz~1GHz)	$\pm 4.2$ dB
Radiated emission (above 1GHz)	$\pm 4.3$ dB
Temperature	$\pm 1$ degree
Humidity	$\pm 5$ %

#### 3.4 Test software

Software Name	Manufacturer	Model	Version
RF Test System	Farad	LZ-RF	Lz_Rf 3A3

#### 4 LIST OF TEST EQUIPMENT

Equipment No.	Equipment Name	Manufacturer	Model	Serial No.	Calibration date	Due date
MTI-E001	Spectrum Analyzer	Agilent	E4407B	MY41441082	2017/09/18	2018/09/17
MTI-E002	CMU 200 universal radio communication tester	Rohde&schwarz	CMU 200	114587	2017/09/18	2018/09/17
MTI-E004	EMI Test Receiver	Rohde&schwarz	ESPI	1000314	2017/09/18	2018/09/17
MTI-E006	Broadband antenna	schwarzbeck	VULB9163	872	2017/09/18	2018/09/17
MTI-E007	Horn antenna	schwarzbeck	BBHA9120D	1201	2017/09/18	2018/09/17
MTI-E014	amplifier	America	8447D	3113A06150	2017/09/18	2018/09/17
MTI-E015	Conduction Immunity Signal Generator	Schloder	CDG6000	126A1343/2015	2017/09/18	2018/09/17
MTI-E016	Coupled decoupling network	Schloder	CDA M2/M3	A2210332/2015	2017/09/18	2018/09/17
MTI-E032	Comprehensive test instrument	Rohde&schwarz	CMW500	124192	2018/04/13	2019/04/12
MTI-E034	amplifier	Agilent	8449B	3008A02400	2018/08/22	2019/08/21
MTI-E037	Artificial power network	Schwarzbeck	NSLK8127	#841	2017/9/26	2018/9/25
MTI-E040	Spectrum analyzer	Agilent	N9020A	MY49100060	2018/03/05	2019/03/04
MTI-E041	Signal generator	Agilent	N5182A	MY49060455	2018/02/23	2019/02/22
MTI-E042	Analog signal generator	Agilent	E4421B	GB40051240	2018/02/23	2019/02/22
MTI-E043	Power probe	Dare Instruments	RPR3006W	16I00054SN O16	2018/02/29	2019/02/28
MTI-E047	10dB attenuator	Mini-Circuits	UNAT-10+	15542	2018/05/24	2019/05/23
MTI-E049	spectrum analyzer	Rohde&schwarz	FSP-38	100019	2017/09/18	2018/09/17
MTI-E050	PSG Signal generator	Agilent	E8257D	MY46520873	2018/04/24	2019/04/23
MTI-E051	Active Loop Antenna 9kHz - 30MHz	Schwarzbeck	FMZB 1519 B	00044	2018/02/26	2019/02/25
MTI-E052	18-40GHz amplifier	Chengdu step Micro Technology	ZLNA-18-40G-21	1608001	2017/09/18	2018/09/17
MTI-E053	15-40G Antenna	Schwarzbeck	BBHA9170	BBHA9170582	2017/09/18	2018/09/17
MTI-E058	Artificial power network	Schwarzbeck	NSLK8127	#841	2017/12/05	2018/12/04

Note: the calibration interval of the above test instruments is 12 months and the calibrations are traceable to international system unit (SI).

## 5 TEST RESULTS

### 5.1 Antenna requirement

#### 5.1.1 Standard requirement

15.203 requirement: For intentional device, according to 15.203: an intentional radiator shall be designed to ensure that no antenna other than that furnished by the responsible party shall be used with the device

#### 5.1.2 EUT Antenna

The EUT antenna is Coil Antenna. It comply with the standard requirement. In case of replacement of broken antenna the same antenna type must be used.



## 5.2 Conducted emission

### 5.2.1 Limits

For the following equipment, when designed to be connected to the public utility (AC) power line the radio frequency voltage that is conducted back onto the AC power line on any frequency or frequencies shall not exceed the limits in the following tables. Compliance with the provisions of this paragraph shall be based on the measurement of the radio frequency voltage between each power line and ground at the power terminal using a 50  $\mu$ H/50 ohms line impedance stabilization network (LISN).

Frequency (MHz)	Conducted limit (dB $\mu$ V)	
	Quasi-peak	Average
0.15 -0.5	66 - 56 *	56 - 46 *
0.5 -5	56	46
5 -30	60	50

Note : the limit of " \* " marked band means the limitation decreases linearly with the logarithm of the frequency in the range.

### 5.2.2 Test Procedures

The EUT was placed 0.8 meters from the horizontal ground plane with EUT being connected to the power mains through a line impedance stabilization network (LISN). All other support equipment powered from additional LISN(s). The LISN provide 50 Ohm/ 50uH of coupling impedance for the measuring instrument.

Interconnecting cables that hang closer than 40 cm to the ground plane shall be folded back and forth in the center forming a bundle 30 to 40 cm long.

I/O cables that are not connected to a peripheral shall be bundled in the center. The end of the cable may be terminated, if required, using the correct terminating impedance. The overall length shall not exceed 1 m.

LISN is at least 80 cm from nearest part of EUT chassis.

For the actual test configuration, please refer to the related Item – photographs of the test setup.

### 5.2.3 Test Setup

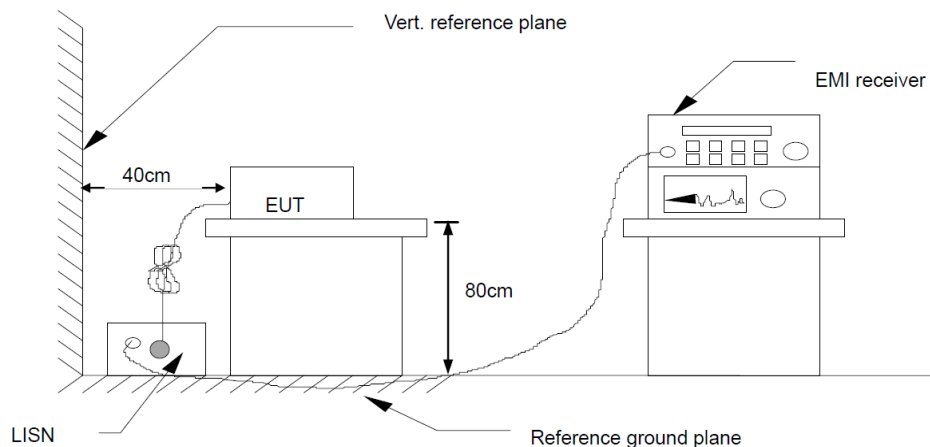

### 5.2.4 Test Result

Temperature:	27°C	Relative Humidity:	65%
Pressure:	101kPa	Phase:	L
Test voltage:	DC 5V from adapter AC 120V/60Hz	Test mode:	Mode 1

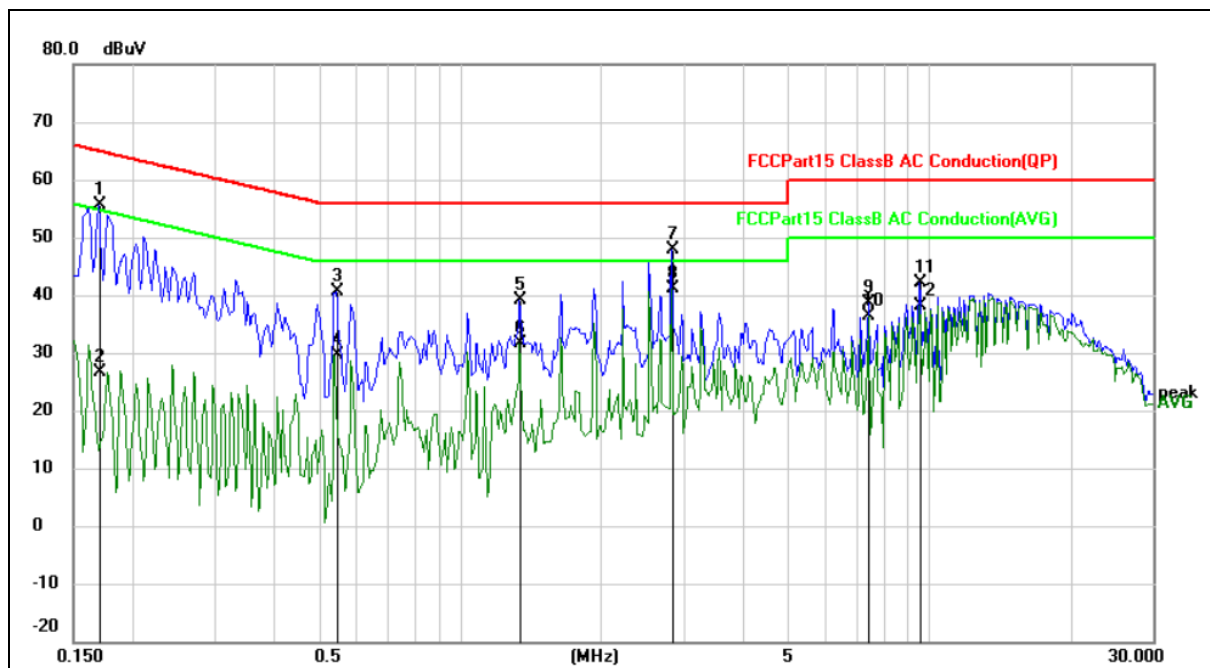

No.	Mk.	Freq. MHz	Reading Level dBuV	Correct Factor dB	Measure- ment dBuV	Limit dBuV	Over dB	Detector	Comment
1		0.1695	54.13	1.57	55.70	64.98	-9.28	QP	
2		0.1695	25.00	1.57	26.57	54.98	-28.41	AVG	
3		0.5445	39.17	1.57	40.74	56.00	-15.26	QP	
4		0.5445	28.06	1.57	29.63	46.00	-16.37	AVG	
5		1.3414	37.48	1.58	39.06	56.00	-16.94	QP	
6		1.3414	30.07	1.58	31.65	46.00	-14.35	AVG	
7		2.8258	46.74	1.10	47.84	56.00	-8.16	QP	
8	*	2.8258	40.01	1.10	41.11	46.00	-4.89	AVG	
9		7.4414	38.27	0.39	38.66	60.00	-21.34	QP	
10		7.4414	35.90	0.39	36.29	50.00	-13.71	AVG	
11		9.5195	41.72	0.39	42.11	60.00	-17.89	QP	
12		9.5195	37.69	0.39	38.08	50.00	-11.92	AVG	

Temperature:	27°C	Relative Humidity:	65%
Pressure:	101kPa	Phase:	N
Test voltage:	DC 5V from adapter AC 120V/60Hz	Test mode:	Mode 1

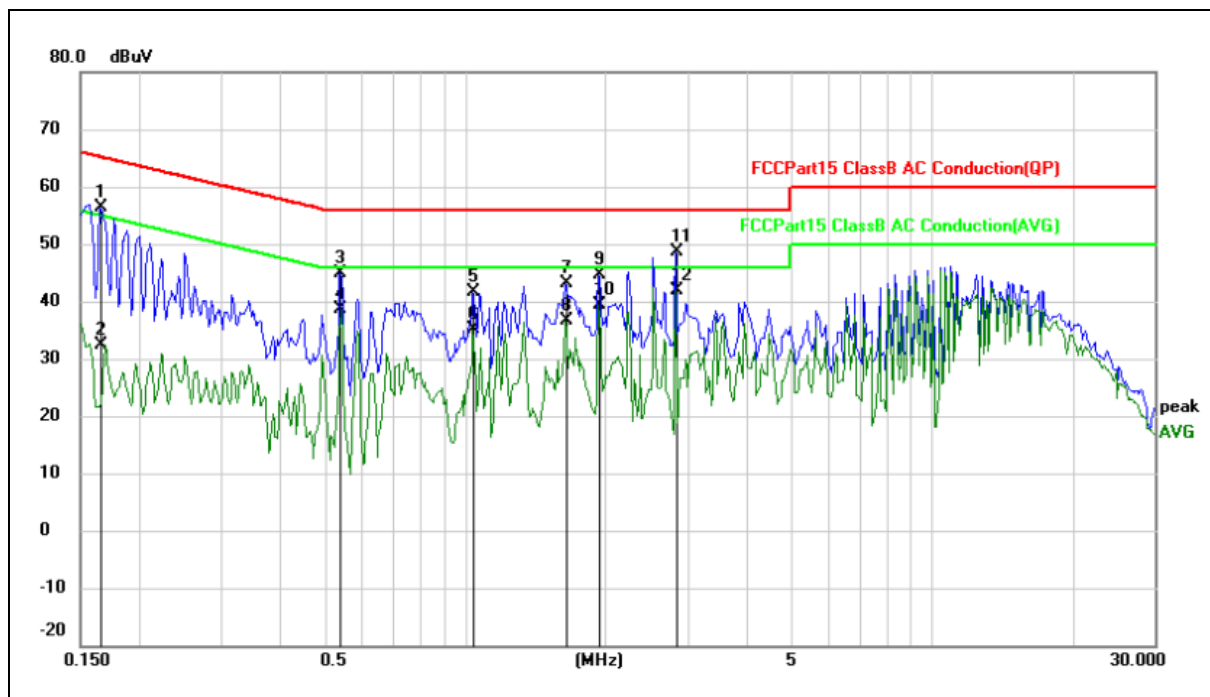

No.	Mk.	Freq. MHz	Reading Level dBuV	Correct Factor dB	Measure- ment dBuV	Limit dBuV	Over dB	Detector	Comment
1		0.1655	54.78	1.57	56.35	65.18	-8.83	QP	
2		0.1655	30.71	1.57	32.28	55.18	-22.90	AVG	
3		0.5404	43.38	1.57	44.95	56.00	-11.05	QP	
4		0.5404	36.97	1.57	38.54	46.00	-7.46	AVG	
5		1.0404	39.95	1.58	41.53	56.00	-14.47	QP	
6		1.0404	33.52	1.58	35.10	46.00	-10.90	AVG	
7		1.6382	41.51	1.58	43.09	56.00	-12.91	QP	
8		1.6382	35.04	1.58	36.62	46.00	-9.38	AVG	
9		1.9351	43.10	1.59	44.69	56.00	-11.31	QP	
10		1.9351	37.89	1.59	39.48	46.00	-6.52	AVG	
11		2.8256	47.41	1.10	48.51	56.00	-7.49	QP	
12	*	2.8256	40.87	1.10	41.97	46.00	-4.03	AVG	

Temperature:	27°C	Relative Humidity:	65%
Pressure:	101kPa	Phase:	L
Test voltage:	DC 5V from adapter AC 240V/60Hz	Test mode:	Mode 1

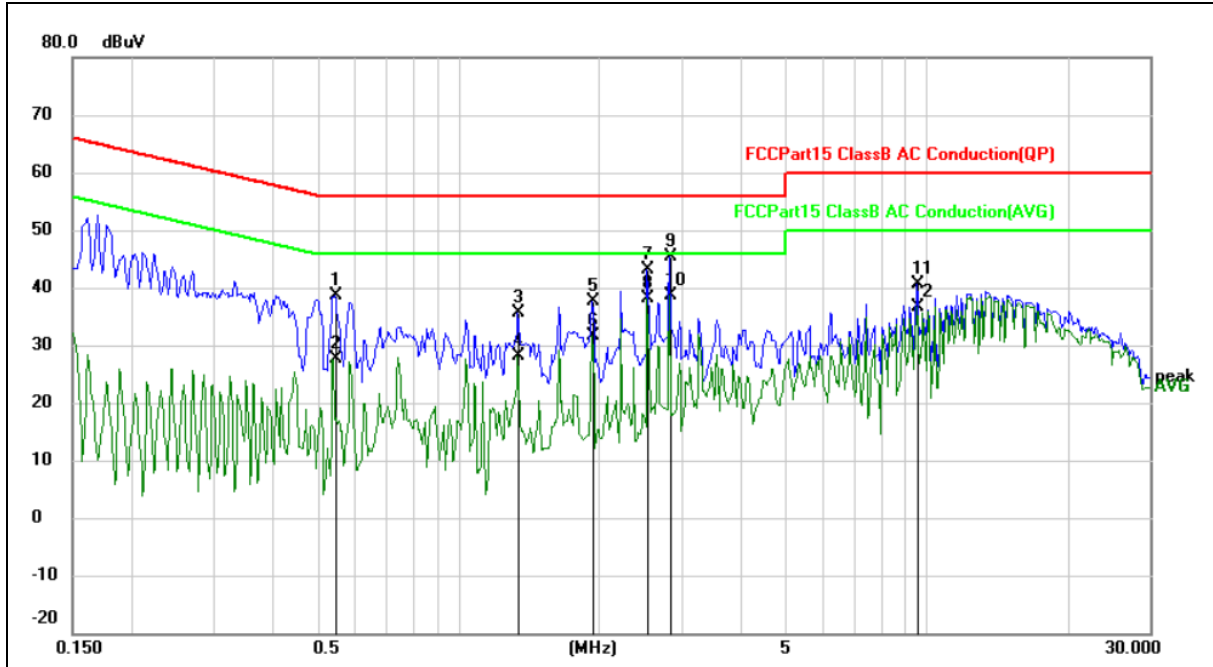

No.	Mk.	Freq. MHz	Reading Level dBuV	Correct Factor dB	Measure- ment dBuV	Limit dBuV	Over dB	Detector	Comment
1		0.5443	37.17	1.57	38.74	56.00	-17.26	QP	
2		0.5443	26.06	1.57	27.63	46.00	-18.37	AVG	
3		1.3411	33.98	1.58	35.56	56.00	-20.44	QP	
4		1.3411	26.57	1.58	28.15	46.00	-17.85	AVG	
5		1.9351	36.03	1.59	37.62	56.00	-18.38	QP	
6		1.9351	29.98	1.59	31.57	46.00	-14.43	AVG	
7		2.5288	41.91	1.23	43.14	56.00	-12.86	QP	
8		2.5288	36.94	1.23	38.17	46.00	-7.83	AVG	
9		2.8256	44.24	1.10	45.34	56.00	-10.66	QP	
10	*	2.8256	37.51	1.10	38.61	46.00	-7.39	AVG	
11		9.5195	40.22	0.39	40.61	60.00	-19.39	QP	
12		9.5195	36.19	0.39	36.58	50.00	-13.42	AVG	

Temperature:	27°C	Relative Humidity:	65%
Pressure:	101kPa	Phase:	N
Test voltage:	DC 5V from adapter AC 240V/60Hz	Test mode:	Mode 1

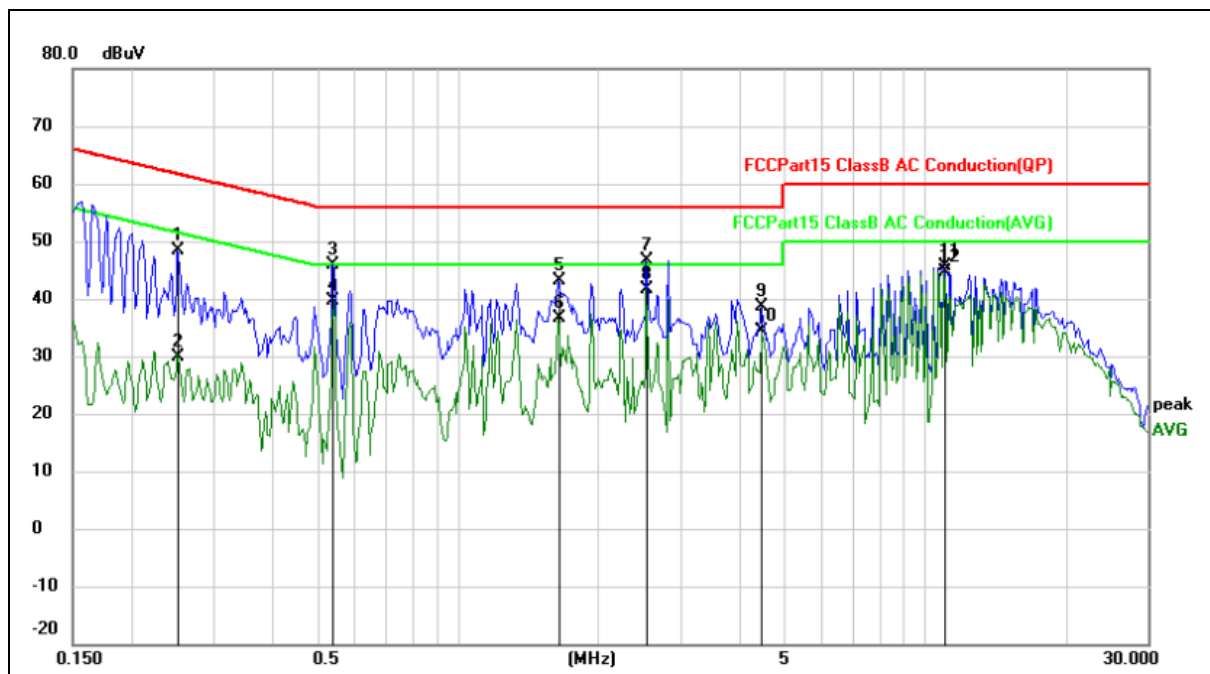

No.	Mk.	Freq. MHz	Reading Level dBuV	Correct Factor dB	Measure- ment dBuV	Limit dBuV	Over dB	Detector	Comment
1		0.2515	46.72	1.57	48.29	61.71	-13.42	QP	
2		0.2515	28.26	1.57	29.83	51.71	-21.88	AVG	
3		0.5403	44.38	1.57	45.95	56.00	-10.05	QP	
4		0.5403	37.97	1.57	39.54	46.00	-6.46	AVG	
5		1.6382	41.51	1.58	43.09	56.00	-12.91	QP	
6		1.6382	35.04	1.58	36.62	46.00	-9.38	AVG	
7		2.5288	45.48	1.23	46.71	56.00	-9.29	QP	
8	*	2.5288	40.38	1.23	41.61	46.00	-4.39	AVG	
9		4.4648	38.02	0.63	38.65	56.00	-17.35	QP	
10		4.4648	33.66	0.63	34.29	46.00	-11.71	AVG	
11		11.0076	45.26	0.37	45.63	60.00	-14.37	QP	
12		11.0076	44.23	0.37	44.60	50.00	-5.40	AVG	

5.3 Radiated emission

5.3.1 Limits

In case the emission fall within the restricted band specified on 15.205(a), then the 15.209(a) limit in the table below has to be followed.

Frequencies (MHz)	Field Strength (microrvolts/meter)	Measurement Distance (meters)
0.009~0.490	2400/F(KHz)	300
0.490~1.705	24000/F(KHz)	30
1.705~30.0	30	30
30~88	100	3
88~216	150	3
216~960	200	3
Above 960	500	3

LIMITS OF RADIATED EMISSION MEASUREMENT (Above 1000MHz)

FREQUENCY (MHz)	Class B (dBuV/m) (at 3M)	
	PEAK	AVERAGE
Above 1000	74	54

Notes:

The limit for radiated test was performed according to FCC PART 15C.

The tighter limit applies at the band edges.

Emission level (dBuV/m)=20log Emission level (uV/m).

FREQUENCY RANGE OF RADIATED MEASUREMENT (For unintentional radiators)

Highest frequency generated or Upper frequency of measurement used in the device or on which the device operates or tunes (MHz)	Range (MHz)
Below 1.705	30
1.705 – 108	1000
108 – 500	2000
500 – 1000	5000
Above 1000	5 <sup>th</sup> harmonic of the highest frequency or 40 GHz, whichever is lower

Spectrum Parameter	Setting
Attenuation	Auto
Start Frequency	1000 MHz
Stop Frequency	10th carrier harmonic
RB / VB (emission in restricted band)	1 MHz / 1 MHz for Peak, 1 MHz / 10Hz for Average

Receiver Parameter	Setting
Attenuation	Auto
Start ~ Stop Frequency	9kHz~150kHz / RB 200Hz for QP
Start ~ Stop Frequency	150kHz~30MHz / RB 9kHz for QP

Start ~ Stop Frequency	30MHz~1000MHz / RB 120kHz for QP
------------------------	----------------------------------

### 5.3.2 Test Procedures

- a. The measuring distance of at 3 m shall be used for measurements at frequency up to 25GHz. For frequencies above 1GHz, any suitable measuring distance may be used.
- b. The EUT was placed on the top of a rotating table 0.8 meters above the ground at a 3 meter semi-chamber test. The table was rotated 360 degrees to determine the position of the highest radiation.
- c. The height of the equipment or of the substitution antenna shall be 0.8m; above 1GHz, the height was 1.5m, the height of the test antenna shall vary between 1 m to 4 m. Both horizontal and vertical polarizations of the antenna are set to make the measurement.
- d. The initial step in collecting conducted emission data is a spectrum analyzer peak detector mode pre-scanning the measurement frequency range. Significant peaks are then marked and then Quasi Peak detector mode re-measured.
- e. If the Peak Mode measured value compliance with and lower than Quasi Peak Mode Limit, the EUT shall be deemed to meet QP Limits and then no additional QP Mode measurement performed.
- f. For the actual test configuration, please refer to the related Item –EUT Test Photos.
- g. For the radiated emission test above 1GHz:  
Place the measurement antenna away from each area of the EUT determined to be a source of emissions at the specified measurement distance, while keeping the measurement antenna aimed at the source of emissions at each frequency of significant emissions, with polarization oriented for maximum response.
- h. The measurement antenna may have to be higher or lower than the EUT, depending on the radiation pattern of the emission and staying aimed at the emission source for receiving the maximum signal. The final measurement antenna elevation shall be that which maximizes the emissions. The measurement antenna elevation for maximum emissions shall be restricted to a range of heights of from 1 m to 4 m above the ground or reference ground plane.

Note: Both horizontal and vertical antenna polarities were tested and performed pretest to three orthogonal axis. The worst case emissions were reported

### 5.3.3 Test Setup

#### Radiated Emission Test-Up Frequency Below 30MHz

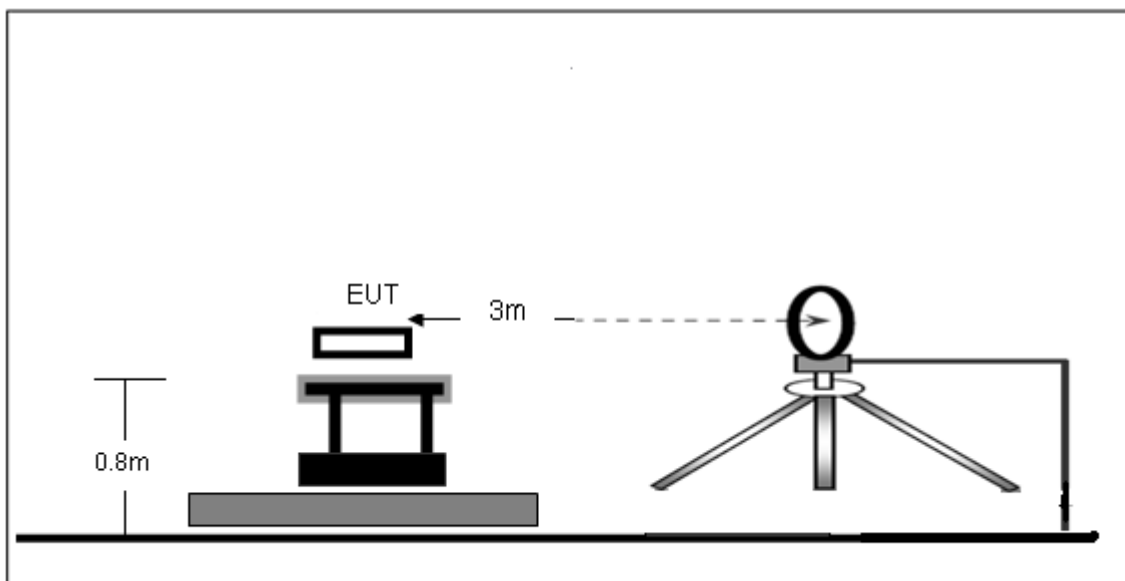

#### Radiated Emission Test-Up Frequency 30MHz~1GHz

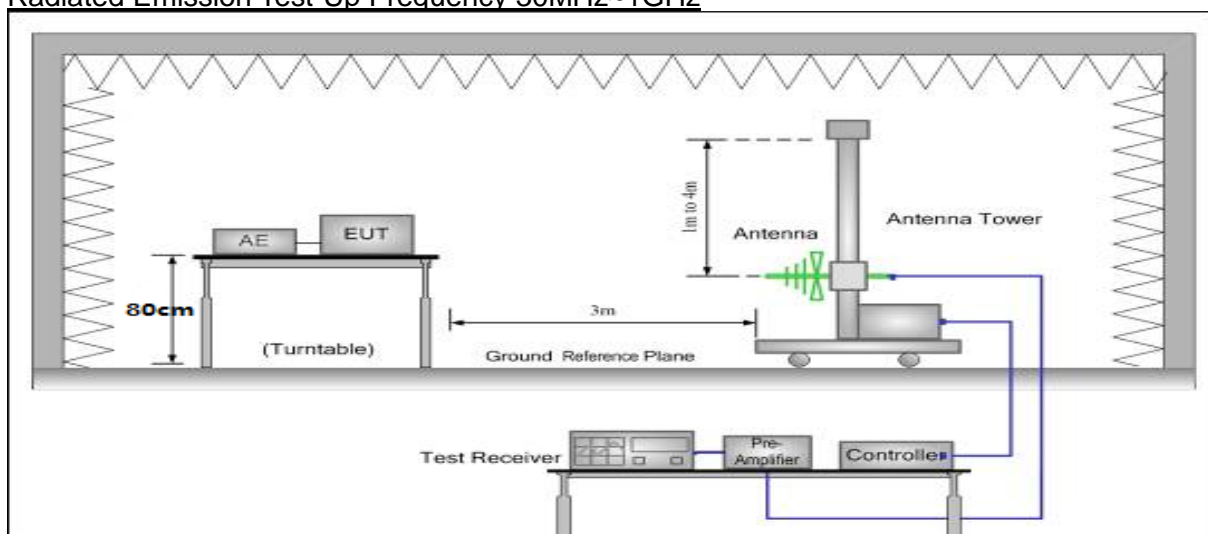

### 5.3.4 Test Result



Frequency range (9kHz – 30MHz)

Temperature:	23°C	Relative Humidity:	59%
Pressure:	101kPa	Test mode:	Mode 1
Test voltage:	DC 5V from adapter AC 120V/60Hz		

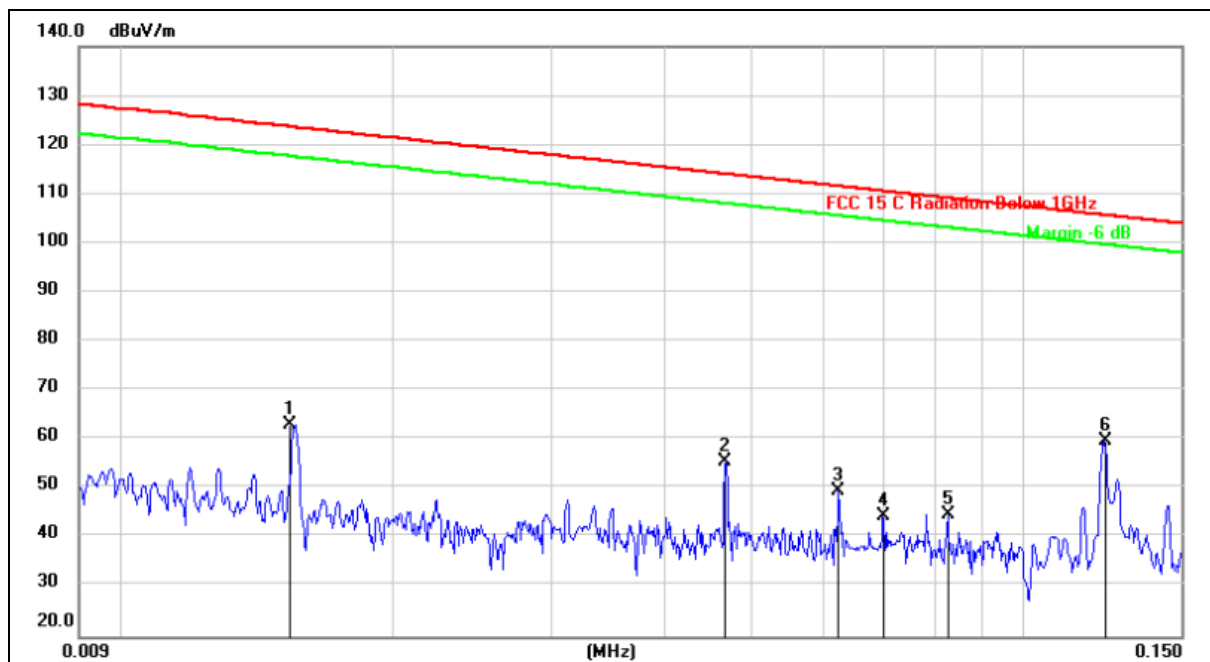

No.	Mk.	Freq. MHz	Reading Level dBuV	Correct Factor dBuV/m	Measure- ment dBuV/m	Limit dBuV/m	Over dB	Detector
1		0.0154	42.37	20.62	62.99	123.69	-60.70	peak
2		0.0468	35.16	20.43	55.59	114.09	-58.50	peak
3		0.0625	29.15	20.43	49.58	111.59	-62.01	peak
4		0.0700	24.04	20.44	44.48	110.61	-66.13	peak
5		0.0826	24.36	20.44	44.80	109.18	-64.38	peak
6	*	0.1232	39.21	20.43	59.64	105.72	-46.08	peak

Temperature:	23°C	Relative Humidity:	59%
Pressure:	101kPa	Test mode:	Mode 1
Test voltage:	DC 5V from adapter AC 120V/60Hz		

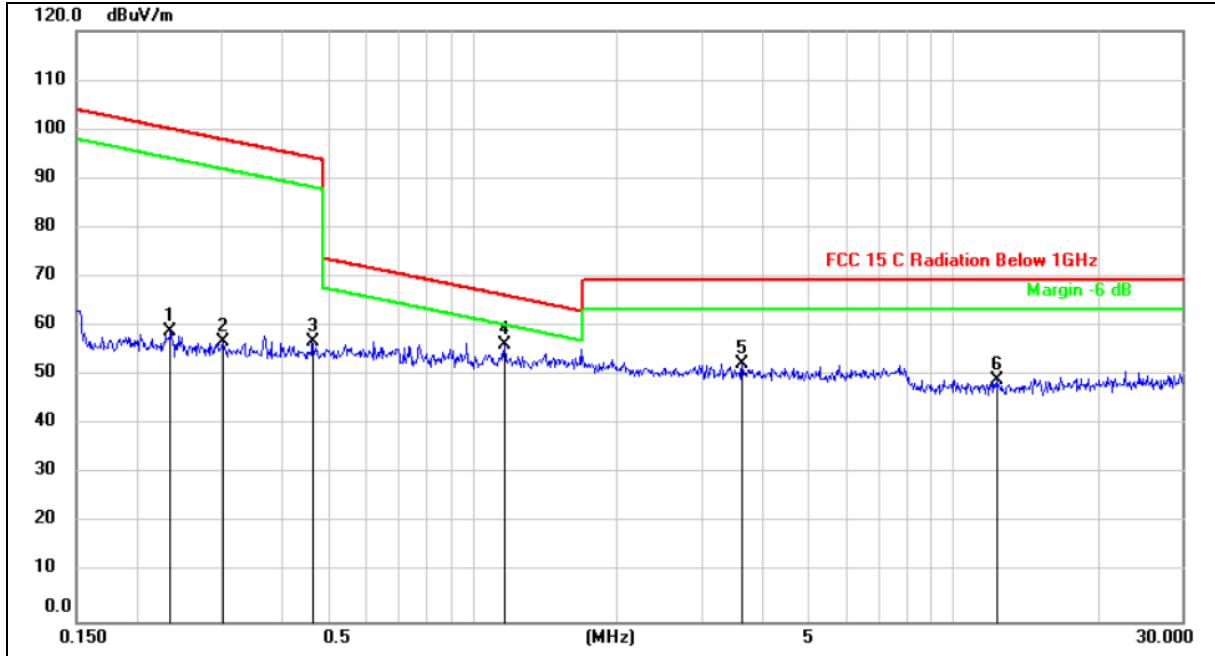

No.	Mk.	Freq. MHz	Reading Level dBuV	Correct Factor dBuV/m	Measure- ment dBuV/m	Limit dBuV/m	Over dB	Detector
1		0.2353	38.58	20.34	58.92	100.14	-41.22	peak
2		0.3019	36.49	20.33	56.82	97.98	-41.16	peak
3		0.4637	36.68	20.31	56.99	94.28	-37.29	peak
4	*	1.1653	35.88	20.26	56.14	66.30	-10.16	peak
5		3.6417	31.95	20.29	52.24	69.50	-17.26	peak
6		12.3833	28.59	20.36	48.95	69.50	-20.55	peak

Frequency range (30MHz – 1GHz)

Temperature:	23°C	Relative Humidity:	59%
Pressure:	101kPa	Polarization:	Vertical
Test voltage:	DC 5V from adapter AC 120V/60Hz	Test mode:	Mode 1

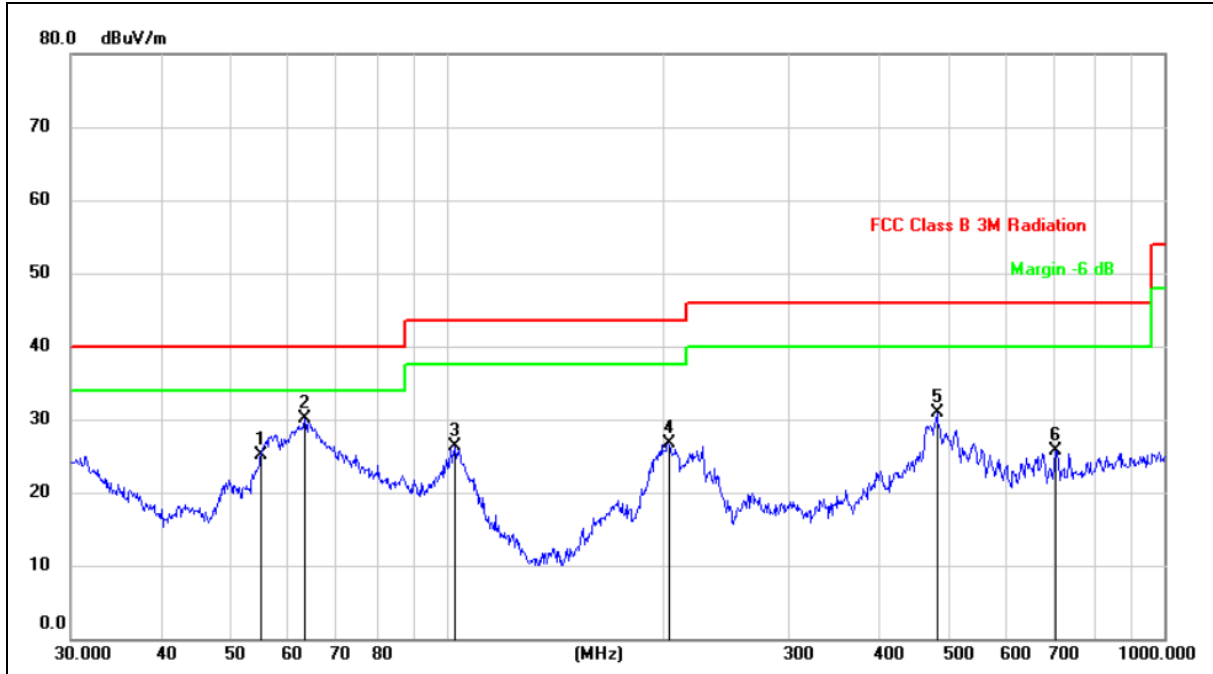

No.	Mk.	Freq.	Reading Level	Correct Factor	Measurement	Limit	Over	Detector
		MHz	dBuV	dBuV/m	dBuV/m	dBuV/m	dB	
1		55.2207	35.48	-10.45	25.03	40.00	-14.97	QP
2	*	63.5356	42.08	-12.06	30.02	40.00	-9.98	QP
3		102.7192	37.72	-11.44	26.28	43.50	-17.22	QP
4		203.5228	37.27	-10.61	26.66	43.50	-16.84	QP
5		482.2156	36.33	-5.33	31.00	46.00	-15.00	QP
6		704.2261	29.82	-4.16	25.66	46.00	-20.34	QP

Temperature:	23°C	Relative Humidity:	59%
Pressure:	101kPa	Polarization:	Horizontal
Test voltage:	DC 5V from adapter AC 120V/60Hz	Test mode:	Mode 1

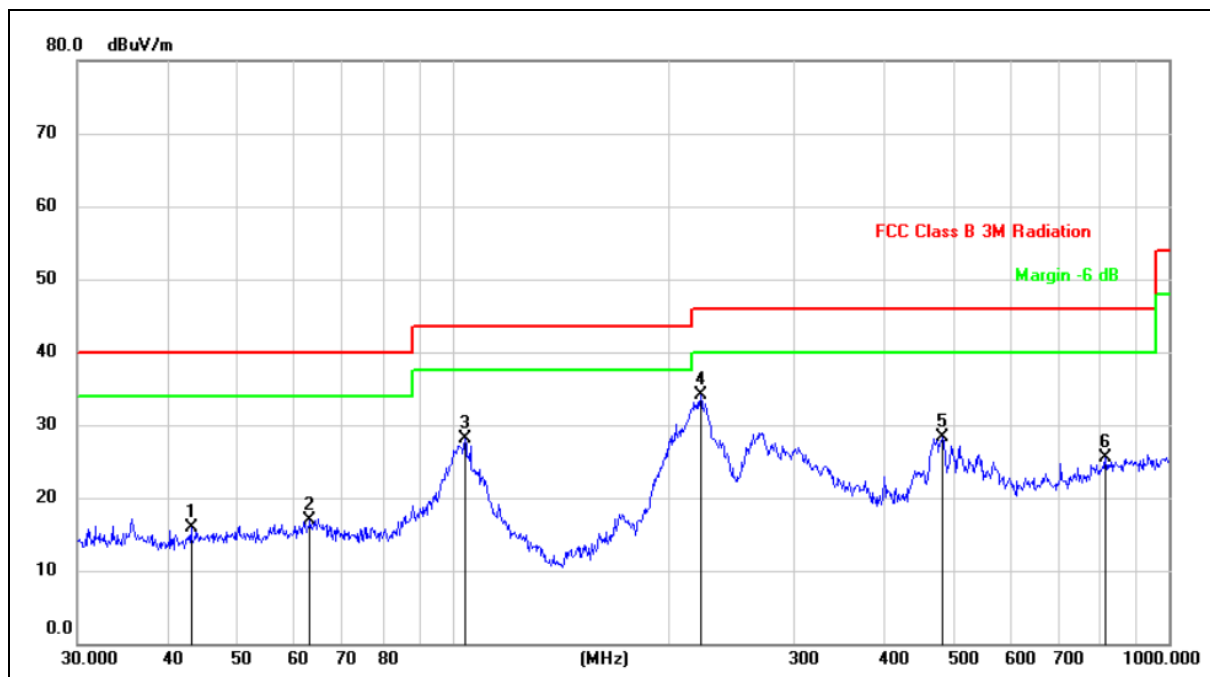

No.	Mk.	Freq. MHz	Reading Level dBuV	Correct Factor dBuV/m	Measure- ment dBuV/m	Limit dBuV/m	Over dB	Detector
1		43.2017	26.04	-10.04	16.00	40.00	-24.00	QP
2		63.3132	28.88	-12.00	16.88	40.00	-23.12	QP
3		104.1701	39.60	-11.43	28.17	43.50	-15.33	QP
4	*	222.1698	45.13	-10.97	34.16	46.00	-11.84	QP
5		483.9094	33.68	-5.32	28.36	46.00	-17.64	QP
6		815.9678	28.08	-2.56	25.52	46.00	-20.48	QP

5.4 Occupied bandwidth

5.4.1 Test method

Use the following spectrum analyzer settings:

Span = approximately 2 to 3 times the 20 dB bandwidth, centered on a hopping channel

RBW  $\geq 1\%$  of the 20 dB bandwidth

VBW  $\geq$  RBW

Sweep = auto

Detector function = peak

Trace = max hold

The EUT should be transmitting at its maximum data rate. Allow the trace to stabilize. Use the marker-to-peak function to set the marker to the peak of the emission. Use the marker-delta function to measure 20 dB down one side of the emission. Reset the marker-delta function, and move the marker to the other side of the emission, until it is (as close as possible to) even with the reference marker level. The marker-delta reading at this point is the 20 dB bandwidth and 99% occupied bandwidth of the emission.

5.4.2 Test result

Frequency (kHz)	20dB emission bandwidth (kHz)	99% occupied bandwidth (kHz)
160	8.200	7.064

Test plots as below

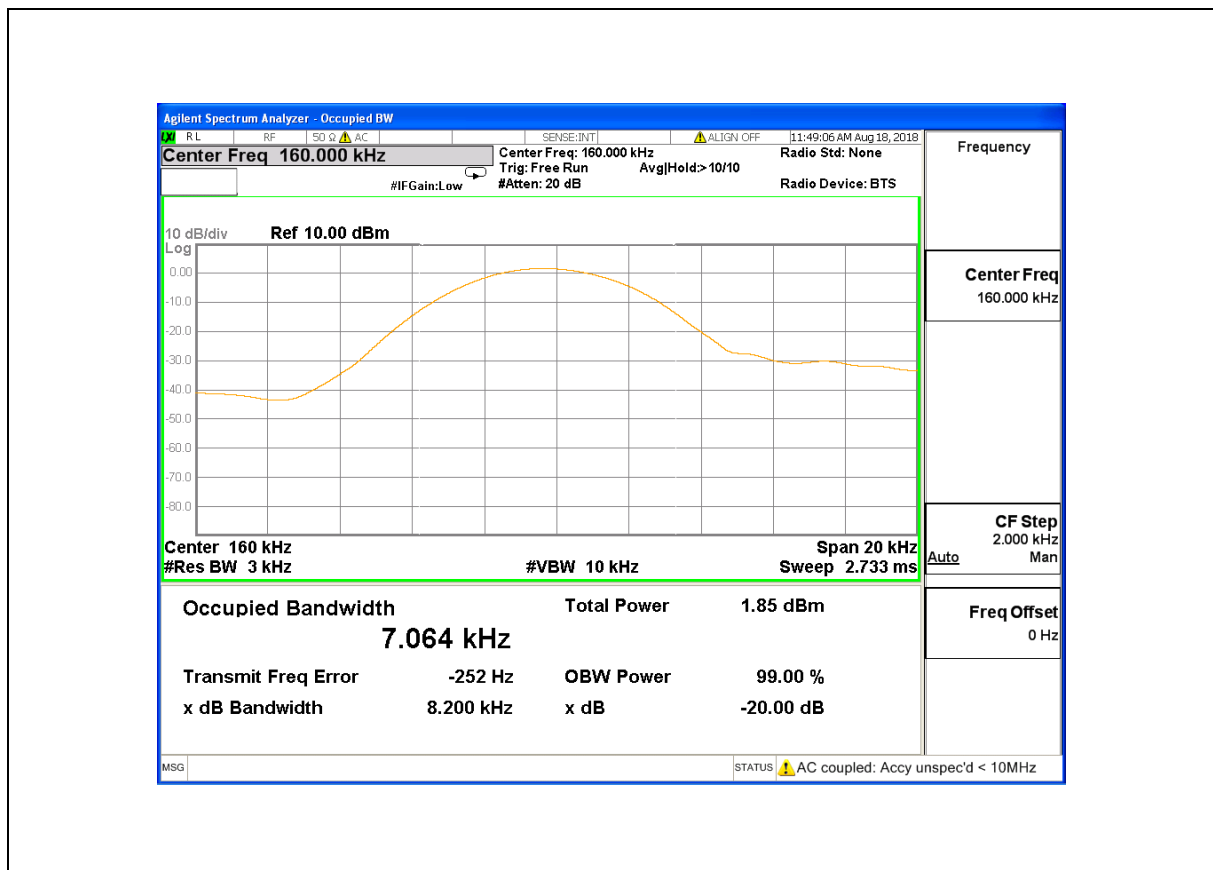

## Photographs of the Test Setup

Radiated emission

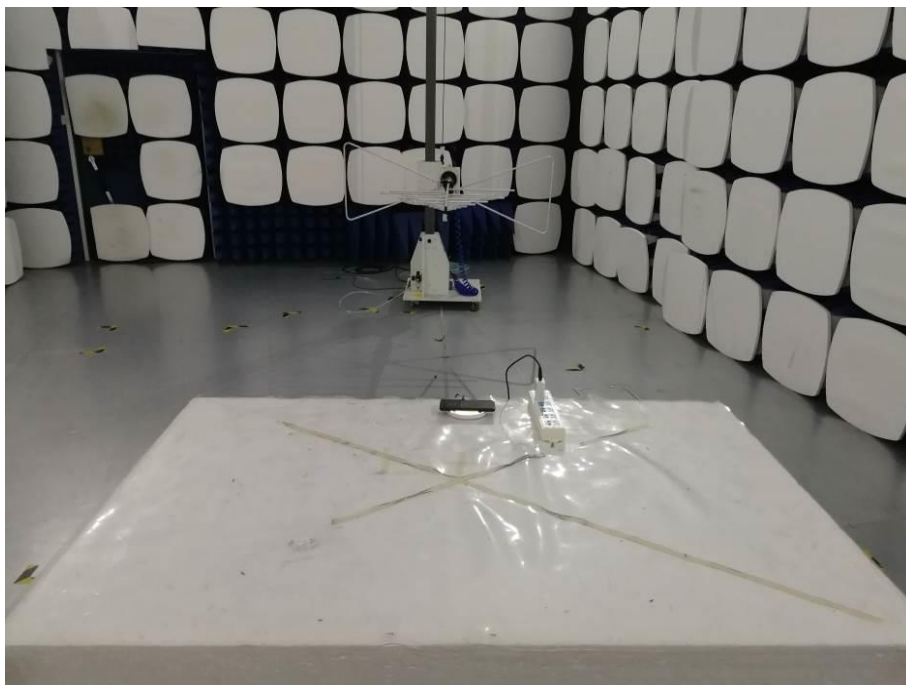
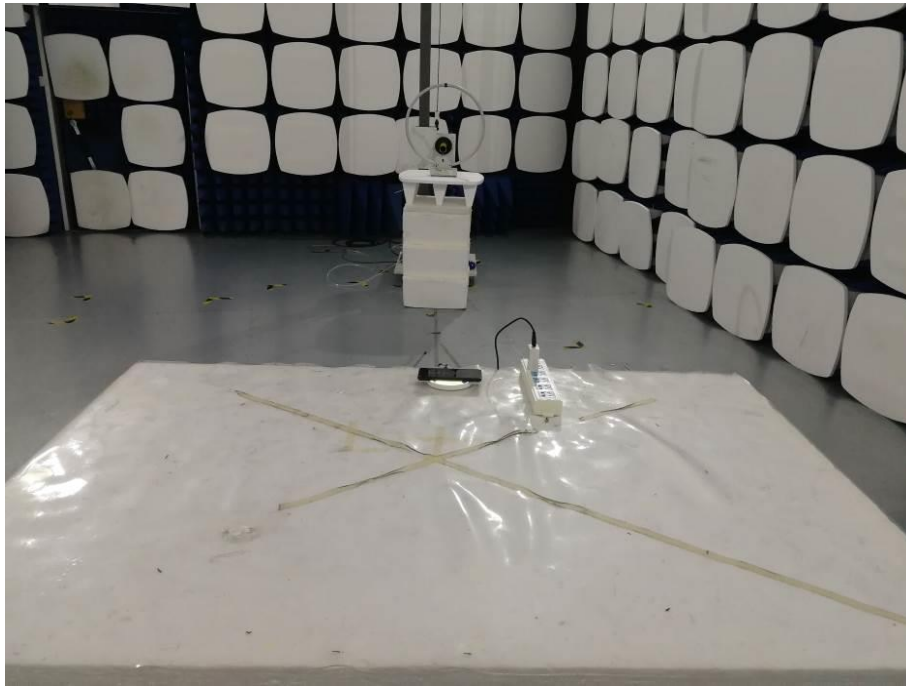

Conducted emission



## **Photographs of the EUT**

See the APPENDIX 1: EUT PHOTO in the report No.: MTi180830E134-1.

**----END OF REPORT----**