

## FCC Report (Bluetooth)

**Product Name** : TWS Earphones  
**Trade mark** : DOAGEAS  
**Model No.** : E1, E2, E3,E4, E5, E6, E7, E8, E9, E10  
**FCC ID** : 2AQ2W-E2  
**Report Number** : BLA-EMC-201911-A06-01  
**Date of sample receipt** : November 04, 2019  
**Date of Test** : November 04, 2019–November 11, 2019  
**Date of Issue** : November 13, 2019  
**Test standard** : FCC CFR Title 47 Part 15 Subpart C Section 15.247  
**Test result** : PASS

Prepared for:

**Shenzhen Doageas Technology Co., Ltd.**  
**5/F, 4th Bldg, Hedian Industrial Park, Guanlan, Longhua, Shenzhen,**  
**Guangdong518110, China**

Prepared by:

**BlueAsia of Technical Services(Shenzhen) Co., Ltd.**  
**IOT Test Centre of BlueAsia**  
**No. 448 Bulong Road, Bantian Street, Longgang District, Shenzhen,**  
**China**  
**TEL: +86-755-28682673**  
**FAX: +86-755-28682673**

Compiled by:

*Eason*

Review by:

*Sweet .wang*

Approved by:

*Emen-li*

Date: November 13, 2019



## 2 Version

| Version No. | Date              | Description |
|-------------|-------------------|-------------|
| 00          | November 13, 2019 | Original    |
|             |                   |             |
|             |                   |             |
|             |                   |             |
|             |                   |             |

BlueAsia

### 3 Contents

|  | Page      |
|--|-----------|
| <b>1 COVER PAGE .....</b>                            | <b>1</b>  |
| <b>2 VERSION .....</b>                               | <b>2</b>  |
| <b>3 CONTENTS .....</b>                              | <b>3</b>  |
| <b>4 TEST SUMMARY .....</b>                          | <b>4</b>  |
| <b>5 GENERAL INFORMATION .....</b>                   | <b>5</b>  |
| 5.1 GENERAL DESCRIPTION OF EUT .....                 | 5         |
| 5.2 TEST MODE .....                                  | 7         |
| 5.3 TEST FACILITY.....                               | 7         |
| 5.4 TEST LOCATION.....                               | 7         |
| 5.5 OTHER INFORMATION REQUESTED BY THE CUSTOMER..... | 7         |
| 5.6 DESCRIPTION OF SUPPORT UNITS.....                | 7         |
| <b>6 TEST INSTRUMENTS LIST .....</b>                 | <b>8</b>  |
| <b>7 TEST RESULTS AND MEASUREMENT DATA .....</b>     | <b>10</b> |
| 7.1 ANTENNA REQUIREMENT .....                        | 10        |
| 7.2 CONDUCTED EMISSIONS .....                        | 11        |
| 7.3 CONDUCTED PEAK OUTPUT POWER.....                 | 14        |
| 7.4 20DB EMISSION BANDWIDTH.....                     | 17        |
| 7.5 CARRIER FREQUENCIES SEPARATION.....              | 20        |
| 7.6 HOPPING CHANNEL NUMBER .....                     | 23        |
| 7.7 DWELL TIME.....                                  | 24        |
| 7.8 PSEUDORANDOM FREQUENCY HOPPING SEQUENCE .....    | 26        |
| 7.9 BAND EDGE.....                                   | 27        |
| 7.9.1 <i>Conducted Emission Method</i> .....         | 27        |
| 7.9.2 <i>Radiated Emission Method</i> .....          | 30        |
| 7.10 SPURIOUS EMISSION .....                         | 32        |
| 7.10.1 <i>Conducted Emission Method</i> .....        | 32        |
| 7.10.2 <i>Radiated Emission Method</i> .....         | 34        |
| <b>8 TEST SETUP PHOTO .....</b>                      | <b>42</b> |
| <b>9 EUT CONSTRUCTIONAL DETAILS.....</b>             | <b>44</b> |

## 4 Test Summary

| Test Item                               | Section in CFR 47 | Result |
|---|-------------------|--------|
| Antenna Requirement                     | 15.203/15.247 (c) | Pass   |
| AC Power Line Conducted Emission        | 15.207            | Pass   |
| Conducted Peak Output Power             | 15.247 (b)(1)     | Pass   |
| 20dB Occupied Bandwidth                 | 15.247 (a)(1)     | Pass   |
| Carrier Frequencies Separation          | 15.247 (a)(1)     | Pass   |
| Hopping Channel Number                  | 15.247 (a)(1)     | Pass   |
| Dwell Time                              | 15.247 (a)(1)     | Pass   |
| Pseudorandom Frequency Hopping Sequence | 15.247(b)(4)      | Pass   |
| Radiated Emission                       | 15.205/15.209     | Pass   |
| Band Edge                               | 15.247(d)         | Pass   |

*Pass: The EUT complies with the essential requirements in the standard.*

*Remark: Test according ANSI C63.10:2013*

### Measurement Uncertainty

| Test Item                        | Frequency Range | Measurement Uncertainty | Notes |
|----------------------------------|-----------------|-------------------------|-------|
| Radiated Emission                | 9kHz ~ 30MHz    | ± 4.34dB                | (1)   |
| Radiated Emission                | 30MHz ~ 1000MHz | ± 4.24dB                | (1)   |
| Radiated Emission                | 1GHz ~ 26.5GHz  | ± 4.68dB                | (1)   |
| AC Power Line Conducted Emission | 0.15MHz ~ 30MHz | ± 3.45dB                | (1)   |

Note (1): The measurement uncertainty is for coverage factor of k=2 and a level of confidence of 95%.

## 5 General Information

### 5.1 General Description of EUT

|  |  |
|--|--|
| Product Name:  | TWS Earphones                          |
| Model No.:   | E1, E2, E3,E4, E5, E6, E7, E8, E9, E10 |
| Test Model No.:  | E2                                     |
| <i>Remark: All above models are identical in the same PCB layout, interior structure and electrical circuits. The differences are model name for commercial purpose.</i> |  |
| Serial No.:  | N/A                                    |
| Sample(s) Status   | Engineer sample                        |
| Hardware:  | DGLS-E2-R V1.1                         |
| Software:  | V2.0                                   |
| Operation Frequency:   | 2402MHz-2480MHz                        |
| Channel numbers:   | 79                                     |
| Channel separation:  | 1MHz                                   |
| Modulation type:   | GFSK, $\pi/4$ -DQPSK                   |
| Antenna Type:  | Chip Antenna                           |
| Antenna gain:  | -0.58dBi                               |
| Power supply:  | DC 3.7V                                |

| Operation Frequency each of channel |           |         |           |         |           |         |           |
|-------------------------------------|-----------|---------|-----------|---------|-----------|---------|-----------|
| Channel                             | Frequency | Channel | Frequency | Channel | Frequency | Channel | Frequency |
| 1                                   | 2402MHz   | 21      | 2422MHz   | 41      | 2442MHz   | 61      | 2462MHz   |
| 2                                   | 2403MHz   | 22      | 2423MHz   | 42      | 2443MHz   | 62      | 2463MHz   |
| 3                                   | 2404MHz   | 23      | 2424MHz   | 43      | 2444MHz   | 63      | 2464MHz   |
| 4                                   | 2405MHz   | 24      | 2425MHz   | 44      | 2445MHz   | 64      | 2465MHz   |
| 5                                   | 2406MHz   | 25      | 2426MHz   | 45      | 2446MHz   | 65      | 2466MHz   |
| 6                                   | 2407MHz   | 26      | 2427MHz   | 46      | 2447MHz   | 66      | 2467MHz   |
| 7                                   | 2408MHz   | 27      | 2428MHz   | 47      | 2448MHz   | 67      | 2468MHz   |
| 8                                   | 2409MHz   | 28      | 2429MHz   | 48      | 2449MHz   | 68      | 2469MHz   |
| 9                                   | 2410MHz   | 29      | 2430MHz   | 49      | 2450MHz   | 69      | 2470MHz   |
| 10                                  | 2411MHz   | 30      | 2431MHz   | 50      | 2451MHz   | 70      | 2471MHz   |
| 11                                  | 2412MHz   | 31      | 2432MHz   | 51      | 2452MHz   | 71      | 2472MHz   |
| 12                                  | 2413MHz   | 32      | 2433MHz   | 52      | 2453MHz   | 72      | 2473MHz   |
| 13                                  | 2414MHz   | 33      | 2434MHz   | 53      | 2454MHz   | 73      | 2474MHz   |
| 14                                  | 2415MHz   | 34      | 2435MHz   | 54      | 2455MHz   | 74      | 2475MHz   |
| 15                                  | 2416MHz   | 35      | 2436MHz   | 55      | 2456MHz   | 75      | 2476MHz   |
| 16                                  | 2417MHz   | 36      | 2437MHz   | 56      | 2457MHz   | 76      | 2477MHz   |
| 17                                  | 2418MHz   | 37      | 2438MHz   | 57      | 2458MHz   | 77      | 2478MHz   |
| 18                                  | 2419MHz   | 38      | 2439MHz   | 58      | 2459MHz   | 78      | 2479MHz   |
| 19                                  | 2420MHz   | 39      | 2440MHz   | 59      | 2460MHz   | 79      | 2480MHz   |
| 20                                  | 2421MHz   | 40      | 2441MHz   | 60      | 2461MHz   |         |           |

Note:

In section 15.31(m), regards to the operating frequency range over 10 MHz, the Lowest frequency, the middle frequency, and the highest frequency of channel were selected to perform the test, and the selected channel see below:

| Channel             | Frequency |
|---------------------|-----------|
| The lowest channel  | 2402MHz   |
| The middle channel  | 2441MHz   |
| The Highest channel | 2480MHz   |

## 5.2 Test mode

|   |   |
|---|---|
| Transmitting mode   | Keep the EUT in continuously transmitting mode. |
| <p><i>Remark: During the test, the test voltage was tuned from 85% to 115% of the nominal rated supply voltage, and found that the worst case was under the nominal rated supply condition. So the report just shows that condition's data.</i></p> |   |

## 5.3 Test Facility

|   |
|---|
| <p>The test facility is recognized, certified, or accredited by the following organizations:</p> <ul style="list-style-type: none"> <li>● <b>FCC — Designation No.: CN1252</b><br/> <i>BlueAsia of Technical Services(Shenzhen) Co., Ltd</i> has been registered and fully described in a report filed with the (FCC) Federal Communications Commission. The acceptance letter from the FCC is maintained in files. Designation CN1252.</li> <li>● <b>ISED — CAB identifier No.: CN0028</b><br/> <i>BlueAsia of Technical Services(Shenzhen) Co., Ltd</i> has been registered by Certification and Engineering Bureau of ISED for radio equipment testing with CAB identifier CN0028</li> </ul> |
|---|

## 5.4 Test Location

|   |
|---|
| All tests were performed at:  |
| <p><i>All tests were performed at:</i><br/> <i>BlueAsia of Technical Services(Shenzhen) Co., Ltd.</i><br/> <i>IOT Test Centre of BlueAsia</i><br/> <i>No. 448 Bulong Road, Bantian Street, Longgang District, Shenzhen, China</i><br/> <i>Telephone: TEL: +86-755-28682673 FAX: +86-755-28682673</i><br/>           No tests were sub-contracted.</p> |

## 5.5 Other Information Requested by the Customer

|       |
|-------|
| None. |
|-------|

## 5.6 Description of Support Units

| Manufacturer | Description       | Model | Serial Number |
|--------------|-------------------|-------|---------------|
| UGREEN       | Adapter           | CD112 | 20358         |
| Lenovo       | Notebook computer | E470C | PF-10FB5C     |

## 6 Test Instruments list

| Radiated Emission: |                         |                 |           |                  |                        |                            |
|--------------------|-------------------------|-----------------|-----------|------------------|------------------------|----------------------------|
| Item               | Test Equipment          | Manufacturer    | Model No. | Serial No.       | Cal.Date<br>(mm-dd-yy) | Cal.Due date<br>(mm-dd-yy) |
| 1                  | 3m SAC                  | SKET            | 9m*6 m*6m | 966              | 06-10-2018             | 06-09-2023                 |
| 2                  | Broadband Antenna       | SCHWARZBECK     | VULB9168  | 00836<br>P:00227 | 07-14-2019             | 07-13-2020                 |
| 3                  | Horn Antenna            | SCHWARZBECK     | 9120D     | 01892<br>P:00331 | 07-14-2019             | 07-13-2020                 |
| 4                  | EMI Test Software       | EZ              | EZ        | N/A              | N/A                    | N/A                        |
| 5                  | Pre-amplifier           | SKET            | N/A       | N/A              | 07-19-2019             | 07-18-2020                 |
| 6                  | Spectrum analyzer       | Rohde & Schwarz | FSP40     | 100817           | 05-24-2019             | 05-23-2020                 |
| 7                  | EMI Test Receiver       | Rohde & Schwarz | ESR7      | 101199           | 03-21-2019             | 03-20-2020                 |
| 8                  | Controller              | SKET            | N/A       | N/A              | N/A                    | N/A                        |
| 9                  | Vector Signal Generator | Agilent         | E4438C    | MY45092582       | 05-24-2019             | 05-23-2020                 |
| 10                 | Signal Generator        | Agilent         | E8257D    | MY44320250       | 05-24-2019             | 05-23-2020                 |
| 11                 | Coaxial Cable           | BlueAsia        | BLA-XC-02 | N/A              | N/A                    | N/A                        |
| 12                 | Coaxial Cable           | BlueAsia        | BLA-XC-03 | N/A              | N/A                    | N/A                        |
| 13                 | Coaxial Cable           | BlueAsia        | BLA-XC-01 | N/A              | N/A                    | N/A                        |



| <b>Conducted Emission</b> |                              |                     |                  |                   |                                |                                    |
|---------------------------|------------------------------|---------------------|------------------|-------------------|--------------------------------|------------------------------------|
| <b>Item</b>               | <b>Test Equipment</b>        | <b>Manufacturer</b> | <b>Model No.</b> | <b>Serial No.</b> | <b>Cal.Date<br/>(mm-dd-yy)</b> | <b>Cal.Due date<br/>(mm-dd-yy)</b> |
| 1                         | EMI Test Receiver            | Rohde & Schwarz     | ESPI3            | 101082            | 06-10-2019                     | 06-09-2020                         |
| 2                         | LISN                         | CHASE               | MN2050D          | 1447              | 12-18-2018                     | 12-17-2019                         |
| 3                         | LISN                         | Rohde & Schwarz     | ENV216           | 3560.6550.15      | 07-19-2019                     | 07-18-2020                         |
| 4                         | EMI Test Software            | EZ                  | EZ               | N/A               | N/A                            | N/A                                |
| 5                         | Temperature Humidity Chamber | Mingle              | TH101B           | N/A               | 07-19-2019                     | 07-18-2020                         |
| 6                         | Coaxial Cable                | BlueAsia            | BLA-XC-05        | N/A               | N/A                            | N/A                                |

| <b>RF Conducted Test:</b> |                              |                     |                  |                   |                                |                                    |
|---------------------------|------------------------------|---------------------|------------------|-------------------|--------------------------------|------------------------------------|
| <b>Item</b>               | <b>Test Equipment</b>        | <b>Manufacturer</b> | <b>Model No.</b> | <b>Serial No.</b> | <b>Cal.Date<br/>(mm-dd-yy)</b> | <b>Cal.Due date<br/>(mm-dd-yy)</b> |
| 1                         | Spectrum Analyzer            | Agilent             | N9030A           | MY50510123        | 05-24-2019                     | 05-23-2020                         |
| 2                         | Spectrum analyzer            | Rohde & Schwarz     | FSP40            | 100817            | 05-24-2019                     | 05-23-2020                         |
| 3                         | Vector Signal Generator      | Agilent             | E4438C           | MY45092582        | 05-24-2019                     | 05-23-2020                         |
| 4                         | Signal Generator             | Agilent             | E8257D           | MY44320250        | 05-24-2019                     | 05-23-2020                         |
| 5                         | Power Sensor                 | D.A.R.E             | RPR3006W         | 17100015SNO27     | 05-24-2019                     | 05-23-2020                         |
| 6                         | Power Sensor                 | D.A.R.E             | RPR3006W         | 17100015SNO28     | 05-24-2019                     | 05-23-2020                         |
| 7                         | DC Power Supply              | LODESTAR            | LP305DE          | N/A               | 07-19-2019                     | 07-18-2020                         |
| 8                         | Temperature Humidity Chamber | Mingle              | TH101B           | N/A               | 07-19-2019                     | 07-18-2020                         |

## 7 Test results and Measurement Data

### 7.1 Antenna requirement

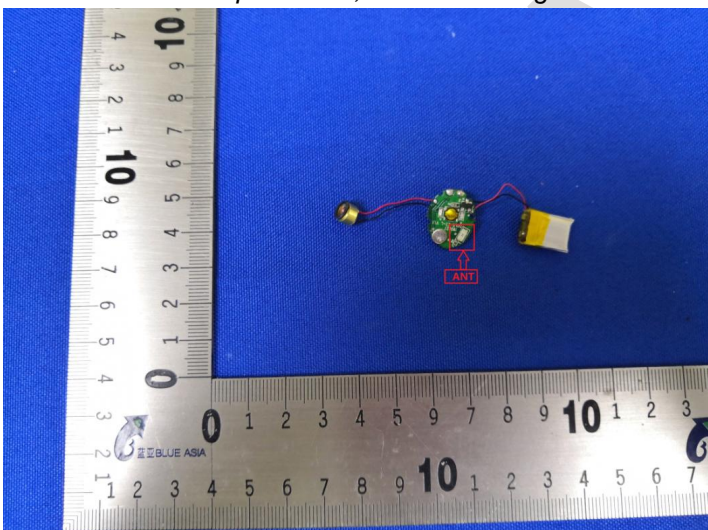
|  |                                     |
|--|-------------------------------------|
| <b>Standard requirement:</b>   | FCC Part15 C Section 15.203 /247(c) |
| <p><b>15.203 requirement:</b><br/>An intentional radiator shall be designed to ensure that no antenna other than that furnished by the responsible party shall be used with the device. The use of a permanently attached antenna or of an antenna that uses a unique coupling to the intentional radiator, the manufacturer may design the unit so that a broken antenna can be replaced by the user, but the use of a standard antenna jack or electrical connector is prohibited.</p> <p><b>15.247(c) (1)(i) requirement:</b><br/>(i) Systems operating in the 2400-2483.5 MHz band that is used exclusively for fixed. Point-to-point operations may employ transmitting antennas with directional gain greater than 6dBi provided the maximum conducted output power of the intentional radiator is reduced by 1 dB for every 3 dB that the directional gain of the antenna exceeds 6dBi.</p> |                                     |
| <b>E.U.T Antenna:</b>  |                                     |
| <p><i>The antenna is Chip antenna, the best case gain of the antenna is -0.58dBi</i></p>   |                                     |

## 7.2 Conducted Emissions

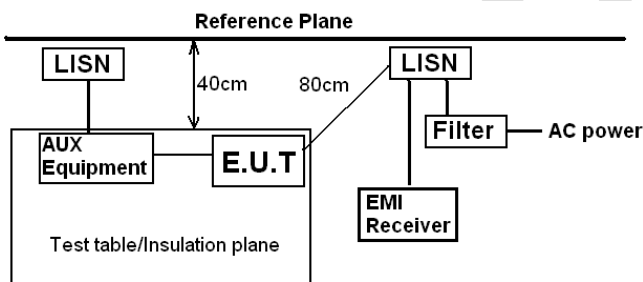
| Test Requirement:     | FCC Part15 C Section 15.207  |                       |              |  |            |         |          |           |           |       |    |    |      |    |    |
|-----------------------|--|-----------------------|--------------|--|------------|---------|----------|-----------|-----------|-------|----|----|------|----|----|
| Test Method:          | ANSI C63.10:2013   |                       |              |  |            |         |          |           |           |       |    |    |      |    |    |
| Test Frequency Range: | 150KHz to 30MHz  |                       |              |  |            |         |          |           |           |       |    |    |      |    |    |
| Class / Severity:     | Class B  |                       |              |  |            |         |          |           |           |       |    |    |      |    |    |
| Receiver setup:       | RBW=9KHz, VBW=30KHz, Sweep time=auto   |                       |              |  |            |         |          |           |           |       |    |    |      |    |    |
| Limit:                | <table border="1"> <thead> <tr> <th rowspan="2">Frequency range (MHz)</th> <th colspan="2">Limit (dBuV)</th> </tr> <tr> <th>Quasi-peak</th> <th>Average</th> </tr> </thead> <tbody> <tr> <td>0.15-0.5</td> <td>66 to 56*</td> <td>56 to 46*</td> </tr> <tr> <td>0.5-5</td> <td>56</td> <td>46</td> </tr> <tr> <td>5-30</td> <td>60</td> <td>50</td> </tr> </tbody> </table> <p>* Decreases with the logarithm of the frequency.</p>  | Frequency range (MHz) | Limit (dBuV) |  | Quasi-peak | Average | 0.15-0.5 | 66 to 56* | 56 to 46* | 0.5-5 | 56 | 46 | 5-30 | 60 | 50 |
| Frequency range (MHz) | Limit (dBuV)   |                       |              |  |            |         |          |           |           |       |    |    |      |    |    |
|                       | Quasi-peak   | Average               |              |  |            |         |          |           |           |       |    |    |      |    |    |
| 0.15-0.5              | 66 to 56*  | 56 to 46*             |              |  |            |         |          |           |           |       |    |    |      |    |    |
| 0.5-5                 | 56   | 46                    |              |  |            |         |          |           |           |       |    |    |      |    |    |
| 5-30                  | 60   | 50                    |              |  |            |         |          |           |           |       |    |    |      |    |    |
| Test setup:           |  <p><i>Remark</i><br/>       E.U.T: Equipment Under Test<br/>       LISN: Line Impedance Stabilization Network<br/>       Test table height=0.8m</p>  |                       |              |  |            |         |          |           |           |       |    |    |      |    |    |
| Test procedure:       | <ol style="list-style-type: none"> <li>1. The E.U.T and simulators are connected to the main power through a line impedance stabilization network (L.I.S.N.). This provides a 50ohm/50uH coupling impedance for the measuring equipment.</li> <li>2. The peripheral devices are also connected to the main power through a LISN that provides a 50ohm/50uH coupling impedance with 50ohm termination. (Please refer to the block diagram of the test setup and photographs).</li> <li>3. Both sides of A.C. line are checked for maximum conducted interference. In order to find the maximum emission, the relative positions of equipment and all of the interface cables must be changed according to ANSI C63.10:2013 on conducted measurement.</li> </ol> |                       |              |  |            |         |          |           |           |       |    |    |      |    |    |
| Test Instruments:     | Refer to section 6.0 for details   |                       |              |  |            |         |          |           |           |       |    |    |      |    |    |
| Test mode:            | Refer to section 5.2 for details   |                       |              |  |            |         |          |           |           |       |    |    |      |    |    |
| Test results:         | Pass   |                       |              |  |            |         |          |           |           |       |    |    |      |    |    |

### Measurement data:

BlueAsia of Technical Services(Shenzhen) Co., Ltd.

IOT Test Centre of BlueAsia,

No. 448 Bulong Road, Bantian Street, Longgang District, Shenzhen, China

Telephone: TEL: +86-755-28682673 FAX: +86-755-28682673

**Line:**

|                         |               |                      |             |
|-------------------------|---------------|----------------------|-------------|
| <b>EUT:</b>             | TWS Earphones | <b>Probe:</b>        | L1          |
| <b>Model:</b>           | E2            | <b>Power Source:</b> | AC120V/60Hz |
| <b>Mode:</b>            | BT mode       | <b>Test by:</b>      | Eason       |
| <b>Temp./Hum.(%RH):</b> | 26°C/60%RH    |                      |             |

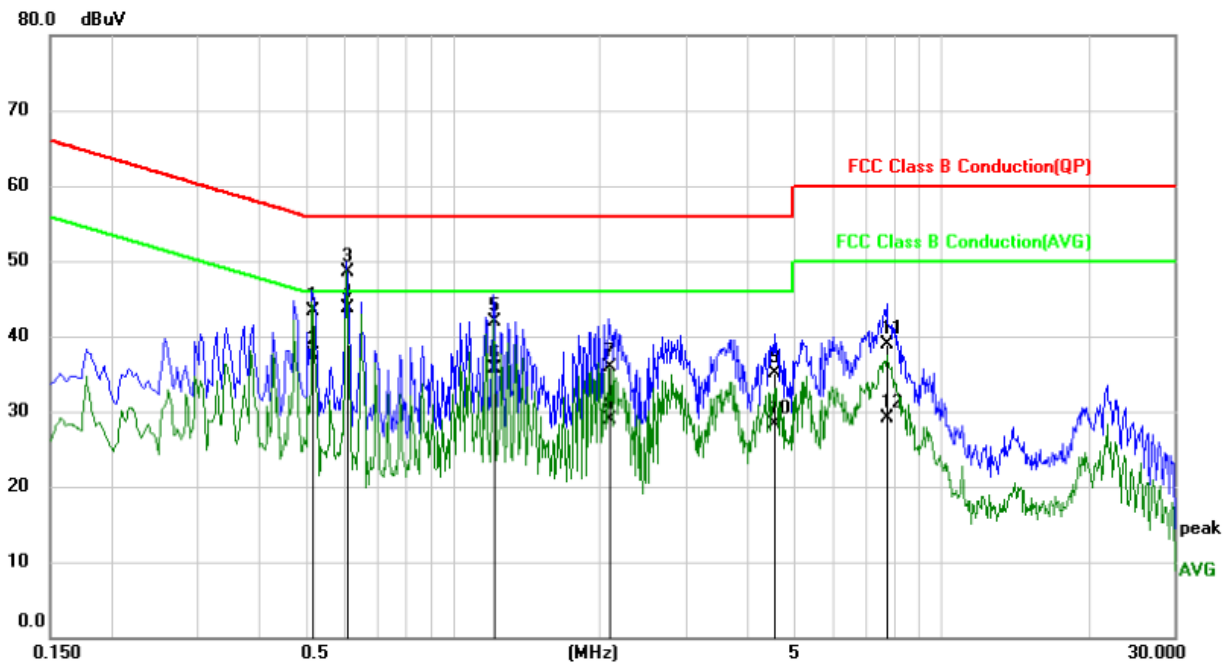

| No. | Mk. | Freq.  | Reading | Correct | Measure- | Limit | Over   |          |
|-----|-----|--------|---------|---------|----------|-------|--------|----------|
|     |     | MHz    | Level   | Factor  | ment     |       |        | Detector |
|     |     |        | dBuV    | dB      | dBuV     | dBuV  | dB     |          |
| 1   |     | 0.5180 | 33.52   | 9.73    | 43.25    | 56.00 | -12.75 | QP       |
| 2   |     | 0.5180 | 27.74   | 9.73    | 37.47    | 46.00 | -8.53  | AVG      |
| 3   |     | 0.6060 | 38.75   | 9.74    | 48.49    | 56.00 | -7.51  | QP       |
| 4   | *   | 0.6060 | 34.01   | 9.74    | 43.75    | 46.00 | -2.25  | AVG      |
| 5   |     | 1.2140 | 32.12   | 9.81    | 41.93    | 56.00 | -14.07 | QP       |
| 6   |     | 1.2140 | 25.97   | 9.81    | 35.78    | 46.00 | -10.22 | AVG      |
| 7   |     | 2.0900 | 26.11   | 9.82    | 35.93    | 56.00 | -20.07 | QP       |
| 8   |     | 2.0900 | 19.07   | 9.82    | 28.89    | 46.00 | -17.11 | AVG      |
| 9   |     | 4.5660 | 25.19   | 9.86    | 35.05    | 56.00 | -20.95 | QP       |
| 10  |     | 4.5660 | 18.39   | 9.86    | 28.25    | 46.00 | -17.75 | AVG      |
| 11  |     | 7.7300 | 28.96   | 9.87    | 38.83    | 60.00 | -21.17 | QP       |
| 12  |     | 7.7300 | 19.24   | 9.87    | 29.11    | 50.00 | -20.89 | AVG      |

**Neutral:**

|                        |               |                      |             |
|------------------------|---------------|----------------------|-------------|
| <b>EUT:</b>            | TWS Earphones | <b>Probe:</b>        | N           |
| <b>Model:</b>          | E2            | <b>Power Source:</b> | AC120V/60Hz |
| <b>Mode:</b>           | BT mode       | <b>Test by:</b>      | Eason       |
| <b>Temp./Hum.(%H):</b> | 26°C/60%RH    |                      |             |

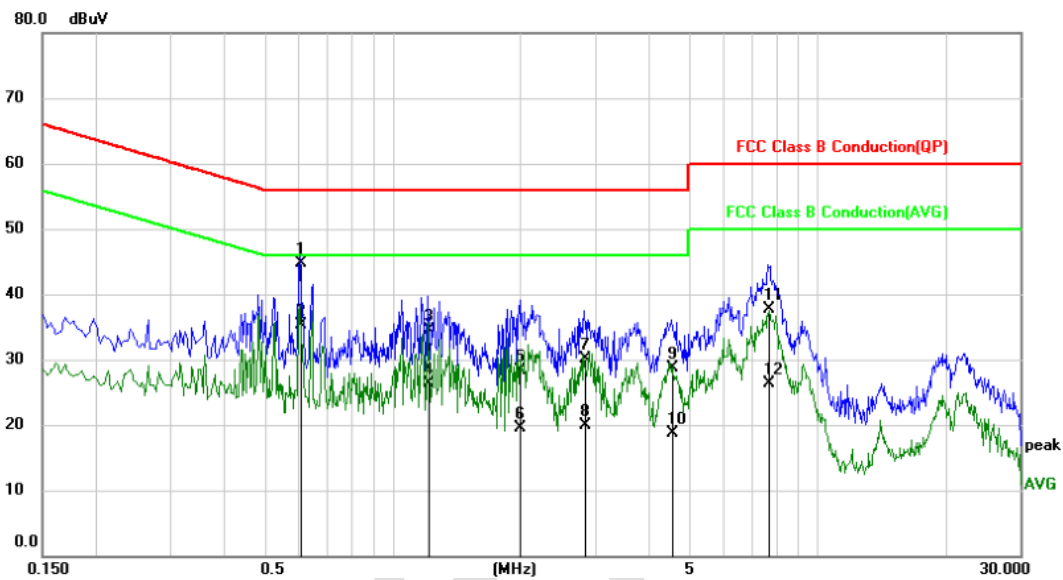

| No. | Mk. | Freq.  | Reading | Correct | Measure- | Limit | Over   |          |
|-----|-----|--------|---------|---------|----------|-------|--------|----------|
|     |     | MHz    | Level   | Factor  | ment     |       |        | Detector |
|     |     |        | dBuV    | dB      | dBuV     | dBuV  | dB     |          |
| 1   |     | 0.6060 | 34.87   | 9.74    | 44.61    | 56.00 | -11.39 | QP       |
| 2   | *   | 0.6060 | 25.59   | 9.74    | 35.33    | 46.00 | -10.67 | AVG      |
| 3   |     | 1.2140 | 24.71   | 9.83    | 34.54    | 56.00 | -21.46 | QP       |
| 4   |     | 1.2140 | 16.49   | 9.83    | 26.32    | 46.00 | -19.68 | AVG      |
| 5   |     | 1.9940 | 18.41   | 9.86    | 28.27    | 56.00 | -27.73 | QP       |
| 6   |     | 1.9940 | 9.61    | 9.86    | 19.47    | 46.00 | -26.53 | AVG      |
| 7   |     | 2.8260 | 20.27   | 9.88    | 30.15    | 56.00 | -25.85 | QP       |
| 8   |     | 2.8260 | 10.07   | 9.88    | 19.95    | 46.00 | -26.05 | AVG      |
| 9   |     | 4.5460 | 18.91   | 9.88    | 28.79    | 56.00 | -27.21 | QP       |
| 10  |     | 4.5460 | 8.73    | 9.88    | 18.61    | 46.00 | -27.39 | AVG      |
| 11  |     | 7.6780 | 27.91   | 9.86    | 37.77    | 60.00 | -22.23 | QP       |
| 12  |     | 7.6780 | 16.51   | 9.86    | 26.37    | 50.00 | -23.63 | AVG      |

**Notes:**

1. An initial pre-scan was performed on the line and neutral lines with peak detector.
2. Quasi-Peak and Average measurement were performed at the frequencies with maximized peak emission.

BlueAsia of Technical Services(Shenzhen) Co., Ltd.

IOT Test Centre of BlueAsia,

No. 448 Bulong Road, Bantian Street, Longgang District, Shenzhen, China

Telephone: TEL: +86-755-28682673 FAX: +86-755-28682673

3. Final Level =Receiver Read level +Correct Factor
4. Correct Factor = LISN Factor + Cable Loss

### 7.3 Conducted Peak Output Power

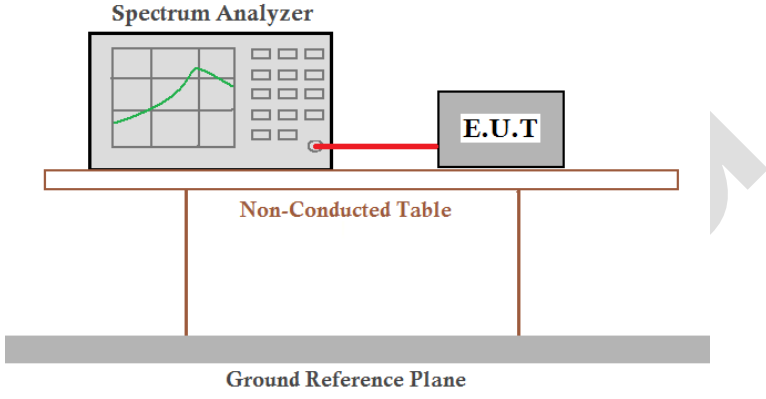
|                   |   |
|-------------------|---|
| Test Requirement: | FCC Part15 C Section 15.247 (b)(3)  |
| Test Method:      | ANSI C63.10:2013  |
| Limit:            | 21dBm(for BDR&EDR)  |
| Test setup:       |  |
| Test Instruments: | Refer to section 6.0 for details  |
| Test mode:        | Refer to section 5.2 for details  |
| Test results:     | Pass  |

#### Measurement Data

| Mode     | Test channel | Peak Output Power (dBm) | Limit (dBm) | Result |
|----------|--------------|-------------------------|-------------|--------|
| GFSK     | Lowest       | -2.32                   | 21.00       | Pass   |
|          | Middle       | -4.80                   |             |        |
|          | Highest      | -2.96                   |             |        |
| Pi/4QPSK | Lowest       | -1.55                   | 21.00       | Pass   |
|          | Middle       | -3.87                   |             |        |
|          | Highest      | -2.04                   |             |        |

Test plot as follows:

|            |           |
|------------|-----------|
| Test mode: | GFSK mode |
|------------|-----------|

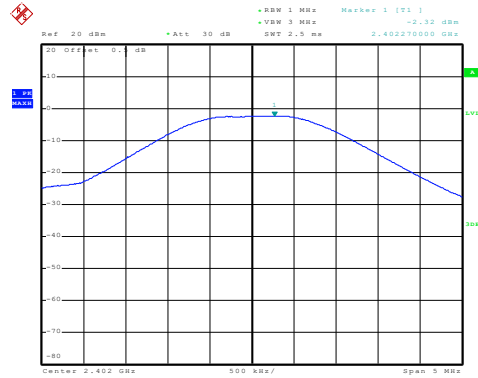

Date: 5.NOV.2019 14:38:11

Lowest channel

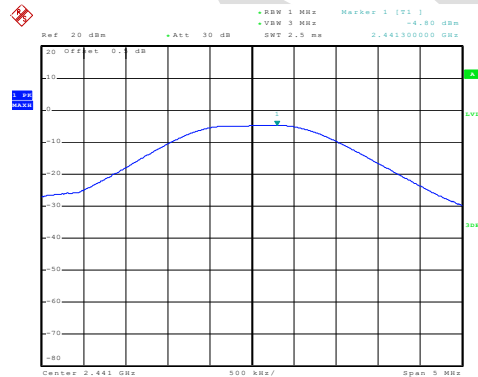

Date: 5.NOV.2019 14:41:41

Middle channel

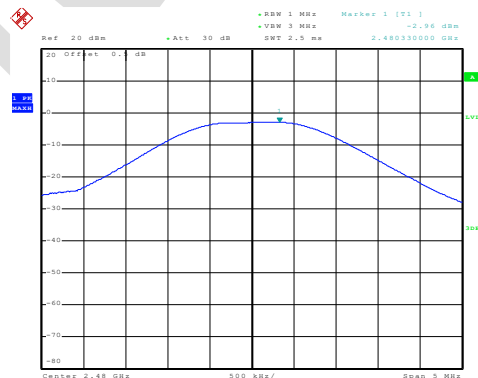

Date: 5.NOV.2019 14:42:36

Highest channel

Test mode: Pi/4QPSK mode

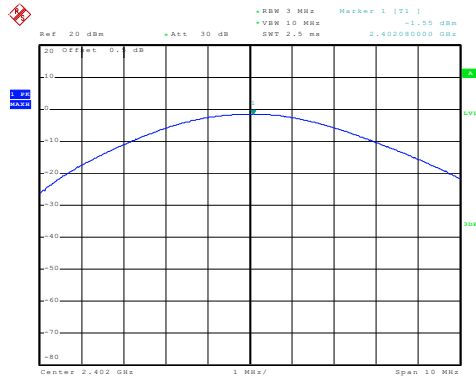

Date: 5.NOV.2019 14:45:22

Lowest channel

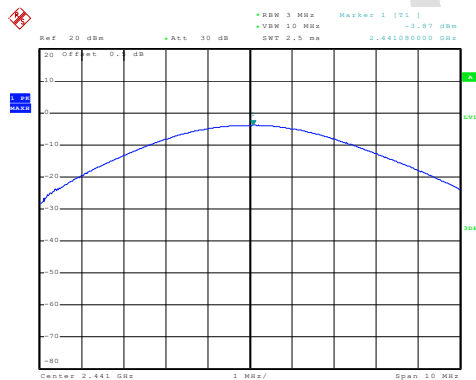

Date: 5.NOV.2019 14:46:09

Middle channel

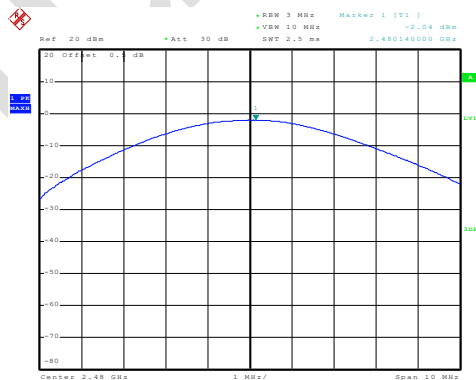

Date: 5.NOV.2019 14:46:56

Highest channel

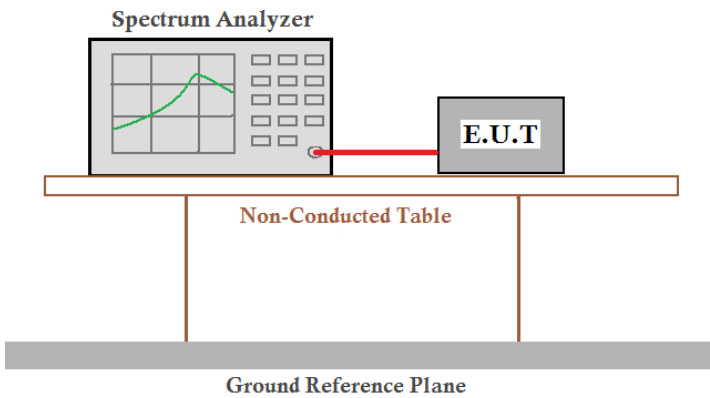

#### 7.4 20dB Emission Bandwidth

|                   |  |
|-------------------|--|
| Test Requirement: | FCC Part15 C Section 15.247 (a)(2)   |
| Test Method:      | ANSI C63.10:2013   |
| Limit:            | N/A  |
| Test setup:       |  |
| Test Instruments: | Refer to section 6.0 for details   |
| Test mode:        | Refer to section 5.2 for details   |
| Test results:     | Pass   |

#### Measurement Data

| Mode     | Test channel | 20dB Emission Bandwidth (MHz) | Result |
|----------|--------------|-------------------------------|--------|
| GFSK     | Lowest       | 1.108                         | Pass   |
|          | Middle       | 1.104                         |        |
|          | Highest      | 1.108                         |        |
| Pi/4QPSK | Lowest       | 1.218                         | Pass   |
|          | Middle       | 1.242                         |        |
|          | Highest      | 1.242                         |        |

Test plot as follows:

|            |           |
|------------|-----------|
| Test mode: | GFSK mode |
|------------|-----------|

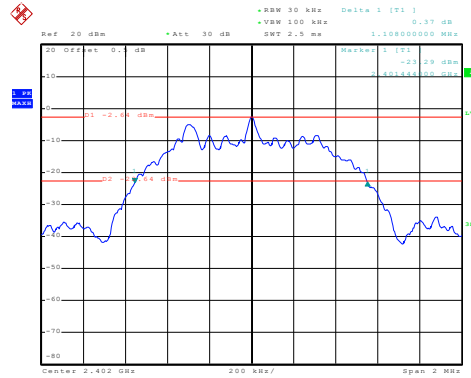

Date: 5.NOV.2019 14:50:08

Lowest channel

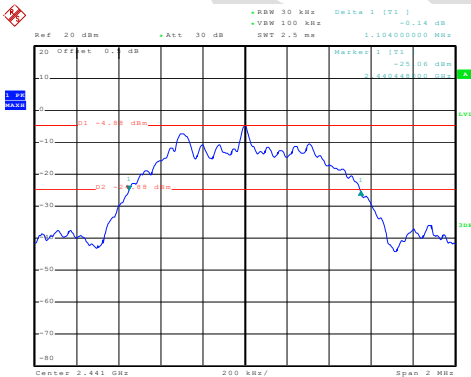

Date: 5.NOV.2019 14:51:54

Middle channel

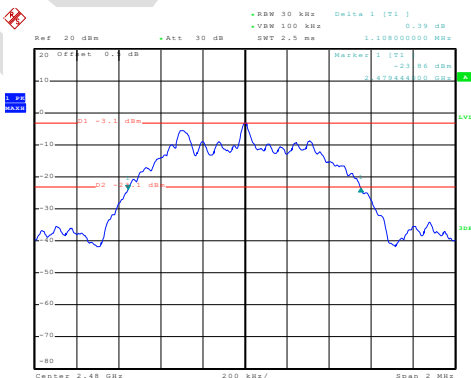

Date: 5.NOV.2019 14:53:24

Highest channel

Test mode: Pi/4QPSK mode

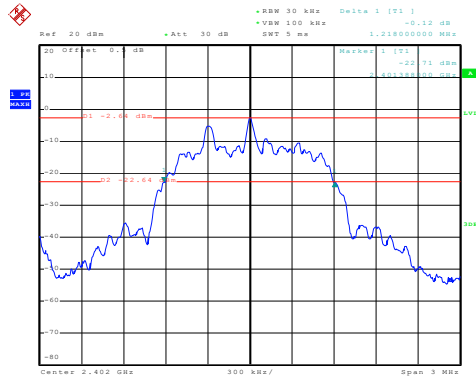

Date: 5.NOV.2019 14:54:58

Lowest channel

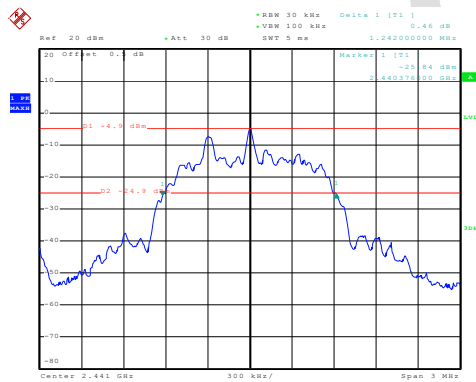

Date: 5.NOV.2019 14:56:19

Middle channel

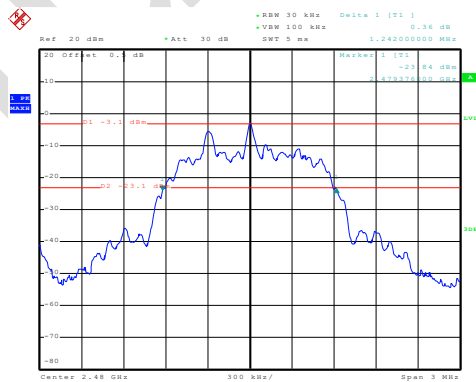

Date: 5.NOV.2019 14:57:39

Highest channel

### 7.5 Carrier Frequencies Separation

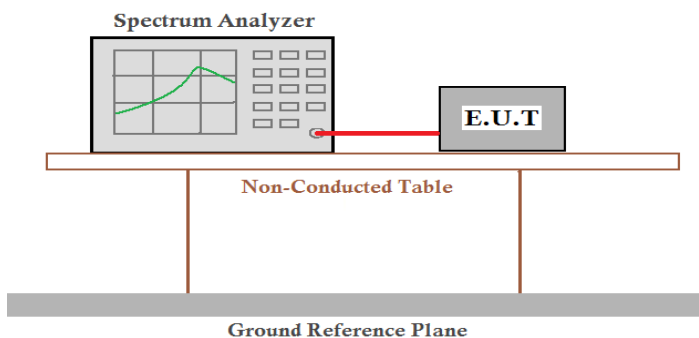
|                   |  |
|-------------------|--|
| Test Requirement: | FCC Part15 C Section 15.247 (a)(1)   |
| Test Method:      | ANSI C63.10:2013   |
| Receiver setup:   | RBW=100KHz, VBW=300KHz, detector=Peak  |
| Limit:            | GFSK & Pi/4QPSK : 0.025MHz or 2/3 of the 20dB bandwidth (whichever is greater)     |
| Test setup:       |  |
| Test Instruments: | Refer to section 6.0 for details   |
| Test mode:        | Refer to section 5.2 for details   |
| Test results:     | Pass   |

#### Measurement Data

| Mode     | Test channel | Carrier Frequencies Separation (kHz) | Limit (kHz) | Result |
|----------|--------------|--------------------------------------|-------------|--------|
| GFSK     | Lowest       | 1000                                 | 739         | Pass   |
|          | Middle       | 1000                                 | 739         | Pass   |
|          | Highest      | 1004                                 | 739         | Pass   |
| Pi/4QPSK | Lowest       | 1004                                 | 828         | Pass   |
|          | Middle       | 1000                                 | 828         | Pass   |
|          | Highest      | 1004                                 | 828         | Pass   |

Note: According to section 7.4

| Mode     | 20dB bandwidth (kHz)<br>(worse case) | Limit (kHz)<br>(Carrier Frequencies Separation) |
|----------|--------------------------------------|---|
| GFSK     | 1108                                 | 739   |
| Pi/4QPSK | 1242                                 | 828   |

**Test plot as follows:**

|                  |      |
|------------------|------|
| Modulation mode: | GFSK |
|------------------|------|

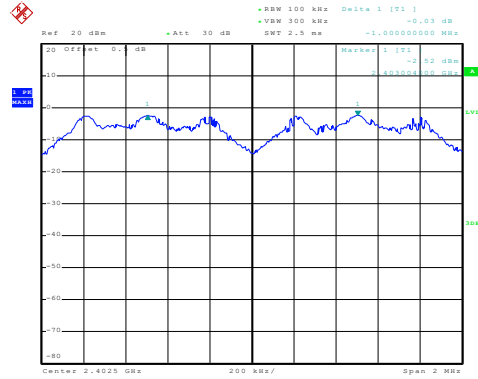

Date: 5.NOV.2019 15:21:33

Lowest channel

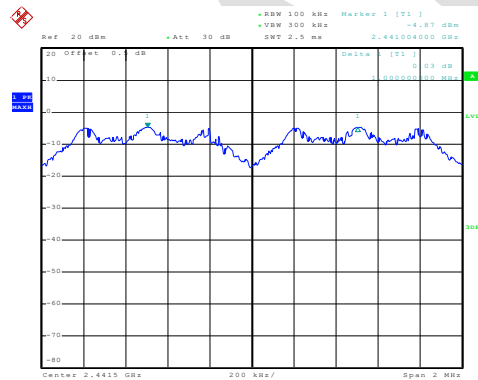

Date: 5.NOV.2019 15:23:29

Middle channel

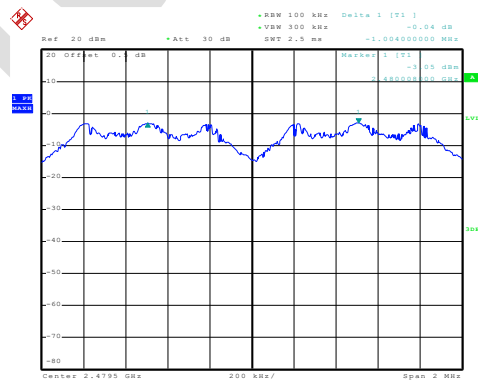

Date: 5.NOV.2019 15:25:40

Highest channel

Test mode: Pi/4QPSK mode

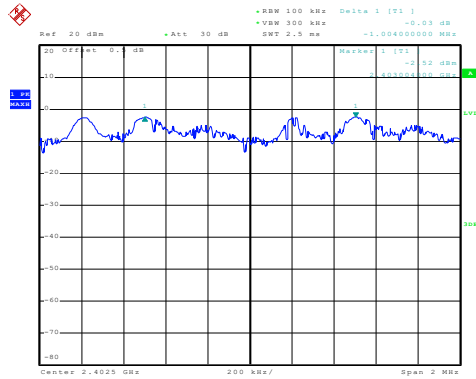

Date: 5.NOV.2019 15:30:29

Lowest channel

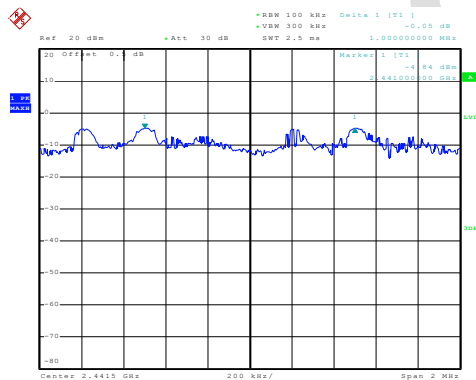

Date: 5.NOV.2019 15:32:22

Middle channel

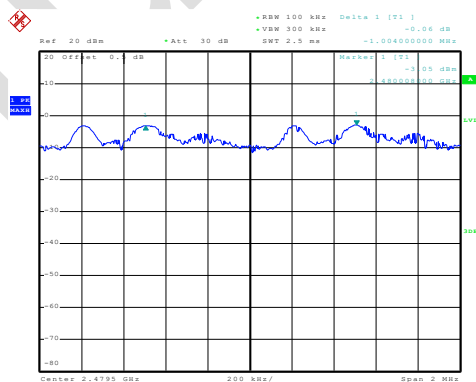

Date: 5.NOV.2019 15:28:30

Highest channel

### 7.6 Hopping Channel Number

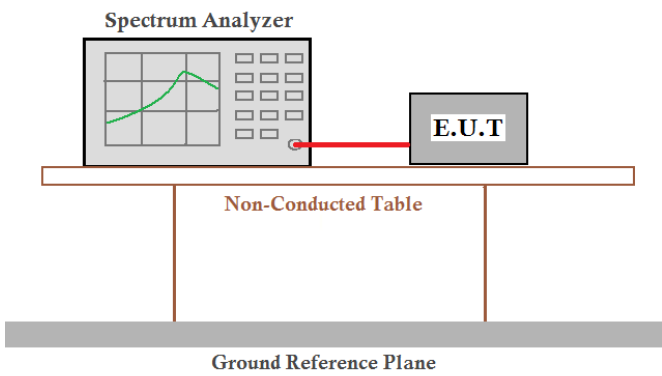
|                   |  |
|-------------------|--|
| Test Requirement: | FCC Part15 C Section 15.247 (a)(1)   |
| Test Method:      | ANSI C63.10:2013   |
| Receiver setup:   | RBW=100kHz, VBW=300kHz, Frequency range=2400MHz-2483.5MHz, Detector=Peak           |
| Limit:            | 15 channels  |
| Test setup:       |  |
| Test Instruments: | Refer to section 6.0 for details   |
| Test mode:        | Refer to section 5.2 for details   |
| Test results:     | Pass   |

#### Measurement Data:

| Mode     | Hopping channel numbers | Limit | Result |
|----------|-------------------------|-------|--------|
| GFSK     | 79                      | 15    | Pass   |
| Pi/4QPSK | 79                      | 15    | Pass   |

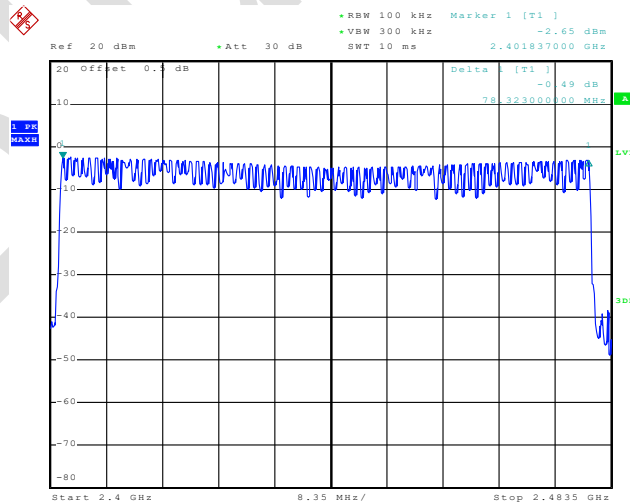

Date: 5.NOV.2019 16:01:00

## 7.7 Dwell Time

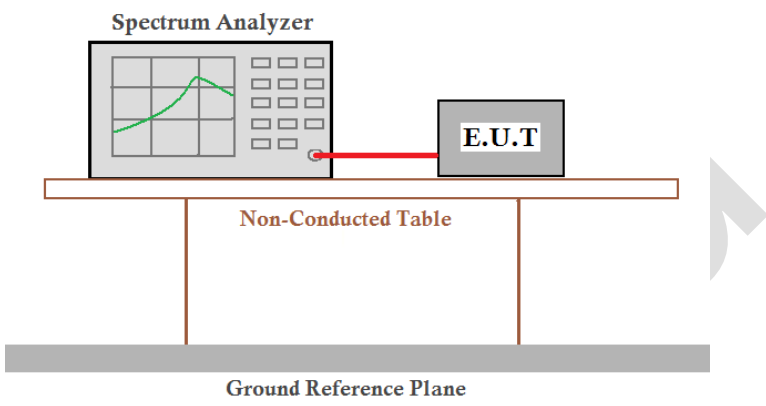
|                   |  |
|-------------------|--|
| Test Requirement: | FCC Part15 C Section 15.247 (a)(1)   |
| Test Method:      | ANSI C63.10:2013   |
| Receiver setup:   | RBW=1MHz, VBW=1MHz, Span=0Hz, Detector=Peak  |
| Limit:            | 0.4 Second   |
| Test setup:       |  |
| Test Instruments: | Refer to section 6.0 for details   |
| Test mode:        | Refer to section 5.2 for details   |
| Test results:     | Pass   |

### Measurement Data

| Frequency | Packet    | Dwell time(ms) | Limit(ms) | Result |
|-----------|-----------|----------------|-----------|--------|
| 2441MHz   | DH1/2-DH1 | 140.16         | 400       | Pass   |
| 2441MHz   | DH3/2-DH3 | 274.56         | 400       | Pass   |
| 2441MHz   | DH5/2-DH5 | 315.73         | 400       | Pass   |

The test period:  $T = 0.4 \text{ Second/Channel} \times 79 \text{ Channel} = 31.6 \text{ s}$

Test channel: 2441MHz as blow

DH1/2-DH1 time slot =  $0.438(\text{ms}) \times (1600 / (2 \times 79)) \times 31.6 = 140.16\text{ms}$

DH3/2-DH3 time slot =  $1.716(\text{ms}) \times (1600 / (4 \times 79)) \times 31.6 = 274.56\text{ms}$

DH5/2-DH5 time slot =  $2.960(\text{ms}) \times (1600 / (6 \times 79)) \times 31.6 = 315.73\text{ms}$

Test plot as follows:



|               |         |
|---------------|---------|
| Test channel: | 2441MHz |
|---------------|---------|

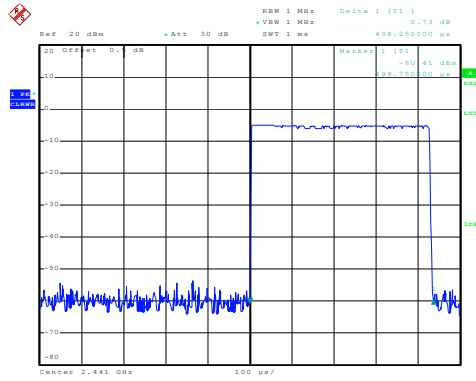

Date: 5.NOV.2019 15:51:46

DH1/2-DH1

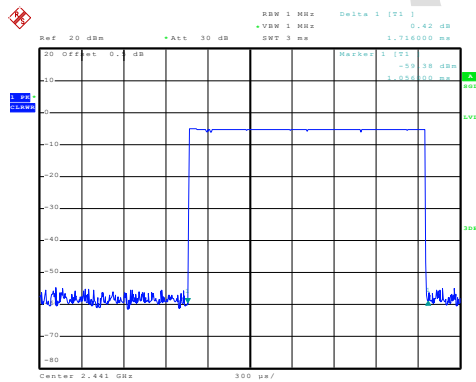

Date: 5.NOV.2019 15:53:18

DH3/2-DH3

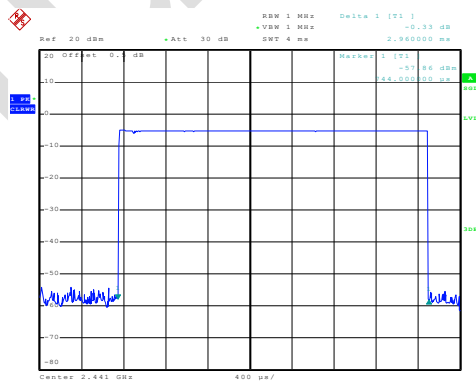

Date: 5.NOV.2019 15:56:34

DH5/2-DH5

### 7.8 Pseudorandom Frequency Hopping Sequence

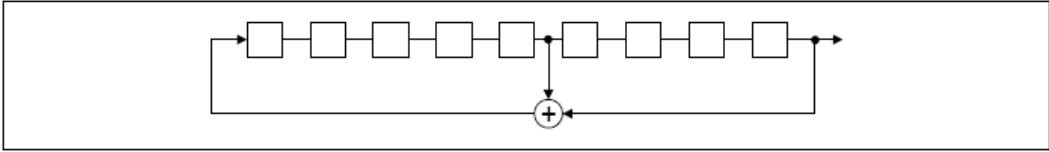
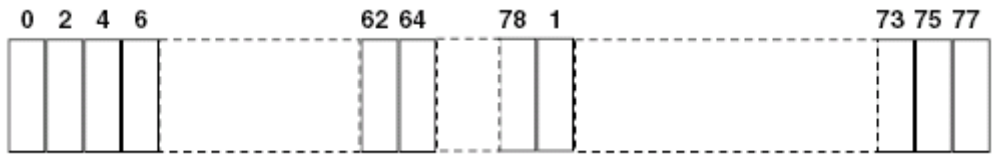
| Test Requirement:   | FCC Part15 C Section 15.247 (a)(1) requirement: |
|---|---|
| <p>Frequency hopping systems shall have hopping channel carrier frequencies separated by a minimum of 25 kHz or the 20 dB bandwidth of the hopping channel, whichever is greater.</p> <p>Alternatively. Frequency hopping systems operating in the 2400-2483.5 MHz band may have hopping channel carrier frequencies that are separated by 25 kHz or two-thirds of the 20 dB bandwidth of the hopping channel, whichever is greater, provided the systems operate with an output power no greater than 125 mW. The system shall hop to channel frequencies that are selected at the system hopping rate from a Pseudorandom ordered list of hopping frequencies. Each frequency must be used equally on the average by each transmitter. The system receivers shall have input bandwidths that match the hopping channel bandwidths of their corresponding transmitters and shall shift frequencies in synchronization with the transmitted signals.</p>  |   |
| EUT Pseudorandom Frequency Hopping Sequence   |   |
| <p>The pseudorandom sequence may be generated in a nine-stage shift register whose 5th and 9th stage outputs are added in a modulo-two addition stage. And the result is fed back to the input of the first stage. The sequence begins with the first ONE of 9 consecutive ONES; i.e. the shift register is initialized with nine ones.</p> <ul style="list-style-type: none"> <li>• Number of shift register stages: 9</li> <li>• Length of pseudo-random sequence: <math>2^9 - 1 = 511</math> bits</li> <li>• Longest sequence of zeros: 8 (non-inverted signal)</li> </ul> <div data-bbox="244 1016 1297 1167" style="text-align: center;">  </div> <p style="text-align: center;"><i>Linear Feedback Shift Register for Generation of the PRBS sequence</i></p> <p>An example of Pseudorandom Frequency Hopping Sequence as follow:</p> <div data-bbox="244 1263 1240 1417" style="text-align: center;">  </div> <p>Each frequency used equally on the average by each transmitter.<br/>The system receivers have input bandwidths that match the hopping channel bandwidths of their corresponding transmitters and shift frequencies in synchronization with the transmitted signals.</p> |   |

## 7.9 Band Edge

### 7.9.1 Conducted Emission Method

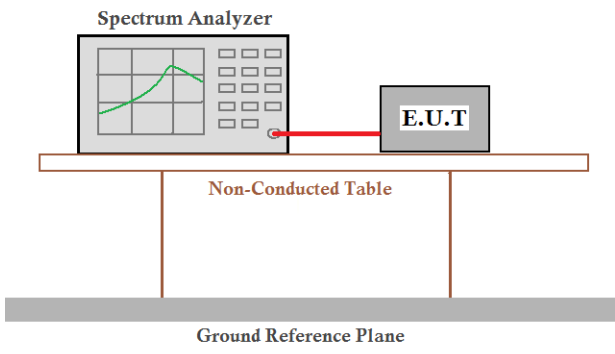
|                   |   |
|-------------------|---|
| Test Requirement: | FCC Part15 C Section 15.247 (d)   |
| Test Method:      | ANSI C63.10:2013  |
| Receiver setup:   | RBW=100kHz, VBW=300kHz, Detector=Peak   |
| Limit:            | In any 100 kHz bandwidth outside the frequency band in which the spread spectrum intentional radiator is operating, the radio frequency power that is produced by the intentional radiator shall be at least 20 dB below that in the 100 kHz bandwidth within the band that contains the highest level of the desired power, based on either an RF conducted or a radiated measurement. |
| Test setup:       |  <p>The diagram illustrates the test setup. A Spectrum Analyzer is connected to an E.U.T. (Equipment Under Test) via a red cable. Both are placed on a Non-Conducted Table, which is supported by a Ground Reference Plane.</p>  |
| Test Instruments: | Refer to section 6.0 for details  |
| Test mode:        | Refer to section 5.2 for details  |
| Test results:     | Pass  |

Test plot as follows:

**GFSK Mode:**

|               |                |
|---------------|----------------|
| Test channel: | Lowest channel |
|---------------|----------------|

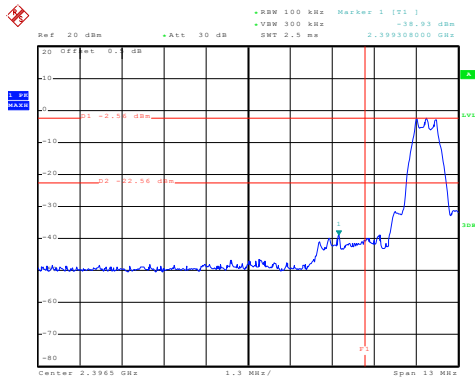

Date: 5 NOV 2019 15:07:08

No-hopping mode

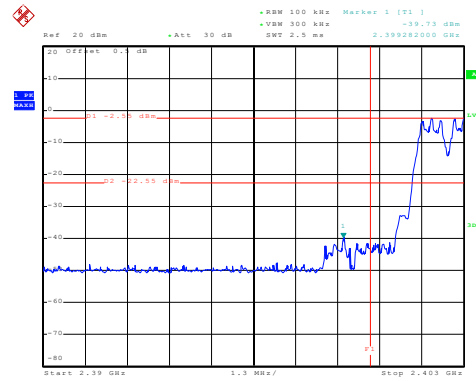

Date: 5 NOV 2019 15:04:23

Hopping mode

|               |                 |
|---------------|-----------------|
| Test channel: | Highest channel |
|---------------|-----------------|

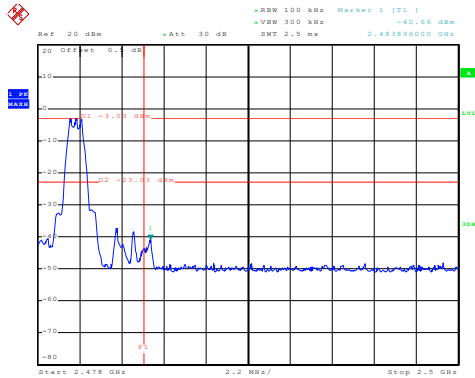

Date: 5.NOV.2019 15:10:29

No-hopping mode

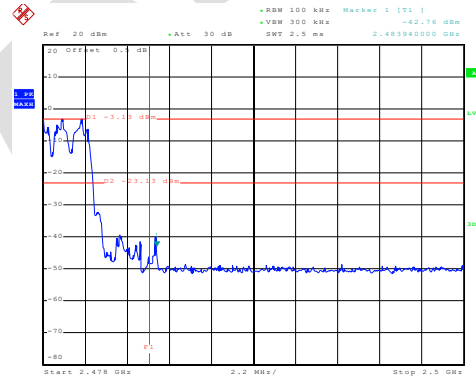

Date: 5.NOV.2019 15:12:03

Hopping mode

**Pi/4QPSK Mode:**

|               |                |
|---------------|----------------|
| Test channel: | Lowest channel |
|---------------|----------------|

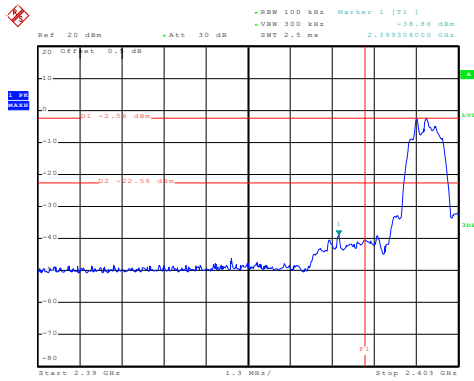

Date: 5 NOV 2019 15:08:07

No-hopping mode

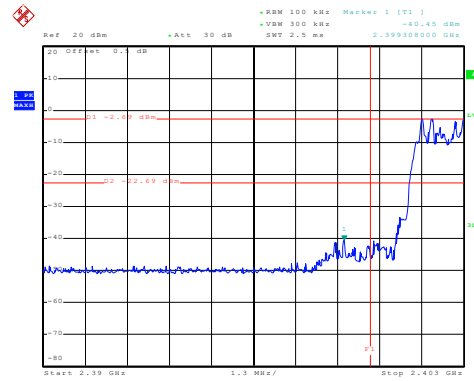

Date: 5 NOV 2019 15:06:30

Hopping mode

|               |                 |
|---------------|-----------------|
| Test channel: | Highest channel |
|---------------|-----------------|

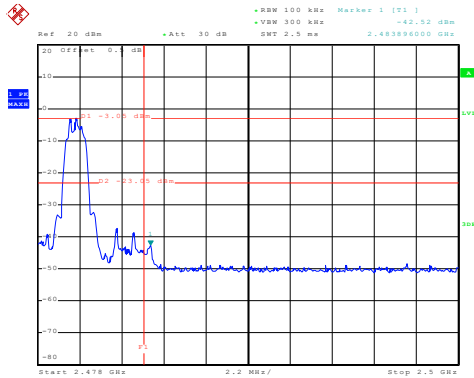

Date: 5.NOV.2019 15:15:45

No-hopping mode

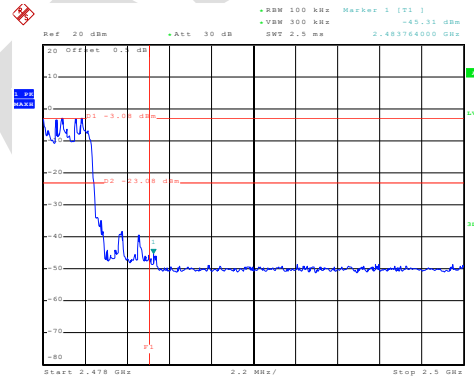

Date: 5.NOV.2019 15:14:20

Hopping mode

### 7.9.2 Radiated Emission Method

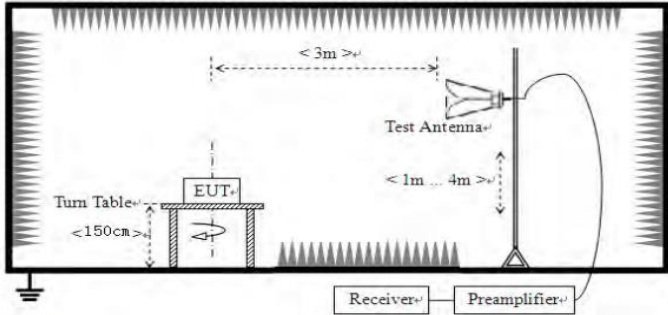
|                       |   |          |                    |      |               |
|-----------------------|---|----------|--------------------|------|---------------|
| Test Requirement:     | FCC Part15 C Section 15.209 and 15.205  |          |                    |      |               |
| Test Method:          | ANSI C63.10:2013  |          |                    |      |               |
| Test Frequency Range: | All restriction band have been tested, and 2310MHz to 2390MHz, 2483.5MHz to 2500MHz band is the worse case  |          |                    |      |               |
| Test site:            | Measurement Distance: 3m  |          |                    |      |               |
| Receiver setup:       | Frequency   | Detector | RBW                | VBW  | Remark        |
|                       | Above 1GHz  | Peak     | 1MHz               | 3MHz | Peak Value    |
|                       |   | Peak     | 1MHz               | 10Hz | Average Value |
| Limit:                | Frequency   |          | Limit (dBuV/m @3m) |      | Remark        |
|                       | Above 1GHz  |          | 54.00              |      | Average Value |
|                       |   |          | 74.00              |      | Peak Value    |
| Test setup:           |    |          |                    |      |               |
| Test Procedure:       | <ol style="list-style-type: none"> <li>1. The EUT was placed on the top of a rotating table 1.5 meters above the ground at a 3 meter camber. The table was rotated 360 degrees to determine the position of the highest radiation.</li> <li>2. The EUT was set 3 meters away from the interference-receiving antenna, which was mounted on the top of a variable-height antenna tower.</li> <li>3. The antenna height is varied from one meter to four meters above the ground to determine the maximum value of the field strength. Both horizontal and vertical polarizations of the antenna are set to make the measurement.</li> <li>4. For each suspected emission, the EUT was arranged to its worst case and then the antenna was tuned to heights from 1 meter to 4 meters and the rota table was turned from 0 degrees to 360 degrees to find the maximum reading.</li> <li>5. The test-receiver system was set to Peak Detect Function and Specified Bandwidth with Maximum Hold Mode.</li> <li>6. If the emission level of the EUT in peak mode was 10dB lower than the limit specified, then testing could be stopped and the peak values of the EUT would be reported. Otherwise the emissions that did not have 10dB margin would be re-tested one by one using peak, quasi-peak or average method as specified and then reported in a data sheet.</li> </ol> |          |                    |      |               |
| Test Instruments:     | Refer to section 6.0 for details  |          |                    |      |               |
| Test mode:            | Refer to section 5.2 for details  |          |                    |      |               |
| Test results:         | Pass  |          |                    |      |               |

## Remark:

1. During the test, pre-scan the GFSK, Pi/4QPSK modulation, and found the Pi/4QPSK modulation which it is worse case.

|               |        |
|---------------|--------|
| Test channel: | Lowest |
|---------------|--------|

## Peak value:

| Frequency (MHz) | Read Level (dBuV) | Correct factor (dB/m) | Level (dBuV/m) | Limit Line (dBuV/m) | Over Limit (dB) | Polarization |
|-----------------|-------------------|-----------------------|----------------|---------------------|-----------------|--------------|
| 2310.00         | 56.89             | -14.42                | 42.47          | 74.00               | -31.53          | Horizontal   |
| 2390.00         | 55.46             | -14.11                | 41.35          | 74.00               | -32.65          | Horizontal   |
| 2310.00         | 57.31             | -14.71                | 42.60          | 74.00               | -31.40          | Vertical     |
| 2390.00         | 56.53             | -14.44                | 42.09          | 74.00               | -31.97          | Vertical     |

## Average value:

| Frequency (MHz) | Read Level (dBuV) | Correct factor (dB/m) | Level (dBuV/m) | Limit Line (dBuV/m) | Over Limit (dB) | Polarization |
|-----------------|-------------------|-----------------------|----------------|---------------------|-----------------|--------------|
| 2310.00         | 43.50             | -14.42                | 29.08          | 54.00               | -24.92          | Horizontal   |
| 2390.00         | 42.97             | -14.11                | 28.86          | 54.00               | -25.14          | Horizontal   |
| 2310.00         | 42.55             | -14.71                | 27.84          | 54.00               | -26.16          | Vertical     |
| 2390.00         | 42.87             | -14.44                | 28.43          | 54.00               | -25.57          | Vertical     |

|               |         |
|---------------|---------|
| Test channel: | Highest |
|---------------|---------|

## Peak value:

| Frequency (MHz) | Read Level (dBuV) | Correct factor (dB/m) | Level (dBuV/m) | Limit Line (dBuV/m) | Over Limit (dB) | Polarization |
|-----------------|-------------------|-----------------------|----------------|---------------------|-----------------|--------------|
| 2483.50         | 56.93             | -13.61                | 43.32          | 74.00               | -30.68          | Horizontal   |
| 2500.00         | 59.09             | -13.53                | 45.56          | 74.00               | -28.44          | Horizontal   |
| 2483.50         | 62.30             | -14.00                | 48.30          | 74.00               | -25.70          | Vertical     |
| 2500.00         | 59.04             | -13.93                | 45.11          | 74.00               | -28.89          | Vertical     |

## Average value:

| Frequency (MHz) | Read Level (dBuV) | Correct factor (dB/m) | Level (dBuV/m) | Limit Line (dBuV/m) | Over Limit (dB) | Polarization |
|-----------------|-------------------|-----------------------|----------------|---------------------|-----------------|--------------|
| 2483.50         | 42.63             | -13.61                | 29.02          | 54.00               | -24.98          | Horizontal   |
| 2500.00         | 45.08             | -13.53                | 31.55          | 54.00               | -22.45          | Horizontal   |
| 2483.50         | 44.65             | -14.00                | 30.65          | 54.00               | -23.35          | Vertical     |
| 2500.00         | 51.34             | -13.93                | 37.41          | 54.00               | -16.59          | Vertical     |

## Remark:

1. Final Level = Receiver Read level + Correct factor
2. The emission levels of other frequencies are very lower than the limit and not show in test report.
3. Correct factor = Antenna Factor + Cable Loss – Preamplifier Factor

## 7.10 Spurious Emission

### 7.10.1 Conducted Emission Method

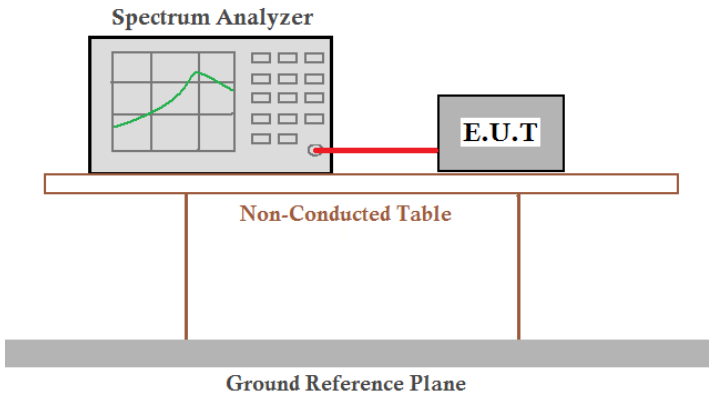
|                   |   |
|-------------------|---|
| Test Requirement: | FCC Part15 C Section 15.247 (d)   |
| Test Method:      | ANSI C63.10:2013  |
| Limit:            | In any 100 kHz bandwidth outside the frequency band in which the spread spectrum intentional radiator is operating, the radio frequency power that is produced by the intentional radiator shall be at least 20 dB below that in the 100 kHz bandwidth within the band that contains the highest level of the desired power, based on either an RF conducted or a radiated measurement. |
| Test setup:       |  <p>The diagram illustrates the test setup. A Spectrum Analyzer is connected to an E.U.T. (Equipment Under Test) via a red cable. Both are placed on a Non-Conducted Table, which is supported by a Ground Reference Plane.</p>  |
| Test Instruments: | Refer to section 6.0 for details  |
| Test mode:        | Refer to section 5.2 for details  |
| Test results:     | Pass  |

**Remark:**

During the test, pre-scan the GFSK, Pi/4QPSK modulation, and found the Pi/4QPSK modulation which it is worse case.



|               |                |
|---------------|----------------|
| Test channel: | Lowest channel |
|---------------|----------------|

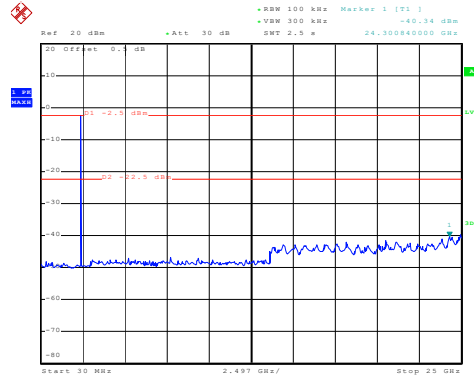

30MHz~25GHz

|               |                |
|---------------|----------------|
| Test channel: | Middle channel |
|---------------|----------------|

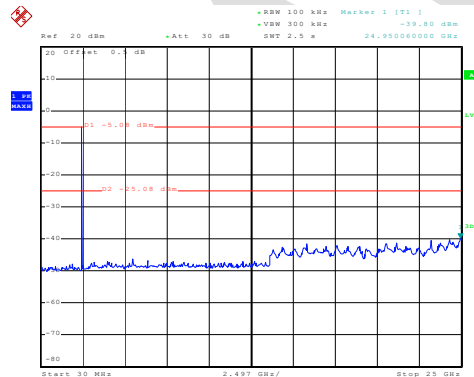

30MHz~25GHz

|               |                 |
|---------------|-----------------|
| Test channel: | Highest channel |
|---------------|-----------------|

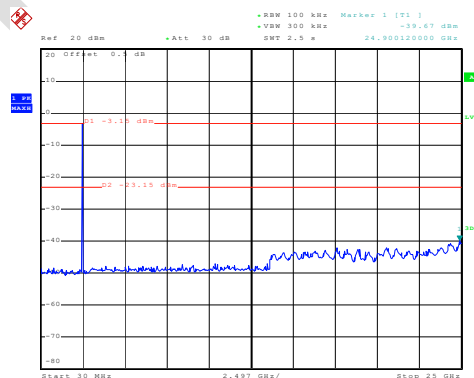

30MHz~25GHz

**7.10.2 Radiated Emission Method**

|                                |  |              |         |                      |            |
|--------------------------------|--|--------------|---------|----------------------|------------|
| Test Requirement:              | FCC Part15 C Section 15.209  |              |         |                      |            |
| Test Method:                   | ANSI C63.10:2013   |              |         |                      |            |
| Test Frequency Range:          | 9kHz to 25GHz  |              |         |                      |            |
| Test site:                     | Measurement Distance: 3m   |              |         |                      |            |
| Receiver setup:                | Frequency  | Detector     | RBW     | VBW                  | Value      |
|                                | 9KHz-150KHz  | Quasi-peak   | 200Hz   | 600Hz                | Quasi-peak |
|                                | 150KHz-30MHz   | Quasi-peak   | 9KHz    | 30KHz                | Quasi-peak |
|                                | 30MHz-1GHz   | Quasi-peak   | 120KHz  | 300KHz               | Quasi-peak |
|                                | Above 1GHz   | Peak         | 1MHz    | 3MHz                 | Peak       |
| Peak                           |  | 1MHz         | 10Hz    | Average              |            |
| Limit:<br>(Spurious Emissions) | Frequency  | Limit (uV/m) | Value   | Measurement Distance |            |
|                                | 0.009MHz-0.490MHz  | 2400/F(KHz)  | QP      | 300m                 |            |
|                                | 0.490MHz-1.705MHz  | 24000/F(KHz) | QP      | 30m                  |            |
|                                | 1.705MHz-30MHz   | 30           | QP      | 30m                  |            |
|                                | 30MHz-88MHz  | 100          | QP      | 3m                   |            |
|                                | 88MHz-216MHz   | 150          | QP      |                      |            |
|                                | 216MHz-960MHz  | 200          | QP      |                      |            |
|                                | 960MHz-1GHz  | 500          | QP      |                      |            |
|                                | Above 1GHz   | 500          | Average |                      |            |
| 5000                           |  | Peak         |         |                      |            |
| Limit:<br>(band edge)          | Emissions radiated outside of the specified frequency bands, except for harmonics, shall be attenuated by at least 50 dB below the level of the fundamental or to the general radiated emission limits in Section 15.209, whichever is the lesser attenuation. |              |         |                      |            |

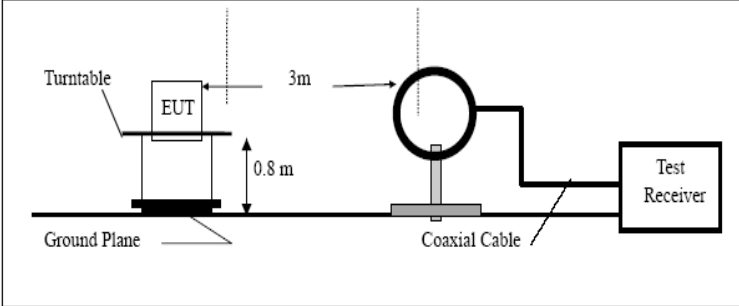
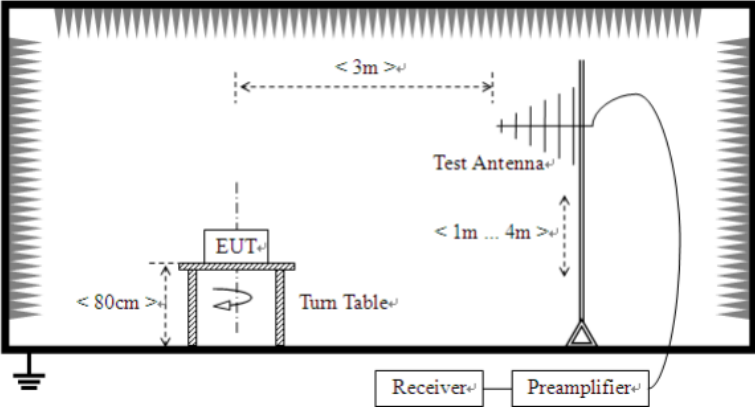
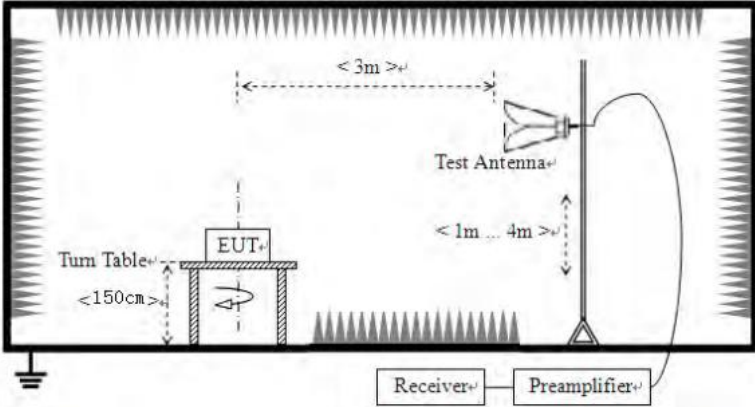
|                        |  |
|------------------------|--|
| <p>Test setup:</p>     | <p>Below 30MHz</p>  <p>Below 1GHz</p>  <p>Above 1GHz</p>    |
| <p>Test Procedure:</p> | <ol style="list-style-type: none"> <li>1. The EUT was placed on the top of a rotating table (0.8m for below 1G and 1.5m for above 1G) above the ground at a 3 meter camber. The table was rotated 360 degrees to determine the position of the highest radiation.</li> <li>2. The EUT was set 3 meters away from the interference-receiving antenna, which was mounted on the top of a variable-height antenna tower.</li> </ol> |

|                   |  |
|-------------------|--|
|                   | <ol style="list-style-type: none"> <li>3. The antenna height is varied from one meter to four meters above the ground to determine the maximum value of the field strength. Both horizontal and vertical polarizations of the antenna are set to make the measurement.</li> <li>4. For each suspected emission, the EUT was arranged to its worst case and then the antenna was tuned to heights from 1 meter to 4 meters and the rota table was turned from 0 degrees to 360 degrees to find the maximum reading.</li> <li>5. The test-receiver system was set to Peak Detect Function and Specified Bandwidth with Maximum Hold Mode.</li> <li>6. If the emission level of the EUT in peak mode was 10dB lower than the limit specified, then testing could be stopped and the peak values of the EUT would be reported. Otherwise the emissions that did not have 10dB margin would be re-tested one by one using peak, quasi-peak or average method as specified and then reported in a data sheet.</li> </ol> |
| Test Instruments: | Refer to section 6.0 for details   |
| Test mode:        | Refer to section 5.2 for details   |
| Test results:     | Pass   |

**Measurement data:**

*Remark:*

1. *During the test, pre-scan the GFSK, Pi/4QPSK modulation, and found the Pi/4QPSK modulation which it is worse case.*
2. *Pre-scan all kind of the place mode (X-axis, Y-axis, Z-axis), and found the Y-axis which it is worse case.*

■ **9 kHz ~ 30 MHz**

The low frequency, which started from 9 kHz to 30 MHz, was pre-scanned and the result which was 20 dB lower than the limit line per 15.31(o) was not reported.

■ Below 1GHz

|                        |               |                      |            |
|------------------------|---------------|----------------------|------------|
| <b>EUT:</b>            | TWS Earphones | <b>Polarziation:</b> | Horizontal |
| <b>Model:</b>          | E2            | <b>Power Source:</b> | DC3.7V     |
| <b>Mode:</b>           | BT mode       | <b>Test by:</b>      | Eason      |
| <b>Temp./Hum.(%H):</b> | 26°C/60%RH    |                      |            |

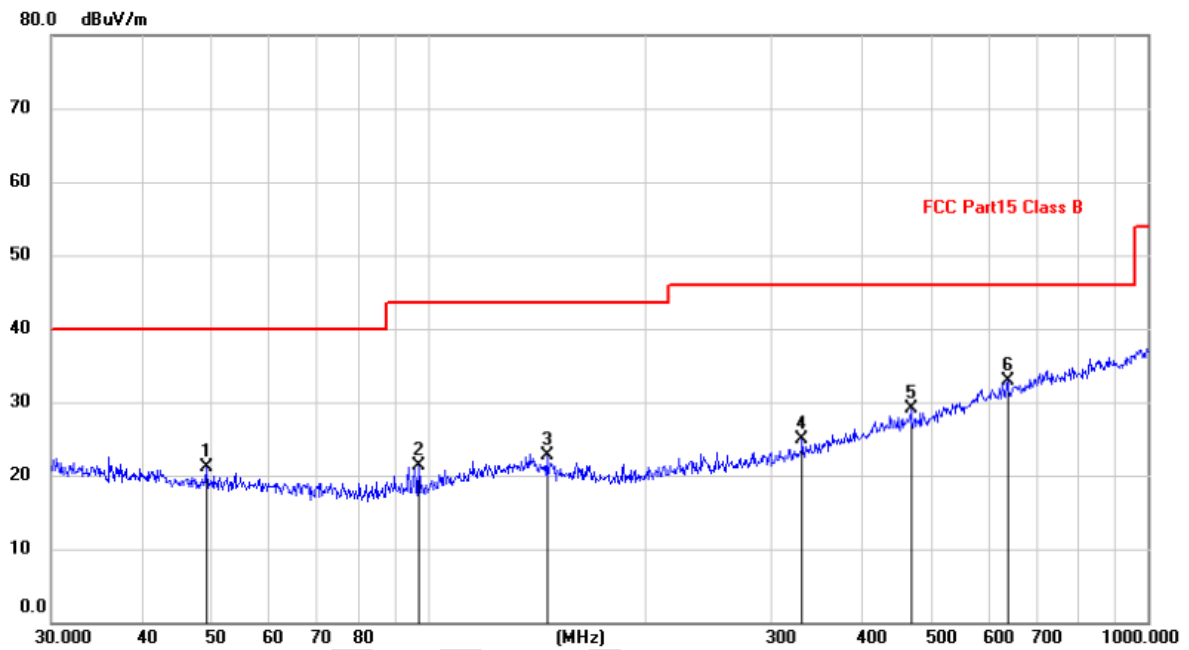

| No. | Mk. | Freq.<br>MHz | Reading<br>Level<br>dBuV | Correct<br>Factor<br>dB | Measure-<br>ment<br>dBuV/m | Limit<br>dBuV/m | Over<br>dB | Detector |
|-----|-----|--------------|--------------------------|-------------------------|----------------------------|-----------------|------------|----------|
| 1   |     | 49.3594      | 6.66                     | 14.36                   | 21.02                      | 40.00           | -18.98     | QP       |
| 2   |     | 97.1148      | 10.98                    | 10.25                   | 21.23                      | 43.50           | -22.27     | QP       |
| 3   |     | 146.3735     | 9.61                     | 13.16                   | 22.77                      | 43.50           | -20.73     | QP       |
| 4   |     | 331.3546     | 10.29                    | 14.68                   | 24.97                      | 46.00           | -21.03     | QP       |
| 5   |     | 468.8762     | 10.77                    | 18.25                   | 29.02                      | 46.00           | -16.98     | QP       |
| 6   | *   | 638.3686     | 11.28                    | 21.64                   | 32.92                      | 46.00           | -13.08     | QP       |

|                        |               |                      |          |
|------------------------|---------------|----------------------|----------|
| <b>EUT:</b>            | TWS Earphones | <b>Polarziation:</b> | Vertical |
| <b>Model:</b>          | E2            | <b>Power Source:</b> | DC3.7V   |
| <b>Mode:</b>           | BT mode       | <b>Test by:</b>      | Eason    |
| <b>Temp./Hum.(%H):</b> | 26°C/60%RH    |                      |          |

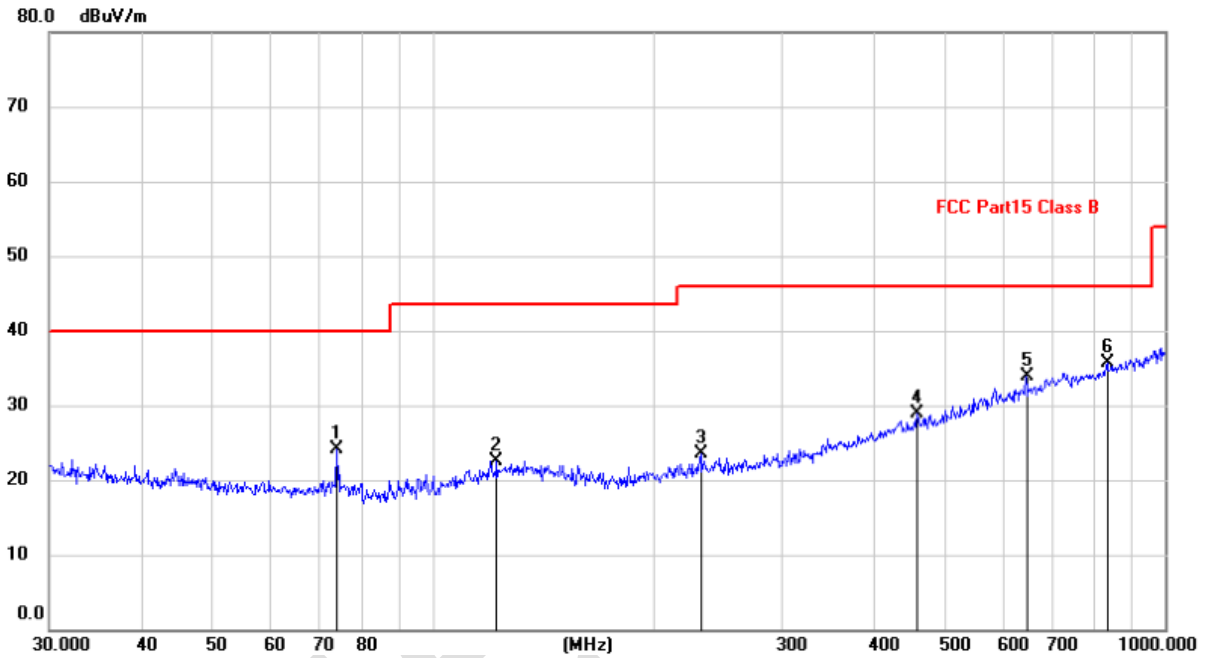

| No. | Mk. | Freq.<br>MHz | Reading<br>Level<br>dBuV | Correct<br>Factor<br>dB | Measure-<br>ment<br>dBuV/m | Limit<br>dBuV/m | Over<br>dB | Detector |
|-----|-----|--------------|--------------------------|-------------------------|----------------------------|-----------------|------------|----------|
| 1   |     | 74.1351      | 14.00                    | 10.20                   | 24.20                      | 40.00           | -15.80     | QP       |
| 2   |     | 122.4040     | 9.93                     | 12.64                   | 22.57                      | 43.50           | -20.93     | QP       |
| 3   |     | 232.5318     | 11.15                    | 12.35                   | 23.50                      | 46.00           | -22.50     | QP       |
| 4   |     | 459.1144     | 10.87                    | 18.07                   | 28.94                      | 46.00           | -17.06     | QP       |
| 5   |     | 645.1195     | 12.08                    | 21.74                   | 33.82                      | 46.00           | -12.18     | QP       |
| 6   | *   | 833.3171     | 11.30                    | 24.39                   | 35.69                      | 46.00           | -10.31     | QP       |

**■ Above 1GHz**

|               |        |
|---------------|--------|
| Test channel: | Lowest |
|---------------|--------|

**Peak value:**

| Frequency (MHz) | Read Level (dBuV) | Correct factor (dB/m) | Level (dBuV/m) | Limit Line (dBuV/m) | Over Limit (dB) | Polarization |
|-----------------|-------------------|-----------------------|----------------|---------------------|-----------------|--------------|
| 4804.00         | 54.30             | -7.87                 | 46.43          | 74.00               | -27.57          | Vertical     |
| 7206.00         | 56.81             | -2.42                 | 54.39          | 74.00               | -19.61          | Vertical     |
| 9608.00         | 55.23             | -2.38                 | 52.85          | 74.00               | -21.15          | Vertical     |
| 12010.00        | *                 |                       |                | 74.00               |                 | Vertical     |
| 14412.00        | *                 |                       |                | 74.00               |                 | Vertical     |
| 4804.00         | 56.17             | -7.87                 | 48.30          | 74.00               | -25.70          | Horizontal   |
| 7206.00         | 56.48             | -2.42                 | 54.06          | 74.00               | -19.94          | Horizontal   |
| 9608.00         | 55.16             | -2.38                 | 52.78          | 74.00               | -21.22          | Horizontal   |
| 12010.00        | *                 |                       |                | 74.00               |                 | Horizontal   |
| 14412.00        | *                 |                       |                | 74.00               |                 | Horizontal   |

**Average value:**

| Frequency (MHz) | Read Level (dBuV) | Correct factor (dB/m) | Level (dBuV/m) | Limit Line (dBuV/m) | Over Limit (dB) | Polarization |
|-----------------|-------------------|-----------------------|----------------|---------------------|-----------------|--------------|
| 4804.00         | 43.56             | -7.87                 | 35.69          | 54.00               | -18.31          | Vertical     |
| 7206.00         | 42.58             | -2.42                 | 40.16          | 54.00               | -13.84          | Vertical     |
| 9608.00         | 43.78             | -2.38                 | 41.40          | 54.00               | -12.60          | Vertical     |
| 12010.00        | *                 |                       |                | 54.00               |                 | Vertical     |
| 14412.00        | *                 |                       |                | 54.00               |                 | Vertical     |
| 4804.00         | 43.03             | -7.87                 | 35.16          | 54.00               | -18.84          | Horizontal   |
| 7206.00         | 44.15             | -2.42                 | 41.73          | 54.00               | -12.27          | Horizontal   |
| 9608.00         | 44.26             | -2.38                 | 41.83          | 54.00               | -12.12          | Horizontal   |
| 12010.00        | *                 |                       |                | 54.00               |                 | Horizontal   |
| 14412.00        | *                 |                       |                | 54.00               |                 | Horizontal   |

|               |        |
|---------------|--------|
| Test channel: | Middle |
|---------------|--------|

**Peak value:**

| Frequency (MHz) | Read Level (dBuV) | Correct factor (dB/m) | Level (dBuV/m) | Limit Line (dBuV/m) | Over Limit (dB) | Polarization |
|-----------------|-------------------|-----------------------|----------------|---------------------|-----------------|--------------|
| 4882.00         | 54.08             | -10.06                | 44.02          | 74.00               | -29.98          | Vertical     |
| 7323.00         | 56.49             | -2.40                 | 54.09          | 74.00               | -19.91          | Vertical     |
| 9764.00         | 55.72             | -2.38                 | 53.34          | 74.00               | -20.66          | Vertical     |
| 12205.00        | *                 |                       |                | 74.00               |                 | Vertical     |
| 14646.00        | *                 |                       |                | 74.00               |                 | Vertical     |
| 4882.00         | 56.98             | -10.06                | 46.92          | 74.00               | -27.08          | Horizontal   |
| 7323.00         | 56.71             | -2.40                 | 54.31          | 74.00               | -19.69          | Horizontal   |
| 9764.00         | 56.03             | -2.38                 | 53.65          | 74.00               | -20.35          | Horizontal   |
| 12205.00        | *                 |                       |                | 74.00               |                 | Horizontal   |
| 14646.00        | *                 |                       |                | 74.00               |                 | Horizontal   |

**Average value:**

| Frequency (MHz) | Read Level (dBuV) | Correct factor (dB/m) | Level (dBuV/m) | Limit Line (dBuV/m) | Over Limit (dB) | Polarization |
|-----------------|-------------------|-----------------------|----------------|---------------------|-----------------|--------------|
| 4882.00         | 44.12             | -10.06                | 34.06          | 54.00               | -19.94          | Vertical     |
| 7323.00         | 44.71             | -2.40                 | 42.31          | 54.00               | -11.69          | Vertical     |
| 9764.00         | 43.69             | -2.38                 | 41.31          | 54.00               | -12.69          | Vertical     |
| 12205.00        | *                 |                       |                | 54.00               |                 | Vertical     |
| 14646.00        | *                 |                       |                | 54.00               |                 | Vertical     |
| 4882.00         | 43.31             | -10.06                | 33.25          | 54.00               | -20.75          | Horizontal   |
| 7323.00         | 43.42             | -2.40                 | 41.02          | 54.00               | -12.98          | Horizontal   |
| 9764.00         | 44.78             | -2.38                 | 42.40          | 54.00               | -11.60          | Horizontal   |
| 12205.00        | *                 |                       |                | 54.00               |                 | Horizontal   |
| 14646.00        | *                 |                       |                | 54.00               |                 | Horizontal   |



|               |         |
|---------------|---------|
| Test channel: | Highest |
|---------------|---------|

**Peak value:**

| Frequency (MHz) | Read Level (dBuV) | Correct factor (dB/m) | Level (dBuV/m) | Limit Line (dBuV/m) | Over Limit (dB) | Polarization |
|-----------------|-------------------|-----------------------|----------------|---------------------|-----------------|--------------|
| 4960.00         | 52.99             | -9.19                 | 43.80          | 74.00               | -30.20          | Vertical     |
| 7440.00         | 55.51             | -2.45                 | 53.06          | 74.00               | -20.94          | Vertical     |
| 9920.00         | 56.37             | -2.37                 | 54.00          | 74.00               | -20.00          | Vertical     |
| 12400.00        | *                 |                       |                | 74.00               |                 | Vertical     |
| 14880.00        | *                 |                       |                | 74.00               |                 | Vertical     |
| 4960.00         | 56.46             | -9.19                 | 47.27          | 74.00               | -26.73          | Horizontal   |
| 7440.00         | 56.27             | -2.45                 | 53.82          | 74.00               | -20.18          | Horizontal   |
| 9920.00         | 55.18             | -2.37                 | 52.81          | 74.00               | -21.19          | Horizontal   |
| 12400.00        | *                 |                       |                | 74.00               |                 | Horizontal   |
| 14880.00        | *                 |                       |                | 74.00               |                 | Horizontal   |

**Average value:**

| Frequency (MHz) | Read Level (dBuV) | Correct factor (dB/m) | Level (dBuV/m) | Limit Line (dBuV/m) | Over Limit (dB) | Polarization |
|-----------------|-------------------|-----------------------|----------------|---------------------|-----------------|--------------|
| 4960.00         | 43.02             | -9.19                 | 33.83          | 54.00               | -20.17          | Vertical     |
| 7440.00         | 42.47             | -2.45                 | 40.02          | 54.00               | -13.98          | Vertical     |
| 9920.00         | 44.51             | -2.37                 | 42.14          | 54.00               | -11.86          | Vertical     |
| 12400.00        | *                 |                       |                | 54.00               |                 | Vertical     |
| 14880.00        | *                 |                       |                | 54.00               |                 | Vertical     |
| 4960.00         | 44.23             | -9.19                 | 35.04          | 54.00               | -18.96          | Horizontal   |
| 7440.00         | 44.14             | -2.45                 | 41.69          | 54.00               | -12.31          | Horizontal   |
| 9920.00         | 42.27             | -2.37                 | 39.90          | 54.00               | -14.10          | Horizontal   |
| 12400.00        | *                 |                       |                | 54.00               |                 | Horizontal   |
| 14880.00        | *                 |                       |                | 54.00               |                 | Horizontal   |

*Remark:*

1. *Final Level = Receiver Read level + Correct factor*
2. *Correct factor = Antenna Factor + Cable Loss – Preamplifier Factor*
3. *“\*” means this data is too weak instrument of signal is unable to test.*
4. *The emission levels of other frequencies are very lower than the limit and not show in test report.*

## 8 Test Setup Photo

Radiated Emission



### Conducted Emission





## 9 EUT Constructional Details

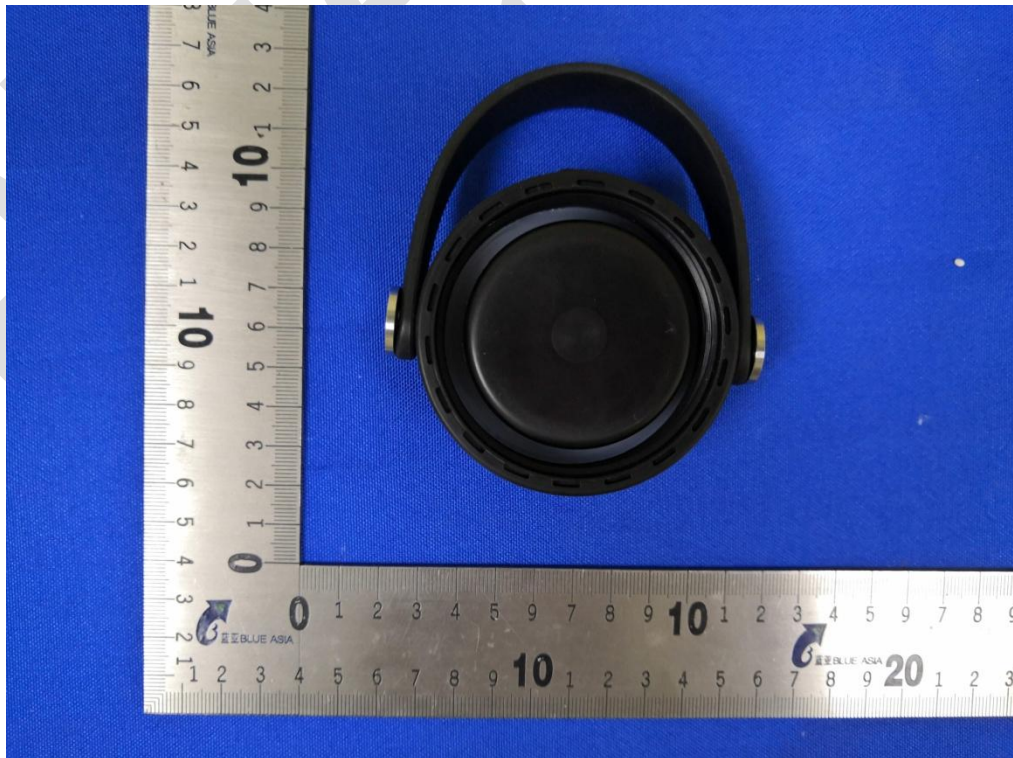
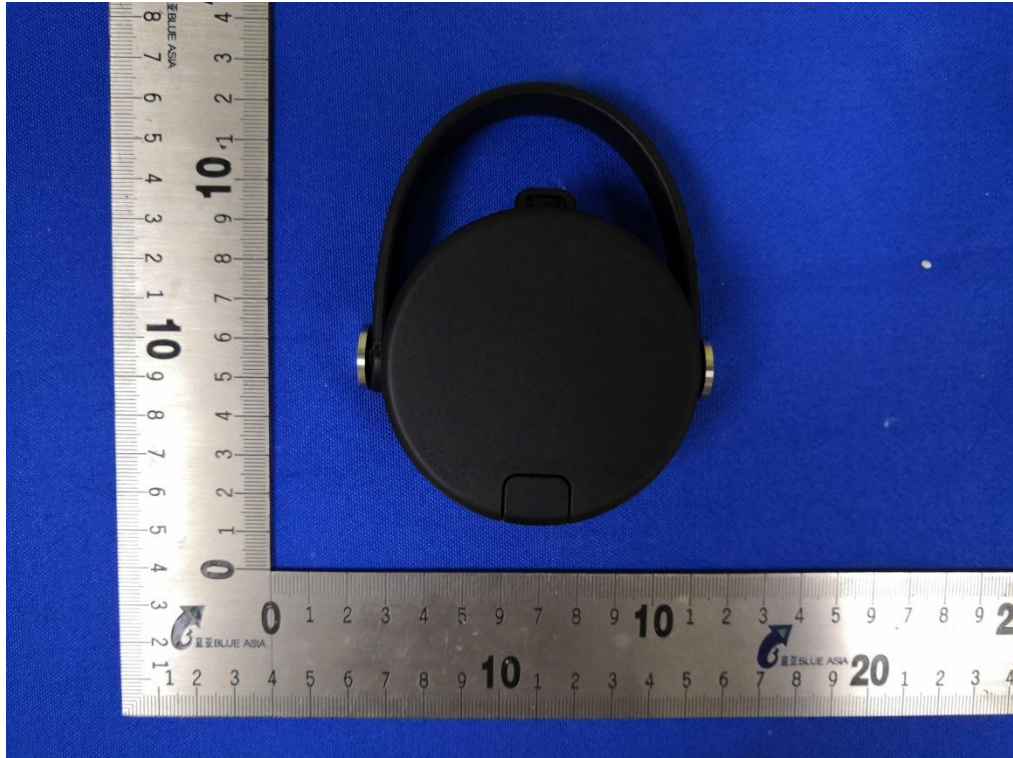

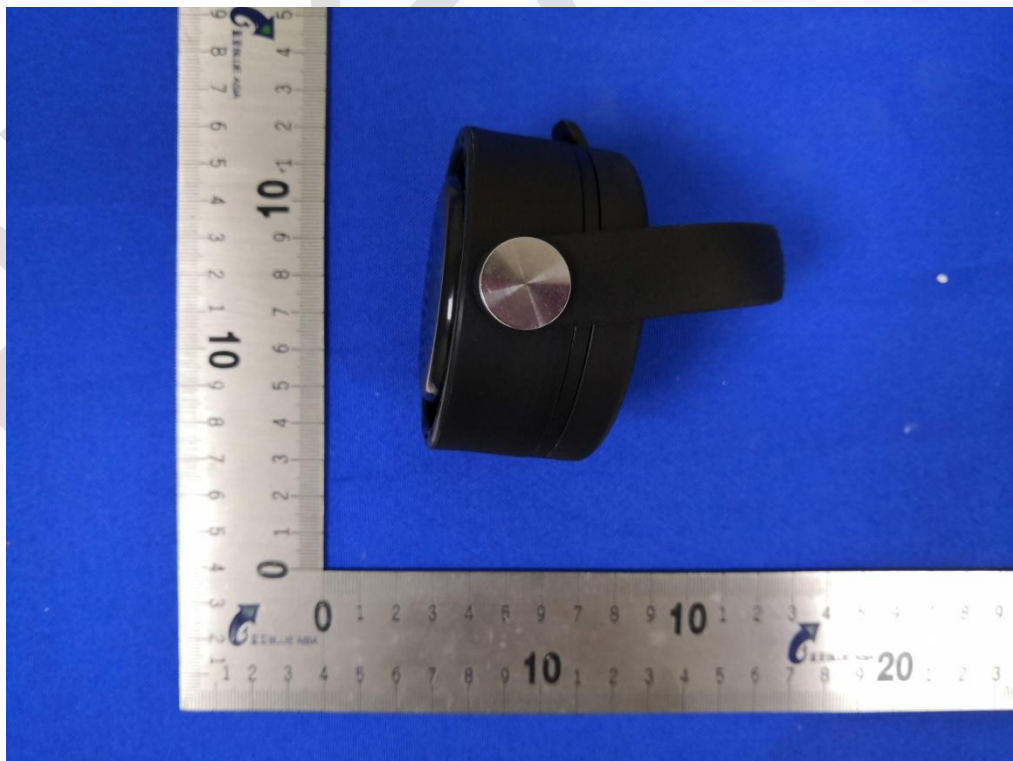











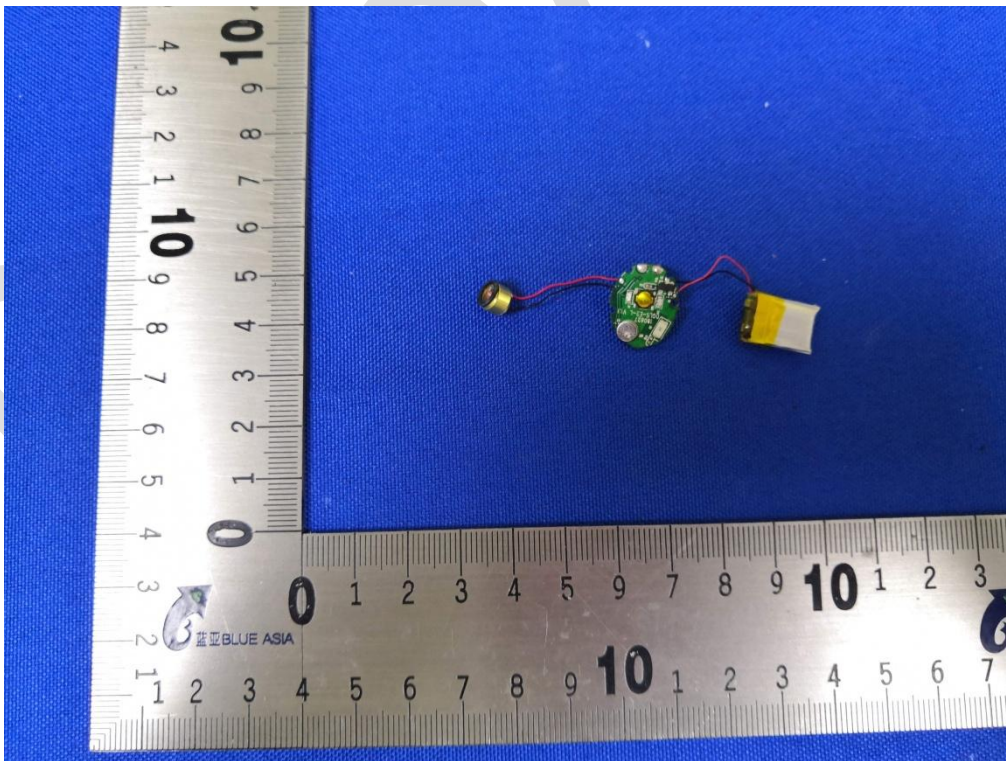



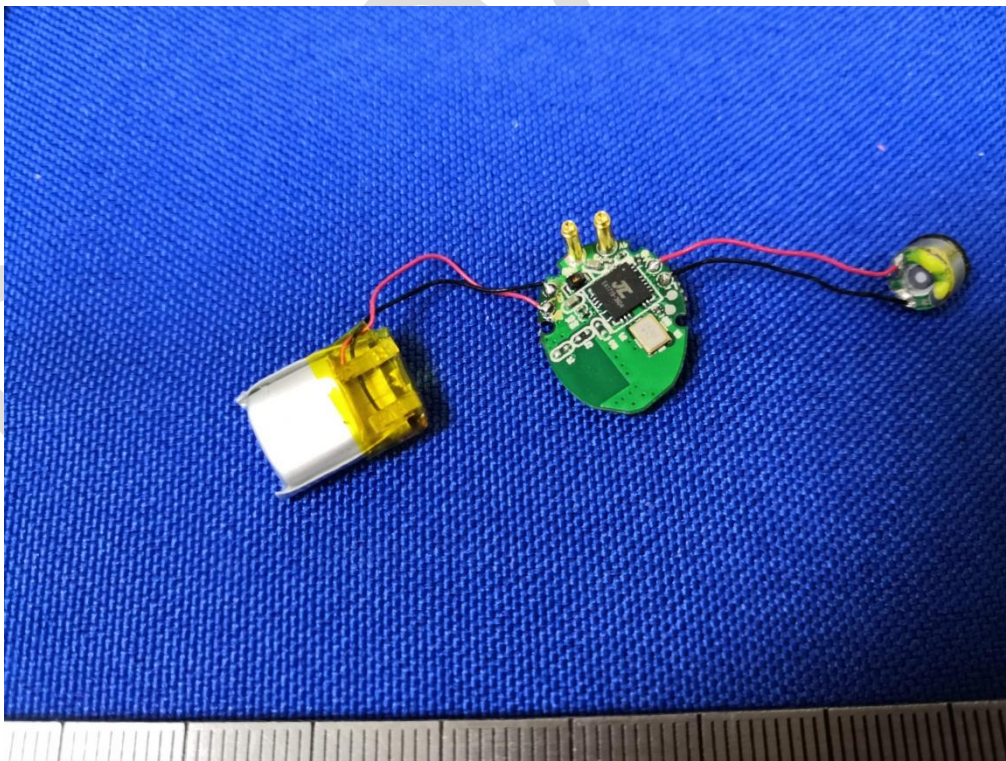
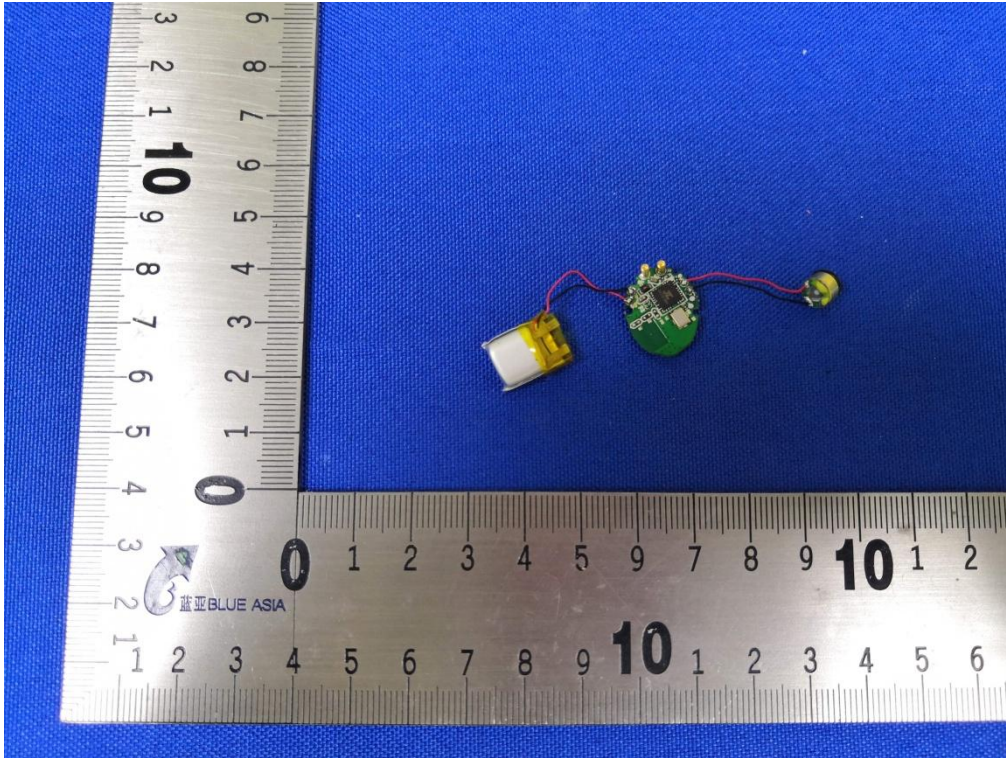

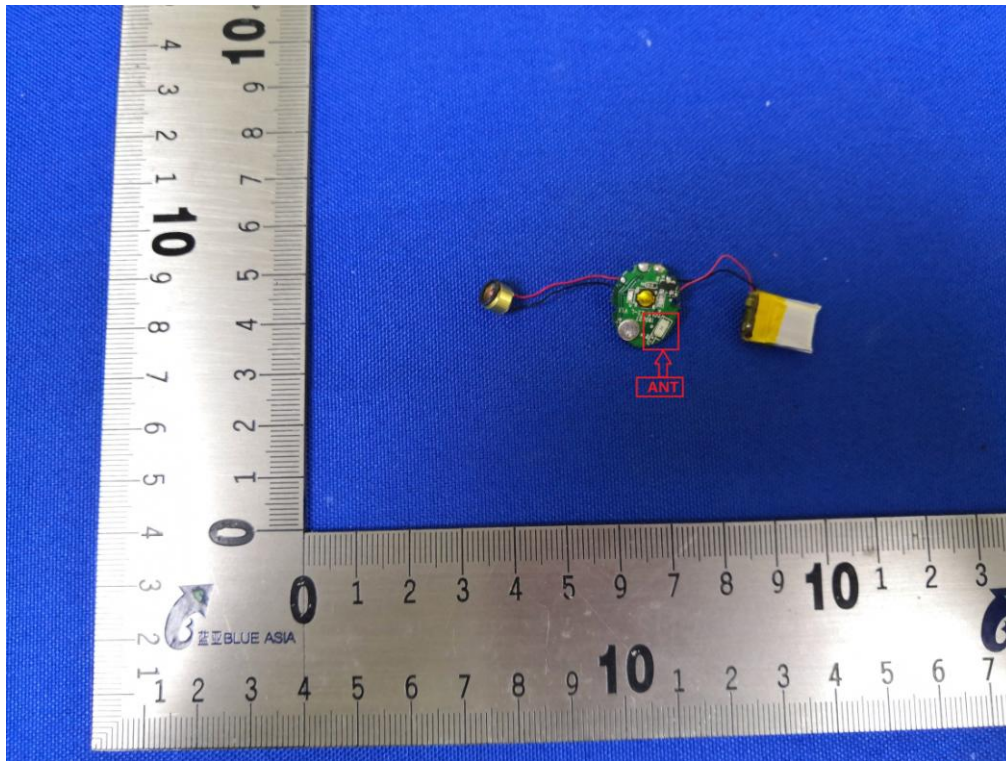

\*\*\* End of Report \*\*\*

The test report is effective only with both signature and specialized stamp, The result(s) shown in this report refer only to the sample(s) tested. Without written approval of BlueAsia, this report can't be reproduced except in full.

-----End-----