



# TEST REPORT

## FCC PART 15 SUBPART C 15.247

Test report  
On Behalf of  
Shenzhen Doageas Technology Co., Ltd.  
For  
Bluetooth speaker  
Model No.: B81

FCC ID: 2AQ2W-B81X

Prepared for : Shenzhen Doageas Technology Co., Ltd.  
5/F, 4th Bldg, Hedian Industrial Park, Guanlan, Longhua, Shenzhen,  
Guangdong 518110, China

Prepared By : Shenzhen HUAKE Testing Technology Co., Ltd.  
1F, B2 Building, Junfeng Zhongcheng Zhizao Innovation Park, Fuhai Street,  
Bao'an District, Shenzhen City, China

Date of Test: Jul. 05, 2021 -- Jul. 20, 2021

Date of Report: Jul. 20, 2021

Report Number: HK2009222670-E



### TEST RESULT CERTIFICATION

**Applicant's name** ..... : Shenzhen Doageas Technology Co., Ltd.  
**Address** ..... : 5/F, 4th Bldg, Hedian Industrial Park, Guanlan, Longhua, Shenzhen, Guangdong 518110, China  
**Manufacturer's Name** ..... : Shenzhen Doageas Technology Co., Ltd.  
**Address** ..... : 5/F, 4th Bldg, Hedian Industrial Park, Guanlan, Longhua, Shenzhen, Guangdong 518110, China

#### Product description

**Trade Mark** ..... :   
**Product name** ..... : Bluetooth speaker  
**Model and/or type reference** : B81

**Standards** ..... : **FCC Part 15 Subpart C 15.247**

This publication may be reproduced in whole or in part for non-commercial purposes as long as the Shenzhen HUAKE Testing Technology Co., Ltd. is acknowledged as copyright owner and source of the material. Shenzhen HUAKE Testing Technology Co., Ltd. takes no responsibility for and will not assume liability for damages resulting from the reader's interpretation of the reproduced material due to its placement and context.

**Date of Test** ..... :  
**Date (s) of performance of tests** ..... : Jul. 05, 2021 -- Jul. 20, 2021  
**Date of Issue** ..... : Jul. 20, 2021  
**Test Result** ..... : **Pass**

Prepared by:   
 \_\_\_\_\_  
 Project Engineer

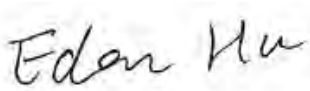
Reviewed by:   
 \_\_\_\_\_  
 Project Supervisor

Approved by:   
 \_\_\_\_\_  
 Technical Director



**Table of Contents**

**Page**

<b>1. SUMMARY .....</b>	<b>4</b>
1.1. TEST STANDARDS .....	4
1.2. TEST DESCRIPTION.....	4
1.3. TEST FACILITY .....	5
1.4. STATEMENT OF THE MEASUREMENT UNCERTAINTY.....	5
<b>2. GENERAL INFORMATION .....</b>	<b>6</b>
2.1. ENVIRONMENTAL CONDITIONS .....	6
2.2. GENERAL DESCRIPTION OF EUT .....	6
2.3. DESCRIPTION OF TEST MODES AND TEST FREQUENCY.....	7
2.4. EQUIPMENTS USED DURING THE TEST .....	8
2.5. RELATED SUBMITTAL(S) / GRANT (S).....	9
2.6. MODIFICATIONS.....	9
2.7. DESCRIPTION OF TEST SETUP .....	9
2.8. DESCRIPTION OF SUPPORT UNITS .....	9
<b>3. TEST CONDITIONS AND RESULTS .....</b>	<b>10</b>
3.1. CONDUCTED EMISSIONS TEST .....	10
3.2. RADIATED EMISSIONS AND BAND EDGE .....	13
3.3. MAXIMUM PEAK CONDUCTED OUTPUT POWER.....	25
3.4. 20dB BANDWIDTH.....	28
3.5. FREQUENCY SEPARATION .....	31
3.6. NUMBER OF HOPPING FREQUENCY.....	34
3.7. TIME OF OCCUPANCY (DWELL TIME).....	36
3.8. OUT-OF-BAND EMISSIONS .....	44
3.9. PSEUDORANDOM FREQUENCY HOPPING SEQUENCE.....	53
3.10. ANTENNA REQUIREMENT .....	54
<b>4. TEST SETUP PHOTOS OF THE EUT .....</b>	<b>55</b>
<b>5. PHOTOS OF THE EUT .....</b>	<b>57</b>



# 1. SUMMARY

## 1.1. TEST STANDARDS

The tests were performed according to following standards:

**FCC Rules Part 15.247:** Frequency Hopping, Direct Spread Spectrum and Hybrid Systems that are in operation within the bands of 902-928 MHz, 2400-2483.5 MHz, and 5725-5850 MHz

**ANSI C63.4: 2014:** –American National Standard for Methods of Measurement of Radio-Noise Emissions from Low-Voltage Electrical and Electronic Equipment in the Range of 9 kHz to 40GHz

## 1.2. Test Description

FCC PART 15.247		
FCC Part 15.207	AC Power Conducted Emission	PASS
FCC Part 15.247(a)(1)(i)	20dB Bandwidth& 99% Bandwidth	PASS
FCC Part 15.247(d)	Spurious RF Conducted Emission	PASS
FCC Part 15.247(b)	Maximum Peak Output Power	PASS
FCC part 15.247(a)(1)	Pseudorandom Frequency Hopping Sequence	PASS
FCC Part 15.247(a)(1)	Number of hopping frequency& Time of Occupancy	PASS
FCC Part 15.247(a)(1)	Frequency Separation	PASS
FCC Part 15.205/15.209	Radiated Emissions	PASS
FCC Part 15.247(d)	Band Edge Compliance of RF Emission	PASS



### 1.3. Test Facility

#### 1.3.1 Address of the test laboratory

Shenzhen HUAKE Testing Technology Co., Ltd.

Add.:1F, B2 Building, Junfeng Zhongcheng Zhizao Innovation Park,Heping Community, Fuhai Street, Bao'an District, Shenzhen, China

There is one 3m semi-anechoic chamber and two line conducted labs for final test. The Test Sites meet the requirements in documents ANSI C63.4 and CISPR 32/EN 55032 requirements.

#### 1.3.2 Laboratory accreditation

The test facility is recognized, certified, or accredited by the following organizations:

##### IC Registration No.: 21210

The 3m alternate test site of Shenzhen HUAKE Testing Technology Co., Ltd. EMC Laboratory has been registered by Certification and Engineer Bureau of Industry Canada for the performance of with Registration No.: 21210 on May 24, 2016.

### 1.4. Statement of the measurement uncertainty

The data and results referenced in this document are true and accurate. The reader is cautioned that there may be errors within the calibration limits of the equipment and facilities. The measurement uncertainty was calculated for all measurements listed in this test report acc. to CISPR 16 - 4 "Specification for radio disturbance and immunity measuring apparatus and methods – Part 4: Uncertainty in EMC Measurements" and is documented in the Shenzhen HUAKE Testing Technology Co., Ltd. quality system acc. to DIN EN ISO/IEC 17025. Furthermore, component and process variability of devices similar to that tested may result in additional deviation. The manufacturer has the sole responsibility of continued compliance of the device.

Hereafter the best measurement capability for HUAKE laboratory is reported:

Test	Measurement Uncertainty	Notes
Transmitter power conducted	±0.57 dB	(1)
Transmitter power Radiated	±2.20 dB	(1)
Conducted spurious emission 9KHz-40 GHz	±2.20 dB	(1)
Occupied Bandwidth	±0.01ppm	(1)
Radiated Emission 30~1000MHz	±4.10dB	(1)
Radiated Emission Above 1GHz	±4.32dB	(1)
Conducted Disturbance0.15~30MHz	±3.20dB	(1)

(1) This uncertainty represents an expanded uncertainty expressed at approximately the 95% confidence level using a coverage factor of k=2.



## 2. GENERAL INFORMATION

### 2.1. Environmental conditions

During the measurement the environmental conditions were within the listed ranges:

Normal Temperature:	25°C
Relative Humidity:	55 %
Air Pressure:	101 kPa

### 2.2. General Description of EUT

Product Name:	Bluetooth speaker
Model/Type reference:	B81
Serial Model:	/
Trade Mark	DOAGEAS
FCC ID	2AQ2W-B81N
Hardware Version:	V11
Software Version:	V1.5
Version:	Supported EDR
Modulation:	GFSK, π/4DQPSK
Operation frequency:	2402MHz~2480MHz
Channel number:	79CH
Channel separation:	1MHz
Antenna type:	PCB Antenna
Antenna gain:	0dBi
Power supply:	DC 3.7V from battery

Note: 1. For more details, refer to the user's manual of the EUT.



### 2.3. Description of Test Modes and Test Frequency

The Applicant provides communication tools software to control the EUT for staying in continuous transmitting and receiving mode for testing.

There are 79 channels provided to the EUT and Channel 00/39/78 was selected for testing.

#### Operation Frequency :

Channel	Frequency (MHz)
00	2402
01	2403
:	:
38	2440
39	2441
40	2442
:	:
77	2479
78	2480

Note: The line display in grey were the channel selected for testing

Preliminary tests were performed in each mode and packet length of BT, and found worst case as bellow, finally test were conducted at those mode and recorded in this report.

Test Items	Worst case
Conducted Emissions	Charging mode
Radiated Emissions and Band Edge	2DH5
Maximum Conducted Output Power	DH5/2DH5
20dB Bandwidth&99% Bandwidth	DH5/2DH5
Frequency Separation	DH5/2DH5 Middle channel
Number of hopping frequency	DH5/2DH5
Time of Occupancy (Dwell Time)	DH1/DH3/DH5 Middle channel 2DH1/2DH3/2DH5 Middle channel
Out-of-band Emissions	DH5/2DH5

Note: All tests are based on 3.7V battery test results



## 2.4. Equipments Used during the Test

Item	Equipment	Manufacturer	Model No.	Serial No.	Last Cal.	Cal. Interval
1.	L.I.S.N. Artificial Mains Network	R&S	ENV216	HKE-002	Dec. 25, 2020	1 Year
2.	Receiver	R&S	ESCI 7	HKE-010	Dec. 25, 2020	1 Year
3.	RF automatic control unit	Tonscend	JS0806-2	HKE-060	Dec. 25, 2020	1 Year
4.	Spectrum analyzer	R&S	FSP40	HKE-025	Dec. 25, 2020	1 Year
5.	Spectrum analyzer	Agilent	N9020A	HKE-048	Dec. 25, 2020	1 Year
6.	Preamplifier	Schwarzbeck	BBV 9743	HKE-006	Dec. 25, 2020	1 Year
7.	EMI Test Receiver	Rohde & Schwarz	ESCI 7	HKE-010	Dec. 25, 2020	1 Year
8.	Bilog Broadband Antenna	Schwarzbeck	VULB9163	HKE-012	Dec. 25, 2020	1 Year
9.	Loop Antenna	Schwarzbeck	FMZB 1519 B	HKE-014	Dec. 25, 2020	1 Year
10.	Horn Antenna	Schwarzbeck	9120D	HKE-013	Dec. 25, 2020	1 Year
11.	Pre-amplifier	EMCI	EMC051845 SE	HKE-015	Dec. 25, 2020	1 Year
12.	Pre-amplifier	Agilent	83051A	HKE-016	Dec. 25, 2020	1 Year
13.	EMI Test Software EZ-EMC	Tonscend	JS1120-B Version	HKE-083	Dec. 27, 2018	N/A
14.	Power Sensor	Agilent	E9300A	HKE-086	Dec. 25, 2020	1 Year
15.	Spectrum analyzer	Agilent	N9020A	HKE-048	Dec. 25, 2020	1 Year
16.	Signal generator	Agilent	N5182A	HKE-029	Dec. 25, 2020	1 Year
17.	Signal Generator	Agilent	83630A	HKE-028	Dec. 25, 2020	1 Year
18.	Shielded room	Shiel Hong	4*3*3	HKE-039	Dec. 27, 2017	3 Year
19.	Power Meter	R&S	NRVD	SEL0069	Dec. 25, 2020	1 Year
20.	High Gain Antenna	Schwarzbeck	LB-180400K F	HKE-054	Dec. 25, 2020	1 Year

The calibration interval was one year





### 2.5. Related Submittal(s) / Grant (s)

This submittal(s) (test report) is intended to comply with Section 15.247 of the FCC Part 15, Subpart C Rules. RSS Gen and RSS 247 Rules.

### 2.6. Modifications

No modifications were implemented to meet testing criteria.

### 2.7. DESCRIPTION OF TEST SETUP

Operation of EUT during conducted testing:

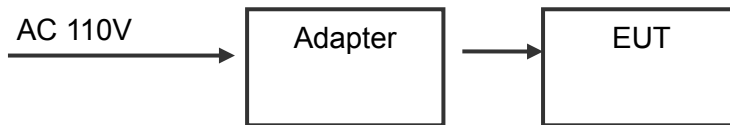

Operation of EUT during Radiation and Above1GHz Radiation testing:



NOTE: During the test, it has been confirmed that the battery is fully charged

### 2.8. Description of Support Units

The EUT has been tested as an independent unit together with other necessary accessories or support units. The following support units or accessories were used to form a representative test configuration during the tests.

Description	Information	Manufacturer	Remark	Certificate
ADAPTER	MODEL:FJ-SW1260502500UN INPUT:100-240 50/60Hz 0.4A Max OUTPUT:5V 2500mA	SHENZHEN FUJIA APPLIANCE CO.,LTD	Provide by lab	SDOC

### 3. TEST CONDITIONS AND RESULTS

#### 3.1. Conducted Emissions Test

##### LIMIT

According to FCC CFR Title 47 Part 15 Subpart C Section 15.207 and RSS Gen 8.8, AC Power Line Conducted Emissions Limits for Licence-Exempt Radio Apparatus as below:

Frequency range (MHz)	Limit (dBuV)	
	Quasi-peak	Average
0.15-0.5	66 to 56*	56 to 46*
0.5-5	56	46
5-30	60	50

\* Decreases with the logarithm of the frequency.

##### TEST CONFIGURATION



##### TEST PROCEDURE

1. The equipment was set up as per the test configuration to simulate typical actual usage per the user's manual. The EUT is a tabletop system; a wooden table with a height of 0.8 meters is used and is placed on the ground plane as per ANSI C63.10:2013.
2. Support equipment, if needed, was placed as per ANSI C63.10:2013
3. All I/O cables were positioned to simulate typical actual usage as per ANSI C63.10:2013.
4. The adapter received AC120V/60Hz power through a Line Impedance Stabilization Network (LISN) which supplied power source and was grounded to the ground plane.
5. All support equipments received AC power from a second LISN, if any.
6. The EUT test program was started. Emissions were measured on each current carrying line of the EUT using a spectrum Analyzer / Receiver connected to the LISN powering the EUT. The LISN has two monitoring points: Line 1 (Hot Side) and Line 2 (Neutral Side). Two scans were taken: one with Line 1 connected to Analyzer / Receiver and Line 2 connected to a 50 ohm load; the second scan had Line 1 connected to a 50 ohm load and Line 2 connected to the Analyzer / Receiver.
7. Analyzer / Receiver scanned from 150 KHz to 30MHz for emissions in each of the test modes.
8. During the above scans, the emissions were maximized by cable manipulation.



**TEST RESULTS**

Test Specification: Line

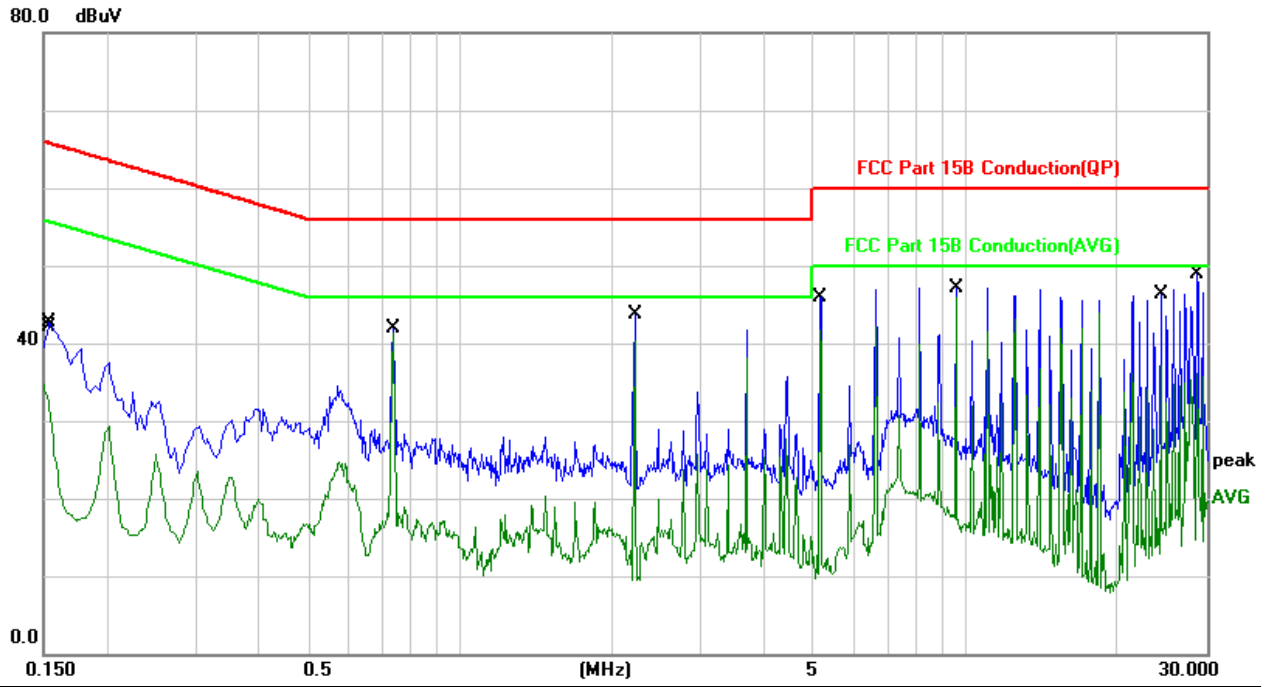

No.	Mk.	Freq. MHz	Reading Level dBuV	Correct Factor dB	Measure- ment dBuV	Limit dBuV	Over dB	Detector	Comment
1		0.1499	34.89	-0.13	34.76	56.00	-21.24	AVG	
2		0.1539	42.76	-0.13	42.63	65.78	-23.15	QP	
3		0.7380	42.06	-0.06	42.00	56.00	-14.00	QP	
4		0.7380	41.43	-0.06	41.37	46.00	-4.63	AVG	
5		2.2180	43.92	-0.24	43.68	56.00	-12.32	QP	
6		2.2180	40.64	-0.24	40.40	46.00	-5.60	AVG	
7		5.1659	46.19	-0.22	45.97	60.00	-14.03	QP	
8		5.1659	41.83	-0.22	41.61	50.00	-8.39	AVG	
9		9.5778	47.34	-0.19	47.15	60.00	-12.85	QP	
10	*	9.5778	46.06	-0.19	45.87	50.00	-4.13	AVG	
11		24.3220	37.47	-0.43	37.04	50.00	-12.96	AVG	
12		28.7220	49.22	-0.39	48.83	60.00	-11.17	QP	

Remark: Margin = Limit – Level  
 Correction factor = Cable lose + LISN insertion loss  
 Level=Test receiver reading + correction factor



Test Specification: Neutral

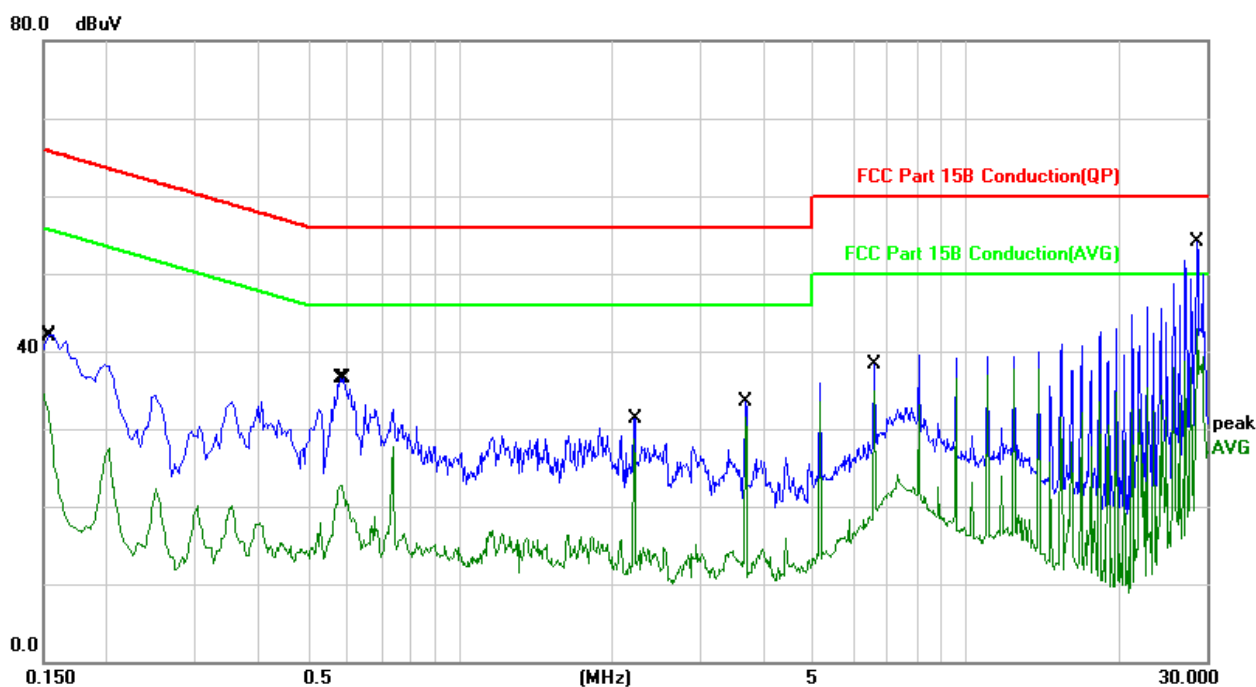

No.	Mk.	Freq.	Reading Level	Correct Factor	Measurement	Limit	Over	Detector	Comment
		MHz	dBuV	dB	dBuV	dBuV	dB		
1		0.1500	34.62	-0.13	34.49	55.99	-21.50	AVG	
2		0.1539	42.33	-0.13	42.20	65.78	-23.58	QP	
3		0.5820	22.84	-0.04	22.80	46.00	-23.20	AVG	
4		0.5899	36.51	-0.04	36.47	56.00	-19.53	QP	
5		2.2100	29.03	-0.24	28.79	46.00	-17.21	AVG	
6		2.2139	31.60	-0.24	31.36	56.00	-24.64	QP	
7		3.6780	33.73	-0.19	33.54	56.00	-22.46	QP	
8		3.6780	31.60	-0.19	31.41	46.00	-14.59	AVG	
9		6.6220	38.60	-0.27	38.33	60.00	-21.67	QP	
10		6.6220	35.15	-0.27	34.88	50.00	-15.12	AVG	
11	*	28.7140	54.44	-0.39	54.05	60.00	-5.95	QP	
12		28.7140	43.33	-0.39	42.94	50.00	-7.06	AVG	

Remark: Margin = Limit – Level  
 Correction factor = Cable lose + LISN insertion loss  
 Level=Test receiver reading + correction factor

Notes:

1. An initial pre-scan was performed on the line and neutral lines with peak detector.
  2. Quasi-Peak and Average measurement were performed at the frequencies with maximized peak emission.
  3. Final Level =Receiver Read level + LISN Factor + Cable Loss.
- If the average limit is met when using a quasi-peak detector receiver, the EUT shall be deemed to meet both limits and measurement with the average detector receiver is unnecessary.

### 3.2. Radiated Emissions and Band Edge

#### Limit

For intentional device, according to § 15.209(a), the general requirement of field strength of radiated emission out of authorized band shall not exceed the following table at a 3 meters measurement distance.

In addition, radiated emissions which fall in the restricted bands, as defined in §15.205(a), must also comply with the radiated emission limits specified in §15.209(a)

Except when the requirements applicable to a given device state otherwise, emissions from licence-exempt transmitters shall comply with the field strength limits shown in table below.

Additionally, the level of any transmitter emission shall not exceed the level of the transmitter's fundamental emission

Unwanted emissions that fall into restricted bands shall comply with the limits specified in RSS-Gen; and Unwanted emissions that do not fall within the restricted frequency bands shall comply either with the limits specified in the applicable RSS or with those specified in this RSS-Gen.

Radiated emission limits

Frequency (MHz)	Distance (Meters)	Radiated (dBµV/m)	Radiated (µV/m)
0.009-0.49	3	$20\log(2400/F(\text{KHz}))+40\log(300/3)$	$2400/F(\text{KHz})$
0.49-1.705	3	$20\log(24000/F(\text{KHz}))+ 40\log(30/3)$	$24000/F(\text{KHz})$
1.705-30	3	$20\log(30)+ 40\log(30/3)$	30
30-88	3	40.0	100
88-216	3	43.5	150
216-960	3	46.0	200
Above 960	3	54.0	500

#### TEST CONFIGURATION

(A) Radiated Emission Test Set-Up, Frequency Below 30MHz

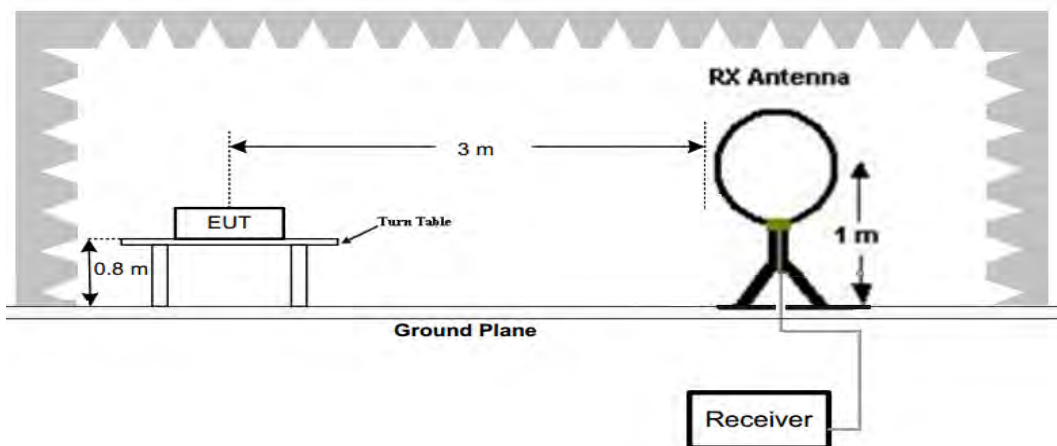

(B) Radiated Emission Test Set-Up, Frequency below 1000MHz

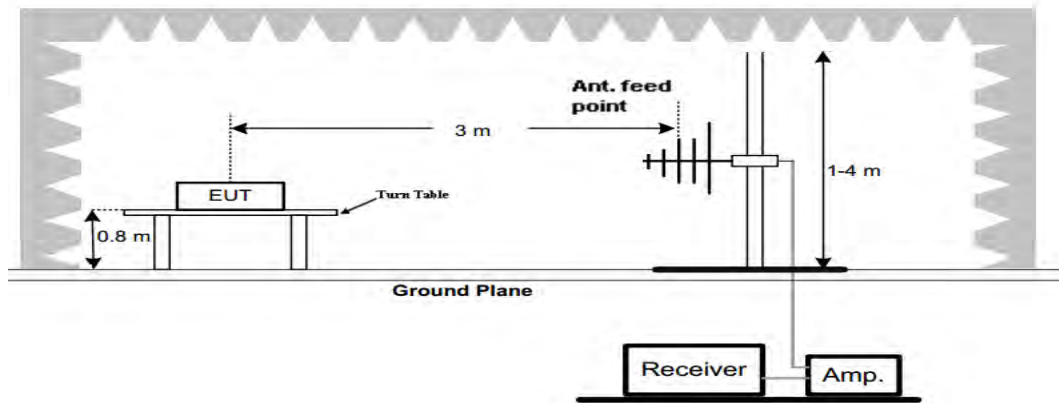

(C) Radiated Emission Test Set-Up, Frequency above 1000MHz

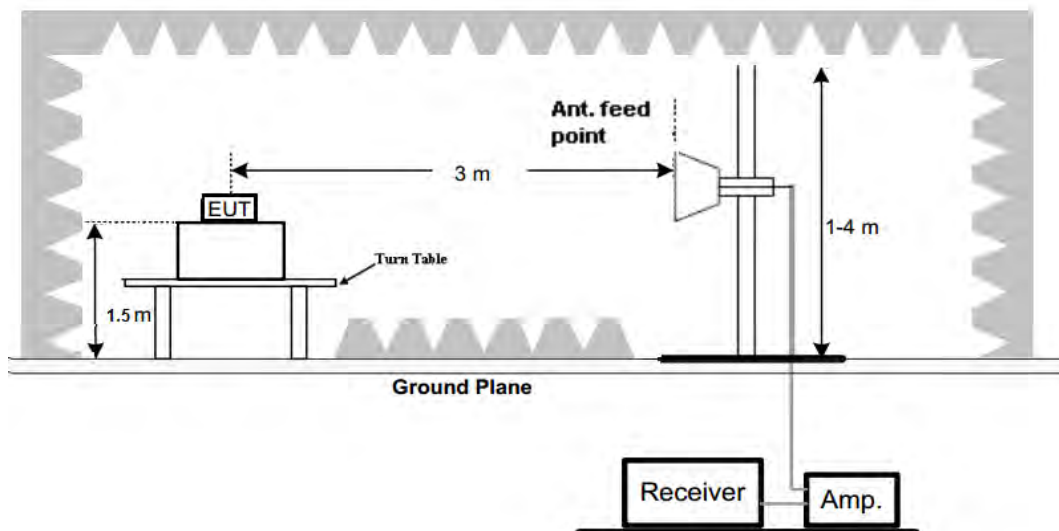

### Test Procedure

- 1) Below 1G: The EUT was placed on the top of a rotating table 0.8 meters above the ground at a 3 meter semi-anechoic chamber. The table was rotated 360 degrees to determine the position of the highest radiation.
- 2) Above 1G: The EUT was placed on the top of a rotating table 1.5 meters above the ground at a 3 meter semi-anechoic chamber. The table was rotated 360 degrees to determine the position of the highest radiation.

Note: For the radiated emission test above 1GHz: Place the measurement antenna away from each area of the EUT determined to be a source of emissions at the specified measurement distance, while keeping the measurement antenna aimed at the source of emissions at each frequency of significant emissions, with polarization oriented for maximum response. The measurement antenna may have to be higher or lower than the EUT, depending on the radiation pattern of the emission and staying aimed at the emission source for receiving the maximum signal. The final measurement antenna elevation shall be that which maximizes the emissions. The measurement antenna elevation for maximum emissions shall be restricted to a range of heights of from 1 m to 4 m above the ground or reference ground plane.

The EUT was set 3 meters away from the interference-receiving antenna, which was mounted on the top of a variable-height antenna tower.

The antenna height is varied from one meter to four meters above the ground to determine the maximum value of the field strength. Both horizontal and vertical polarizations of the antenna are set to make the measurement. For each suspected emission, the EUT was arranged to its worst case and then the antenna was tuned to heights from 1 meter to 4 meters (for the test frequency of below 30MHz, the antenna was tuned to heights 1 meter) and the rotatable table was turned from 0 degrees to 360 degrees to find the maximum reading. The test-receiver system was set to Peak Detect Function and Specified Bandwidth with Maximum Hold Mode.



If the emission level of the EUT in peak mode was 10dB lower than the limit specified, then testing could be stopped and the peak values of the EUT would be reported. Otherwise the emissions that did not have 10dB margin would be re-tested one by one using peak, quasi-peak or average method as specified and then reported in a data sheet.

Test the EUT in the lowest channel, the middle channel, the Highest channel

The radiation measurements are performed in X, Y, Z axis positioning for Transmitting mode, and found the X axis positioning which it is the worst case. Repeat above procedures until all frequencies measured was complete.

## **TEST RESULTS**

Remark:

1. Radiated Emission measured at GFSK,  $\pi/4$  DQPSK from 9 KHz to 10th harmonic of fundamental and recorded worst case at  $\pi/4$  DQPSK -2DH5 mode.
2. Radiated emission test from 9KHz to 10th harmonic of fundamental was verified, and no emission found except system noise floor (more than 20dB below the limit) in 9KHz to 30MHz and not recorded in this report.
3. For below 1GHz testing recorded worst at 2DH5 low channel.



**Below 1GHz Test Results:**

Antenna polarity: H

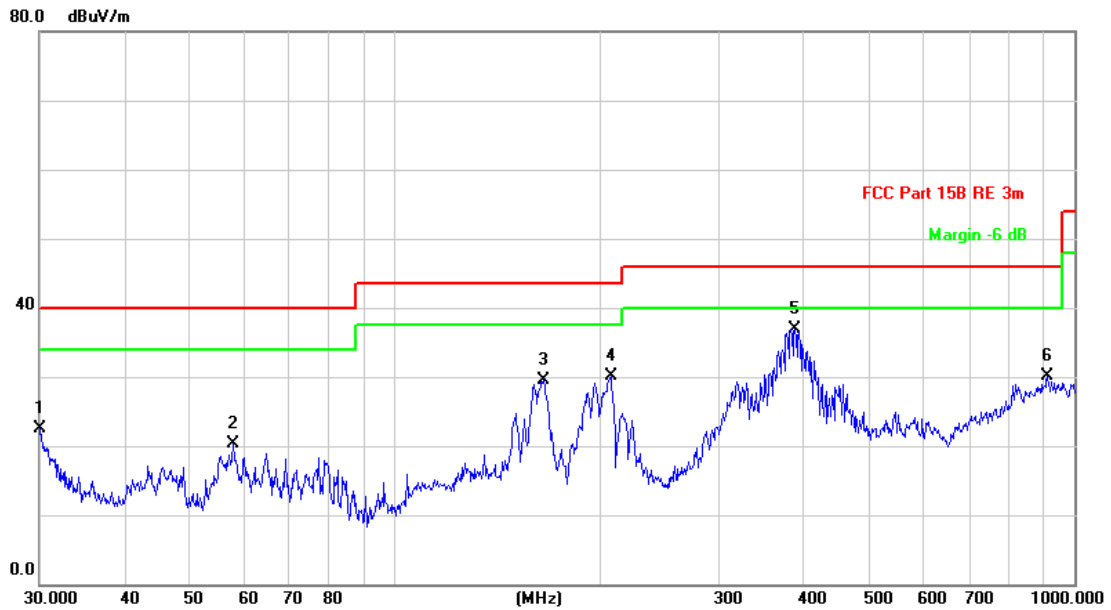

No.	Mk.	Freq.	Reading Level	Correct Factor	Measurement	Limit	Over	Antenna Height	Table Degree	
		MHz	dBuV	dB/m	dBuV/m	dBuV/m	dB	cm	degree	Comment
1		30.1054	21.03	1.43	22.46	40.00	-17.54	QP		
2		57.7962	36.81	-16.48	20.33	40.00	-19.67	QP		
3		165.4866	35.49	-6.02	29.47	43.50	-14.03	QP		
4		207.8501	37.07	-7.06	30.01	43.50	-13.49	QP		
5	*	387.9920	39.02	-2.04	36.98	46.00	-9.02	QP		
6		912.8620	22.83	7.30	30.13	46.00	-15.87	QP		

Remark: Margin = Limit – Level

Correction Factor= Antenna Factor + Cable loss – Pre-amplifier

Level=Test receiver reading + correction factor





Antenna polarity: V

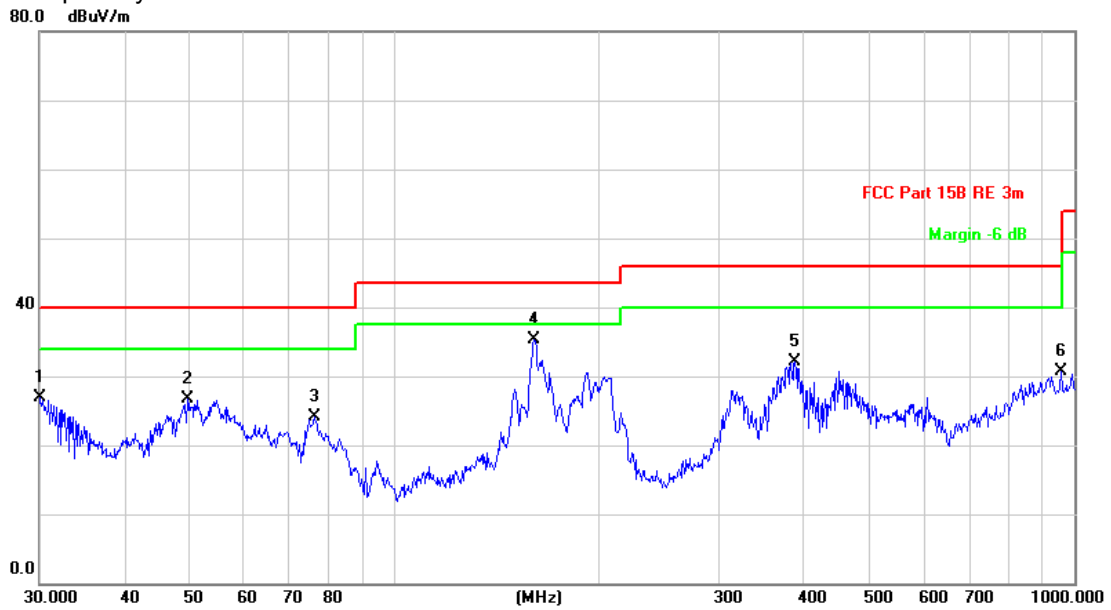

No.	Mk.	Freq. MHz	Reading Level dBuV	Correct Factor dB/m	Measure- ment dBuV/m	Limit dBuV/m	Over dB	Detector	Antenna Height cm	Table Degree	Comment
1		30.0000	25.29	1.62	26.91	40.00	-13.09	QP			
2		49.5328	43.96	-17.19	26.77	40.00	-13.23	QP			
3		76.2442	37.65	-13.58	24.07	40.00	-15.93	QP			
4	*	160.3456	40.98	-5.75	35.23	43.50	-8.27	QP			
5		387.9920	34.06	-2.04	32.02	46.00	-13.98	QP			
6		955.4381	23.82	6.85	30.67	46.00	-15.33	QP			

Remark: Margin = Limit – Level

Correction Factor= Antenna Factor + Cable loss – Pre-amplifier

Level=Test receiver reading + correction factor

**For 1GHz to 25GHz**

Worst case:

2DH5--CH Low (2402MHz)

Horizontal:

Frequency	Meter Reading	Factor	Emission Level	Limits	Margin	Detector Type
(MHz)	(dB $\mu$ V)	(dB)	(dB $\mu$ V/m)	(dB $\mu$ V/m)	(dB)	
4804.00	58.64	-3.65	54.99	74	-19.01	Peak
4804.00	36.94	-3.65	33.29	54	-20.71	AVG
7206.00	58.46	-0.95	57.51	74	-16.49	Peak
7206.00	37.79	-0.95	36.84	54	-17.16	AVG

Remark :Factor= Antenna Factor + Cable Loss - Pre-amplifier

Vertical:

Frequency	Meter Reading	Factor	Emission Level	Limits	Margin	Detector Type
(MHz)	(dB $\mu$ V)	(dB)	(dB $\mu$ V/m)	(dB $\mu$ V/m)	(dB)	
4804.00	56.72	-3.65	53.07	74	-20.93	Peak
4804.00	35.12	-3.65	31.47	54	-22.53	AVG
7206.00	57.02	-0.95	56.07	74	-17.93	Peak
7206.00	37.04	-0.95	36.09	54	-17.91	AVG

Remark :Factor= Antenna Factor + Cable Loss - Pre-amplifier



## 2DH5--CH Middle (2441MHz)

Horizontal:

Frequency (MHz)	Meter Reading (dB $\mu$ V)	Factor (dB)	Emission Level (dB $\mu$ V/m)	Limits (dB $\mu$ V/m)	Margin (dB)	Detector Type
4882.00	52.51	-3.54	48.97	74	-25.03	Peak
4882.00	34.83	-3.54	31.29	54	-22.71	AVG
7323.00	53.14	-0.81	52.33	74	-21.67	Peak
7323.00	36.17	-0.81	35.36	54	-18.64	AVG

Remark :Factor= Antenna Factor + Cable Loss - Pre-amplifier

Vertical:

Frequency (MHz)	Meter Reading (dB $\mu$ V)	Factor (dB)	Emission Level (dB $\mu$ V/m)	Limits (dB $\mu$ V/m)	Margin (dB)	Detector Type
4882.00	53.26	-3.54	49.72	74	-24.28	Peak
4882.00	36.53	-3.54	32.99	54	-21.01	AVG
7323.00	53.58	-0.81	52.77	74	-21.23	Peak
7323.00	35.11	-0.81	34.30	54	-19.70	AVG

Remark :Factor= Antenna Factor + Cable Loss - Pre-amplifier



2DH5--CH High (2480MHz)

Horizontal:

Frequency	Meter Reading	Factor	Emission Level	Limits	Margin	Detector Type
(MHz)	(dBμV)	(dB)	(dBμV/m)	(dBμV/m)	(dB)	
4960.00	52.45	-3.43	49.02	74	-24.98	Peak
4960.00	34.46	-3.43	31.03	54	-22.97	AVG
7440.00	52.13	-0.77	51.36	74	-22.64	Peak
7440.00	35.36	-0.77	34.59	54	-19.41	AVG

Remark :Factor= Antenna Factor + Cable Loss - Pre-amplifier

Vertical:

Frequency	Meter Reading	Factor	Emission Level	Limits	Margin	Detector Type
(MHz)	(dBμV)	(dB)	(dBμV/m)	(dBμV/m)	(dB)	
4960.00	51.88	-3.43	48.45	74	-25.55	Peak
4960.00	34.20	-3.43	30.77	54	-23.23	AVG
7440.00	53.46	-0.77	52.69	74	-21.31	Peak
7440.00	35.18	-0.77	34.41	54	-19.59	AVG

Remark :Factor= Antenna Factor + Cable Loss - Pre-amplifier

Remark :

- (1) Measuring frequencies from 1 GHz to the 25 GHz
- (2) "F" denotes fundamental frequency; "H" denotes spurious frequency. "E" denotes band edge frequency.
- (3) \* denotes emission frequency which appearing within the Restricted Bands specified in provision of 15.205, then the general radiated emission limits in 15.209 apply.
- (4) The other emissions are 20 dB below the limit value, which are not reported. It is deemed to comply with the requireme.
- (5) The IF bandwidth of EMI Test Receiver between 30MHz to 1GHz was 120KHz, 1 MHz for measuring above 1 GHz, below 30MHz was 10KHz. The resolution bandwidth of test receiver/spectrum analyzer is 1MHz and video bandwidth is 3MHz for peak measurement with peak detector at frequency above 1GHz. The resolution bandwidth of test receiver/spectrum analyzer is 1MHz and video bandwidth is 10Hz for Average measurement with peak detection at frequency above 1GHz.
- (6) When the test results of Peak Detected below the limits of Average Detected, the Average Detected is not need completed. For example: Top Channel at Fundamental 73.16dBuV/m(PK Value) <93.98(AV Limit), at harmonic 53.20 dBuV/m(PK Value) <54 dBuV/m(AV Limit), the Average Detected not need to completed.
- (7)All modes of operation were investigated and the worst-case emissions are reported.



Radiated Band Edge Test:

Hopping

Operation Mode: TX CH Low (2402MHz)

Horizontal (Worst case: 2DH5)

Frequency (MHz)	Meter Reading (dB $\mu$ V)	Factor (dB)	Emission Level (dB $\mu$ V/m)	Limits (dB $\mu$ V/m)	Margin (dB)	Detector Type
2310	51.58	-5.81	45.77	74	-28.23	Peak
2310	39.51	-5.81	33.70	54	-20.30	AVG
2390	53.60	-5.84	47.76	74	-26.24	Peak
2390	37.68	-5.84	31.84	54	-22.16	AVG

Remark :Factor= Antenna Factor + Cable Loss - Pre-amplifier

Vertical:

Frequency (MHz)	Meter Reading (dB $\mu$ V)	Factor (dB)	Emission Level (dB $\mu$ V/m)	Limits (dB $\mu$ V/m)	Margin (dB)	Detector Type
2310	53.24	-5.81	47.43	74	-26.57	Peak
2310	37.86	-5.81	32.05	54	-21.95	AVG
2390	52.25	-5.84	46.41	74	-27.59	Peak
2390	39.94	-5.84	34.10	54	-19.90	AVG

Remark :Factor= Antenna Factor + Cable Loss - Pre-amplifier



Operation Mode: TX CH High (2480MHz)

Horizontal (Worst case: 2DH5)

Frequency (MHz)	Meter Reading (dB $\mu$ V)	Factor (dB)	Emission Level (dB $\mu$ V/m)	Limits (dB $\mu$ V/m)	Margin (dB)	Detector Type
2483.5	53.62	-6.04	47.58	74	-26.42	Peak
2483.5	38.47	-6.04	32.43	54	-21.57	AVG
2500	54.09	-6.06	48.03	74	-25.97	Peak
2500	37.60	-6.06	31.54	54	-22.46	AVG

Remark :Factor= Antenna Factor + Cable Loss - Pre-amplifier

Vertical:

Frequency (MHz)	Meter Reading (dB $\mu$ V)	Factor (dB)	Emission Level (dB $\mu$ V/m)	Limits (dB $\mu$ V/m)	Margin (dB)	Detector Type
2483.5	51.50	-6.04	45.46	74	-28.54	Peak
2483.5	38.61	-6.04	32.57	54	-21.43	AVG
2500	53.47	-6.06	47.41	74	-26.59	Peak
2500	38.85	-6.06	32.79	54	-21.21	AVG

Remark :Factor= Antenna Factor + Cable Loss - Pre-amplifier



NO hopping

Operation Mode: TX CH Low (2402MHz)

Horizontal (Worst case: 2DH5)

Frequency (MHz)	Meter Reading (dB $\mu$ V)	Factor (dB)	Emission Level (dB $\mu$ V/m)	Limits (dB $\mu$ V/m)	Margin (dB)	Detector Type
2310	53.47	-5.81	47.66	74	-26.34	Peak
2310	40.17	-5.81	34.36	54	-19.64	AVG
2390	52.73	-5.84	46.89	74	-27.11	Peak
2390	39.13	-5.84	33.29	54	-20.71	AVG

Remark :Factor= Antenna Factor + Cable Loss - Pre-amplifier

Vertical:

Frequency (MHz)	Meter Reading (dB $\mu$ V)	Factor (dB)	Emission Level (dB $\mu$ V/m)	Limits (dB $\mu$ V/m)	Margin (dB)	Detector Type
2310	53.52	-5.81	47.71	74	-26.29	Peak
2310	39.15	-5.81	33.34	54	-20.66	AVG
2390	54.13	-5.84	48.29	74	-25.71	Peak
2390	39.34	-5.84	33.50	54	-20.50	AVG

Remark :Factor= Antenna Factor + Cable Loss - Pre-amplifier



Operation Mode: TX CH High (2480MHz)

## Horizontal (Worst case:2DH5)

Frequency (MHz)	Meter Reading (dB $\mu$ V)	Factor (dB)	Emission Level (dB $\mu$ V/m)	Limits (dB $\mu$ V/m)	Margin (dB)	Detector Type
2483.5	52.33	-6.04	46.29	74	-27.71	Peak
2483.5	39.38	-6.04	33.34	54	-20.66	AVG
2500	52.59	-6.06	46.53	74	-27.47	Peak
2500	37.80	-6.06	31.74	54	-22.26	AVG

Remark :Factor= Antenna Factor + Cable Loss - Pre-amplifier

## Vertical:

Frequency (MHz)	Meter Reading (dB $\mu$ V)	Factor (dB)	Emission Level (dB $\mu$ V/m)	Limits (dB $\mu$ V/m)	Margin (dB)	Detector Type
2483.5	53.50	-6.04	47.46	74	-26.54	Peak
2483.5	38.03	-6.04	31.99	54	-22.01	AVG
2500	53.94	-6.06	47.88	74	-26.12	Peak
2500	38.05	-6.06	31.99	54	-22.01	AVG

Remark :Factor= Antenna Factor + Cable Loss - Pre-amplifier





### 3.3. Maximum Peak Conducted Output Power

#### Limit

For frequency hopping systems operating in the 2400-2483.5 MHz band employing at least 75 non-overlapping hopping channels, and all frequency hopping systems in the 5725-5850 MHz band: 1 watt.

For all other frequency hopping systems in the 2400-2483.5 MHz band: 0.125 watts.

#### Test Procedure

Remove the antenna from the EUT and then connect a low loss RF cable from the antenna port to the Spectrum..

#### Test Configuration

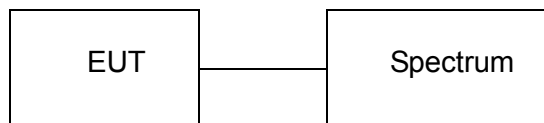

#### Test Results

Type	Channel	Output power (dBm)	Limit (dBm)	Result
GFSK	00	-0.726	21	Pass
	39	-0.897		
	78	-0.994		
π/4DQPSK	00	-0.033	21	Pass
	39	-0.188		
	78	-0.229		

Note: 1.The test results including the cable lose.

Refer to the figure below:



### GFSK Modulation

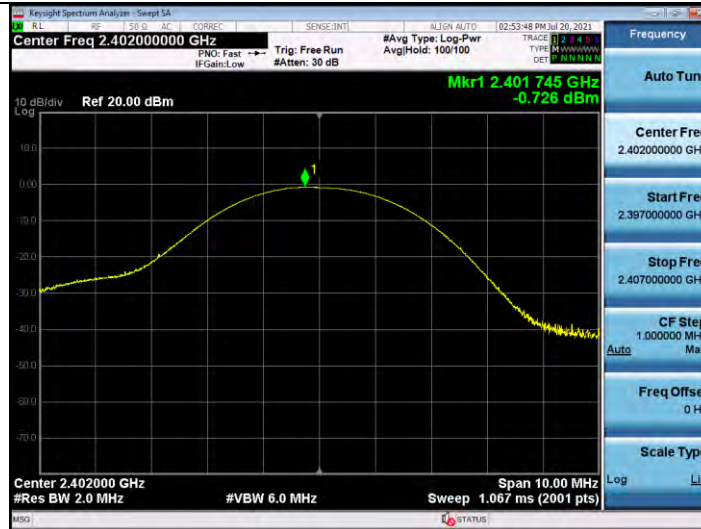

2402

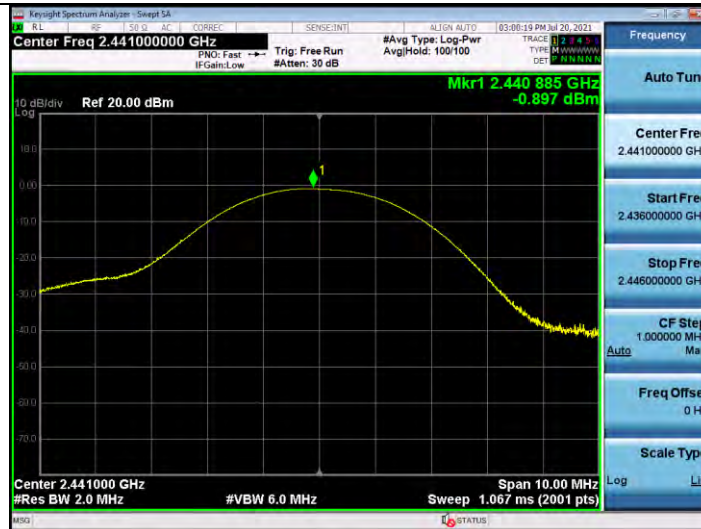

2441

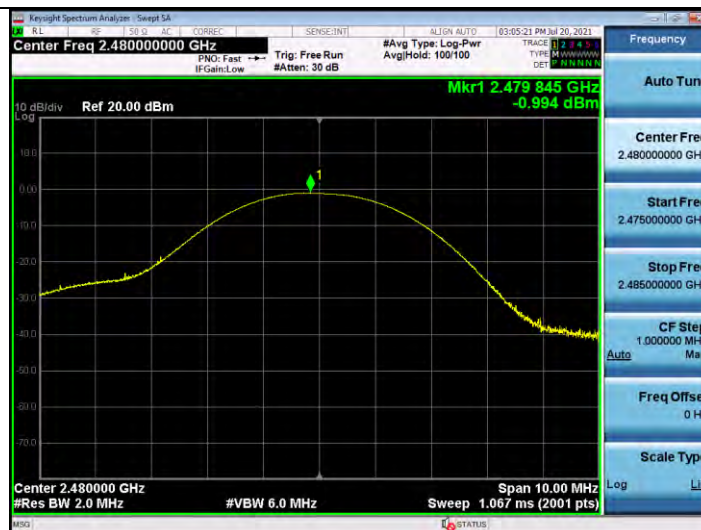

2480



### $\pi/4$ DQPSK Modulation

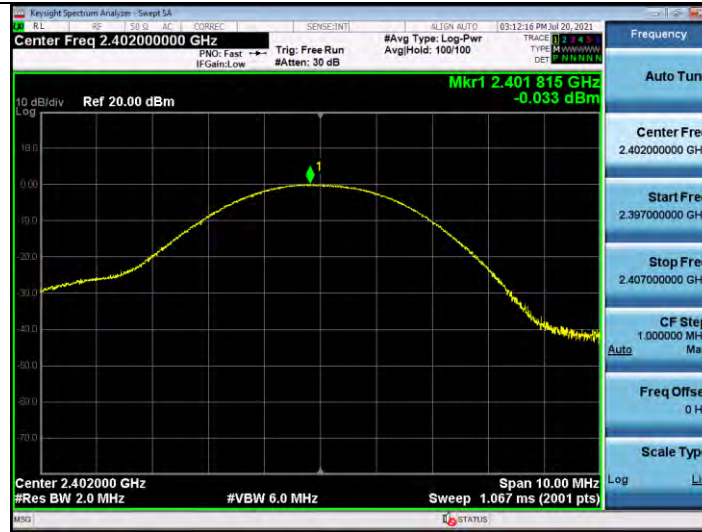

2402



2441

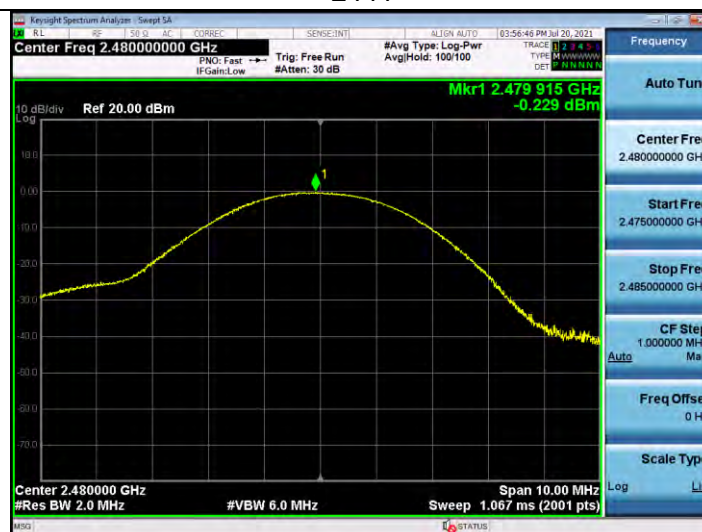

2480



### 3.4. 20dB Bandwidth

#### Limit

Frequency hopping systems shall have hopping channel carrier frequencies separated by a minimum of 25 kHz or the 20 dB bandwidth of the hopping channel, whichever is greater.

#### Test Procedure

The transmitter output was connected to the spectrum analyzer through an attenuator. The bandwidth of the fundamental frequency was measured by spectrum analyzer with RBW (1% to 5% of the OBW ) and VBW is 3 X RBW.

The 20dB bandwidth is defined as the total spectrum the power of which is higher than peak power minus 20dB.

The occupied bandwidth is the frequency bandwidth such that, below its lower and above its upper frequency limits, the mean powers are each equal to 0.5% of the total mean power of the given emission. The following procedure shall be used for measuring 99% power bandwidth:

RBW=1% to 5% of the OBW

VBW=approximately 3 X RBW

Detector=Peak

Trace Mode: Max Hold

Use the 99% power bandwidth function of the instrument to measure the Occupied Bandwidth and recorded.

#### Test Configuration

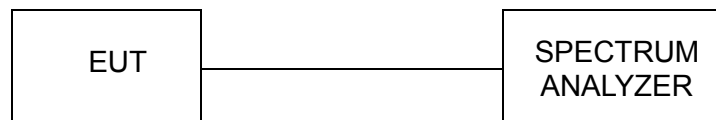

#### Test Results

Modulation	Channel	20dB bandwidth (MHz)	Result
GFSK	CH00	0.8833	Pass
	CH39	0.8618	
	CH78	0.8630	
π/4DQPSK	CH00	1.307	
	CH39	1.259	
	CH78	1.333	



Test plot as follows:

### GFSK Modulation



### CH00

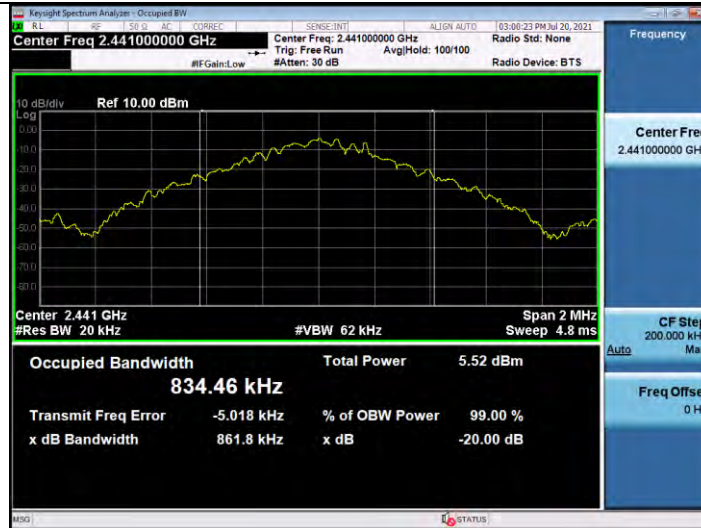

### CH39



### CH78



### $\pi/4$ DQPSK Modulation

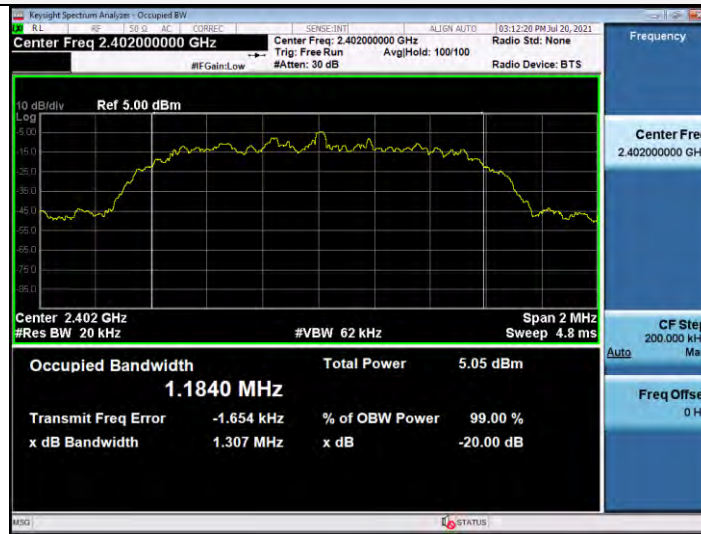

### CH00

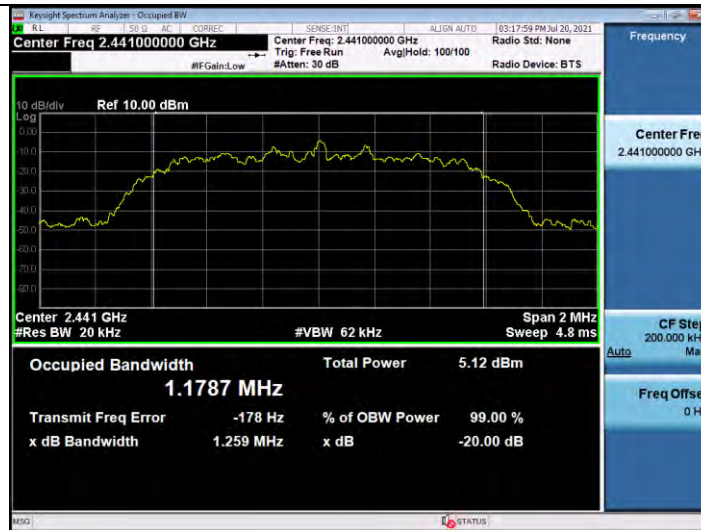

### CH39



### CH78



### 3.5. Frequency Separation

#### LIMIT

Frequency hopping systems shall have hopping channel carrier frequencies separated by minimum of 25KHz or the  $2/3 \times 20\text{dB}$  bandwidth of the hopping channel, whichever is greater.

#### TEST PROCEDURE

The transmitter output was connected to the spectrum analyzer through an attenuator. The bandwidth of the fundamental frequency was measured by spectrum analyzer with 30 KHz RBW and 100 KHz VBW.

#### TEST CONFIGURATION

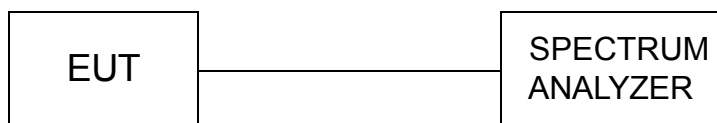

#### TEST RESULTS

Modulation	Channel	Channel Separation (MHz)	Limit(MHz)	Result
GFSK	CH00	1.003	0.589	Pass
	CH01			
	CH39	0.996	0.575	
	CH40			
	CH77	0.997	0.575	
	CH78			
$\pi/4$ DQPSK	CH00	0.987	0.871	Pass
	CH01			
	CH39	1.006	0.839	
	CH40			
	CH77	0.999	0.889	
	CH78			

Note: We have tested all mode at high, middle and low channel, and recorded worst case



Test plot as follows:







### $\pi/4$ DQPSK

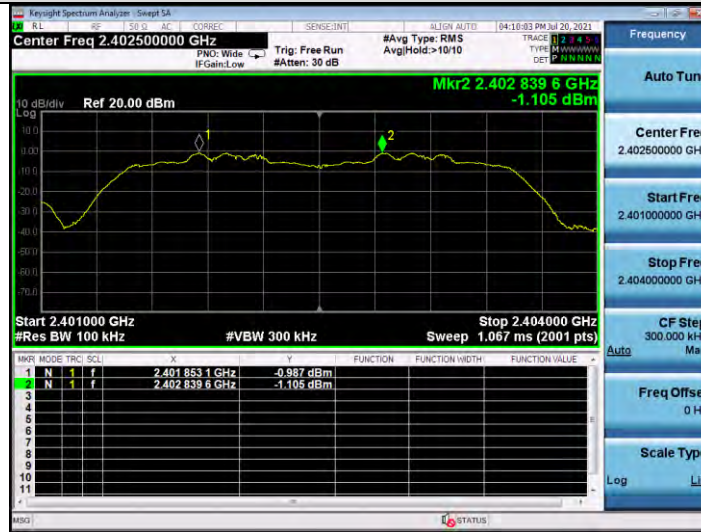

### CH00- CH01

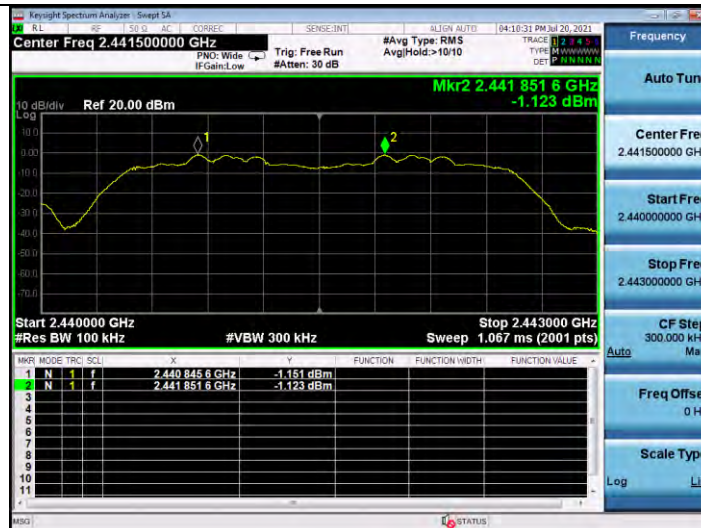

### CH39- CH40

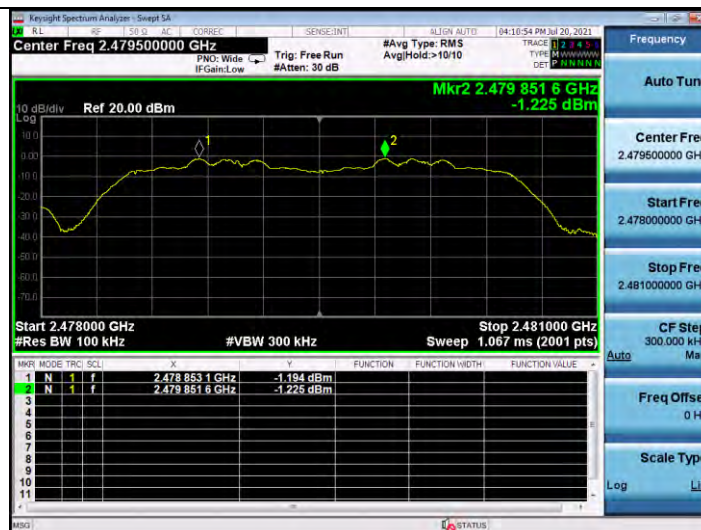

### CH77- CH78



### 3.6. Number of hopping frequency

#### Limit

Frequency hopping systems in the 2400–2483.5 MHz band shall use at least 15 channels.

#### Test Procedure

The transmitter output was connected to the spectrum analyzer through an attenuator. Set spectrum analyzer start 2400MHz to 2483.5MHz.

#### Test Configuration

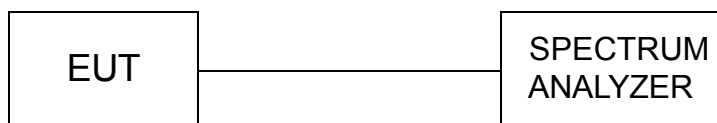

#### Test Results

Modulation	Number of Hopping Channel	Limit	Result
GFSK	79	≥15	Pass
$\pi/4$ DQPSK	79		



Test plot as follows:

### GFSK Modulation

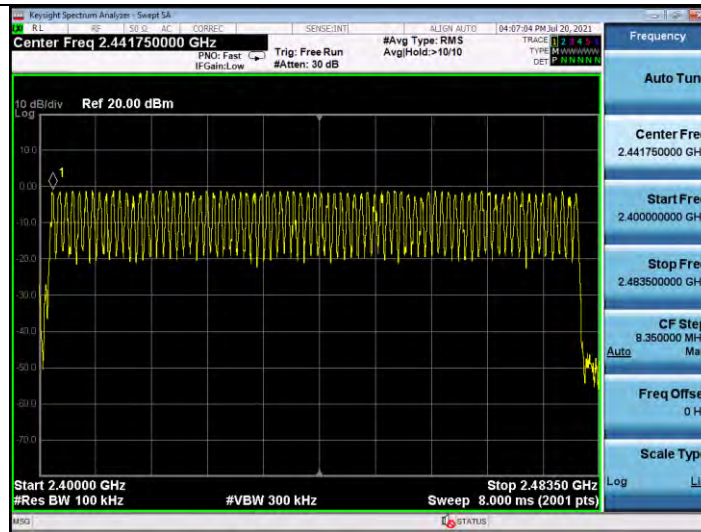

### $\pi/4$ DQPSK Modulation





### 3.7. Time of Occupancy (Dwell Time)

#### Limit

The average time of occupancy on any channel shall not be greater than 0.4 seconds within a period of 0.4 seconds multiplied by the number of hopping channels employed.

#### Test Procedure

The transmitter output was connected to the spectrum analyzer through an attenuator. Set center frequency of spectrum analyzer=operating frequency with 1MHz RBW and 3MHz VBW, Span 0Hz.

#### Test Configuration

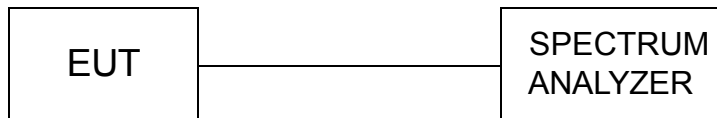

**Test Results**

Mode	Packet	Channel	Burst Width [ms/hop/ch]	Dwell Time[ms]	Limit (second)
GFSK	DH1	LCH	0.3789	121.248	≤0.4
GFSK	DH1	MCH	0.3789	121.248	≤0.4
GFSK	DH1	HCH	0.3789	121.248	≤0.4
GFSK	DH3	LCH	1.636	261.760	≤0.4
GFSK	DH3	MCH	1.638	262.080	≤0.4
GFSK	DH3	HCH	1.638	262.080	≤0.4
GFSK	DH5	LCH	2.884	307.627	≤0.4
GFSK	DH5	MCH	2.887	307.947	≤0.4
GFSK	DH5	HCH	2.888	308.053	≤0.4
π/4DQPSK	2DH1	LCH	0.3888	124.416	≤0.4
π/4DQPSK	2DH1	MCH	0.3890	124.480	≤0.4
π/4DQPSK	2DH1	HCH	0.3932	125.824	≤0.4
π/4DQPSK	2DH3	LCH	1.644	263.040	≤0.4
π/4DQPSK	2DH3	MCH	1.640	262.400	≤0.4
π/4DQPSK	2DH3	HCH	1.644	263.040	≤0.4
π/4DQPSK	2DH5	LCH	2.890	308.267	≤0.4
π/4DQPSK	2DH5	MCH	2.894	308.693	≤0.4
π/4DQPSK	2DH5	HCH	2.893	308.587	≤0.4

**Note:**

1. We have tested all mode at high,middle and low channel,and recoreded worst case at middle channel.
2. Dwell time=Pulse time (ms) × (1600 ÷ 2 ÷ 79) ×31.6 Second for DH1, 2-DH1  
Dwell time=Pulse time (ms) × (1600 ÷ 4 ÷ 79) ×31.6 Second for DH3, 2-DH3  
Dwell time=Pulse time (ms) × (1600 ÷ 6 ÷ 79) ×31.6 Second for DH5, 2-DH5



Test plot as follows:

### GFSK Modulation

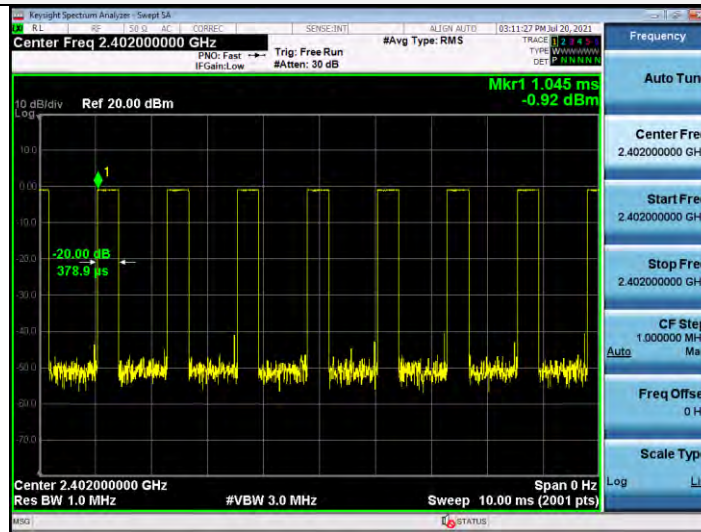

### DH1 2402

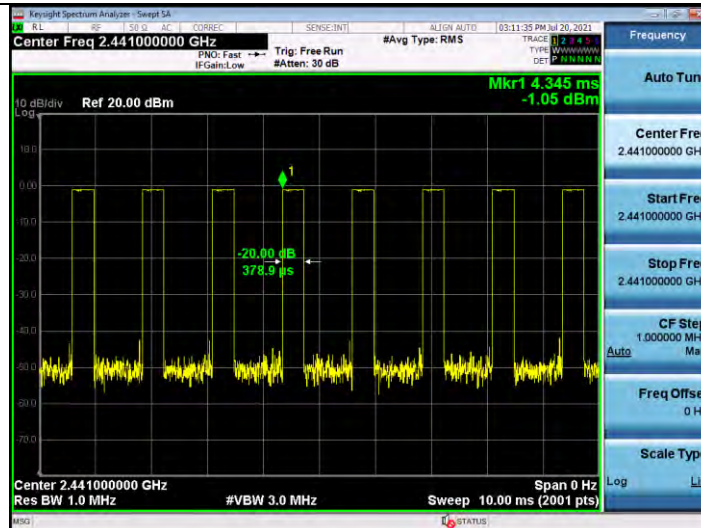

### DH1 2441

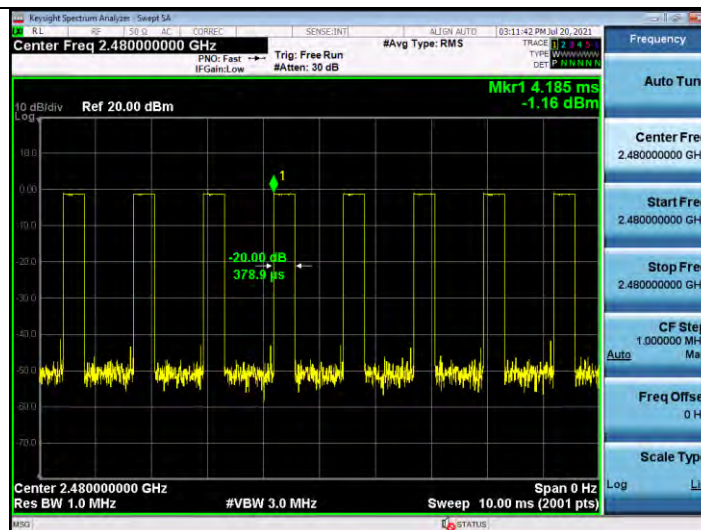

### DH1 2480



### GFSK Modulation

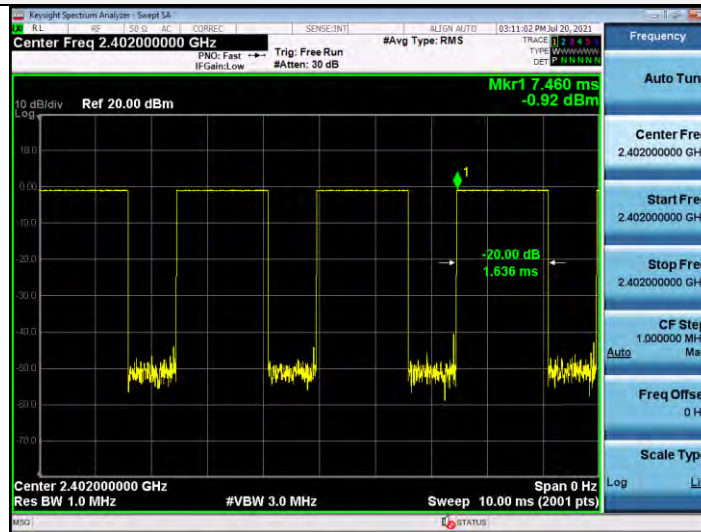

### DH3 2402

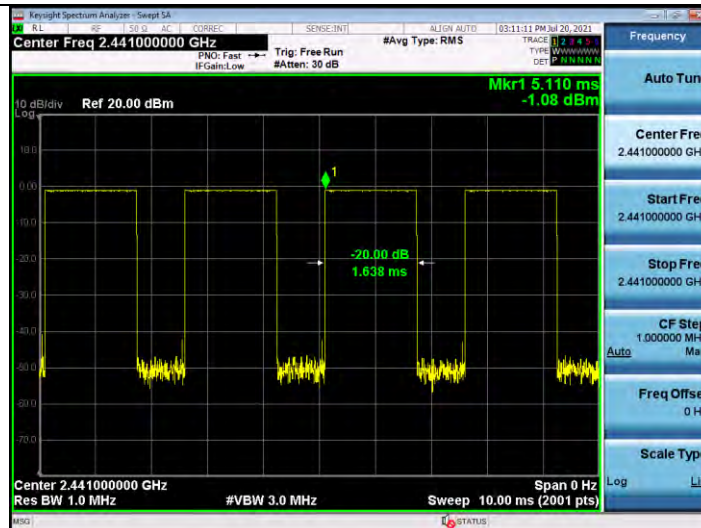

### DH3 2441

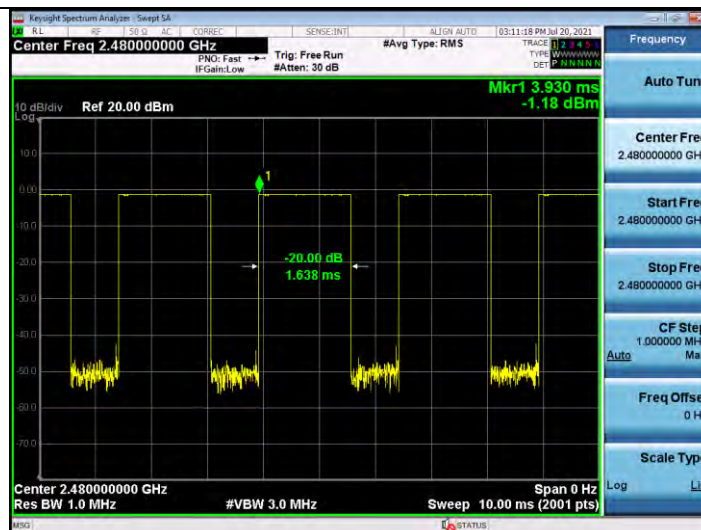

### DH3 2480



### GFSK Modulation

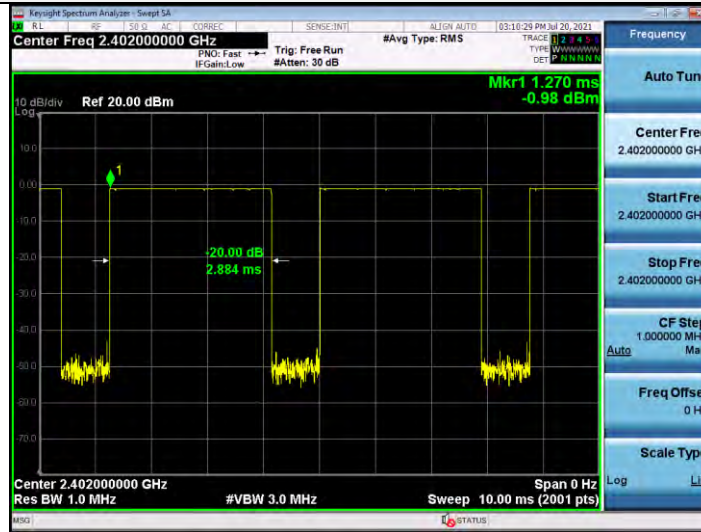

### DH5 2402

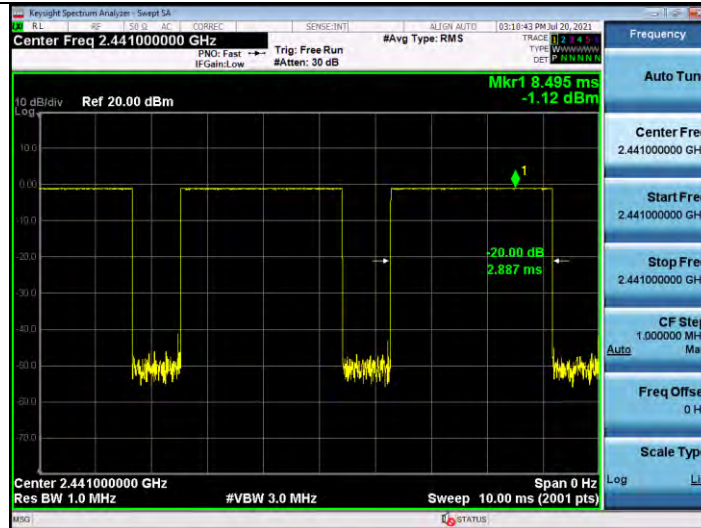

### DH5 2441

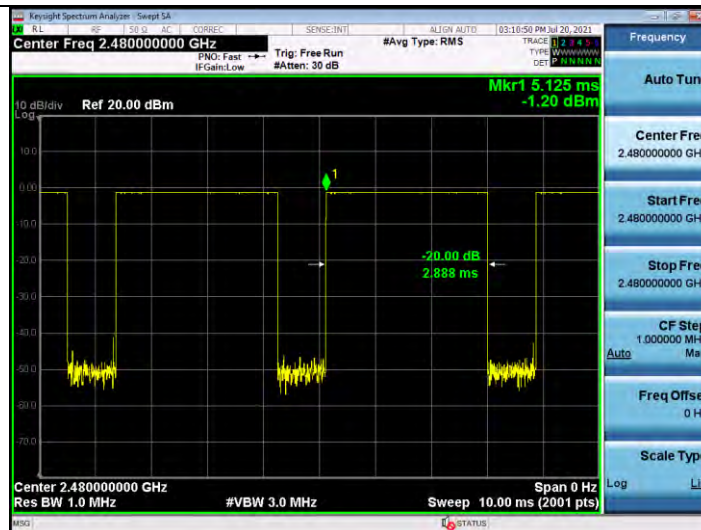

### DH5 2480





### $\pi$ /4DQPSK Modulation

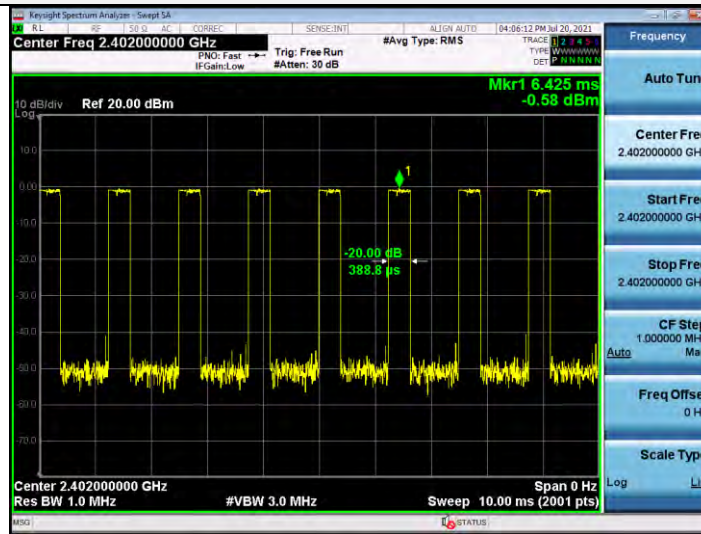

### 2-DH1 2402

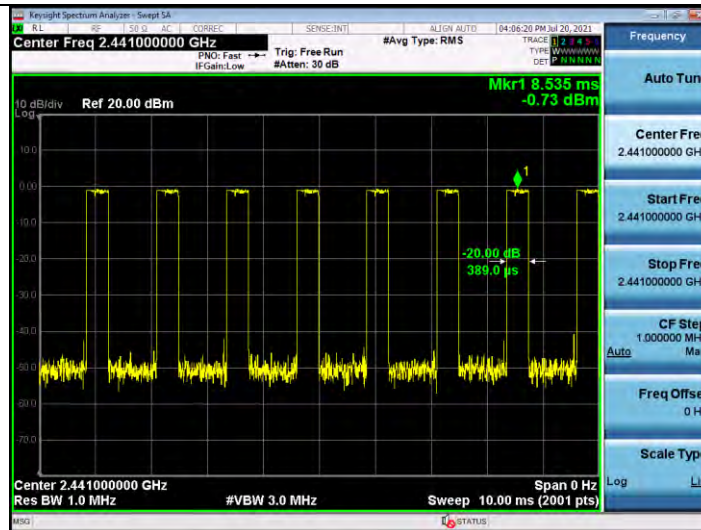

### 2-DH1 2441

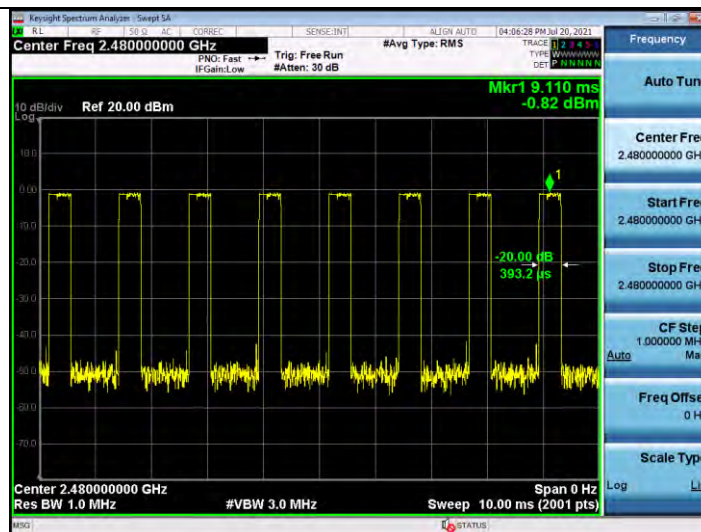

### 2-DH1 2480



### $\pi/4$ DQPSK Modulation

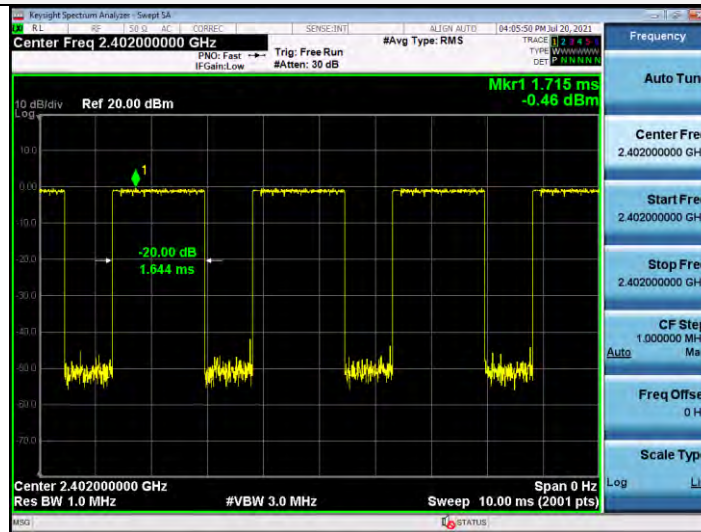

### 2-DH3 2402

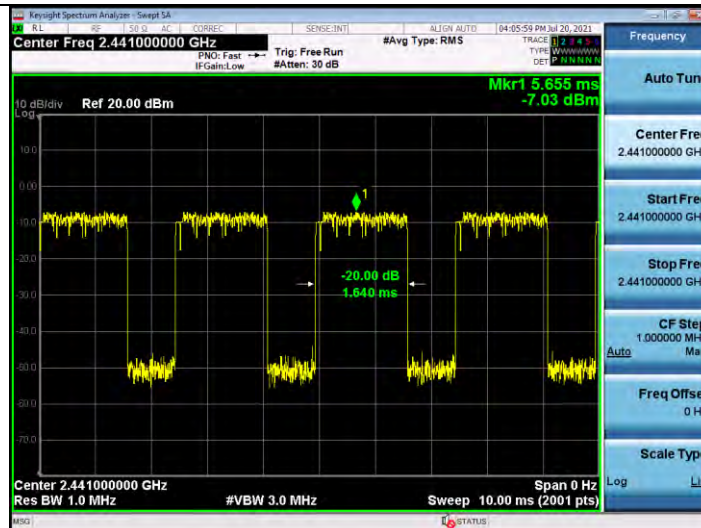

### 2-DH3 2441

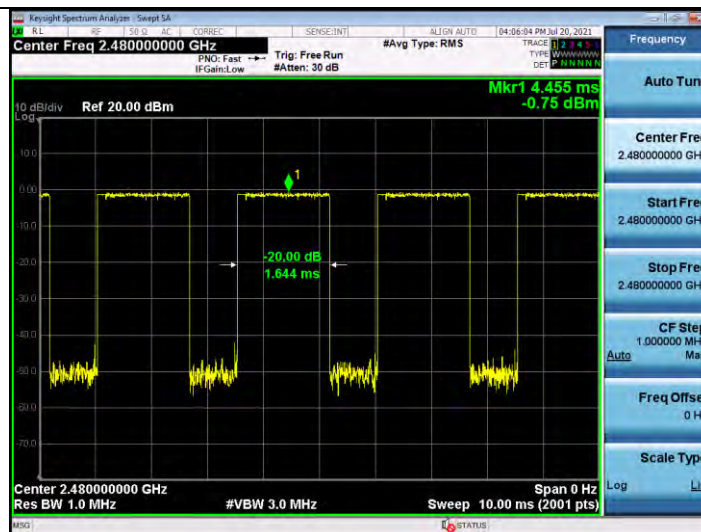

### 2-DH3 2480



### $\pi/4$ DQPSK Modulation

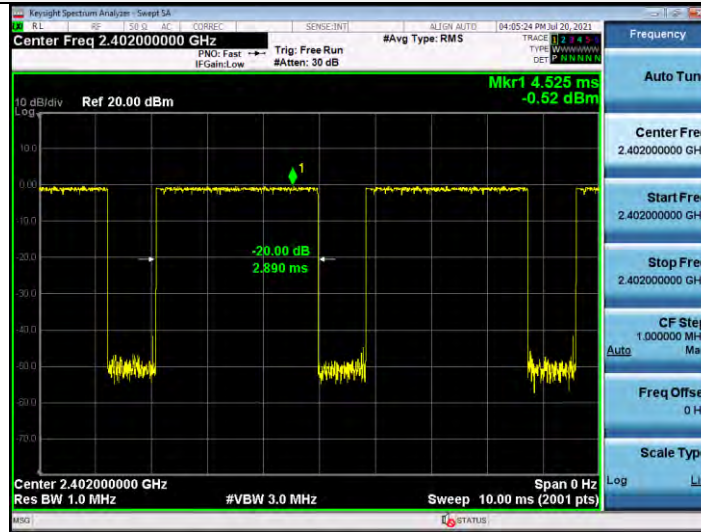

2-DH5 2402

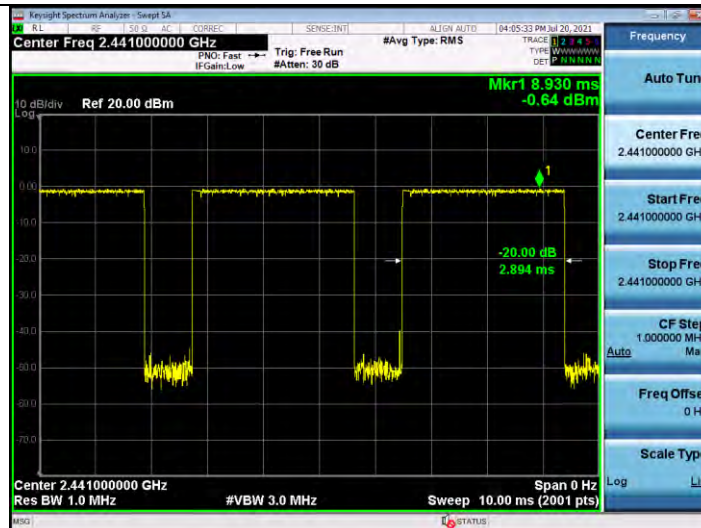

2-DH5 2441

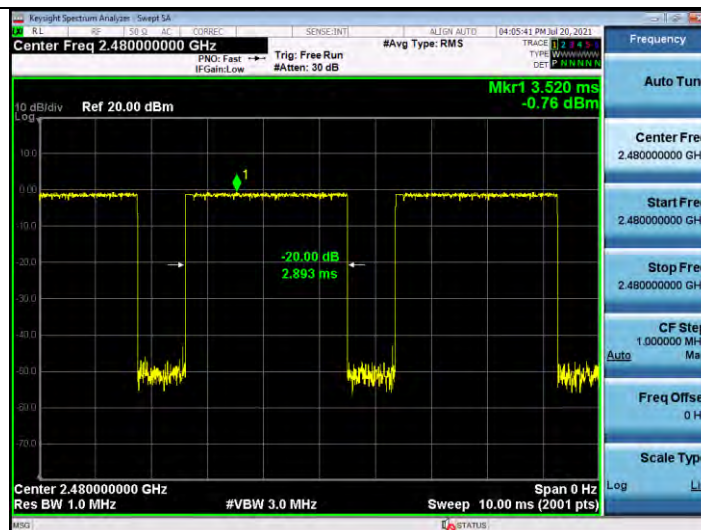

2-DH5 2480



### 3.8. Out-of-band Emissions

#### Limit

In any 100 kHz bandwidth outside the frequency band in which the spread spectrum or digitally modulated intentional radiator is operating, the radio frequency power that is produced by the intentional radiator shall be at least 20 dB below that in the 100 kHz bandwidth within the band that contains the highest level of the desired power, based on either an RF conducted or a radiated measurement, provided the transmitter demonstrates compliance with the peak conducted power limits. If the transmitter complies with the conducted power limits based on the use of RMS averaging over a time interval, as permitted under paragraph (b)(3) of this section, the attenuation required under this paragraph shall be 30 dB instead of 20 dB. Attenuation below the general limits specified in §15.209(a) is not required.

In any 100 kHz bandwidth outside the frequency band in which the spread spectrum or digitally modulated device is operating, the RF power that is produced shall be at least 20 dB below that in the 100 kHz bandwidth within the band that contains the highest level of the desired power, based on either an RF conducted or a radiated measurement, provided that the transmitter demonstrates compliance with the peak conducted power limits. If the transmitter complies with the conducted power limits based on the use of root-mean-square averaging over a time interval, as permitted under Section 5.4(4), the attenuation required shall be 30 dB instead of 20 dB. Attenuation below the general field strength limits specified in RSS-Gen is not required.

#### Test Procedure

Connect the transmitter output to spectrum analyzer using a low loss RF cable, and set the spectrum analyzer to RBW=100 kHz, VBW= 300 kHz, peak detector, and max hold. Measurements utilizing these settings are made of the in-band reference level, bandedge and out-of-band emissions.

#### Test Configuration

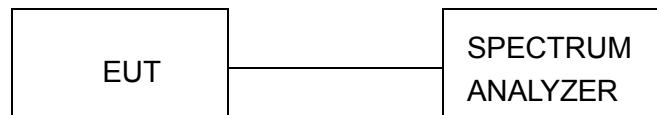

#### Test Results

Remark: The measurement frequency range is from 30MHz to the 10th harmonic of the fundamental frequency. The lowest, middle and highest channels are tested to verify the spurious emissions and bandage measurement data.



Test plot as follows:

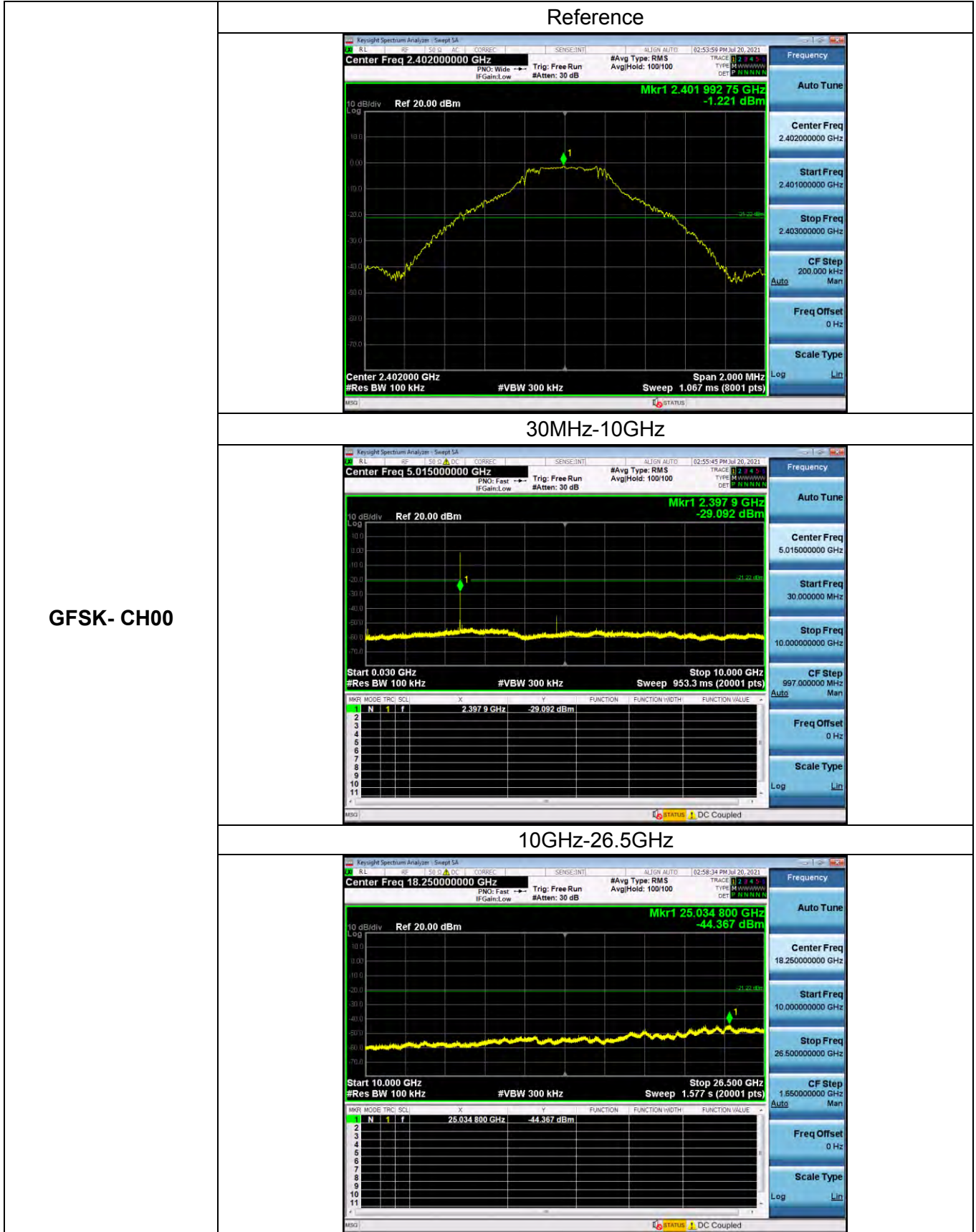



GFSK - CH39

Reference



30MHz-10GHz

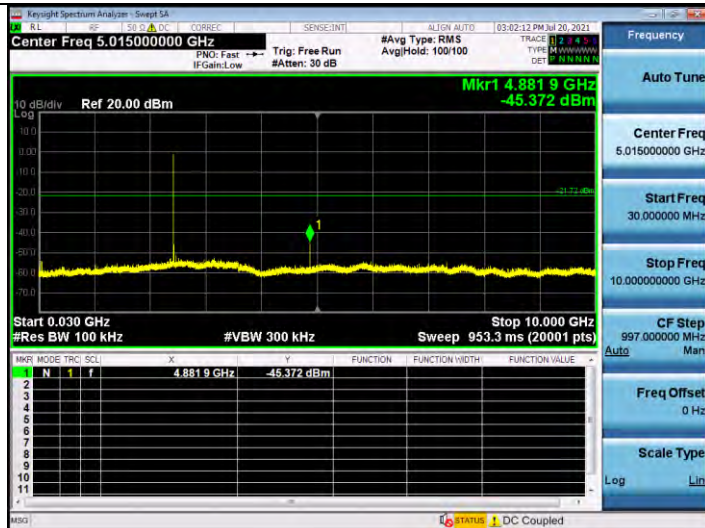

10GHz-26.5GHz

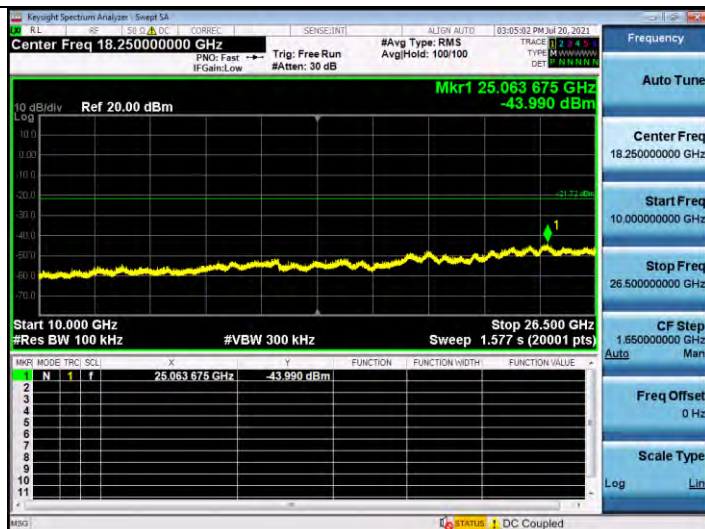



GFSK - CH78

Reference



30MHz-10GHz

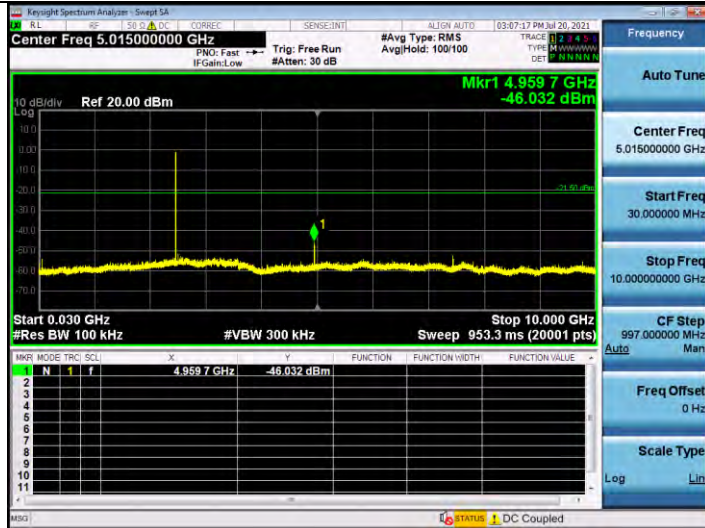

10GHz-26.5GHz

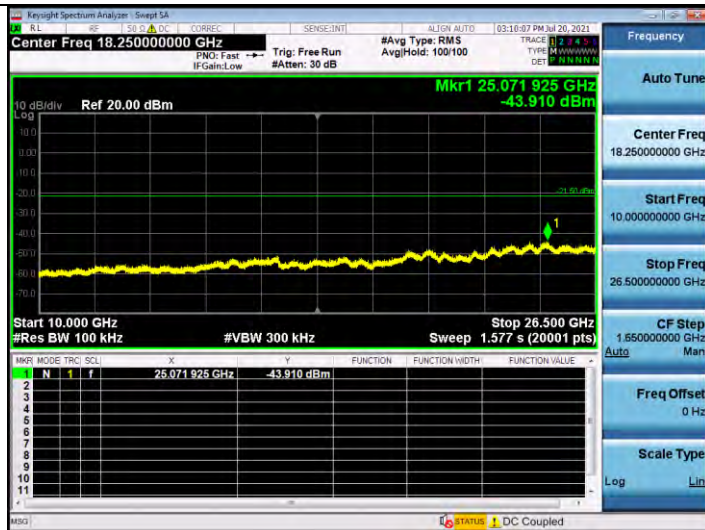



### Left Band edge hopping off

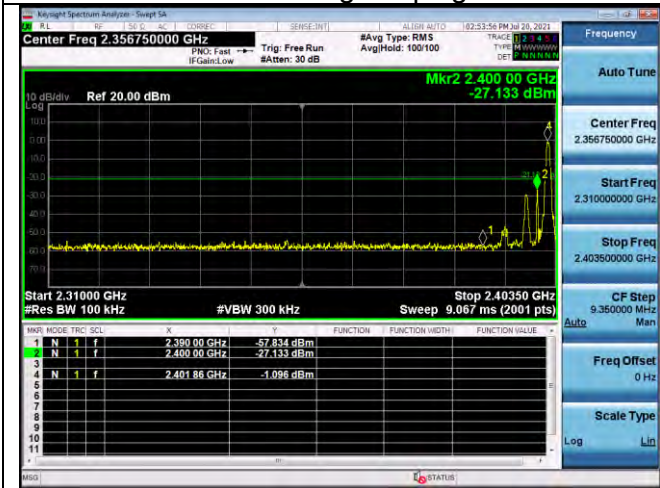

### Right Band edge hopping off

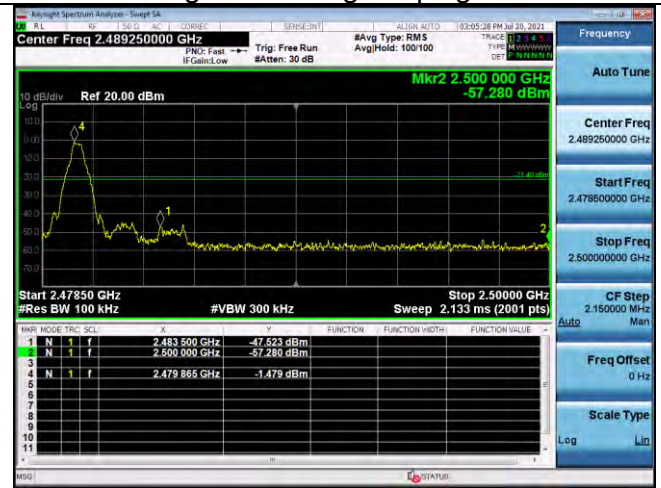

### Left Band edge hopping on

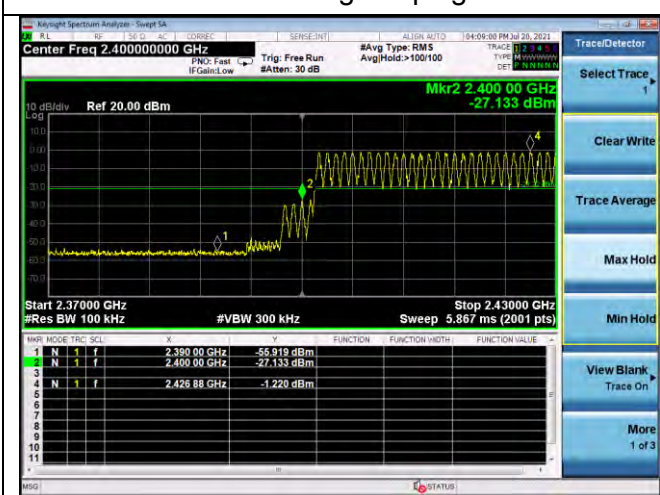

### Right Band edge hopping on

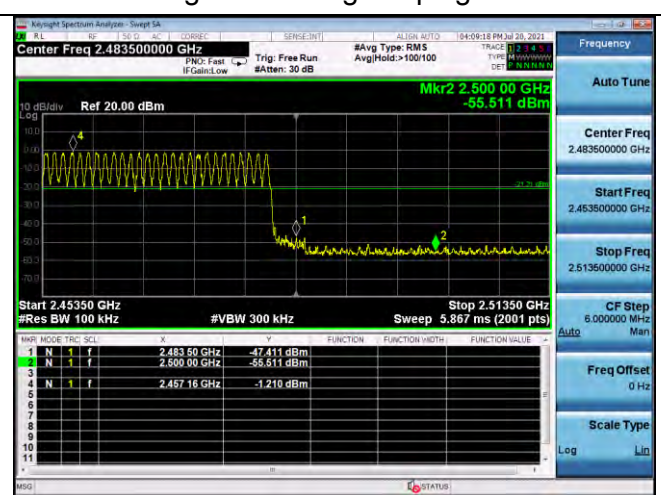



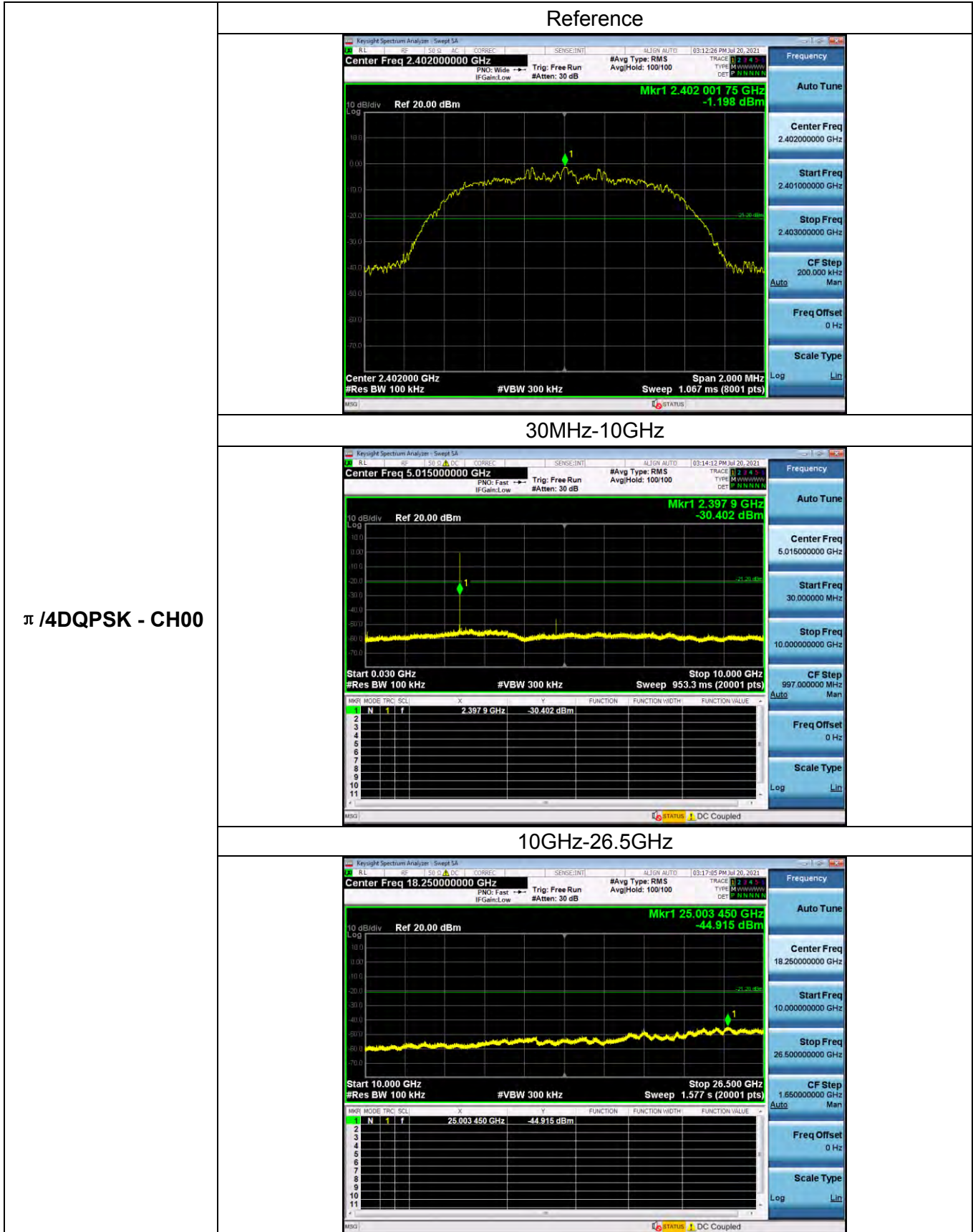

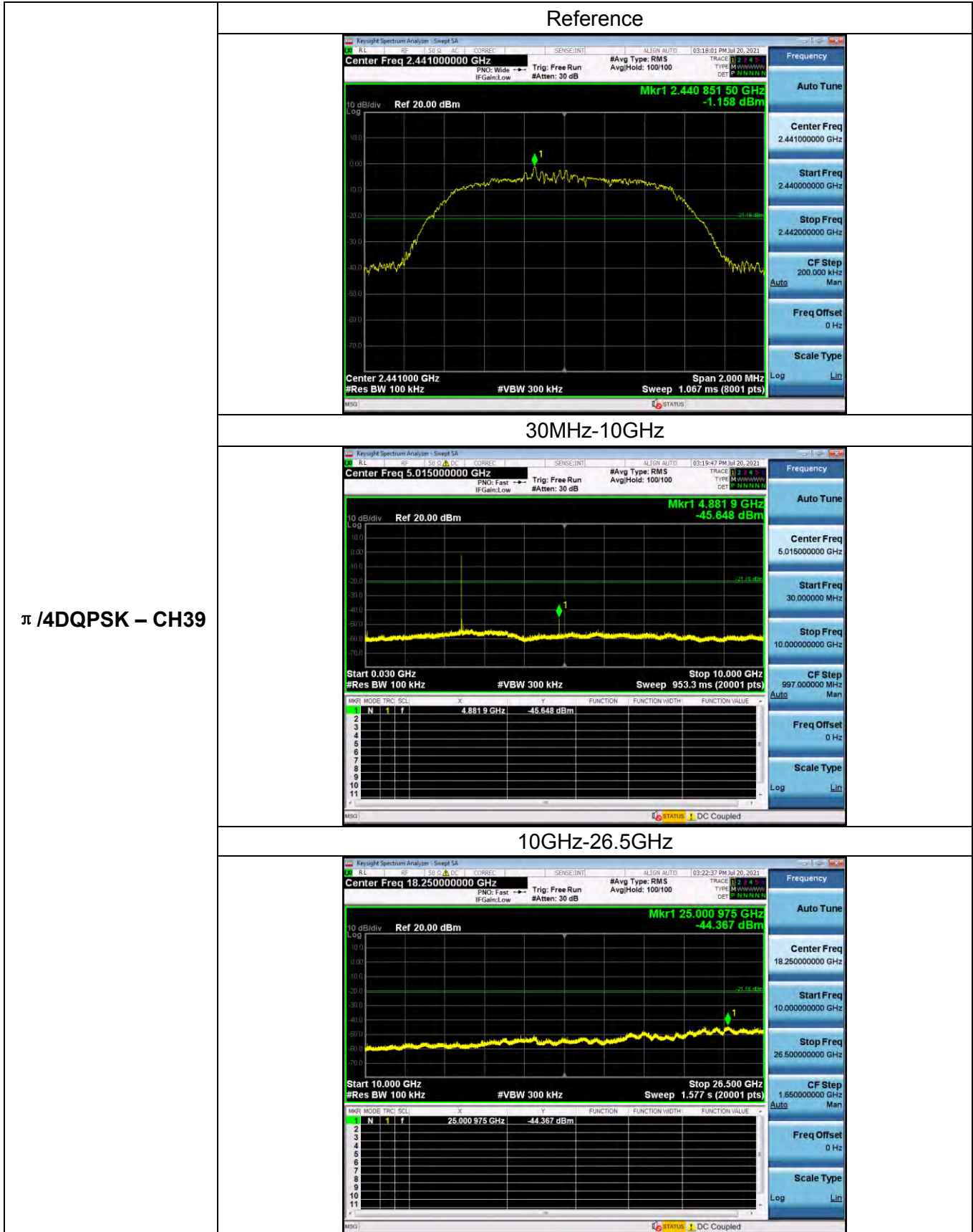

$\pi$  /4DQPSK – CH39

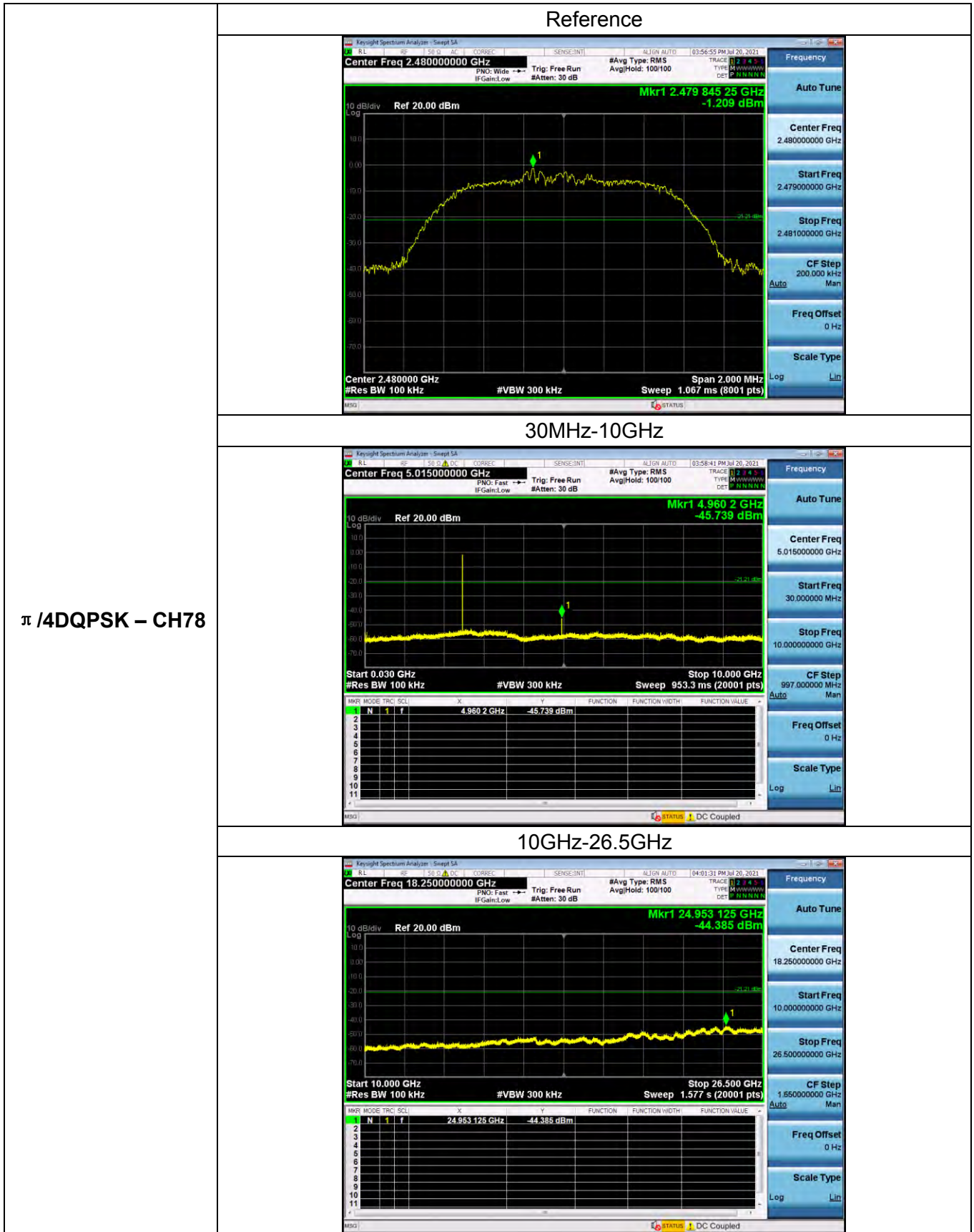



### Left Band edge hopping off

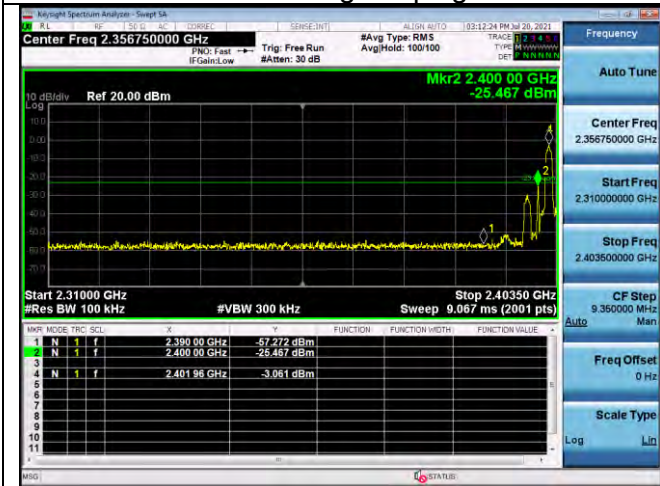

### Right Band edge hopping off

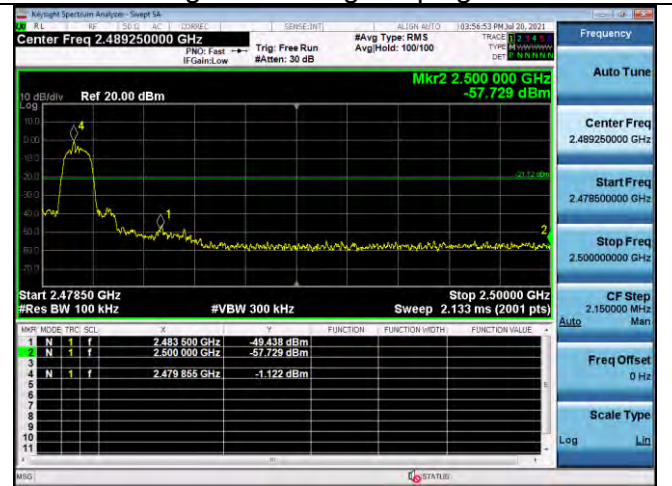

### Left Band edge hopping on

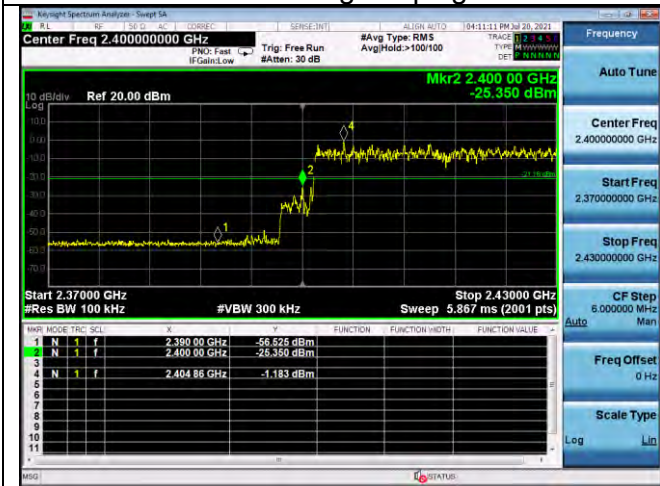

### Right Band edge hopping on

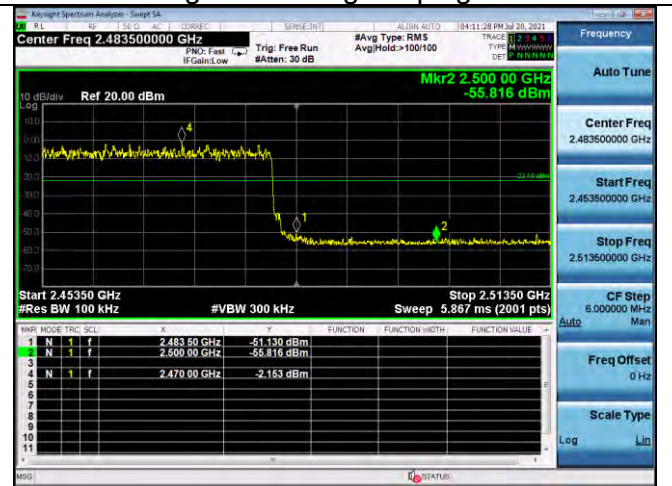

### 3.9. Pseudorandom Frequency Hopping Sequence

#### TEST APPLICABLE

**For 47 CFR Part 15C section 15.247 (a) (1):**

Frequency hopping systems shall have hopping channel carrier frequencies separated by a minimum of 25 kHz or the 20 dB bandwidth of the hop-ping channel, whichever is greater. Alternatively, frequency hopping systems operating in the 2400–2483.5 MHz band may have hopping channel carrier frequencies that are separated by 25 kHz or two-thirds of the 20 dB bandwidth of the hopping channel, whichever is greater, provided the systems operate with an output power no greater than 125 mW. The system shall hop to channel frequencies that are selected at the system hopping rate from a pseudo randomly ordered list of hopping frequencies. Each frequency must be used equally on the average by each transmitter. The system receivers shall have input bandwidths that match the hop-ping channel bandwidths of their corresponding transmitters and shall shift frequencies in synchronization with the transmitted signals.

#### EUT Pseudorandom Frequency Hopping Sequence Requirement

The pseudorandom frequency hopping sequence may be generated in a nine-stage shift register whose 5<sup>th</sup> and 9<sup>th</sup> stage outputs are added in a modulo-two addition stage. And the result is fed back to the input of the first stage. The sequence begins with the first one of 9 consecutive ones, for example: the shift register is initialized with nine ones.

- Number of shift register stages:9
- Length of pseudo-random sequence: $2^9-1=511$  bits
- Longest sequence of zeros:8(non-inverted signal)

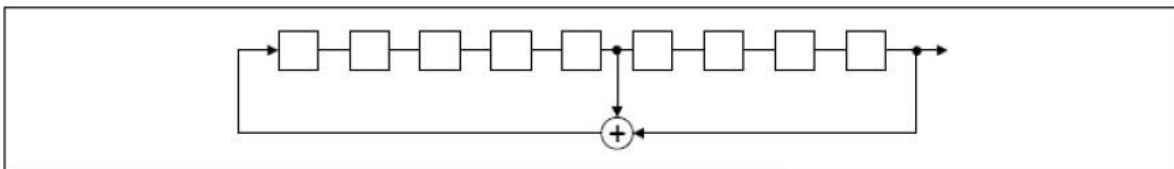

*Linear Feedback Shift Register for Generation of the PRBS sequence*

An example of pseudorandom frequency hopping sequence as follows:

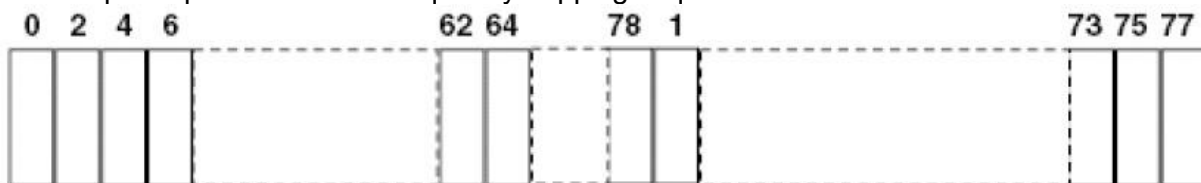

Each frequency used equally one the average by each transmitter.

The system receiver have input bandwidths that match the hopping channel bandwidths of their corresponding transmitter and shift frequencies in synchronization with the transmitted signals.

### 3.10. ANTENNA REQUIREMENT

#### Standard Applicable

For intentional device, according to FCC 47 CFR Section 15.203, an intentional radiator shall be designed to ensure that no antenna other than that furnished by the responsible party shall be used with the device. And according to FCC 47 CFR Section 15.247, if transmitting antennas of directional gain greater than 6dBi are used, the power shall be reduced by the amount in dB that the directional gain of the antenna exceeds 6dBi.

#### Refer to statement below for compliance.

The manufacturer may design the unit so that the user can replace a broken antenna, but the use of a standard antenna jack or electrical connector is prohibited. Further, this requirement does not apply to intentional radiators that must be professionally installed.

#### Antenna Connected Construction

The PCB antenna used in the product is a permanently connected antenna that complies with the provisions of part 15.203 requirement in this section. The antenna used in this product is a PCB Antenna, The directional gains of antenna used for transmitting is 0 dBi.

PCB Antenna

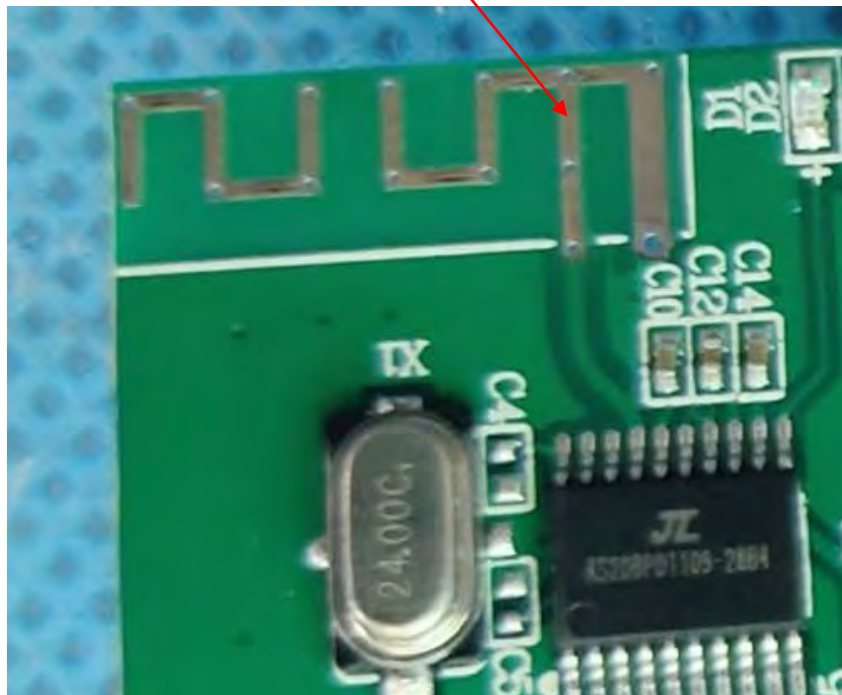

## 4. Test Setup Photos of the EUT

Radiated Emissions





Conducted Emissions





## 5. PHOTOS OF THE EUT

### External photos

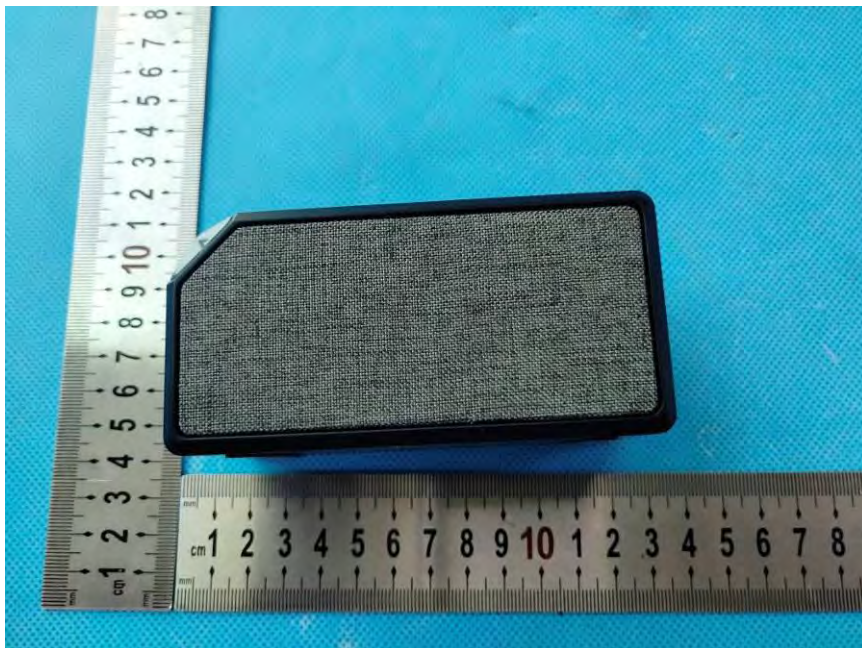



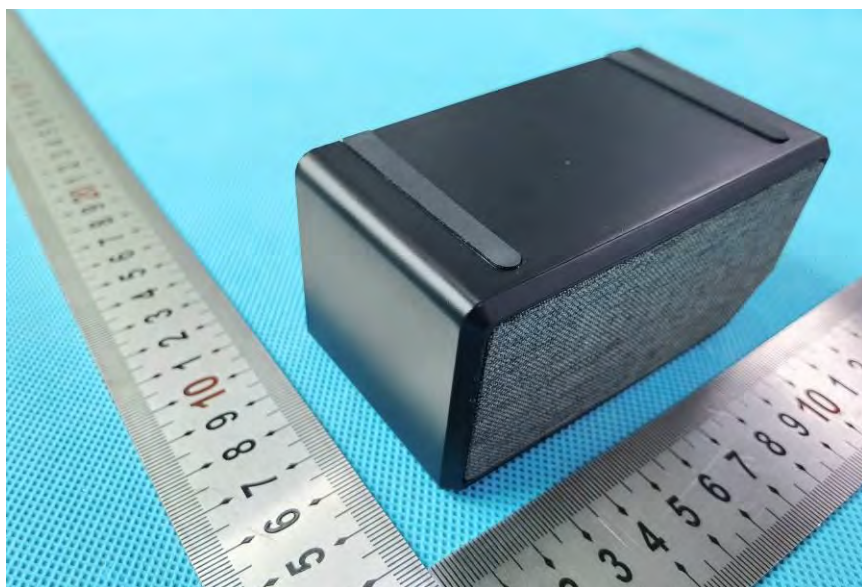
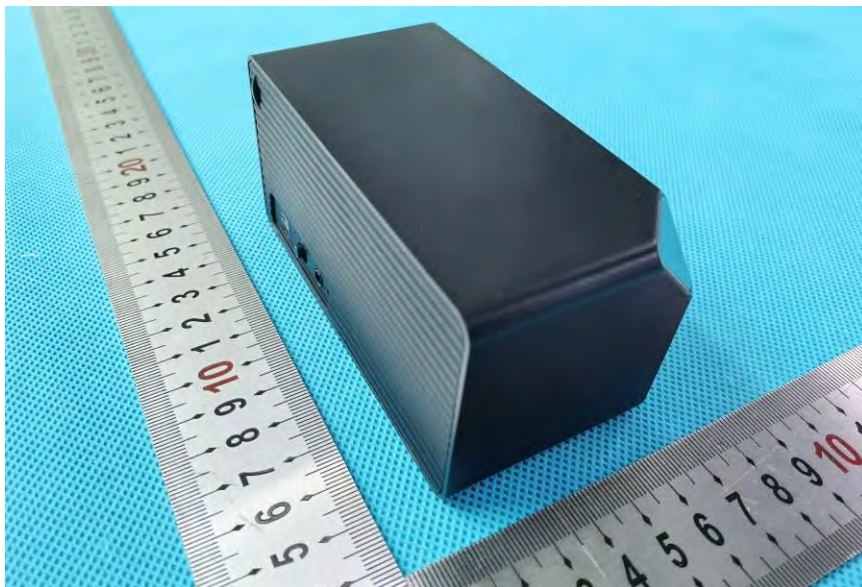

**Internal photos**

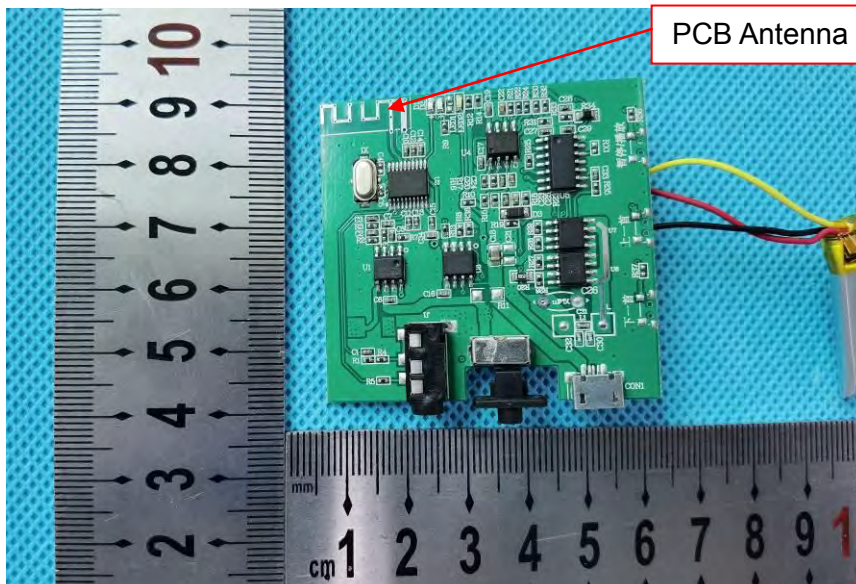
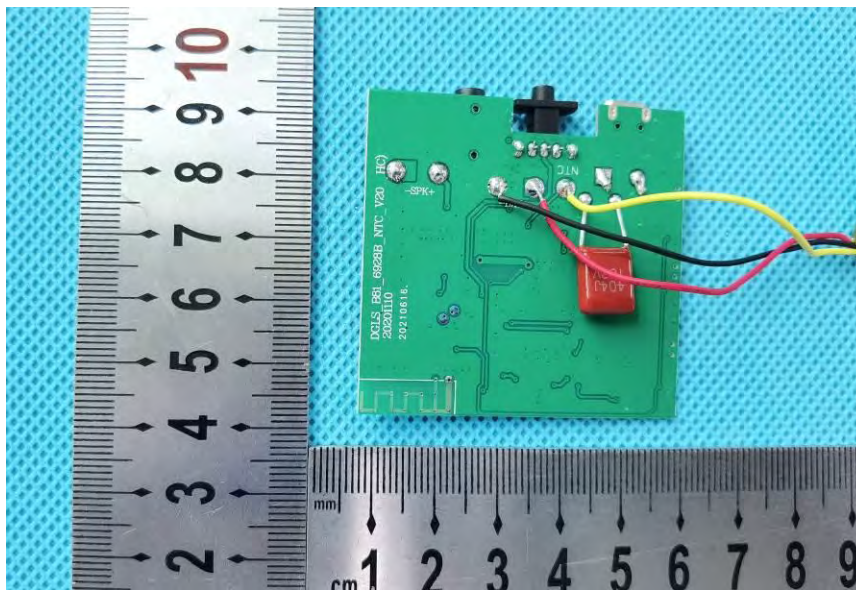
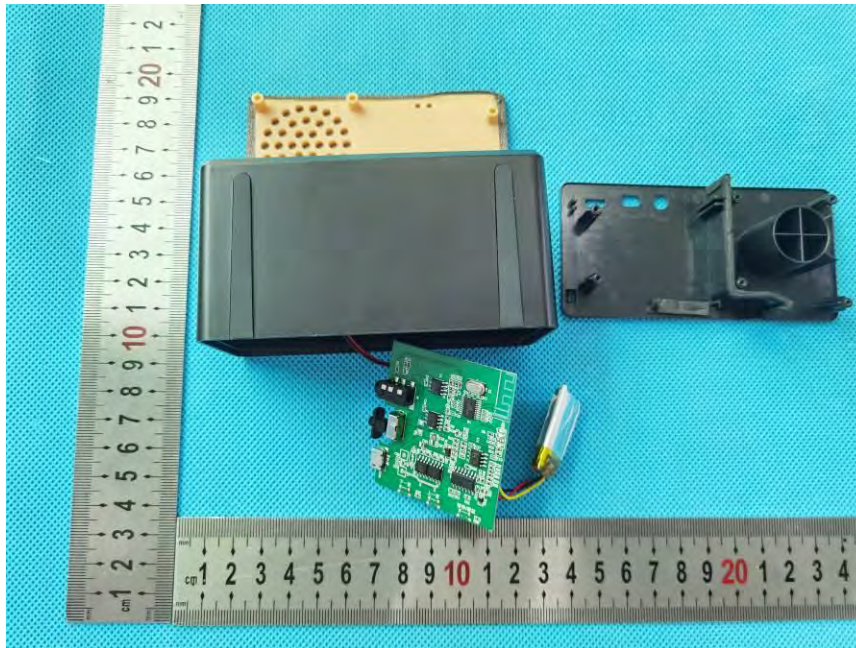

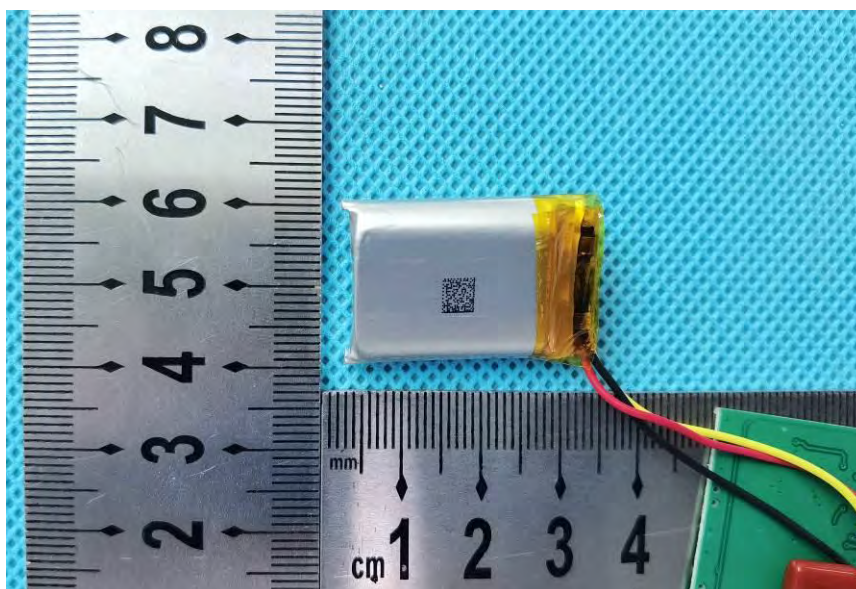
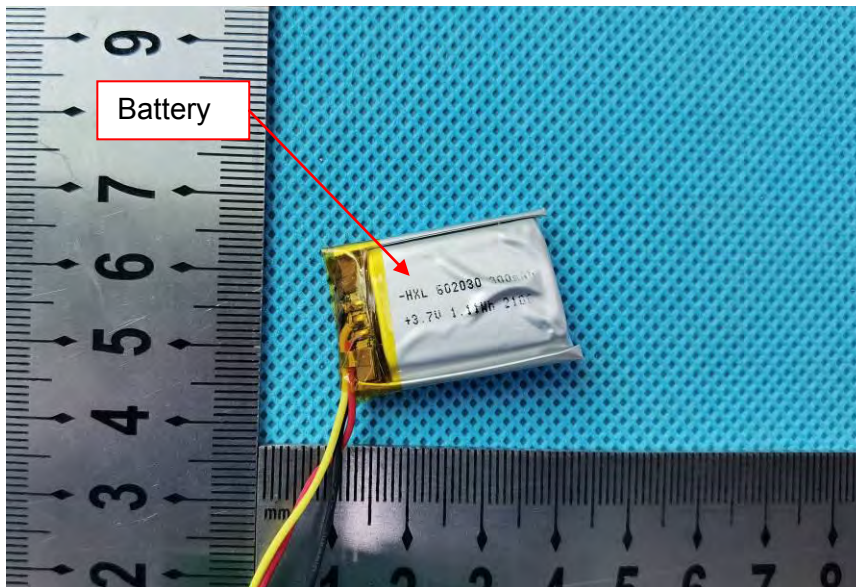

END