

3. 20 dB Bandwidth

3.1. Test Setup

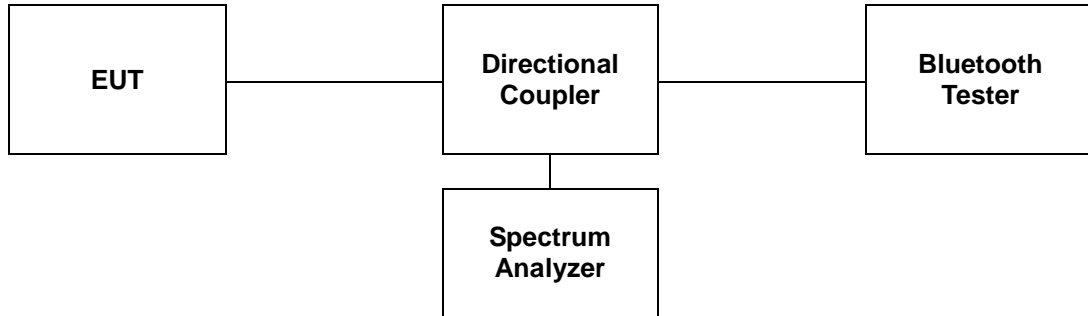

3.2. Limit

Limit: Not Applicable

3.3. Test Procedure

The test follows ANSI C63.10-2013.

The 20 dB bandwidth was measured with a spectrum analyzer connected to RF antenna connector (conducted measurement) while EUT was operating in transmit mode at the appropriate center frequency.

Use the following spectrum analyzer setting:

Span = approximately 2 to 3 times the 20 dB bandwidth, centered on a hopping channel.

RBW \geq 1 % of the 20 dB bandwidth

VBW \geq RBW

Sweep = auto

Detector = peak

Trace = max hold

The marker-to-peak function to set the mark to the peak of the emission. Use the marker-delta function to measure 20 dB down one side of the emission. Reset the function, and move the marker to the other side of the emission, until it is (as close as possible to) even with the reference marker level. The marker-delta reading at this point is 20 dB bandwidth of the emission.

The results shown in this test report refer only to the sample(s) tested unless otherwise stated. This test report cannot be reproduced, except in full, without prior written permission of the Company. This test report does not assure KOLAS accreditation.

SGS Korea Co., Ltd. (Gunpo Laboratory) 4, LS-ro 182beon-gil, Gunpo-si, Gyeonggi-do, Korea, 15807 <http://www.sgsgroup.kr>

RTT5041-19(2017.07.10)(0)

Tel. +82 31 428 5700 / Fax. +82 31 427 2370

A4(210 mm x 297 mm)

3.4. Test Results

Ambient temperature : (23 ± 1) °C
 Relative humidity : 47 % R.H.

Test voltage: DC 12 V

| Operation Mode | Data Rate (Mbps) | Channel | Frequency (MHz) | 20 dB Bandwidth (MHz) |
|----------------|------------------|---------|-----------------|-----------------------|
| GFSK | 1 | Low | 2 402 | 0.944 |
| | | Middle | 2 441 | 0.941 |
| | | High | 2 480 | 0.944 |
| π/4DQPSK | 2 | Low | 2 402 | 1.280 |
| | | Middle | 2 441 | 1.280 |
| | | High | 2 480 | 1.277 |
| 8DPSK | 3 | Low | 2 402 | 1.259 |
| | | Middle | 2 441 | 1.259 |
| | | High | 2 480 | 1.259 |

Test voltage: DC 24 V

| Operation Mode | Data Rate (Mbps) | Channel | Frequency (MHz) | 20 dB Bandwidth (MHz) |
|----------------|------------------|---------|-----------------|-----------------------|
| GFSK | 1 | Low | 2 402 | 0.941 |
| | | Middle | 2 441 | 0.944 |
| | | High | 2 480 | 0.944 |
| π/4DQPSK | 2 | Low | 2 402 | 1.277 |
| | | Middle | 2 441 | 1.277 |
| | | High | 2 480 | 1.277 |
| 8DPSK | 3 | Low | 2 402 | 1.262 |
| | | Middle | 2 441 | 1.262 |
| | | High | 2 480 | 1.259 |

The results shown in this test report refer only to the sample(s) tested unless otherwise stated. This test report cannot be reproduced, except in full, without prior written permission of the Company. This test report does not assure KOLAS accreditation.

- Test plots

Test voltage: DC 12 V

Operating Mode: GFSK

Low channel

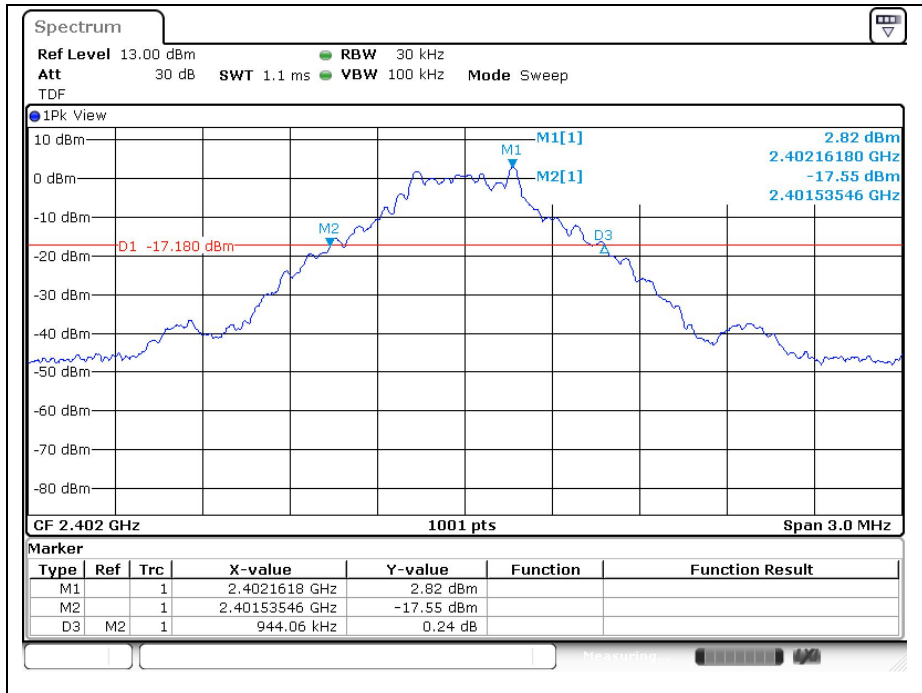

Middle channel

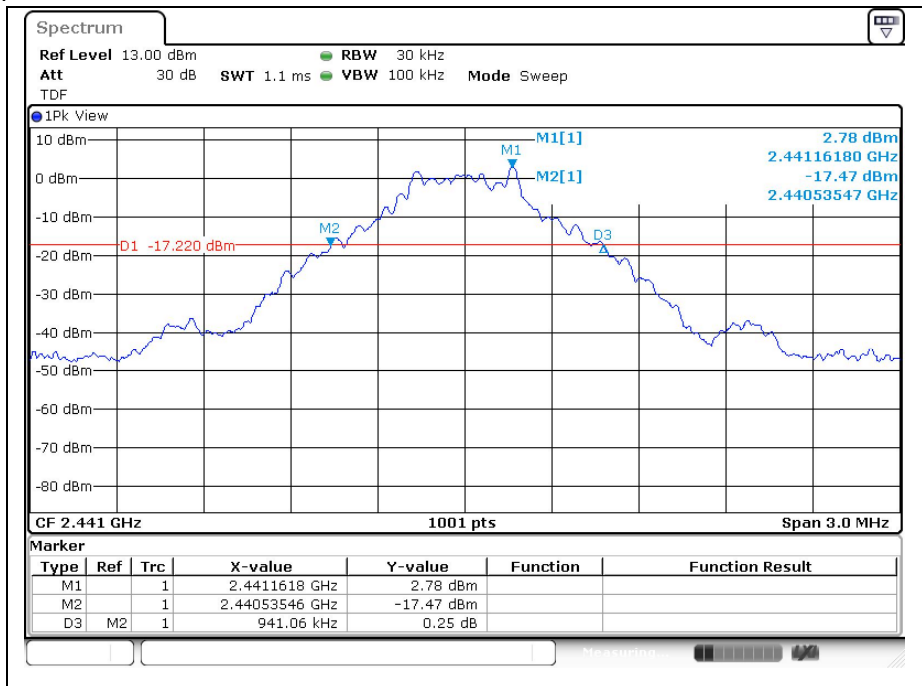

The results shown in this test report refer only to the sample(s) tested unless otherwise stated. This test report cannot be reproduced, except in full, without prior written permission of the Company. This test report does not assure KOLAS accreditation.

High channel

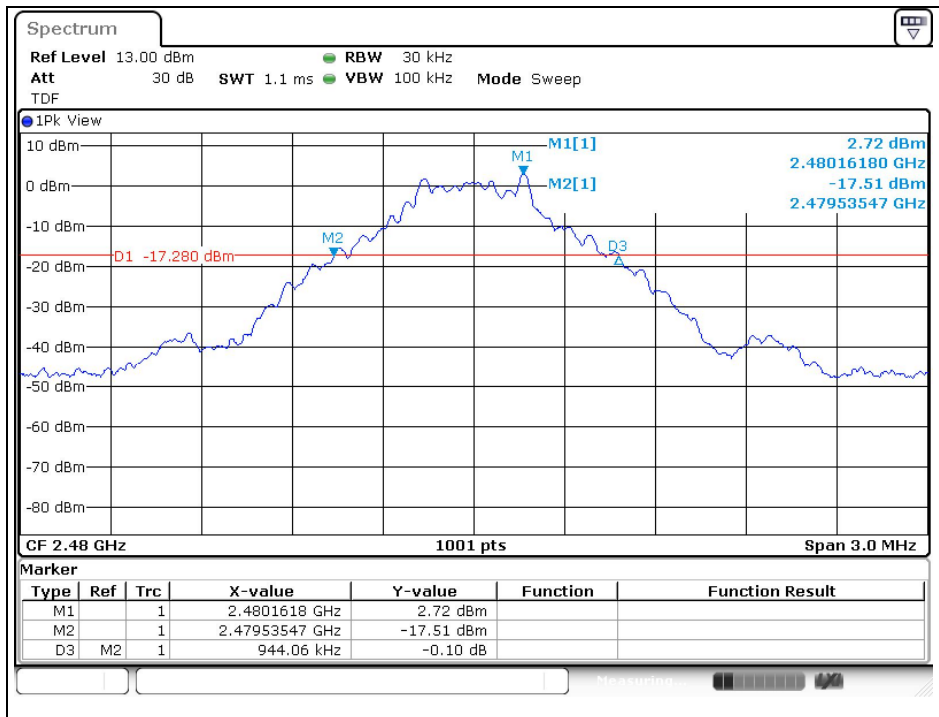

Operating Mode: $\pi/4$ DQPSK

Low channel

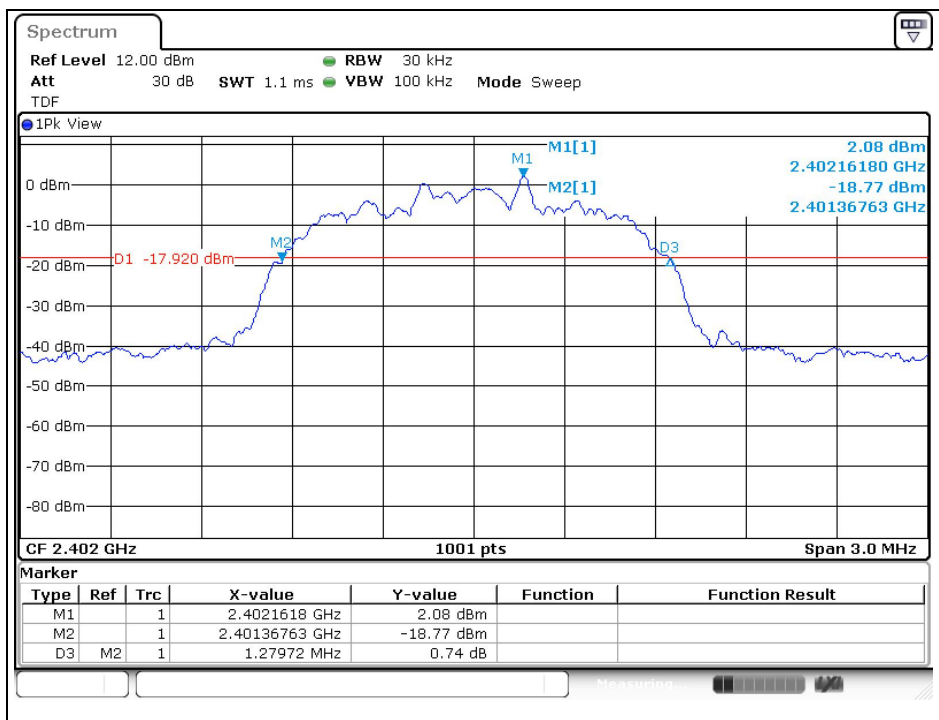

The results shown in this test report refer only to the sample(s) tested unless otherwise stated. This test report cannot be reproduced, except in full, without prior written permission of the Company. This test report does not assure KOLAS accreditation.

Middle channel

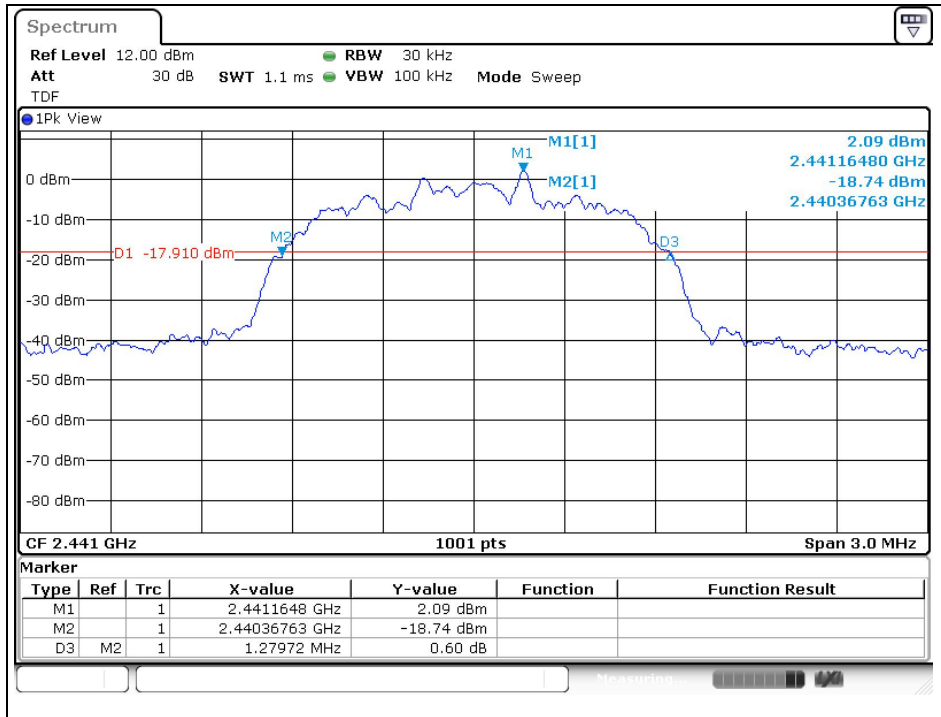

High channel

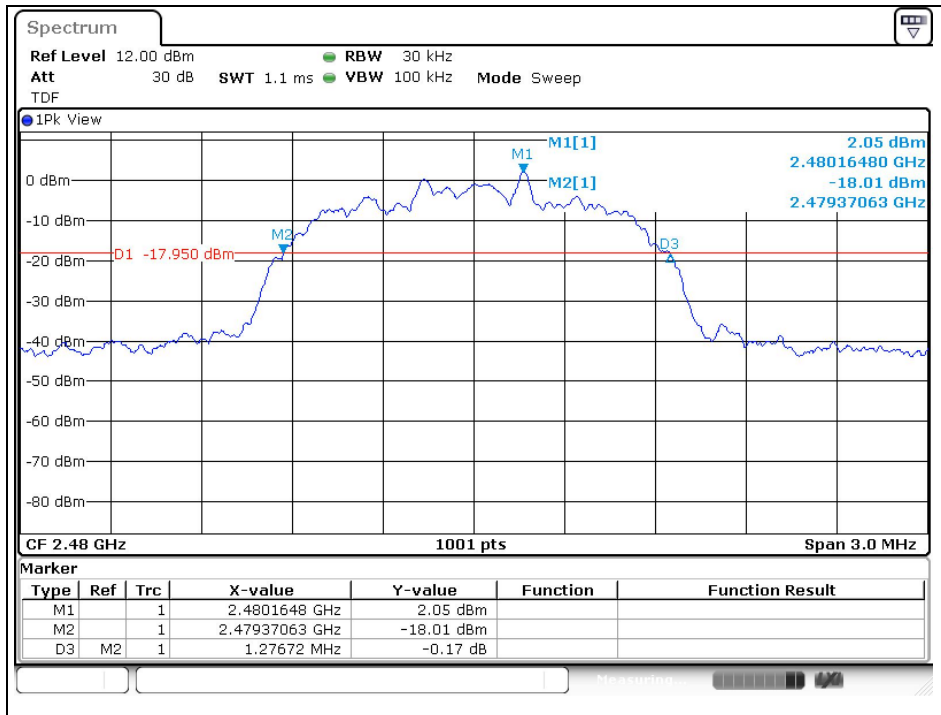

The results shown in this test report refer only to the sample(s) tested unless otherwise stated. This test report cannot be reproduced, except in full, without prior written permission of the Company. This test report does not assure KOLAS accreditation.

Operating Mode: 8DPSK

Low channel

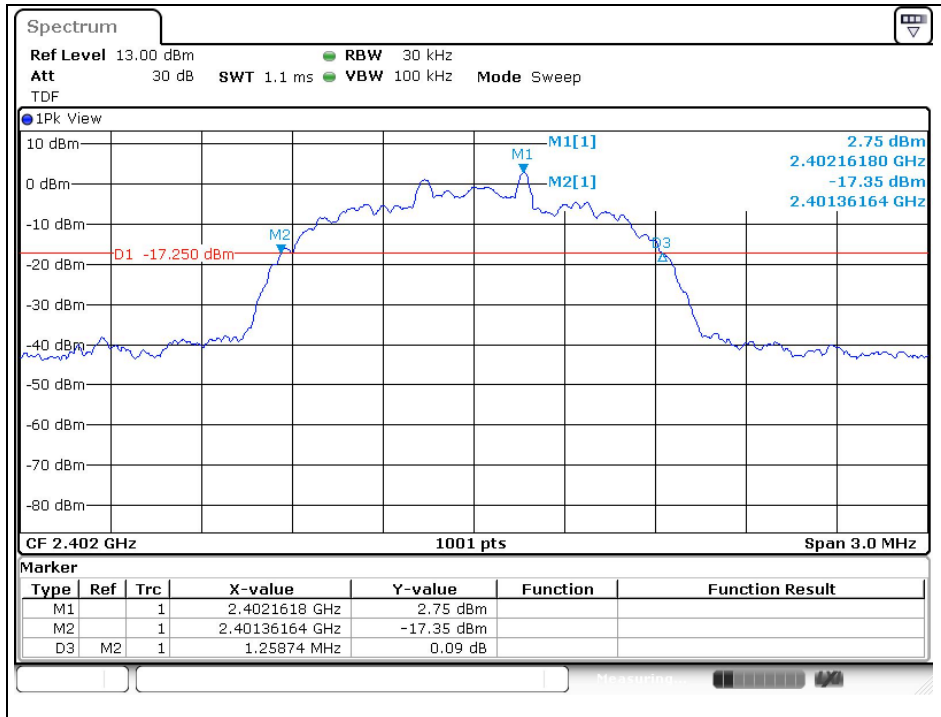

Middle channel

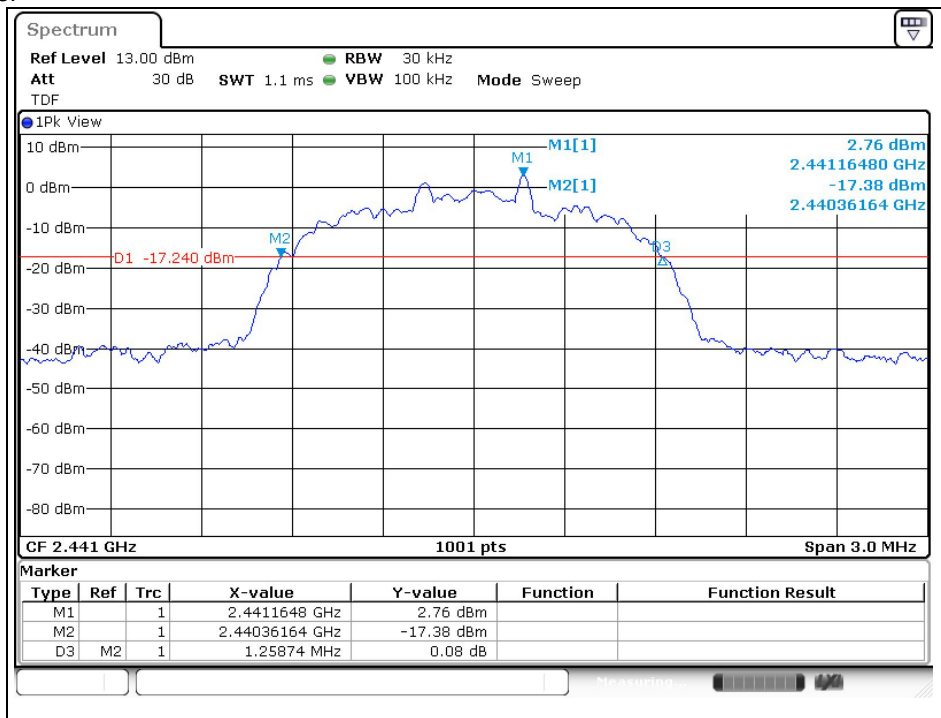

The results shown in this test report refer only to the sample(s) tested unless otherwise stated. This test report cannot be reproduced, except in full, without prior written permission of the Company. This test report does not assure KOLAS accreditation.

High channel

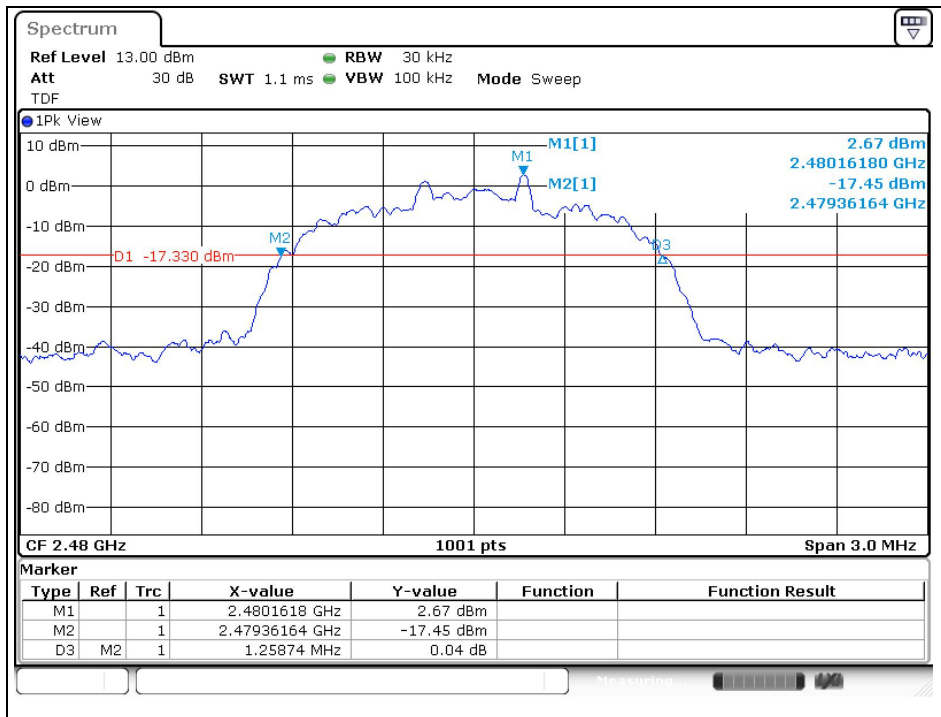

Test voltage: DC 24 V

Operating Mode: GFSK

Low channel

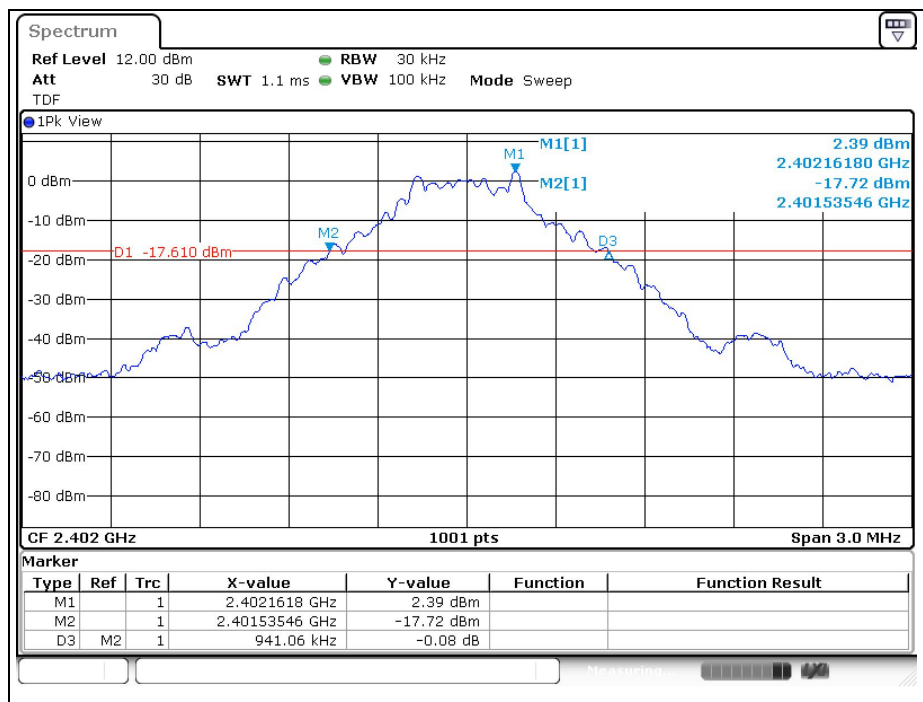

The results shown in this test report refer only to the sample(s) tested unless otherwise stated. This test report cannot be reproduced, except in full, without prior written permission of the Company. This test report does not assure KOLAS accreditation.

Middle channel

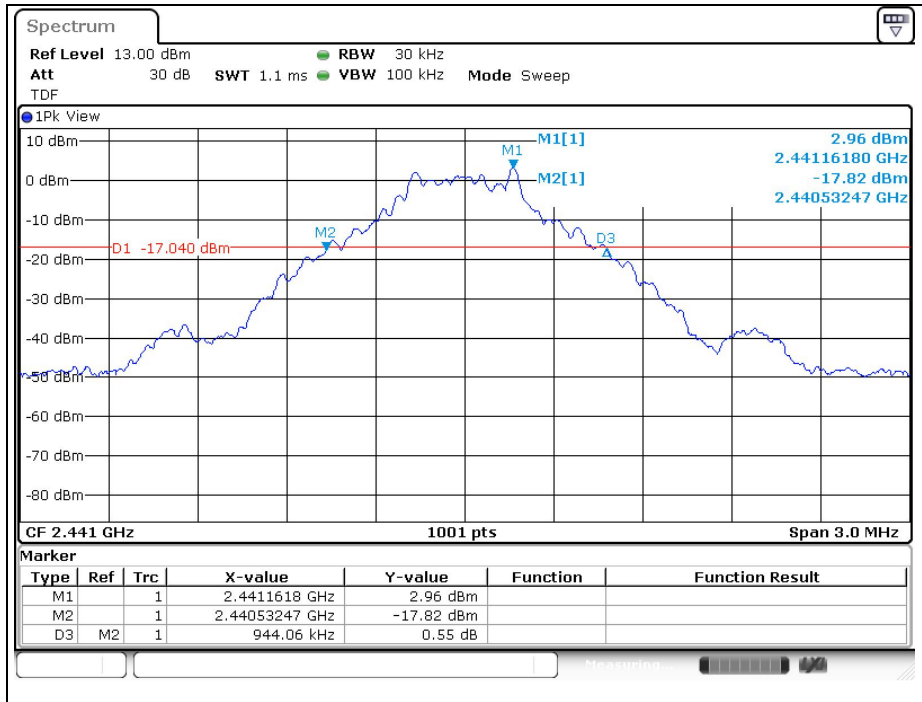

High channel

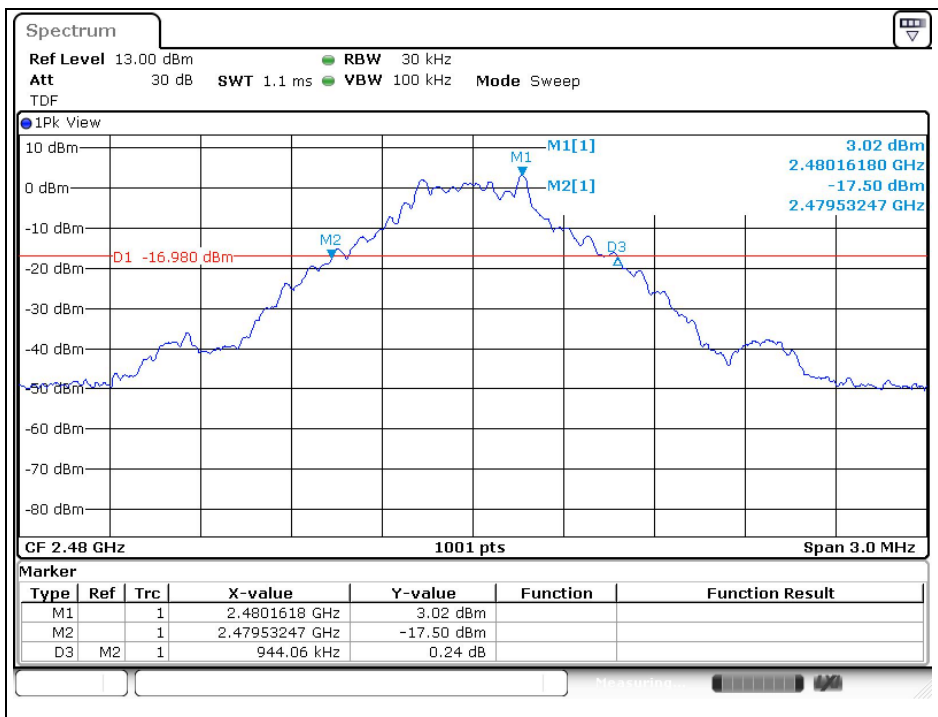

The results shown in this test report refer only to the sample(s) tested unless otherwise stated. This test report cannot be reproduced, except in full, without prior written permission of the Company. This test report does not assure KOLAS accreditation.

Operating Mode: $\pi/4$ DQPSK

Low channel

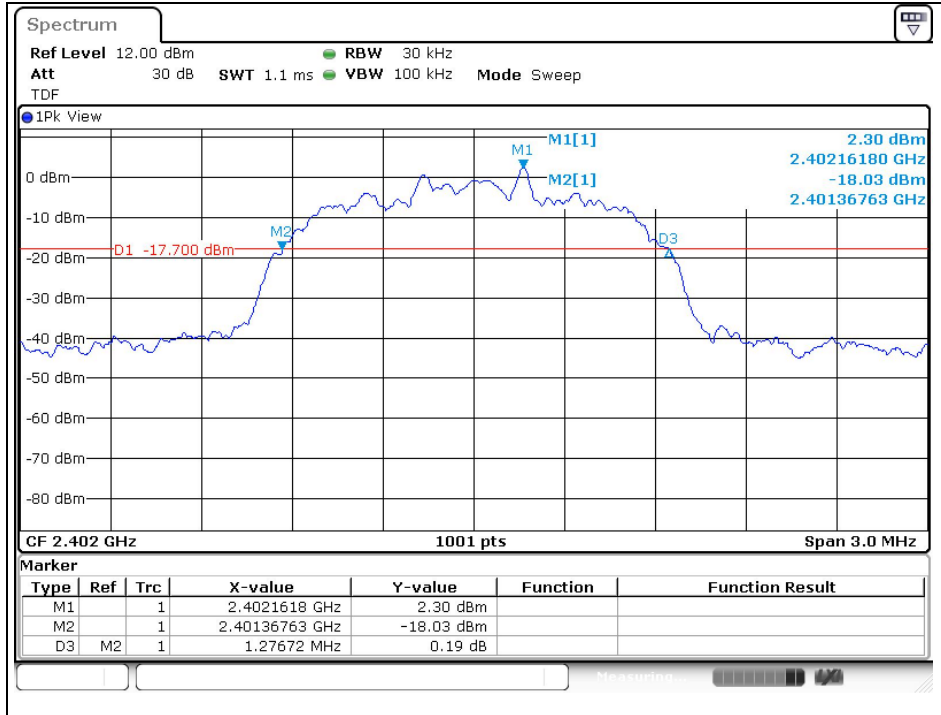

Middle channel

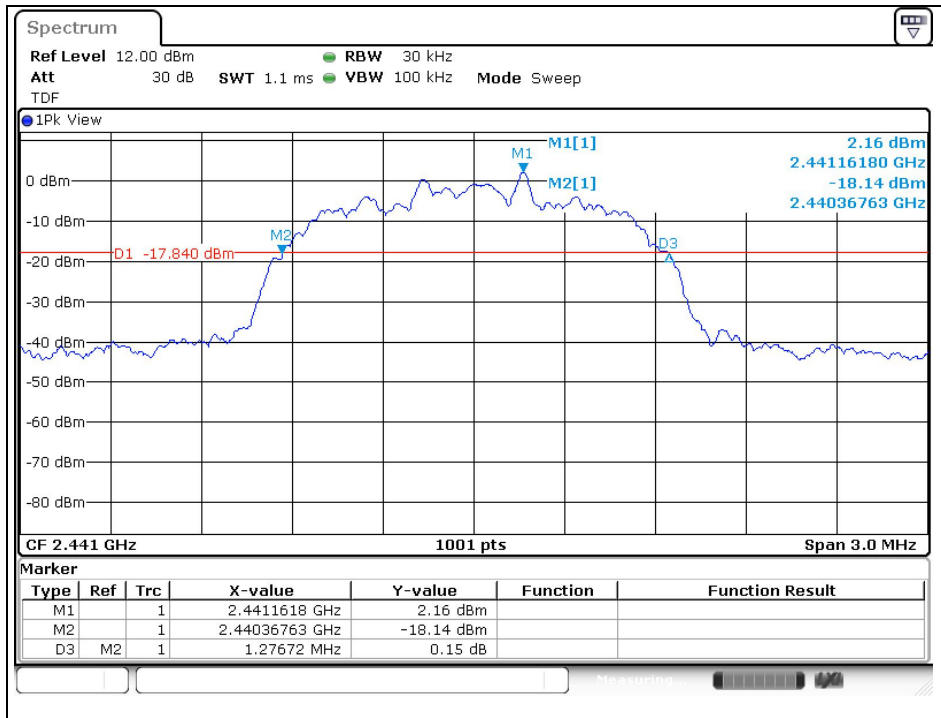

The results shown in this test report refer only to the sample(s) tested unless otherwise stated. This test report cannot be reproduced, except in full, without prior written permission of the Company. This test report does not assure KOLAS accreditation.

High channel

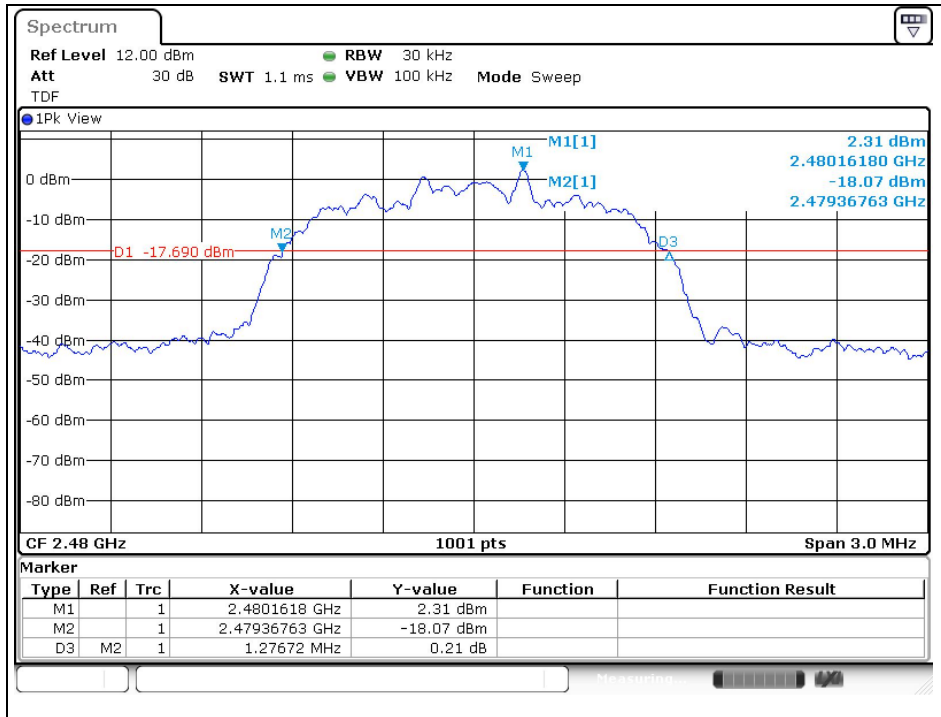

Operating Mode: 8DPSK

Low channel

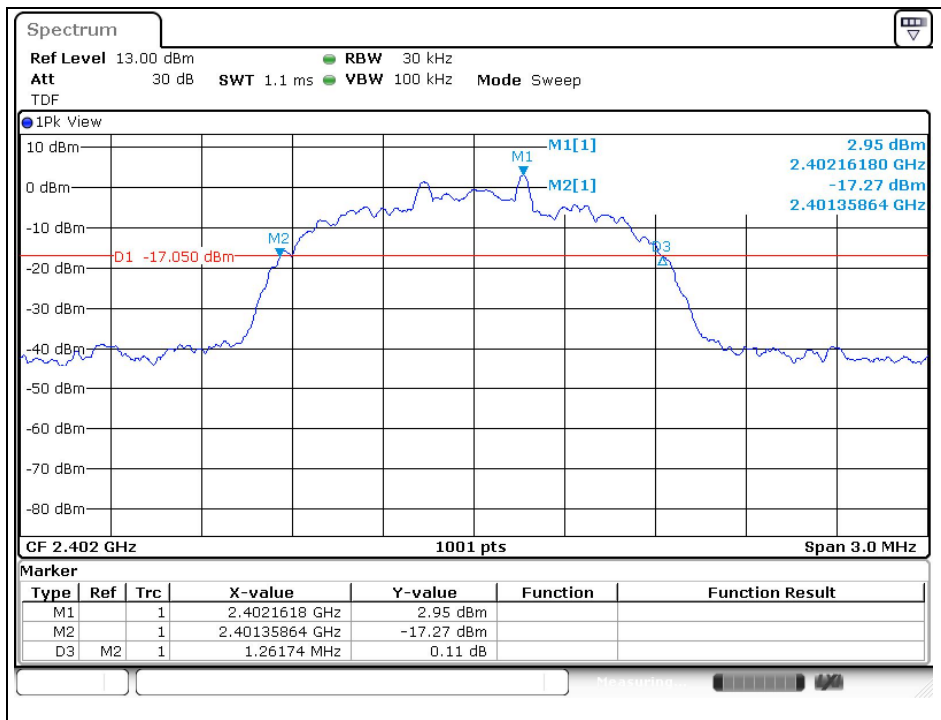

The results shown in this test report refer only to the sample(s) tested unless otherwise stated. This test report cannot be reproduced, except in full, without prior written permission of the Company. This test report does not assure KOLAS accreditation.

Middle channel

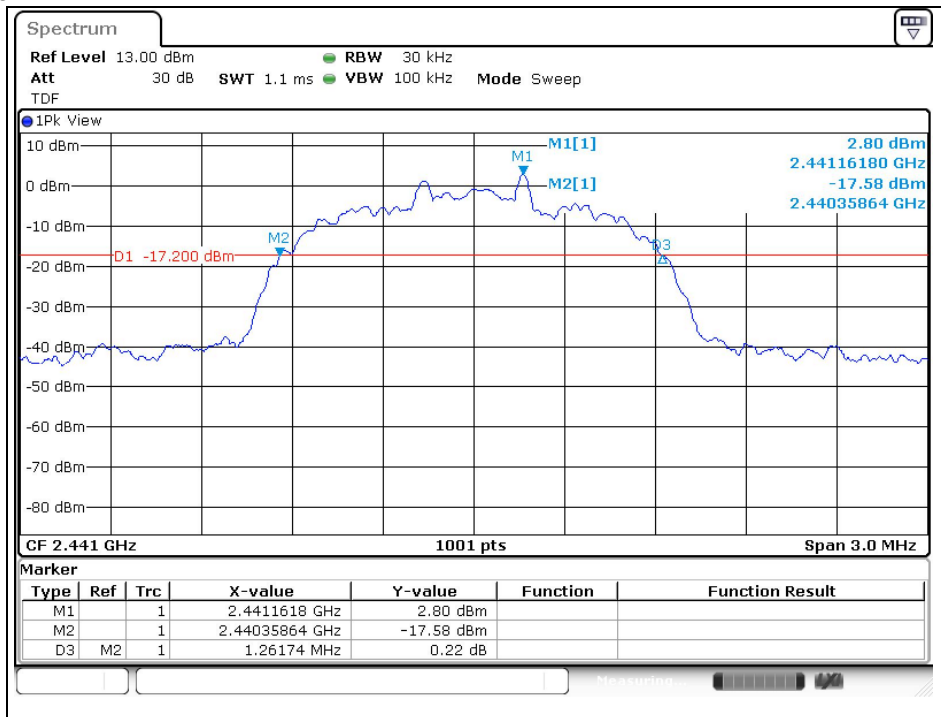

High channel

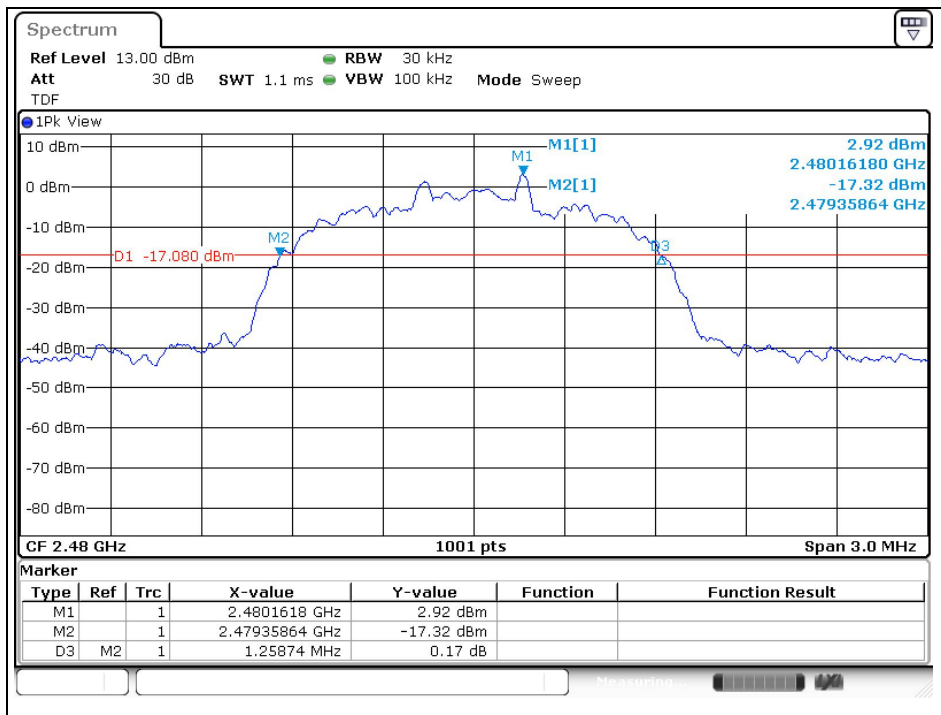

The results shown in this test report refer only to the sample(s) tested unless otherwise stated. This test report cannot be reproduced, except in full, without prior written permission of the Company. This test report does not assure KOLAS accreditation.

4. Maximum Peak Conducted Output Power

4.1. Test Setup

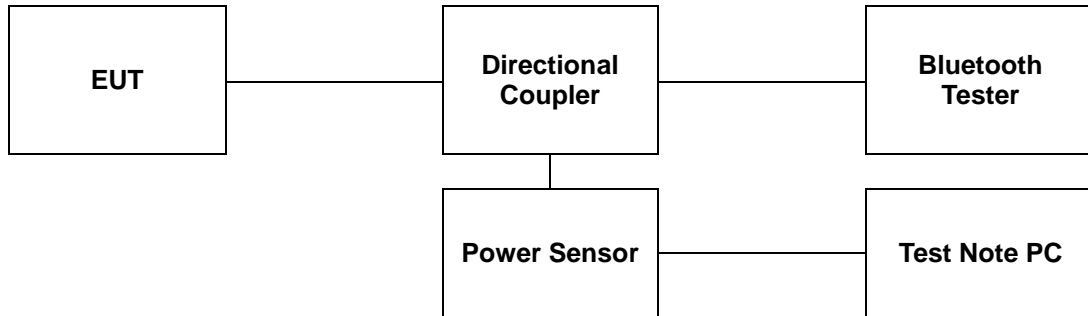

4.2. Limit

1. §15.247(a)(1), Frequency hopping systems shall have hopping channel carrier frequencies separated by a minimum of 25 kHz or the 20 dB bandwidth of the hopping channel, whichever is greater. Alternatively, frequency hopping systems operating in the 2 400-2 483.5 MHz band may have hopping channel carrier frequencies that are separated by 25 kHz or two-thirds of the 20 dB bandwidth of the hopping channel, whichever is greater, provided the systems operate with an output power no greater than 125 mW.
2. §15.247(b)(1), For frequency hopping systems operating in the 2 400-2 483.5 MHz band employing at least 75 non-overlapping hopping channels, and all frequency hopping systems in the 5 725-5 850 MHz band: 1 watt. For all other frequency hopping systems in the 2 400-2 483.5 MHz band: 0.125 watts.

4.3. Test Procedure

The test follows ANSI C63.10-2013. Using the power sensor instead of a spectrum analyzer.

1. Place the EUT on the table and set it in the transmitting mode.
2. Remove the antenna from the EUT and then connect a low loss RF cable from the antenna port to the Power sensor.
3. Test program: (S/W name: R&S Power Viewer, Version: 3.2.0)
4. Measure peak power each channel.

The results shown in this test report refer only to the sample(s) tested unless otherwise stated. This test report cannot be reproduced, except in full, without prior written permission of the Company. This test report does not assure KOLAS accreditation.

4.4. Test Results

Ambient temperature : (23 ± 1) °C
 Relative humidity : 47 % R.H.

Test voltage: DC 12 V

| Operation Mode | Data Rate (Mbps) | Channel | Frequency (MHz) | Average Power Result (dB m) | Peak Power Result (dB m) | Limit (dB m) |
|----------------|------------------|---------|-----------------|-----------------------------|--------------------------|--------------|
| GFSK | 1 | Low | 2 402 | 4.97 | 5.41 | 30 |
| | | Middle | 2 441 | <u>5.03</u> | <u>5.51</u> | |
| | | High | 2 480 | 4.85 | 5.39 | |
| π/4DQPSK | 2 | Low | 2 402 | 3.91 | 6.56 | 20.97 |
| | | Middle | 2 441 | <u>3.92</u> | <u>6.61</u> | |
| | | High | 2 480 | 3.78 | 6.57 | |
| 8DPSK | 3 | Low | 2 402 | 3.92 | 6.94 | |
| | | Middle | 2 441 | <u>3.99</u> | <u>6.98</u> | |
| | | High | 2 480 | 3.80 | 6.79 | |

The results shown in this test report refer only to the sample(s) tested unless otherwise stated. This test report cannot be reproduced, except in full, without prior written permission of the Company. This test report does not assure KOLAS accreditation.

Test voltage: DC 24 V

| Operation Mode | Data Rate (Mbps) | Channel | Frequency (MHz) | Average Power Result (dB m) | Peak Power Result (dB m) | Limit (dB m) |
|----------------|------------------|---------|-----------------|-----------------------------|--------------------------|--------------|
| GFSK | 1 | Low | 2 402 | 5.80 | 6.26 | 30 |
| | | Middle | 2 441 | 5.60 | 6.12 | |
| | | High | 2 480 | 5.83 | 6.40 | |
| π/4DQPSK | 2 | Low | 2 402 | 4.83 | 7.43 | 20.97 |
| | | Middle | 2 441 | 4.70 | 7.40 | |
| | | High | 2 480 | 5.24 | 7.98 | |
| 8DPSK | 3 | Low | 2 402 | 4.83 | 7.85 | |
| | | Middle | 2 441 | 4.69 | 7.78 | |
| | | High | 2 480 | 5.21 | 8.24 | |

Remark;

In the case of AFH, the limit for peak power is 0.125 W
 Directional coupler and cable offset compensate for test program (R&S Power Viewer) before measuring.

The results shown in this test report refer only to the sample(s) tested unless otherwise stated. This test report cannot be reproduced, except in full, without prior written permission of the Company. This test report does not assure KOLAS accreditation.

5. Carrier Frequency Separation

5.1. Test Setup

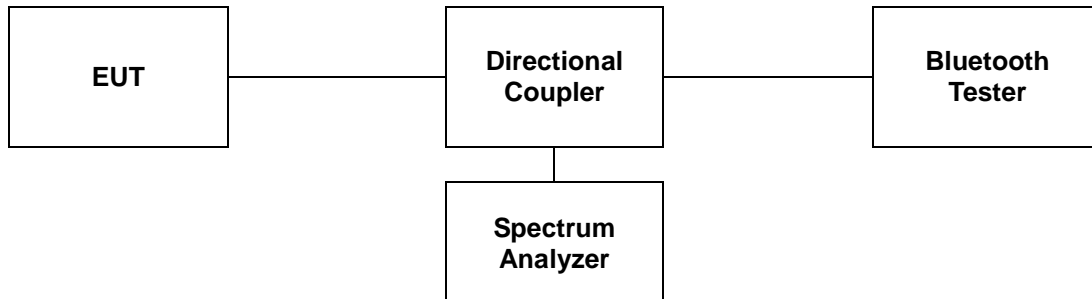

5.2. Limit

§15.247(a)(1), Frequency hopping systems shall have hopping channel carrier frequencies separated by a minimum of 25 kHz or the 20 dB bandwidth of the hopping channel, whichever is greater. Alternatively, frequency hopping systems operating in the 2 400-2 483.5 MHz band may have hopping channel carrier frequencies that are separated by 25 kHz or two-thirds of the 20 dB bandwidth of the hopping channel, whichever is greater, provided the systems operate with an output power no greater than 125 mW.

5.3. Test Procedure

The test follows ANSI C63.10-2013.

The device is operating in hopping mode between 79 channels and also supporting Adaptive Frequency Hopping with hopping between 20 channels. As compared with each operating mode, 79 channels are chosen as a representative for test.

Use the following spectrum analyzer settings:

Span = wide enough to capture the peaks of two adjacent channels

RBW = Start with the RBW set to approximately 30% of the channel spacing; adjust as necessary to best identify the center of each individual channel.

VBW \geq RBW

Sweep = auto

Detector = peak

Trace = max hold

Allow the trace to stabilize.

Use the marker-delta function to determine the between the peaks of the adjacent channels.

The results shown in this test report refer only to the sample(s) tested unless otherwise stated. This test report cannot be reproduced, except in full, without prior written permission of the Company. This test report does not assure KOLAS accreditation.

SGS Korea Co., Ltd. (Gunpo Laboratory) 4, LS-ro 182beon-gil, Gunpo-si, Gyeonggi-do, Korea, 15807 <http://www.sgsgroup.kr>

RTT5041-19(2017.07.10)(0)

Tel. +82 31 428 5700 / Fax. +82 31 427 2370

A4(210 mm x 297 mm)

5.4. Test Results

Ambient temperature : (23 ± 1) °C
 Relative humidity : 47 % R.H.

Test voltage: DC 12 V

| Operation Mode | Frequency (MHz) | Adjacent Hopping Channel Separation (kHz) | 20 dB Bandwidth (kHz) | Minimum Bandwidth (kHz) |
|----------------|-----------------|---|-----------------------|-------------------------|
| GFSK | 2 441 | 1 000 | 941 | 25 |

| Operation Mode | Frequency (MHz) | Adjacent Hopping Channel Separation (kHz) | Two-third of 20 dB Bandwidth (kHz) | Minimum Bandwidth (kHz) |
|----------------|-----------------|---|------------------------------------|-------------------------|
| 8DPSK | 2 441 | 1 000 | 839 | 25 |

Test voltage: DC 24 V

| Operation Mode | Frequency (MHz) | Adjacent Hopping Channel Separation (kHz) | 20 dB Bandwidth (kHz) | Minimum Bandwidth (kHz) |
|----------------|-----------------|---|-----------------------|-------------------------|
| GFSK | 2 441 | 1 000 | 944 | 25 |

| Operation Mode | Frequency (MHz) | Adjacent Hopping Channel Separation (kHz) | Two-third of 20 dB Bandwidth (kHz) | Minimum Bandwidth (kHz) |
|----------------|-----------------|---|------------------------------------|-------------------------|
| 8DPSK | 2 441 | 1 000 | 841 | 25 |

Remark;

Measurement is made with EUT operating in hopping mode between 79 channels providing a worst case scenario as compared to AFH mode hopping between 20 channels.

The results shown in this test report refer only to the sample(s) tested unless otherwise stated. This test report cannot be reproduced, except in full, without prior written permission of the Company. This test report does not assure KOLAS accreditation.

Test voltage: DC 12 V

Operating Mode: GFSK

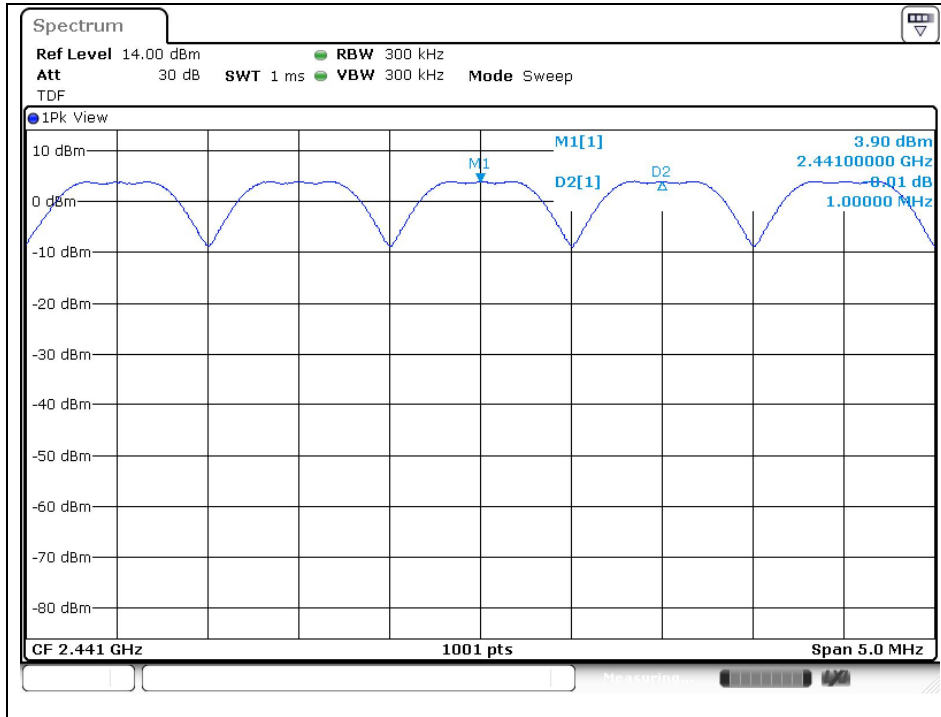

Operating Mode: 8DPSK

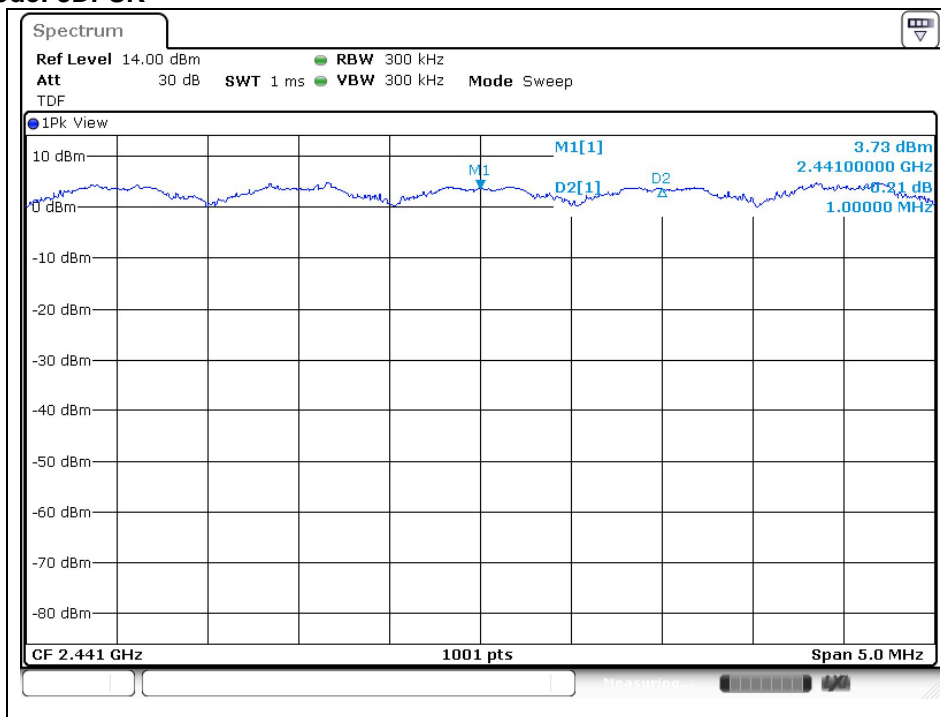

The results shown in this test report refer only to the sample(s) tested unless otherwise stated. This test report cannot be reproduced, except in full, without prior written permission of the Company. This test report does not assure KOLAS accreditation.

Test voltage: DC 24 V

Operating Mode: GFSK

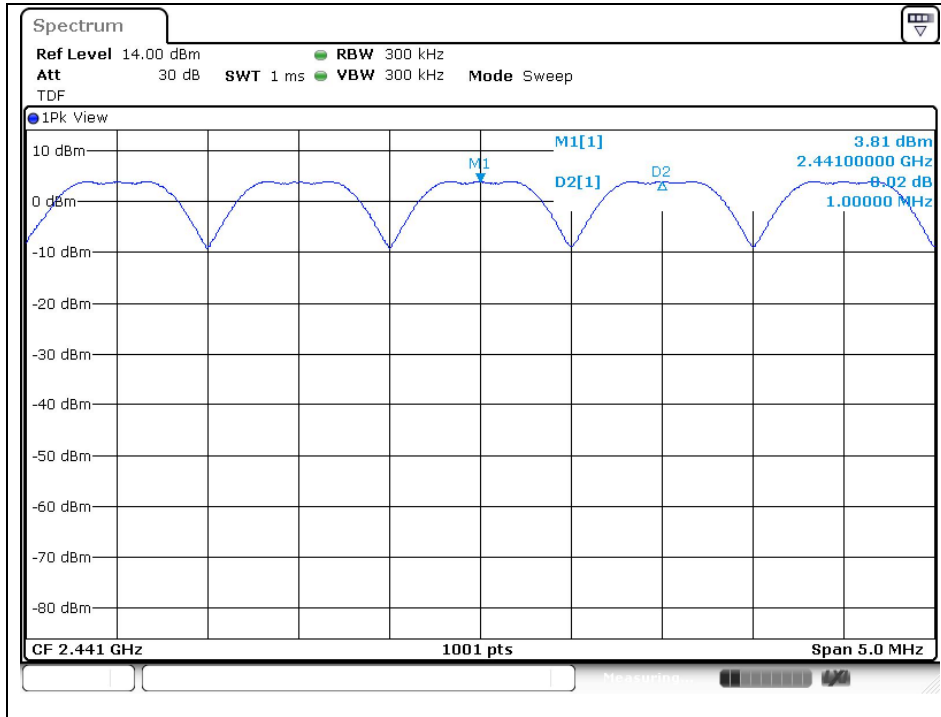

Operating Mode: 8DPSK

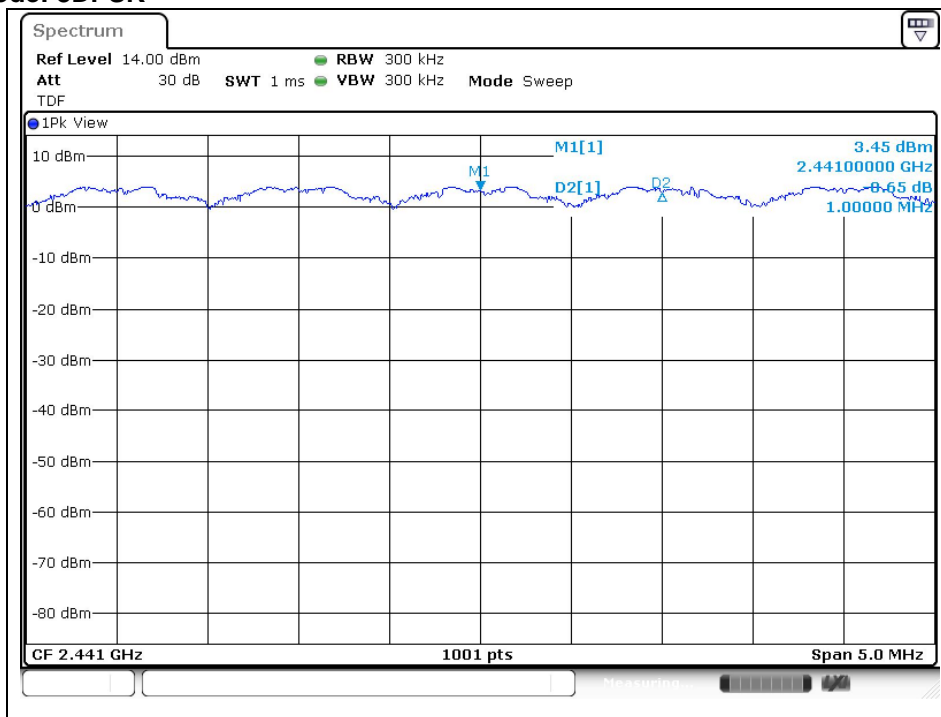

The results shown in this test report refer only to the sample(s) tested unless otherwise stated. This test report cannot be reproduced, except in full, without prior written permission of the Company. This test report does not assure KOLAS accreditation.

6. Number of Hopping Frequencies

6.1. Test Setup

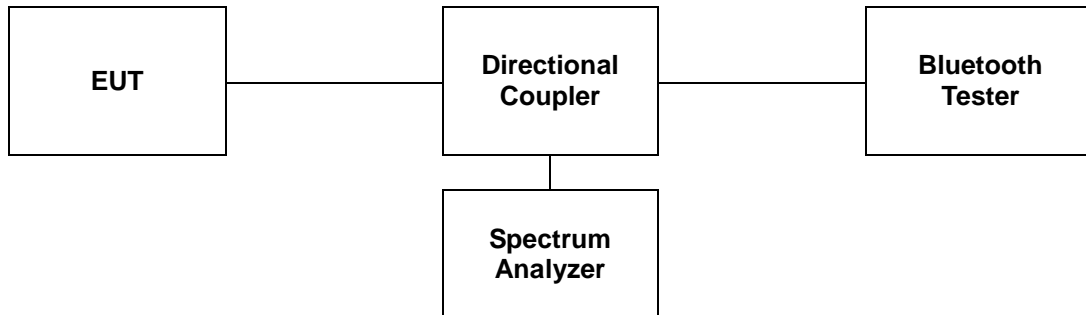

6.2. Limit

§15.247(a)(1)(iii), Frequency hopping systems in the 2 400-2 483.5 MHz band shall use at least 15 channels. The average time of occupancy on any channel shall not be greater than 0.4 seconds within a period of 0.4 seconds multiplied by the number of hopping channels employed. Frequency hopping systems may avoid or suppress transmissions on a particular hopping frequency provided that a minimum of 15 channels are used.

6.3. Test Procedure

The test follows ANSI C63.10-2013.

The device supports Adaptive Frequency Hopping and will use a minimum of 20 channels of the 79 available channels.

The EUT shall have its hopping function enabled. Use the following spectrum analyzer settings:

1. Span: The frequency band of operation. Depending on the number of channels the device supports, it may be necessary to divide the frequency range of operation across multiple spans, to allow the individual channels to be clearly seen.
2. RBW: To identify clearly the individual channels, set the RBW to less than 30 % of the channel spacing or the 20 dB bandwidth, whichever is smaller.
3. VBW \geq RBW
4. Sweep: Auto
5. Detector function: Peak
6. Trace: Max hold
7. Allow the trace to stabilize.

The results shown in this test report refer only to the sample(s) tested unless otherwise stated. This test report cannot be reproduced, except in full, without prior written permission of the Company. This test report does not assure KOLAS accreditation.

SGS Korea Co., Ltd. (Gunpo Laboratory) 4, LS-ro 182beon-gil, Gunpo-si, Gyeonggi-do, Korea, 15807 <http://www.sgsgroup.kr>

RTT5041-19(2017.07.10)(0)

Tel. +82 31 428 5700 / Fax. +82 31 427 2370

A4(210 mm x 297 mm)

6.4. Test Results

Ambient temperature : (23 ± 1) °C
 Relative humidity : 47 % R.H.

Test voltage: DC 12 V

| Operation Mode | Number of Hopping Frequency | Limit |
|----------------|-----------------------------|-------|
| GFSK | 79 | ≥ 15 |
| 8DPSK | 79 | ≥ 15 |

Test voltage: DC 24 V

| Operation Mode | Number of Hopping Frequency | Limit |
|----------------|-----------------------------|-------|
| GFSK | 79 | ≥ 15 |
| 8DPSK | 79 | ≥ 15 |

Remark;

Measurement is made with EUT operating in hopping mode between 79 channels providing a worst case scenario as compared to AFH mode hopping between 20 channels.

The results shown in this test report refer only to the sample(s) tested unless otherwise stated. This test report cannot be reproduced, except in full, without prior written permission of the Company. This test report does not assure KOLAS accreditation.

SGS Korea Co., Ltd. (Gunpo Laboratory) 4, LS-ro 182beon-gil, Gunpo-si, Gyeonggi-do, Korea, 15807 <http://www.sgsgroup.kr>

Test voltage: DC 12 V

Operating Mode: GFSK

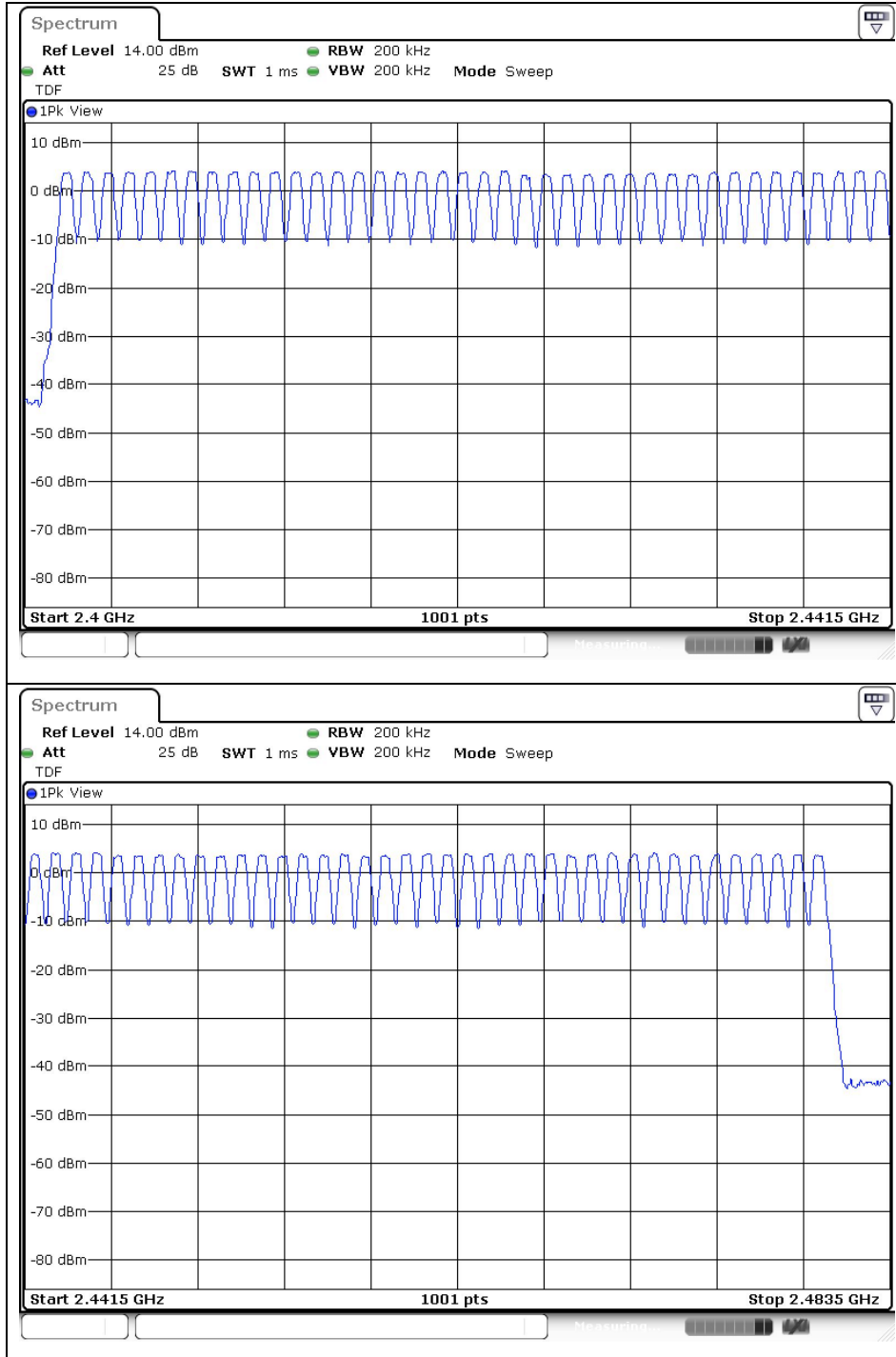

The results shown in this test report refer only to the sample(s) tested unless otherwise stated. This test report cannot be reproduced, except in full, without prior written permission of the Company. This test report does not assure KOLAS accreditation.

Operating Mode: 8DPSK

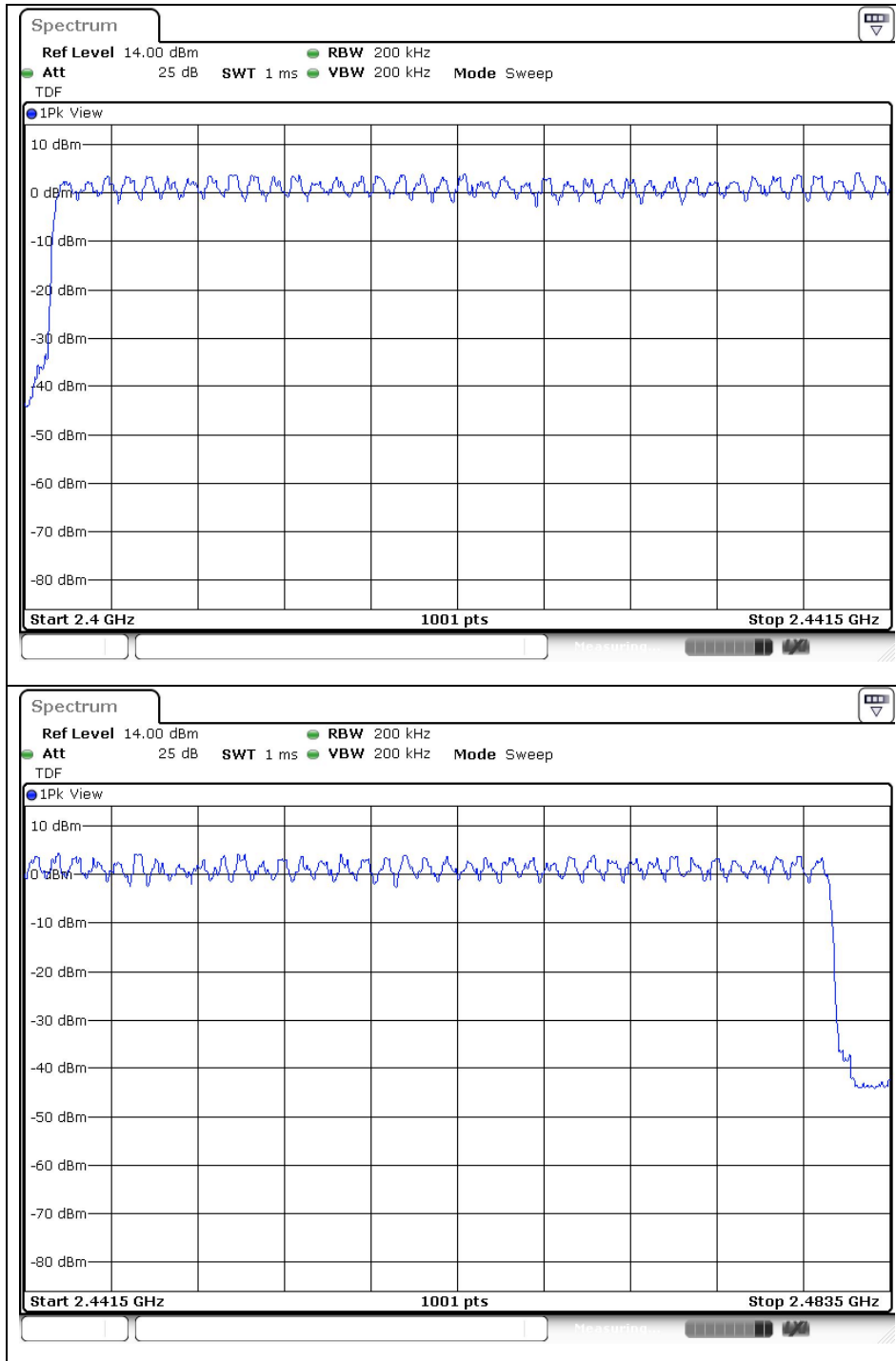

The results shown in this test report refer only to the sample(s) tested unless otherwise stated. This test report cannot be reproduced, except in full, without prior written permission of the Company. This test report does not assure KOLAS accreditation.

Test voltage: DC 24 V

Operating Mode: GFSK

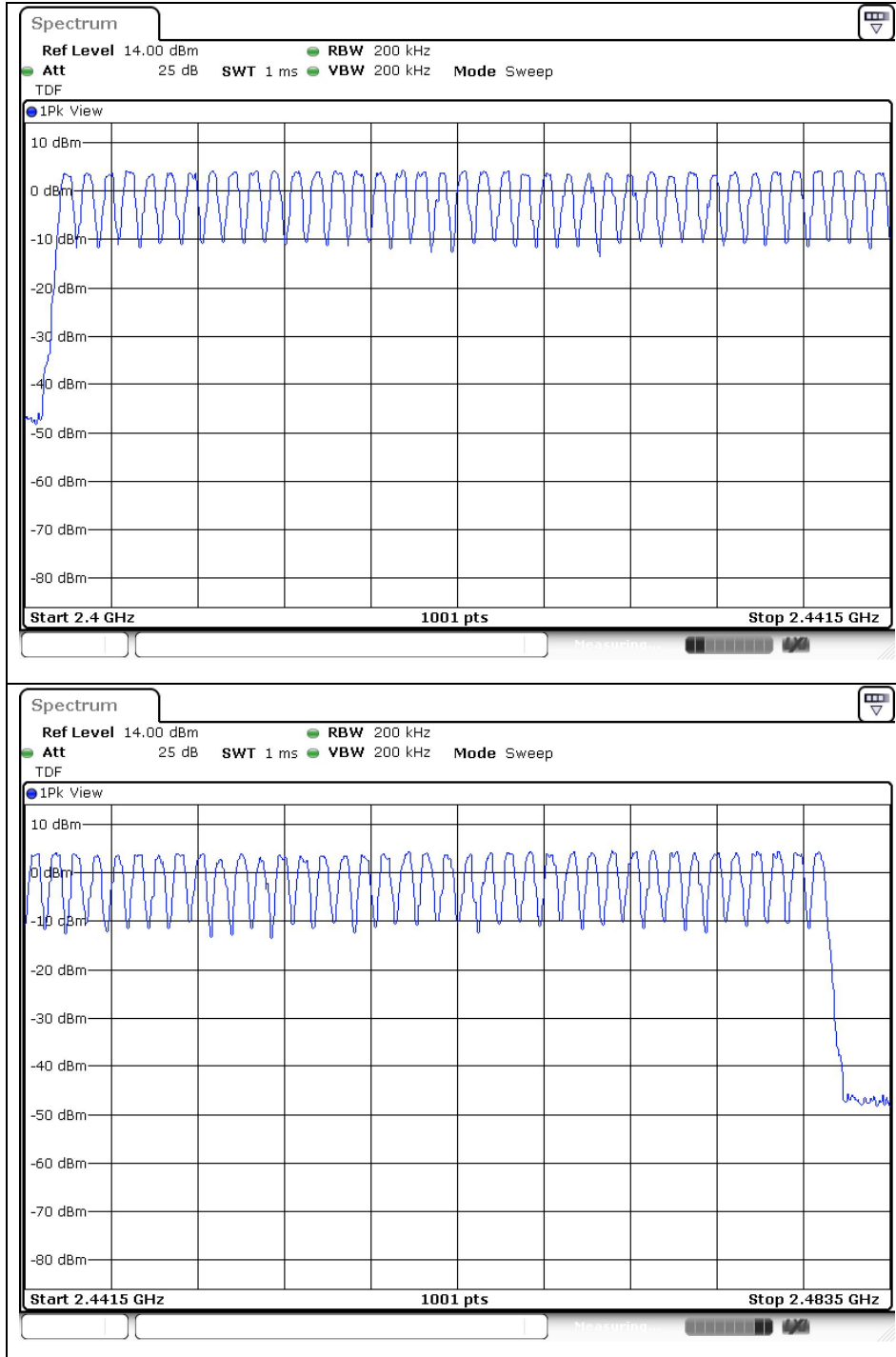

The results shown in this test report refer only to the sample(s) tested unless otherwise stated. This test report cannot be reproduced, except in full, without prior written permission of the Company. This test report does not assure KOLAS accreditation.

Operating Mode: 8DPSK

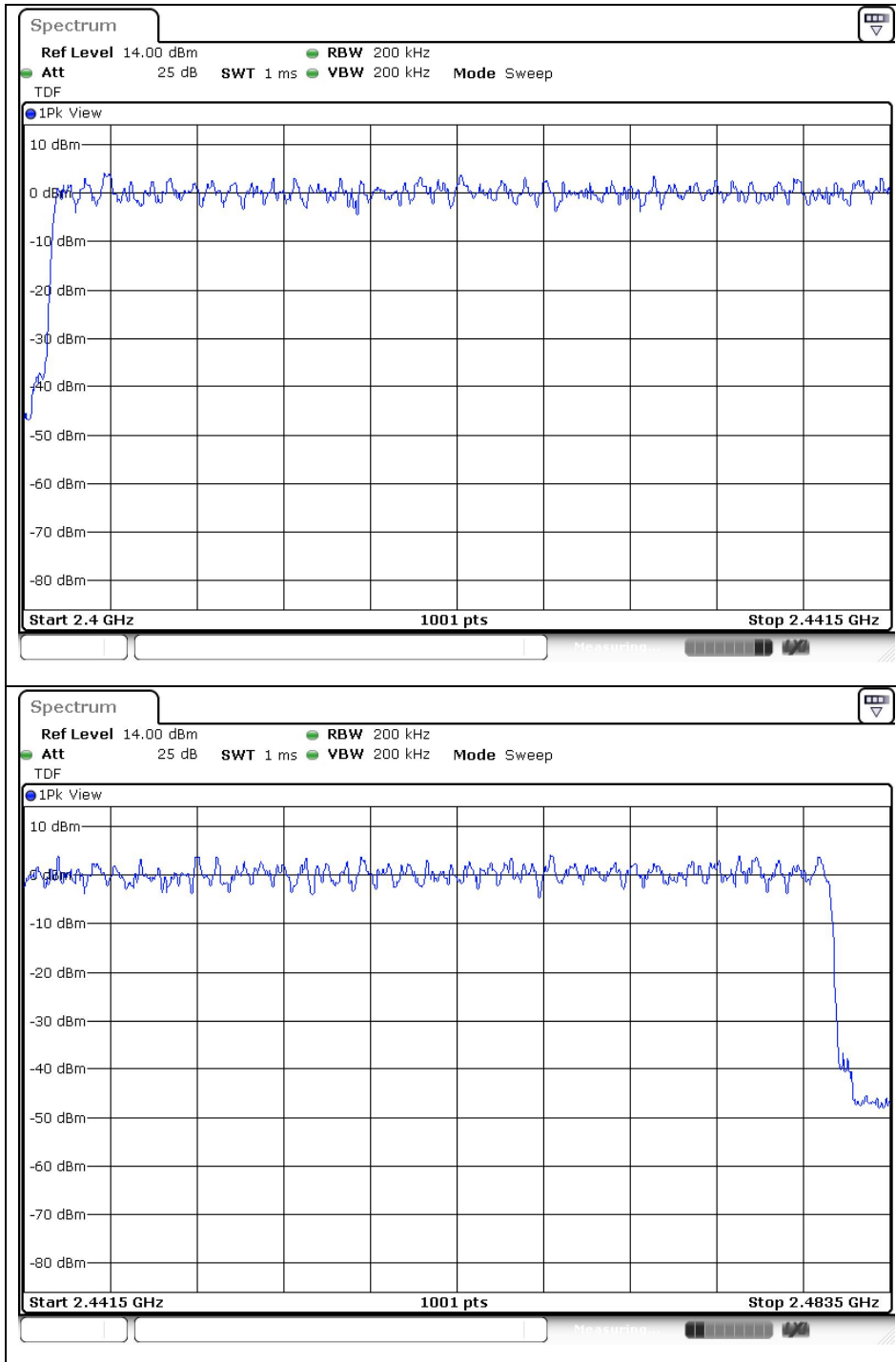

The results shown in this test report refer only to the sample(s) tested unless otherwise stated. This test report cannot be reproduced, except in full, without prior written permission of the Company. This test report does not assure KOLAS accreditation.

7. Time of Occupancy (Dwell Time)

7.1. Test Set up

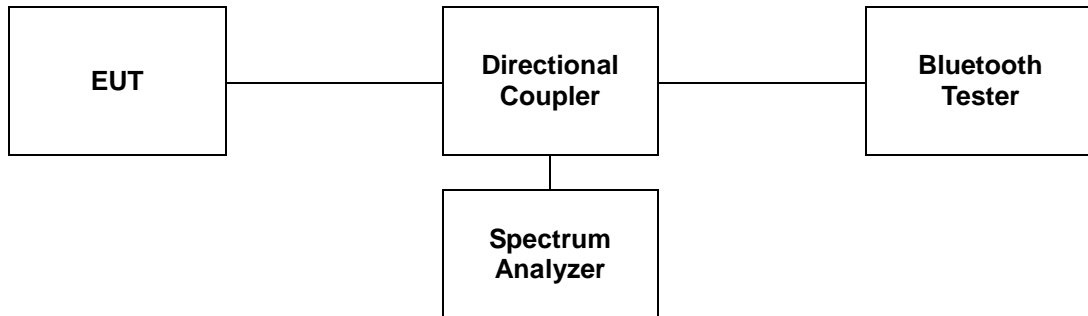

7.2. Limit

§15.247(a)(1)(iii), Frequency hopping systems in the 2 400-2 483.5 MHz band, the average time of occupancy on any frequency shall not be greater than 0.4 second within a 31.6 second period.

A period time = 0.4 (s) * 79 = 31.6 (s)

*Adaptive Frequency Hopping

A period time = 0.4 (s) * 20 = 8 (s)

The results shown in this test report refer only to the sample(s) tested unless otherwise stated. This test report cannot be reproduced, except in full, without prior written permission of the Company. This test report does not assure KOLAS accreditation.

SGS Korea Co., Ltd. (Gunpo Laboratory) 4, LS-ro 182beon-gil, Gunpo-si, Gyeonggi-do, Korea, 15807 <http://www.sgsgroup.kr>

RTT5041-19(2017.07.10)(0)

Tel. +82 31 428 5700 / Fax. +82 31 427 2370

A4(210 mm x 297 mm)

7.3. Test Procedure

All data rates and modes were investigated for this test. The full data for the worst case data rate are reported in this section. The test follows ANSI C63.10-2013.

1. Check the calibration of the measuring instrument using either an internal calibrator or a known signal from an external generator.
2. Position the EUT as shown in test setup without connection to measurement instrument. Turn on the EUT and connect its antenna terminal to measurement instrument via a low loss cable.
3. Measure the time duration of one transmission on the measured frequency. And then plot the result with time difference of this time duration.
4. The Bluetooth has 3 type of payload, DH1, DH3, DH5 and 3DH1, 3DH3, 3DH5. The hopping rate is insisted of 1 600 per second.

The EUT must have its hopping function enabled. Use the following spectrum analyzer setting:

Span = zero span, centered on a hopping channel

RBW = 1 MHz

VBW ≥ RBW

Sweep = as necessary to capture the entire dwell time per hopping channel

Detector = peak

Trace = max hold

Use the marker-delta function to determine the dwell time. If this value varies with different modes of operation, repeat this test for each variation.

The results shown in this test report refer only to the sample(s) tested unless otherwise stated. This test report cannot be reproduced, except in full, without prior written permission of the Company. This test report does not assure KOLAS accreditation.

SGS Korea Co., Ltd. (Gunpo Laboratory) 4, LS-ro 182beon-gil, Gunpo-si, Gyeonggi-do, Korea, 15807 <http://www.sgsgroup.kr>

RTT5041-19(2017.07.10)(0)

Tel. +82 31 428 5700 / Fax. +82 31 427 2370

A4(210 mm × 297 mm)

7.4. Test Results

Ambient temperature : (23 ± 1) °C
 Relative humidity : 47 % R.H.

7.4.1. Test voltage: DC 12 V

7.4.1.1. Packet Type: DH1, 3DH1

| Operation Mode | Frequency (MHz) | Dwell Time (ms) | Time of occupancy on the Tx Channel in 31.6 sec (ms) | Limit for time of occupancy on the Tx Channel in 31.6 sec (ms) |
|----------------|-----------------|-----------------|--|--|
| GFSK | 2 441 | 0.38 | 121.60 | 400 |
| 8DPSK | 2 441 | 0.40 | 128.00 | 400 |

Remark;

Time of occupancy on the TX channel in 31.6 sec

In case of GFSK: $0.38 \times \{(1\ 600 \div 2) / 79\} \times 31.6 = 121.60$ ms

In case of 8DPSK: $0.40 \times \{(1\ 600 \div 2) / 79\} \times 31.6 = 128.00$ ms

The results shown in this test report refer only to the sample(s) tested unless otherwise stated. This test report cannot be reproduced, except in full, without prior written permission of the Company. This test report does not assure KOLAS accreditation.

SGS Korea Co., Ltd. (Gunpo Laboratory) 4, LS-ro 182beon-gil, Gunpo-si, Gyeonggi-do, Korea, 15807 <http://www.sgsgroup.kr>

RTT5041-19(2017.07.10)(0)

Tel. +82 31 428 5700 / Fax. +82 31 427 2370

A4(210 mm x 297 mm)

Operating Mode: GFSK

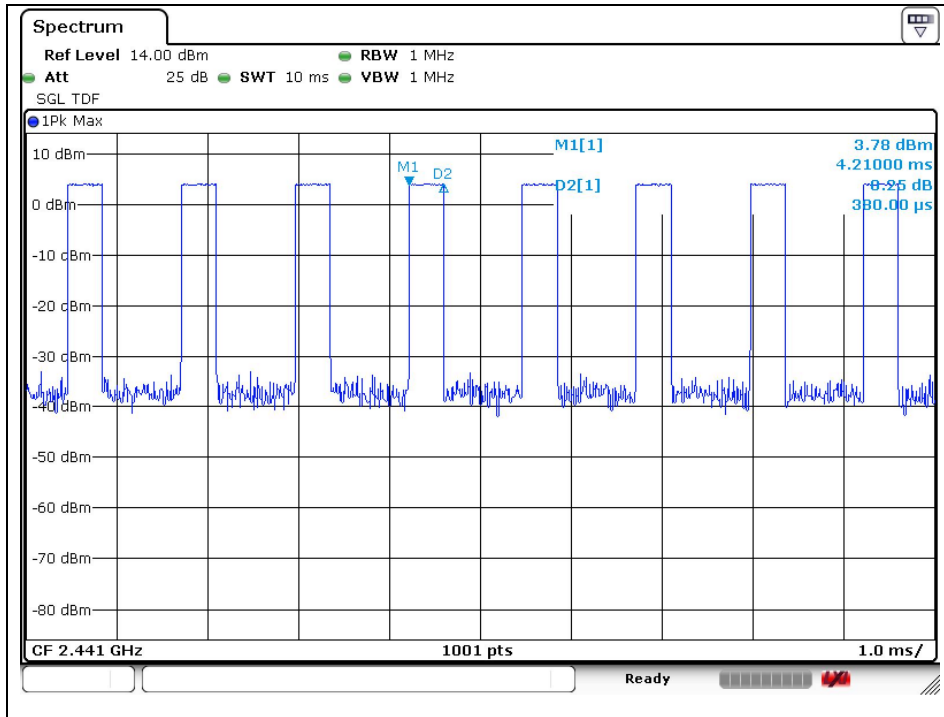

Operating Mode: 8DPSK

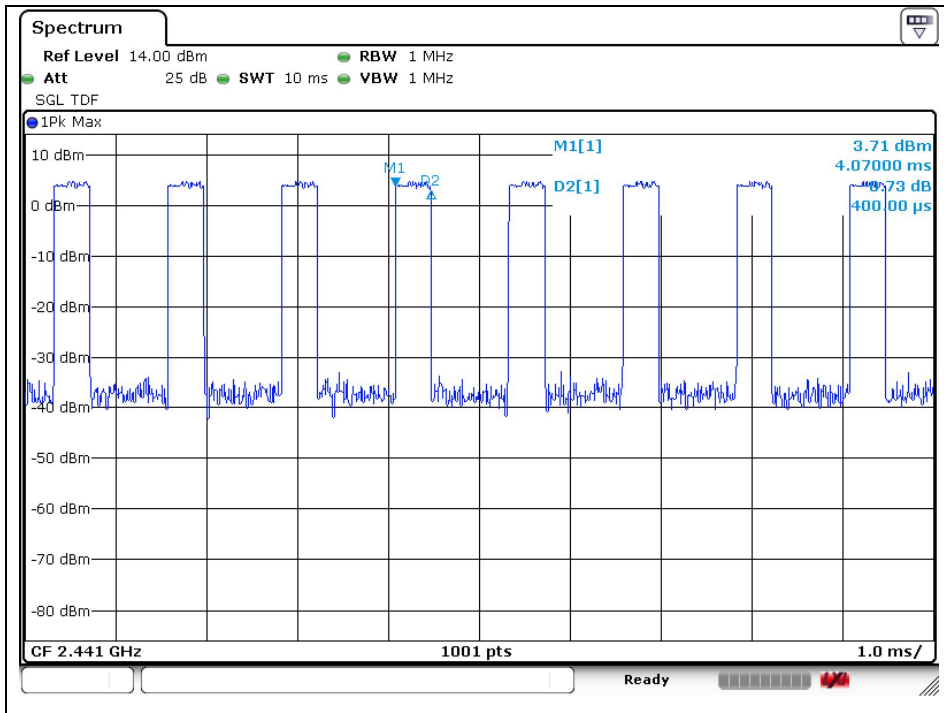

The results shown in this test report refer only to the sample(s) tested unless otherwise stated. This test report cannot be reproduced, except in full, without prior written permission of the Company. This test report does not assure KOLAS accreditation.

7.4.1.2. Packet Type: DH3, 3DH3

| Operation Mode | Frequency (MHz) | Dwell Time (ms) | Time of occupancy on the Tx Channel in 31.6 sec (ms) | Limit for time of occupancy on the Tx Channel in 31.6 sec (ms) |
|----------------|-----------------|-----------------|--|--|
| GFSK | 2 441 | 1.64 | 262.40 | 400 |
| 8DPSK | 2 441 | 1.65 | 264.00 | 400 |

Remark;

Time of occupancy on the TX channel in 31.6 sec

In case of GFSK: $1.64 \times \{(1\ 600 \div 4) / 79\} \times 31.6 = 262.40$ ms

In case of 8DPSK: $1.65 \times \{(1\ 600 \div 4) / 79\} \times 31.6 = 264.00$ ms

The results shown in this test report refer only to the sample(s) tested unless otherwise stated. This test report cannot be reproduced, except in full, without prior written permission of the Company. This test report does not assure KOLAS accreditation.

SGS Korea Co., Ltd. (Gunpo Laboratory) 4, LS-ro 182beon-gil, Gunpo-si, Gyeonggi-do, Korea, 15807 <http://www.sgsgroup.kr>

RTT5041-19(2017.07.10)(0)

Tel. +82 31 428 5700 / Fax. +82 31 427 2370

A4(210 mm x 297 mm)

Operating Mode: GFSK

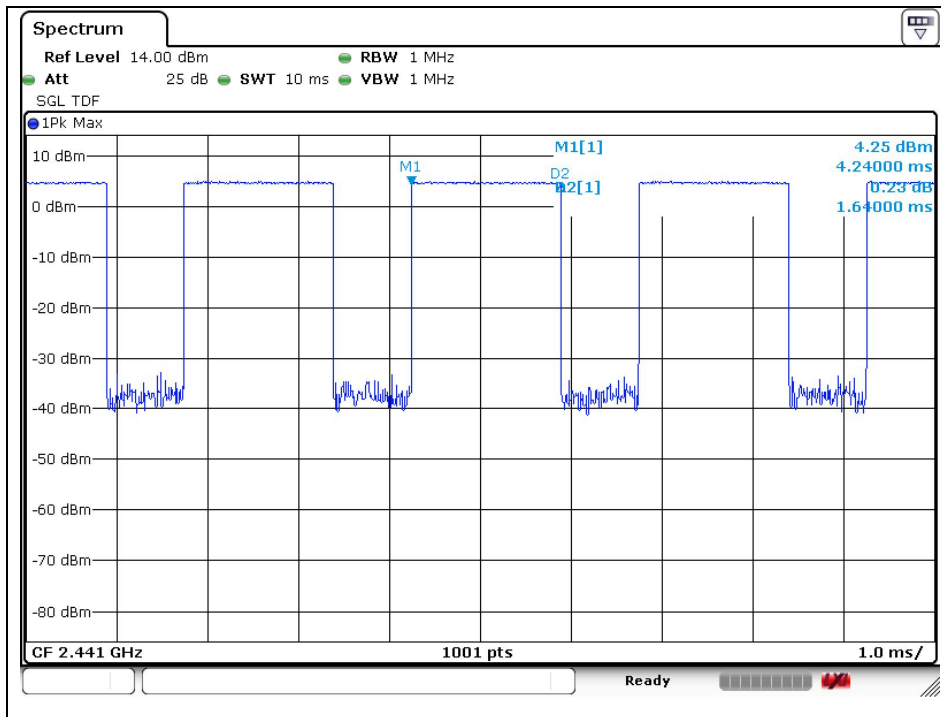

Operating Mode: 8DPSK

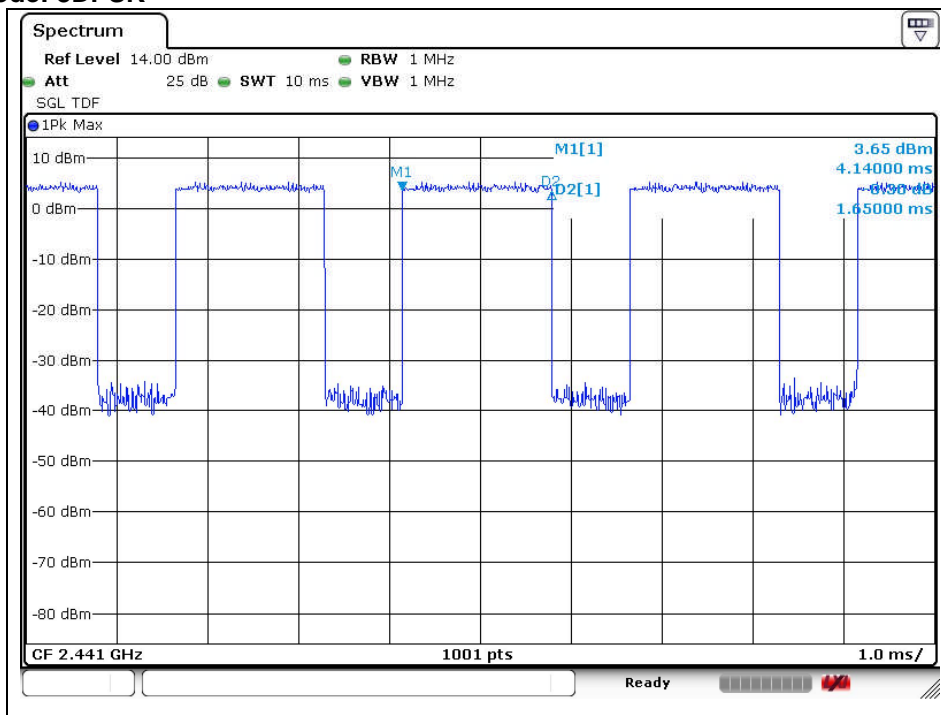

The results shown in this test report refer only to the sample(s) tested unless otherwise stated. This test report cannot be reproduced, except in full, without prior written permission of the Company. This test report does not assure KOLAS accreditation.

7.4.1.3. Packet Type: DH5, 3DH5

| Operation Mode | Frequency (MHz) | Dwell Time (ms) | Time of occupancy on the Tx Channel in 31.6 sec (ms) | Limit for time of occupancy on the Tx Channel in 31.6 sec (ms) |
|----------------|-----------------|-----------------|--|--|
| GFSK | 2 441 | 2.89 | 308.27 | 400 |
| 8DPSK | 2 441 | 2.89 | 308.27 | 400 |

Remark;

Time of occupancy on the TX channel in 31.6 sec

In case of GFSK and 8DPSK: $2.89 \times \{(1\ 600 \div 6) / 79\} \times 31.6 = 308.27$ ms

The results shown in this test report refer only to the sample(s) tested unless otherwise stated. This test report cannot be reproduced, except in full, without prior written permission of the Company. This test report does not assure KOLAS accreditation.

SGS Korea Co., Ltd. (Gunpo Laboratory) 4, LS-ro 182beon-gil, Gunpo-si, Gyeonggi-do, Korea, 15807 <http://www.sgsgroup.kr>

RTT5041-19(2017.07.10)(0)

Tel. +82 31 428 5700 / Fax. +82 31 427 2370

A4(210 mm x 297 mm)

Operating Mode: GFSK

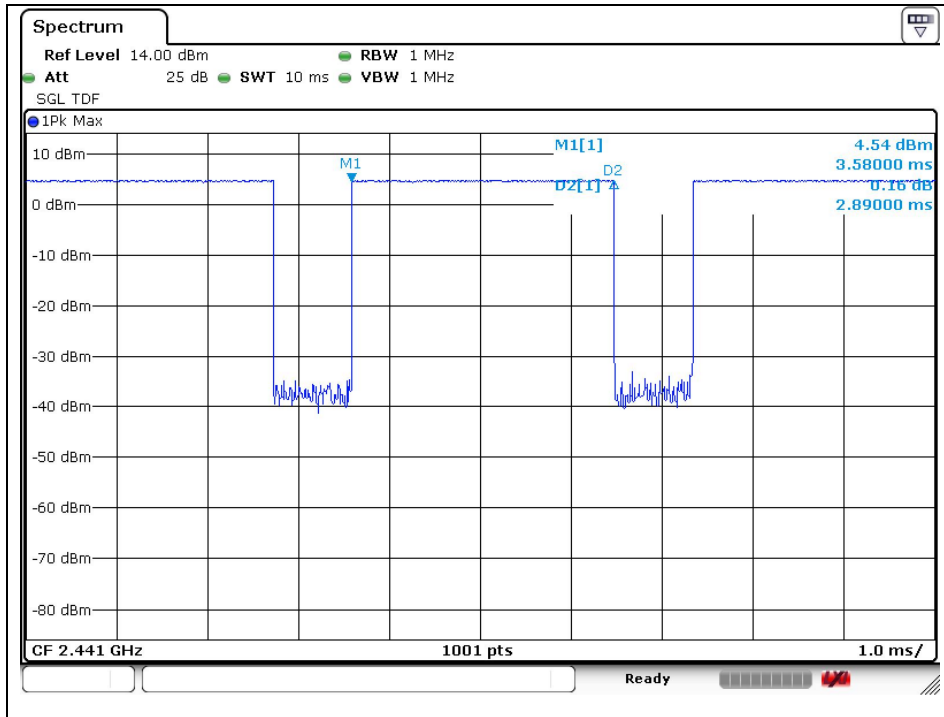

Operating Mode: 8DPSK

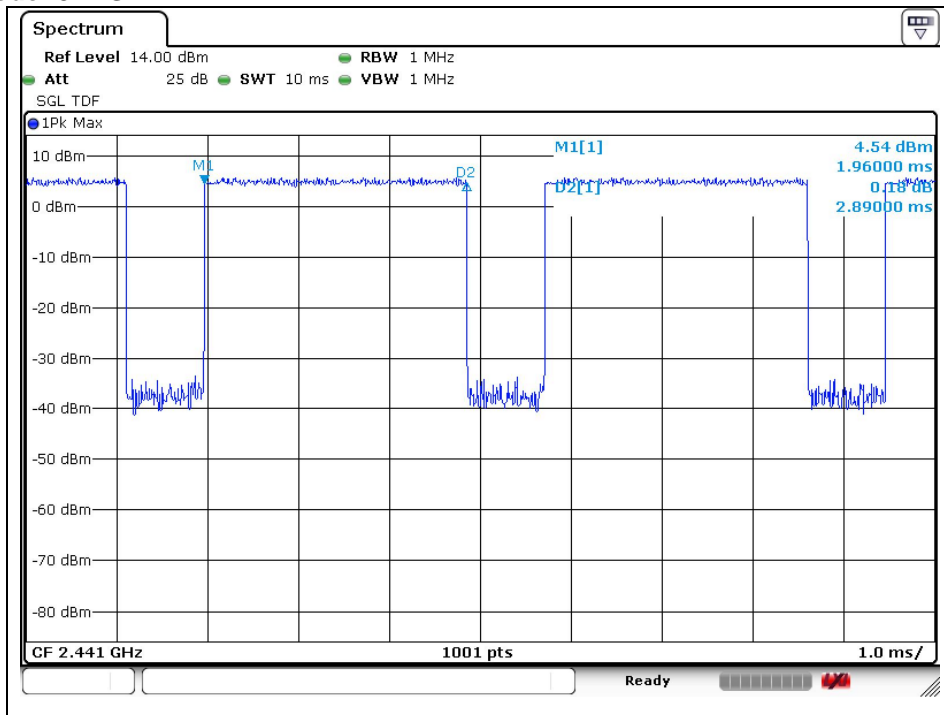

The results shown in this test report refer only to the sample(s) tested unless otherwise stated. This test report cannot be reproduced, except in full, without prior written permission of the Company. This test report does not assure KOLAS accreditation.

7.4.1.4. Packet Type: DH1, 3DH1 (Adaptive Frequency Hopping)

| Operation Mode | Frequency (MHz) | Dwell Time (ms) | Time of occupancy on the Tx Channel in 8 sec (ms) | Limit for time of occupancy on the Tx Channel in 8 sec (ms) |
|----------------|-----------------|-----------------|---|---|
| GFSK | 2 441 | 0.39 | 62.40 | 400 |
| 8DPSK | 2 441 | 0.39 | 62.40 | 400 |

Remark;

Time of occupancy on the TX channel in 8 sec

In case of GFSK and 8DPSK: $0.39 \times \{(800 \div 2) / 20\} \times 8 = 62.40$ ms

The results shown in this test report refer only to the sample(s) tested unless otherwise stated. This test report cannot be reproduced, except in full, without prior written permission of the Company. This test report does not assure KOLAS accreditation.

SGS Korea Co., Ltd. (Gunpo Laboratory) 4, LS-ro 182beon-gil, Gunpo-si, Gyeonggi-do, Korea, 15807 <http://www.sgsgroup.kr>

RTT5041-19(2017.07.10)(0)

Tel. +82 31 428 5700 / Fax. +82 31 427 2370

A4(210 mm x 297 mm)

Operating Mode: GFSK

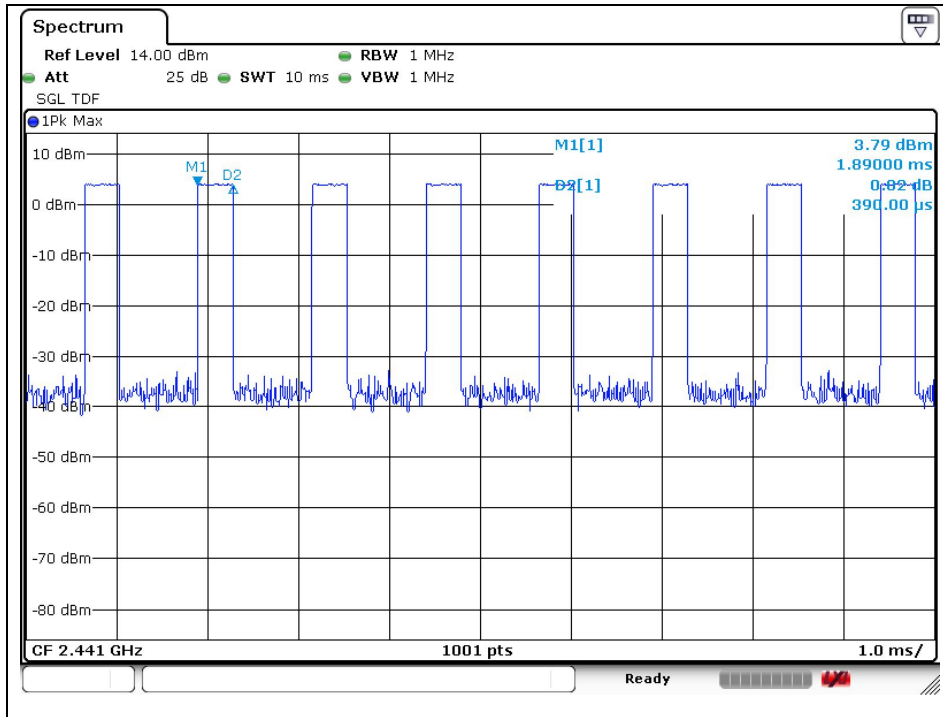

Operating Mode: 8DPSK

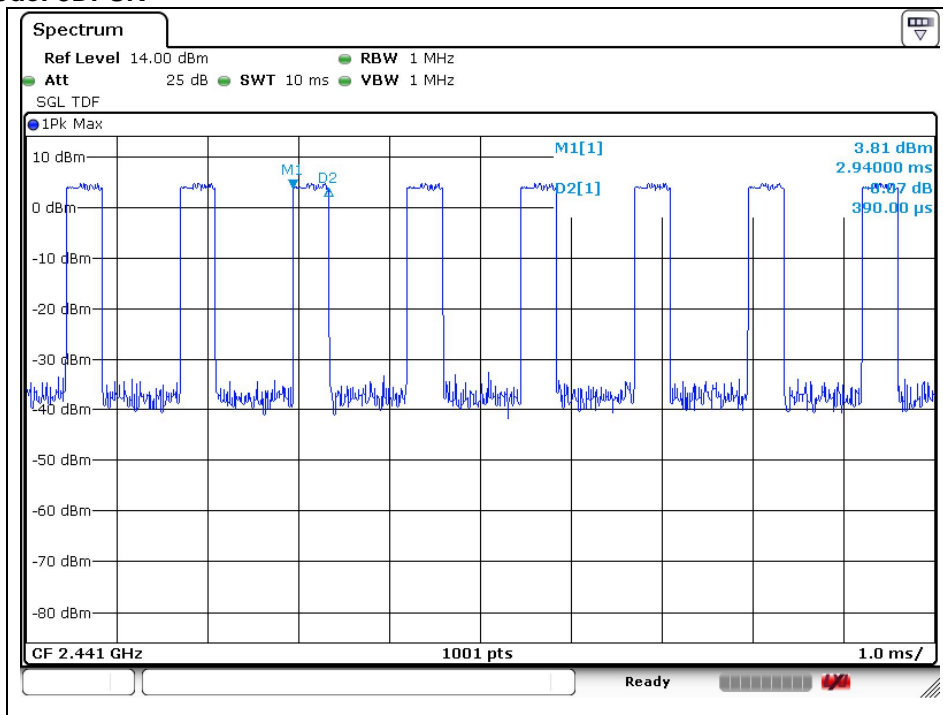

The results shown in this test report refer only to the sample(s) tested unless otherwise stated. This test report cannot be reproduced, except in full, without prior written permission of the Company. This test report does not assure KOLAS accreditation.

7.4.1.5. Packet Type: DH3, 3DH3 (Adaptive Frequency Hopping)

| Operation Mode | Frequency (MHz) | Dwell Time (ms) | Time of occupancy on the Tx Channel in 8 sec (ms) | Limit for time of occupancy on the Tx Channel in 8 sec (ms) |
|----------------|-----------------|-----------------|---|---|
| GFSK | 2 441 | 1.64 | 131.20 | 400 |
| 8DPSK | 2 441 | 1.64 | 131.20 | 400 |

Remark;

Time of occupancy on the TX channel in 8 sec

In case of GFSK and 8DPSK: $1.64 \times \{(800 \div 4) / 20\} \times 8 = 131.20$ ms

The results shown in this test report refer only to the sample(s) tested unless otherwise stated. This test report cannot be reproduced, except in full, without prior written permission of the Company. This test report does not assure KOLAS accreditation.

SGS Korea Co., Ltd. (Gunpo Laboratory) 4, LS-ro 182beon-gil, Gunpo-si, Gyeonggi-do, Korea, 15807 <http://www.sgsgroup.kr>

RTT5041-19(2017.07.10)(0)

Tel. +82 31 428 5700 / Fax. +82 31 427 2370

A4(210 mm x 297 mm)

Operating Mode: GFSK

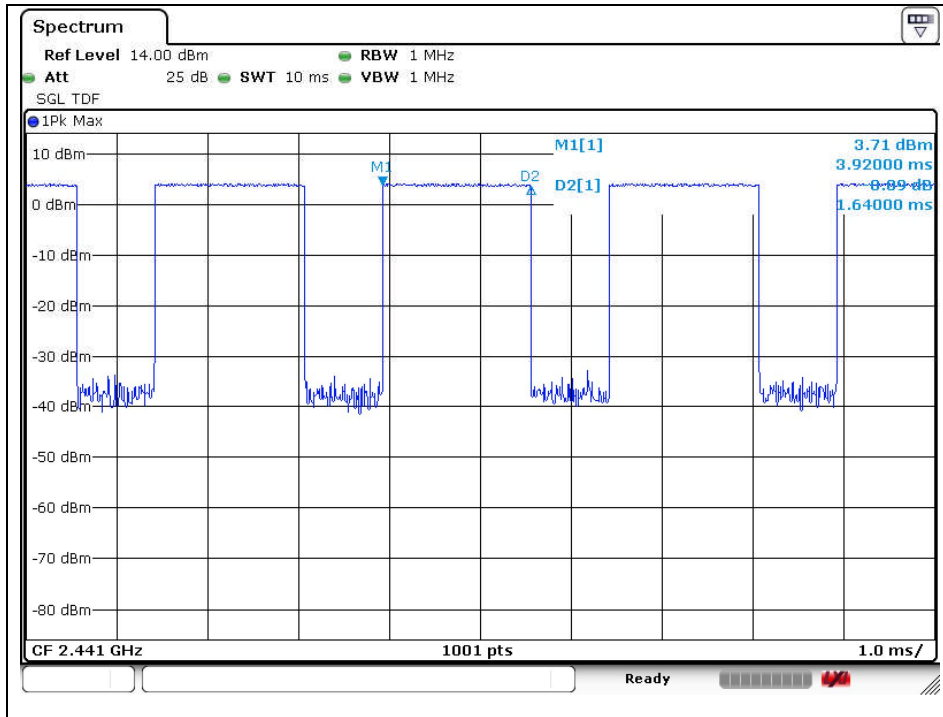

Operating Mode: 8DPSK

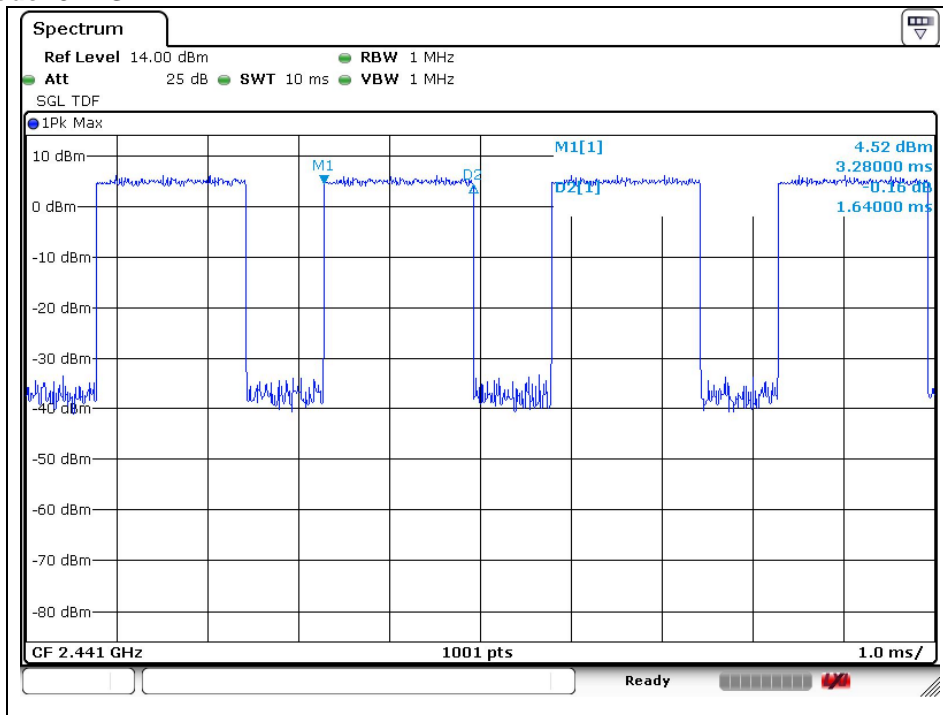

The results shown in this test report refer only to the sample(s) tested unless otherwise stated. This test report cannot be reproduced, except in full, without prior written permission of the Company. This test report does not assure KOLAS accreditation.

7.4.1.6. Packet Type: DH5, 3DH5 (Adaptive Frequency Hopping)

| Operation Mode | Frequency (MHz) | Dwell Time (ms) | Time of occupancy on the Tx Channel in 8 sec (ms) | Limit for time of occupancy on the Tx Channel in 8 sec (ms) |
|----------------|-----------------|-----------------|---|---|
| GFSK | 2 441 | 2.89 | 154.13 | 400 |
| 8DPSK | 2 441 | 2.90 | 154.67 | 400 |

Remark;

Time of occupancy on the TX channel in 8 sec

In case of GFSK: $2.89 \times \{(800 \div 6) / 20\} \times 8 = 154.13 \text{ ms}$

In case of 8DPSK: $2.90 \times \{(800 \div 6) / 20\} \times 8 = 154.67 \text{ ms}$

The results shown in this test report refer only to the sample(s) tested unless otherwise stated. This test report cannot be reproduced, except in full, without prior written permission of the Company. This test report does not assure KOLAS accreditation.

SGS Korea Co., Ltd. (Gunpo Laboratory) 4, LS-ro 182beon-gil, Gunpo-si, Gyeonggi-do, Korea, 15807 <http://www.sgsgroup.kr>

RTT5041-19(2017.07.10)(0)

Tel. +82 31 428 5700 / Fax. +82 31 427 2370

A4(210 mm x 297 mm)

Operating Mode: GFSK

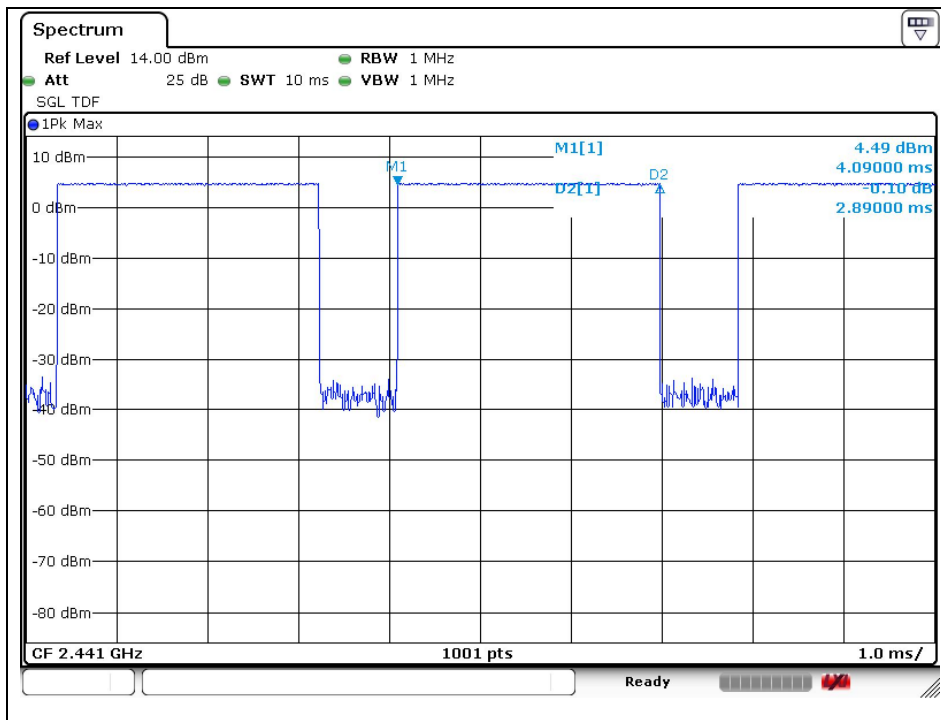

Operating Mode: 8DPSK

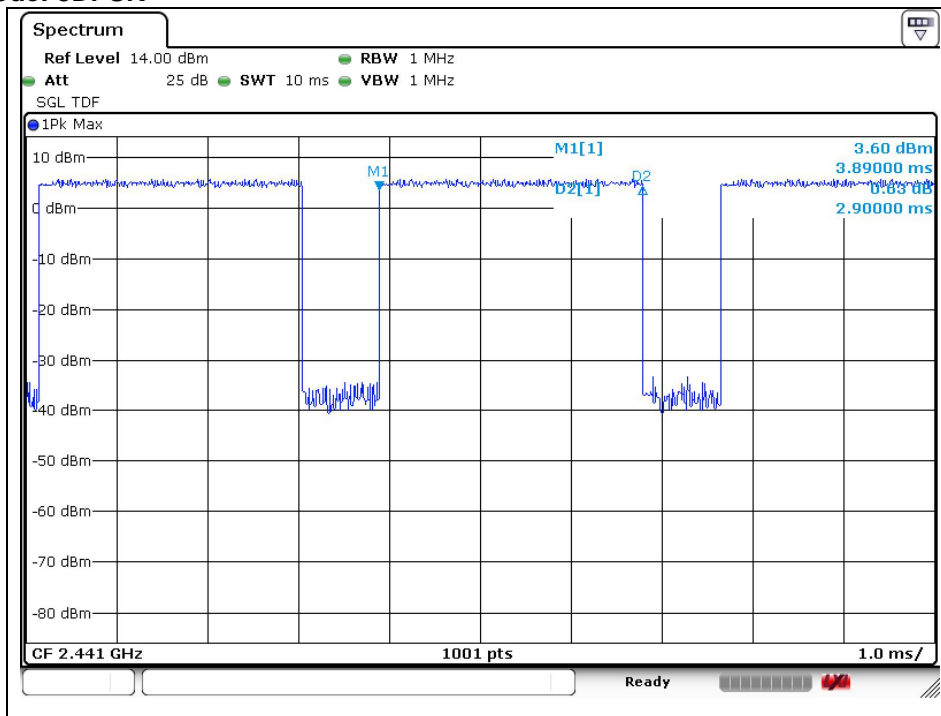

The results shown in this test report refer only to the sample(s) tested unless otherwise stated. This test report cannot be reproduced, except in full, without prior written permission of the Company. This test report does not assure KOLAS accreditation.

7.4.2. Test voltage: DC 24 V

7.4.2.1. Packet Type: DH1, 3DH1

| Operation Mode | Frequency (MHz) | Dwell Time (ms) | Time of occupancy on the Tx Channel in 31.6 sec (ms) | Limit for time of occupancy on the Tx Channel in 31.6 sec (ms) |
|----------------|-----------------|-----------------|--|--|
| GFSK | 2 441 | 0.38 | 121.60 | 400 |
| 8DPSK | 2 441 | 0.39 | 124.80 | 400 |

Remark;

Time of occupancy on the TX channel in 31.6 sec

In case of GFSK: $0.38 \times \{(1\ 600 \div 2) / 79\} \times 31.6 = 121.60$ ms

In case of 8DPSK: $0.39 \times \{(1\ 600 \div 2) / 79\} \times 31.6 = 124.80$ ms

The results shown in this test report refer only to the sample(s) tested unless otherwise stated. This test report cannot be reproduced, except in full, without prior written permission of the Company. This test report does not assure KOLAS accreditation.

SGS Korea Co., Ltd. (Gunpo Laboratory) 4, LS-ro 182beon-gil, Gunpo-si, Gyeonggi-do, Korea, 15807 <http://www.sgsgroup.kr>

RTT5041-19(2017.07.10)(0)

Tel. +82 31 428 5700 / Fax. +82 31 427 2370

A4(210 mm x 297 mm)

Operating Mode: GFSK

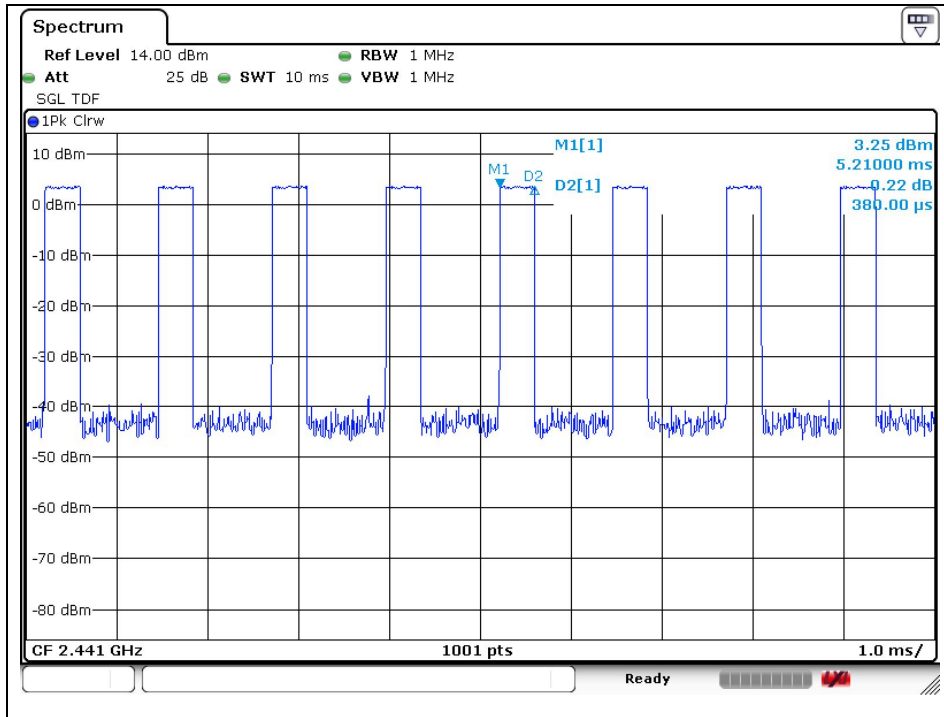

Operating Mode: 8DPSK

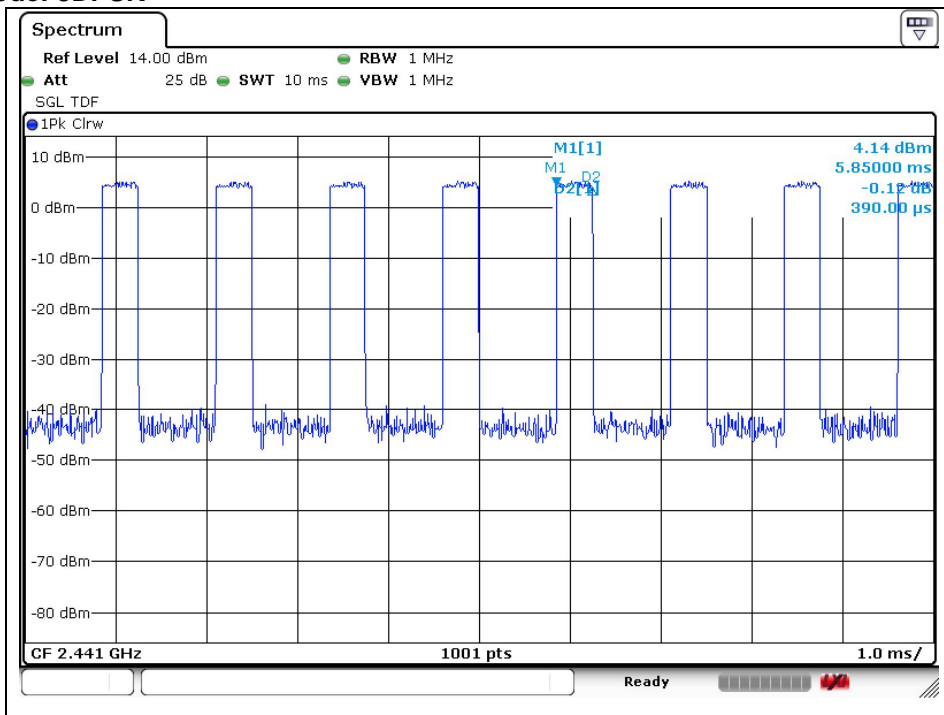

The results shown in this test report refer only to the sample(s) tested unless otherwise stated. This test report cannot be reproduced, except in full, without prior written permission of the Company. This test report does not assure KOLAS accreditation.

7.4.2.2. Packet Type: DH3, 3DH3

| Operation Mode | Frequency (MHz) | Dwell Time (ms) | Time of occupancy on the Tx Channel in 31.6 sec (ms) | Limit for time of occupancy on the Tx Channel in 31.6 sec (ms) |
|----------------|-----------------|-----------------|--|--|
| GFSK | 2 441 | 1.64 | 262.40 | 400 |
| 8DPSK | 2 441 | 1.65 | 264.00 | 400 |

Remark;

Time of occupancy on the TX channel in 31.6 sec

In case of GFSK: $1.64 \times \{(1\ 600 \div 4) / 79\} \times 31.6 = 262.40$ ms

In case of 8DPSK: $1.65 \times \{(1\ 600 \div 4) / 79\} \times 31.6 = 264.00$ ms

The results shown in this test report refer only to the sample(s) tested unless otherwise stated. This test report cannot be reproduced, except in full, without prior written permission of the Company. This test report does not assure KOLAS accreditation.

SGS Korea Co., Ltd. (Gunpo Laboratory) 4, LS-ro 182beon-gil, Gunpo-si, Gyeonggi-do, Korea, 15807 <http://www.sgsgroup.kr>

RTT5041-19(2017.07.10)(0)

Tel. +82 31 428 5700 / Fax. +82 31 427 2370

A4(210 mm x 297 mm)

Operating Mode: GFSK

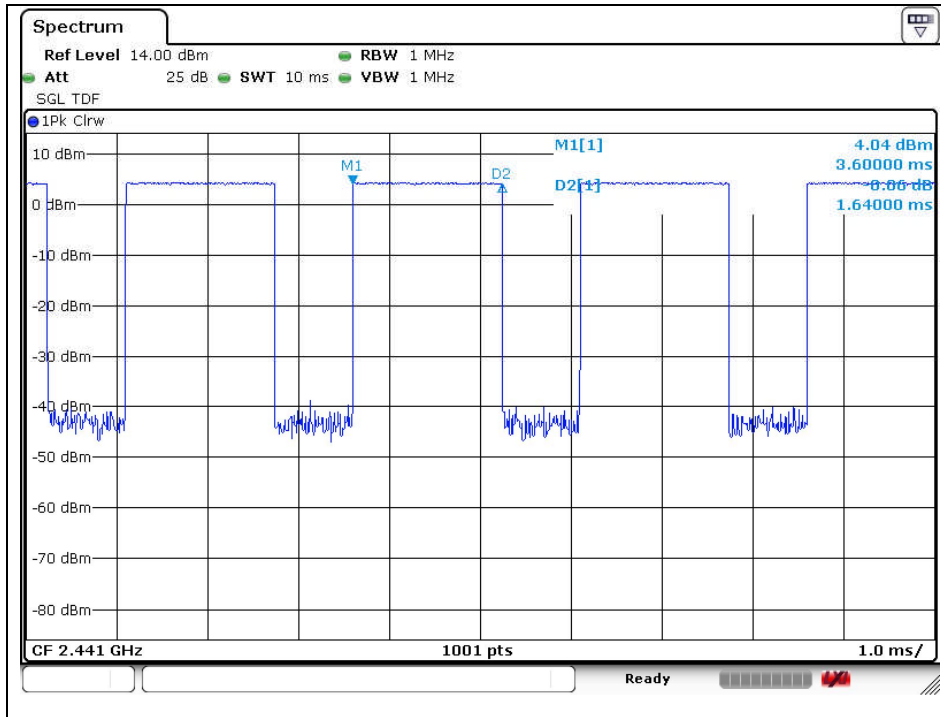

Operating Mode: 8DPSK

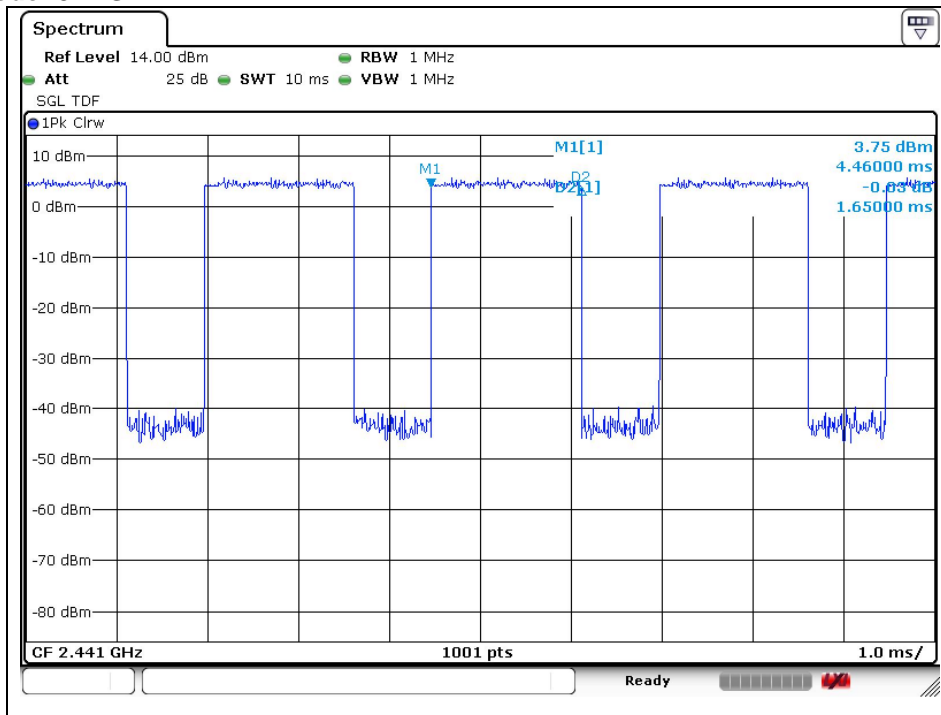

The results shown in this test report refer only to the sample(s) tested unless otherwise stated. This test report cannot be reproduced, except in full, without prior written permission of the Company. This test report does not assure KOLAS accreditation.

7.4.2.3. Packet Type: DH5, 3DH5

| Operation Mode | Frequency (MHz) | Dwell Time (ms) | Time of occupancy on the Tx Channel in 31.6 sec (ms) | Limit for time of occupancy on the Tx Channel in 31.6 sec (ms) |
|----------------|-----------------|-----------------|--|--|
| GFSK | 2 441 | 2.89 | 308.27 | 400 |
| 8DPSK | 2 441 | 2.89 | 308.27 | 400 |

Remark;

Time of occupancy on the TX channel in 31.6 sec

In case of GFSK and 8DPSK: $2.89 \times \{(1\ 600 \div 6) / 79\} \times 31.6 = 308.27$ ms

The results shown in this test report refer only to the sample(s) tested unless otherwise stated. This test report cannot be reproduced, except in full, without prior written permission of the Company. This test report does not assure KOLAS accreditation.

SGS Korea Co., Ltd. (Gunpo Laboratory) 4, LS-ro 182beon-gil, Gunpo-si, Gyeonggi-do, Korea, 15807 <http://www.sgsgroup.kr>

RTT5041-19(2017.07.10)(0)

Tel. +82 31 428 5700 / Fax. +82 31 427 2370

A4(210 mm x 297 mm)

Operating Mode: GFSK

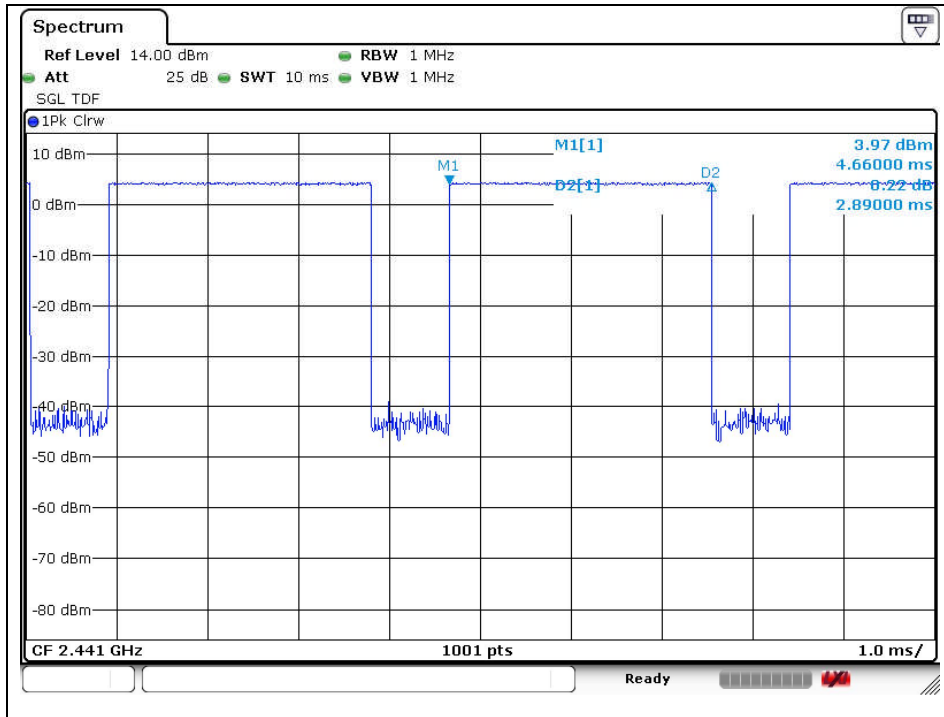

Operating Mode: 8DPSK

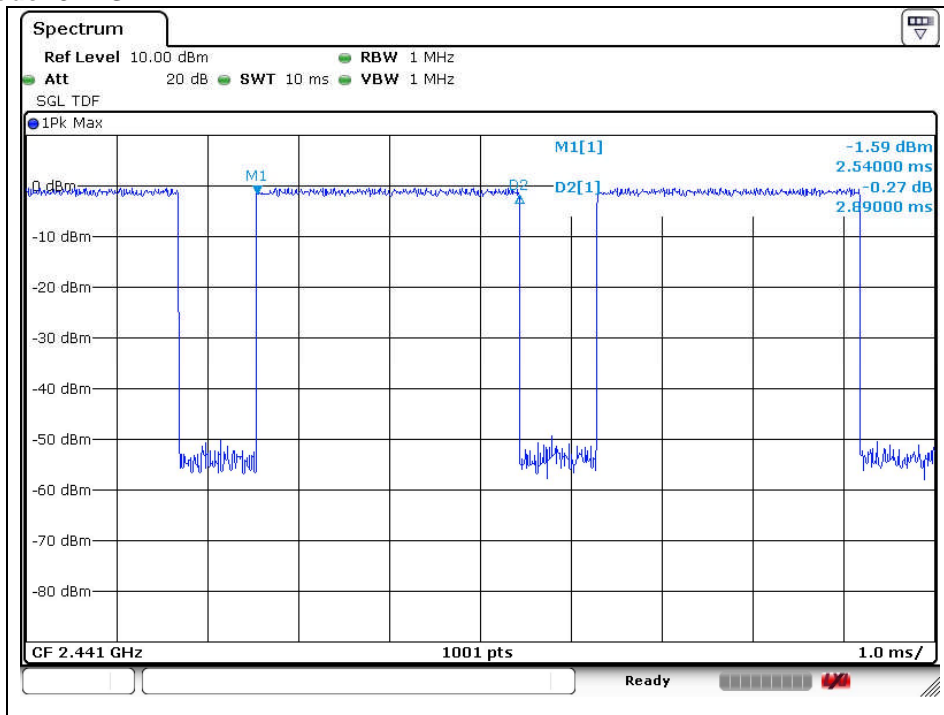

The results shown in this test report refer only to the sample(s) tested unless otherwise stated. This test report cannot be reproduced, except in full, without prior written permission of the Company. This test report does not assure KOLAS accreditation.

7.4.2.4. Packet Type: DH1, 3DH1 (Adaptive Frequency Hopping)

| Operation Mode | Frequency (MHz) | Dwell Time (ms) | Time of occupancy on the Tx Channel in 8 sec (ms) | Limit for time of occupancy on the Tx Channel in 8 sec (ms) |
|----------------|-----------------|-----------------|---|---|
| GFSK | 2 441 | 0.39 | 62.40 | 400 |
| 8DPSK | 2 441 | 0.39 | 62.40 | 400 |

Remark;

Time of occupancy on the TX channel in 8 sec

In case of GFSK and 8DPSK: $0.39 \times \{(800 \div 2) / 20\} \times 8 = 62.40$ ms

The results shown in this test report refer only to the sample(s) tested unless otherwise stated. This test report cannot be reproduced, except in full, without prior written permission of the Company. This test report does not assure KOLAS accreditation.

SGS Korea Co., Ltd. (Gunpo Laboratory) 4, LS-ro 182beon-gil, Gunpo-si, Gyeonggi-do, Korea, 15807 <http://www.sgsgroup.kr>

RTT5041-19(2017.07.10)(0)

Tel. +82 31 428 5700 / Fax. +82 31 427 2370

A4(210 mm x 297 mm)

Operating Mode: GFSK

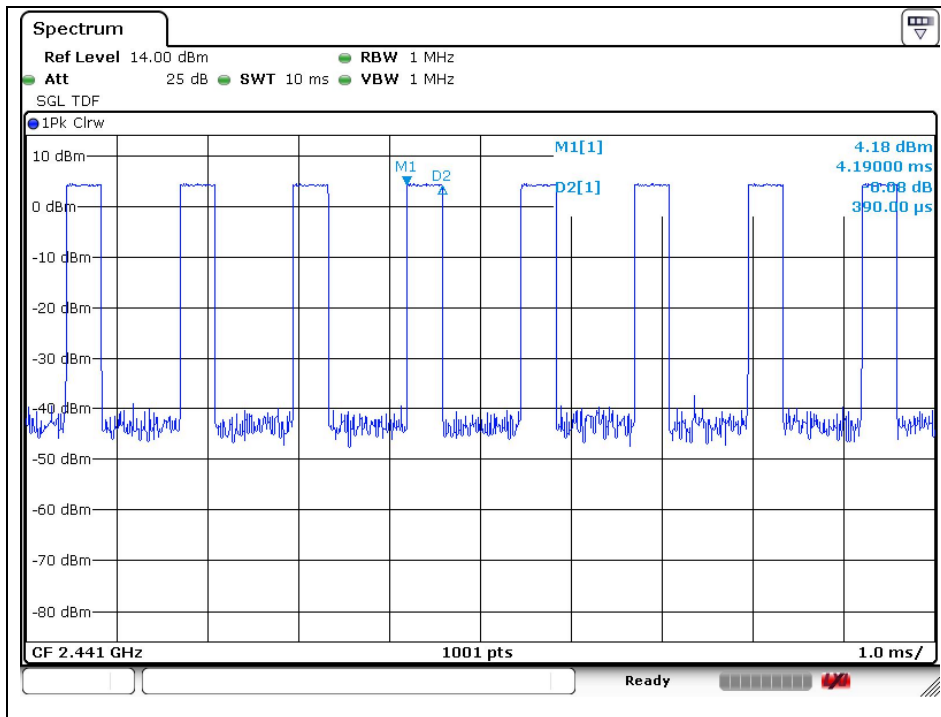

Operating Mode: 8DPSK

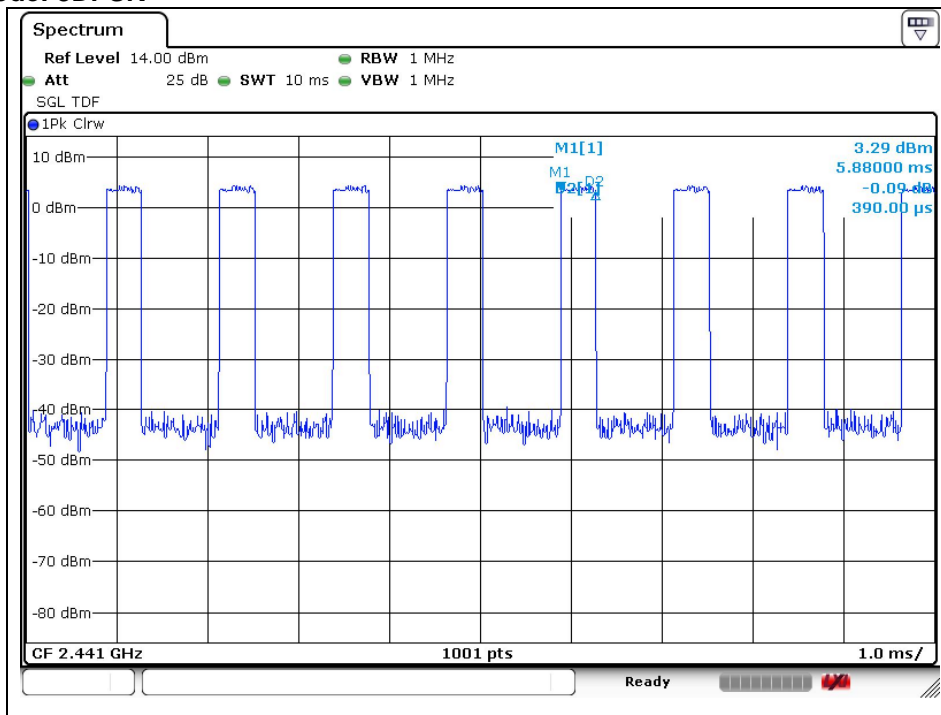

The results shown in this test report refer only to the sample(s) tested unless otherwise stated. This test report cannot be reproduced, except in full, without prior written permission of the Company. This test report does not assure KOLAS accreditation.

7.4.2.5. Packet Type: DH3, 3DH3 (Adaptive Frequency Hopping)

| Operation Mode | Frequency (MHz) | Dwell Time (ms) | Time of occupancy on the Tx Channel in 8 sec (ms) | Limit for time of occupancy on the Tx Channel in 8 sec (ms) |
|----------------|-----------------|-----------------|---|---|
| GFSK | 2 441 | 1.64 | 131.20 | 400 |
| 8DPSK | 2 441 | 1.64 | 131.20 | 400 |

Remark;

Time of occupancy on the TX channel in 8 sec

In case of GFSK and 8DPSK: $1.64 \times \{(800 \div 4) / 20\} \times 8 = 131.20$ ms

The results shown in this test report refer only to the sample(s) tested unless otherwise stated. This test report cannot be reproduced, except in full, without prior written permission of the Company. This test report does not assure KOLAS accreditation.

SGS Korea Co., Ltd. (Gunpo Laboratory) 4, LS-ro 182beon-gil, Gunpo-si, Gyeonggi-do, Korea, 15807 <http://www.sgsgroup.kr>

RTT5041-19(2017.07.10)(0)

Tel. +82 31 428 5700 / Fax. +82 31 427 2370

A4(210 mm x 297 mm)

Operating Mode: GFSK

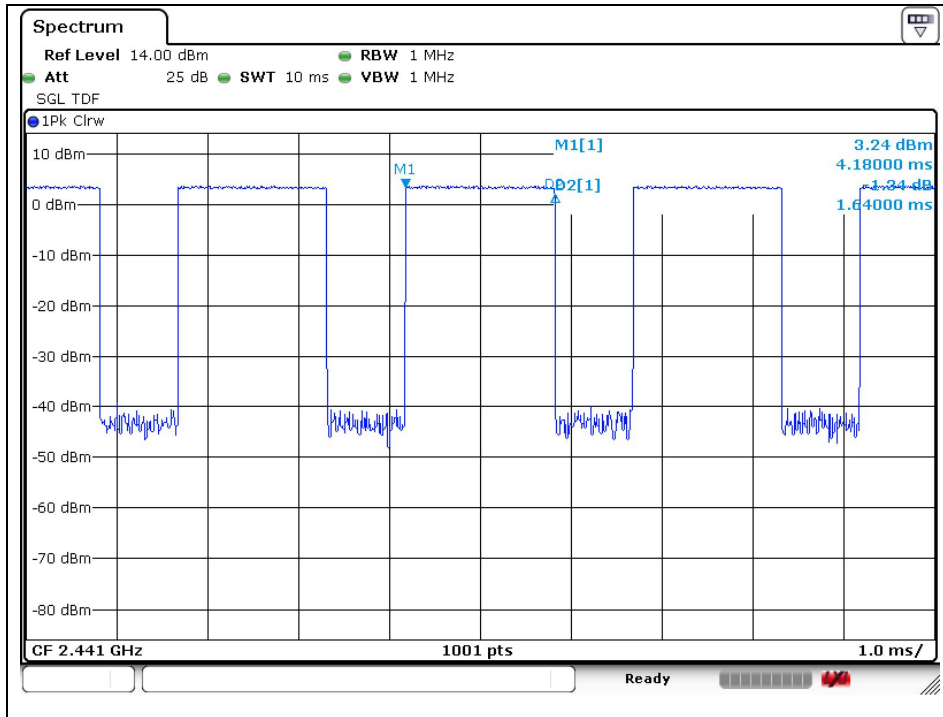

Operating Mode: 8DPSK

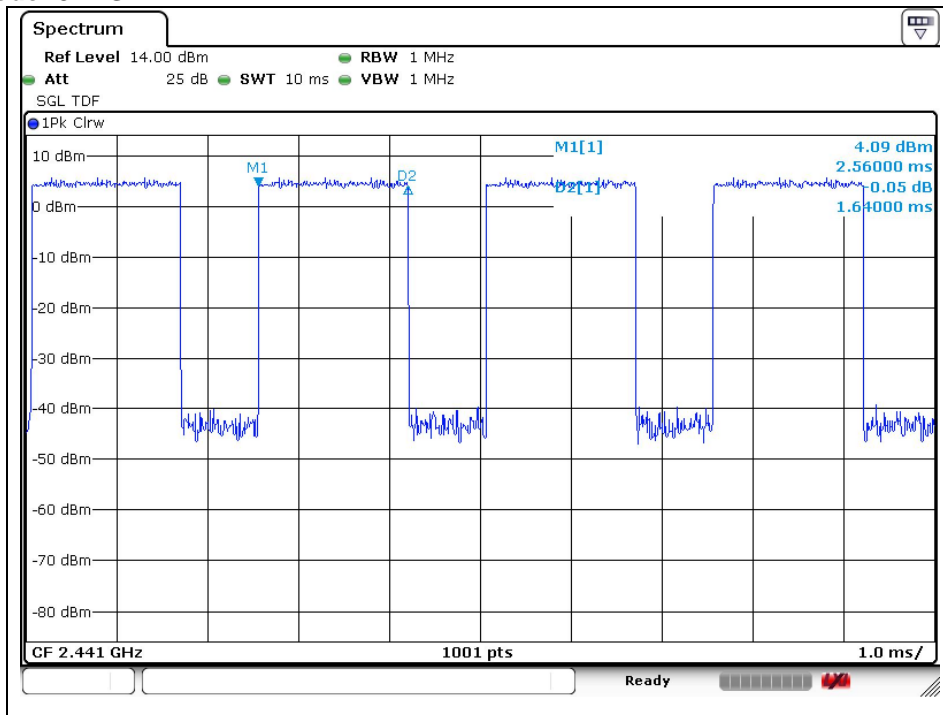

The results shown in this test report refer only to the sample(s) tested unless otherwise stated. This test report cannot be reproduced, except in full, without prior written permission of the Company. This test report does not assure KOLAS accreditation.

7.4.2.6. Packet Type: DH5, 3DH5 (Adaptive Frequency Hopping)

| Operation Mode | Frequency (MHz) | Dwell Time (ms) | Time of occupancy on the Tx Channel in 8 sec (ms) | Limit for time of occupancy on the Tx Channel in 8 sec (ms) |
|----------------|-----------------|-----------------|---|---|
| GFSK | 2 441 | 2.89 | 154.13 | 400 |
| 8DPSK | 2 441 | 2.90 | 154.67 | 400 |

Remark;

Time of occupancy on the TX channel in 8 sec

In case of GFSK: $2.89 \times \{(800 \div 6) / 20\} \times 8 = 154.13 \text{ ms}$

In case of 8DPSK: $2.90 \times \{(800 \div 6) / 20\} \times 8 = 154.67 \text{ ms}$

The results shown in this test report refer only to the sample(s) tested unless otherwise stated. This test report cannot be reproduced, except in full, without prior written permission of the Company. This test report does not assure KOLAS accreditation.

SGS Korea Co., Ltd. (Gunpo Laboratory) 4, LS-ro 182beon-gil, Gunpo-si, Gyeonggi-do, Korea, 15807 <http://www.sgsgroup.kr>

RTT5041-19(2017.07.10)(0)

Tel. +82 31 428 5700 / Fax. +82 31 427 2370

A4(210 mm x 297 mm)

Operating Mode: GFSK

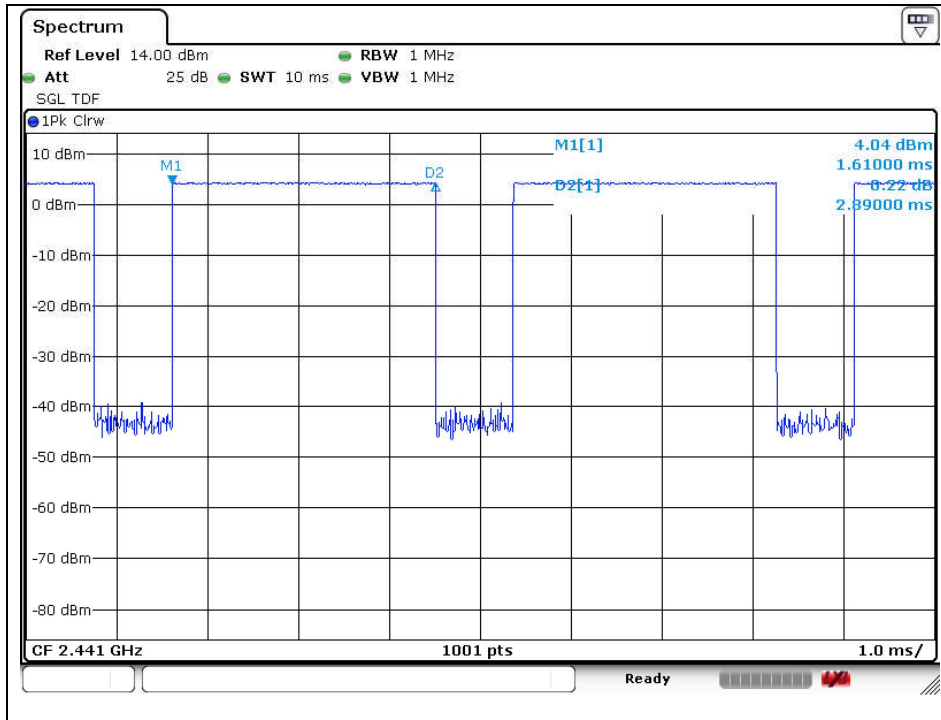

Operating Mode: 8DPSK

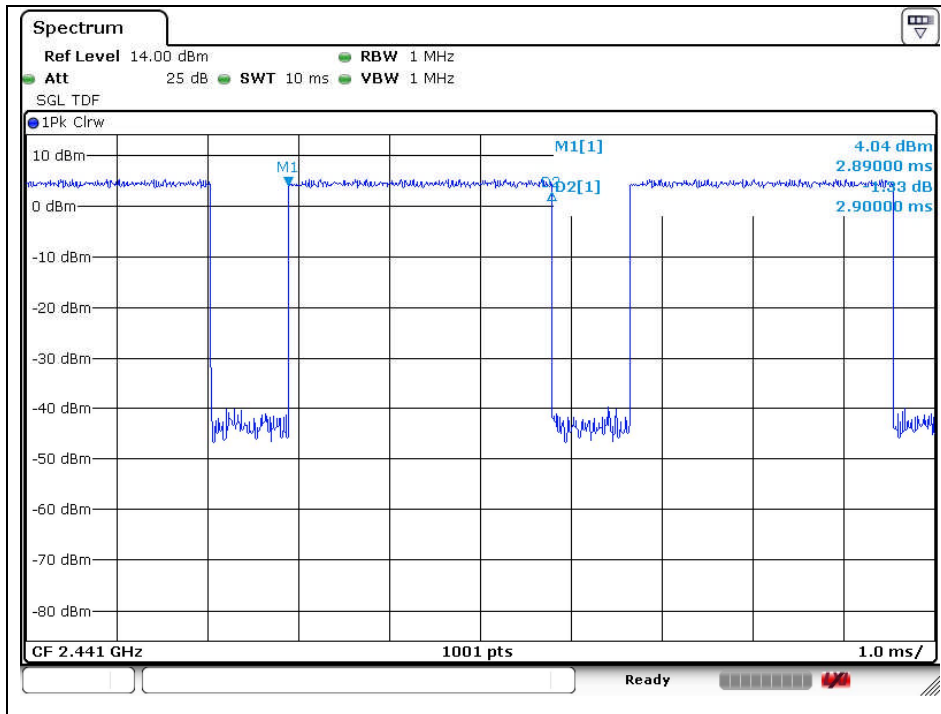

The results shown in this test report refer only to the sample(s) tested unless otherwise stated. This test report cannot be reproduced, except in full, without prior written permission of the Company. This test report does not assure KOLAS accreditation.

8. Antenna Requirement

8.1. Standard Applicable

For intentional device, according to FCC 47 CFR Section §15.203, an intentional radiator shall be designed to ensure that no antenna other than that furnished by the responsible party shall be used with the device. And according to FCC 47 CFR Section §15.247 (b) if transmitting antennas of directional gain greater than 6 dB i are used, the power shall be reduced by the amount in dB that the gain of the antenna exceeds 6 dB i.

8.2. Antenna Connected Construction

Antenna used in this product is Multilayer Chip Antenna with gain of 3.50 dB i.

- End of the Test Report -

The results shown in this test report refer only to the sample(s) tested unless otherwise stated. This test report cannot be reproduced, except in full, without prior written permission of the Company. This test report does not assure KOLAS accreditation.

SGS Korea Co., Ltd. (Gunpo Laboratory) 4, LS-ro 182beon-gil, Gunpo-si, Gyeonggi-do, Korea, 15807 <http://www.sgsgroup.kr>

RTT5041-19(2017.07.10)(0)

Tel. +82 31 428 5700 / Fax. +82 31 427 2370

A4(210 mm x 297 mm)