



FCC TEST REPORT

Test report

On Behalf of

Shenzhen FuShiKe Electronic Co., Ltd

For

Bluetooth headset

Model No.: A6,K10D,K10P,Q2,X980,TWS100,T200,X860,X918,Q1,Q10,Motion,
Engage,Q7,Q700

FCC ID: 2APZE-A6

Prepared for : Shenzhen FuShiKe Electronic Co., Ltd
F2, Building C, Kedashi Technology Park, No.42 Xinzhang Road, Guanlan Street,
Longhua New District, Shenzhen, China 518110

Prepared By : Shenzhen HUAKE Testing Technology Co., Ltd.
1F, B2 Building, Junfeng Zhongcheng Zhizao Innovation Park, Fuhai Street,
Bao'an District, Shenzhen City, China



TEST REPORT

Applicant's name.....: **Shenzhen FuShiKe Electronic Co., Ltd**
Address: F2, Building C, Kedashi Technology Park, No.42 Xinzhang Road,
 Guanlan Street, Longhua New District, Shenzhen, China 518110
Manufacture's Name: **Shenzhen FuShiKe Electronic Co., Ltd**
Address: F2, Building C, Kedashi Technology Park, No.42 Xinzhang Road,
 Guanlan Street, Longhua New District, Shenzhen, China 518110

Product description

Trade Mark: /
Product name: Bluetooth headset
Model and/or type reference : A6,K10D,K10P,Q2,X980,TWS100,T200,X860,X918,Q1,Q10,
 Motion,Engage,Q7,Q700
Standards: FCC Rules and Regulations Part 15 Subpart C Section 15.247
 ANSI C63.10: 2013

This publication may be reproduced in whole or in part for non-commercial purposes as long as the Shenzhen HUAK Testing Technology Co., Ltd. is acknowledged as copyright owner and source of the material. Shenzhen HUAK Testing Technology Co., Ltd. takes no responsibility for and will not assume liability for damages resulting from the reader's interpretation of the reproduced material due to its placement and context.

Date of Test.....: :
Date (s) of performance of tests: Nov. 20, 2018 ~. Dec. 03, 2018
Date of Issue: Dec. 03, 2018
Test Result: **Pass**

Testing Engineer : Gary Qian
 (Gary Qian)

Technical Manager : Eden Hu
 (Eden Hu)

Authorized Signatory : Jason Zhou
 (Jason Zhou)



Contents

1.	<u>..TEST STANDARDS</u>	<u>4</u>
2.	<u>..SUMMARY</u>	<u>5</u>
2.1.	Product Description	5
2.2.	Equipment Under Test	5
2.3.	Short description of the Equipment under Test (EUT)	5
2.4.	EUT operation mode	6
2.5.	Block Diagram of Test Setup	7
2.6.	Related Submittal(s) / Grant (s)	7
2.7.	Modifications	7
3.	<u>..TEST ENVIRONMENT</u>	<u>8</u>
3.1.	TEST FACILITY	8
3.2.	Environmental conditions	8
3.3.	Summary of measurement results	8
3.4.	Statement of the measurement uncertainty	9
3.5.	Equipments Used during the Test	9
4.	<u>..TEST CONDITIONS AND RESULTS</u>	<u>10</u>
4.1.	AC Power Conducted Emission	10
4.2.	Radiated Emission.....	13
4.3.	Maximum Peak Output Power.....	20
4.4.	20dB Bandwidth	21
4.5.	Frequency Separation	25
4.6.	Band Edge Compliance of RF Emission	27
4.7.	Spurious RF Conducted Emission	32
4.8.	Number of hopping frequency	38
4.9.	Time Of Occupancy(Dwell Time)	40
4.10.	Pseudorandom Frequency Hopping Sequence	44
4.11.	Antenna Requirement.....	45
5.	<u>..TEST SETUP PHOTOS OF THE EUT.....</u>	<u>46</u>



1. TEST STANDARDS

The tests were performed according to following standards:

[FCC Rules Part 15.247](#): Frequency Hopping, Direct Spread Spectrum and Hybrid Systems that are in operation within the bands of 902-928 MHz, 2400-2483.5 MHz, and 5725-5850 MHz.

[ANSI C63.10-2013](#): American National Standard for Testing Unlicensed Wireless Devices

[DA 00-705](#): Filing and Measurement Guidelines for Frequency Hopping Spread Spectrum Systems



2. SUMMARY

2.1. Product Description

Name of EUT	Bluetooth headset
Trade Mark:	/
Model Number	A6
List Model:	K10D,K10P,Q2,X980,TWS100,T200,X860,X918,Q1,Q10, Motion,Engage,Q7,Q700
Power Rating	DC 3.7V and DC 5V From Adapter
Adapter(Auxiliary test Provided by the laborator)	Mode:EP-TA20CBC Input:AC100-240V-50/60Hz, 0.5A Output:DC 5V,2A
FCC ID	2APZE-A6
Bluetooth FCC Operation frequency	2402MHz-2480MHz
Bluetooth Modulation	GFSK,8DPSK, π /4DQPSK
Bluetooth	BT 4.2
Antenna Type	Ceramic antenna
Antenna gain	2.0dBi

2.2. Equipment Under Test

Power supply system utilised

Power supply voltage	:	<input type="radio"/> 230V / 50 Hz	<input type="radio"/> 120V / 60Hz
		<input type="radio"/> 12 V DC	<input type="radio"/> 24 V DC
		<input checked="" type="radio"/> Other (specified in blank below)	

DC 3.7V and DC 5V From Adapter

2.3. Short description of the Equipment under Test (EUT)

This is a Bluetooth headset.

For more details, refer to the user's manual of the EUT.



2.4. EUT operation mode

The Applicant provides test software (BlueTest3) to control the EUT for staying in continuous transmitting and receiving mode for testing .There are 79 channels provided to the EUT. Channel 00/39/78 was selected to test.

Channel	Frequency(MHz)	Channel	Frequency(MHz)
00	2402	40	2442
01	2403	41	2443
02	2404	42	2444
03	2405	43	2445
04	2406	44	2446
05	2407	45	2447
06	2408	46	2448
07	2409	47	2449
08	2410	48	2450
09	2411	49	2451
10	2412	50	2452
11	2413	51	2453
12	2414	52	2454
13	2415	53	2455
14	2416	54	2456
15	2417	55	2457
16	2418	56	2458
17	2419	57	2459
18	2420	58	2460
19	2421	59	2461
20	2422	60	2462
21	2423	61	2463
22	2424	62	2464
23	2425	63	2465
24	2426	64	2466
25	2427	65	2467
26	2428	66	2468
27	2429	67	2469
28	2430	68	2470
29	2431	69	2471
30	2432	70	2472
31	2433	71	2473
32	2434	72	2474
33	2435	73	2475
34	2436	74	2476
35	2437	75	2477
36	2438	76	2478
37	2439	77	2479
38	2440	78	2480
39	2441		



2.5. Block Diagram of Test Setup

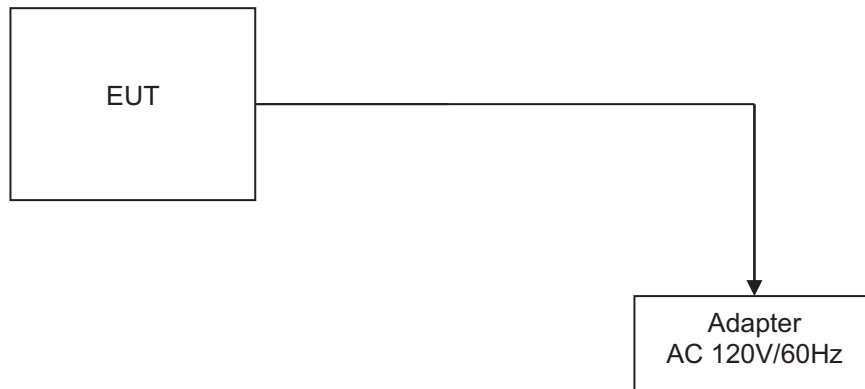

2.6. Related Submittal(s) / Grant (s)

This submittal(s) (test report) is intended for **FCC ID: 2APZE-A6** filing to comply with Section 15.247 of the FCC Part 15, Subpart C Rules.

2.7. Modifications

No modifications were implemented to meet testing criteria.



3. TEST ENVIRONMENT

3.1. TEST FACILITY

Test Firm : Shenzhen HUAK Testing Technology Co., Ltd.

Address 1F, B2 Building, Junfeng Zhongcheng Zhizao Innovation Park, Fuhai Street, Bao'an District, Shenzhen City, China

3.2. Environmental conditions

During the measurement the environmental conditions were within the listed ranges:

Temperature:	15-35 ° C
Humidity:	30-60 %
Atmospheric pressure:	950-1050mbar

3.3. Summary of measurement results

Test Specification clause	Test case	Test Mode	Test Channel	Recorded In Report		Pass	Fail	NA	NP	Remark
§15.247(a)(1)	Carrier Frequency separation	GFSK π/4DQPSK 8DPSK	<input checked="" type="checkbox"/> Lowest <input checked="" type="checkbox"/> Middle <input checked="" type="checkbox"/> Highest	GFSK π/4DQPSK 8DPSK	<input checked="" type="checkbox"/> Middle	<input checked="" type="checkbox"/>	<input type="checkbox"/>	<input type="checkbox"/>	<input type="checkbox"/>	complies
§15.247(a)(1)	Number of Hopping channels	GFSK π/4DQPSK 8DPSK	<input checked="" type="checkbox"/> Full	GFSK 8DPSK	<input checked="" type="checkbox"/> Full	<input checked="" type="checkbox"/>	<input type="checkbox"/>	<input type="checkbox"/>	<input type="checkbox"/>	complies
§15.247(a)(1)	Time of Occupancy (dwell time)	GFSK π/4DQPSK 8DPSK	<input checked="" type="checkbox"/> Lowest <input checked="" type="checkbox"/> Middle <input checked="" type="checkbox"/> Highest	GFSK π/4DQPSK 8DPSK	<input checked="" type="checkbox"/> Middle	<input checked="" type="checkbox"/>	<input type="checkbox"/>	<input type="checkbox"/>	<input type="checkbox"/>	complies
§15.247(a)(1)	Spectrum bandwidth of a FHSS system 20dB bandwidth	GFSK π/4DQPSK 8DPSK	<input checked="" type="checkbox"/> Lowest <input checked="" type="checkbox"/> Middle <input checked="" type="checkbox"/> Highest	GFSK π/4DQPSK 8DPSK	<input checked="" type="checkbox"/> Lowest <input checked="" type="checkbox"/> Middle <input checked="" type="checkbox"/> Highest	<input checked="" type="checkbox"/>	<input type="checkbox"/>	<input type="checkbox"/>	<input type="checkbox"/>	complies
§15.247(b)(1)	Maximum output power	GFSK π/4DQPSK 8DPSK	<input checked="" type="checkbox"/> Lowest <input checked="" type="checkbox"/> Middle <input checked="" type="checkbox"/> Highest	GFSK π/4DQPSK 8DPSK	<input checked="" type="checkbox"/> Lowest <input checked="" type="checkbox"/> Middle <input checked="" type="checkbox"/> Highest	<input checked="" type="checkbox"/>	<input type="checkbox"/>	<input type="checkbox"/>	<input type="checkbox"/>	complies
§15.247(d)	Band edge compliance conducted	GFSK π/4DQPSK 8DPSK	<input checked="" type="checkbox"/> Lowest <input checked="" type="checkbox"/> Highest	GFSK π/4DQPSK 8DPSK	<input checked="" type="checkbox"/> Lowest <input checked="" type="checkbox"/> Highest	<input checked="" type="checkbox"/>	<input type="checkbox"/>	<input type="checkbox"/>	<input type="checkbox"/>	complies
§15.205	Band edge compliance radiated	GFSK π/4DQPSK 8DPSK	<input checked="" type="checkbox"/> Lowest <input checked="" type="checkbox"/> Highest	GFSK	<input checked="" type="checkbox"/> Lowest <input checked="" type="checkbox"/> Highest	<input checked="" type="checkbox"/>	<input type="checkbox"/>	<input type="checkbox"/>	<input type="checkbox"/>	complies
§15.247(d)	TX spurious emissions conducted	GFSK π/4DQPSK 8DPSK	<input checked="" type="checkbox"/> Lowest <input checked="" type="checkbox"/> Middle <input checked="" type="checkbox"/> Highest	GFSK π/4DQPSK 8DPSK	<input checked="" type="checkbox"/> Lowest <input checked="" type="checkbox"/> Middle <input checked="" type="checkbox"/> Highest	<input checked="" type="checkbox"/>	<input type="checkbox"/>	<input type="checkbox"/>	<input type="checkbox"/>	complies
§15.247(d)	TX spurious emissions radiated	GFSK π/4DQPSK 8DPSK	<input checked="" type="checkbox"/> Lowest <input checked="" type="checkbox"/> Middle <input checked="" type="checkbox"/> Highest	GFSK	<input checked="" type="checkbox"/> Lowest <input checked="" type="checkbox"/> Middle <input checked="" type="checkbox"/> Highest	<input checked="" type="checkbox"/>	<input type="checkbox"/>	<input type="checkbox"/>	<input type="checkbox"/>	complies
§15.209(a)	TX spurious Emissions radiated Below 1GHz	GFSK π/4DQPSK 8DPSK	<input checked="" type="checkbox"/> Lowest <input checked="" type="checkbox"/> Middle <input checked="" type="checkbox"/> Highest	GFSK	<input checked="" type="checkbox"/> Middle	<input checked="" type="checkbox"/>	<input type="checkbox"/>	<input type="checkbox"/>	<input type="checkbox"/>	complies
§15.107(a) §15.207	Conducted Emissions 9KHz-30 MHz	GFSK π/4DQPSK 8DPSK	<input checked="" type="checkbox"/> Lowest <input checked="" type="checkbox"/> Middle <input checked="" type="checkbox"/> Highest	GFSK	<input checked="" type="checkbox"/> Middle	<input checked="" type="checkbox"/>	<input type="checkbox"/>	<input type="checkbox"/>	<input type="checkbox"/>	complies

Remark:

1. The measurement uncertainty is not included in the test result.
2. NA = Not Applicable; NP = Not Performed
3. We tested all test mode and recorded worst case in report



3.4. Statement of the measurement uncertainty

Measurement Uncertainty

Conducted Emission Expanded Uncertainty	= 2.23dB, k=2
Radiated emission expanded uncertainty(9kHz-30MHz)	= 3.08dB, k=2
Radiated emission expanded uncertainty(30MHz-1000MHz)	= 4.42dB, k=2
Radiated emission expanded uncertainty(Above 1GHz)	= 4.06dB, k=2

3.5. Equipments Used during the Test

Item	Equipment	Manufacturer	Model No.	Serial No.	Last Cal.	Cal. Interval
1.	L.I.S.N. Artificial Mains Network	R&S	ENV216	HKE-002	Dec. 28, 2017	1 Year
2.	Receiver	R&S	ESCI 7	HKE-010	Dec. 28, 2017	1 Year
3.	RF automatic control unit	Tonscend	JS0806-2	HKE-060	Dec. 28, 2017	1 Year
4.	Spectrum analyzer	R&S	FSP40	HKE-025	Dec. 28, 2017	1 Year
5.	Spectrum analyzer	Agilent	N9020A	HKE-048	Dec. 28, 2017	1 Year
6.	Preamplifier	Schwarzbeck	BBV 9743	HKE-006	Dec. 28, 2017	1 Year
7.	EMI Test Receiver	Rohde & Schwarz	ESCI 7	HKE-010	Dec. 28, 2017	1 Year
8.	Bilog Broadband Antenna	Schwarzbeck	VULB9163	HKE-012	Dec. 28, 2017	1 Year
9.	Loop Antenna	Schwarzbeck	FMZB 1519 B	HKE-014	Dec. 28, 2017	1 Year
10.	Horn Antenna	Schwarzbeck	9120D	HKE-013	Dec. 28, 2017	1 Year
11.	Broadband Horn Antenna	SCHWARZBECK	BBHA 9170	HKE-017	Dec. 28, 2017	1 Year
12.	Pre-amplifier	EMCI	EMC051845 SE	HKE-015	Dec. 28, 2017	1 Year
13.	Pre-amplifier	Agilent	83051A	HKE-016	Dec. 28, 2017	1 Year
14.	EMI Test Software EZ-EMC	Tonscend	JS1120-B Version	HKE-083	Dec. 28, 2017	N/A
15.	Power Sensor	Agilent	E9300A	HKE-086	Dec. 28, 2017	1 Year
16.	Spectrum analyzer	Agilent	N9020A	HKE-048	Dec. 28, 2017	1 Year
17.	Signal generator	Agilent	N5182A	HKE-029	Dec. 28, 2017	1 Year
18.	Signal Generator	Agilent	83630A	HKE-028	Dec. 28, 2017	1 Year
19.	Shielded room	Shiel Hong	4*3*3	HKE-039	Dec. 28, 2017	3 Year
20.	RF Cable(below 1GHz)	HUBER+SUHNER	RG214	HKE-055	Dec. 28, 2017	1 Year
21.	RF Cable(above 1GHz)	HUBER+SUHNER	RG214	HKE-056	Dec. 28, 2017	1 Year

Note: 1. The Cal.Interval was one year.

4. TEST CONDITIONS AND RESULTS

4.1. AC Power Conducted Emission

TEST CONFIGURATION

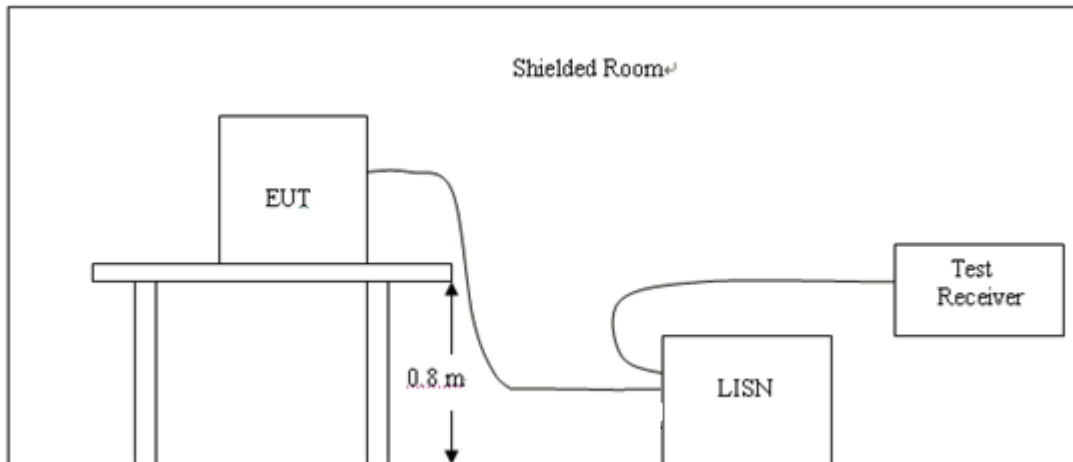

TEST PROCEDURE

- 1, The equipment was set up as per the test configuration to simulate typical actual usage per the user's manual. The EUT is a tabletop system, a wooden table with a height of 0.8 meters is used and is placed on the ground plane as per ANSI C63.10.
- 2, Support equipment, if needed, was placed as per ANSI C63.10.
- 3, All I/O cables were positioned to simulate typical actual usage as per ANSI C63.10.
- 4, If a EUT received DC power from the USB Port of Notebook PC, the PC's adapter received power through a Line Impedance Stabilization Network (LISN) which supplied power source and was grounded to the ground plane.
- 5, All support equipments received AC power from a second LISN, if any.
- 6, The EUT test program was started. Emissions were measured on each current carrying line of the EUT using a spectrum Analyzer / Receiver connected to the LISN powering the EUT. The LISN has two monitoring points: Line 1 (Hot Side) and Line 2 (Neutral Side). Two scans were taken: one with Line 1 connected to Analyzer / Receiver and Line 2 connected to a 50 ohm load; the second scan had Line 1 connected to a 50 ohm load and Line 2 connected to the Analyzer / Receiver.
- 7, Analyzer / Receiver scanned from 150 KHz to 30MHz for emissions in each of the test modes.

AC Power Conducted Emission Limit

For intentional device, according to § 15.207(a) AC Power Conducted Emission Limits is as following :

Frequency range (MHz)	Limit (dBuV)	
	Quasi-peak	Average
0.15-0.5	66 to 56*	56 to 46*
0.5-5	56	46
5-30	60	50

* Decreases with the logarithm of the frequency.

TEST RESULTS

Remark:

1. All modes of GFSK, Pi/4 DQPSK, and 8DPSK were test at Low, Middle, and High channel; only the worst result of GFSK Middle Channel was reported as below:
2. Both 120 VAC, 50/60 Hz and 240 VAC, 50/60 Hz power supply have been tested, only the worst result of 120 VAC, 60 Hz was reported as below:.



Power supply:

DC 5V from Adapter
AC 120V/60Hz

Polarization

L

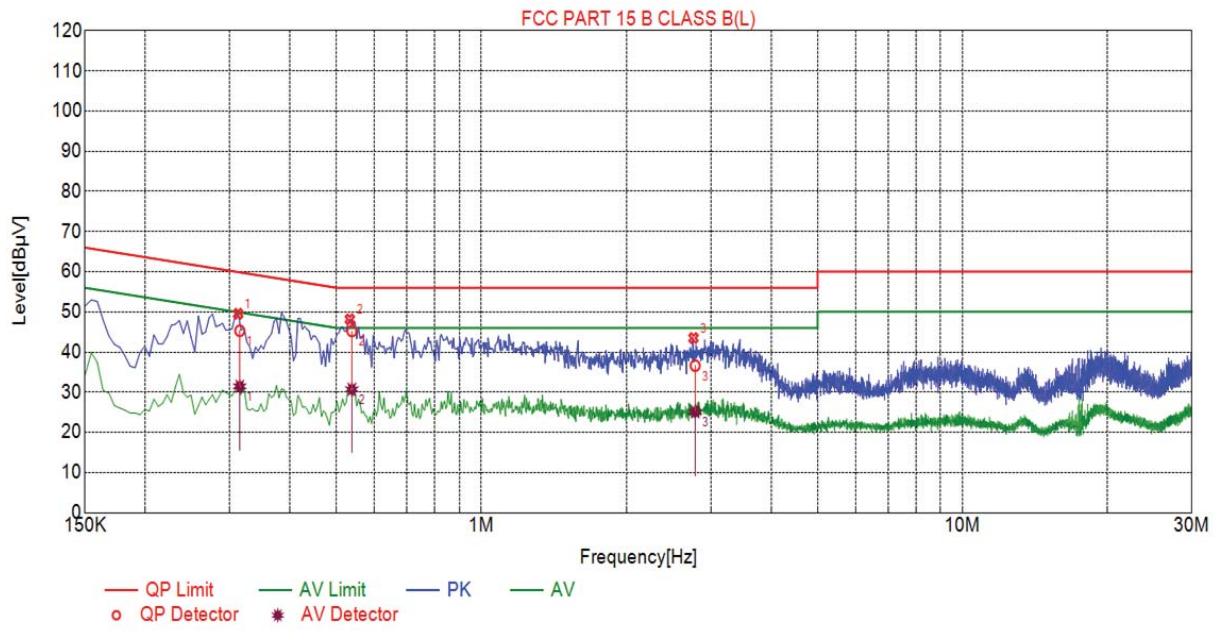

Final Data List

NO.	Freq. [MHz]	Factor [dB]	QP Value [dBμV]	QP Limit [dBμV]	QP Margin [dB]	AV Value [dBμV]	AV Limit [dBμV]	AV Margin [dB]
1	0.3144	10.05	45.31	59.85	14.54	31.48	49.85	18.37
2	0.5378	10.05	45.24	56.00	10.76	30.73	46.00	15.27
3	2.7820	10.21	36.62	56.00	19.38	25.13	46.00	20.87



Power supply:	DC 5V from Adapter AC 120V/60Hz	Polarization	N
---------------	------------------------------------	--------------	---

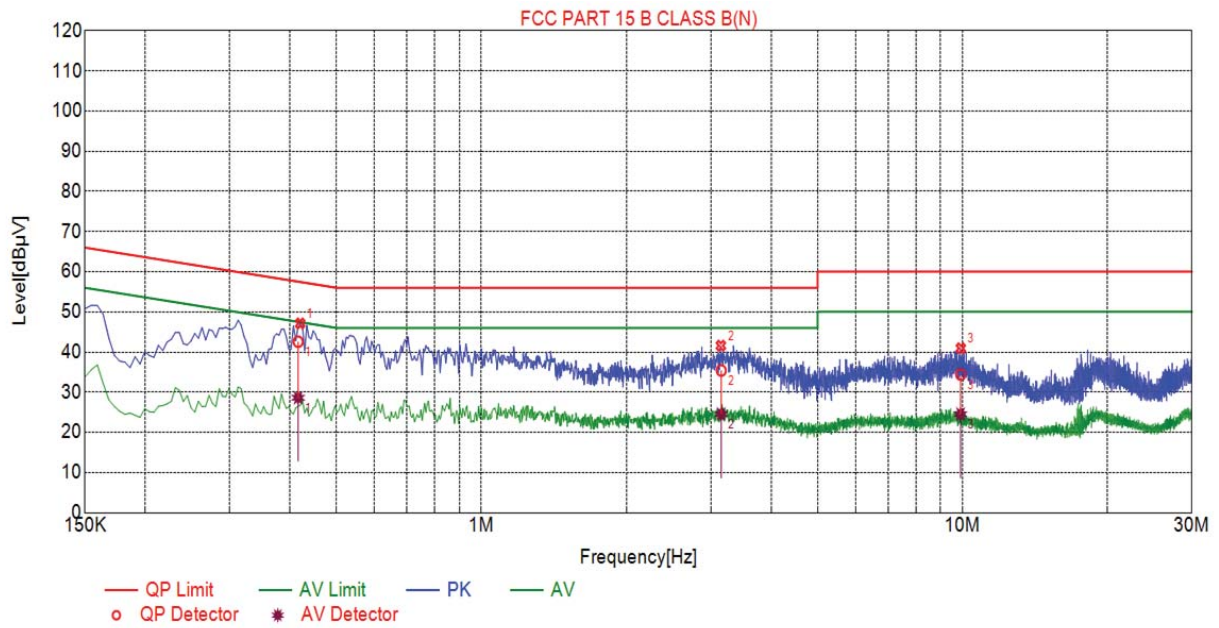

Final Data List

NO.	Freq. [MHz]	Factor [dB]	QP Value [dBuV]	QP Limit [dBuV]	QP Margin [dB]	AV Value [dBuV]	AV Limit [dBuV]	AV Margin [dB]
1	0.4158	10.03	42.57	57.53	14.96	28.63	47.53	18.90
2	3.1522	10.23	35.41	56.00	20.59	24.57	46.00	21.43
3	9.9147	10.07	34.41	60.00	25.59	24.56	50.00	25.44

4.2. Radiated Emission

TEST CONFIGURATION

Frequency range 9 KHz – 30MHz

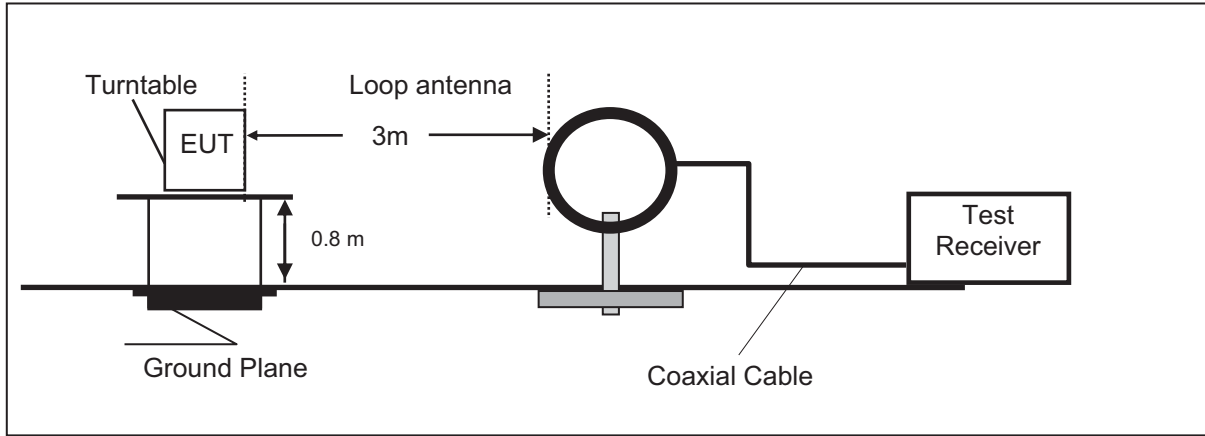

Frequency range 30MHz – 1000MHz

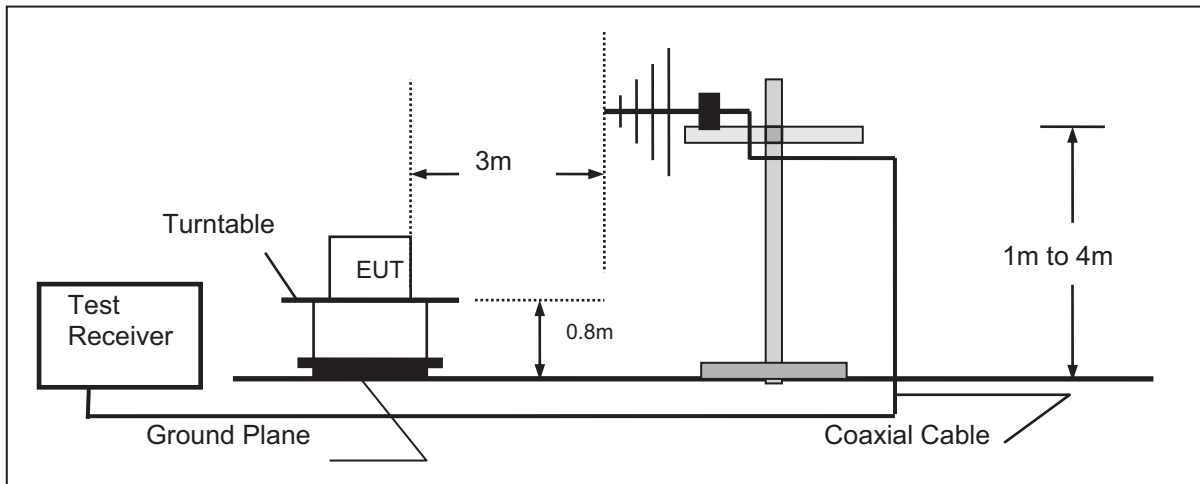

Frequency range above 1GHz-25GHz

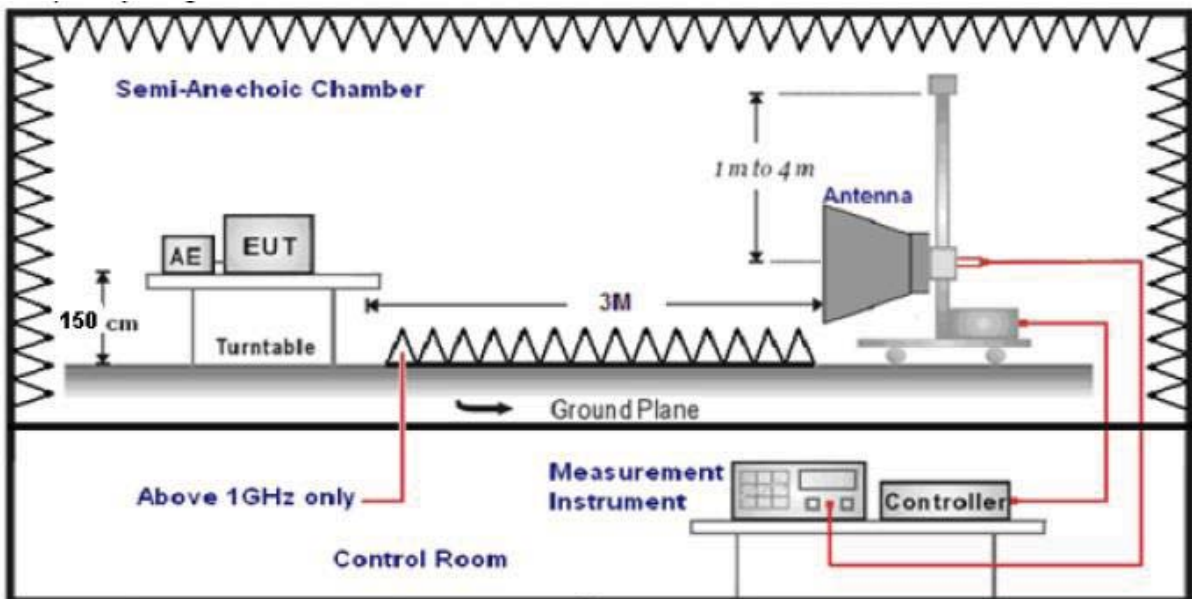



TEST PROCEDURE

1. The EUT was placed on a turn table which is 12mm above ground plane when testing frequency range 9 KHz –25GHz.
2. Maximum procedure was performed by raising the receiving antenna from 1m to 4m and rotating the turn table from 0°C to 360°C to acquire the highest emissions from EUT.
3. And also, each emission was to be maximized by changing the polarization of receiving antenna both horizontal and vertical.
4. Repeat above procedures until all frequency measurements have been completed.
5. The EUT minimum operation frequency was 32.768KHz and maximum operation frequency was 2480MHz.so radiated emission test frequency band from 9KHz to 25GHz.
6. The distance between test antenna and EUT as following table states:

Test Frequency range	Test Antenna Type	Test Distance
9KHz-30MHz	Active Loop Antenna	3
30MHz-1GHz	Ultra-Broadband Antenna	3
1GHz-18GHz	Double Ridged Horn Antenna	3
18GHz-25GHz	Horn Antenna	1

7. Setting test receiver/spectrum as following table states:

Test Frequency range	Test Receiver/Spectrum Setting	Detector
9KHz-150KHz	RBW=200Hz/VBW=3KHz, Sweep time=Auto	QP
150KHz-30MHz	RBW=9KHz/VBW=100KHz, Sweep time=Auto	QP
30MHz-1GHz	RBW=120KHz/VBW=1000KHz, Sweep time=Auto	QP
1GHz-40GHz	Peak Value: RBW=1MHz/VBW=3MHz, Sweep time=Auto Average Value: RBW=1MHz/VBW=10Hz, Sweep time=Auto	Peak

Field Strength Calculation

The field strength is calculated by adding the Antenna Factor and Cable Factor and subtracting the Amplifier Gain and Duty Cycle Correction Factor(if any) from the measured reading. The basic equation with a sample calculation is as follows:

$$FS = RA + AF + CL - AG$$

Where FS = Field Strength	CL = Cable Attenuation Factor (Cable Loss)
RA = Reading Amplitude	AG = Amplifier Gain
AF = Antenna Factor	

$$Transd=AF +CL-AG$$

RADIATION LIMIT

For intentional device, according to § 15.209(a), the general requirement of field strength of radiated emission from intentional radiators at a distance of 3 meters shall not exceed the following table. According to § 15.247(d), in any 100kHz bandwidth outside the frequency band in which the EUT is operating, the radio frequency power that is produced by the intentional radiator shall be at least 20dB below that in the100kHz bandwidth within the band that contains the highest level of desired power.

The pre-test have done for the EUT in three axes and found the worst emission at position shown in test setup photos.

Frequency (MHz)	Distance (Meters)	Radiated (dBµV/m)	Radiated (µV/m)
0.009-0.49	3	20log(2400/F(KHz))+40log(300/3)	2400/F(KHz)
0.49-1.705	3	20log(24000/F(KHz))+ 40log(30/3)	24000/F(KHz)
1.705-30	3	20log(30)+ 40log(30/3)	30
30-88	3	40.0	100
88-216	3	43.5	150
216-960	3	46.0	200
Above 960	3	54.0	500



TEST RESULTS

Remark: For test below 1GHz all modes of GFSK, Pi/4 DQPSK, and 8DPSK were test at Low, Middle, and High channel; only the worst result of GFSK Middle Channel was reported as below:

For 9 KHz-30MHz

Frequency (MHz)	Corrected Reading (dBuV/m)@3m	FCC Limit (dBuV/m) @3m	Margin (dB)	Detector	Result
0.38	46.37	96.01	49.64	QP	PASS
1.55	51.42	63.80	12.38	QP	PASS
19.68	56.71	69.54	12.83	QP	PASS
24.62	40.86	69.54	28.68	QP	PASS

For 30MHz-1GHz

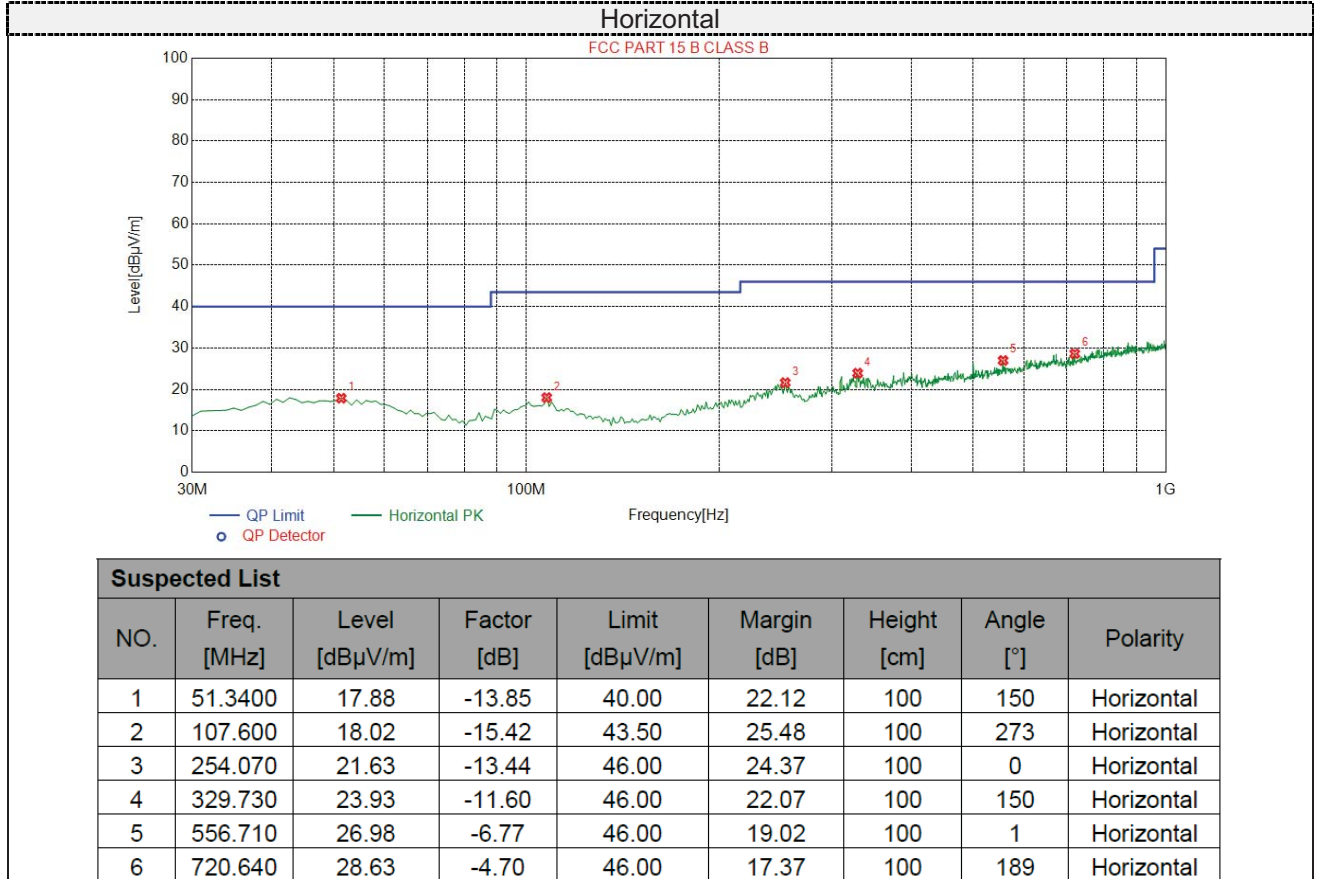

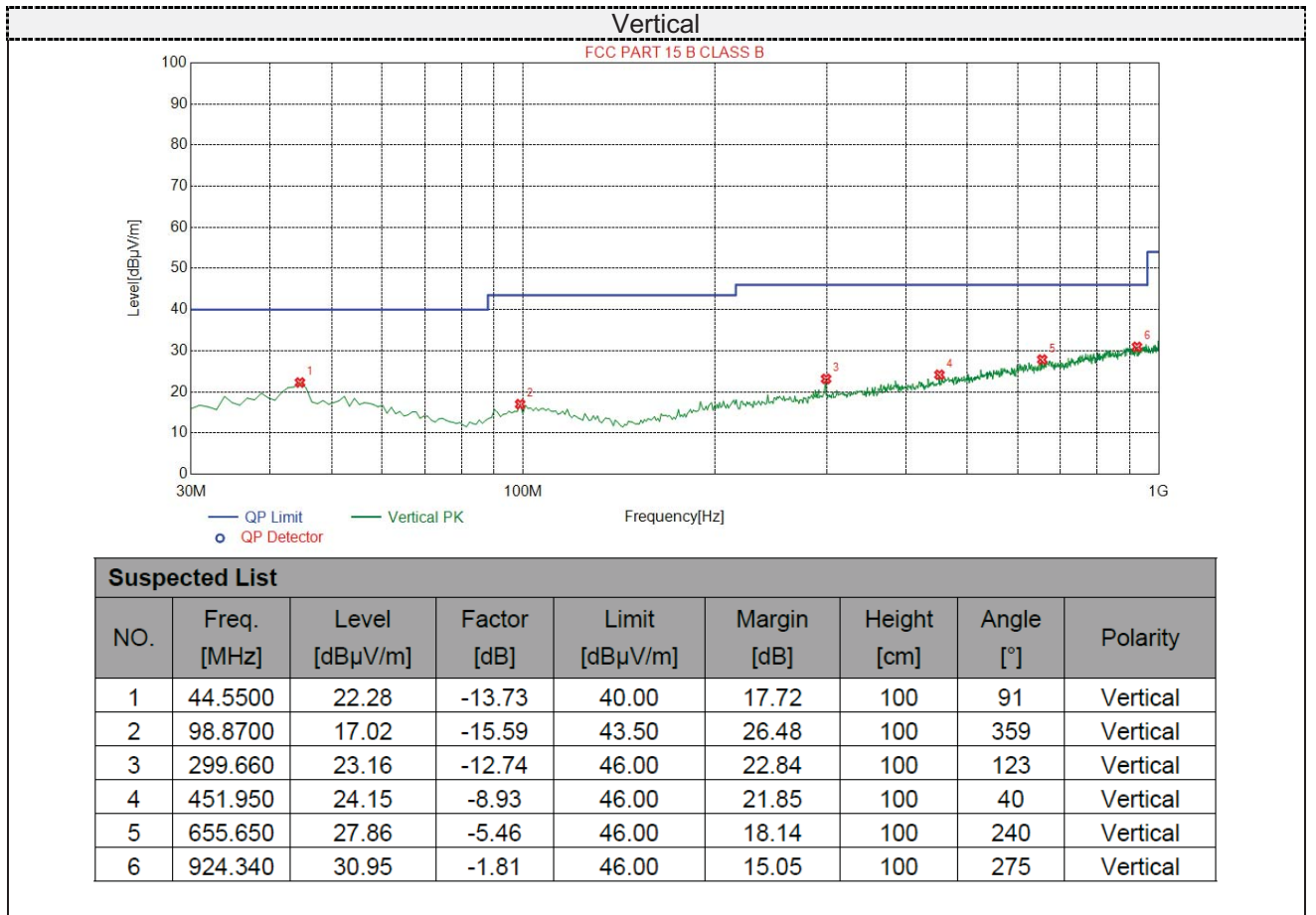



For 1GHz to 25GHz

Remark: For test above 1GHz GFSK, Pi/4 DQPSK, and 8DPSK were test at Low, Middle, and High channel; only the worst result of GFSK was reported as below:

CH Low (2402MHz)

Horizontal:

Frequency	Meter Reading	Factor	Emission Level	Limits	Margin	Detector Type
(MHz)	(dBμV)	(dB)	(dBμV/m)	(dBμV/m)	(dB)	
4804	60.56	-3.64	56.92	74	-17.08	peak
4804	46.72	-3.64	43.08	54	-10.92	AVG
7206	56.38	-0.95	55.43	74	-18.57	peak
7206	42.51	-0.95	41.56	54	-12.44	AVG
---	---	---	---	---	---	---
---	---	---	---	---	---	---

Remark: Factor = Antenna Factor + Cable Loss – Pre-amplifier.

Vertical:

Frequency	Meter Reading	Factor	Emission Level	Limits	Margin	Detector Type
(MHz)	(dBμV)	(dB)	(dBμV/m)	(dBμV/m)	(dB)	
4804	61.63	-3.64	57.99	74	-16.01	peak
4804	44.79	-3.64	41.15	54	-12.85	AVG
7206	55.68	-0.95	54.73	74	-19.27	peak
7206	42.42	-0.95	41.47	54	-12.53	AVG
---	---	---	---	---	---	---
---	---	---	---	---	---	---

Remark: Factor = Antenna Factor + Cable Loss – Pre-amplifier.



CH Middle (2441MHz)

Horizontal:

Frequency	Meter Reading	Factor	Emission Level	Limits	Margin	Detector Type
(MHz)	(dB μ V)	(dB)	(dB μ V/m)	(dB μ V/m)	(dB)	
4882	61.89	-3.51	58.38	74	-15.62	peak
4882	44.68	-3.51	41.17	54	-12.83	AVG
7326	56.51	-0.82	55.69	74	-18.31	peak
7326	41.67	-0.82	40.85	54	-13.15	AVG
---	---	---	---	---	---	---
---	---	---	---	---	---	---

Remark: Factor = Antenna Factor + Cable Loss – Pre-amplifier.

Vertical:

Frequency	Meter Reading	Factor	Emission Level	Limits	Margin	Detector Type
(MHz)	(dB μ V)	(dB)	(dB μ V/m)	(dB μ V/m)	(dB)	
4882	59.72	-3.51	56.21	74	-17.79	peak
4882	45.53	-3.51	42.02	54	-11.98	AVG
7326	56.49	-0.82	55.67	74	-18.33	peak
7326	41.67	-0.82	40.85	54	-13.15	AVG
---	---	---	---	---	---	---
---	---	---	---	---	---	---

Remark: Factor = Antenna Factor + Cable Loss – Pre-amplifier.



CH High (2480MHz)

Horizontal:

Frequency	Meter Reading	Factor	Emission Level	Limits	Margin	Detector Type
(MHz)	(dB μ V)	(dB)	(dB μ V/m)	(dB μ V/m)	(dB)	
4960	59.76	-3.43	56.33	74	-17.67	peak
4960	45.68	-3.43	42.25	54	-11.75	AVG
7440	55.13	-0.75	54.38	74	-19.62	peak
7440	41.72	-0.75	40.97	54	-13.03	AVG
---	---	---	---	---	---	---
---	---	---	---	---	---	---

Remark: Factor = Antenna Factor + Cable Loss – Pre-amplifier.

Vertical:

Frequency	Meter Reading	Factor	Emission Level	Limits	Margin	Detector Type
(MHz)	(dB μ V)	(dB)	(dB μ V/m)	(dB μ V/m)	(dB)	
4960	59.09	-3.43	55.66	74	-18.34	peak
4960	46.2	-3.43	42.77	54	-11.23	AVG
7440	56.37	-0.75	55.62	74	-18.38	peak
7440	41.76	-0.75	41.01	54	-12.99	AVG
---	---	---	---	---	---	---
---	---	---	---	---	---	---

Remark: Factor = Antenna Factor + Cable Loss – Pre-amplifier.

Remark:

(1) Data of measurement within this frequency range shown “---” in the table above means the reading of emissions are attenuated more than 20dB below the permissible limits or the field strength is too small to be measured.

(2) When the test results of Peak Detected below the limits of Average Detected, the Average Detected is not need completed.



4.3. Maximum Peak Output Power

TEST CONFIGURATION

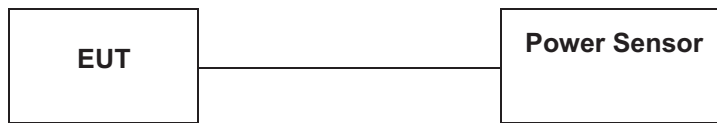

TEST PROCEDURE

According to ANSI C63.10:2013 Maximum peak conducted output power for HFSS devices:
The maximum peak conducted output power may be measured using a broadband peak RF power meter.
The power meter shall have a video bandwidth that is greater than or equal to the HFSS bandwidth and shall utilize a fast-responding diode detector.

LIMIT

For frequency hopping systems operating in the 2400–2483.5 MHz band employing at least 75 non-overlapping hopping channels, and all frequency hopping systems in the 5725–5850 MHz band: 1 watt. For all other frequency hopping systems in the 2400–2483.5 MHz band: 0.125 watts.

TEST RESULTS

Type	Channel	Peak Output power (dBm)	Limit (dBm)	Result
GFSK	00	1.837	21	Pass
	39	0.411		
	78	1.286		
$\pi/4$ DQPSK	00	1.211	21	Pass
	39	0.116		
	78	1.040		
8DPSK	00	1.435	21	Pass
	39	0.228		
	78	1.138		

Note: 1.The test results including the cable lose.



4.4. 20dB Bandwidth

TEST CONFIGURATION

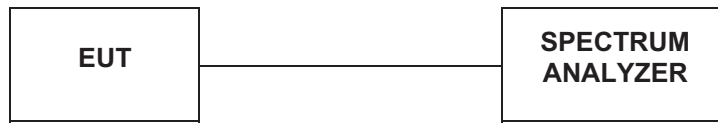

TEST PROCEDURE

The transmitter output was connected to the spectrum analyzer through an attenuator. The bandwidth of the fundamental frequency was measured by spectrum analyzer with RBW=30 KHz and VBW=100KHz. The 20dB bandwidth is defined as the total spectrum the power of which is higher than peak power minus 20dB.

LIMIT

For frequency hopping systems operating in the 2400MHz-2483.5MHz no limit for 20dB bandwidth.

TEST RESULTS

Modulation	Channel	20dB bandwidth (MHz)	99% OBW (MHz)	Result
GFSK	CH00	1.015	0.88213	Pass
	CH39	0.9674	0.89060	
	CH78	1.031	0.89752	
$\pi/4$ DQPSK	CH00	1.287	1.1800	
	CH39	1.293	1.1814	
	CH78	1.286	1.1817	
8DPSK	CH00	1.294	1.1899	
	CH39	1.294	1.2005	
	CH78	1.309	1.1956	



GFSK Modulation



CH00

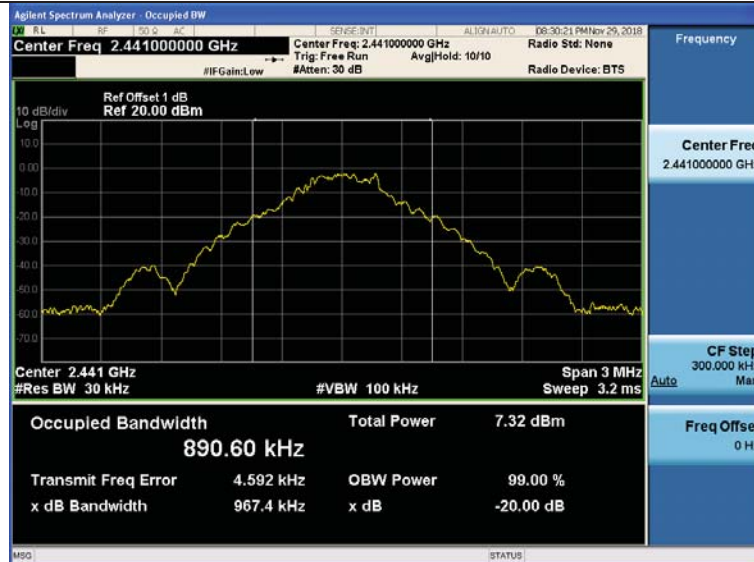

CH39

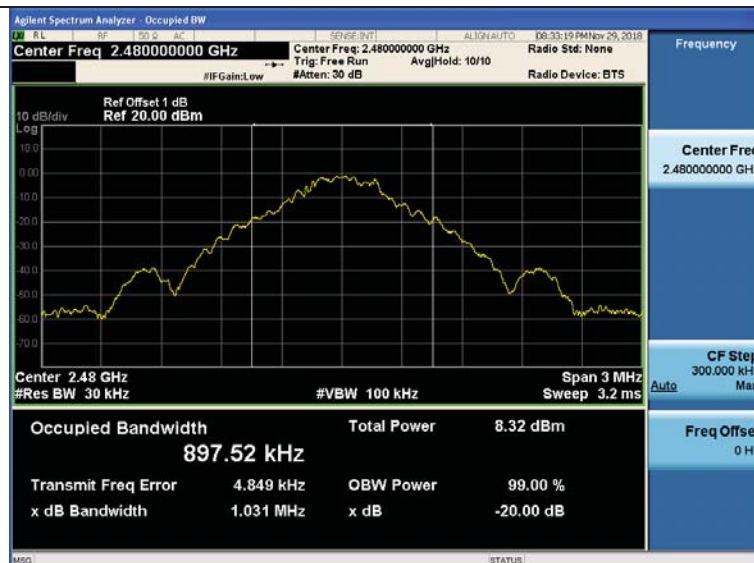

CH78



$\pi/4$ DQPSK Modulation

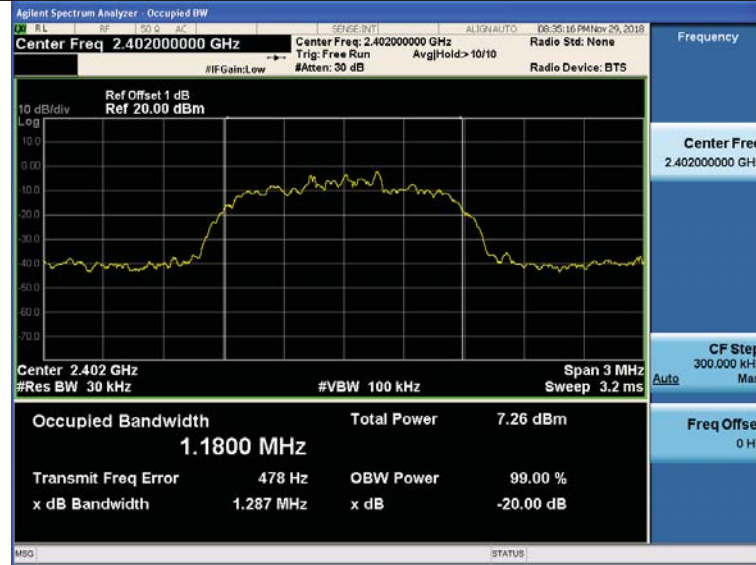

CH00

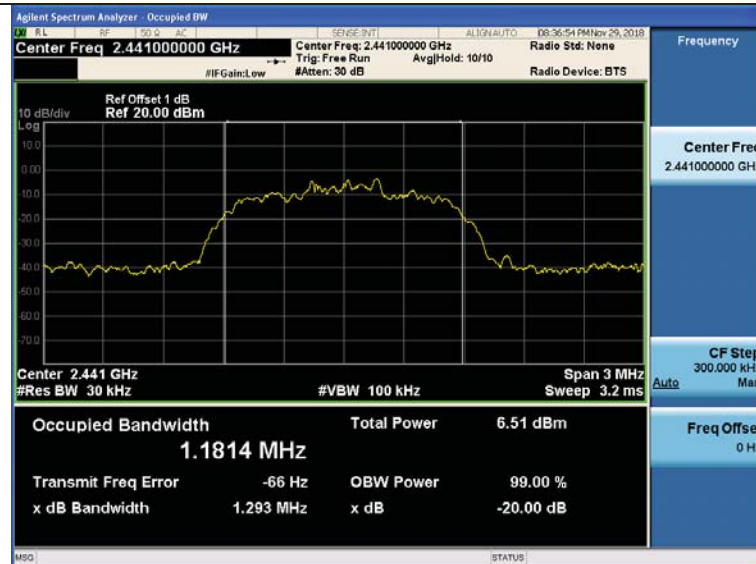

CH39

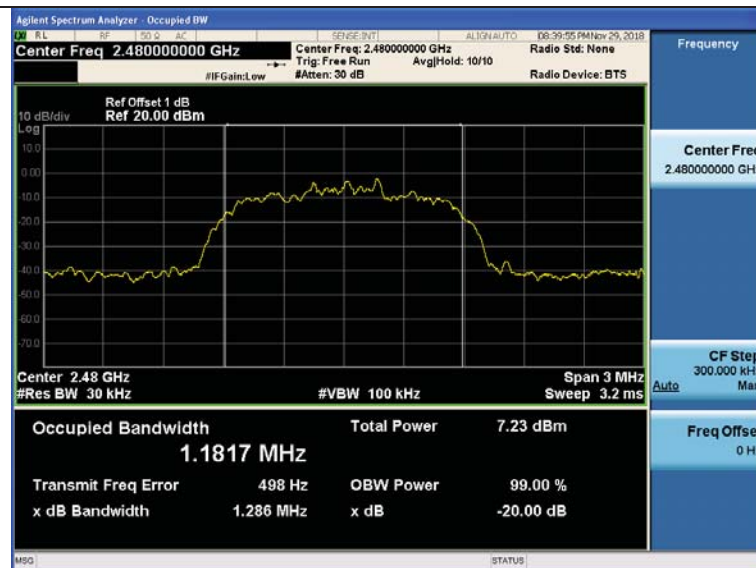

CH78



8DPSK Modulation

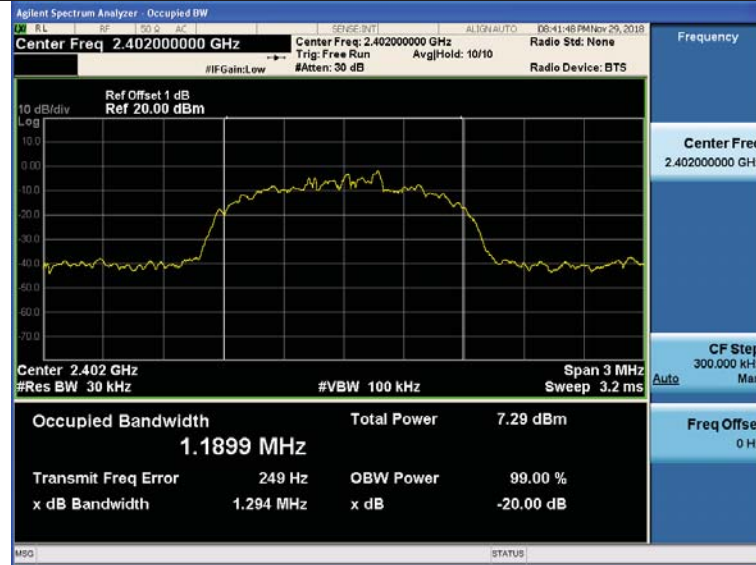

CH00

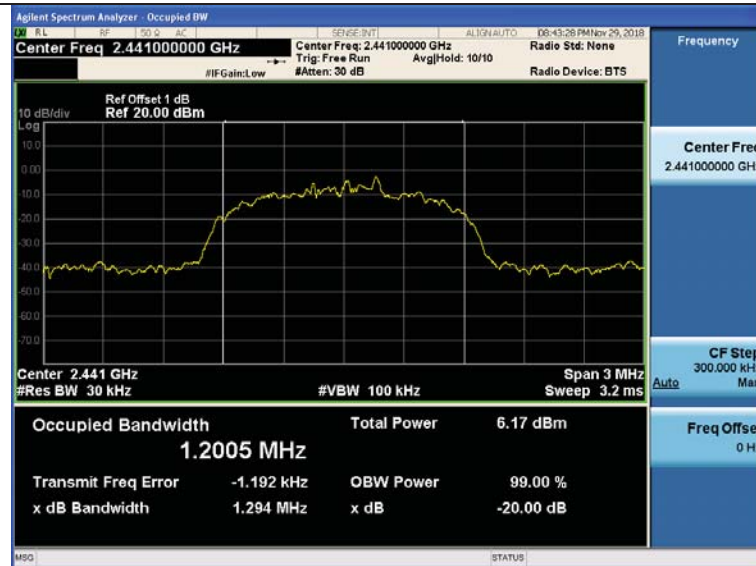

CH39



CH78



4.5. Frequency Separation

TEST CONFIGURATION



TEST PROCEDURE

The transmitter output was connected to the spectrum analyzer through an attenuator. The bandwidth of the fundamental frequency was measured by spectrum analyzer with RBW=30 KHz and VBW=100KHz.

LIMIT

According to 15.247(a)(1),frequency hopping systems shall have hopping channel carrier frequencies separated by minimum of 25KHz or the 2/3*20dB bandwidth of the hopping channel, whichever is greater.

TEST RESULTS

4.5.1 GFSK Test Mode

Modulation	Channel	Channel Separation (MHz)	20dB Bandwidth (MHz)	Limit(MHz) 2/3* 20dB BW	Result
GFSK	CH38	0.916	1.031	0.687	Pass
	CH39				
π/4DQPSK	CH38	1.043	1.293	0.862	Pass
	CH39				
8DPSK	CH38	0.992	1.309	0.873	Pass
	CH39				

Remark: We have tested all mode at high, middle and low channel, and recorded worst case at middle



GFSK Modulation



$\pi/4$ DQPSK Modulation

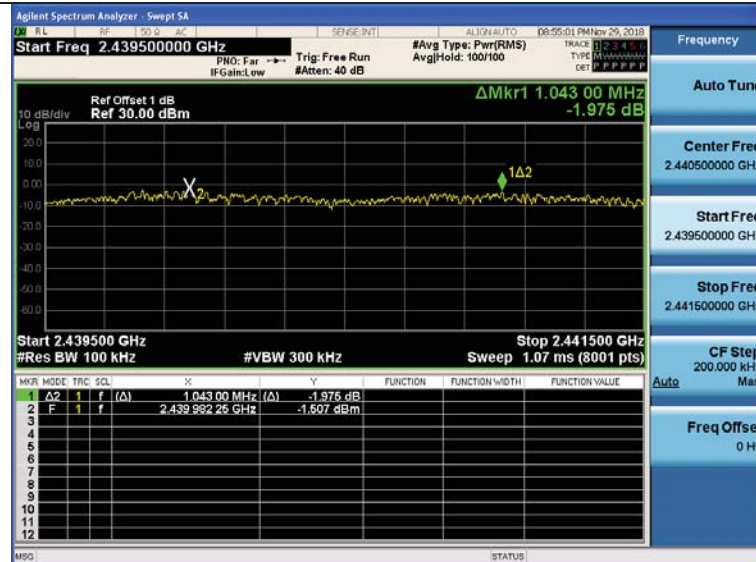

8DPSK Modulation

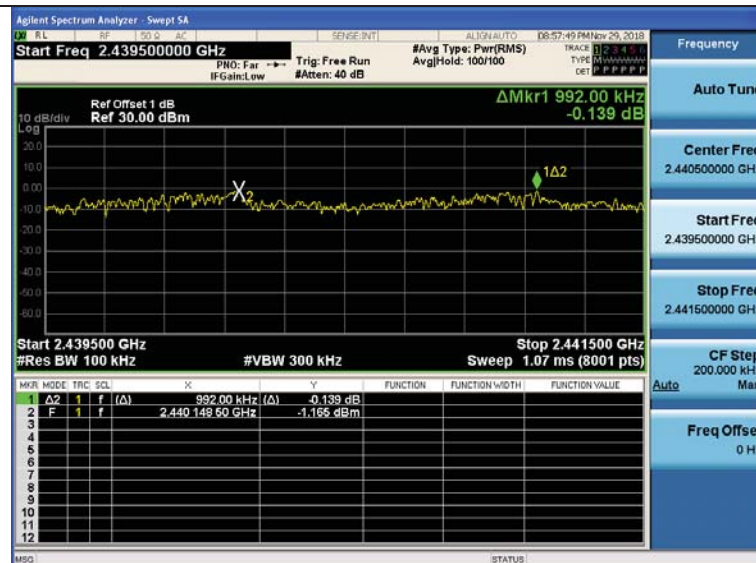

4.6. Band Edge Compliance of RF Emission

TEST REQUIREMENT

In any 100 kHz bandwidth outside the frequency band in which the spread spectrum or digitally modulated intentional radiator is operating, the radio frequency power that is produced by the intentional radiator shall be at least 20 dB below that in the 100 kHz bandwidth within the band that contains the highest level of the desired power, based on either an RF conducted or a radiated measurement, provided the transmitter demonstrates compliance with the peak conducted power limits. If the transmitter complies with the conducted power limits based on the use of RMS averaging over a time interval, as permitted under paragraph (b)(3) of this section, the attenuation required under this paragraph shall be 30 dB instead of 20 dB. Attenuation below the general limits specified in §15.209(a) is not required. In addition, radiated emissions which fall in the restricted bands, as defined in §15.205(a), must also comply with the radiated emission limits specified in §15.209(a) (see §15.205(c)).

TEST CONFIGURATION

For Radiated

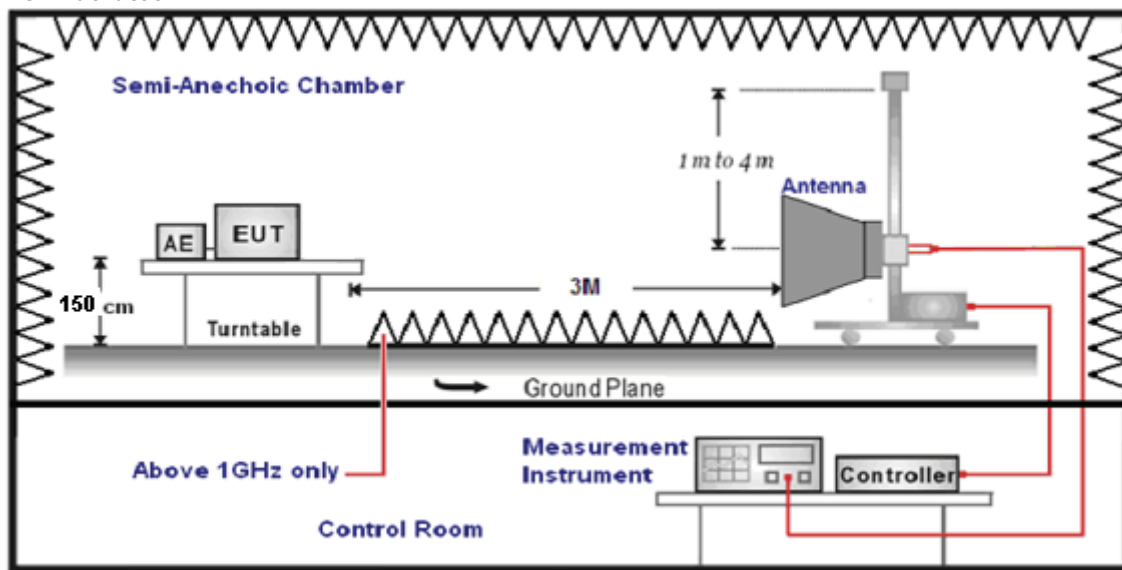

For Conducted

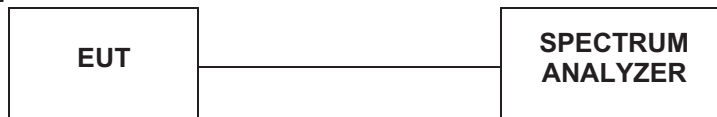

TEST PROCEDURE

1. The EUT was placed on a turn table which is 1.5m above ground plane.
2. Maximum procedure was performed by raising the receiving antenna from 1m to 4m and rotating the turn table from 0° to 360° to acquire the highest emissions from EUT.
3. And also, each emission was to be maximized by changing the polarization of receiving antenna both horizontal and vertical.
4. Repeat above procedures until all frequency measurements have been completed..
5. The distance between test antenna and EUT was 3 meter:
6. Setting test receiver/spectrum as following table states:

Test Frequency range	Test Receiver/Spectrum Setting	Detector
1GHz-40GHz	Peak Value: RBW=1MHz/VBW=3MHz, Sweep time=Auto Average Value: RBW=1MHz/VBW=10Hz, Sweep time=Auto	Peak

LIMIT

Below -20dB of the highest emission level in operating band.

Radiated emissions which fall in the restricted bands, as defined in § 15.205(a), must also comply with the radiated emission limits specified in § 15.209(a)

**TEST RESULTS****4.6.1 For Radiated Bandedge Measurement**

Remark: GFSK, Pi/4 DQPSK and 8DPSK all have been tested, only worse case GFSK is reported.

Operation Mode: GFSK TX Low channel(2402MHz)

Horizontal (Worst case)

Frequency (MHz)	Meter Reading (dB μ V)	Factor (dB)	Emission Level (dB μ V/m)	Limits (dB μ V/m)	Margin (dB)	Detector Type
2390	55.57	-5.81	49.76	74	-24.24	peak
2390	38.47	-5.81	32.66	54	-21.34	AVG
Remark: Factor = Antenna Factor + Cable Loss – Pre-amplifier.						

Vertical:

Frequency (MHz)	Meter Reading (dB μ V)	Factor (dB)	Emission Level (dB μ V/m)	Limits (dB μ V/m)	Margin (dB)	Detector Type
2390	57.69	-5.81	51.88	74	-22.12	peak
2390	40.71	-5.81	34.9	54	-19.1	AVG
Remark: Factor = Antenna Factor + Cable Loss – Pre-amplifier.						

Operation Mode: GFSK TX High channel (2480MHz)

Horizontal (Worst case)

Frequency (MHz)	Meter Reading (dB μ V)	Factor (dB)	Emission Level (dB μ V/m)	Limits (dB μ V/m)	Margin (dB)	Detector Type
2483.5	56.37	-5.65	50.72	74	-23.28	peak
2483.5	40.42	-5.65	34.77	54	-19.23	AVG
Remark: Factor = Antenna Factor + Cable Loss – Pre-amplifier.						

Vertical:

Frequency (MHz)	Meter Reading (dB μ V)	Factor (dB)	Emission Level (dB μ V/m)	Limits (dB μ V/m)	Margin (dB)	Detector Type
2483.5	57.68	-5.65	52.03	74	-21.97	peak
2483.5	41.75	-5.65	36.1	54	-17.9	AVG
Remark: Factor = Antenna Factor + Cable Loss – Pre-amplifier.						
Remark: All the other emissions not reported were too low to read and deemed to comply with FCC limit.						



4.6.2 For Conducted Bandedge Measurement

GFSK

Frequency (MHz)	Delta Peak to Band emission (dBc)	Hopping Mode	Limit (dBc)	Verdict
2400.00	-57.717	OFF	-20	PASS
2400.00	-60.866	ON	-20	PASS
2483.50	-60.239	OFF	-20	PASS
2483.50	-61.425	ON	-20	PASS

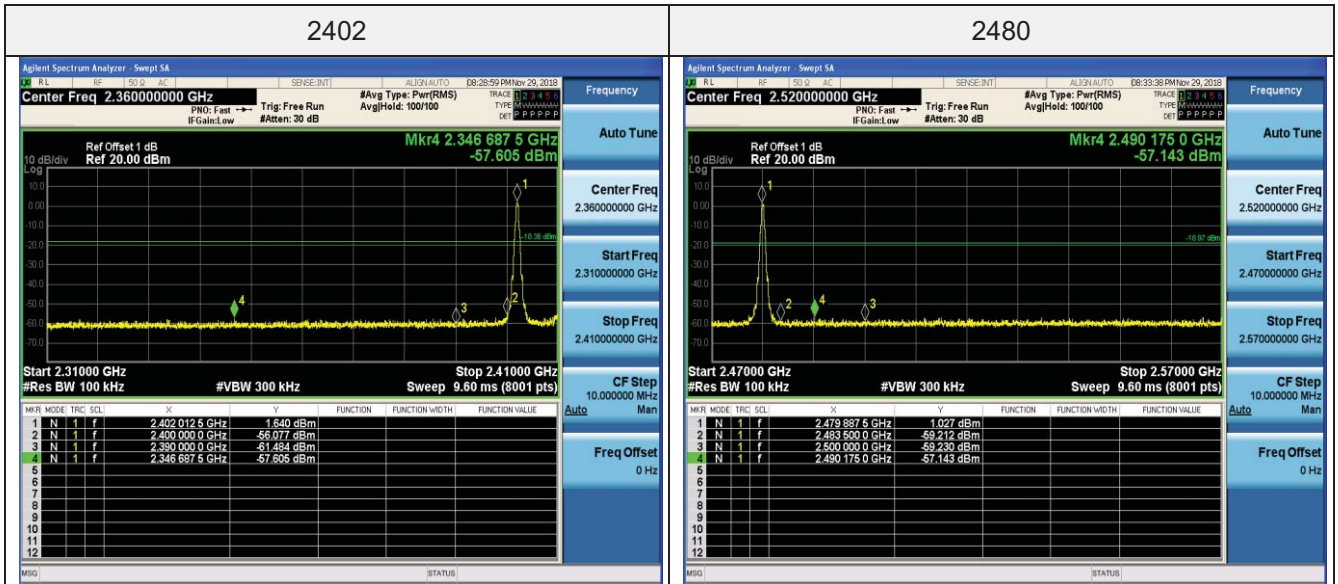

Hopping Off

Hopping Off

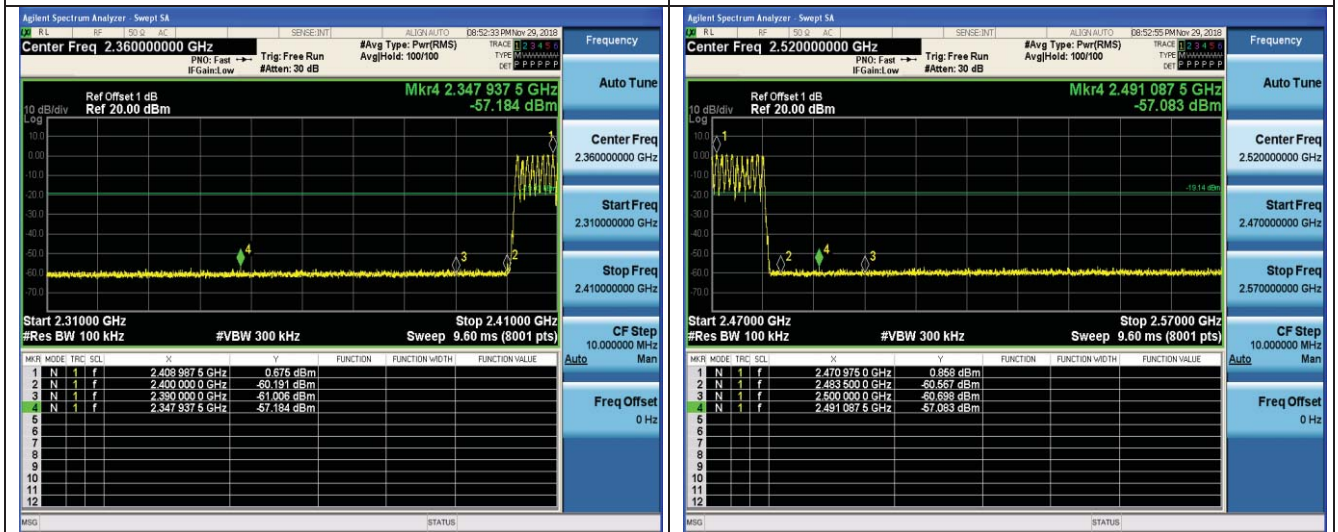

Hopping On

Hopping On



$\pi/4$ DQPSK

Frequency (MHz)	Delta Peak to Band emission (dBc)	Hopping Mode	Limit (dBc)	Verdict
2400.00	-56.125	OFF	-20	PASS
2400.00	-60.507	ON	-20	PASS
2483.50	-59.881	OFF	-20	PASS
2483.50	-61.098	ON	-20	PASS

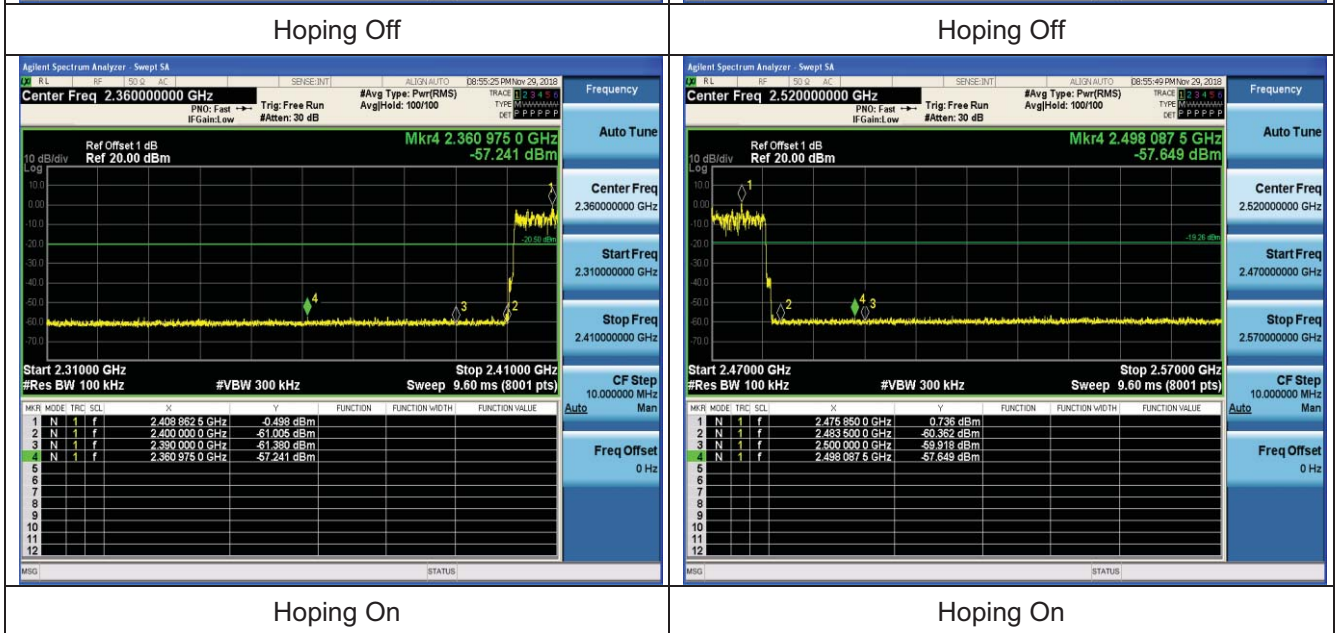
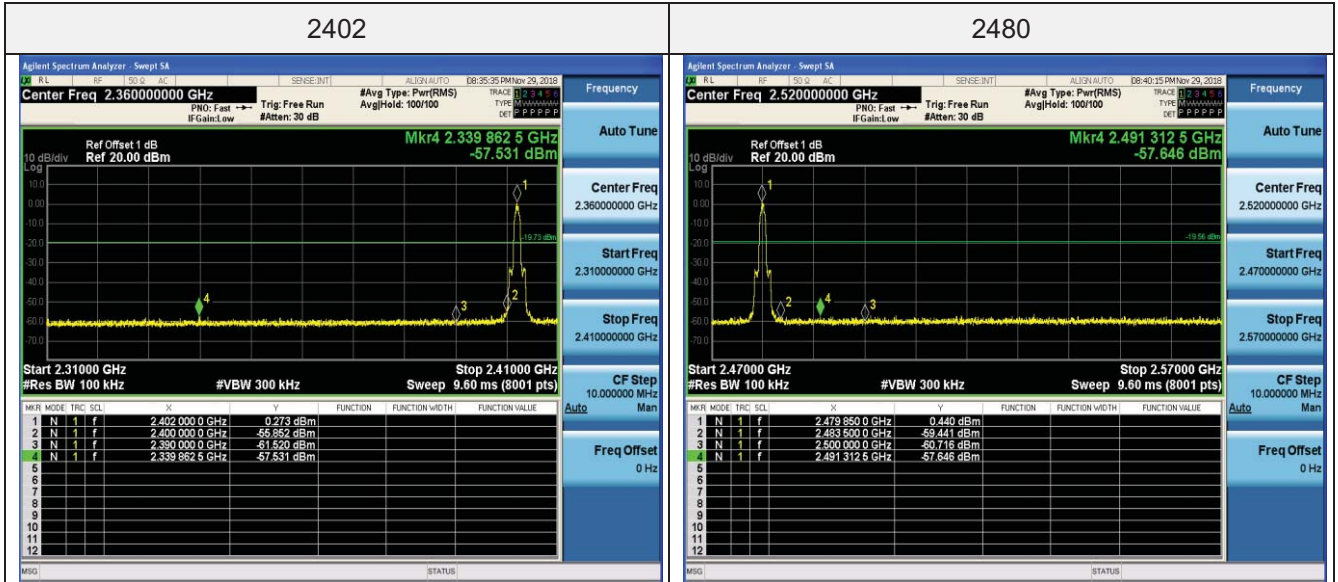



8DPSK

Frequency (MHz)	Delta Peak to Band emission (dBc)	Hopping Mode	Limit (dBc)	Verdict
2400.00	-55.767	OFF	-20	PASS
2400.00	-59.484	ON	-20	PASS
2483.50	-60.762	OFF	-20	PASS
2483.50	-59.410	ON	-20	PASS

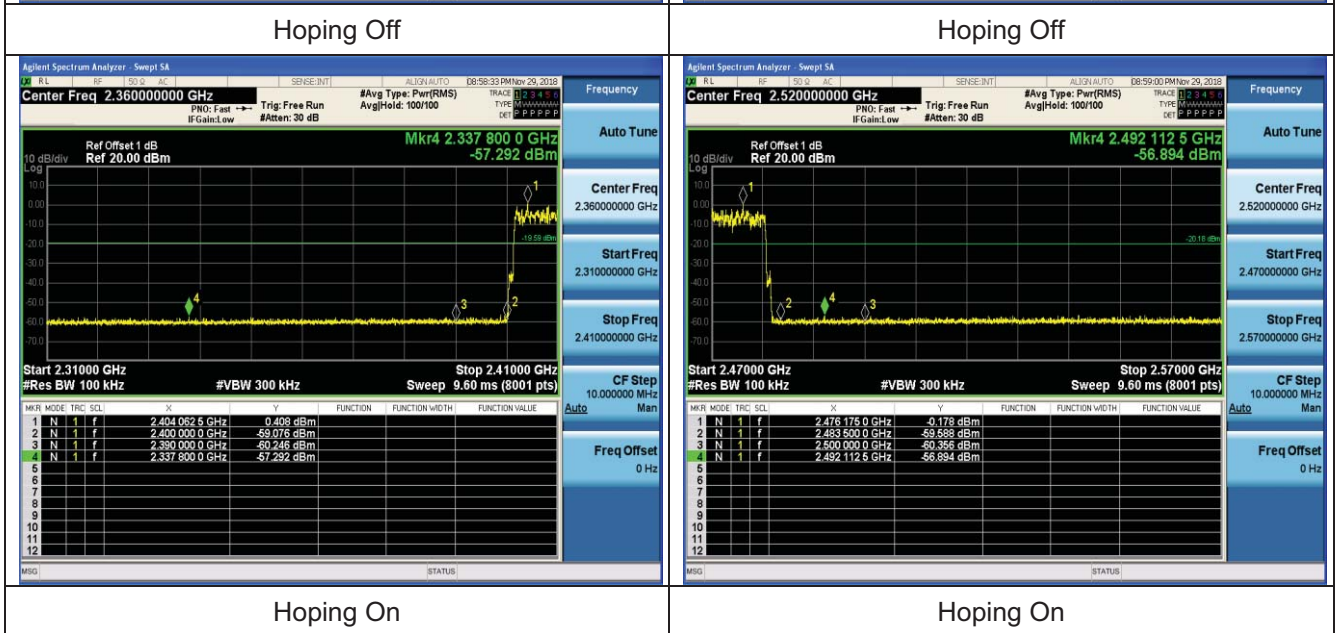
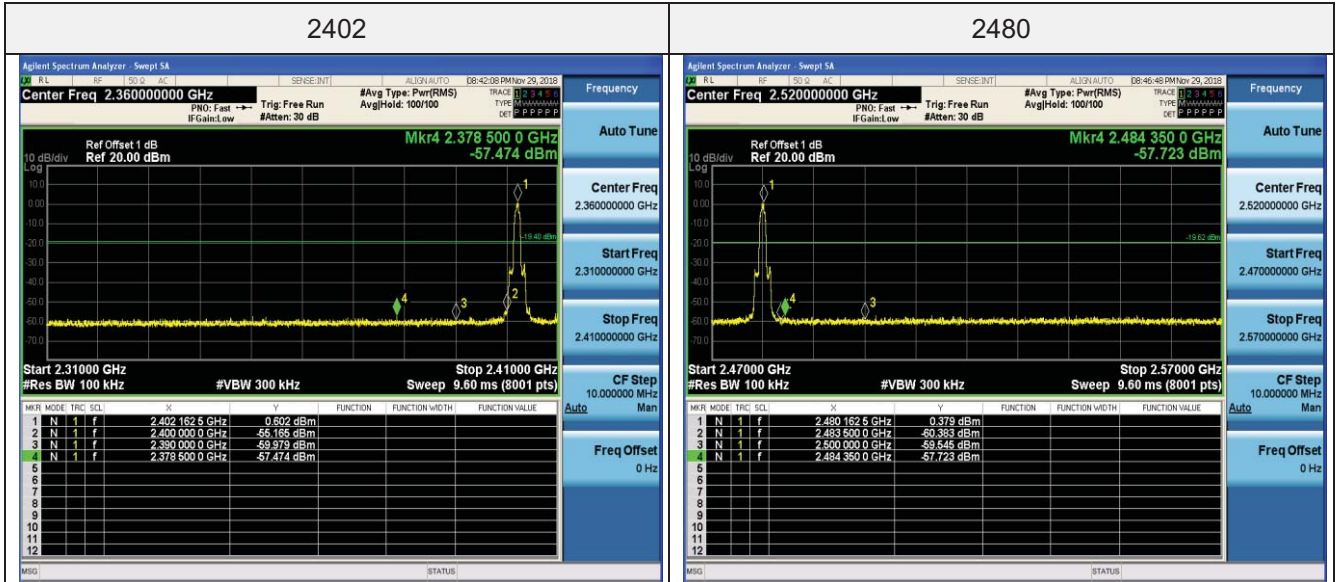



4.7. Spurious RF Conducted Emission

TEST CONFIGURATION

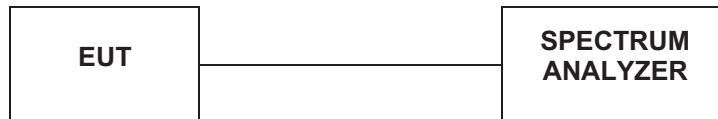

TEST PROCEDURE

The Spurious RF conducted emissions compliance of RF radiated emission should be measured by following the guidance in ANSI C63.10-2013 with respect to maximizing the emission by rotating the EUT, measuring the emission while the EUT is situated in three orthogonal planes (if appropriate), adjusting the measurement antenna height and polarization etc. Set RBW=100kHz and VBW= 300KHz to measure the peak field strength, and measure frequency range from 9KHz to 25GHz.

LIMIT

1. Below -20dB of the highest emission level in operating band.
2. Fall in the restricted bands listed in section 15.205. The maximum permitted average field strength is listed in section 15.209.

TEST RESULTS

Remark: The measurement frequency range is from 30MHz to the 10th harmonic of the fundamental frequency. The lowest, middle and highest channels are tested to verify the spurious emissions and bandedge measurement data.

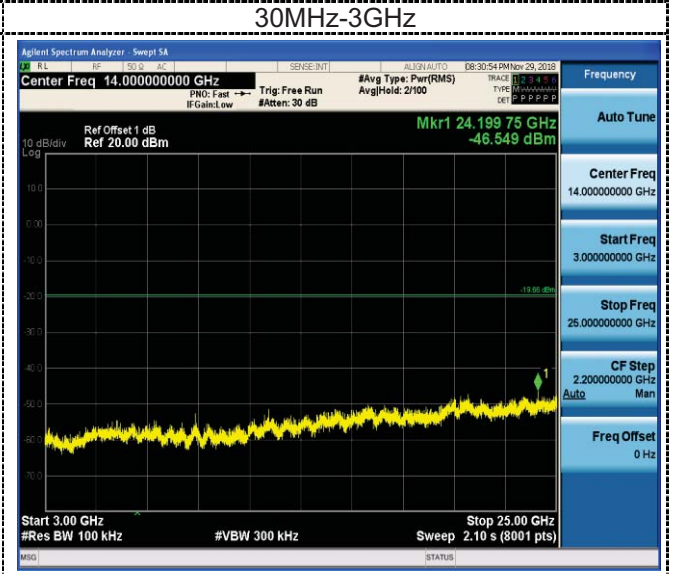
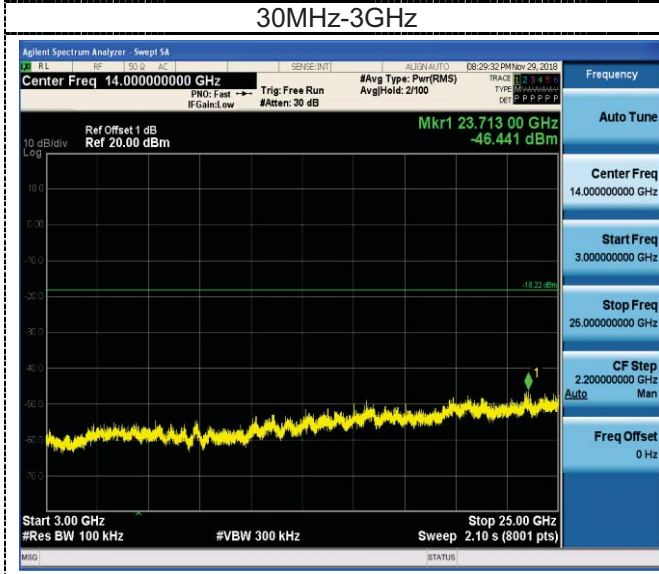
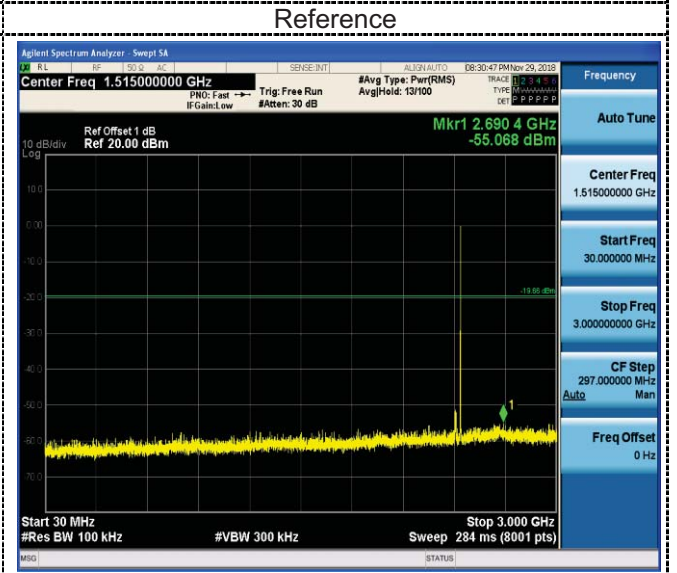
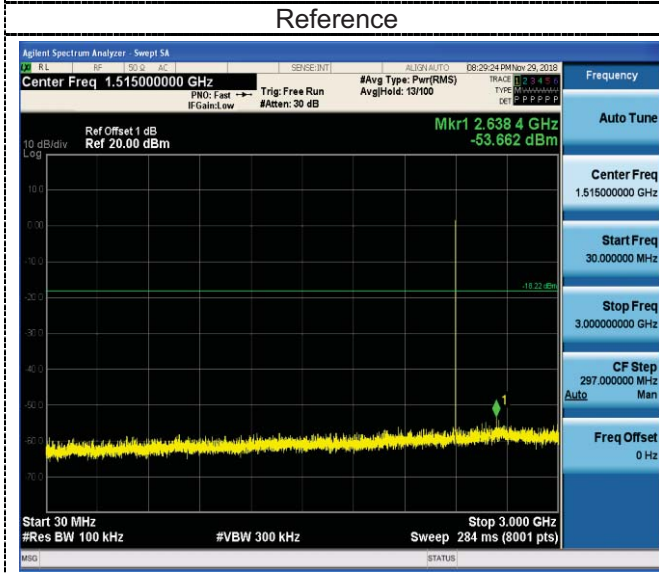
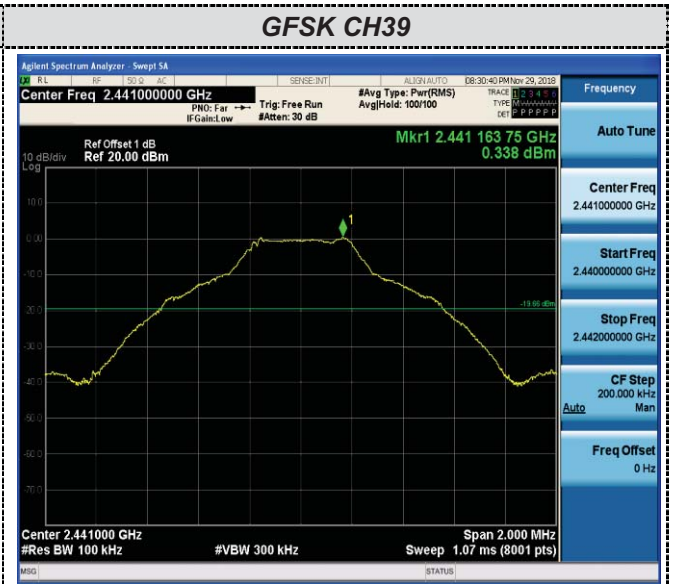
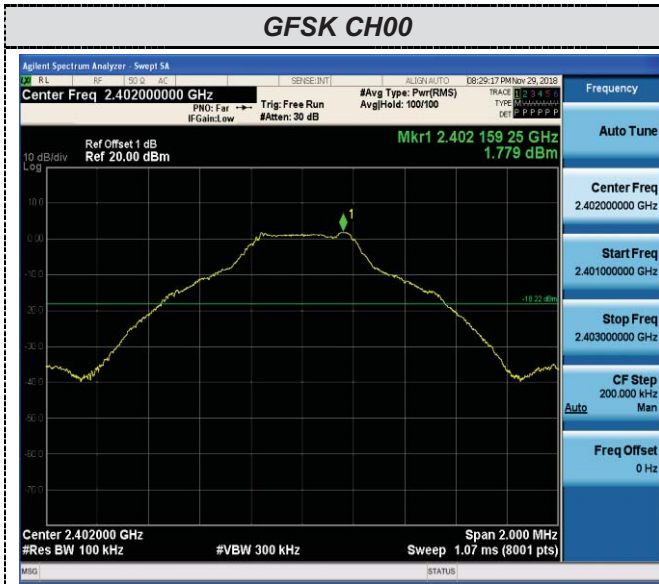

3GHz-25GHz

3GHz-25GHz

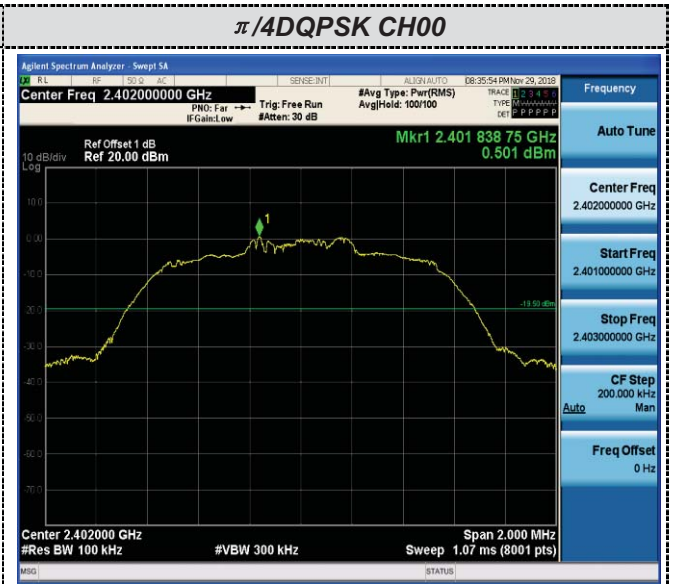
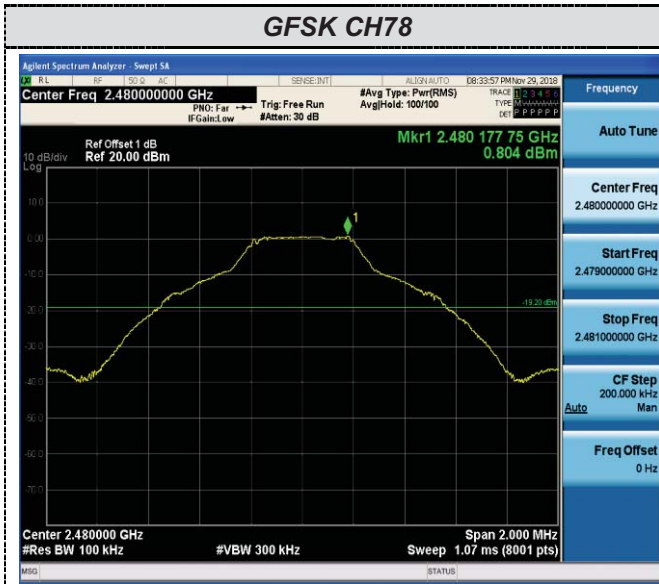

Reference

Reference

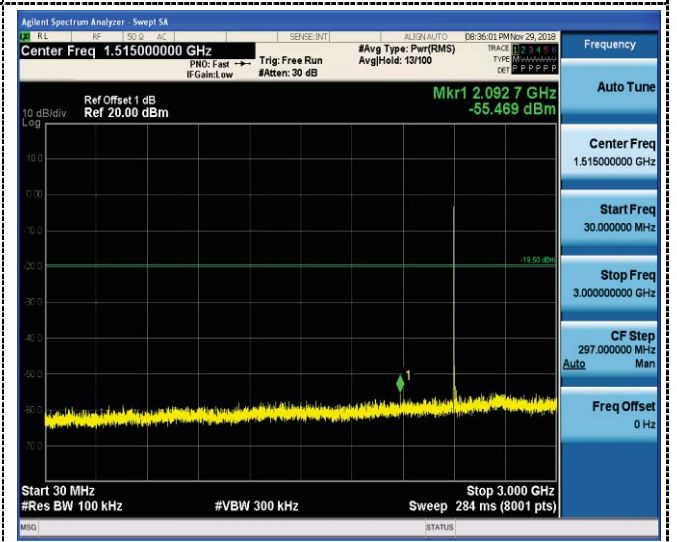
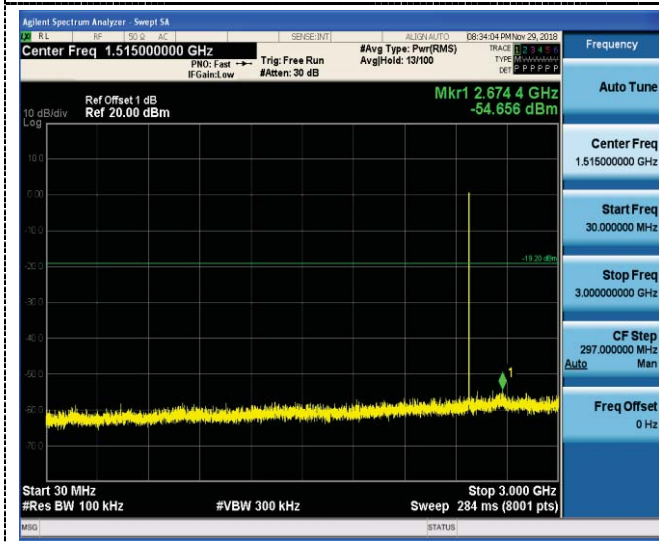

30MHz-3GHz

30MHz-3GHz

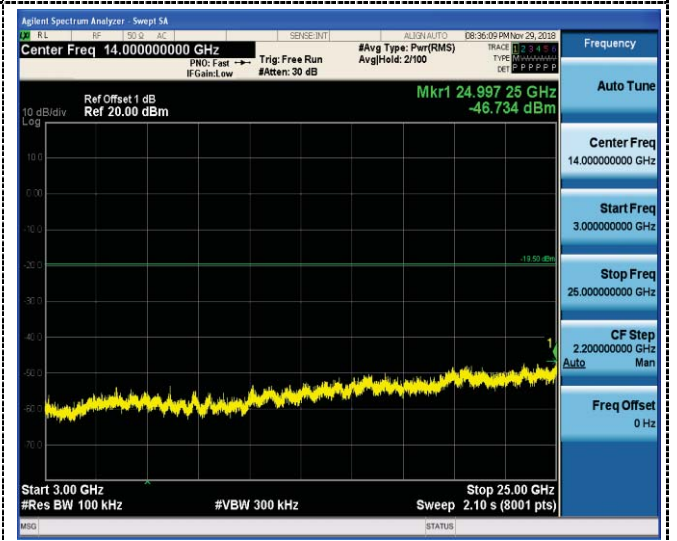
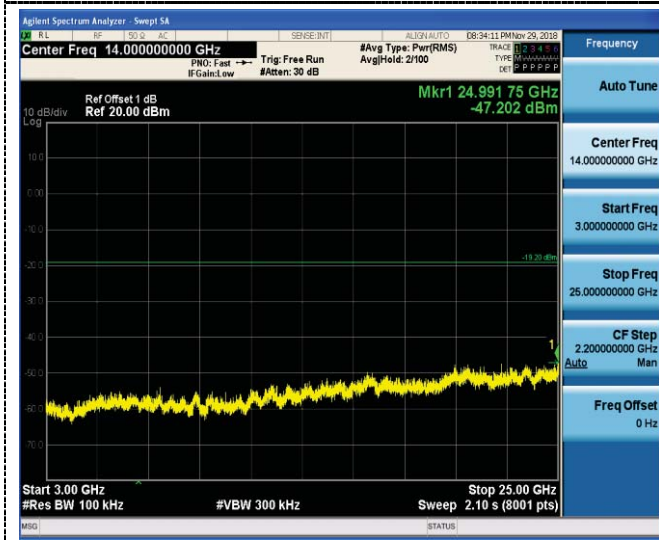

3GHz-25GHz

3GHz-25GHz

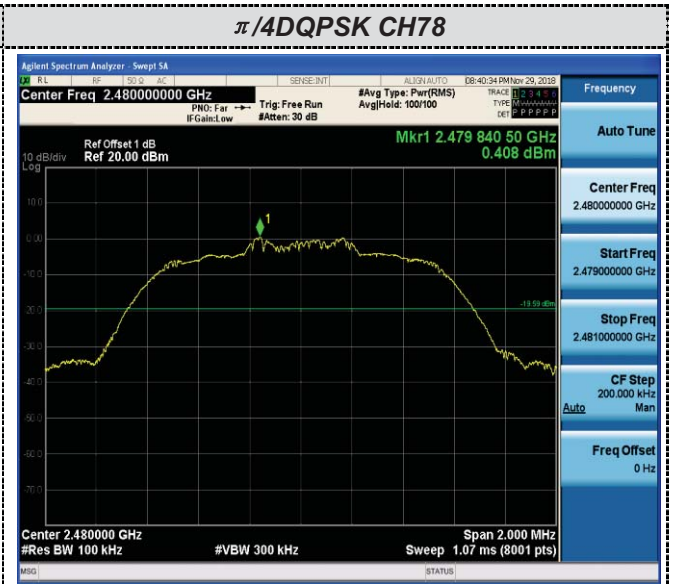
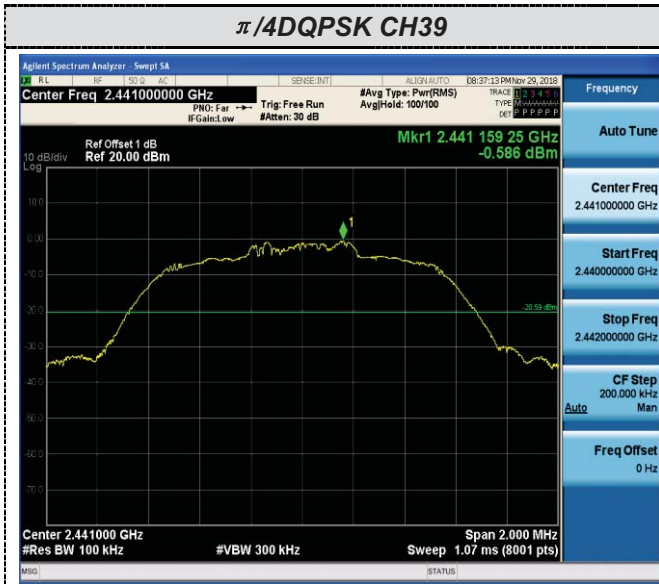

Reference

Reference

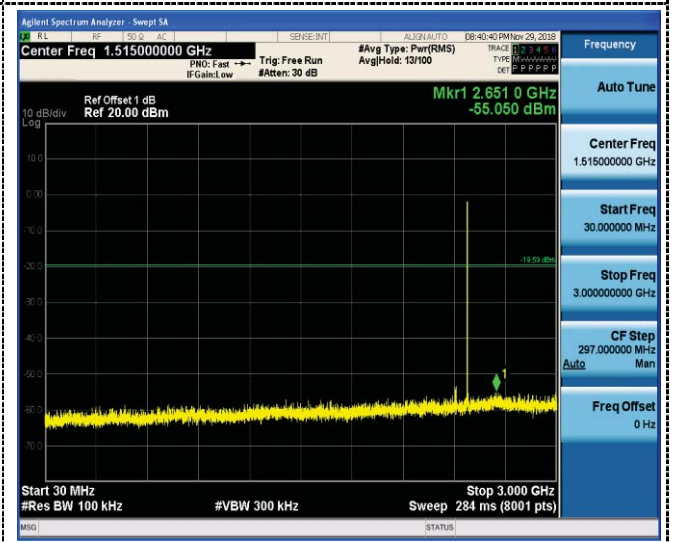
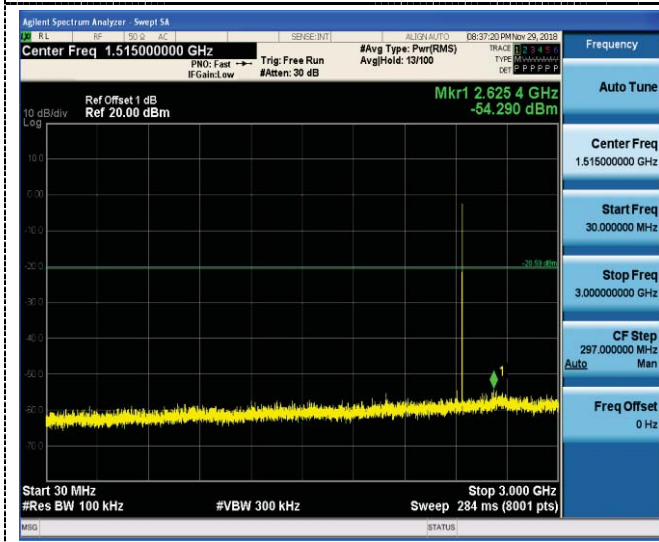

30MHz-3GHz

30MHz-3GHz

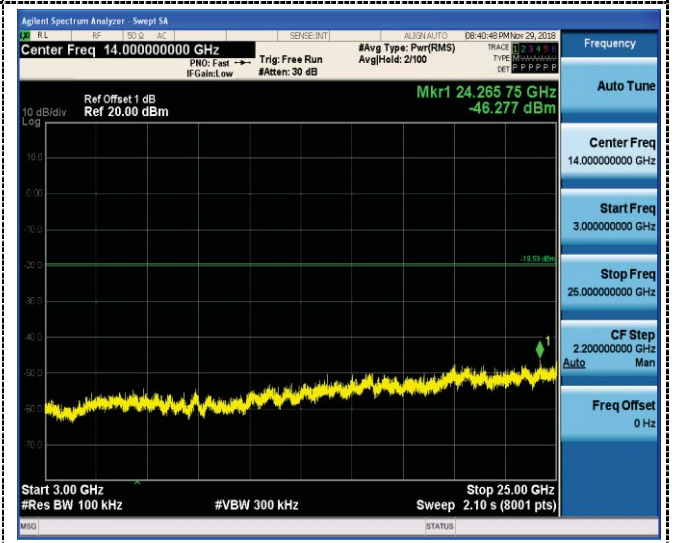
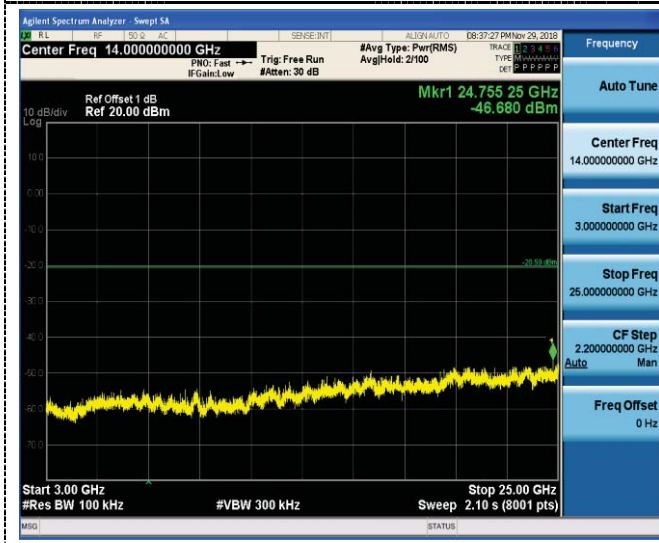

3GHz-25GHz

3GHz-25GHz



8DPSK CH00

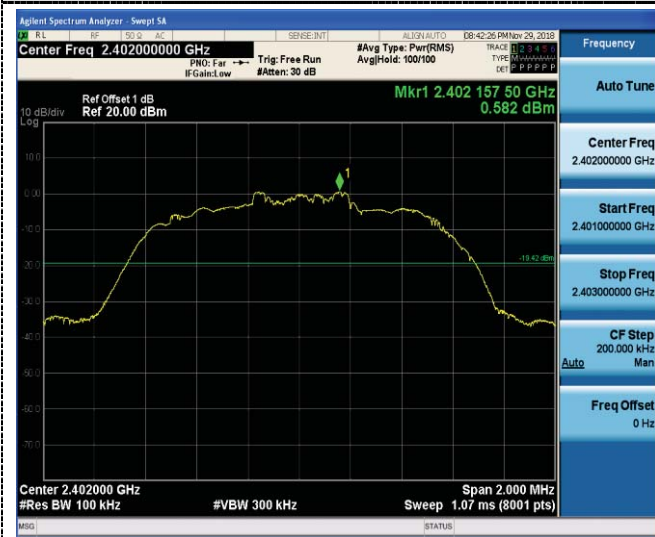

8DPSK CH39

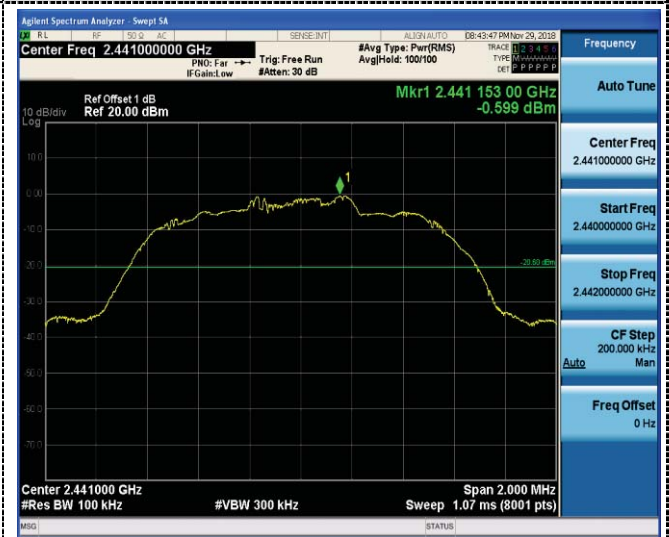

Reference

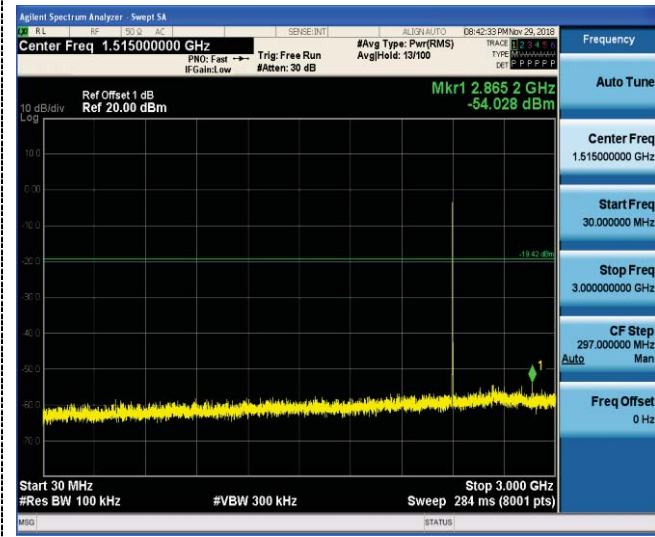

Reference

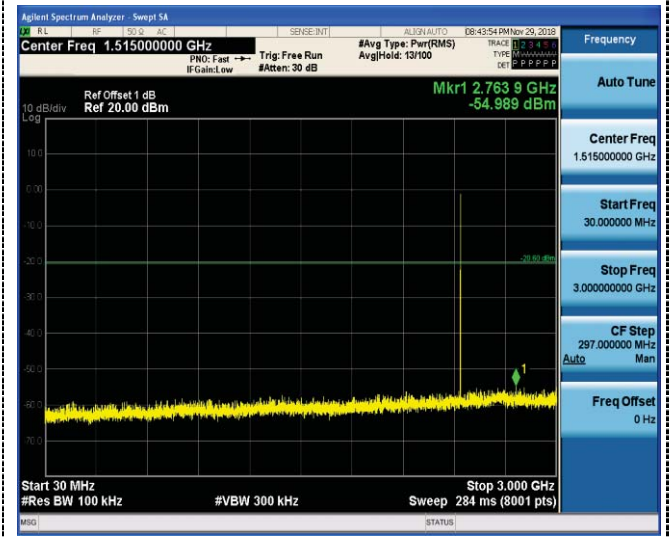

30MHz-3GHz

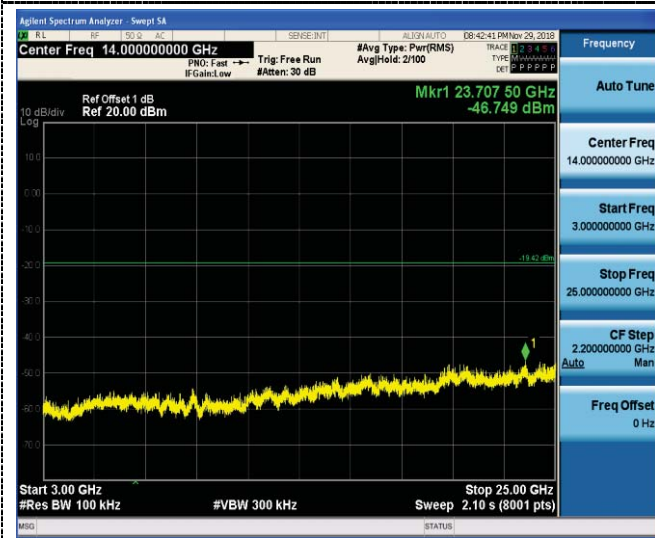

30MHz-3GHz

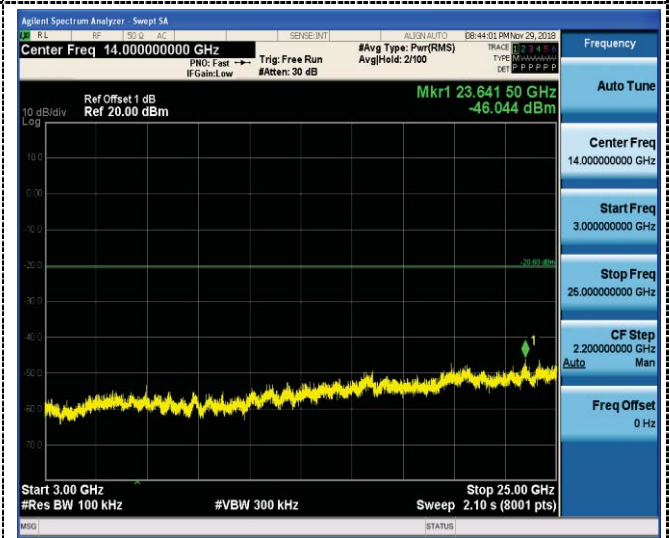

3GHz-25GHz

3GHz-25GHz



8DPSK CH78

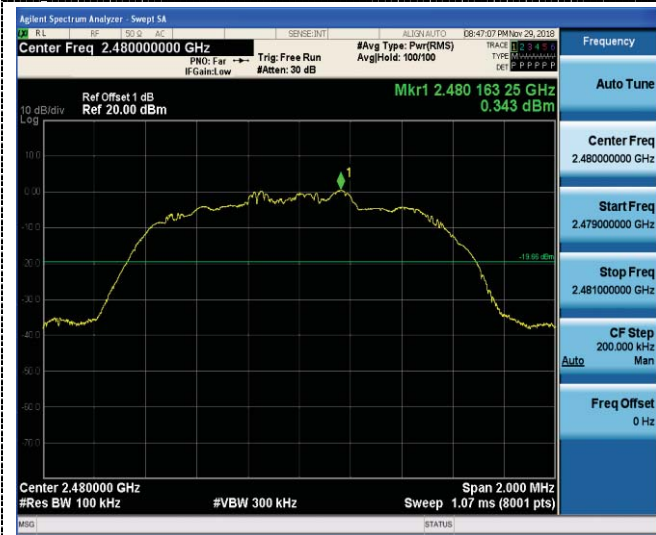

Reference

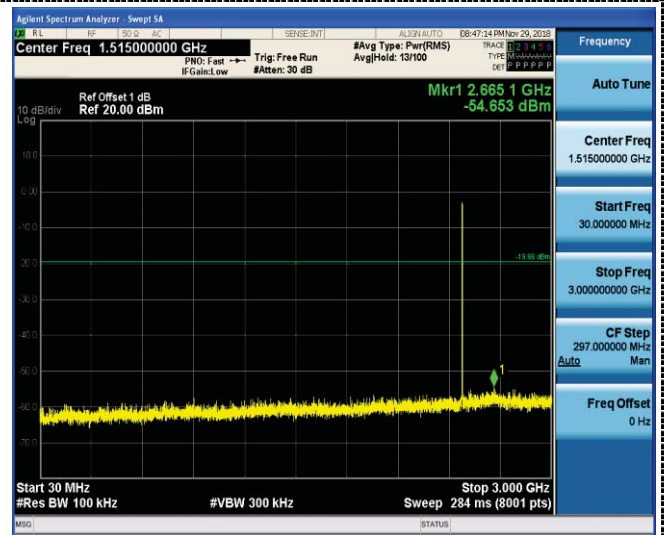

30MHz-3GHz

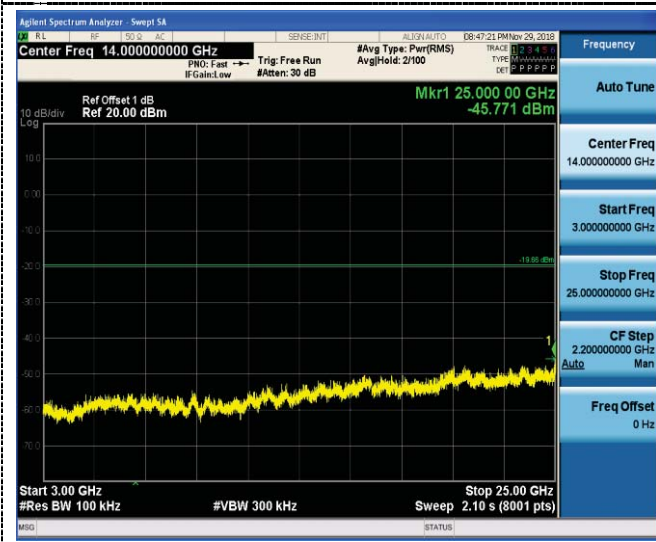

3GHz-25GHz



4.8. Number of hopping frequency

TEST CONFIGURATION

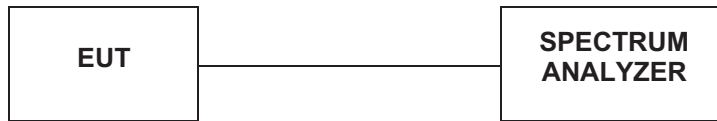

TEST PROCEDURE

The transmitter output was connected to the spectrum analyzer through an attenuator. Set spectrum analyzer start 2400MHz to 2483.5MHz with RBW=1MHz and VBW=3MHz.

LIMIT

Frequency hopping systems in the 2400–2483.5 MHz band shall use at least 15 channels.

Modulation	Number of Hopping Channel	Limit	Result
GFSK	79	≥15	Pass
$\pi/4$ DQPSK	79		
8DPSK	79		

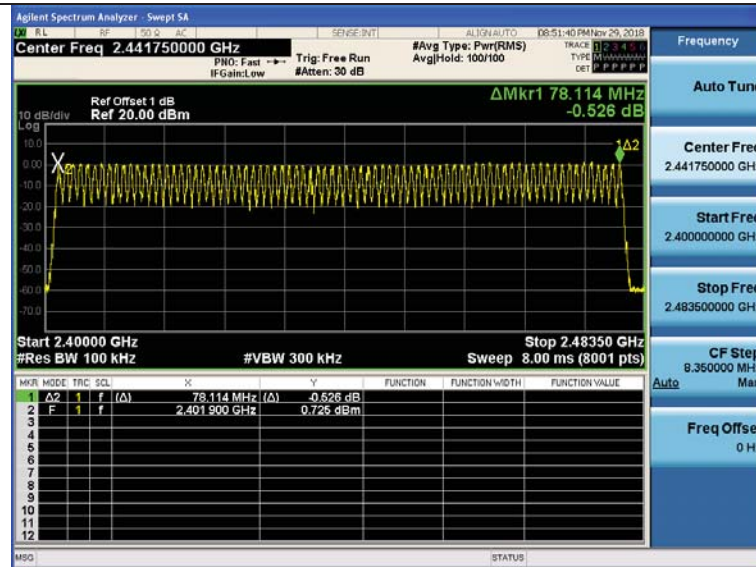

GFSK Modulation

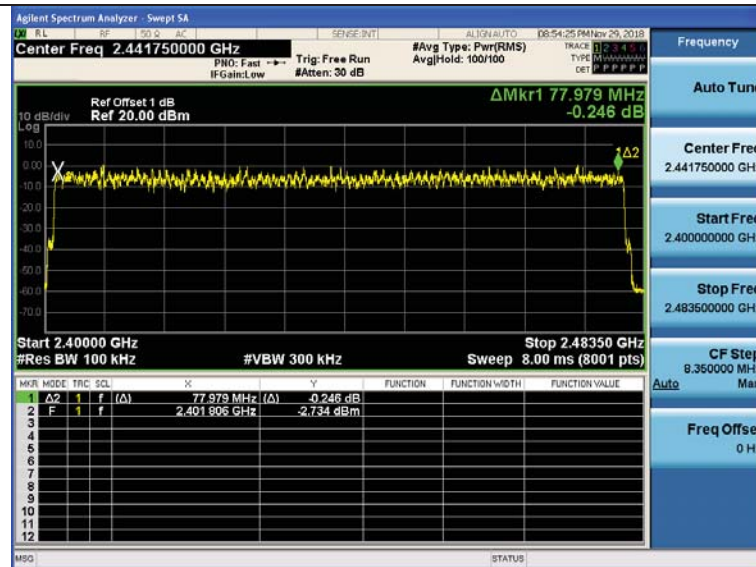

$\pi/4$ DQPSK

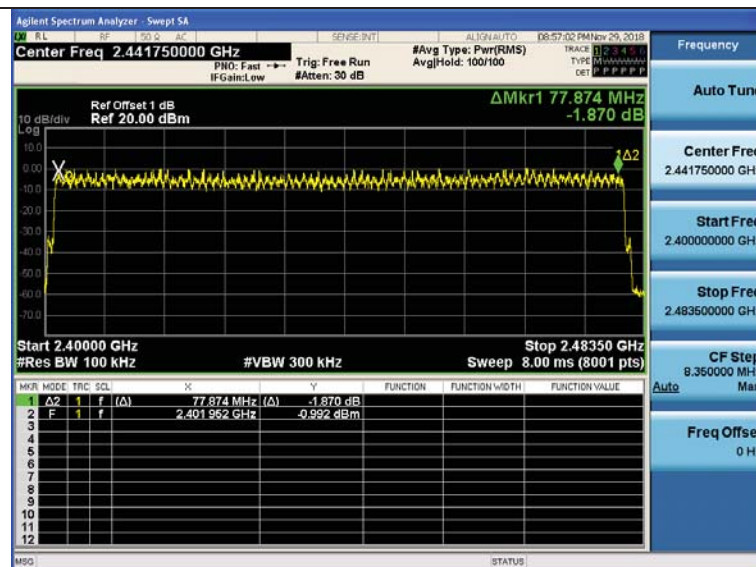

8DPSK Modulation



4.9. Time Of Occupancy(Dwell Time)

TEST CONFIGURATION

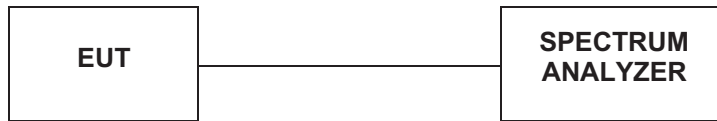

TEST PROCEDURE

The transmitter output was connected to the spectrum analyzer through an attenuator. Set center frequency of spectrum analyzer=operating frequency with RBW=1MHz and VBW=3MHz,Span=0Hz.

LIMIT

The average time of occupancy on any channel shall not be greater than 0.4 seconds within a pe-riod of 0.4 seconds multiplied by the number of hopping channels employed.

TEST RESULTS

Modulation	Packet	Pulse time (ms)	Dwell time (second)	Limit (second)	Result
GFSK	DH1	0.371	0.119	0.40	Pass
	DH3	1.626	0.260		
	DH5	2.874	0.307		
$\pi/4$ DQPSK	DH1	0.379	0.121	0.40	Pass
	DH3	1.629	0.261		
	DH5	2.877	0.307		
8DPSK	3-DH1	0.380	0.122	0.40	Pass
	3-DH3	1.575	0.252		
	3-DH5	2.878	0.307		

Note:

1. We have tested all mode at high,middle and low channel,and recoreded worst case at middle channel.
2. Dwell time=Pulse time (ms) \times (1600 \div 2 \div 79) \times 31.6 Second for DH1, 2-DH1, 3-DH1
Dwell time=Pulse time (ms) \times (1600 \div 4 \div 79) \times 31.6 Second for DH3, 2-DH3, 3-DH3
Dwell time=Pulse time (ms) \times (1600 \div 6 \div 79) \times 31.6 Second for DH5, 2-DH5, 3-DH5



GFSK Modulation

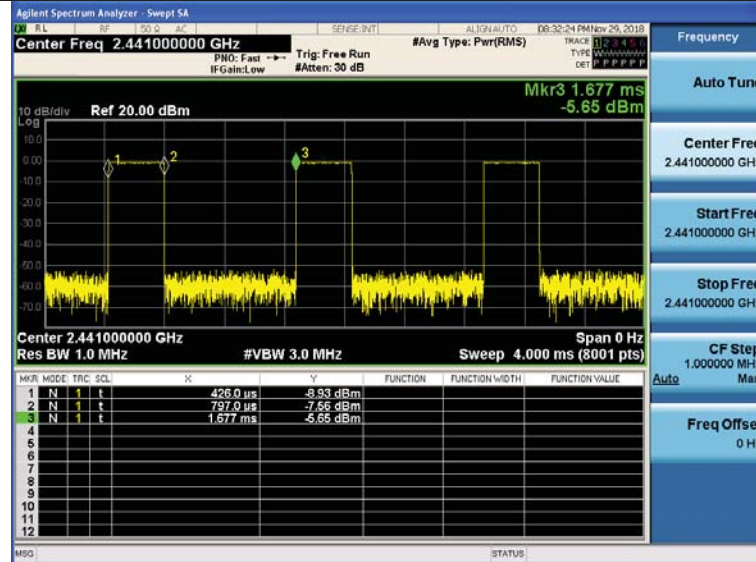

DH1

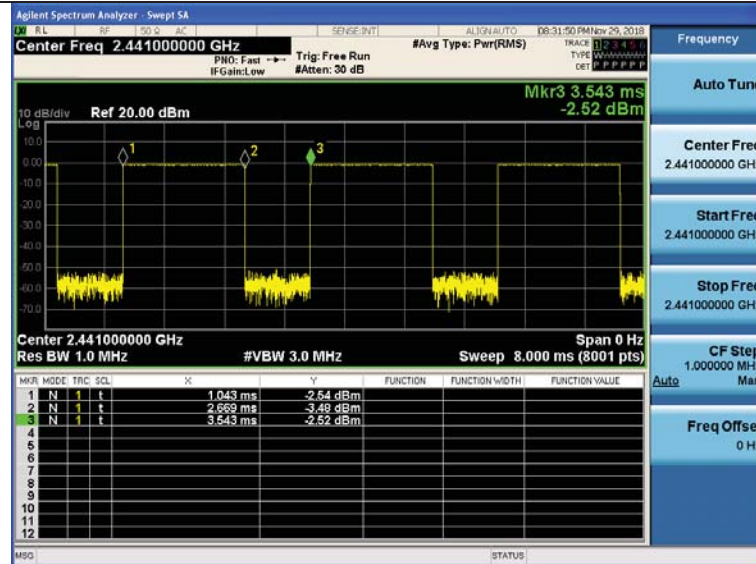

DH3

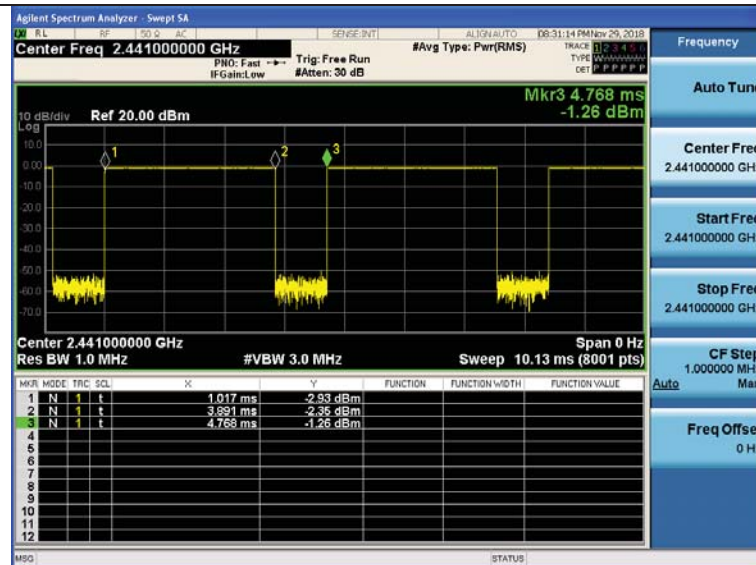

DH5



$\pi/4$ DQPSK Modulation

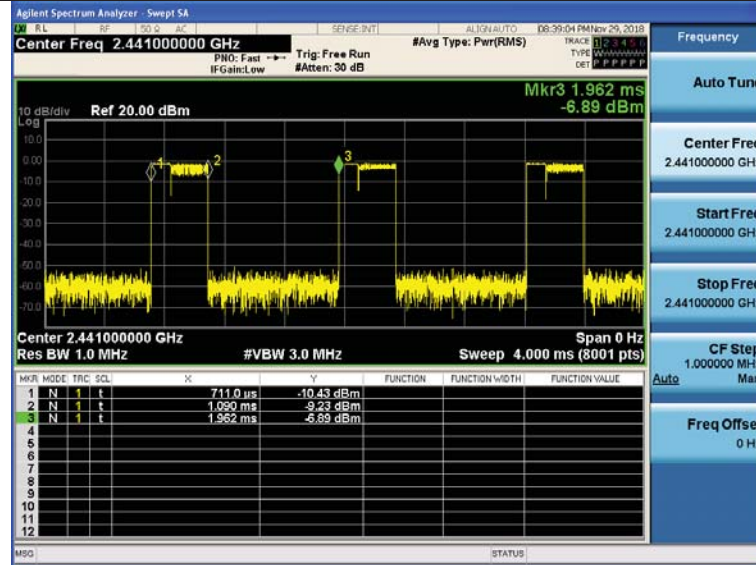

2-DH1

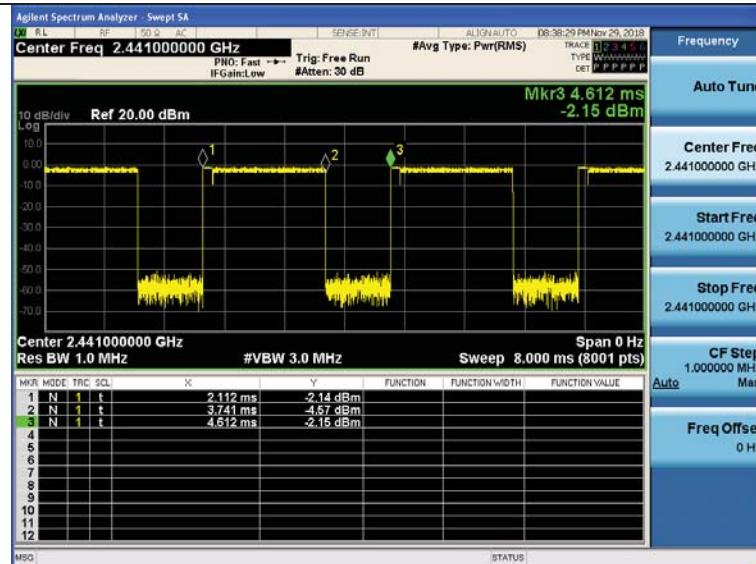

2-DH3

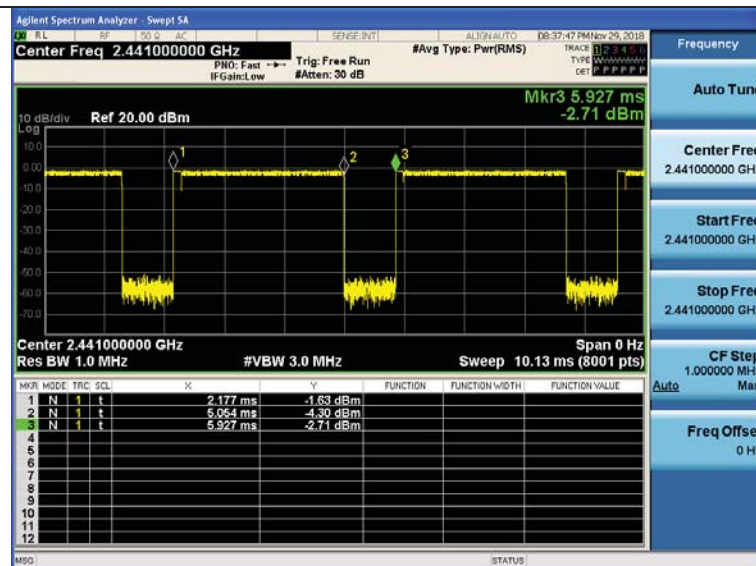

2-DH5



8DPSK Modulation

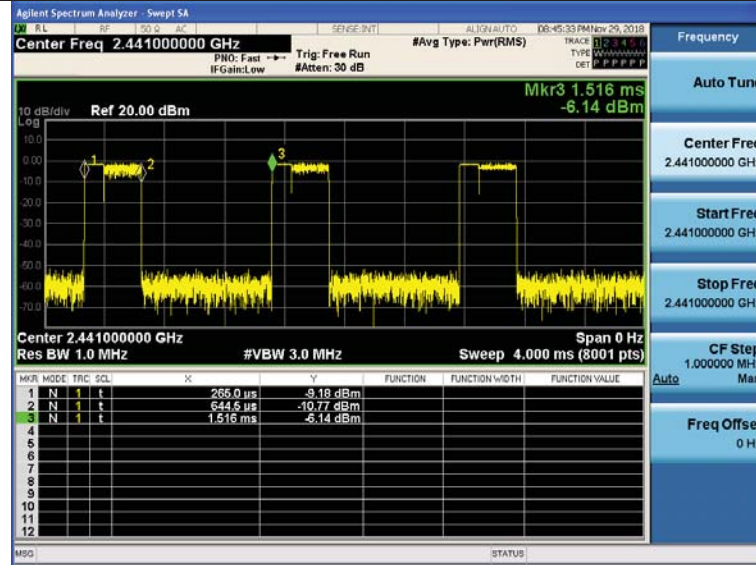

3-DH1

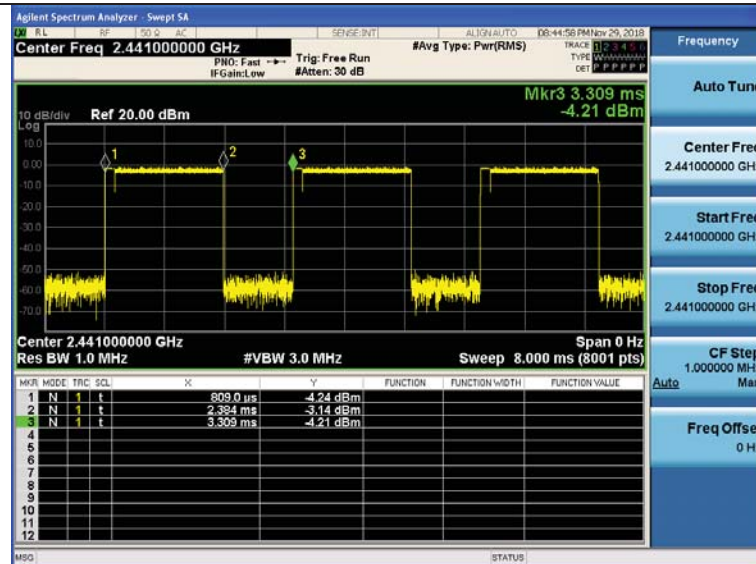

3-DH3

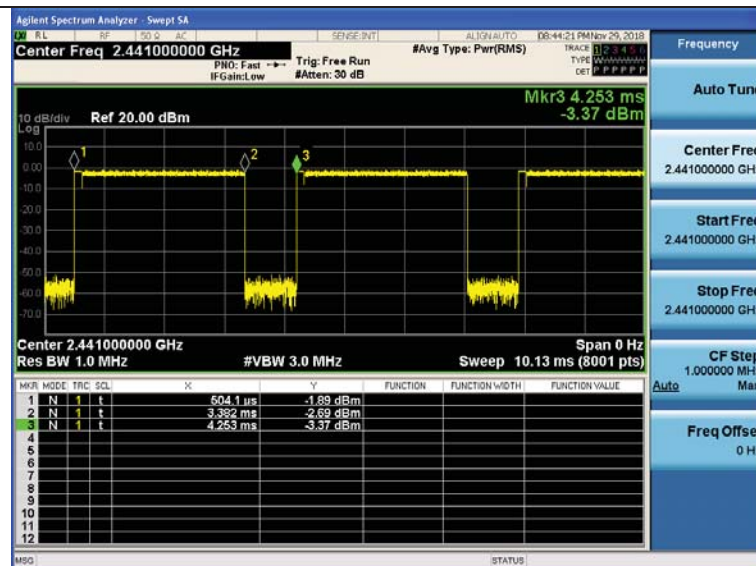

3-DH5



4.10. Pseudorandom Frequency Hopping Sequence

TEST APPLICABLE

For 47 CFR Part 15C section 15.247 (a)(1) requirement:

Frequency hopping systems shall have hopping channel carrier frequencies separated by a minimum of 25 kHz or the 20 dB bandwidth of the hopping channel, whichever is greater. Alternatively, frequency hopping systems operating in the 2400–2483.5 MHz band may have hopping channel carrier frequencies that are separated by 25 kHz or two-thirds of the 20 dB bandwidth of the hopping channel, whichever is greater, provided the systems operate with an output power no greater than 125 mW. The system shall hop to channel frequencies that are selected at the system hopping rate from a pseudo randomly ordered list of hopping frequencies. Each frequency must be used equally on the average by each transmitter. The system receivers shall have input bandwidths that match the hopping channel bandwidths of their corresponding transmitters and shall shift frequencies in synchronization with the transmitted signals.

EUT Pseudorandom Frequency Hopping Sequence Requirement

The pseudorandom frequency hopping sequence may be generated in a nine-stage shift register whose 5th and 9th stage outputs are added in a modulo-two addition stage. And the result is fed back to the input of the first stage. The sequence begins with the first one of 9 consecutive ones, for example: the shift register is initialized with nine ones.

- Number of shift register stages:9
- Length of pseudo-random sequence:2⁹-1=511 bits
- Longest sequence of zeros:8(non-inverted signal)

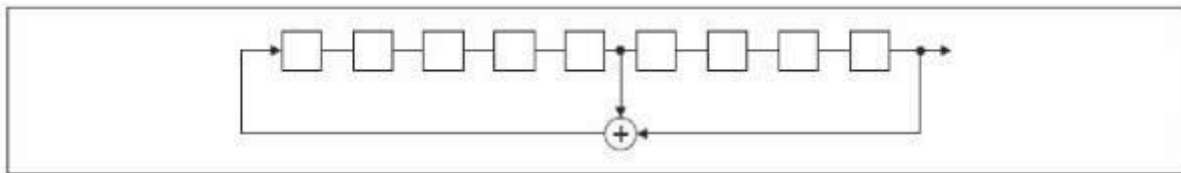

Linear Feedback Shift Register for Generation of the PRBS sequence

An example of pseudorandom frequency hopping sequence as follows:

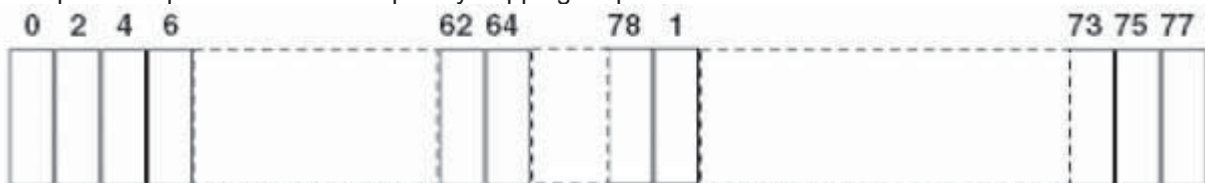

Each frequency used equally on the average by each transmitter. The system receiver has input bandwidths that match the hopping channel bandwidths of their corresponding transmitter and shifts frequencies in synchronization with the transmitted signals.



4.11. Antenna Requirement

Standard Applicable

Standard Applicable

For intentional device, according to FCC 47 CFR Section 15.203, an intentional radiator shall be designed to ensure that no antenna other than that furnished by the responsible party shall be used with the device.

And according to FCC 47 CFR Section 15.247 (c), if transmitting antennas of directional gain greater than 6dBi are used, the power shall be reduced by the amount in dB that the directional gain of the antenna exceeds 6dBi.

Antenna Information

The directional gains of antenna used for transmitting is 2.00 dBi.



5. Test Setup Photos of the EUT

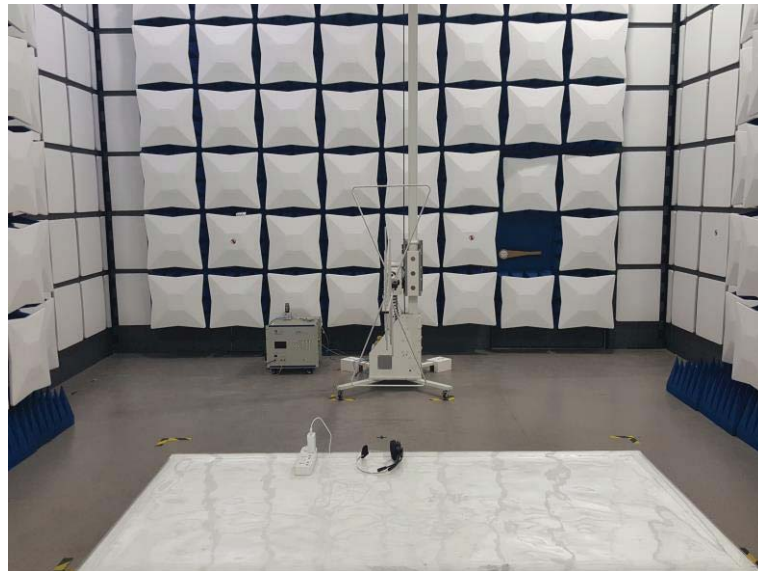

.....End of Report.....