

TEST REPORT



Report No.: TW2304178E  
Applicant: LEADER PREMIUMS LIMITED  
Product: 3IN1 Folding Charger  
Model No.: AB0427  
Trademark: N/A  
Test Standards: FCC Part 15 Subpart C

Test Result: It is herewith confirmed and found to comply with the requirements set up by ANSI C63.4&FCC Part 15 Subpart C, for the evaluation of electromagnetic compatibility

Approved By  
*Terry Tang*

Terry Tang

Manager

Dated: May 09, 2023

**Results appearing herein relate only to the sample tested**  
**The technical reports is issued errors and omissions exempt and is subject to withdrawal at**

**SHENZHEN TIMEWAY TESTING LABORATORIES**

**Zone C, 1st Floor, Block B, Jun Xiang Da Building, Zhongshan Park Road West, Tong Le Village, Nanshan District, Shenzhen, China**

Tel (755) 83448688, Fax (755) 83442996, E-Mail:info@timeway-lab.com



### **Special Statement:**

The testing quality ability of our laboratory meet with "Quality Law of People's Republic of China" Clause 19.

The testing quality system of our laboratory meets with ISO/IEC-17025 requirements, which is approved by CNAS. This approval result is accepted by MRA of APLAC.

Our test facility is recognized, certified, or accredited by the following organizations:

#### **CNAS-LAB Code: L2292**

The EMC Laboratory has been assessed and in compliance with CNAS-CL01 accreditation criteria for testing Laboratories (identical to ISO/IEC 17025:2017 General Requirements) for the Competence of testing Laboratories.

#### **FCC-Registration No.: 744189**

The EMC Laboratory has been registered and fully described in a report filed with the (FCC) Federal Communications commission. The acceptance letter from the FCC is maintained in our files. Registration No.: 744189.

#### **Industry Canada (IC) —Registration No.:5205A**

The EMC Laboratory has been registered by Certification and Engineering Bureau of Industry Canada for radio equipment testing with Registration No.: 5205A.

#### **A2LA (Certification Number:5013.01)**

The EMC Laboratory has been accredited by the American Association for Laboratory Accreditation (A2LA). Certification Number:5013.01

The report refers only to the sample tested and does not apply to the bulk.

This report is issued in confidence to the client and it will be strictly treated as such by the SHENZHEN TIMEWAY TESTING LABORATORIES. It may not be reproduced rather in its entirety or in part and it may not be used for adverting. The client to whom the report is issued may, however, show or send it . or a certified copy there of prepared by the SHENZHEN TIMEWAY TESTING LABORATORIES. to his customer. Supplier or others persons directly concerned. SHENZHEN TIMEWAY TESTING LABORATORIES. will not, without the consent of the client enter into any discussion of correspondence with any third party concerning the contents of the report. In the event of the improper use of the report. The SHENZHEN TIMEWAY TESTING LABORATORIES. reserves the rights to withdraw it and to adopt any other remedies which may be appropriate.



Test Report Conclusion

Content

<b>1.0</b>	<b>General Details</b> .....	4
1.1	Test Lab Details.....	4
1.2	Applicant Details.....	4
1.3	Description of EUT .....	4
1.4	Submitted Sample.....	5
1.5	Test Duration.....	5
1.6	Test Uncertainty.....	5
1.7	Test By.....	5
<b>2.0</b>	<b>List of Measurement Equipment</b> .....	6
<b>3.0</b>	<b>Technical Details</b> .....	7
3.1	Summary of Test Results.....	7
3.2	Test Standards.....	7
<b>4.0</b>	<b>EUT Modification</b> .....	7
<b>5.0</b>	<b>Power Line Conducted Emission Test</b> .....	8
5.1	Schematics of the Test.....	8
5.2	Test Method and Test Procedure.....	8
5.3	Configuration of the EUT.....	8
5.4	EUT Operating Condition.....	9
5.5	Conducted Emission Limit.....	9
5.6	Test Result.....	9
<b>6.0</b>	<b>Radiated Emission test</b> .....	16
6.1	Test Method and Test Procedure.....	16
6.2	Configuration of the EUT.....	17
6.3	EUT Operation Condition.....	17
6.4	Radiated Emission Limit.....	17
6.5	Test Result.....	18
<b>7.0</b>	<b>20dB Bandwidth Test</b> .....	28
<b>8.0</b>	<b>Antenna Requirement</b> .....	32
<b>9.0</b>	<b>FCC Label</b> .....	33
<b>10.0</b>	<b>Photo of Testing</b> .....	34

The report refers only to the sample tested and does not apply to the bulk.

This report is issued in confidence to the client and it will be strictly treated as such by the SHENZHEN TIMEWAY TESTING LABORATORIES. It may not be reproduced rather in its entirety or in part and it may not be used for advertising. The client to whom the report is issued may, however, show or send it, or a certified copy thereof prepared by the SHENZHEN TIMEWAY TESTING LABORATORIES, to his customer. Supplier or others persons directly concerned. SHENZHEN TIMEWAY TESTING LABORATORIES, will not, without the consent of the client enter into any discussion of correspondence with any third party concerning the contents of the report.

In the event of the improper use of the report, The SHENZHEN TIMEWAY TESTING LABORATORIES, reserves the rights to withdraw it and to adopt any other remedies which may be appropriate.



## 1.0 General Details

### 1.1 Test Lab Details

Name: SHENZHEN TIMEWAY TESTING LABORATORIES.  
Address: Zone C, 1st Floor, Block B, Jun Xiang Da Building, Zhongshan Park Road West, Tong Le Village, Nanshan District, Shenzhen, China  
Telephone: +86 755 83448688  
Fax: +86 755 83442996  
Site on File with the Federal Communications Commission – United States  
Registration Number: 744189  
For 3m Anechoic Chamber

### 1.2 Applicant Details

Applicant: LEADER PREMIUMS LIMITED  
Address: ROOM 901, HENGFU MANSION, NO.858, FUMINGROAD, NINGBO, CHINA  
Telephone: --  
Fax: --

### 1.3 Description of EUT

Product: 3IN1 Folding Charger  
Manufacturer: LEADER PREMIUMS LIMITED  
Address: ROOM 901, HENGFU MANSION, NO.858, FUMINGROAD, NINGBO, CHINA  
Trademark: N/A  
Model Number: AB0427  
Additional Model Name: N/A  
Additional Trade Name: N/A  
Rating: Input: DC5V/3A or DC9V/3A;  
Wireless Output: DC5V/1A or DC9V/1.1A  
USB A & Type-C Output (MAX): DC5V, 2A  
Test Mode: Mode 1: DC9V 1.1A (Phone);  
Mode 2: DC5V/1A (TWS Earphone);  
Mode 3: Mode 1+ Mode 2  
Hardware Version: wirelesscharging-AB0427  
Software Version: leader.2021.11  
Serial No.: leader0427  
Operation Frequency: See below table

The report refers only to the sample tested and does not apply to the bulk.

This report is issued in confidence to the client and it will be strictly treated as such by the SHENZHEN TIMEWAY TESTING LABORATORIES. It may not be reproduced rather in its entirety or in part and it may not be used for advertising. The client to whom the report is issued may, however, show or send it, or a certified copy thereof prepared by the SHENZHEN TIMEWAY TESTING LABORATORIES, to his customer. Supplier or others persons directly concerned. SHENZHEN TIMEWAY TESTING LABORATORIES, will not, without the consent of the client enter into any discussion of correspondence with any third party concerning the contents of the report.

In the event of the improper use of the report. The SHENZHEN TIMEWAY TESTING LABORATORIES, reserves the rights to withdraw it and to adopt any other remedies which may be appropriate.



Channel	Frequency (MHz)	Channel	Frequency (MHz)	Channel	Frequency (MHz)	Channel	Frequency (MHz)
01	0.1115	06	0.140	11	0.165	16	0.190
02	0.120	07	0.145	12	0.170	17	0.195
03	0.125	08	0.150	13	0.175	18	0.200
04	0.130	09	0.155	14	0.180	19	0.205
05	0.135	10	0.160	15	0.185		
Test channel		Frequency (MHz)					
CH13		0.175 MHz					

Modulation Type: MSK  
Antenna Designation Inductive Loop Antenna with Gain 0dBi (for each one)

1.4 Submitted Sample  
1 Samples

1.5 Test Duration  
2023-04-12 to 2023-05-09

1.6 Test Uncertainty  
Conducted Emissions Uncertainty =3.6dB  
Radiated Emissions below 9kHz-30MHz Uncertainty =4.3dB  
Radiated Emissions below 30MHz-1GHz Uncertainty =4.7dB  
Radiated Emissions above 1GHz Uncertainty =6.0dB  
Conducted Power Uncertainty =6.0dB  
Occupied Channel Bandwidth Uncertainty =5%

1.7 Test Engineer

The sample tested by

*Andy Xing*

Print Name: Andy Xing

The report refers only to the sample tested and does not apply to the bulk.  
This report is issued in confidence to the client and it will be strictly treated as such by the SHENZHEN TIMEWAY TESTING LABORATORIES. It may not be reproduced rather in its entirety or in part and it may not be used for advertising. The client to whom the report is issued may, however, show or send it, or a certified copy thereof prepared by the SHENZHEN TIMEWAY TESTING LABORATORIES, to his customer. Supplier or others persons directly concerned. SHENZHEN TIMEWAY TESTING LABORATORIES, will not, without the consent of the client enter into any discussion of correspondence with any third party concerning the contents of the report.  
In the event of the improper use of the report. The SHENZHEN TIMEWAY TESTING LABORATORIES, reserves the rights to withdraw it and to adopt any other remedies which may be appropriate.



2.0 Test Equipment					
Instrument Type	Manufacturer	Model	Serial No.	Date of Cal.	Due Date
ESPI Test Receiver	R&S	ESPI 3	100379	2022-07-15	2023-07-14
LISN	R&S	EZH3-Z5	100294	2022-07-18	2023-07-17
LISN	R&S	EZH3-Z5	100253	2022-07-18	2023-07-17
Impuls-Begrenzer	R&S	ESH3-Z2	100281	2022-07-18	2023-07-17
Loop Antenna	EMCO	6507	00078608	2022-07-18	2025-07-17
Spectrum	R&S	FSIQ26	100292	2022-07-15	2023-07-14
Horn Antenna	A-INFO	LB-180400-KF	J211060660	2022-07-18	2025-07-17
Horn Antenna	R&S	BBHA 9120D	9120D-631	2022-07-18	2024-07-17
Power meter	Anritsu	ML2487A	6K00003613	2022-07-18	2023-07-17
Power sensor	Anritsu	MA2491A	32263	2022-07-18	2023-07-17
Bilog Antenna	Schwarebeck	VULB9163	9163/340	2022-07-18	2025-07-17
9*6*6 Anechoic	--	--	N/A	2022-07-26	2025-07-25
EMI Test Receiver	RS	ESVB	826156/011	2022-07-15	2023-07-14
EMI Test Receiver	RS	ESCS 30	834115/006	2022-07-15	2023-07-14
Spectrum	HP/Agilent	E4407B	MY50441392	2022-07-15	2023-07-14
Spectrum	RS	FSP	1164.4391.38	2022-07-15	2023-07-14
RF Cable	Zhengdi	ZT26-NJ-NJ-8 M/FA	--	2022-07-15	2023-07-14
RF Cable	Zhengdi	7m	--	2022-07-15	2023-07-14
Pre-Amplifier	Schwarebeck	BBV9743	#218	2022-07-15	2023-07-14
Pre-Amplifier	HP/Agilent	8449B	3008A00160	2022-07-15	2023-07-14
LISN	SCHAFFNER	NNB42	00012	2022-08-18	2023-07-17
ESPI Test Receiver	R&S	ESPI 3	100379	2022-07-15	2023-07-14
LISN	R&S	EZH3-Z5	100294	2022-07-18	2023-07-17

## 2.2 Automation Test Software

### For Conducted Emission Test

Name	Version
EZ-EMC	Ver.EMC-CON 3A1.1

### For Radiated Emissions

Name	Version
EMI Test Software BL410-EV18.91	V18.905
EMI Test Software BL410-EV18.806 High Frequency	V18.06

The report refers only to the sample tested and does not apply to the bulk.

This report is issued in confidence to the client and it will be strictly treated as such by the SHENZHEN TIMEWAY TESTING LABORATORIES. It may not be reproduced rather in its entirety or in part and it may not be used for advertising. The client to whom the report is issued may, however, show or send it, or a certified copy thereof prepared by the SHENZHEN TIMEWAY TESTING LABORATORIES, to his customer. Supplier or other persons directly concerned. SHENZHEN TIMEWAY TESTING LABORATORIES, will not, without the consent of the client enter into any discussion of correspondence with any third party concerning the contents of the report.

In the event of the improper use of the report. The SHENZHEN TIMEWAY TESTING LABORATORIES, reserves the rights to withdraw it and to adopt any other remedies which may be appropriate.



### 3.0 Technical Details

#### 3.1 Summary of test results

<b>The EUT has been tested according to the following specifications:</b>			
<b>Standard</b>	<b>Test Type</b>	<b>Result</b>	<b>Notes</b>
FCC Part 15, Paragraph 15.203	Antenna requirements	<b>Pass</b>	Compliant
FCC Part 15, Paragraph 15.207	Conducted Emission Test	<b>Pass</b>	Compliant
FCC Part 15, Paragraph 15.209 (a) (f)	General Requirement	<b>Pass</b>	Compliant
FCC Part 15, Paragraph 15.215	20dB Bandwidth Testing	<b>Pass</b>	Compliant

#### 3.2 Test Standards

**FCC Part 15 Subpart C , ANSI C63.4 :2014 and ANSI C63.10 :2013**

#### 4.0 EUT Modification

No modification by SHENZHEN TIMEWAY TESTING LABORATORIES

The report refers only to the sample tested and does not apply to the bulk.

This report is issued in confidence to the client and it will be strictly treated as such by the SHENZHEN TIMEWAY TESTING LABORATORIES. It may not be reproduced rather in its entirety or in part and it may not be used for advertising. The client to whom the report is issued may, however, show or send it . or a certified copy there of prepared by the SHENZHEN TIMEWAY TESTING LABORATORIES. to his customer. Supplier or others persons directly concerned. SHENZHEN TIMEWAY TESTING LABORATORIES. will not, without the consent of the client enter into any discussion of correspondence with any third party concerning the contents of the report.

In the event of the improper use of the report. The SHENZHEN TIMEWAY TESTING LABORATORIES. reserves the rights to withdraw it and to adopt any other remedies which may be appropriate.



**5. Power Line Conducted Emission Test**

5.1 Schematics of the test

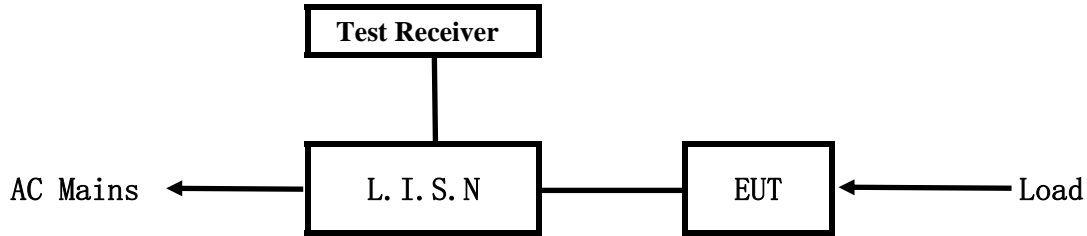

EUT: Equipment Under Test

5.2 Test Method and test Procedure

The EUT was tested according to ANSI C63.10-2013. The Frequency spectrum from 0.15MHz to 30MHz was investigated. The LISN used was 50ohm/50uH as specified by section 5.1 of ANSI C63.10 –2013.

Test Voltage: 120V~, 60Hz

Block diagram of Test setup

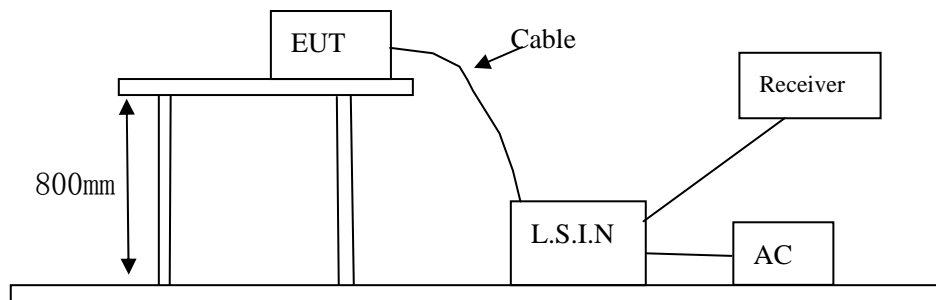

5.3 Configuration of The EUT

The EUT was configured according to ANSI C63.4-2014. All interface ports were connected to the appropriate peripherals. All peripherals and cables are listed below.

A. EUT

Device	Manufacturer	Model	FCC ID
3IN1 Folding Charger	LEADER PREMIUMS LIMITED	AB0427	2APYY-AB0427

B. Internal Device

Device	Manufacturer	Model	FCC ID/DOC
N/A			

The report refers only to the sample tested and does not apply to the bulk.

This report is issued in confidence to the client and it will be strictly treated as such by the SHENZHEN TIMEWAY TESTING LABORATORIES. It may not be reproduced rather in its entirety or in part and it may not be used for advertising. The client to whom the report is issued may, however, show or send it, or a certified copy thereof prepared by the SHENZHEN TIMEWAY TESTING LABORATORIES, to his customer. Supplier or others persons directly concerned. SHENZHEN TIMEWAY TESTING LABORATORIES, will not, without the consent of the client enter into any discussion of correspondence with any third party concerning the contents of the report.

In the event of the improper use of the report. The SHENZHEN TIMEWAY TESTING LABORATORIES, reserves the rights to withdraw it and to adopt any other remedies which may be appropriate.





C. Peripherals

Device	Manufacturer	Model	Rating
Power Supply	Chenyang	UP0920	Input: 100-240V~, 50-60Hz, 0.5A; Output: DC5V, 3A or DC9V, 2A

5.4 EUT Operating Condition

Operating condition is according to ANSI C63.10 -2013.

A Setup the EUT and simulators as shown on follow

B Enable AF signal and confirm EUT active to normal condition

5.5 Power line conducted Emission Limit according to Paragraph 15.207

Frequency (MHz)	Limits (dB $\mu$ V)	
	Quasi-peak Level	Average Level
0.15 ~ 0.50	66.0~56.0*	56.0~46.0*
0.50 ~ 5.00	56.0	46.0
5.00 ~ 30.00	60.0	50.0

- Notes: 1. \*Decreasing linearly with logarithm of frequency.  
 2. The tighter limit shall apply at the transition frequencies

5.6 Test Results

The frequency spectrum from 0.15MHz to 30MHz was investigated. All reading are quasi-peak values with a resolution bandwidth of 9kHz. (The average detector is necessary when the Quasi-peak emission level beyond the average Limit.)



**A: Conducted Emission on Live Terminal (150kHz to 30MHz)**

**EUT Operating Environment**

Temperature: 25°C Humidity:75%RH Atmospheric Pressure: 101 kPa

**EUT set Condition: Keep Transmitting**

**Test mode: Mode 1**

**Results: Pass**

Please refer to following diagram for individual

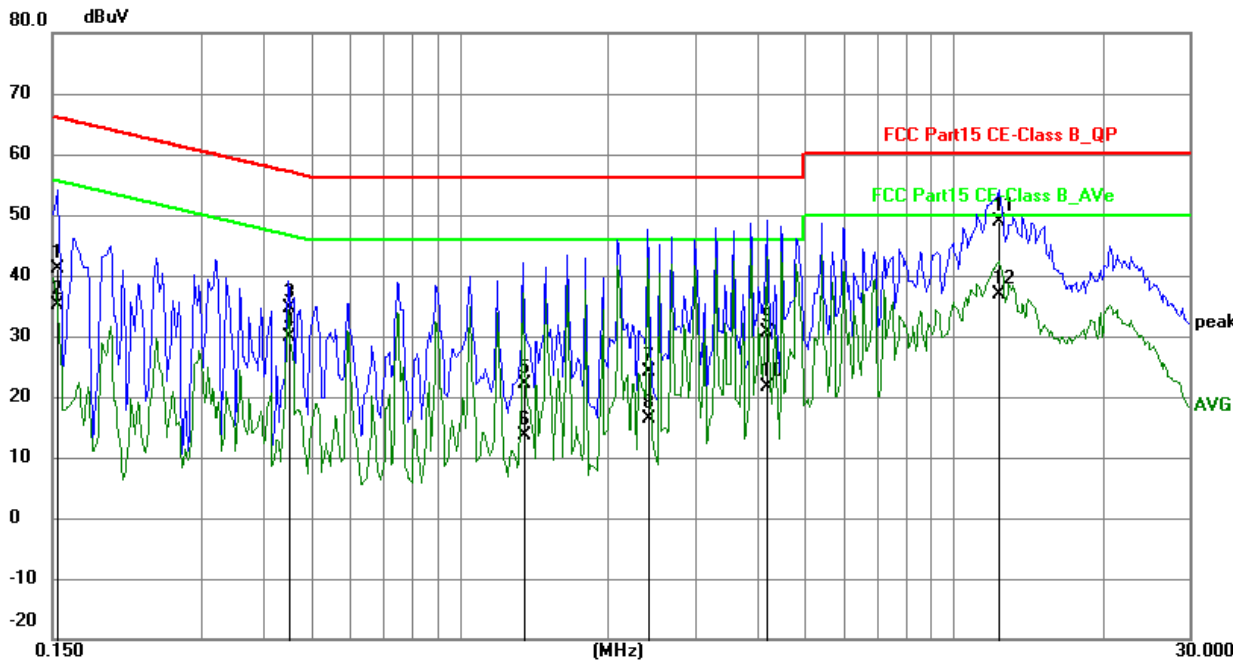

No.	Frequency (MHz)	Reading (dBuV)	Factor (dB)	Level (dBuV)	Limit (dBuV)	Margin (dB)	Detector	P/F
1	0.1539	31.42	9.78	41.20	65.79	-24.59	QP	P
2	0.1539	25.40	9.78	35.18	55.79	-20.61	AVG	P
3	0.4503	24.98	9.77	34.75	56.87	-22.12	QP	P
4	0.4503	20.12	9.77	29.89	46.87	-16.98	AVG	P
5	1.3473	12.35	9.79	22.14	56.00	-33.86	QP	P
6	1.3473	3.95	9.79	13.74	46.00	-32.26	AVG	P
7	2.3964	14.43	9.82	24.25	56.00	-31.75	QP	P
8	2.3964	6.45	9.82	16.27	46.00	-29.73	AVG	P
9	4.1934	20.63	9.89	30.52	56.00	-25.48	QP	P
10	4.1934	11.75	9.89	21.64	46.00	-24.36	AVG	P
11	12.3678	38.62	10.26	48.88	60.00	-11.12	QP	P
12	12.3678	26.69	10.26	36.95	50.00	-13.05	AVG	P

The report refers only to the sample tested and does not apply to the bulk.

This report is issued in confidence to the client and it will be strictly treated as such by the SHENZHEN TIMEWAY TESTING LABORATORIES. It may not be reproduced rather in its entirety or in part and it may not be used for advertising. The client to whom the report is issued may, however, show or send it, or a certified copy thereof prepared by the SHENZHEN TIMEWAY TESTING LABORATORIES, to his customer. Supplier or others persons directly concerned. SHENZHEN TIMEWAY TESTING LABORATORIES, will not, without the consent of the client enter into any discussion of correspondence with any third party concerning the contents of the report.

In the event of the improper use of the report. The SHENZHEN TIMEWAY TESTING LABORATORIES, reserves the rights to withdraw it and to adopt any other remedies which may be appropriate.



**B: Conducted Emission on Neutral Terminal (150kHz to 30MHz)**

**EUT Operating Environment**

Temperature: 25°C Humidity:75%RH Atmospheric Pressure: 101 kPa

**EUT set Condition: Keep Transmitting**

**Test mode: Mode 1**

**Results: Pass**

Please refer to following diagram for individual

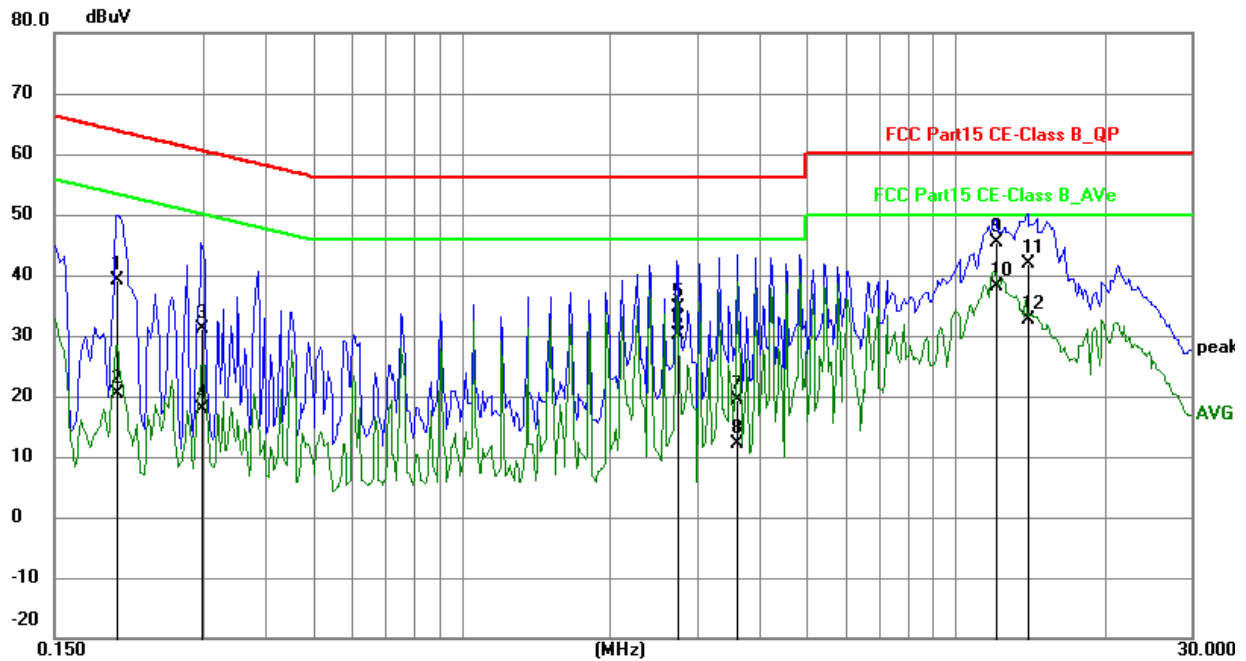

No.	Frequency (MHz)	Reading (dBuV)	Factor (dB)	Level (dBuV)	Limit (dBuV)	Margin (dB)	Detector	P/F
1	0.2007	29.41	9.75	39.16	63.58	-24.42	QP	P
2	0.2007	10.64	9.75	20.39	53.58	-33.19	AVG	P
3	0.2982	21.25	9.76	31.01	60.29	-29.28	QP	P
4	0.2982	8.10	9.76	17.86	50.29	-32.43	AVG	P
5	2.7318	24.72	9.83	34.55	56.00	-21.45	QP	P
6	2.7318	20.19	9.83	30.02	46.00	-15.98	AVG	P
7	3.6084	9.58	9.87	19.45	56.00	-36.55	QP	P
8	3.6084	2.15	9.87	12.02	46.00	-33.98	AVG	P
9	12.0948	35.25	10.25	45.50	60.00	-14.50	QP	P
10	12.0948	27.95	10.25	38.20	50.00	-11.80	AVG	P
11	13.9863	31.65	10.34	41.99	60.00	-18.01	QP	P
12	13.9863	22.33	10.34	32.67	50.00	-17.33	AVG	P

The report refers only to the sample tested and does not apply to the bulk.

This report is issued in confidence to the client and it will be strictly treated as such by the SHENZHEN TIMEWAY TESTING LABORATORIES. It may not be reproduced rather in its entirety or in part and it may not be used for advertising. The client to whom the report is issued may, however, show or send it, or a certified copy thereof prepared by the SHENZHEN TIMEWAY TESTING LABORATORIES, to his customer. Supplier or others persons directly concerned. SHENZHEN TIMEWAY TESTING LABORATORIES, will not, without the consent of the client enter into any discussion of correspondence with any third party concerning the contents of the report.

In the event of the improper use of the report. The SHENZHEN TIMEWAY TESTING LABORATORIES, reserves the rights to withdraw it and to adopt any other remedies which may be appropriate.



**C: Conducted Emission on Live Terminal (150kHz to 30MHz)**

**EUT Operating Environment**

Temperature: 25°C Humidity:75%RH Atmospheric Pressure: 101 kPa

**EUT set Condition: Keep Transmitting**

**Test mode: Mode 2**

**Results: Pass**

Please refer to following diagram for individual

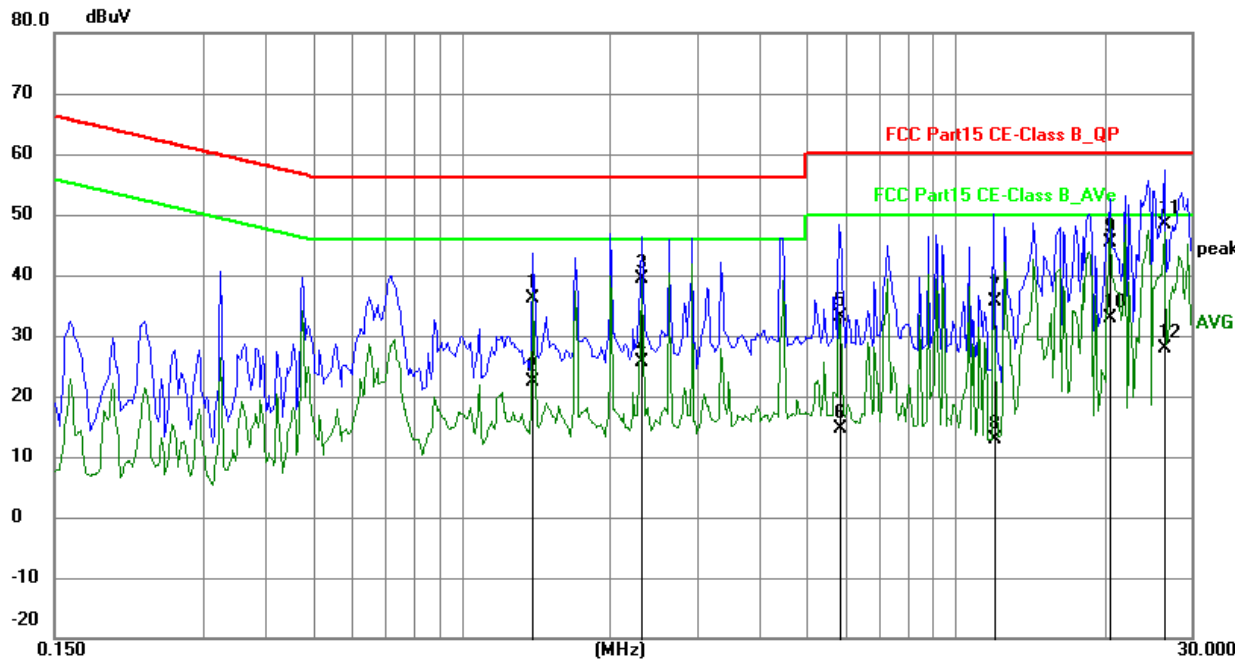

No.	Frequency (MHz)	Reading (dBuV)	Factor (dB)	Level (dBuV)	Limit (dBuV)	Margin (dB)	Detector	P/F
1	1.3941	26.36	9.79	36.15	56.00	-19.85	QP	P
2	1.3941	12.58	9.79	22.37	46.00	-23.63	AVG	P
3	2.3184	29.54	9.81	39.35	56.00	-16.65	QP	P
4	2.3184	15.83	9.81	25.64	46.00	-20.36	AVG	P
5	5.8158	23.16	9.96	33.12	60.00	-26.88	QP	P
6	5.8158	4.65	9.96	14.61	50.00	-35.39	AVG	P
7	11.9778	25.47	10.25	35.72	60.00	-24.28	QP	P
8	11.9778	2.66	10.25	12.91	50.00	-37.09	AVG	P
9	20.5617	34.69	10.71	45.40	60.00	-14.60	QP	P
10	20.5617	22.15	10.71	32.86	50.00	-17.14	AVG	P
11	26.4429	37.41	11.08	48.49	60.00	-11.51	QP	P
12	26.4429	16.85	11.08	27.93	50.00	-22.07	AVG	P

The report refers only to the sample tested and does not apply to the bulk.

This report is issued in confidence to the client and it will be strictly treated as such by the SHENZHEN TIMEWAY TESTING LABORATORIES. It may not be reproduced rather in its entirety or in part and it may not be used for advertising. The client to whom the report is issued may, however, show or send it, or a certified copy thereof prepared by the SHENZHEN TIMEWAY TESTING LABORATORIES, to his customer. Supplier or others persons directly concerned. SHENZHEN TIMEWAY TESTING LABORATORIES, will not, without the consent of the client enter into any discussion of correspondence with any third party concerning the contents of the report.

In the event of the improper use of the report. The SHENZHEN TIMEWAY TESTING LABORATORIES, reserves the rights to withdraw it and to adopt any other remedies which may be appropriate.



**D: Conducted Emission on Neutral Terminal (150kHz to 30MHz)**

**EUT Operating Environment**

Temperature: 25°C Humidity:75%RH Atmospheric Pressure: 101 kPa

**EUT set Condition: Keep Transmitting**

**Test mode: Mode 2**

**Results: Pass**

Please refer to following diagram for individual

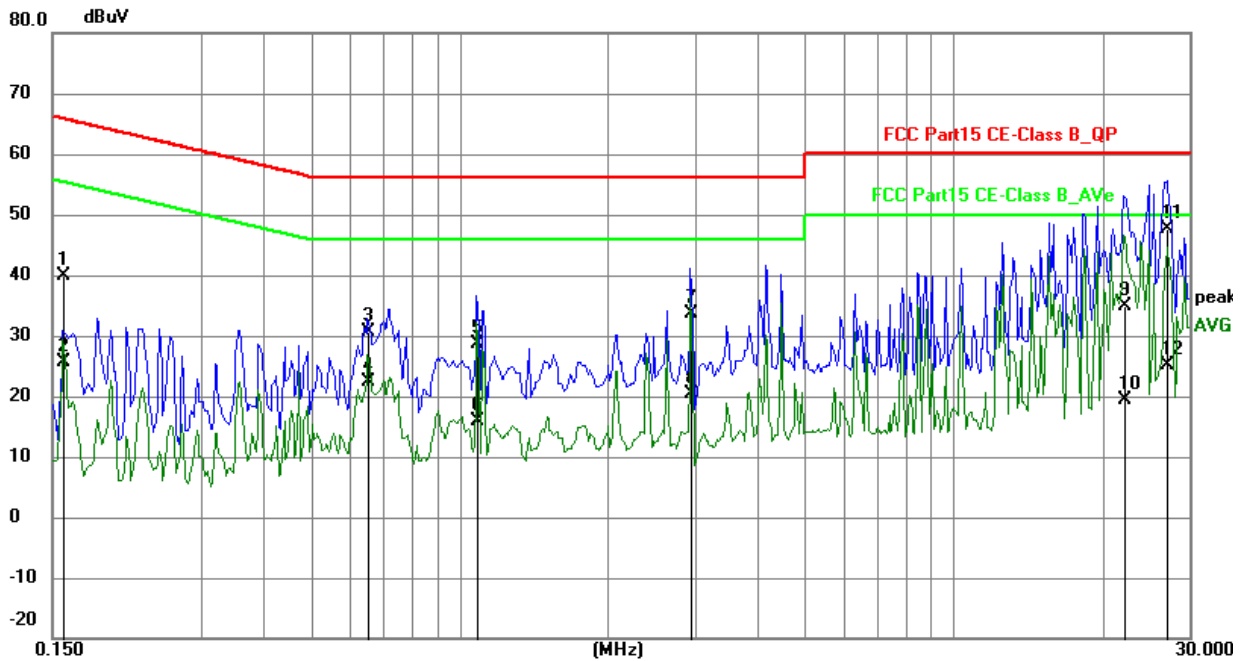

No.	Frequency (MHz)	Reading (dBuV)	Factor (dB)	Level (dBuV)	Limit (dBuV)	Margin (dB)	Detector	P/F
1	0.1578	29.98	9.78	39.76	65.58	-25.82	QP	P
2	0.1578	15.85	9.78	25.63	55.58	-29.95	AVG	P
3	0.6531	20.75	9.78	30.53	56.00	-25.47	QP	P
4	0.6531	12.70	9.78	22.48	46.00	-23.52	AVG	P
5	1.0859	18.77	9.79	28.56	56.00	-27.44	QP	P
6	1.0859	6.15	9.79	15.94	46.00	-30.06	AVG	P
7	2.9385	23.82	9.84	33.66	56.00	-22.34	QP	P
8	2.9385	10.52	9.84	20.36	46.00	-25.64	AVG	P
9	22.1529	23.96	10.81	34.77	60.00	-25.23	QP	P
10	22.1529	8.55	10.81	19.36	50.00	-30.64	AVG	P
11	27.0591	36.57	11.12	47.69	60.00	-12.31	QP	P
12	27.0591	14.11	11.12	25.23	50.00	-24.77	AVG	P

The report refers only to the sample tested and does not apply to the bulk.

This report is issued in confidence to the client and it will be strictly treated as such by the SHENZHEN TIMEWAY TESTING LABORATORIES. It may not be reproduced rather in its entirety or in part and it may not be used for advertising. The client to whom the report is issued may, however, show or send it, or a certified copy thereof prepared by the SHENZHEN TIMEWAY TESTING LABORATORIES, to his customer. Supplier or others persons directly concerned. SHENZHEN TIMEWAY TESTING LABORATORIES, will not, without the consent of the client enter into any discussion of correspondence with any third party concerning the contents of the report.

In the event of the improper use of the report. The SHENZHEN TIMEWAY TESTING LABORATORIES, reserves the rights to withdraw it and to adopt any other remedies which may be appropriate.



**E: Conducted Emission on Live Terminal (150kHz to 30MHz)**

**EUT Operating Environment**

Temperature: 25°C Humidity:75%RH Atmospheric Pressure: 101 kPa

**EUT set Condition: Keep Transmitting**

**Test mode: Mode 3**

**Results: Pass**

Please refer to following diagram for individual

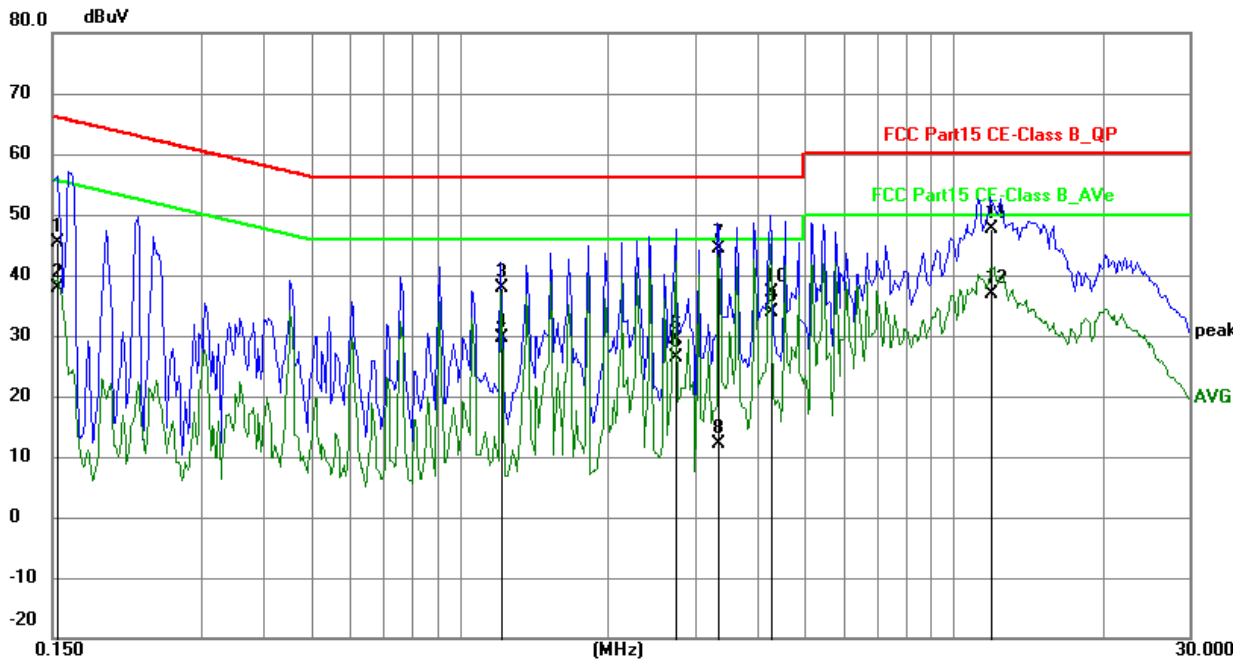

No.	Frequency (MHz)	Reading (dBuV)	Factor (dB)	Level (dBuV)	Limit (dBuV)	Margin (dB)	Detector	P/F
1	0.1539	35.70	9.78	45.48	65.79	-20.31	QP	P
2	0.1539	28.02	9.78	37.80	55.79	-17.99	AVG	P
3	1.2147	27.98	9.79	37.77	56.00	-18.23	QP	P
4	1.2147	19.88	9.79	29.67	46.00	-16.33	AVG	P
5	2.7357	16.61	9.83	26.44	56.00	-29.56	QP	P
6	2.7357	19.54	9.83	29.37	46.00	-16.63	AVG	P
7	3.3432	34.47	9.86	44.33	56.00	-11.67	QP	P
8	3.3432	2.16	9.86	12.02	46.00	-33.98	AVG	P
9	4.2519	23.87	9.90	33.77	56.00	-22.23	QP	P
10	4.2519	27.20	9.90	37.10	46.00	-8.90	AVG	P
11	11.8725	37.41	10.24	47.65	60.00	-12.35	QP	P
12	11.8725	26.66	10.24	36.90	50.00	-13.10	AVG	P

The report refers only to the sample tested and does not apply to the bulk.

This report is issued in confidence to the client and it will be strictly treated as such by the SHENZHEN TIMEWAY TESTING LABORATORIES. It may not be reproduced rather in its entirety or in part and it may not be used for advertising. The client to whom the report is issued may, however, show or send it, or a certified copy thereof prepared by the SHENZHEN TIMEWAY TESTING LABORATORIES, to his customer. Supplier or others persons directly concerned. SHENZHEN TIMEWAY TESTING LABORATORIES, will not, without the consent of the client enter into any discussion of correspondence with any third party concerning the contents of the report.

In the event of the improper use of the report. The SHENZHEN TIMEWAY TESTING LABORATORIES, reserves the rights to withdraw it and to adopt any other remedies which may be appropriate.



**F: Conducted Emission on Neutral Terminal (150kHz to 30MHz)**

**EUT Operating Environment**

Temperature: 25°C Humidity:75%RH Atmospheric Pressure: 101 kPa

**EUT set Condition: Keep Transmitting**

**Test mode: Mode 3**

**Results: Pass**

Please refer to following diagram for individual

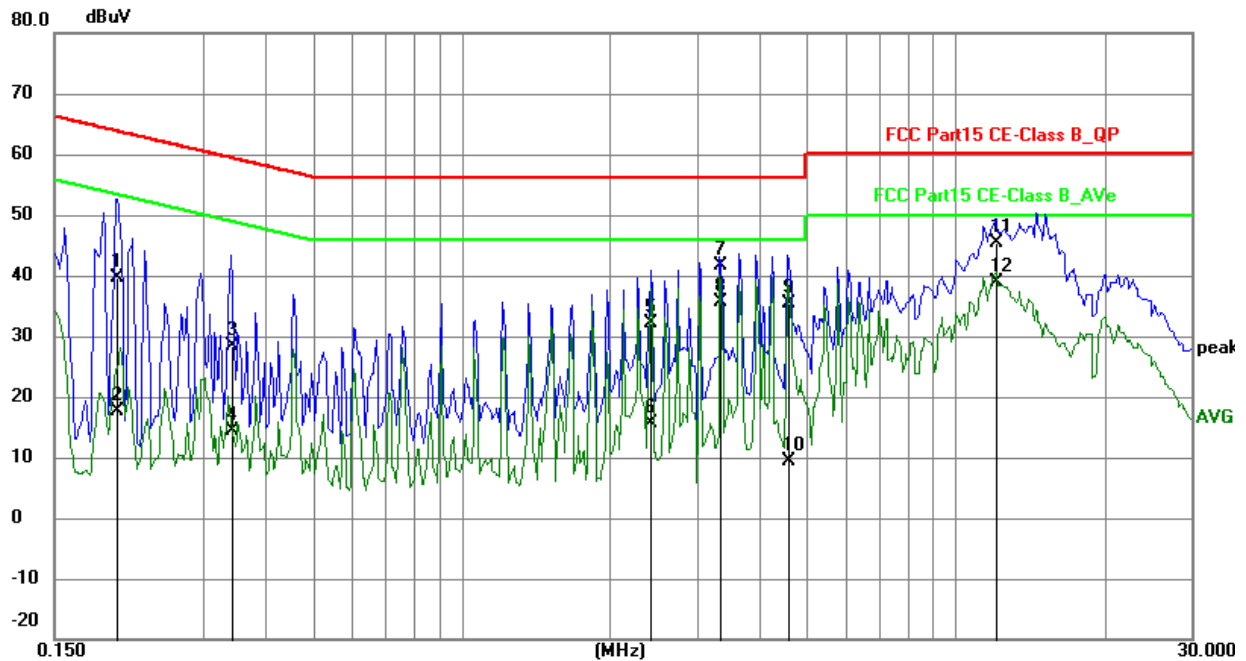

No.	Frequency (MHz)	Reading (dBuV)	Factor (dB)	Level (dBuV)	Limit (dBuV)	Margin (dB)	Detector	P/F
1	0.2007	29.88	9.75	39.63	63.58	-23.95	QP	P
2	0.2007	7.82	9.75	17.57	53.58	-36.01	AVG	P
3	0.3410	18.70	9.76	28.46	59.18	-30.72	QP	P
4	0.3410	4.68	9.76	14.44	49.18	-34.74	AVG	P
5	2.4159	22.20	9.82	32.02	56.00	-23.98	QP	P
6	2.4159	5.79	9.82	15.61	46.00	-30.39	AVG	P
7	3.3432	31.88	9.86	41.74	56.00	-14.26	QP	P
8	3.3432	25.77	9.86	35.63	46.00	-10.37	AVG	P
9	4.5911	25.45	9.91	35.36	56.00	-20.64	QP	P
10	4.5911	-0.46	9.91	9.45	46.00	-36.55	AVG	P
11	12.0870	35.13	10.25	45.38	60.00	-14.62	QP	P
12	12.0870	28.59	10.25	38.84	50.00	-11.16	AVG	P

The report refers only to the sample tested and does not apply to the bulk.

This report is issued in confidence to the client and it will be strictly treated as such by the SHENZHEN TIMEWAY TESTING LABORATORIES. It may not be reproduced rather in its entirety or in part and it may not be used for advertising. The client to whom the report is issued may, however, show or send it, or a certified copy thereof prepared by the SHENZHEN TIMEWAY TESTING LABORATORIES, to his customer. Supplier or others persons directly concerned. SHENZHEN TIMEWAY TESTING LABORATORIES, will not, without the consent of the client enter into any discussion of correspondence with any third party concerning the contents of the report.

In the event of the improper use of the report. The SHENZHEN TIMEWAY TESTING LABORATORIES, reserves the rights to withdraw it and to adopt any other remedies which may be appropriate.



## 6 Radiated Emission Test

### 6.1 Test Method and test Procedure:

- (1) The EUT was tested according to ANSI C63.10-2013. The radiated test was performed at TIMEWAY EMC Laboratory. This site is on file with the FCC laboratory division, Registration No.744189
- (2) The EUT, peripherals were put on the turntable which table size is 1m x 1.5 m, table high 0.8 m. All set up is according to ANSI C63.10-2013.
- (3) The frequency spectrum from 9 kHz to 1 GHz was investigated. All readings from 30 MHz to 1 GHz are quasi-peak values with RBW=120 kHz/VBW=300 kHz; All readings from 9 kHz to 30 MHz are quasi-peak values with RBW=10 kHz/VBW=30 kHz. For the frequency bands 9-90 kHz, 110-490 kHz and above 1000 MHz Radiated emission test in these three bands are based on measurements employing an average detector. Measurements were made at 3 meters.
- (4) The antenna high is varied from 1 m to 4 m high to find the maximum emission for each frequency.
- (5) Maximizing procedure was performed on the six (6) highest emissions to ensure EUT compliance is with all installation combinations. All data was recorded in the peak detection mode. Quasi-peak readings was performed only when an emission was found to be marginal (within -4 dB of specification limit), and are distinguished with a "QP" in the data table.
- (6) The antenna polarization: Vertical polarization and Horizontal polarization.

### Block diagram of Test setup

#### 9kHz-30MHz

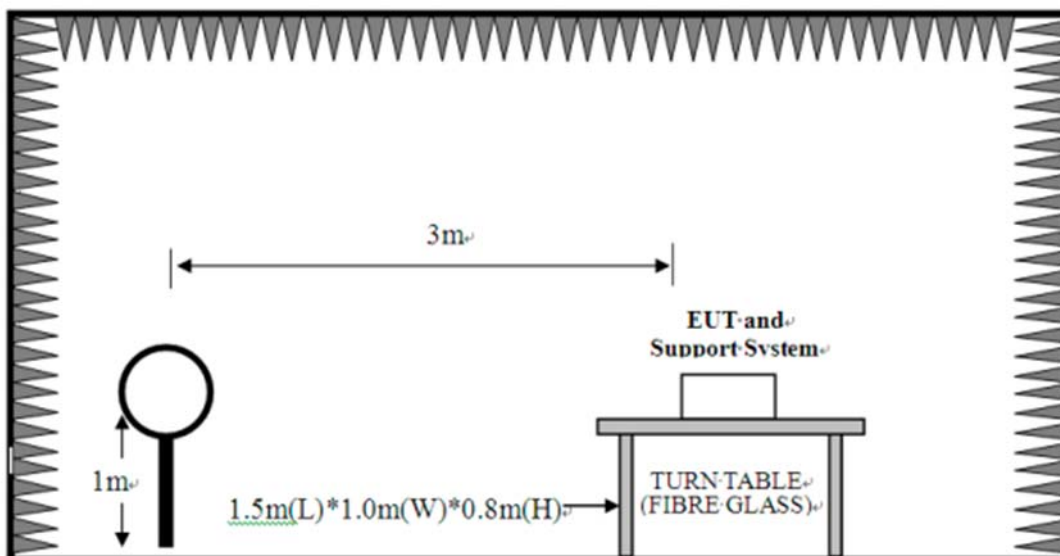

The report refers only to the sample tested and does not apply to the bulk.

This report is issued in confidence to the client and it will be strictly treated as such by the SHENZHEN TIMEWAY TESTING LABORATORIES. It may not be reproduced rather in its entirety or in part and it may not be used for advertising. The client to whom the report is issued may, however, show or send it, or a certified copy thereof prepared by the SHENZHEN TIMEWAY TESTING LABORATORIES, to his customer. Supplier or others persons directly concerned. SHENZHEN TIMEWAY TESTING LABORATORIES, will not, without the consent of the client enter into any discussion of correspondence with any third party concerning the contents of the report.

In the event of the improper use of the report. The SHENZHEN TIMEWAY TESTING LABORATORIES, reserves the rights to withdraw it and to adopt any other remedies which may be appropriate.





**30MHz-1000MHz**

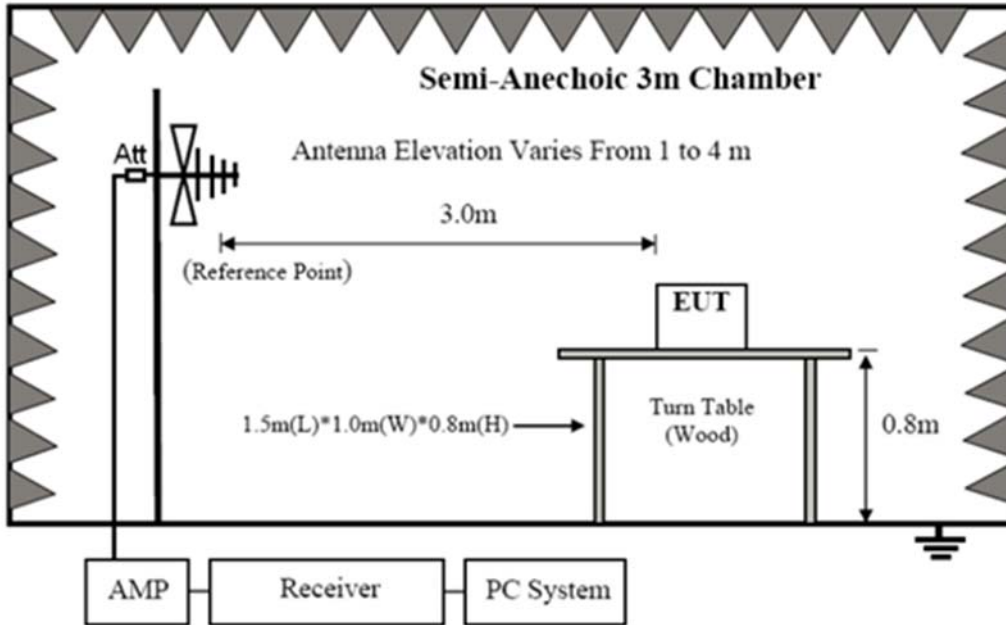

6.2 Configuration of The EUT

Same as section 5.3 of this report

6.3 EUT Operating Condition

Same as section 5.4 of this report.

6.4 Radiated Emission Limit

All emission from a digital device, including any network of conductors and apparatus connected thereto, shall not exceed the level of field strength specified below:

**B. Frequencies in restricted band are compiled to limit on Paragraph 15.209.**

**Limits for frequency below 30MHz**

Frequency Range (MHz)	Distance (m)	Field strength (V/m)
0.009-0.490	300	2400/F(kHz)
0.490-1.705	30	24000/F(kHz)
1.705-30	30	30

The report refers only to the sample tested and does not apply to the bulk.

This report is issued in confidence to the client and it will be strictly treated as such by the SHENZHEN TIMEWAY TESTING LABORATORIES. It may not be reproduced in its entirety or in part and it may not be used for advertising. The client to whom the report is issued may, however, show or send it, or a certified copy thereof prepared by the SHENZHEN TIMEWAY TESTING LABORATORIES, to his customer, supplier or other persons directly concerned. SHENZHEN TIMEWAY TESTING LABORATORIES will not, without the consent of the client enter into any discussion of correspondence with any third party concerning the contents of the report.

In the event of the improper use of the report, the SHENZHEN TIMEWAY TESTING LABORATORIES reserves the rights to withdraw it and to adopt any other remedies which may be appropriate.



**Limits for frequency above 30MHz**

Frequency Range (MHz)	Distance (m)	Field strength (dB $\mu$ V/m)
30-88	3	40.0
88-216	3	43.5
216- 60	3	46.0
Above 960	3	54.0

- Note:
1. RF Voltage (dBuV) = 20 log RF Voltage ( $\mu$ V)
  2. In the Above Table, the tighter limit applies at the band edges.
  3. Distance refers to the distance in meters between the measuring instrument antenna and the EUT
  4. The emission limits shown in the above table are based on measurements employing a CISPR quasi-peak detector except for the frequency bands 9-90 kHz, 110-490 kHz. Radiated emission limits in these three bands are based on measurements employing an average detector.

**6.5 Test result**

The report refers only to the sample tested and does not apply to the bulk.  
This report is issued in confidence to the client and it will be strictly treated as such by the SHENZHEN TIMEWAY TESTING LABORATORIES. It may not be reproduced rather in its entirety or in part and it may not be used for advertising. The client to whom the report is issued may, however, show or send it . or a certified copy there of prepared by the SHENZHEN TIMEWAY TESTING LABORATORIES. to his customer. Supplier or others persons directly concerned. SHENZHEN TIMEWAY TESTING LABORATORIES. will not, without the consent of the client enter into any discussion of correspondence with any third party concerning the contents of the report.  
In the event of the improper use of the report. The SHENZHEN TIMEWAY TESTING LABORATORIES. reserves the rights to withdraw it and to adopt any other remedies which may be appropriate.



**Measurement data:**

**Note: Limit dBuV/m @3m = Limit dBuV/m @300m+ 80**

**Limit dBuV/m @3m = Limit dBuV/m @30m + 40**

**Test mode: Mode 1**

**9 kHz~30 MHz**

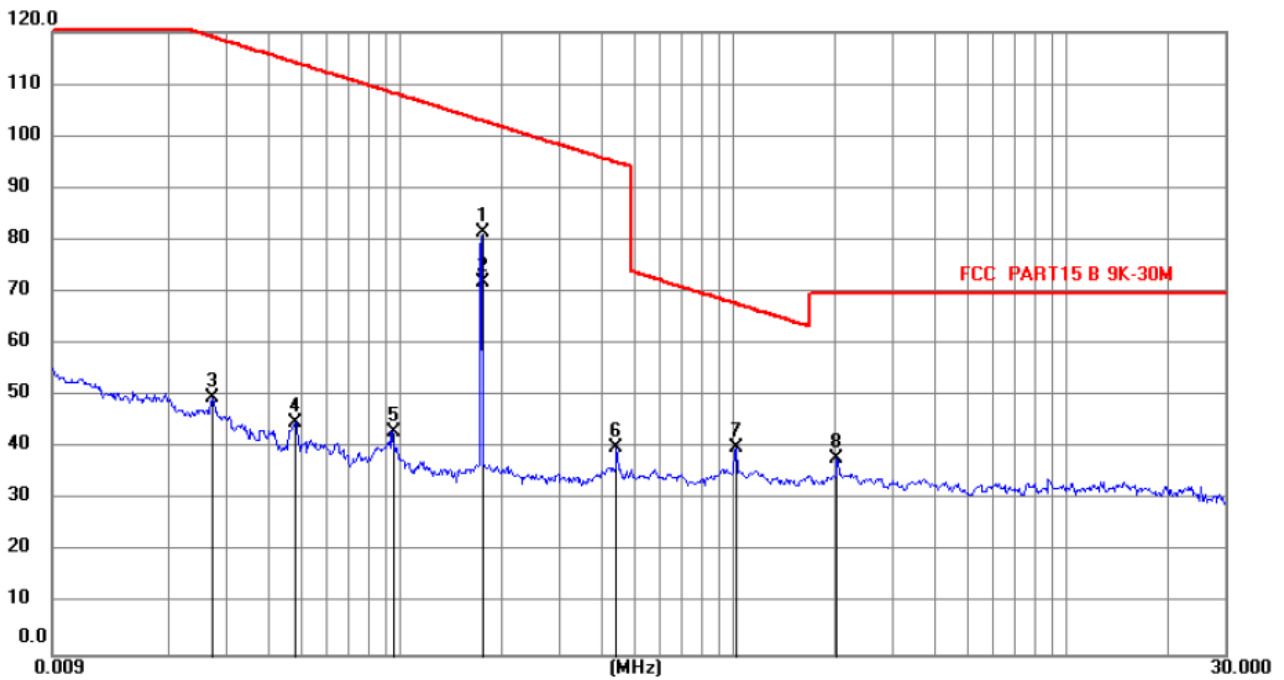

No.	Frequency (MHz)	Reading ( )	Factor (dB)	Level (dBuV/m)	Limit (dBuV/m)	Margin (dB)	Detector	P/F
1	0.1753	71.56	9.77	81.33	102.68	-21.35	peak	P
2	0.1753	62.02	9.77	71.79	102.68	-30.89	AVG	P
3	0.0273	39.47	10.22	49.69	118.74	-69.05	peak	P
4	0.0481	34.89	9.84	44.73	113.85	-69.12	peak	P
5	0.0946	33.34	9.81	43.15	108.01	-64.86	peak	P
6	0.4448	30.37	9.77	40.14	94.64	-54.50	peak	P
7	1.0174	30.27	9.79	40.06	67.47	-27.41	peak	P
8	2.0412	28.28	9.80	38.08	69.51	-31.43	peak	P

The report refers only to the sample tested and does not apply to the bulk.

This report is issued in confidence to the client and it will be strictly treated as such by the SHENZHEN TIMEWAY TESTING LABORATORIES. It may not be reproduced rather in its entirety or in part and it may not be used for advertising. The client to whom the report is issued may, however, show or send it, or a certified copy thereof prepared by the SHENZHEN TIMEWAY TESTING LABORATORIES, to his customer. Supplier or others persons directly concerned, SHENZHEN TIMEWAY TESTING LABORATORIES, will not, without the consent of the client enter into any discussion of correspondence with any third party concerning the contents of the report.

In the event of the improper use of the report, The SHENZHEN TIMEWAY TESTING LABORATORIES, reserves the rights to withdraw it and to adopt any other remedies which may be appropriate.



Test mode: Mode 2

9 kHz~30 MHz

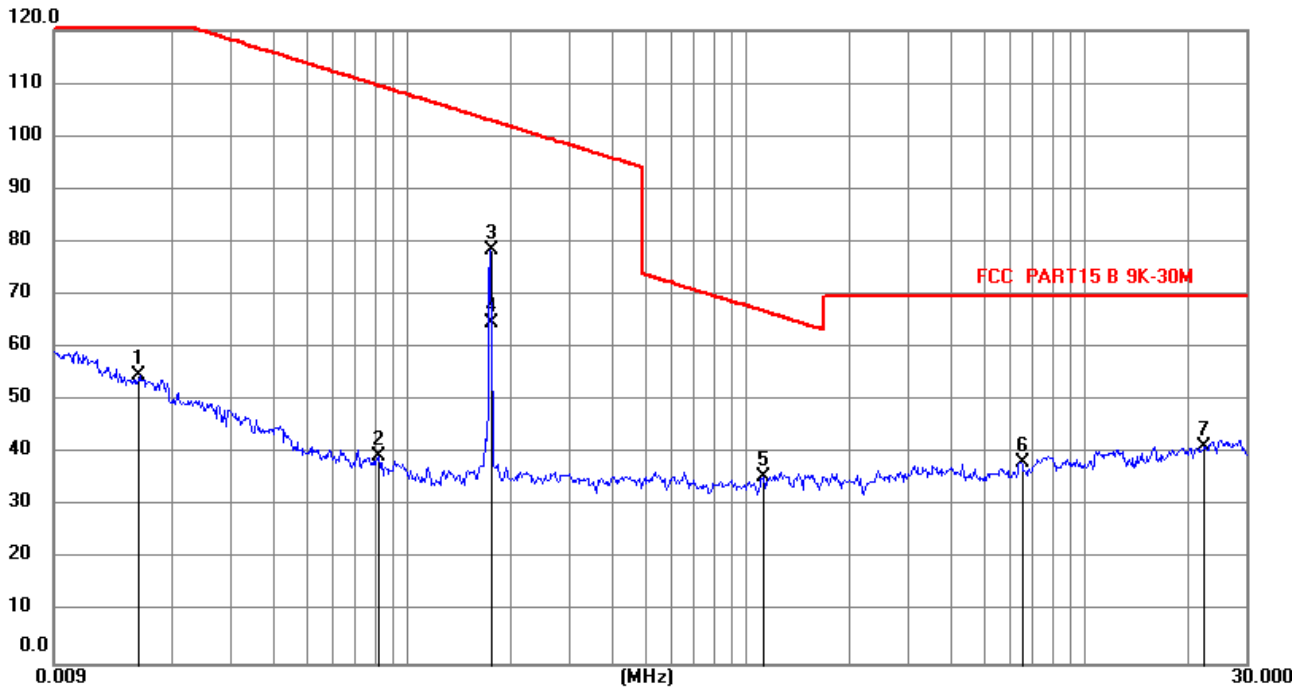

No.	Frequency (MHz)	Reading ( )	Factor (dB)	Level (dBuV/m)	Limit (dBuV/m)	Margin (dB)	Detector	P/F
1	0.0160	44.66	10.21	54.87	123.36	-68.49	peak	P
2	0.0821	29.72	9.78	39.50	109.23	-69.73	peak	P
3	0.1753	68.56	9.77	78.33	102.68	-24.35	peak	P
4	0.1753	55.02	9.77	64.79	102.68	-37.89	AVG	P
5	1.1187	25.82	9.79	35.61	66.65	-31.04	peak	P
6	6.5000	28.35	9.99	38.34	69.55	-31.21	peak	P
7	22.5625	30.32	10.84	41.16	69.59	-28.43	peak	P

The report refers only to the sample tested and does not apply to the bulk.

This report is issued in confidence to the client and it will be strictly treated as such by the SHENZHEN TIMEWAY TESTING LABORATORIES. It may not be reproduced rather in its entirety or in part and it may not be used for advertising. The client to whom the report is issued may, however, show or send it, or a certified copy thereof prepared by the SHENZHEN TIMEWAY TESTING LABORATORIES, to his customer. Supplier or others persons directly concerned. SHENZHEN TIMEWAY TESTING LABORATORIES, will not, without the consent of the client enter into any discussion of correspondence with any third party concerning the contents of the report.

In the event of the improper use of the report. The SHENZHEN TIMEWAY TESTING LABORATORIES, reserves the rights to withdraw it and to adopt any other remedies which may be appropriate.



Test mode: Mode 3

9 kHz~30 MHz

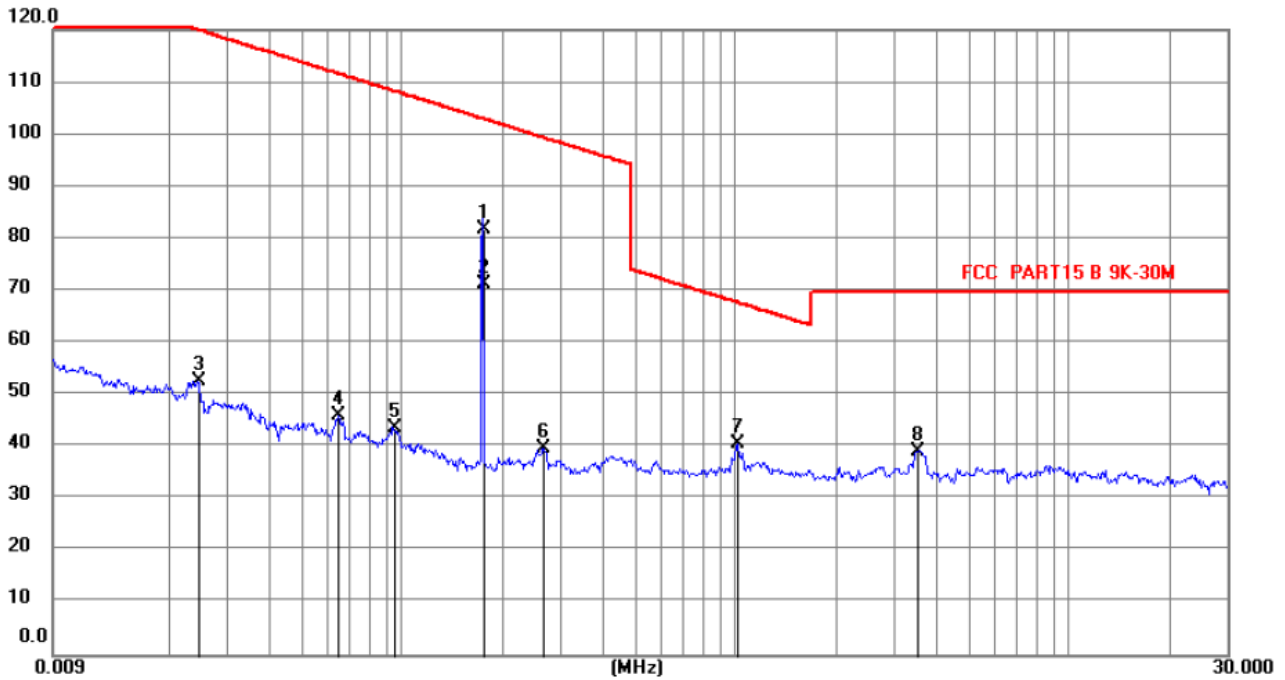

No.	Frequency (MHz)	Reading ()	Factor (dB)	Level (dBuV/m)	Limit (dBuV/m)	Margin (dB)	Detector	P/F
1	0.1753	72.10	9.77	81.87	102.68	-20.81	peak	P
2	0.1753	61.51	9.77	71.28	102.68	-31.40	AVG	P
3	0.0245	42.42	10.28	52.70	119.68	-66.98	peak	P
4	0.0646	36.18	9.77	45.95	111.30	-65.35	peak	P
5	0.0946	33.84	9.81	43.65	108.01	-64.36	peak	P
6	0.2654	29.99	9.75	39.74	99.10	-59.36	peak	P
7	1.0174	30.77	9.79	40.56	67.47	-26.91	peak	P
8	3.5261	29.21	9.87	39.08	69.53	-30.45	peak	P

The report refers only to the sample tested and does not apply to the bulk.

This report is issued in confidence to the client and it will be strictly treated as such by the SHENZHEN TIMEWAY TESTING LABORATORIES. It may not be reproduced rather in its entirety or in part and it may not be used for advertising. The client to whom the report is issued may, however, show or send it, or a certified copy thereof prepared by the SHENZHEN TIMEWAY TESTING LABORATORIES, to his customer. Supplier or others persons directly concerned. SHENZHEN TIMEWAY TESTING LABORATORIES, will not, without the consent of the client enter into any discussion of correspondence with any third party concerning the contents of the report.

In the event of the improper use of the report. The SHENZHEN TIMEWAY TESTING LABORATORIES, reserves the rights to withdraw it and to adopt any other remedies which may be appropriate.



**A. General Radiated Emission Data**

**Radiated Emission In Horizontal (30MHz---1000MHz)**

EUT set Condition: Keep Transmitting  
 Test mode: Mode 1  
**Results: Pass**

Please refer to following diagram for individual

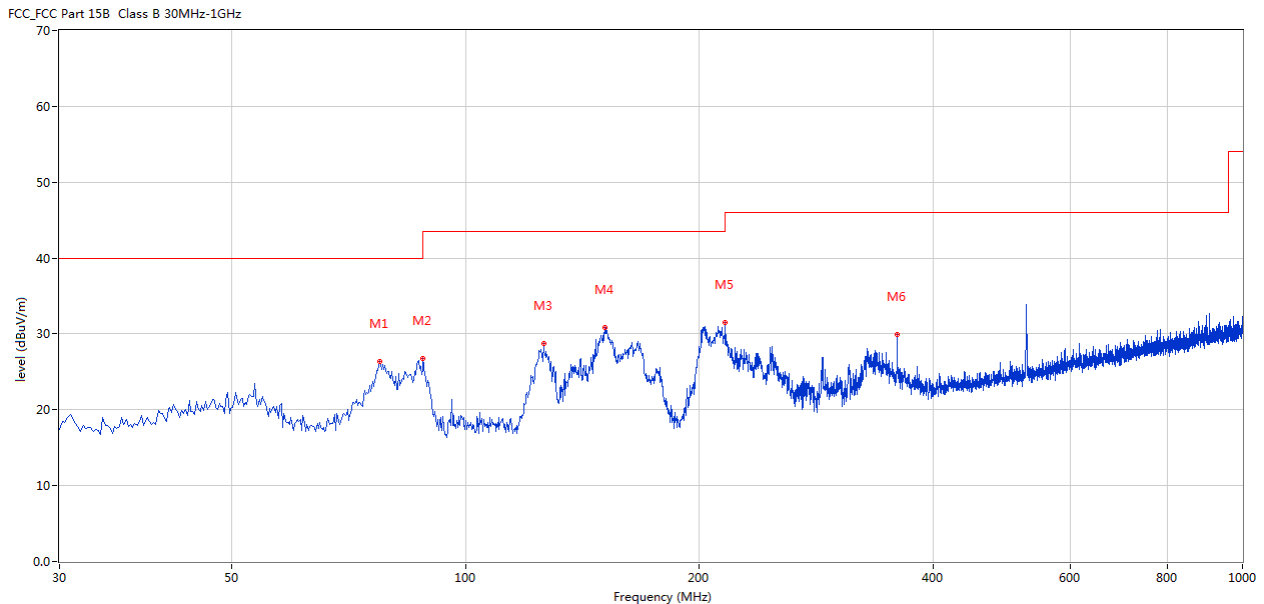

No.	Frequency (MHz)	Results (dBuV/m)	Factor (dB)	Limit (dBuV/m)	Over Limit (dB)	Detector	Table (o)	Height (cm)	ANT	Verdict
1	77.518	26.38	-17.56	40.0	-13.62	Peak	2.00	200	Horizontal	Pass
2	88.185	26.73	-15.59	43.5	-16.77	Peak	192.00	200	Horizontal	Pass
3	126.006	28.69	-16.48	43.5	-14.81	Peak	0.00	200	Horizontal	Pass
4	150.977	30.80	-16.98	43.5	-12.70	Peak	298.00	200	Horizontal	Pass
5	215.709	31.51	-13.60	43.5	-11.99	Peak	67.00	100	Horizontal	Pass
6	359.475	29.90	-9.43	46.0	-16.10	Peak	98.00	100	Horizontal	Pass

The report refers only to the sample tested and does not apply to the bulk.  
 This report is issued in confidence to the client and it will be strictly treated as such by the SHENZHEN TIMEWAY TESTING LABORATORIES. It may not be reproduced rather in its entirety or in part and it may not be used for advertising. The client to whom the report is issued may, however, show or send it . or a certified copy there of prepared by the SHENZHEN TIMEWAY TESTING LABORATORIES. to his customer. Supplier or others persons directly concerned. SHENZHEN TIMEWAY TESTING LABORATORIES. will not, without the consent of the client enter into any discussion of correspondence with any third party concerning the contents of the report.  
 In the event of the improper use of the report. The SHENZHEN TIMEWAY TESTING LABORATORIES. reserves the rights to withdraw it and to adopt any other remedies which may be appropriate.



**B. General Radiated Emission Data**

**Radiated Emission In Vertical (30MHz----1000MHz)**

EUT set Condition: Keep Transmitting  
 Test mode: Mode 1  
**Results: Pass**

Please refer to following diagram for individual

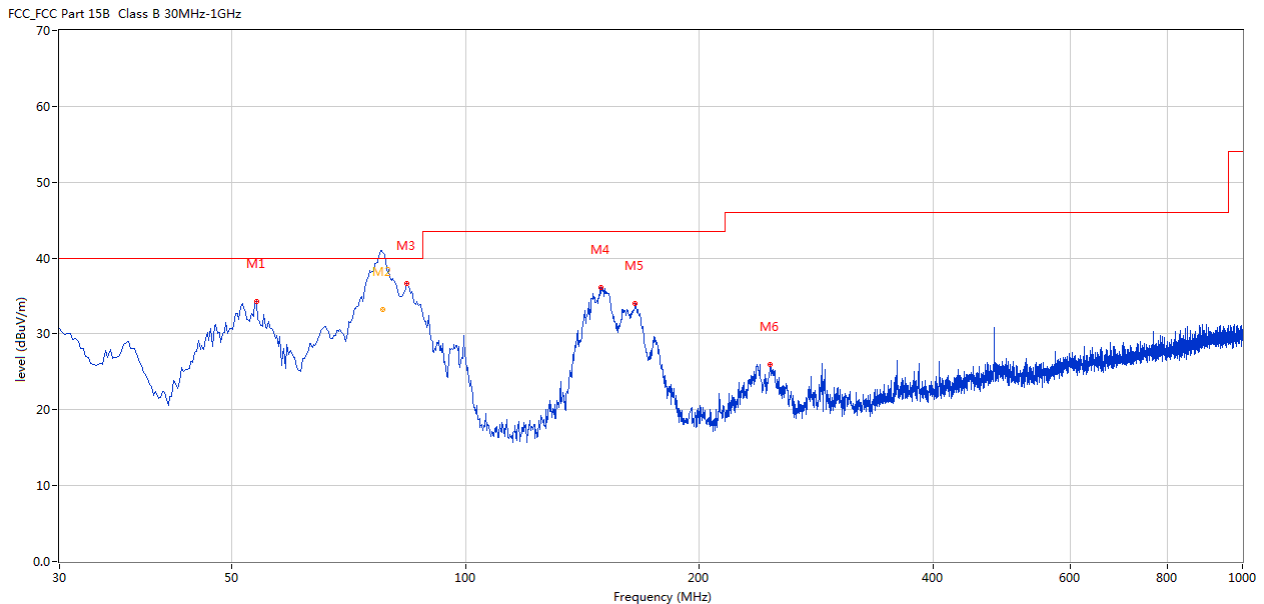

No.	Frequency (MHz)	Results (dBuV/m)	Factor (dB)	Limit (dBuV/m)	Over Limit (dB)	Detector	Table (o)	Height (cm)	ANT	Verdict
1	53.759	34.33	-11.53	40.0	-5.67	Peak	208.00	100	Vertical	Pass
2	78.116	36.52	-17.52	40.0	-3.48	Peak	45.00	100	Vertical	Pass
2*	78.116	33.23	-17.52	40.0	-6.77	QP	45.00	100	Vertical	Pass
3	84.064	36.68	-16.72	40.0	-3.32	Peak	170.00	100	Vertical	Pass
4	149.280	36.06	-17.09	43.5	-7.44	Peak	282.00	100	Vertical	Pass
5	165.281	34.00	-16.18	43.5	-9.50	Peak	269.00	100	Vertical	Pass
6	246.741	25.98	-12.13	46.0	-20.02	Peak	252.00	100	Vertical	Pass

The report refers only to the sample tested and does not apply to the bulk.  
 This report is issued in confidence to the client and it will be strictly treated as such by the SHENZHEN TIMEWAY TESTING LABORATORIES. It may not be reproduced rather in its entirety or in part and it may not be used for advertising. The client to whom the report is issued may, however, show or send it, or a certified copy thereof prepared by the SHENZHEN TIMEWAY TESTING LABORATORIES, to his customer. Supplier or others persons directly concerned. SHENZHEN TIMEWAY TESTING LABORATORIES, will not, without the consent of the client enter into any discussion of correspondence with any third party concerning the contents of the report.  
 In the event of the improper use of the report. The SHENZHEN TIMEWAY TESTING LABORATORIES, reserves the rights to withdraw it and to adopt any other remedies which may be appropriate.



**C. General Radiated Emission Data**

**Radiated Emission In Horizontal (30MHz----1000MHz)**

EUT set Condition: Keep Transmitting  
 Test mode: Mode 2  
**Results: Pass**

Please refer to following diagram for individual

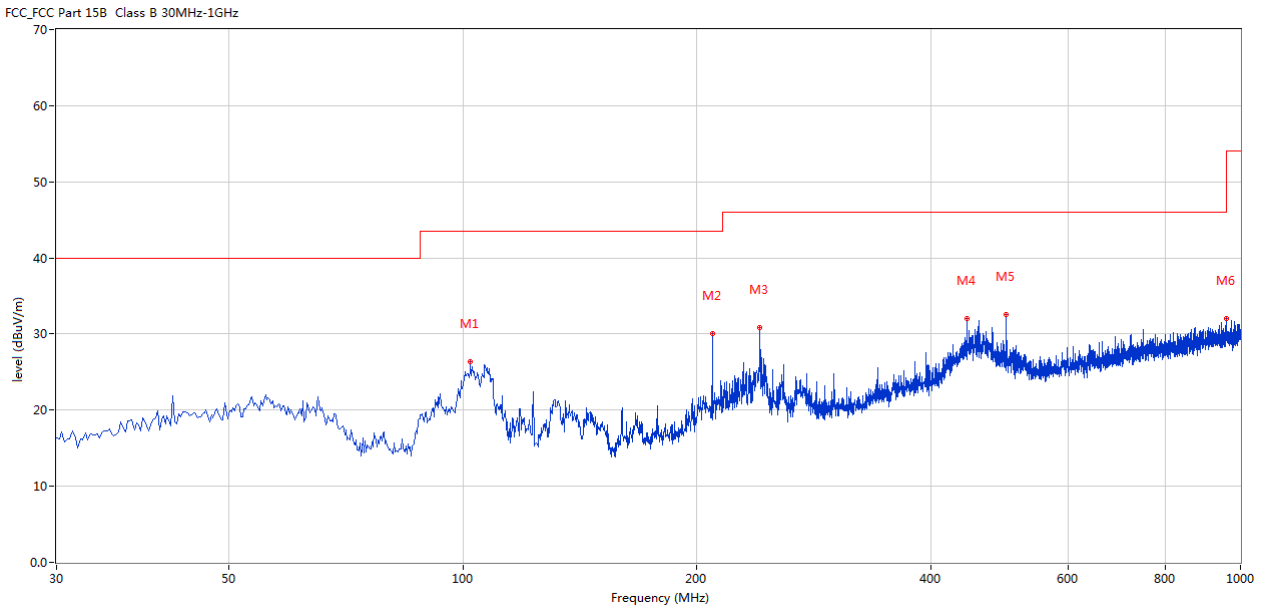

No.	Frequency (MHz)	Results (dBuV/m)	Factor (dB)	Limit (dBuV/m)	Over Limit (dB)	Detector	Table (o)	Height (cm)	ANT	Verdict
1	102.247	26.39	-13.42	43.5	-17.11	Peak	3.00	200	Horizontal	Pass
2	209.405	30.02	-13.60	43.5	-13.48	Peak	113.00	200	Horizontal	Pass
3	240.922	30.85	-12.35	46.0	-15.15	Peak	113.00	200	Horizontal	Pass
4	444.814	32.07	-7.98	46.0	-13.93	Peak	84.00	200	Horizontal	Pass
5	500.090	32.56	-6.91	46.0	-13.44	Peak	179.00	200	Horizontal	Pass
6	958.300	32.10	-1.66	46.0	-13.90	Peak	150.00	200	Horizontal	Pass

The report refers only to the sample tested and does not apply to the bulk.  
 This report is issued in confidence to the client and it will be strictly treated as such by the SHENZHEN TIMEWAY TESTING LABORATORIES. It may not be reproduced in its entirety or in part and it may not be used for advertising. The client to whom the report is issued may, however, show or send it, or a certified copy thereof prepared by the SHENZHEN TIMEWAY TESTING LABORATORIES, to his customer. Supplier or others persons directly concerned. SHENZHEN TIMEWAY TESTING LABORATORIES, will not, without the consent of the client enter into any discussion of correspondence with any third party concerning the contents of the report.  
 In the event of the improper use of the report. The SHENZHEN TIMEWAY TESTING LABORATORIES, reserves the rights to withdraw it and to adopt any other remedies which may be appropriate.





**D. General Radiated Emission Data**

**Radiated Emission In Vertical (30MHz----1000MHz)**

EUT set Condition: Keep Transmitting  
 Test mode: Mode 2  
**Results: Pass**

Please refer to following diagram for individual

FCC\_FCC Part 15B Class B 30MHz-1GHz

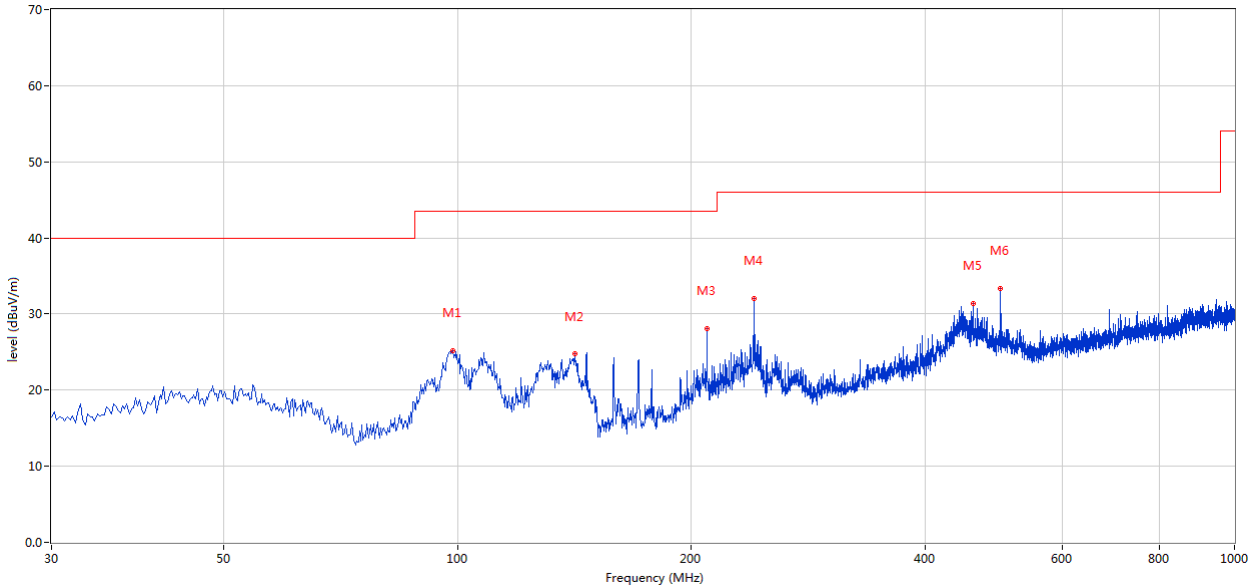

No.	Frequency (MHz)	Results (dBuV/m)	Factor (dB)	Limit (dBuV/m)	Over Limit (dB)	Detector	Table (o)	Height (cm)	ANT	Verdict
1	98.610	25.19	-13.70	43.5	-18.31	Peak	12.00	200	Vertical	Pass
2	141.765	24.72	-17.29	43.5	-18.78	Peak	0.00	200	Vertical	Pass
3	209.405	28.14	-13.60	43.5	-15.36	Peak	108.00	200	Vertical	Pass
4	240.922	32.01	-12.35	46.0	-13.99	Peak	100.00	200	Vertical	Pass
5	460.815	31.44	-7.85	46.0	-14.56	Peak	108.00	200	Vertical	Pass
6	500.090	33.39	-6.91	46.0	-12.61	Peak	189.00	200	Vertical	Pass

The report refers only to the sample tested and does not apply to the bulk.  
 This report is issued in confidence to the client and it will be strictly treated as such by the SHENZHEN TIMEWAY TESTING LABORATORIES. It may not be reproduced in its entirety or in part and it may not be used for advertising. The client to whom the report is issued may, however, show or send it, or a certified copy thereof prepared by the SHENZHEN TIMEWAY TESTING LABORATORIES, to his customer. Supplier or others persons directly concerned. SHENZHEN TIMEWAY TESTING LABORATORIES, will not, without the consent of the client enter into any discussion of correspondence with any third party concerning the contents of the report.  
 In the event of the improper use of the report. The SHENZHEN TIMEWAY TESTING LABORATORIES, reserves the rights to withdraw it and to adopt any other remedies which may be appropriate.



**E. General Radiated Emission Data**

**Radiated Emission In Horizontal (30MHz---1000MHz)**

EUT set Condition: Keep Transmitting  
 Test mode: Mode 3  
**Results: Pass**

Please refer to following diagram for individual

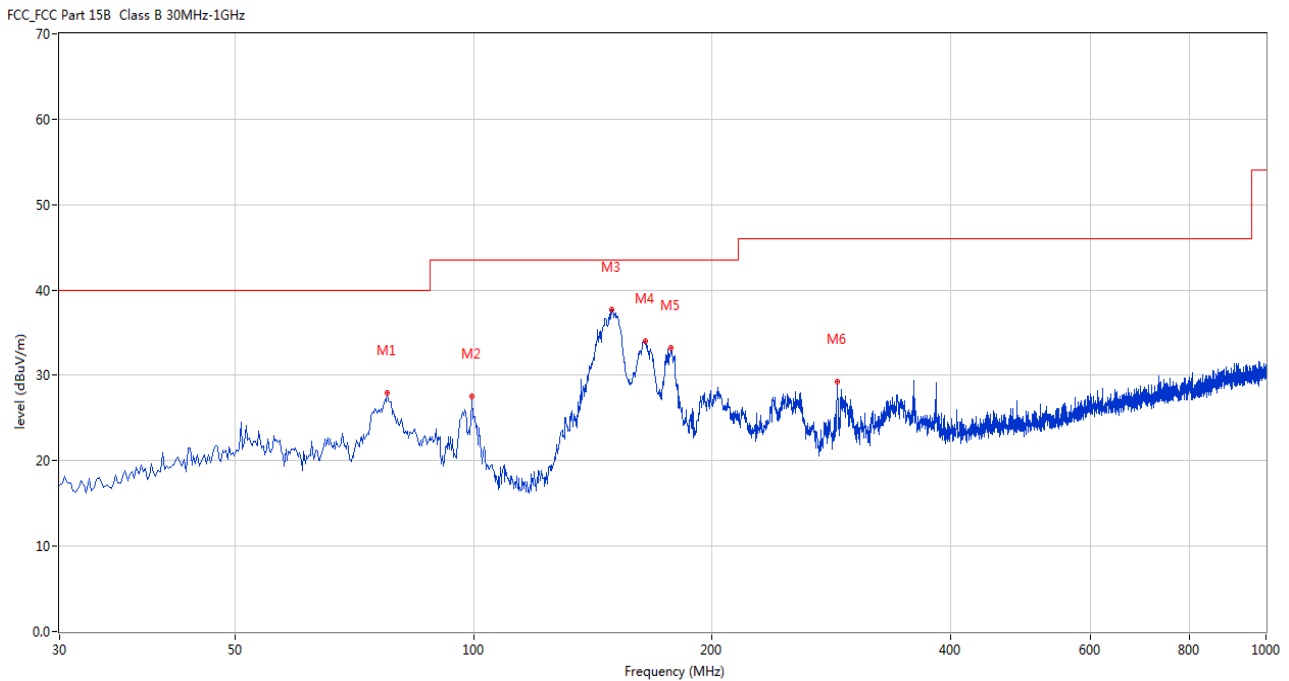

No.	Frequency (MHz)	Results (dBuV/m)	Factor (dB)	Limit (dBuV/m)	Over Limit (dB)	Detector	Table (o)	Height (cm)	ANT	Verdict
1	77.761	27.97	-17.54	40.0	-12.03	Peak	219.00	200	Horizontal	Pass
2	99.580	27.58	-13.60	43.5	-15.92	Peak	211.00	200	Horizontal	Pass
3	149.280	37.76	-17.09	43.5	-5.74	Peak	1.00	200	Horizontal	Pass
4	164.554	34.07	-16.25	43.5	-9.43	Peak	360.00	200	Horizontal	Pass
5	177.403	33.18	-15.66	43.5	-10.32	Peak	329.00	100	Horizontal	Pass
6	287.956	29.27	-11.27	46.0	-16.73	Peak	312.00	100	Horizontal	Pass

The report refers only to the sample tested and does not apply to the bulk.  
 This report is issued in confidence to the client and it will be strictly treated as such by the SHENZHEN TIMEWAY TESTING LABORATORIES. It may not be reproduced in its entirety or in part and it may not be used for advertising. The client to whom the report is issued may, however, show or send it, or a certified copy thereof prepared by the SHENZHEN TIMEWAY TESTING LABORATORIES, to his customer. Supplier or others persons directly concerned. SHENZHEN TIMEWAY TESTING LABORATORIES, will not, without the consent of the client enter into any discussion of correspondence with any third party concerning the contents of the report.  
 In the event of the improper use of the report. The SHENZHEN TIMEWAY TESTING LABORATORIES, reserves the rights to withdraw it and to adopt any other remedies which may be appropriate.



**F. General Radiated Emission Data**

**Radiated Emission In Vertical (30MHz----1000MHz)**

EUT set Condition: Keep Transmitting  
 Test mode: Mode 3  
**Results: Pass**

Please refer to following diagram for individual

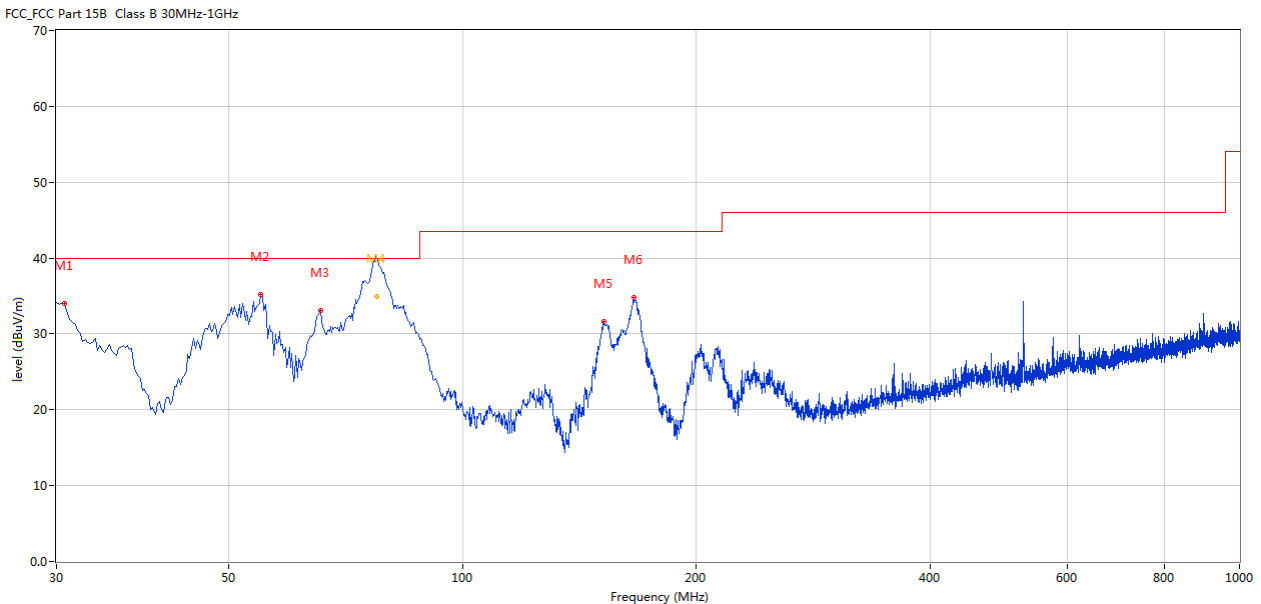

No.	Frequency (MHz)	Results (dBuV/m)	Factor (dB)	Limit (dBuV/m)	Over Limit (dB)	Detector	Table (o)	Height (cm)	ANT	Verdict
1	30.727	33.97	-14.51	40.0	-6.03	Peak	15.00	100	Vertical	Pass
2	54.971	35.17	-11.77	40.0	-4.83	Peak	269.00	100	Vertical	Pass
3	65.639	33.12	-13.79	40.0	-6.88	Peak	28.00	100	Vertical	Pass
4	77.466	38.36	-17.58	40.0	-1.64	Peak	209.00	200	Vertical	Pass
4*	77.466	35.00	-17.58	40.0	-5.00	QP	209.00	200	Vertical	Pass
5	151.947	31.70	-16.93	43.5	-11.80	Peak	256.00	100	Vertical	Pass
6	166.008	34.78	-16.10	43.5	-8.72	Peak	251.00	100	Vertical	Pass

The report refers only to the sample tested and does not apply to the bulk.  
 This report is issued in confidence to the client and it will be strictly treated as such by the SHENZHEN TIMEWAY TESTING LABORATORIES. It may not be reproduced rather in its entirety or in part and it may not be used for advertising. The client to whom the report is issued may, however, show or send it, or a certified copy thereof prepared by the SHENZHEN TIMEWAY TESTING LABORATORIES, to his customer. Supplier or others persons directly concerned. SHENZHEN TIMEWAY TESTING LABORATORIES, will not, without the consent of the client enter into any discussion of correspondence with any third party concerning the contents of the report.  
 In the event of the improper use of the report. The SHENZHEN TIMEWAY TESTING LABORATORIES, reserves the rights to withdraw it and to adopt any other remedies which may be appropriate.



## 7.0 20dB Bandwidth Testing

### 7.1 Test Procedure

With the EUT's antenna attached, the EUT's 20dB Bandwidth was received by the test antenna which was connected to the spectrum analyzer with the START and STOP frequencies set to the EUT's operation band.

### 7.3 Test Data

#### Test Mode 1

Frequency (MHz)	20dB Bandwidth Emission (kHz)	Limit (kHz)	Result
0.175	2.93	--	Pass

#### Test Mode 2

Frequency (MHz)	20dB Bandwidth Emission (kHz)	Limit (kHz)	Result
0.175	2.93	--	Pass

#### Test Mode 3

Frequency (MHz)	20dB Bandwidth Emission (kHz)	Limit (kHz)	Result
0.175	2.93	--	Pass

Refer to attached plots:

The report refers only to the sample tested and does not apply to the bulk.

This report is issued in confidence to the client and it will be strictly treated as such by the SHENZHEN TIMEWAY TESTING LABORATORIES. It may not be reproduced rather in its entirety or in part and it may not be used for advertising. The client to whom the report is issued may, however, show or send it, or a certified copy thereof prepared by the SHENZHEN TIMEWAY TESTING LABORATORIES, to his customer. Supplier or others persons directly concerned. SHENZHEN TIMEWAY TESTING LABORATORIES, will not, without the consent of the client enter into any discussion of correspondence with any third party concerning the contents of the report.

In the event of the improper use of the report. The SHENZHEN TIMEWAY TESTING LABORATORIES, reserves the rights to withdraw it and to adopt any other remedies which may be appropriate.



20dB Bandwidth

Mode 1

	Marker 1 [T1]	RBW	1 kHz	RF Att	10 dB
	Ref Lvl	-33.82 dBm	VBW	3 kHz	
	-20 dBm	175.07014028 kHz	SWT	150 ms	Unit dBm

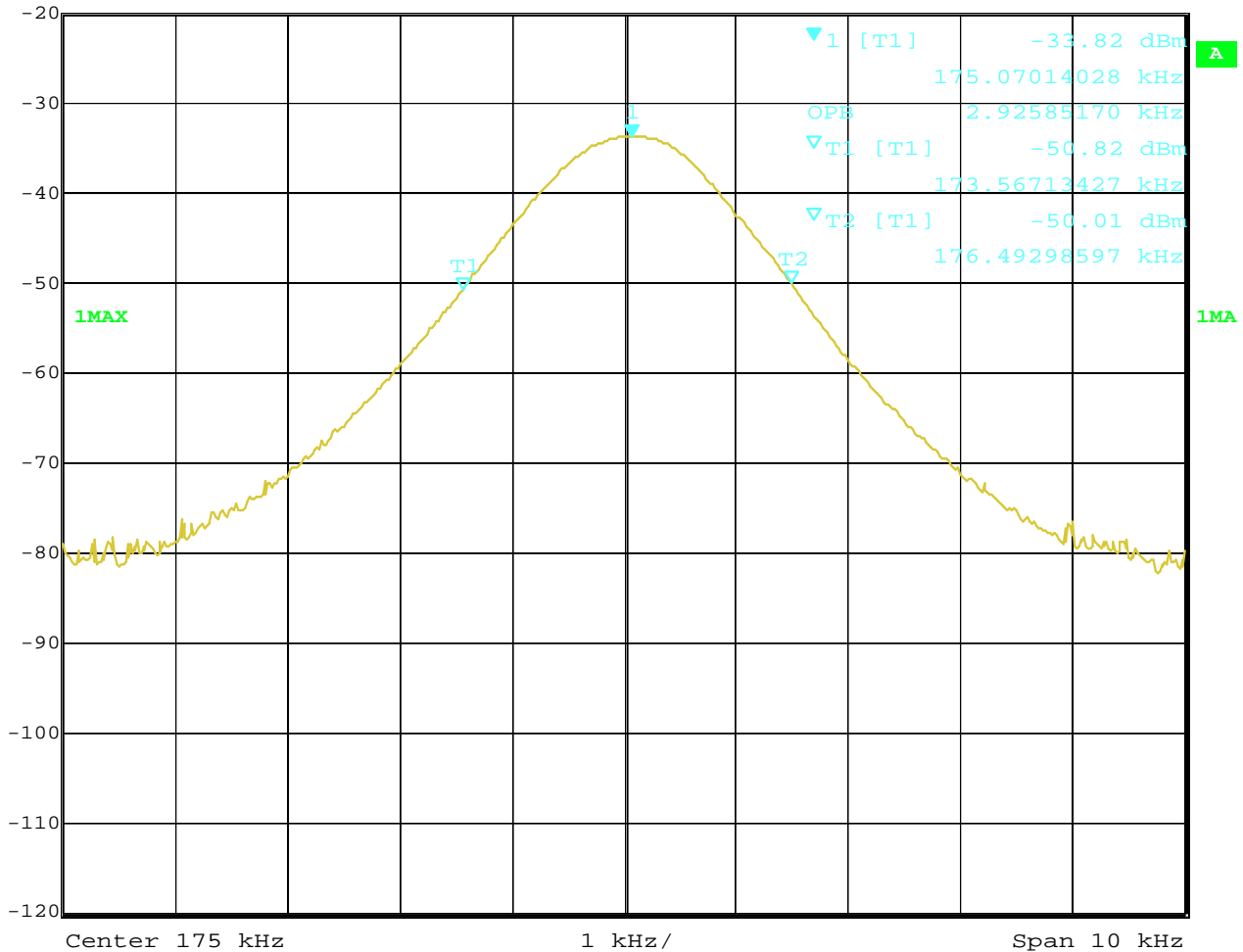

Date: 28.APR.2023 14:31:01

The report refers only to the sample tested and does not apply to the bulk. This report is issued in confidence to the client and it will be strictly treated as such by the SHENZHEN TIMEWAY TESTING LABORATORIES. It may not be reproduced rather in its entirety or in part and it may not be used for advertising. The client to whom the report is issued may, however, show or send it . or a certified copy there of prepared by the SHENZHEN TIMEWAY TESTING LABORATORIES. to his customer. Supplier or others persons directly concerned. SHENZHEN TIMEWAY TESTING LABORATORIES. will not, without the consent of the client enter into any discussion of correspondence with any third party concerning the contents of the report. In the event of the improper use of the report. The SHENZHEN TIMEWAY TESTING LABORATORIES. reserves the rights to withdraw it and to adopt any other remedies which may be appropriate.



Mode 2



Ref Lvl	Marker 1 [T1]	RBW	1 kHz	RF Att	20 dB
-20 dBm	-33.79 dBm	VBW	3 kHz		
	175.09018036 kHz	SWT	150 ms	Unit	dBm

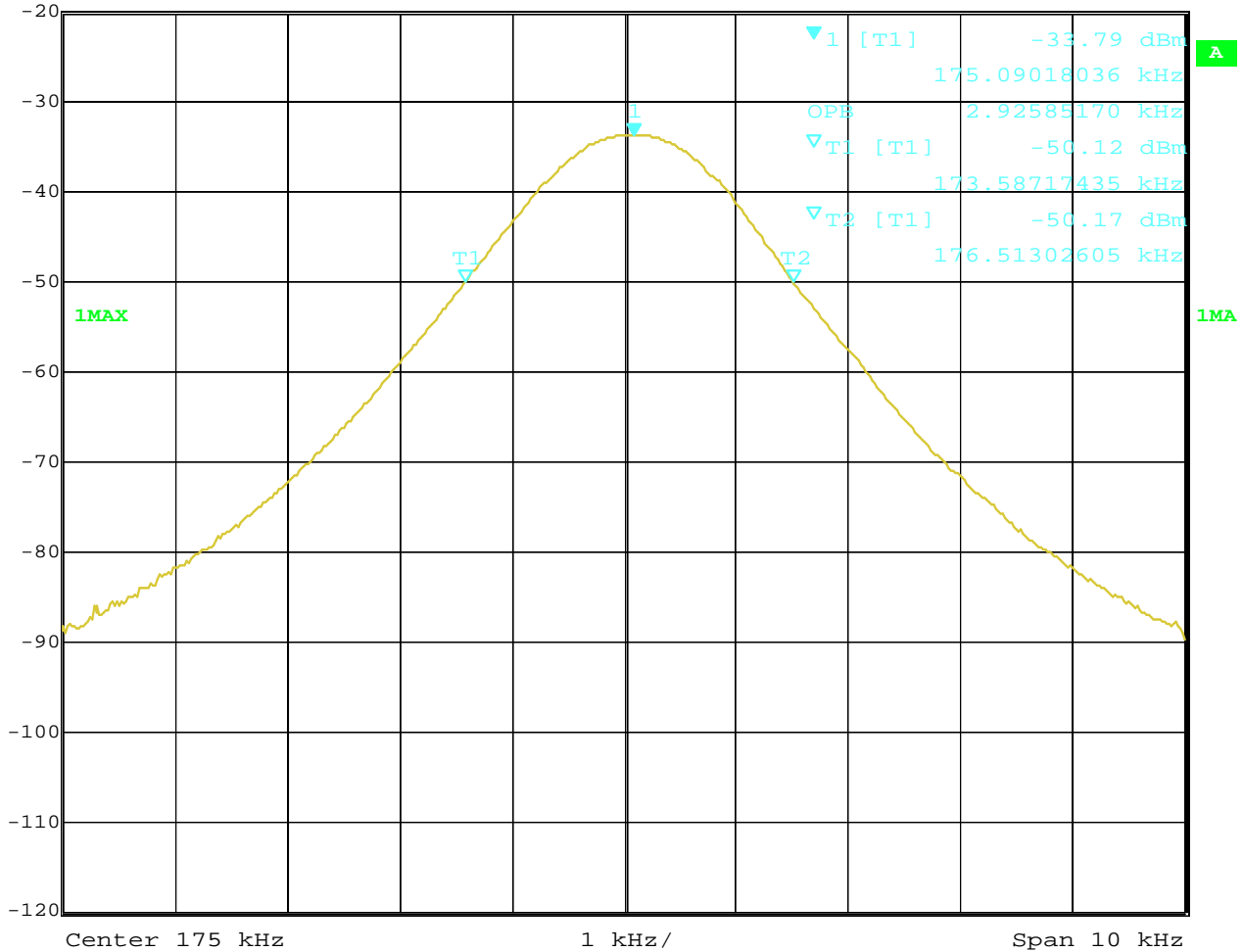

Date: 8.MAY.2023 18:09:55

The report refers only to the sample tested and does not apply to the bulk.  
 This report is issued in confidence to the client and it will be strictly treated as such by the SHENZHEN TIMEWAY TESTING LABORATORIES. It may not be reproduced rather in its entirety or in part and it may not be used for advertising. The client to whom the report is issued may, however, show or send it, or a certified copy thereof prepared by the SHENZHEN TIMEWAY TESTING LABORATORIES, to his customer. Supplier or others persons directly concerned. SHENZHEN TIMEWAY TESTING LABORATORIES, will not, without the consent of the client enter into any discussion of correspondence with any third party concerning the contents of the report.  
 In the event of the improper use of the report. The SHENZHEN TIMEWAY TESTING LABORATORIES, reserves the rights to withdraw it and to adopt any other remedies which may be appropriate.



Mode 3



	Marker 1 [T1]	RBW	1 kHz	RF Att	20 dB
Ref Lvl	-33.79 dBm	VBW	3 kHz		
-20 dBm	175.03006012 kHz	SWT	150 ms	Unit	dBm

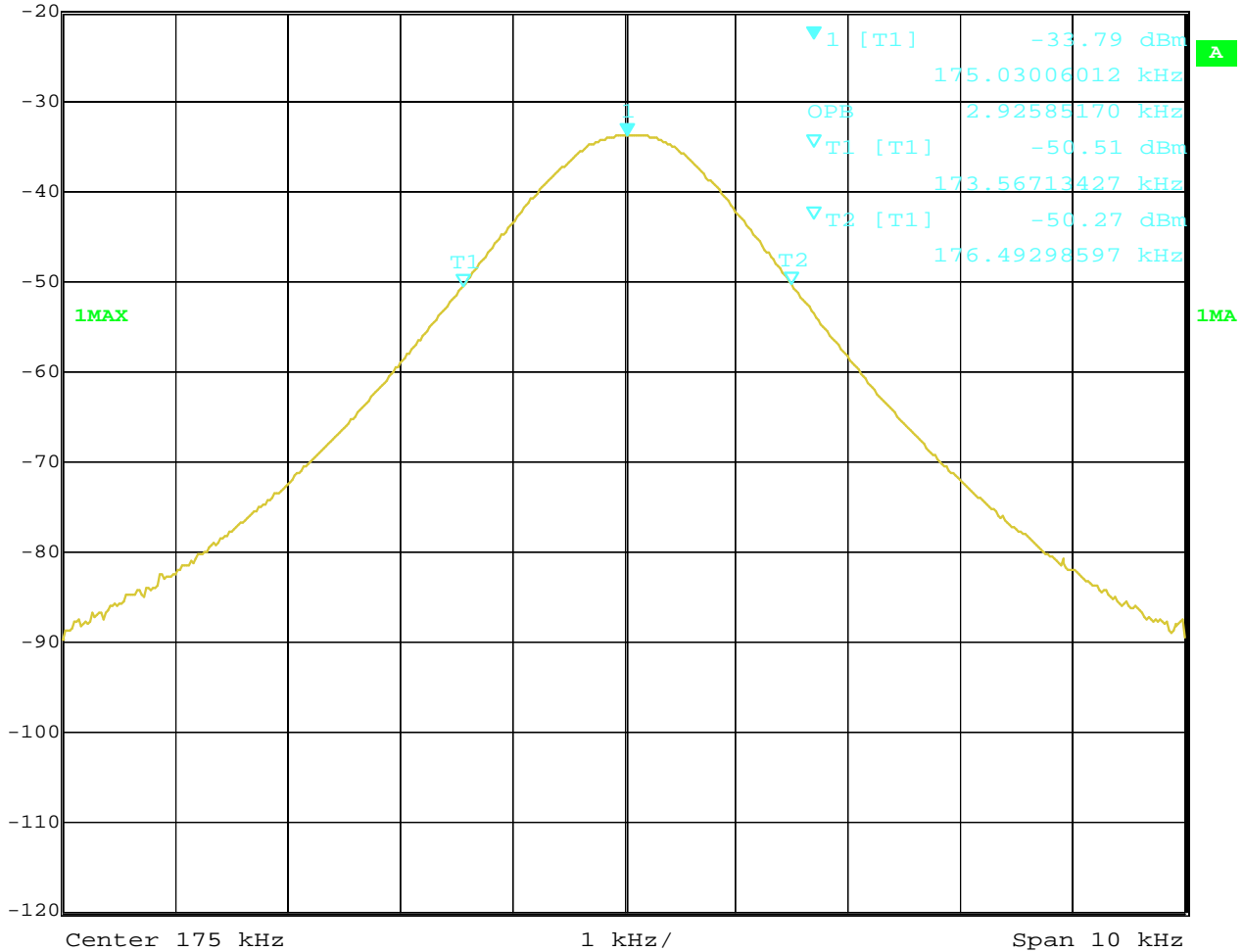

Date: 8.MAY.2023 18:10:34

The report refers only to the sample tested and does not apply to the bulk.  
 This report is issued in confidence to the client and it will be strictly treated as such by the SHENZHEN TIMEWAY TESTING LABORATORIES. It may not be reproduced rather in its entirety or in part and it may not be used for advertising. The client to whom the report is issued may, however, show or send it . or a certified copy there of prepared by the SHENZHEN TIMEWAY TESTING LABORATORIES. to his customer. Supplier or others persons directly concerned. SHENZHEN TIMEWAY TESTING LABORATORIES. will not, without the consent of the client enter into any discussion of correspondence with any third party concerning the contents of the report.  
 In the event of the improper use of the report. The SHENZHEN TIMEWAY TESTING LABORATORIES. reserves the rights to withdraw it and to adopt any other remedies which may be appropriate.



## 8.0 Antenna Requirement

### 8.1 Standard Applicable

An intentional radiator shall be designed to ensure that no antenna other than that furnished by the responsible party shall be used with the device. The use of a permanently attached antenna or of an antenna that uses a unique coupling to the intentional radiator shall be considered sufficient to comply with the provisions of this Section. The manufacturer may design the unit so that a broken antenna can be replaced by the user, but the use of a standard antenna jack or electrical connector is prohibited. This requirement does not apply to carrier current devices or to devices operated under the provisions of Sections 15.211, 15.213, 15.217, 15.219, or 15.221. Further, this requirement does not apply to intentional radiators that must be professionally installed, such as perimeter protection systems and some field disturbance sensors, or to other intentional radiators which, in accordance with Section 15.31(d), must be measured at the installation site. However, the installer shall be responsible for ensuring that the proper antenna is employed so that the limits in this Part are not exceeded.

### 8.2 Antenna Connected constructions

The antenna is Inductive Loop Antenna. The antenna gain is 0dBi for each one. So it meets the requirement of 15.203

The report refers only to the sample tested and does not apply to the bulk.

This report is issued in confidence to the client and it will be strictly treated as such by the SHENZHEN TIMEWAY TESTING LABORATORIES. It may not be reproduced rather in its entirety or in part and it may not be used for advertising. The client to whom the report is issued may, however, show or send it . or a certified copy there of prepared by the SHENZHEN TIMEWAY TESTING LABORATORIES. to his customer. Supplier or others persons directly concerned. SHENZHEN TIMEWAY TESTING LABORATORIES. will not, without the consent of the client enter into any discussion of correspondence with any third party concerning the contents of the report.

In the event of the improper use of the report. The SHENZHEN TIMEWAY TESTING LABORATORIES. reserves the rights to withdraw it and to adopt any other remedies which may be appropriate.





**9.0 FCC ID Label**

**FCC ID: 2APYY-AB0427**

This device complies with Part 15 of the FCC Rules. Operation is subject to the following two conditions: (1) this device may not cause harmful interference, and (2) this device must accept any interference received, including interference that may cause undesired operation

The label must not be a stick-on paper label. The label on these products must be permanently affixed to the product and readily visible at the time of purchase and must last the expected lifetime of the equipment not be readily detachable.

**Mark Location:**



The report refers only to the sample tested and does not apply to the bulk.  
This report is issued in confidence to the client and it will be strictly treated as such by the SHENZHEN TIMEWAY TESTING LABORATORIES. It may not be reproduced rather in its entirety or in part and it may not be used for advertising. The client to whom the report is issued may, however, show or send it, or a certified copy thereof prepared by the SHENZHEN TIMEWAY TESTING LABORATORIES, to his customer, supplier or other persons directly concerned. SHENZHEN TIMEWAY TESTING LABORATORIES will not, without the consent of the client enter into any discussion of correspondence with any third party concerning the contents of the report.  
In the event of the improper use of the report, the SHENZHEN TIMEWAY TESTING LABORATORIES reserves the rights to withdraw it and to adopt any other remedies which may be appropriate.



**10.0. Photo of testing**

10.1 Conducted test View



The report refers only to the sample tested and does not apply to the bulk.

This report is issued in confidence to the client and it will be strictly treated as such by the SHENZHEN TIMEWAY TESTING LABORATORIES. It may not be reproduced rather in its entirety or in part and it may not be used for advertizing. The client to whom the report is issued may, however, show or send it . or a certified copy there of prepared by the SHENZHEN TIMEWAY TESTING LABORATORIES. to his customer. Supplier or others persons directly concerned. SHENZHEN TIMEWAY TESTING LABORATORIES. will not, without the consent of the client enter into any discussion of correspondence with any third party concerning the contents of the report.

In the event of the improper use of the report. The SHENZHEN TIMEWAY TESTING LABORATORIES. reserves the rights to withdraw it and to adopt any other remedies which may be appropriate.

10.2 Radiated emission test view

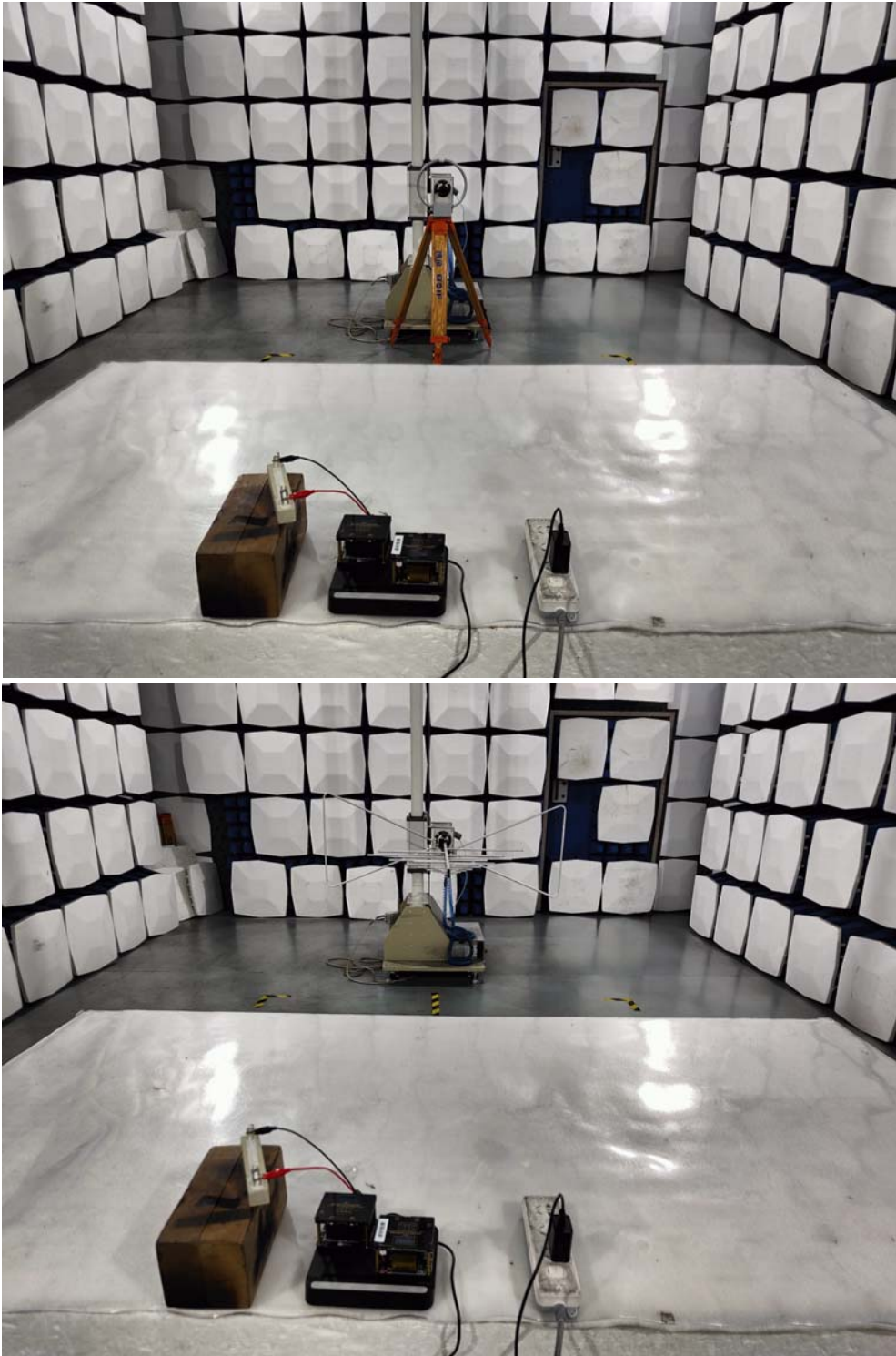

The report refers only to the sample tested and does not apply to the bulk.  
This report is issued in confidence to the client and it will be strictly treated as such by the SHENZHEN TIMEWAY TESTING LABORATORIES. It may not be reproduced rather in its entirety or in part and it may not be used for advertising. The client to whom the report is issued may, however, show or send it . or a certified copy there of prepared by the SHENZHEN TIMEWAY TESTING LABORATORIES. to his customer. Supplier or others persons directly concerned. SHENZHEN TIMEWAY TESTING LABORATORIES. will not, without the consent of the client enter into any discussion of correspondence with any third party concerning the contents of the report.  
In the event of the improper use of the report. The SHENZHEN TIMEWAY TESTING LABORATORIES. reserves the rights to withdraw it and to adopt any other remedies which may be appropriate.

Photo for the EUT

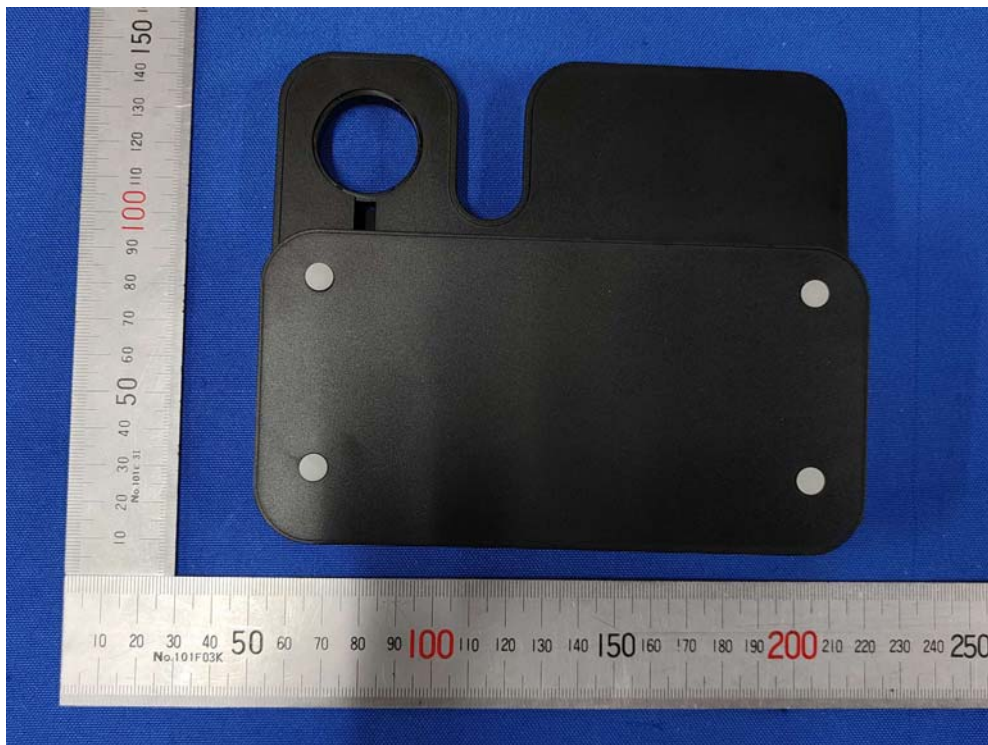

The report refers only to the sample tested and does not apply to the bulk.

This report is issued in confidence to the client and it will be strictly treated as such by the SHENZHEN TIMEWAY TESTING LABORATORIES. It may not be reproduced rather in its entirety or in part and it may not be used for advertising. The client to whom the report is issued may, however, show or send it, or a certified copy thereof prepared by the SHENZHEN TIMEWAY TESTING LABORATORIES, to his customer. Supplier or others persons directly concerned. SHENZHEN TIMEWAY TESTING LABORATORIES, will not, without the consent of the client enter into any discussion of correspondence with any third party concerning the contents of the report.

In the event of the improper use of the report. The SHENZHEN TIMEWAY TESTING LABORATORIES, reserves the rights to withdraw it and to adopt any other remedies which may be appropriate.

Photo for the EUT



The report refers only to the sample tested and does not apply to the bulk.

This report is issued in confidence to the client and it will be strictly treated as such by the SHENZHEN TIMEWAY TESTING LABORATORIES. It may not be reproduced in its entirety or in part and it may not be used for advertising. The client to whom the report is issued may, however, show or send it, or a certified copy thereof prepared by the SHENZHEN TIMEWAY TESTING LABORATORIES, to his customer, supplier or other persons directly concerned. SHENZHEN TIMEWAY TESTING LABORATORIES will not, without the consent of the client, enter into any discussion of correspondence with any third party concerning the contents of the report.

In the event of the improper use of the report, the SHENZHEN TIMEWAY TESTING LABORATORIES reserves the rights to withdraw it and to adopt any other remedies which may be appropriate.

Photo for the EUT

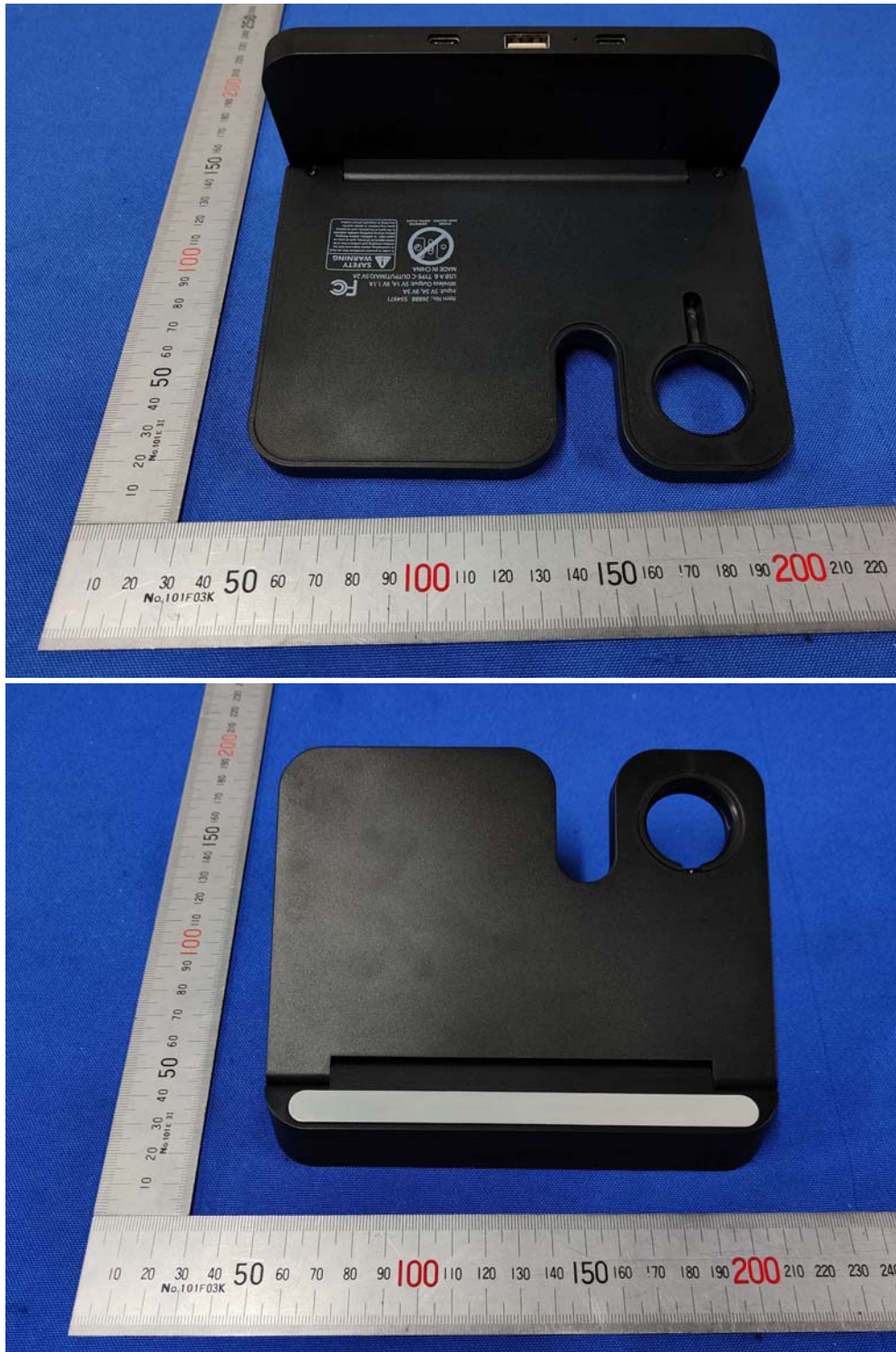

The report refers only to the sample tested and does not apply to the bulk.

This report is issued in confidence to the client and it will be strictly treated as such by the SHENZHEN TIMEWAY TESTING LABORATORIES. It may not be reproduced in its entirety or in part and it may not be used for advertising. The client to whom the report is issued may, however, show or send it, or a certified copy thereof prepared by the SHENZHEN TIMEWAY TESTING LABORATORIES, to his customer, supplier or other persons directly concerned. SHENZHEN TIMEWAY TESTING LABORATORIES will not, without the consent of the client, enter into any discussion of correspondence with any third party concerning the contents of the report.

In the event of the improper use of the report, the SHENZHEN TIMEWAY TESTING LABORATORIES reserves the rights to withdraw it and to adopt any other remedies which may be appropriate.

Photo for the EUT



The report refers only to the sample tested and does not apply to the bulk.

This report is issued in confidence to the client and it will be strictly treated as such by the SHENZHEN TIMEWAY TESTING LABORATORIES. It may not be reproduced rather in its entirety or in part and it may not be used for advertising. The client to whom the report is issued may, however, show or send it . or a certified copy there of prepared by the SHENZHEN TIMEWAY TESTING LABORATORIES. to his customer. Supplier or others persons directly concerned. SHENZHEN TIMEWAY TESTING LABORATORIES. will not, without the consent of the client enter into any discussion of correspondence with any third party concerning the contents of the report.

In the event of the improper use of the report. The SHENZHEN TIMEWAY TESTING LABORATORIES. reserves the rights to withdraw it and to adopt any other remedies which may be appropriate.

Photo for the EUT



The report refers only to the sample tested and does not apply to the bulk.

This report is issued in confidence to the client and it will be strictly treated as such by the SHENZHEN TIMEWAY TESTING LABORATORIES. It may not be reproduced rather in its entirety or in part and it may not be used for advertising. The client to whom the report is issued may, however, show or send it, or a certified copy thereof prepared by the SHENZHEN TIMEWAY TESTING LABORATORIES, to his customer. Supplier or others persons directly concerned. SHENZHEN TIMEWAY TESTING LABORATORIES, will not, without the consent of the client enter into any discussion of correspondence with any third party concerning the contents of the report.

In the event of the improper use of the report. The SHENZHEN TIMEWAY TESTING LABORATORIES, reserves the rights to withdraw it and to adopt any other remedies which may be appropriate.



Photo for the EUT

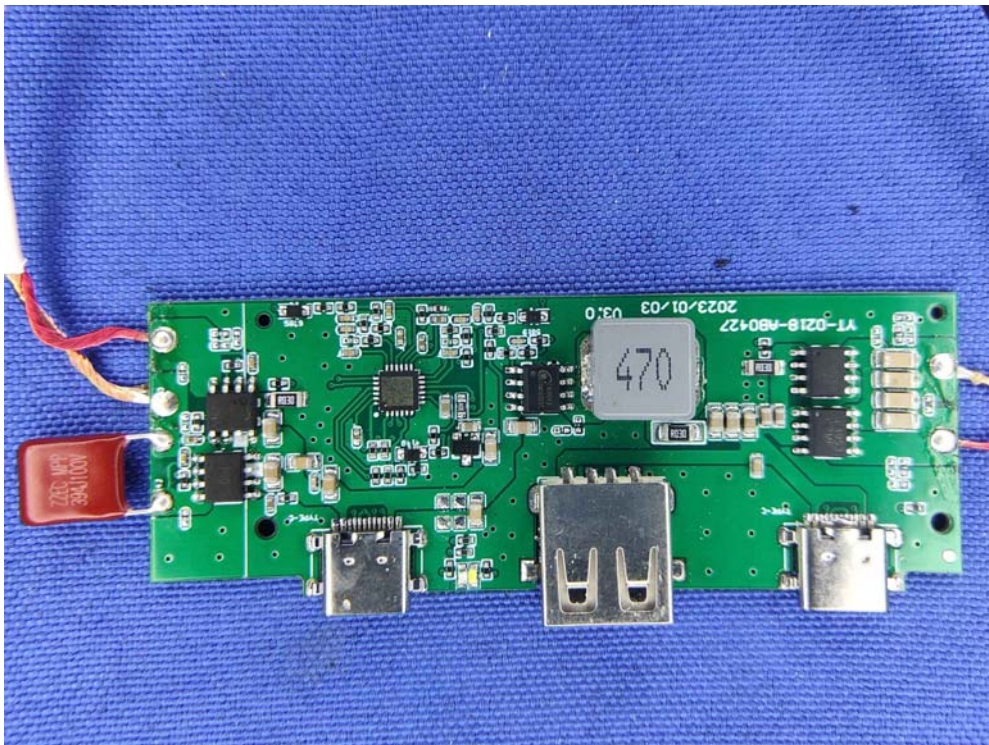
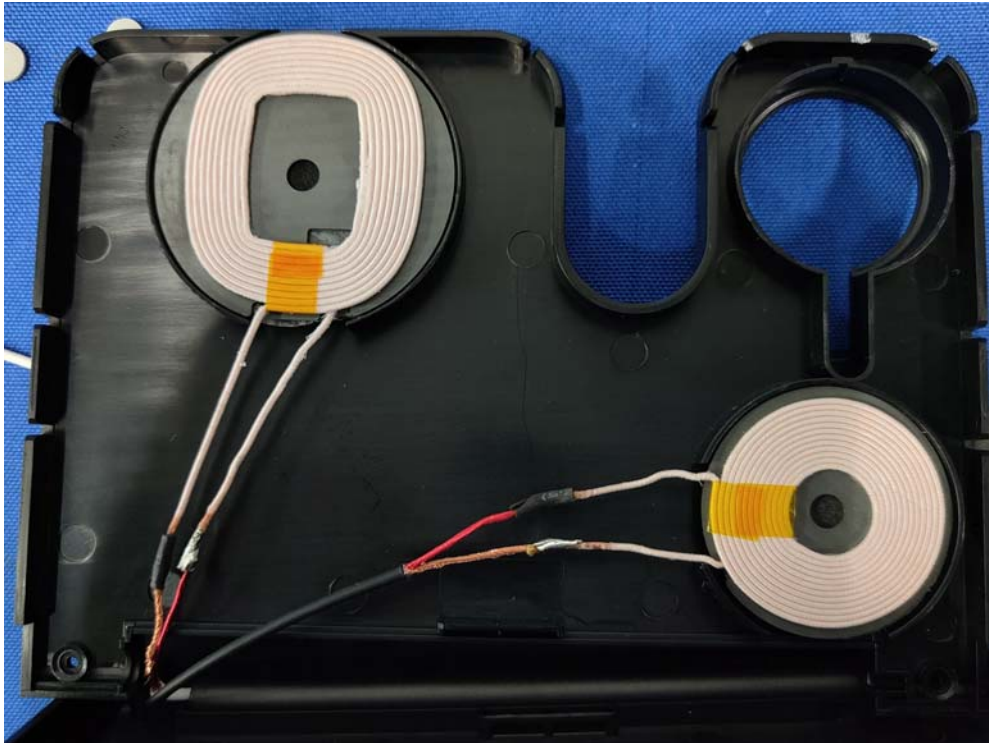

The report refers only to the sample tested and does not apply to the bulk.

This report is issued in confidence to the client and it will be strictly treated as such by the SHENZHEN TIMEWAY TESTING LABORATORIES. It may not be reproduced in its entirety or in part and it may not be used for advertising. The client to whom the report is issued may, however, show or send it, or a certified copy thereof prepared by the SHENZHEN TIMEWAY TESTING LABORATORIES, to his customer, supplier or other persons directly concerned. SHENZHEN TIMEWAY TESTING LABORATORIES will not, without the consent of the client enter into any discussion of correspondence with any third party concerning the contents of the report.

In the event of the improper use of the report, the SHENZHEN TIMEWAY TESTING LABORATORIES reserves the rights to withdraw it and to adopt any other remedies which may be appropriate.

Photo for the EUT

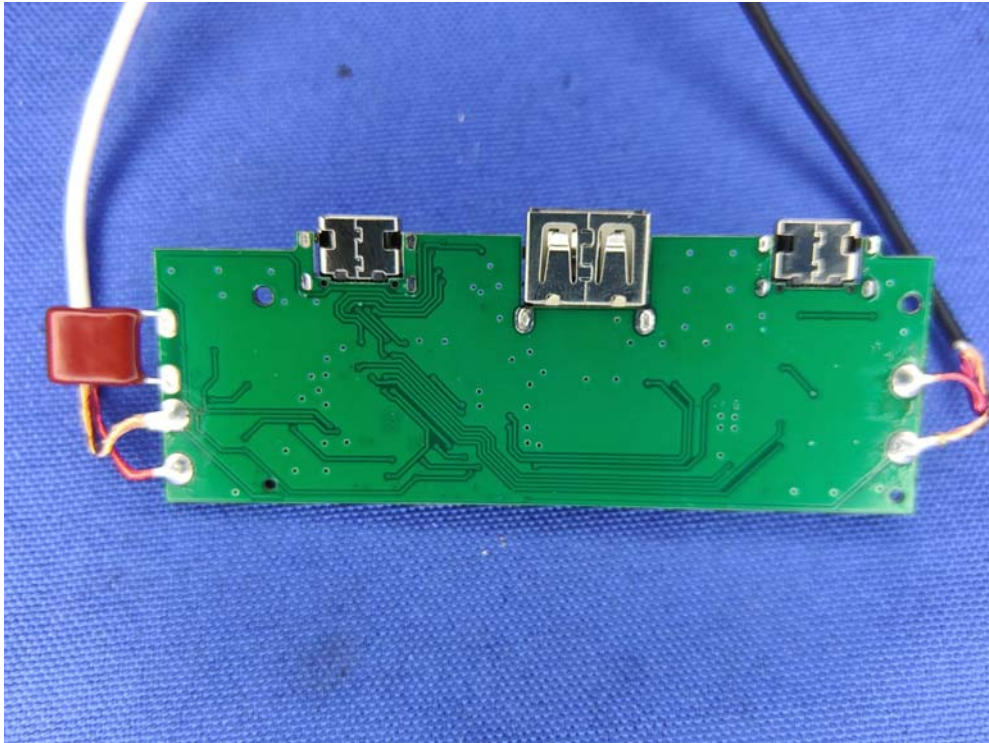

**-End of the report-**

The report refers only to the sample tested and does not apply to the bulk.

This report is issued in confidence to the client and it will be strictly treated as such by the SHENZHEN TIMEWAY TESTING LABORATORIES. It may not be reproduced rather in its entirety or in part and it may not be used for advertising. The client to whom the report is issued may, however, show or send it . or a certified copy there of prepared by the SHENZHEN TIMEWAY TESTING LABORATORIES. to his customer. Supplier or others persons directly concerned. SHENZHEN TIMEWAY TESTING LABORATORIES. will not, without the consent of the client enter into any discussion of correspondence with any third party concerning the contents of the report.

In the event of the improper use of the report. The SHENZHEN TIMEWAY TESTING LABORATORIES. reserves the rights to withdraw it and to adopt any other remedies which may be appropriate.