

TECHNICAL REPORT



Report No.: FCC1907366
File Reference No.: 2019-08-15
Applicant: LEADER PREMIUMS LTD
Product: WIRELESS CHARGER
Model No.: AB0123
Trademark: N/A
Test Standards: FCC CFR 47 Part 18

Test Result: It is herewith confirmed and found to comply with the requirements set up by FCC MP-5 & FCC Part 18, for the evaluation of electromagnetic compatibility

Approved By
Jack Chung

Jack Chung

Manager

Dated: August 15, 2019

Results appearing herein relate only to the sample tested
The technical reports is issued errors and omissions exempt and is subject to withdrawal at

SHENZHEN TIMEWAY TESTING LABORATORIES

Zone C, 1st Floor, Block B, Jun Xiang Da Building, Zhongshan Park Road West, Tong Le Village, Nanshan District, Shenzhen, China

Tel (755) 83448688, Fax (755) 83442996, E-Mail:info@timeway-lab.com



Special Statement:

The testing quality ability of our laboratory meet with "Quality Law of People's Republic of China" Clause 19.

The testing quality system of our laboratory meet with ISO/IEC-17025 requirements, which is approved by CNAS. This approval result is accepted by MRA of APLAC.

Our test facility is recognized, certified, or accredited by the following organizations:

CNAS-LAB Code: L2292

The EMC Laboratory has been assessed and in compliance with CNAS-CL01 accreditation criteria for testing Laboratories (identical to ISO/IEC 17025:2005 General Requirements) for the Competence of testing Laboratories.

FCC-Registration No.: 744189

The EMC Laboratory has been registered and fully described in a report filed with the (FCC) Federal Communications commission. The acceptance letter from the FCC is maintained in our files. Registration No.: 744189.

Industry Canada (IC) —Registration No.:5205A

The EMC Laboratory has been registered by Certification and Engineering Bureau of Industry Canada for radio equipment testing with Registration No.: 5205A.

A2LA (Certification Number:5013.01)

The EMC Laboratory has been accredited by the American Association for Laboratory Accreditation (A2LA). Certification Number:5013.01

The report refers only to the sample tested and does not apply to the bulk.

This report is issued in confidence to the client and it will be strictly treated as such by the SHENZHEN TIMEWAY TESTING LABORATORIES. It may not be reproduced rather in its entirety or in part and it may not be used for adverting. The client to whom the report is issued may, however, show or send it . or a certified copy there of prepared by the SHENZHEN TIMEWAY TESTING LABORATORIES. to his customer. Supplier or others persons directly concerned. SHENZHEN TIMEWAY TESTING LABORATORIES. will not, without the consent of the client enter into any discussion of correspondence with any third party concerning the contents of the report. In the event of the improper use of the report. The SHENZHEN TIMEWAY TESTING LABORATORIES. reserves the rights to withdraw it and to adopt any other remedies which may be appropriate.



Test Report Conclusion
Content

1.0	General Details	4
1.1	Test Lab Details.....	4
1.2	Applicant Details.....	4
1.3	Description of EUT	4
1.4	Submitted Sample.....	4
1.5	Test Duration.....	5
1.6	Test Uncertainty.....	5
1.7	Test By.....	5
2.0	List of Measurement Equipment	5
3.0	Technical Details	6
3.1	Summary of Test Results.....	6
3.2	Test Standards.....	6
4.0	EUT Modification	6
5.0	Power Line Conducted Emission Test	7
5.1	Schematics of the Test.....	7
5.2	Test Method and Test Procedure.....	7
5.3	Configuration of the EUT.....	7
5.4	EUT Operating Condition	8
5.5	Conducted Emission Limit	8
5.6	Test Result	8
6.0	Radiated Emission test	12
6.1	Test Method and Test Procedure.....	12
6.2	Configuration of the EUT.....	13
6.3	EUT Operation Condition.....	13
6.4	Radiated Emission Limit.....	13
6.5	Test Result.....	14
7.0	FCC Label.....	18
8.0	Photo of Testing.....	19

The report refers only to the sample tested and does not apply to the bulk.

This report is issued in confidence to the client and it will be strictly treated as such by the SHENZHEN TIMEWAY TESTING LABORATORIES. It may not be reproduced rather in its entirety or in part and it may not be used for advertising. The client to whom the report is issued may, however, show or send it, or a certified copy thereof prepared by the SHENZHEN TIMEWAY TESTING LABORATORIES, to his customer. Supplier or others persons directly concerned. SHENZHEN TIMEWAY TESTING LABORATORIES, will not, without the consent of the client enter into any discussion of correspondence with any third party concerning the contents of the report.

In the event of the improper use of the report. The SHENZHEN TIMEWAY TESTING LABORATORIES, reserves the rights to withdraw it and to adopt any other remedies which may be appropriate.



1.0 General Details

1.1 Test Lab Details

Name : SHENZHEN TIMEWAY TESTING LABORATORIES.
 Address: Zone C, 1st Floor, Block B, Jun Xiang Da Building, Zhongshan Park Road West, Tong Le Village, Nanshan District, Shenzhen, China
 Telephone: +86 755 83448688
 Fax: +86 755 83442996
 Site on File with the Federal Communications Commission – United States
 Registration Number: 744189
 For 3m Anechoic Chamber

1.2 Applicant Details

Applicant: LEADER PREMIUMS LTD
 Address: 9/F., Hengfu Mansion B building, NO.858. Fuming Road, Ningbo, China
 Telephone: --
 Fax: --

1.3 Description of EUT

Product: WIRELESS CHARGER
 Manufacturer: LEADER PREMIUMS LTD
 Address: 9/F., Hengfu Mansion B building, NO.858. Fuming Road, Ningbo, China
 Brand Name: N/A
 Model Number: AB0123
 Additional Model Name: N/A
 Additional Trade Name: N/A
 Rating: Input: 5V, 2A ; Output: 5V, 1A
 Operation Frequency: See below table

Channel	Frequency (MHz)	Channel	Frequency (MHz)	Channel	Frequency (MHz)	Channel	Frequency (MHz)
01	0.1115	06	0.140	11	0.165	16	0.190
02	0.120	07	0.145	12	0.170	17	0.195
03	0.125	08	0.150	13	0.175	18	0.200
04	0.130	09	0.155	14	0.180	19	0.205
05	0.135	10	0.160	15	0.185		

The report refers only to the sample tested and does not apply to the bulk.
 This report is issued in confidence to the client and it will be strictly treated as such by the SHENZHEN TIMEWAY TESTING LABORATORIES. It may not be reproduced rather in its entirety or in part and it may not be used for advertising. The client to whom the report is issued may, however, show or send it, or a certified copy thereof prepared by the SHENZHEN TIMEWAY TESTING LABORATORIES, to his customer. Supplier or others persons directly concerned. SHENZHEN TIMEWAY TESTING LABORATORIES. will not, without the consent of the client enter into any discussion of correspondence with any third party concerning the contents of the report.
 In the event of the improper use of the report. The SHENZHEN TIMEWAY TESTING LABORATORIES. reserves the rights to withdraw it and to adopt any other remedies which may be appropriate.



Teas channel	Frequency (MHz)
CH13	0.175 MHz

Modulation Type: MSK
Antenna Designation Inductive Loop Antenna with Gain 0dBi

1.4 Submitted Sample
2 Samples

1.5 Test Duration
2019-07-29 to 2019-08-14

1.6 Test Uncertainty
Conducted Emissions Uncertainty =3.6dB
Radiated Emissions below 9kHz-30MHz Uncertainty =4.3dB
Radiated Emissions below 30MHz-1GHz Uncertainty =4.7dB

1.7 Test Engineer *Terry Tang*

The sample tested by _____

Print Name: Terry Tang



2.0 Test Equipment					
Instrument Type	Manufacturer	Model	Serial No.	Date of Cal.	Due Date
ESPI Test Receiver	R&S	ESPI 3	100379	2019-06-21	2020-06-20
Loop Antenna	EMCO	6507	00078608	2018-06-25	2021-06-24
Spectrum	R&S	FSIQ26	100292	2019-06-21	2020-06-20
Horn Antenna	A-INFO	LB-180400-KF	J211060660	2018-06-25	2021-06-24
Horn Antenna	R&S	BBHA 9120D	9120D-631	2018-07-09	2021-07-08
Bilog Antenna	Schwarebeck	VULB9163	9163/340	2018-07-04	2021-07-03
9*6*6 Anechoic	--	--	N/A	2018-02-07	2021-02-06
Spectrum	HP/Agilent	ESA-L1500A	US37451154	2019-06-21	2020-06-20
Spectrum	RS	FSP	1164.4391.38	2019-01-18	2020-01-17
RF Cable	Zhengdi	ZT26-NJ-NJ-8 M/FA	--	2019-05-24	2020-05-23
RF Cable	Zhengdi	7m	--	2019-03-08	2020-03-07
RF Switch	EM	EMSW18	060391	2019-06-21	2020-06-20
Pre-Amplifier	Schwarebeck	BBV9743	#218	2019-06-21	2020-06-20
Pre-Amplifier	HP/Agilent	8449B	3008A00160	2018-08-05 2019-08-05	2019-08-04 2020-08-04
DC Power Supply	Jingtong	JT12098	WYK-305	2018.08.20	2019-08-19
LISN	SCHAFFNER	NNB42	00012	2019-01-08	2020-01-07

The report refers only to the sample tested and does not apply to the bulk.

This report is issued in confidence to the client and it will be strictly treated as such by the SHENZHEN TIMEWAY TESTING LABORATORIES. It may not be reproduced rather in its entirety or in part and it may not be used for advertising. The client to whom the report is issued may, however, show or send it, or a certified copy thereof prepared by the SHENZHEN TIMEWAY TESTING LABORATORIES, to his customer. Supplier or others persons directly concerned. SHENZHEN TIMEWAY TESTING LABORATORIES, will not, without the consent of the client enter into any discussion of correspondence with any third party concerning the contents of the report.

In the event of the improper use of the report. The SHENZHEN TIMEWAY TESTING LABORATORIES, reserves the rights to withdraw it and to adopt any other remedies which may be appropriate.



3.0 Technical Details

3.1 Summary of test results

The EUT has been tested according to the following specifications:			
Standard	Test Type	Result	Notes
FCC CFR47 Part 18, Paragraph 18.307	Conducted Emission Test	Pass	Compliant
FCC CFR47 Part 18, Paragraph 18.305	Radiated Emission Test	Pass	Compliant

3.2 Test Standards

FCC CFR47 Part 18 and FCC MP-5

4.0 EUT Modification

No modification by SHENZHEN TIMEWAY TESTING LABORATORIES

The report refers only to the sample tested and does not apply to the bulk.
This report is issued in confidence to the client and it will be strictly treated as such by the SHENZHEN TIMEWAY TESTING LABORATORIES. It may not be reproduced rather in its entirety or in part and it may not be used for advertising. The client to whom the report is issued may, however, show or send it . or a certified copy there of prepared by the SHENZHEN TIMEWAY TESTING LABORATORIES. to his customer. Supplier or others persons directly concerned. SHENZHEN TIMEWAY TESTING LABORATORIES. will not, without the consent of the client enter into any discussion of correspondence with any third party concerning the contents of the report.
In the event of the improper use of the report. The SHENZHEN TIMEWAY TESTING LABORATORIES. reserves the rights to withdraw it and to adopt any other remedies which may be appropriate.



5. Power Line Conducted Emission Test

5.1 Schematics of the test

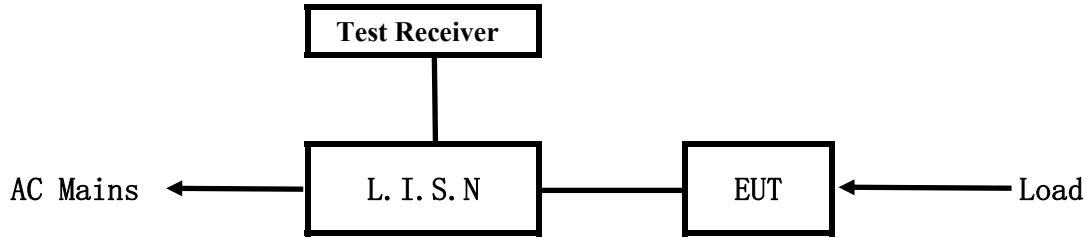

EUT: Equipment Under Test

5.2 Test Method and test Procedure

The EUT was tested according to MP-5. The Frequency spectrum From 0.15MHz to 30MHz was investigated. The LISN used was 50ohm/50uH as specified by section FCC Part 18.307.

Block diagram of Test setup

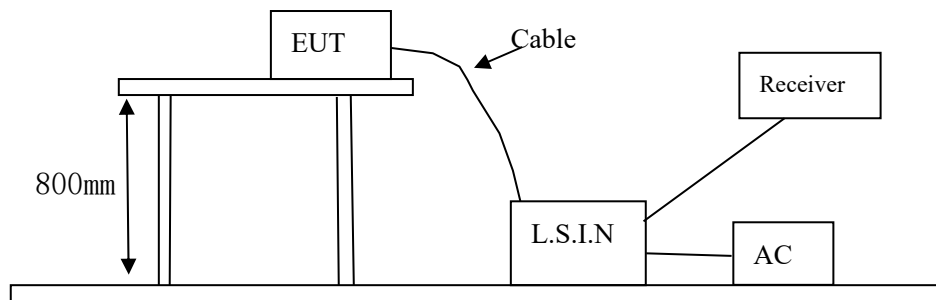

5.3 Configuration of The EUT

The EUT was configured according to MP-5. All interface ports were connected to the appropriate Peripherals. All peripherals and cables are listed below.

A. EUT

Device	Manufacturer	Model	FCC ID
WIRELESS CHARGER	LEADER PREMIUMS LTD	AB0123	2APYY-AB0123

B. Internal Device

Device	Manufacturer	Model	FCC ID/DOC
N/A			

C. Peripherals

Device	Manufacturer	Model	Rating
Power Supply	h.TV	S012BES0500200	Input:100-240V~, 50/60Hz,0.5A; Output: DC5V, 2A

5.4 EUT Operating Condition

The report refers only to the sample tested and does not apply to the bulk.

This report is issued in confidence to the client and it will be strictly treated as such by the SHENZHEN TIMEWAY TESTING LABORATORIES. It may not be reproduced rather in its entirety or in part and it may not be used for advertising. The client to whom the report is issued may, however, show or send it, or a certified copy thereof prepared by the SHENZHEN TIMEWAY TESTING LABORATORIES, to his customer. Supplier or others persons directly concerned. SHENZHEN TIMEWAY TESTING LABORATORIES, will not, without the consent of the client enter into any discussion of correspondence with any third party concerning the contents of the report.

In the event of the improper use of the report. The SHENZHEN TIMEWAY TESTING LABORATORIES, reserves the rights to withdraw it and to adopt any other remedies which may be appropriate.



Operating condition is according to MP-5.

- A Setup the EUT and simulators as shown on follow
- B Enable AF signal and confirm EUT active to normal condition

5.5 Power line conducted Emission Limit according to Paragraph 18.307 (b)

Frequency (MHz)	Class B Limits (dB μ V)	
	Quasi-peak Level	Average Level
0.15 ~ 0.50	66.0~56.0*	56.0~46.0*
0.50 ~ 5.00	56.0	46.0
5.00 ~ 30.00	60.0	50.0

- Notes:
- 1. *Decreasing linearly with logarithm of frequency.
 - 2. The tighter limit shall apply at the transition frequencies

5.6 Test Results

The frequency spectrum from 0.15MHz to 30MHz was investigated. All reading are quasi-peak values with a resolution bandwidth of 9kHz. (The average detector is necessary when the Quasi-peak emission level beyond the average Limit.)

The report refers only to the sample tested and does not apply to the bulk.
This report is issued in confidence to the client and it will be strictly treated as such by the SHENZHEN TIMEWAY TESTING LABORATORIES. It may not be reproduced rather in its entirety or in part and it may not be used for adverting. The client to whom the report is issued may, however, show or send it . or a certified copy there of prepared by the SHENZHEN TIMEWAY TESTING LABORATORIES. to his customer. Supplier or others persons directly concerned. SHENZHEN TIMEWAY TESTING LABORATORIES. will not, without the consent of the client enter into any discussion of correspondence with any third party concerning the contents of the report.
In the event of the improper use of the report. The SHENZHEN TIMEWAY TESTING LABORATORIES. reserves the rights to withdraw it and to adopt any other remedies which may be appropriate.



A: Conducted Emission on Live Terminal (150kHz to 30MHz)

EUT Operating Environment

Temperature: 26°C Humidity: 65%RH Atmospheric Pressure: 101 KPa

EUT set Condition: Keep Transmitting

Results: PASS

Please refer to following diagram for individual

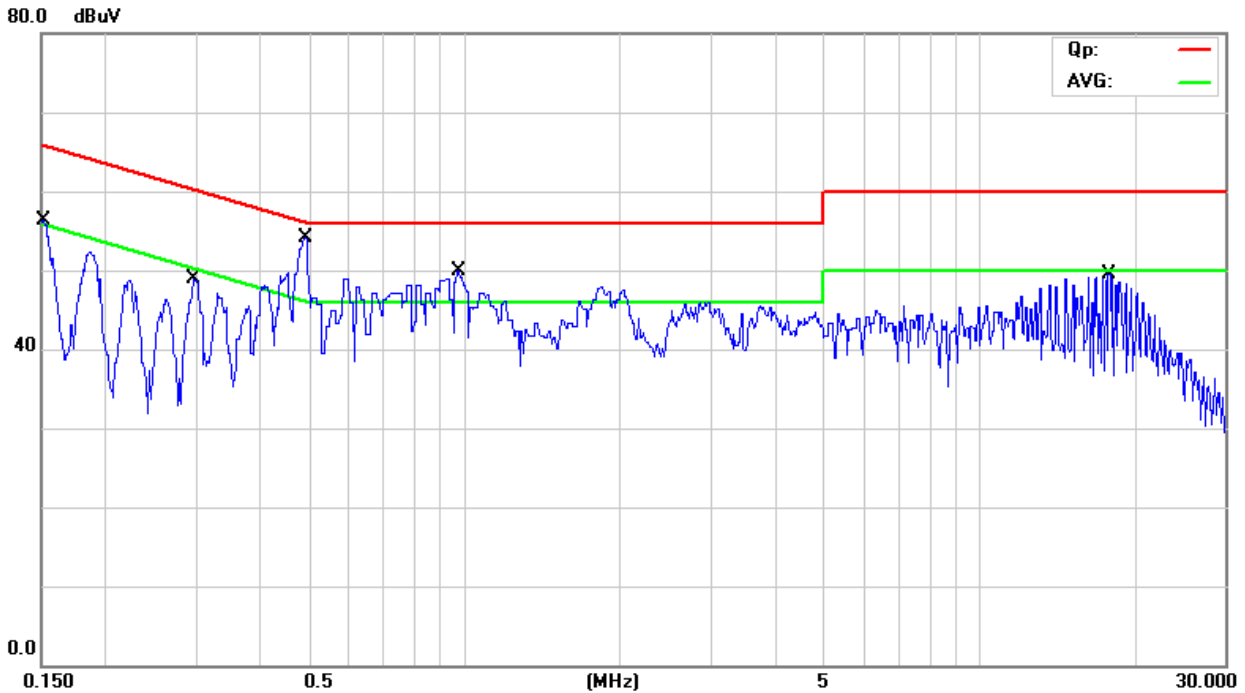

No.	Mk.	Freq. MHz	Reading Level dBuV	Correct Factor dB	Measure- ment dBuV	Limit dBuV	Over dB	Detector	Comment
1		0.1510	41.80	9.78	51.58	65.94	-14.36	QP	
2		0.1510	9.70	9.78	19.48	55.94	-36.46	AVG	
3		0.2970	35.00	9.76	44.76	60.33	-15.57	QP	
4		0.2970	10.70	9.76	20.46	50.33	-29.87	AVG	
5	*	0.4894	42.10	9.77	51.87	56.18	-4.31	QP	
6		0.4894	12.90	9.77	22.67	46.18	-23.51	AVG	
7		0.9742	37.00	9.79	46.79	56.00	-9.21	QP	
8		0.9742	5.90	9.79	15.69	46.00	-30.31	AVG	
9		17.8420	36.70	10.55	47.25	60.00	-12.75	QP	
10		17.8420	3.50	10.55	14.05	50.00	-35.95	AVG	

The report refers only to the sample tested and does not apply to the bulk.

This report is issued in confidence to the client and it will be strictly treated as such by the SHENZHEN TIMEWAY TESTING LABORATORIES. It may not be reproduced rather in its entirety or in part and it may not be used for advertising. The client to whom the report is issued may, however, show or send it, or a certified copy thereof prepared by the SHENZHEN TIMEWAY TESTING LABORATORIES, to his customer. Supplier or others persons directly concerned. SHENZHEN TIMEWAY TESTING LABORATORIES, will not, without the consent of the client enter into any discussion of correspondence with any third party concerning the contents of the report.

In the event of the improper use of the report. The SHENZHEN TIMEWAY TESTING LABORATORIES, reserves the rights to withdraw it and to adopt any other remedies which may be appropriate.



B: Conducted Emission on Neutral Terminal (150kHz to 30MHz)

EUT Operating Environment

Temperature: 26°C Humidity: 65%RH Atmospheric Pressure: 101 KPa

EUT set Condition: Keep Transmitting

Results: Pass

Please refer to following diagram for individual

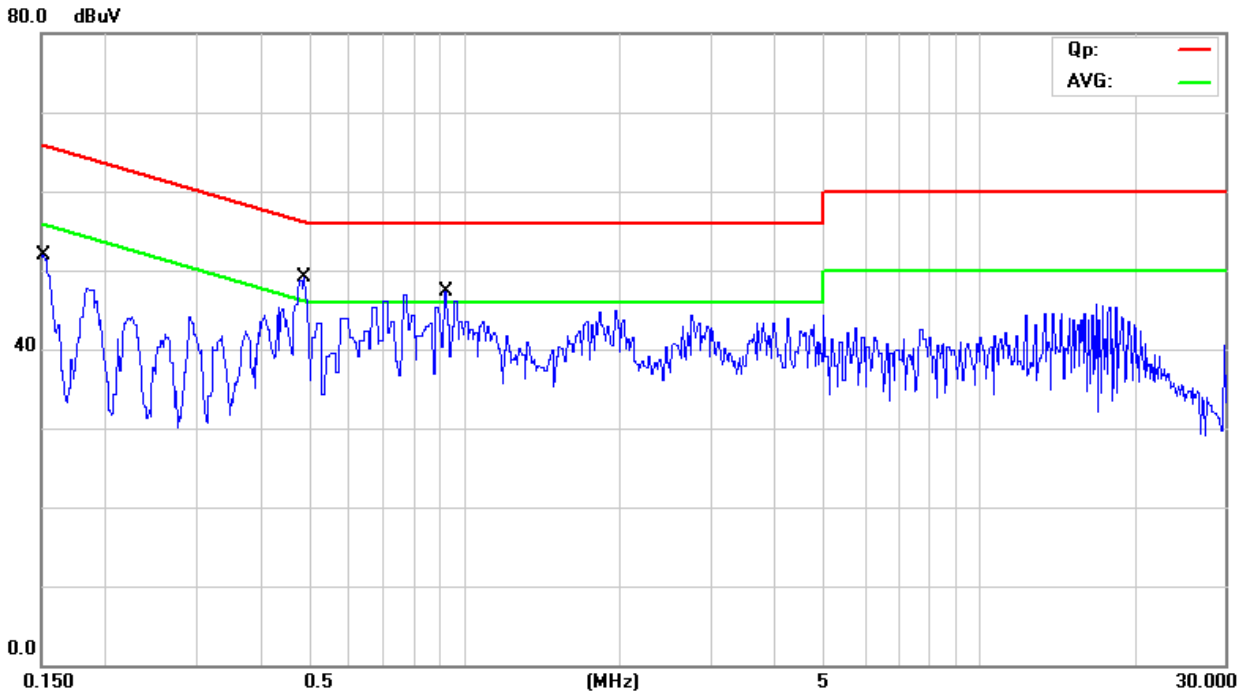

No.	Mk.	Freq. MHz	Reading Level dBuV	Correct Factor dB	Measure- ment dBuV	Limit dBuV	Over dB	Detector	Comment
1		0.1502	38.50	9.78	48.28	65.99	-17.71	QP	
2		0.1502	12.50	9.78	22.28	55.99	-33.71	AVG	
3	*	0.4820	36.20	9.77	45.97	56.30	-10.33	QP	
4		0.4820	11.50	9.77	21.27	46.30	-25.03	AVG	
5		0.9206	30.60	9.79	40.39	56.00	-15.61	QP	
6		0.9206	2.40	9.79	12.19	46.00	-33.81	AVG	

The report refers only to the sample tested and does not apply to the bulk.
 This report is issued in confidence to the client and it will be strictly treated as such by the SHENZHEN TIMEWAY TESTING LABORATORIES. It may not be reproduced in its entirety or in part and it may not be used for advertising. The client to whom the report is issued may, however, show or send it, or a certified copy thereof prepared by the SHENZHEN TIMEWAY TESTING LABORATORIES, to his customer. Supplier or others persons directly concerned. SHENZHEN TIMEWAY TESTING LABORATORIES, will not, without the consent of the client enter into any discussion of correspondence with any third party concerning the contents of the report.
 In the event of the improper use of the report, the SHENZHEN TIMEWAY TESTING LABORATORIES, reserves the rights to withdraw it and to adopt any other remedies which may be appropriate.



6 Radiated Emission Test

6.1 Test Method and test Procedure:

- (1) The EUT was tested according to MP-5. The radiated test was performed at TIMEWAY EMC Laboratory. This site is on file with the FCC laboratory division, Registration No.744189
- (2) The EUT, peripherals were put on the turntable which table size is 1m x 1.5 m, table high 0.8 m. All set up is according to MP-5.
- (3) The frequency spectrum from 9 kHz to 1 GHz was investigated. All readings from 30 MHz to 1 GHz are quasi-peak values with RBW=120 kHz/VBW=300 kHz; All readings from 9 kHz to 30 MHz are quasi-peak values with RBW=10 kHz/VBW=30 kHz. For the frequency bands 9-90 kHz, 110-490 kHz and above 1000 MHz Radiated emission test in these three bands are based on measurements employing an average detector. Measurements were made at 3 meters.
- (4) The antenna high is varied from 1 m to 4 m high to find the maximum emission for each frequency.
- (5) Maximizing procedure was performed on the six (6) highest emissions to ensure EUT compliance is with all installation combinations. All data was recorded in the peak detection mode. Quasi-peak readings was performed only when an emission was found to be marginal (within -4 dB of specification limit), and are distinguished with a "QP" in the data table.
- (6) The antenna polarization: Vertical polarization and Horizontal polarization.

Block diagram of Test setup

9kHz-30MHz

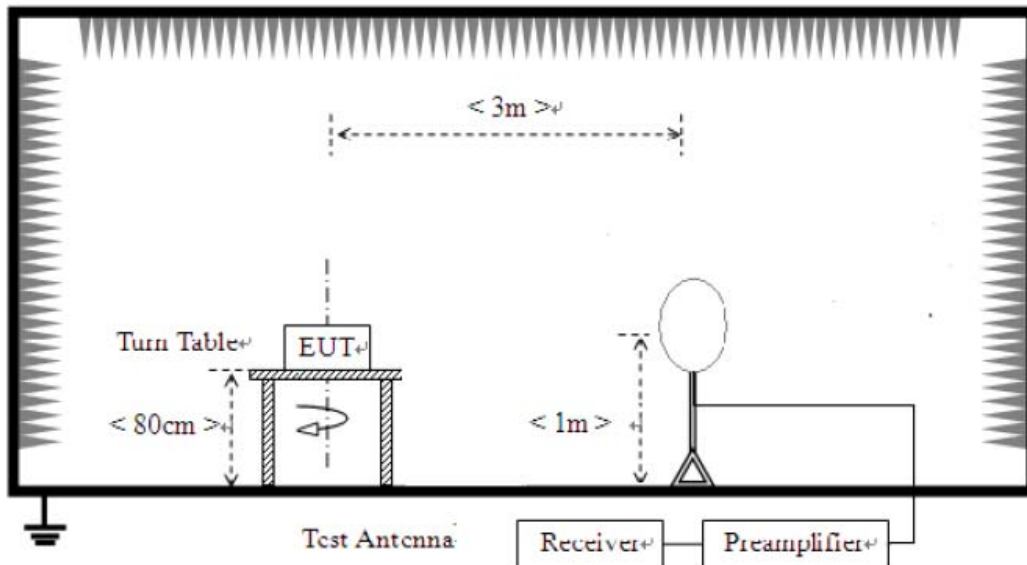

The report refers only to the sample tested and does not apply to the bulk.

This report is issued in confidence to the client and it will be strictly treated as such by the SHENZHEN TIMEWAY TESTING LABORATORIES. It may not be reproduced rather in its entirety or in part and it may not be used for advertising. The client to whom the report is issued may, however, show or send it, or a certified copy thereof prepared by the SHENZHEN TIMEWAY TESTING LABORATORIES, to his customer, Supplier or others persons directly concerned. SHENZHEN TIMEWAY TESTING LABORATORIES, will not, without the consent of the client enter into any discussion of correspondence with any third party concerning the contents of the report.

In the event of the improper use of the report, The SHENZHEN TIMEWAY TESTING LABORATORIES, reserves the rights to withdraw it and to adopt any other remedies which may be appropriate.



30MHz-1000MHz

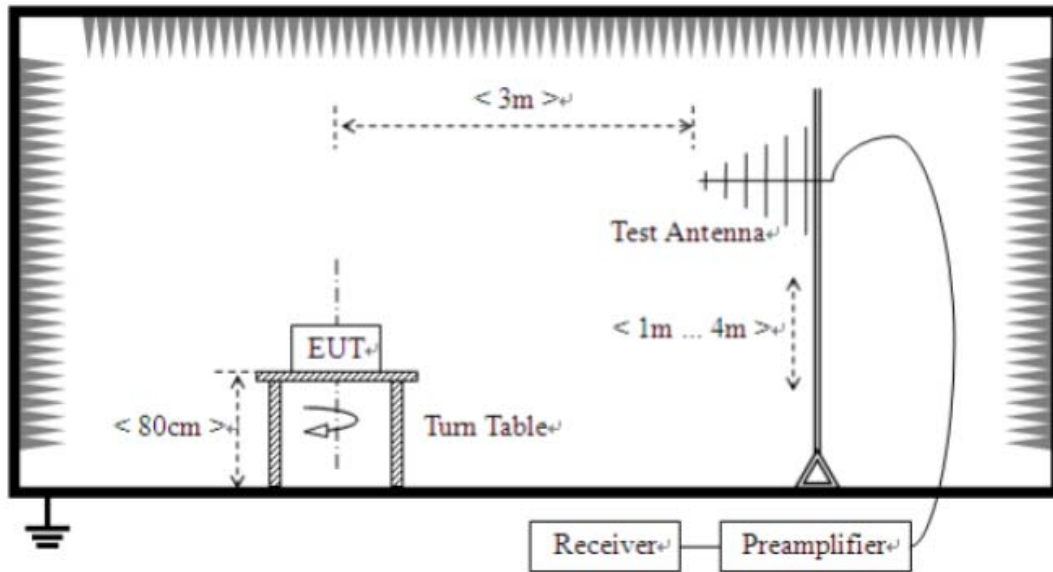

6.2 Configuration of The EUT

Same as section 5.3 of this report

6.3 EUT Operating Condition

Same as section 5.4 of this report.

6.4 Radiated Emission Limit

All emission from a digital device, including any network of conductors and apparatus connected thereto, shall not exceed the level of field strength specified below:

B. Frequencies in restricted band are compiled to limit on Paragraph 18.307.

Limits for frequency below 30MHz

Frequency Range (MHz)	Distance (m)	Field strength (dB μ V/m)
0.009-30	3	103.5

Limits for frequency above 30MHz

Frequency Range (MHz)	Distance (m)	Field strength (dB μ V/m)
30-88	3	40.0
88-216	3	43.5
216-1000	3	46.0

Note: 1. Emission level for frequency of 0.009~30MHz = $20\log(15) + 40\log(300/3) = 103.5$ dB μ V/m

The report refers only to the sample tested and does not apply to the bulk.

This report is issued in confidence to the client and it will be strictly treated as such by the SHENZHEN TIMEWAY TESTING LABORATORIES. It may not be reproduced rather in its entirety or in part and it may not be used for advertising. The client to whom the report is issued may, however, show or send it, or a certified copy thereof prepared by the SHENZHEN TIMEWAY TESTING LABORATORIES, to his customer. Supplier or others persons directly concerned, SHENZHEN TIMEWAY TESTING LABORATORIES, will not, without the consent of the client enter into any discussion of correspondence with any third party concerning the contents of the report.

In the event of the improper use of the report, the SHENZHEN TIMEWAY TESTING LABORATORIES, reserves the rights to withdraw it and to adopt any other remedies which may be appropriate.



1. Emission level for frequency of 30-1000MHz = $20\log(10 \text{ or } 15 \text{ or } 220) + 20\log(30/3) = 40 \text{ or } 43.5 \text{ or } 46 \text{ dB } \mu\text{V/m}$
2. Calculated according FCC 18.305
3. In the Above Table, the tighter limit applies at the band edges.
4. Distance refers to the distance in meters between the measuring instrument antenna and the EUT
5. The emission limits shown in the above table are based on measurements employing a CISPR quasi-peak detector except for the frequency bands 9-90 kHz, 110-490 kHz. Radiated emission limits in these three bands are based on measurements employing an average detector.

6.5 Test result

The report refers only to the sample tested and does not apply to the bulk.

This report is issued in confidence to the client and it will be strictly treated as such by the SHENZHEN TIMEWAY TESTING LABORATORIES. It may not be reproduced rather in its entirety or in part and it may not be used for advertising. The client to whom the report is issued may, however, show or send it, or a certified copy thereof prepared by the SHENZHEN TIMEWAY TESTING LABORATORIES, to his customer. Supplier or others persons directly concerned. SHENZHEN TIMEWAY TESTING LABORATORIES, will not, without the consent of the client enter into any discussion of correspondence with any third party concerning the contents of the report.

In the event of the improper use of the report. The SHENZHEN TIMEWAY TESTING LABORATORIES, reserves the rights to withdraw it and to adopt any other remedies which may be appropriate.



Measurement data:

9 kHz~30 MHz

126.0 dBuV

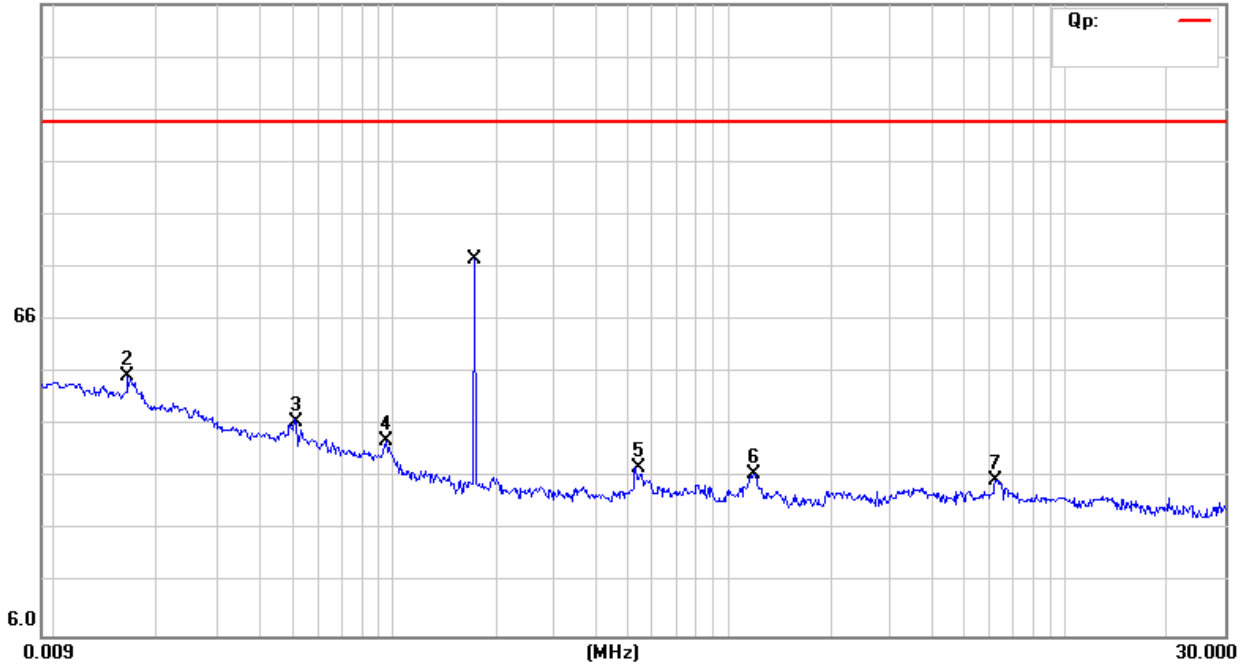

No.	Mk.	Freq. MHz	Reading Level dBuV/m	Correct Factor dB	Measure- ment dBuV/m	Limit dBuV/m	Over dB	Detector	Comment
1	*	0.1750	67.90	9.77	77.67	103.5	-25.83	QP	
2		0.0164	45.18	10.23	55.41	103.5	-48.09	peak	
3		0.0512	36.92	9.80	46.72	103.5	-56.78	peak	
4		0.0956	33.37	9.81	43.18	103.5	-60.32	peak	
5		0.5336	28.05	9.77	37.82	103.5	-65.68	peak	
6		1.1973	27.04	9.79	36.83	103.5	-66.67	peak	
7		6.2500	25.66	9.98	35.64	103.5	-67.86	peak	

The report refers only to the sample tested and does not apply to the bulk.

This report is issued in confidence to the client and it will be strictly treated as such by the SHENZHEN TIMEWAY TESTING LABORATORIES. It may not be reproduced rather in its entirety or in part and it may not be used for advertising. The client to whom the report is issued may, however, show or send it, or a certified copy thereof prepared by the SHENZHEN TIMEWAY TESTING LABORATORIES, to his customer. Supplier or others persons directly concerned. SHENZHEN TIMEWAY TESTING LABORATORIES, will not, without the consent of the client enter into any discussion of correspondence with any third party concerning the contents of the report.

In the event of the improper use of the report. The SHENZHEN TIMEWAY TESTING LABORATORIES, reserves the rights to withdraw it and to adopt any other remedies which may be appropriate.



A. General Radiated Emission Data
Radiated Emission In Horizontal (30MHz----1000MHz)

EUT set Condition: Keep Transmitting

Results: Pass

Please refer to following diagram for individual

FCC_FCC Part 15B Class B 30MHz-1GHz

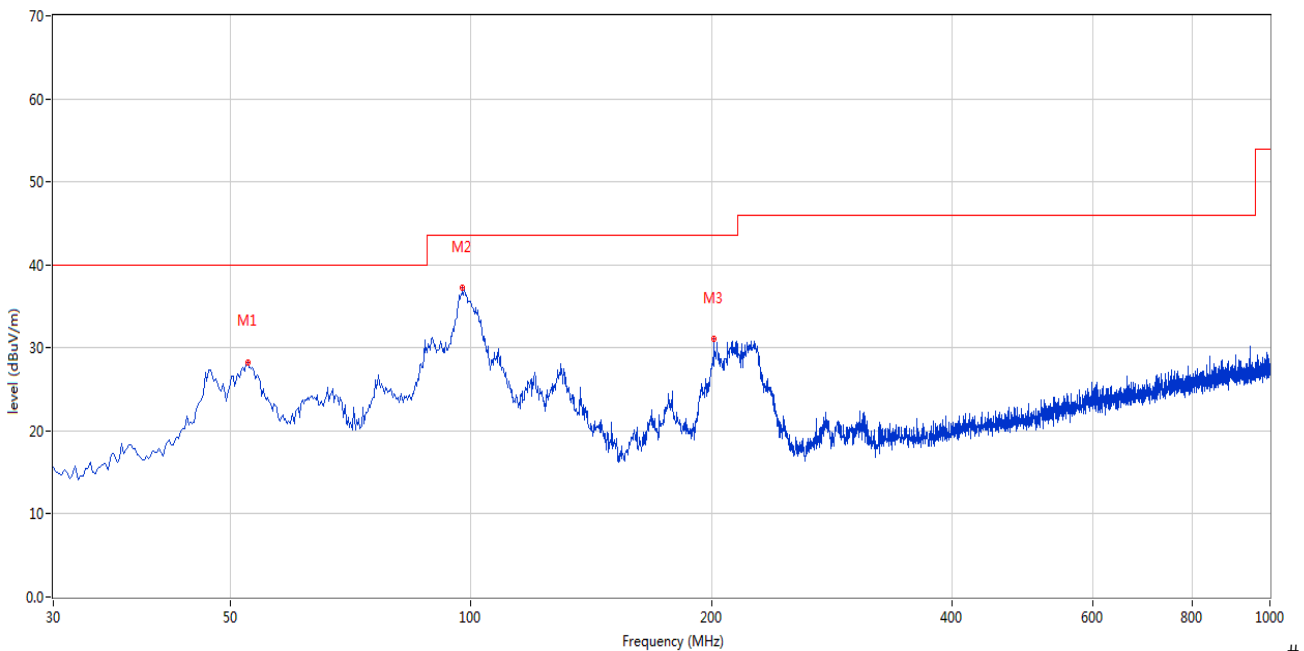

No.	Frequency (MHz)	Results (dBuV/m)	Factor (dB)	Limit (dBuV/m)	Over Limit (dB)	Detector	Table (o)	Height (cm)	ANT	Verdict
1	52.547	28.27	-11.46	40.0	-11.73	Peak	152.00	200	H	Pass
2	97.641	37.24	-13.79	43.5	-6.26	Peak	3.00	200	H	Pass
3	201.405	31.07	-13.42	43.5	-12.43	Peak	27.00	200	H	Pass

The report refers only to the sample tested and does not apply to the bulk.

This report is issued in confidence to the client and it will be strictly treated as such by the SHENZHEN TIMEWAY TESTING LABORATORIES. It may not be reproduced rather in its entirety or in part and it may not be used for advertising. The client to whom the report is issued may, however, show or send it, or a certified copy thereof prepared by the SHENZHEN TIMEWAY TESTING LABORATORIES, to his customer. Supplier or others persons directly concerned. SHENZHEN TIMEWAY TESTING LABORATORIES, will not, without the consent of the client enter into any discussion of correspondence with any third party concerning the contents of the report.

In the event of the improper use of the report. The SHENZHEN TIMEWAY TESTING LABORATORIES, reserves the rights to withdraw it and to adopt any other remedies which may be appropriate.



B. General Radiated Emission Data

Radiated Emission In Vertical (30MHz----1000MHz)

EUT set Condition: Keep Transmitting

Results: Pass

Please refer to following diagram for individual

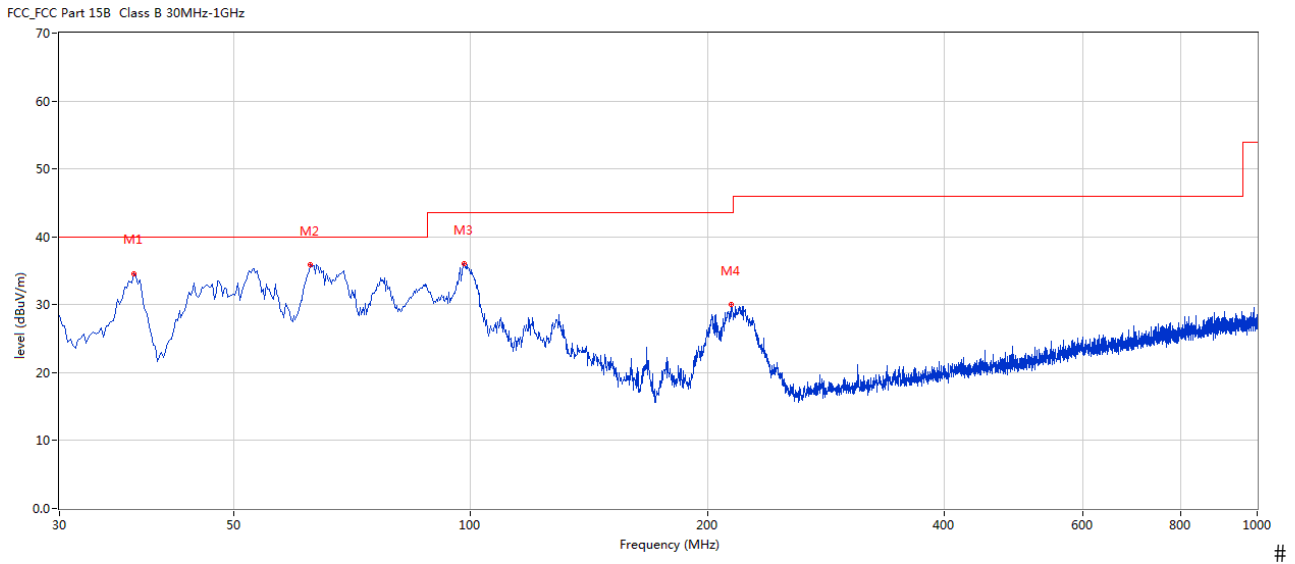

No.	Frequency (MHz)	Results (dBuV/m)	Factor (dB)	Limit (dBuV/m)	Over Limit (dB)	Detector	Table (o)	Height (cm)	ANT	Verdict
1	37.273	34.59	-13.06	40.0	-5.41	Peak	0.00	200	V	Pass
2	62.487	35.83	-13.28	40.0	-4.17	Peak	280.00	100	V	Pass
3	98.125	36.03	-13.73	43.5	-7.47	Peak	288.00	100	V	Pass
4	214.496	30.01	-13.58	43.5	-13.49	Peak	96.00	100	V	Pass

The report refers only to the sample tested and does not apply to the bulk. This report is issued in confidence to the client and it will be strictly treated as such by the SHENZHEN TIMEWAY TESTING LABORATORIES. It may not be reproduced in its entirety or in part and it may not be used for advertising. The client to whom the report is issued may, however, show or send it, or a certified copy thereof prepared by the SHENZHEN TIMEWAY TESTING LABORATORIES, to his customer. Supplier or others persons directly concerned. SHENZHEN TIMEWAY TESTING LABORATORIES. will not, without the consent of the client enter into any discussion of correspondence with any third party concerning the contents of the report. In the event of the improper use of the report. The SHENZHEN TIMEWAY TESTING LABORATORIES. reserves the rights to withdraw it and to adopt any other remedies which may be appropriate.



7.0 FCC ID Label

FCC ID: 2APYY-AB0123

The label must not be a stick-on paper label. The label on these products must be permanently affixed to the product and readily visible at the time of purchase and must last the expected lifetime of the equipment not be readily detachable.

Mark Location:

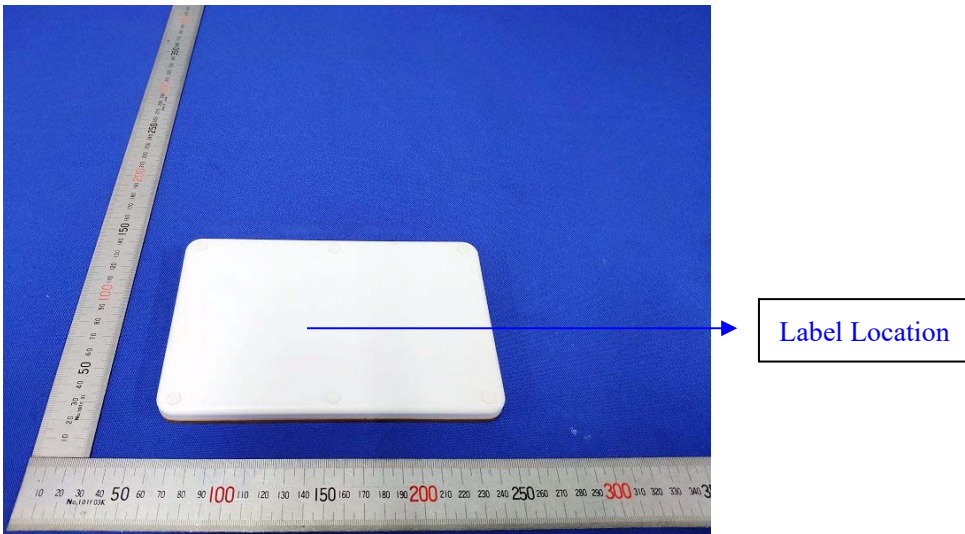

The report refers only to the sample tested and does not apply to the bulk.

This report is issued in confidence to the client and it will be strictly treated as such by the SHENZHEN TIMEWAY TESTING LABORATORIES. It may not be reproduced rather in its entirety or in part and it may not be used for advertising. The client to whom the report is issued may, however, show or send it, or a certified copy thereof prepared by the SHENZHEN TIMEWAY TESTING LABORATORIES, to his customer, supplier or others persons directly concerned. SHENZHEN TIMEWAY TESTING LABORATORIES, will not, without the consent of the client enter into any discussion of correspondence with any third party concerning the contents of the report.

In the event of the improper use of the report, the SHENZHEN TIMEWAY TESTING LABORATORIES, reserves the rights to withdraw it and to adopt any other remedies which may be appropriate.



8.0. Photo of testing

8.1 Conducted test View

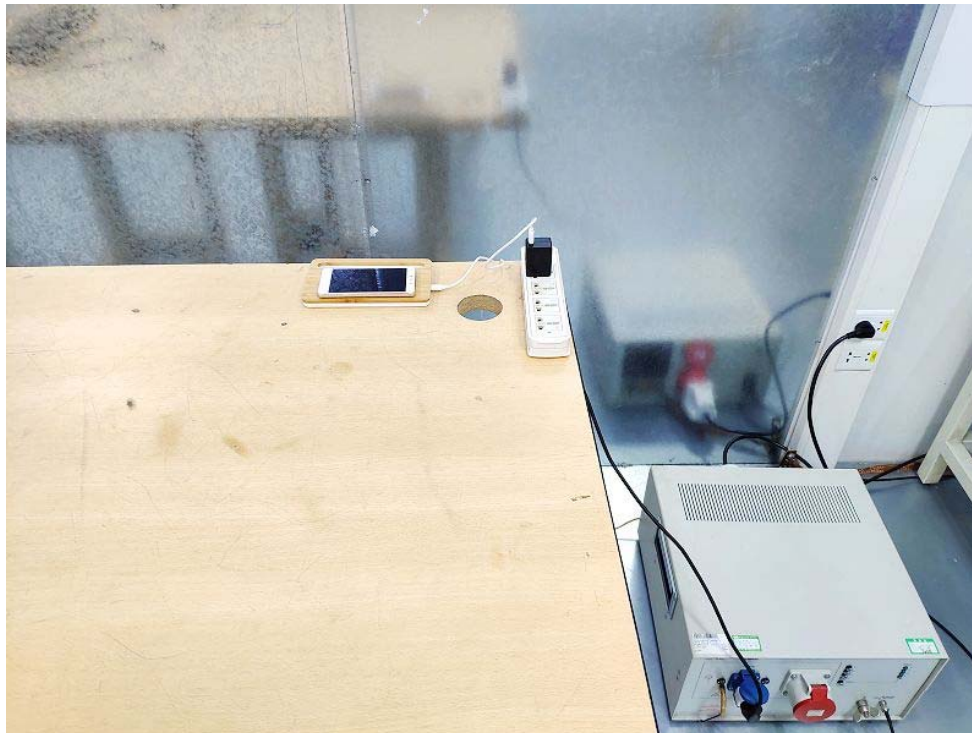

The report refers only to the sample tested and does not apply to the bulk.

This report is issued in confidence to the client and it will be strictly treated as such by the SHENZHEN TIMEWAY TESTING LABORATORIES. It may not be reproduced rather in its entirety or in part and it may not be used for advertising. The client to whom the report is issued may, however, show or send it . or a certified copy there of prepared by the SHENZHEN TIMEWAY TESTING LABORATORIES. to his customer. Supplier or others persons directly concerned. SHENZHEN TIMEWAY TESTING LABORATORIES. will not, without the consent of the client enter into any discussion of correspondence with any third party concerning the contents of the report.

In the event of the improper use of the report. The SHENZHEN TIMEWAY TESTING LABORATORIES. reserves the rights to withdraw it and to adopt any other remedies which may be appropriate.



8.2 Radiated emission test view

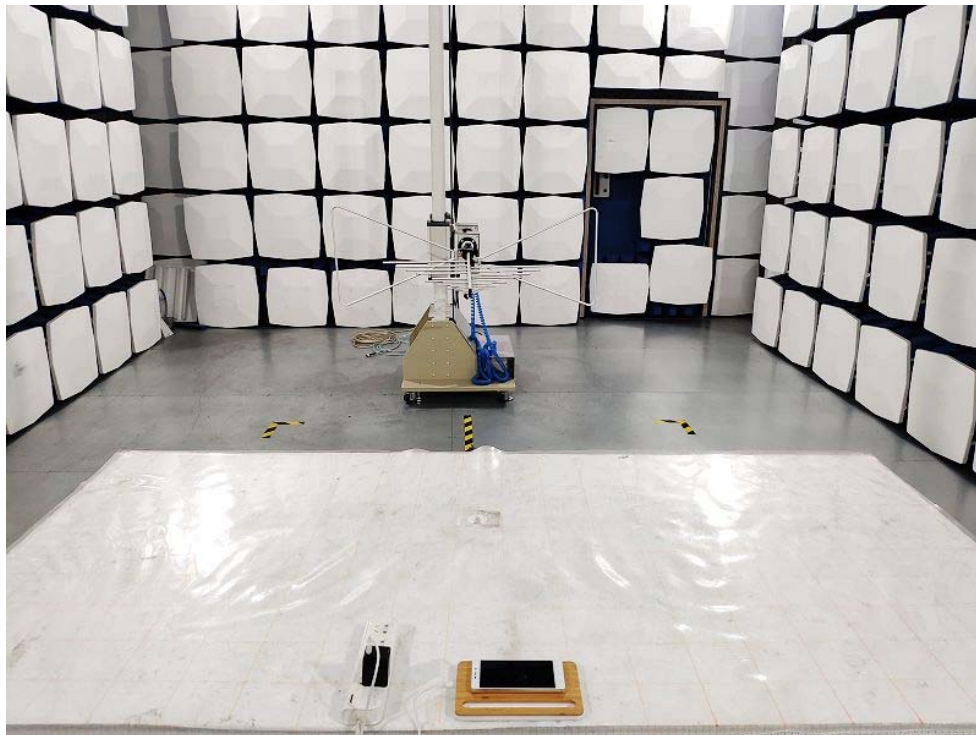
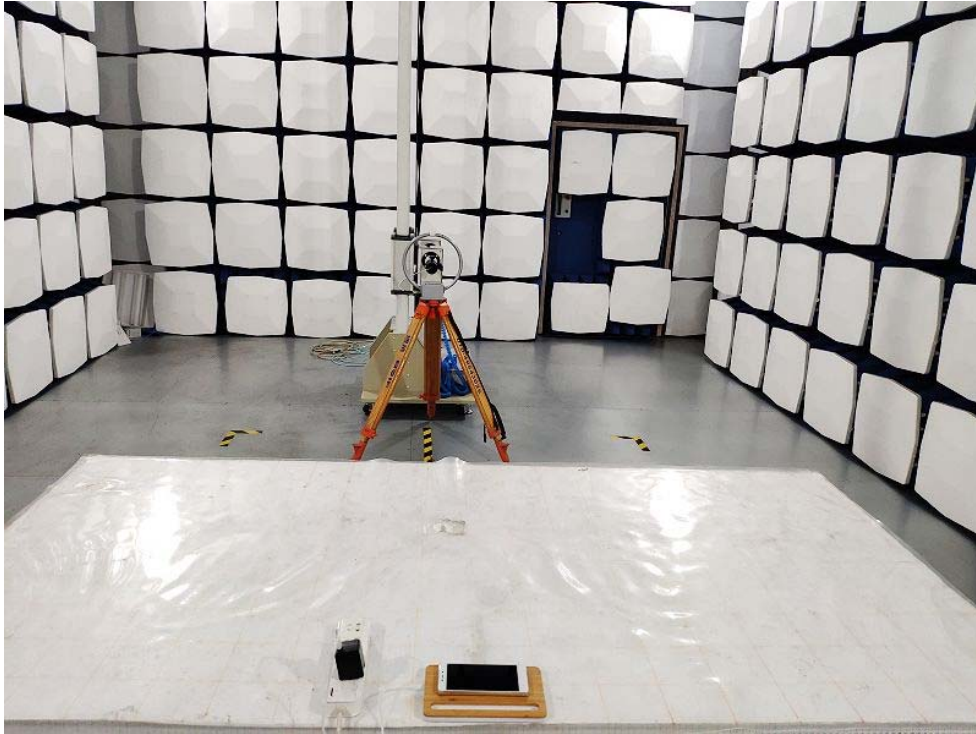

The report refers only to the sample tested and does not apply to the bulk.
This report is issued in confidence to the client and it will be strictly treated as such by the SHENZHEN TIMEWAY TESTING LABORATORIES. It may not be reproduced in its entirety or in part and it may not be used for advertising. The client to whom the report is issued may, however, show or send it, or a certified copy thereof prepared by the SHENZHEN TIMEWAY TESTING LABORATORIES, to his customer, supplier or other persons directly concerned. SHENZHEN TIMEWAY TESTING LABORATORIES, will not, without the consent of the client enter into any discussion of correspondence with any third party concerning the contents of the report.
In the event of the improper use of the report, the SHENZHEN TIMEWAY TESTING LABORATORIES, reserves the rights to withdraw it and to adopt any other remedies which may be appropriate.

Photo for the EUT



The report refers only to the sample tested and does not apply to the bulk.

This report is issued in confidence to the client and it will be strictly treated as such by the SHENZHEN TIMEWAY TESTING LABORATORIES. It may not be reproduced rather in its entirety or in part and it may not be used for advertising. The client to whom the report is issued may, however, show or send it, or a certified copy thereof prepared by the SHENZHEN TIMEWAY TESTING LABORATORIES, to his customer, supplier or other persons directly concerned. SHENZHEN TIMEWAY TESTING LABORATORIES, will not, without the consent of the client enter into any discussion of correspondence with any third party concerning the contents of the report.

In the event of the improper use of the report, the SHENZHEN TIMEWAY TESTING LABORATORIES, reserves the rights to withdraw it and to adopt any other remedies which may be appropriate.

Photo for the EUT



The report refers only to the sample tested and does not apply to the bulk.

This report is issued in confidence to the client and it will be strictly treated as such by the SHENZHEN TIMEWAY TESTING LABORATORIES. It may not be reproduced in its entirety or in part and it may not be used for advertising. The client to whom the report is issued may, however, show or send it, or a certified copy thereof prepared by the SHENZHEN TIMEWAY TESTING LABORATORIES, to his customer. Supplier or others persons directly concerned. SHENZHEN TIMEWAY TESTING LABORATORIES, will not, without the consent of the client enter into any discussion of correspondence with any third party concerning the contents of the report.

In the event of the improper use of the report. The SHENZHEN TIMEWAY TESTING LABORATORIES, reserves the rights to withdraw it and to adopt any other remedies which may be appropriate.

Photo for the EUT

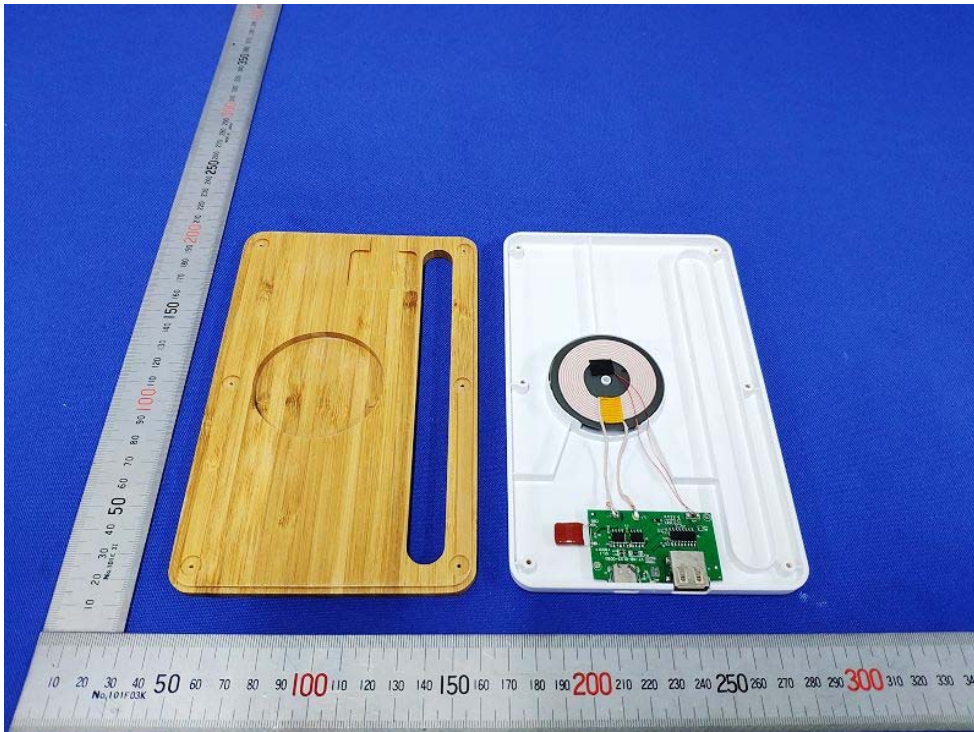

The report refers only to the sample tested and does not apply to the bulk.

This report is issued in confidence to the client and it will be strictly treated as such by the SHENZHEN TIMEWAY TESTING LABORATORIES. It may not be reproduced rather in its entirety or in part and it may not be used for advertising. The client to whom the report is issued may, however, show or send it, or a certified copy thereof prepared by the SHENZHEN TIMEWAY TESTING LABORATORIES, to his customer, supplier or other persons directly concerned. SHENZHEN TIMEWAY TESTING LABORATORIES, will not, without the consent of the client enter into any discussion of correspondence with any third party concerning the contents of the report.

In the event of the improper use of the report, the SHENZHEN TIMEWAY TESTING LABORATORIES, reserves the rights to withdraw it and to adopt any other remedies which may be appropriate.

Photo for the EUT

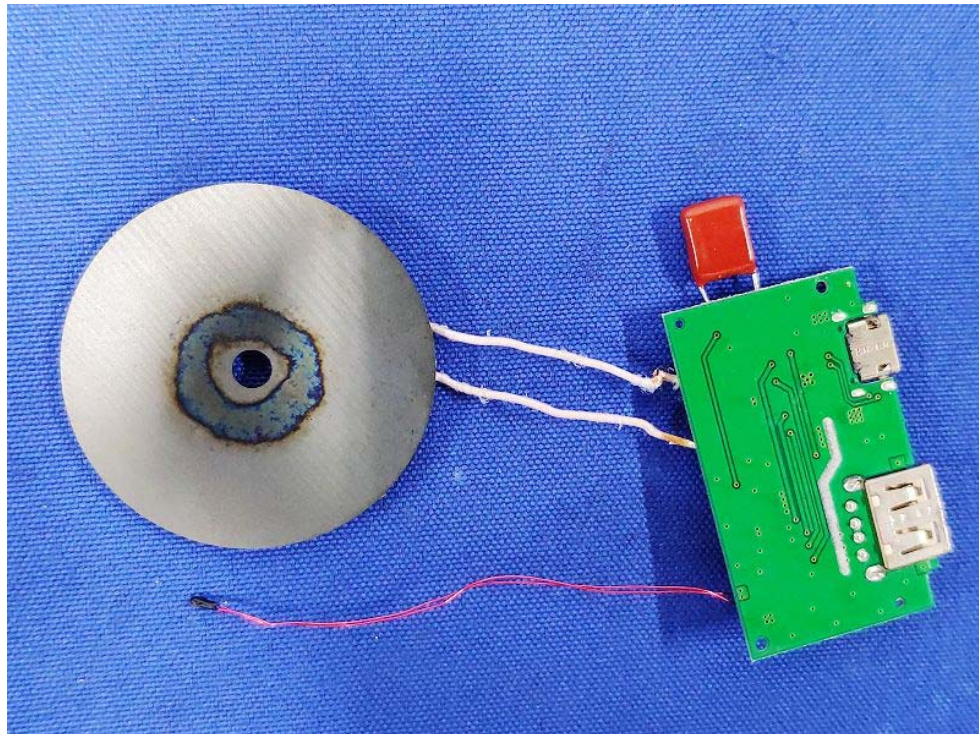
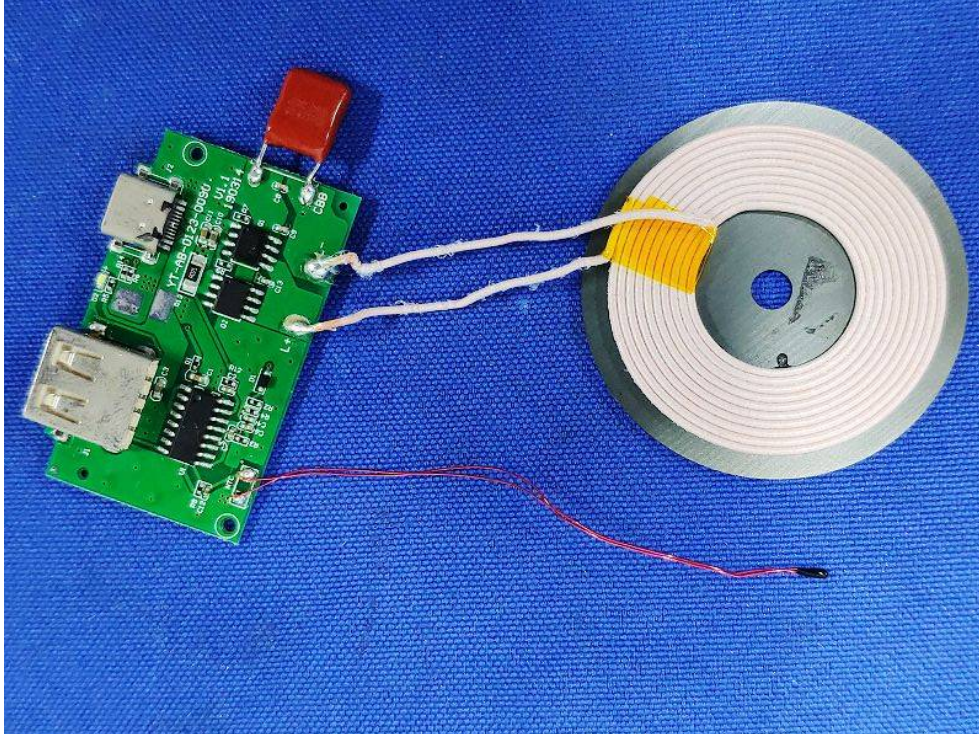

-End of the report-

The report refers only to the sample tested and does not apply to the bulk.

This report is issued in confidence to the client and it will be strictly treated as such by the SHENZHEN TIMEWAY TESTING LABORATORIES. It may not be reproduced in its entirety or in part and it may not be used for advertising. The client to whom the report is issued may, however, show or send it, or a certified copy thereof prepared by the SHENZHEN TIMEWAY TESTING LABORATORIES, to his customer, supplier or other persons directly concerned. SHENZHEN TIMEWAY TESTING LABORATORIES will not, without the consent of the client, enter into any discussion of correspondence with any third party concerning the contents of the report.

In the event of the improper use of the report, the SHENZHEN TIMEWAY TESTING LABORATORIES reserves the rights to withdraw it and to adopt any other remedies which may be appropriate.