

Tracker

USER MANUAL

CONTENTS

- WHAT'S IN THE BOX
- PRODUCT OVERVIEW
- SETTING UP THE SYSTEM
- CHARGING THE TRACKER
- TROUBLESHOOTING GUIDE
- FCC COMPLIANCE
- CUSTOMER SERVICE
- WARRANTY CARD

WHAT'S IN THE BOX

TIPS: Please consult this check list for all parts and accessories prior to set up and installation.

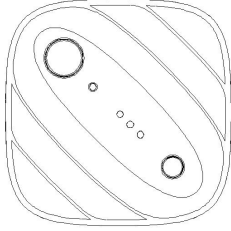

Tracker

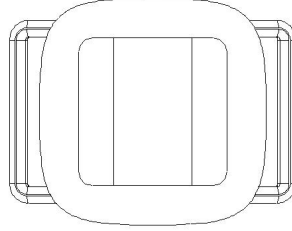

Silicon Case

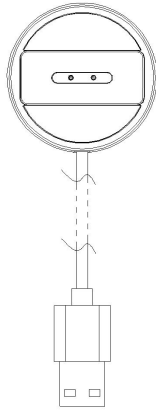

TR4 Tracker Charger

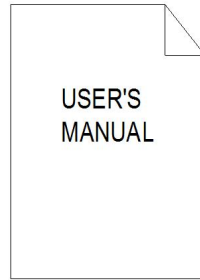

User manual

Activation Guide

PRODUCT OVERVIEW

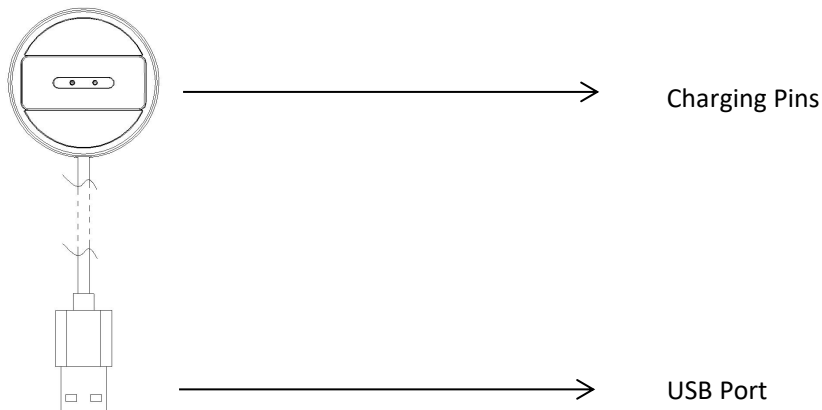
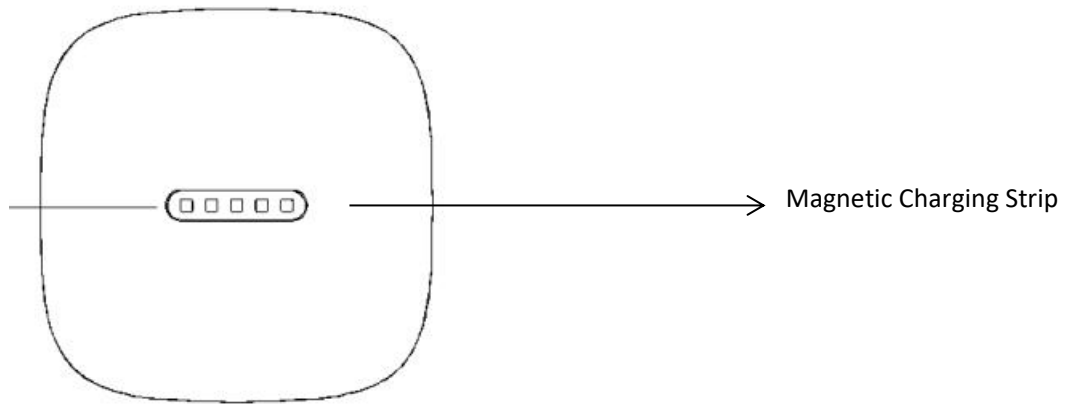
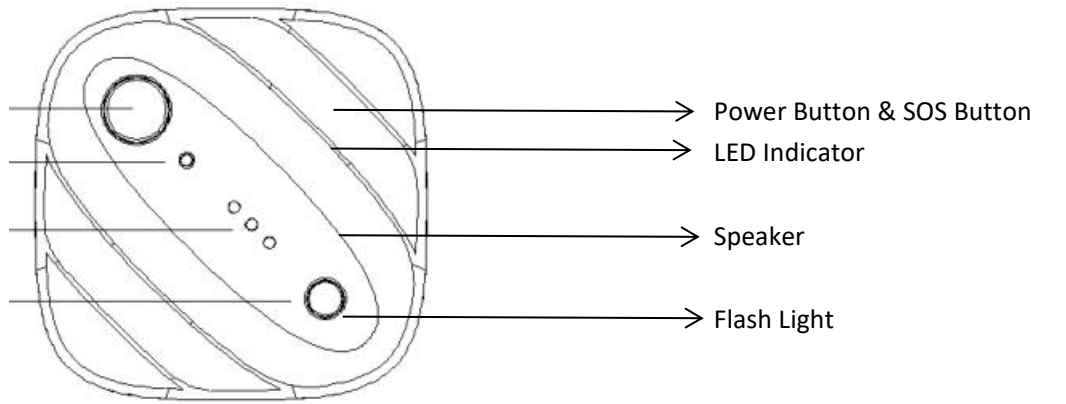

- Power Button - Press and hold for 6 seconds to turn the TR4 Tracker on/off.
- SOS Button - Press and hold for 3 seconds to access the real location of TR4 Tracker on your LaView app.

- TR4 Tracker LED Status

No light	The TR4 Tracker is on standby/off
Blinking yellow and green light	The TR4 Tracker is waiting for pairing
Solid yellow light	The TR4 Tracker is charging
Solid green light	The TR4 Tracker is fully charged
Blue light blinking for three times	The TR4 Tracker is turning on/off

- Speaker - Receive audible feedback from device to track your item.
- Flash light - Receive flash light feedback from device to track your item.

SETTING UP THE SYSTEM

Download The LaView App

1. LaView App is available for both iOS and Android OS. Search the name 'LaView', in App Store or Google Play. (The other LaView apps, such as LaView Connect, LaView ONE, LaView Life do not support the TR4 Tracker)
2. Complete the app registration process.
3. TIPS: Download the LaView App now by scanning the QR Code below:



Connect Base Station to the App

1. Connect the USB end of the TR4 Tracker Charger to the a 12V 1A power adapter.
2. Open the LaView App. Click the blue plus icon (on the top right corner in 'Home') or 'Add Device'.
3. Select 'Auto Scan'.
4. The Auto Scan feature will scan your local network for searching devices. You will also need to have a 2.4 GHz Wi-Fi network selected and Bluetooth enabled.
5. Select TR4 4G GPS Tracker Charger icon and follow up the in-app instructions to finish the setup process.

Note: If you do not have a power adapter for powering on the tracker charger currently, it's fine to skip this section.

Subscribe our Tracker Plan

Please refer to the Activation Guide along with the package and subscribe to our LaView tracker plan before you use the TR4 tracker on our the LaView app.

Connect TR4 Tracker to the LaView App

1. Press the power button on the TR4 Tracker and hold down for 6 seconds to activate it.
2. Wait until the blue light flashes three times, the TR4 Tracker is now activated.
3. Open the LaView App. Click the blue plus icon (on the top right corner in 'Home' or 'Add Device').
4. Select 'Auto Scan'.
5. The Auto Scan feature will scan your local network for searching devices. You will also need to have a 2.4 GHz Wi-Fi network selected and Bluetooth enabled.
6. Select TR4 4G GPS Tracker icon and follow up the in-app instructions to finish the setup process.

TIPS: If you are setting up the tracker system for the first time, the LaView app will send a binding request for setting up your base station, please follow the in-APP instruction to finish the set up process.

CHARGE YOUR TR4 TRACKER

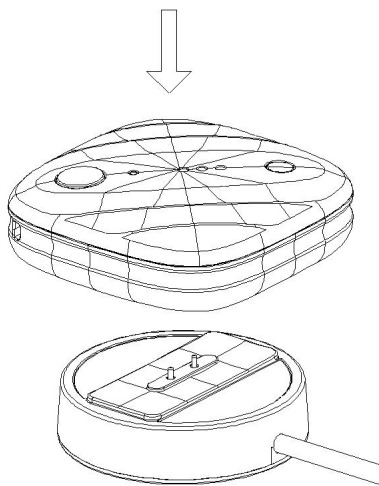

1. Align the charging pins of the USB cable with the charging strip on the back of the TR4 Tracker.
2. Connect the USB end of the TR4 Tracker Charger to a 12V 1A power adapter.
3. Plug the adapter into an power outlet to charge the TRACKER.
4. The LED indicator will be yellow when charging and green when fully charged.

TROUBLESHOOTING GUIDE

- Battery

What can I do if the battery of the tracker drains too fast?

1. The battery life of the tracker varies based on the tracker operating mode.
2. Cold temperatures affect battery's capacity because of their chemistry. If you install the tracker outside in cold temperatures, you might notice a shorter battery duration for the tracker, or a faster than expected drop in the displayed battery capacity.

- Waterproof and Outdoor Use

The camera is IP67 rated for totally dust tight and protection against low-pressure jets of directed water from any angle. The camera can operate between 0°C ~40°C (32°F ~104°F) for all weather use. Please avoid heavy rain or snow to maximize the tracker life span.

- Care and Cleaning

Use a soft, clean cloth and warm water to wipe off the TR4 Tracker. While most household cleaners should not stain or damage the device, check on a small area first. The USB charging cable and adapter should only be cleared with a dry, clean cloth.

TIPS: For more technical questions or tutorials, please follow in-APP tutorial section in the LaView APP or visit our YouTube tutorials.

FCC COMPLIANCE

This device complies with Part 15 of the FCC rules Operation is subject to the following two conditions:

1- this device may not cause harmful interference,

2- this device must accept any interference received, including interference that may cause undesired operation.

The manufacturer is not responsible for any radio or tv interference caused by unauthorized modifications or change to this equipment. Such modifications or change could void the user's authority to operate the equipment.

This equipment has been tested and found to comply with the limits for a Class B digital device, pursuant to part 15 of the FCC Rules. These limits are designed to provide reasonable protection against harmful interference in a residential installation.

This equipment generates, uses and can radiate radio frequency energy and, if not installed and used in accordance with the instructions, may cause harmful interference to radio communications. However, there is no guarantee that interference will not occur in a

particular installation. If this equipment does cause harmful interference to radio or television reception, which can be determined by turning the equipment off and on, the user is encouraged to try to correct the interference by one Or more of the following measures: - Reorient or relocate the receiving antenna.

. Increase the separation between the equipment and receiver.

. Connect the equipment into an outlet on a circuit different from that to which the receiver is connected.

- Consult the dealer or an experienced radio/TV technician for help.

RF warning statement:

To maintain compliance with FCC's RF exposure guidelines, this equipment should be installed and operated with a minimum distance of 20 cm between the radiator and your body which can be determined by timing the equipment off and on, the user is encouraged to try to correct the interference by one or more of the following measures:

- Reorient or relocate the receiving antenna.

- Increase the separation between the equipment and receiver.
- Connect the equipment into an outlet on a circuit different from that to which the receiver is connected.
- Consult the dealer or an experienced radio/TV technician for help.

RF warning statement:

To maintain compliance with FCC's RF exposure guidelines, this equipment should be installed and operated with a minimum distance of 20cm between the radiator and your body.

PARAMETER

Product Information	
Dimensions	47mm x 74mm x 15mm
Weight	40g
Color	Black, White, Grey, Green, Pink
System Information	
Wifi	802.11b/g/n(Chip:BK3633)
Bluetooth	BT 5.2(Chip:BK3633)
Bluetooth Base Station	YES (Chip:RTL 8720cm)
GPS	Support
Bai Dou	Support
Glonass	Support
Galileo	Support
G-SENSOR	Support
Acceleration Sensor	Support
Network & Bands	
4G Network Bands	Cat M1: B1,B2,B3,B4,B5,B8,B12,B13,B18,B19,B20, B25,B26,B27,B28
LTE Category	Cat.M
Others	
Battery	600mAh
Working Time	90 DAYS (Normal Use Mode)
Stand-by Time	500 DAYS (In Bluetooth Connection Mode)
Buzzer	Support
Flash-lighter	Support
IP Rating	IP67
Working Conditions	0°C -40°C

CUSTOMER SERVICE

We proudly offer manufacture 1 year warranty on all LaView products.

If you wish to return a product within the warranty period, please message us directly in your Amazon account or on our website.



LIVE CHAT:

In LaView APP or on laviewusa.com



Email: info@laviewusa.com

Our professional technicians are committed to reply all your requests within 24 hours



If you purchased from Amazon, you can also contact our professional customer service team in your Amazon account

WARRANTY CARD

Your LaView product is protected by a 1-year warranty from the purchase date. For more information on repairs, exchange, and other policies, please visit:

www.laviewusa.com

Please send all inquiries through the Contact Form on our website, or email us at info@laviewusa.com. And our technicians would be glad to assist you.

FCC Warning

This device complies with part 15 of the FCC rules. Operation is subject to the following two conditions: (1) this device may not cause harmful interference, and (2) this device must accept any interference received, including interference that may cause undesired operation.

Changes or modifications not expressly approved by the party responsible for compliance could void the user's authority to operate the equipment.

NOTE: This equipment has been tested and found to comply with the limits for a Class B digital device, pursuant to part 15 of the FCC Rules. These limits are designed to provide reasonable protection against harmful interference in a residential installation. This equipment generates uses and can radiate radio frequency energy and, if not installed and used in accordance with the instructions, may cause harmful interference to radio communications. However, there is no guarantee that interference will not occur in a particular installation. If this equipment does cause harmful interference to radio or television reception, which can be determined by turning the equipment off and on, the user is encouraged to try to correct the interference by one or more of the following measures:

-Reorient or relocate the receiving antenna.

•Increase the separation between the equipment and receiver.

•Connect the equipment into an outlet on a circuit different from that to which the receiver is connected.

•Consult the dealer or an experienced radio/TV technician for help.

Radiation Exposure Statement

This equipment complies with FCC radiation exposure limits set forth for an uncontrolled environment. This equipment should be installed and operated with minimum distance 20cm between the radiator and your body.