



# NFC TEST REPORT

No.I22Z61533-IOT18

for

**Wingtech Group (Hong Kong) Limited**

**5G Mobile Phone**

**Model Name: Celero5G+**

**FCC ID: 2APXW-CELERO5GPLUS**

with

**Hardware Version: V1.0**

**Software Version: Celero5GPlus\_0.01.03**

**Issued Date: 2022-10-31**

**Note:**

The test results in this test report relate only to the devices specified in this report. This report shall not be reproduced except in full without the written approval of CTTL.

The report must not be used by the client to claim product certification, approval, or endorsement by NVLAP, NIST, or any agency of the U.S.Government.

**Test Laboratory:**

**CTTL-Telecommunication Technology Labs, CAICT**

No. 52, Huayuan North Road, Haidian District, Beijing, P. R. China 100191.

Tel:+86(0)10-62304633-2512, Fax:+86(0)10-62304633-2504

Email: [ctl\\_terminals@caict.ac.cn](mailto:ctl_terminals@caict.ac.cn), website: [www.caict.ac.cn](http://www.caict.ac.cn)



## **REPORT HISTORY**

<b>Report Number</b>	<b>Revision</b>	<b>Description</b>	<b>Issue Date</b>
I22Z61533-IOT18	Rev.0	1 <sup>st</sup> edition	2022-10-31

Note: the latest revision of the test report supersedes all previous version.



## **CONTENTS**

<b>1. TEST LABORATORY .....</b>	<b>4</b>
<b>1.1. INTRODUCTION &amp; ACCREDITATION.....</b>	<b>4</b>
<b>1.2. TESTING LOCATION .....</b>	<b>4</b>
<b>1.3. TESTING ENVIRONMENT .....</b>	<b>5</b>
<b>1.4. PROJECT DATA .....</b>	<b>5</b>
<b>1.5. SIGNATURE.....</b>	<b>5</b>
<b>2. CLIENT INFORMATION.....</b>	<b>6</b>
<b>2.1. APPLICANT INFORMATION.....</b>	<b>6</b>
<b>2.2. MANUFACTURER INFORMATION.....</b>	<b>6</b>
<b>3. EQUIPMENT UNDER TEST (EUT) AND ANCILLARY EQUIPMENT (AE) .....</b>	<b>7</b>
<b>3.1. ABOUT EUT .....</b>	<b>7</b>
<b>3.2. INTERNAL IDENTIFICATION OF EUT .....</b>	<b>7</b>
<b>3.3. INTERNAL IDENTIFICATION OF AE .....</b>	<b>7</b>
<b>3.4. EUT SET-UPS.....</b>	<b>8</b>
<b>4. REFERENCE DOCUMENTS .....</b>	<b>9</b>
<b>4.1. DOCUMENTS SUPPLIED BY APPLICANT .....</b>	<b>9</b>
<b>4.2. REFERENCE DOCUMENTS FOR TESTING.....</b>	<b>9</b>
<b>5. TEST RESULTS .....</b>	<b>10</b>
<b>5.1. SUMMARY OF TEST RESULTS .....</b>	<b>10</b>
<b>5.2. STATEMENTS.....</b>	<b>10</b>
<b>6. TEST FACILITIES UTILIZED .....</b>	<b>11</b>
<b>7. MEASUREMENT UNCERTAINTY .....</b>	<b>12</b>
<b>ANNEX A: EUT PARAMETERS.....</b>	<b>13</b>
<b>ANNEX B: DETAILED TEST RESULTS.....</b>	<b>14</b>
<b>ANNEX C: PERSONS INVOLVED IN THIS TESTING .....</b>	<b>26</b>
<b>ANNEX D: ACCREDITATION CERTIFICATE .....</b>	<b>27</b>



## **1. Test Laboratory**

### **1.1. Introduction & Accreditation**

**Telecommunication Technology Labs, CAICT** is an ISO/IEC 17025:2017 accredited test laboratory under NATIONAL VOLUNTARY LABORATORY ACCREDITATION PROGRAM (NVLAP) with lab code 600118-0, and is also an FCC accredited test laboratory (CN5017), and ISED accredited test laboratory (ISED#: 24849). The detail accreditation scope can be found on NVLAP website.

### **1.2. Testing Location**

Location 1: CTTL(huayuan North Road)

Address: No. 52, Huayuan North Road, Haidian District, Beijing,  
P. R. China 100191

### 1.3. Testing Environment

Normal Temperature: 15-35°C  
Extreme Temperature: -20/+55°C  
Normal Relative Humidity: 10-75%  
Normal Air Pressure 86Kpa-106Kpa

### 1.4. Project data

Testing Start Date: 2022-09-15  
Testing End Date: 2022-10-09

### 1.5. Signature

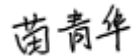

---

Miao Qinghua

(Prepared this test report)



---

Zhou Bin

(Reviewed this test report)



---

Pang Shuai

(Approved this test report)



## **2. Client Information**

### **2.1. Applicant Information**

Company Name: Wingtech Group (Hong Kong) Limited  
Address: Flat/RM 1802 18/F, Podium Plaza, 5 Hanoi Road, Tsim Sha Tsui, KL, HK  
Contact: sharui  
Telephone: +86-21-53529900  
Email: sharui@wingtech.com

### **2.2. Manufacturer Information**

Company Name: Wingtech Group (Hong Kong) Limited  
Address: Flat/RM 1802 18/F, Podium Plaza, 5 Hanoi Road, Tsim Sha Tsui, KL, HK  
Contact: sharui  
Telephone: +86-21-53529900  
Email: sharui@wingtech.com

### 3. Equipment Under Test (EUT) and Ancillary Equipment (AE)

#### 3.1. About EUT

Description	5G Mobile Phone
Model Name	Celero5G+
FCC ID	2APXW-CELERO5GPLUS
GSM Frequency bands	850/900/1800/1900
UMTS Frequency bands	FDD II/IV/V
E-UTRA Frequency bands	FDD 2/4/5/12/14/25/26/29/30/66/71 TDD 41/48
5G NR Frequency bands	NSA n2/n5/n25/n29/n30/n41/n48/n66/n70/n71/n77 SA n2/n5/n25/n30/n41/n48/n66/n70/n71/n77
Operating temperature	-10/+55°C
Extreme low voltage	3.6 V
Normal voltage	3.85 V
Extreme high voltage	4.2 V

#### 3.2. Internal Identification of EUT

EUT ID*	SN or IMEI	HW Version	SW Version
UT92a	869183060032640	V1.0	Celero5GPlus_0.01.03
UT93a	869183060032541	V1.0	Celero5GPlus_0.01.03

\*EUT ID: is used to identify the test sample in the lab internally.

#### 3.3. Internal Identification of AE

AE ID*	Description	SN	Remarks
AE1	Battery	/	/
AE2	USB Cable	/	/
AE3	Charger	/	/
AE1			
Model		TM001	
Manufacturer		Dongguan Veken Battery Co., Ltd.	
Capacity		min4900,typ5000	
Nominal Voltage		3.87V	
AE2			
Model		BLJ15W050300U-U	
Manufacturer		Zhongshan Baolijin Electronic Co., Ltd.	
Length of cable		/	
AE3			
Model		USB AM TO TYPE-C2.0	
Manufacturer		Huizhou Washin Electronics Co., LTD	



Length of cable /

**3.4. EUT Set-ups**

<b>EUT set-up No.</b>	<b>Combination of EUT and AE</b>	<b>Remarks</b>
Set.NFC01	UT93a + AE1 + AE2 + AE3 + NFC Card	---
Set.NFC02	UT93a + AE1+NFC card	---
Set.NFC03	UT92a	---

The Transmit State of NFC: the NFC function is on. The EUT will transmit the NFC data and command continuously during the test.

The Transmit state without modulation: The EUT will transmit the CW signal at the operating frequency.



## 4. Reference Documents

### 4.1. Documents supplied by applicant

EUT parameters, referring to Annex A for detailed information, are supplied by the client or manufacturer, which are the bases of testing.

### 4.2. Reference Documents for testing

The following documents listed in this section are referred for testing.

<b>Reference</b>	<b>Title</b>	<b>Version</b>
CFR 47 Part 2	Part 2 — Frequency Allocations and Radio Treaty Matters; General Rules and Regulations.	2019
CFR 47 Part 15	Part 15 — Radio Frequency Devices. Subpart C — Intentional Radiators. § 15.35 Measurement detector functions and bandwidths. § 15.207 Conducted limits. § 15.209 Radiated emission limits, general requirements. § 15.215 Additional provisions to the general radiated emission limitations. § 15.225 Operation within the band 13.110–14.010 MHz.	2019
ANSI C63.10	American National Standard of Procedures for Compliance Testing of Unlicensed Wireless Devices	2013

## 5. Test Results

### 5.1. Summary of Test Results

No	Test Cases	Clause in Regulation	Section in This Report	Verdict
1	Electric Field Strength of Fundamental Emissions	CFR 47 § 15.225(a)	B.1	P(Set. NFC02)
2	Electric Field Strength of Outside the Allocated Bands	CFR 47 § 15.225(b) CFR 47 § 15.225(c)		P(Set. NFC02)
3	Electric Field Radiated Emissions	CFR 47 § 15.209	B.2	P(Set. NFC01)
		CFR 47 § 15.225(d)	B.3	P(Set. NFC01)
4	Frequency Tolerance	CFR 47 § 15.225(e)	B.4	P(Set. NFC03)
5	20dB Bandwidth	CFR 47 § 15.215(c)	B.5	P(Set. NFC03)
6	Conducted Emissions	CFR 47 § 15.207	B.6	P(Set. NFC01)
The measurement is carried out according to ANSI C63.10. See <b>ANNEX B</b> for details.				

#### Test Conditions:

For this report, all the test cases listed above were tested under normal Temperature, Voltage, humidity and Air Pressure except the Frequency Tolerance test case. The specific conditions of Frequency Tolerance test case are listed in section B.4.3

See **Table 3** for terms for result verdict:

**Table 1 Terms for result verdict**

P	Pass, The EUT complies with the essential requirements in the standard.
NP	Not Perform, The test was not performed by CTTL
NA	Not Applicable, The test was not applicable
F	Fail, The EUT does not comply with the essential requirements in the standard

### 5.2. Statements

The test cases listed in Section 5.1 of this report for the EUT specified in Section 3 were performed by CTTL according to the reference documents in Section 4.

The EUT meets all applicable requirements of the regulations and standards in Section 4.2.



## 6. Test Facilities Utilized

NO.	NAME	TYPE	SERIES NUMBER	PRODUCER	CAL. DUE DATE	CAL. INTERVAL
1.	Spectrum Analyzer	FSL 6	100869	Rohde & Schwarz	2022-10-23	1 Year
2.	Spectrum Analyzer	FSW67	104051	R&S	2023-01-02	1 Year
3.	Climatic chamber	SH242	93008658	ESPEC	2023-02-21	2 Year
4.	Test Receiver	ESW44	103023	R&S	2022-10-28	1 Year
5.	H-field Antenna	HFH2-Z2	829324/007	R&S	2022-12-23	1 Year
6.	EMI Antenna	VULB 9163	302	SCHWARZBECK	2022-12-28	1 Year
7.	Test Receiver	ESCI	100344	R&S	2023-03-21	1 Year
8.	LISN	ENV216	101200	R&S	2023-05-30	1 Year

## 7. Measurement Uncertainty

Item	Uncertainty
Frequency Tolerance	$U = 73 \text{ Hz}, k=2$
20dB Bandwidth	$U = 74 \text{ Hz}, k=2$
Radiated Emissions(9kHz-30MHz)	$U = 4.92 \text{ dB}, k=2$
Radiated Emissions (30MHz-1GHz)	$U = 5.15 \text{ dB}, k=2$
Radiated Emissions (>1GHz)	$U = 5.54 \text{ dB}, k=2$
Conducted emission	$U = 3.08 \text{ dB}, k=2$



**ANNEX A: EUT parameters**

/

## **ANNEX B: Detailed Test Results**

### **B.1. Electric Field Strength of Fundamental and Outside the Allocated bands**

#### **B.1.1. Reference**

See CFR 47 Part 15 § 15.209

See CFR 47 Part 15 § 15.225

See Clause 4, Clause 5 of ANSI C63.10-2013 generally.

#### **B.1.2. Measurement Methods**

The transmitter carrier output levels (E-Field) from the EUT are measured in a semi-anechoic chamber. The EUT is placed on a non-conductive stand of 80cm high, and at a measurement distance of 3m from the receiving antenna. The center of the receiving loop antenna is 1.0 meter above the ground. The E-field is measured with a shielded loop antenna connected to a measurement receiver. Detected E-field was maximized by rotating the EUT through 360° and adjusting the receiving antenna polarizations. The maximization processes were repeated with the EUT positioned respectively in its three orthogonal axes. The measurements were performed with the peak detector and if required, the quasi-peak detector.

The measurement bandwidth is:

**Table B-1: Measurement bandwidth**

Frequency of Emission (MHz)	RBW/VBW
12.56-14.56	10/30 kHz

The E-field measured at 3m is calculated as:

$$\text{E-field (dB}\mu\text{V/m)} = \text{Rx (dB}\mu\text{V)} + \text{Cable Loss (dB)} + \text{AF@3m (dB/m)}$$

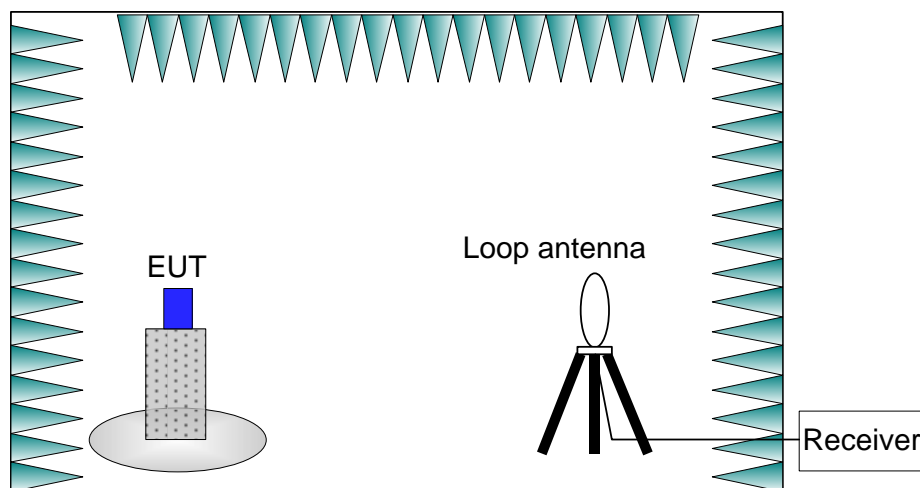

**Figure B-1: Measurement Setup**

#### **B.1.3. EUT Operating Mode and Test Conditions**

The measurement of EUT is carried out under the transmit state of NFC(See 3.4).

The EUT is powered by a travel adapter.

During the measurements, the ambient temperature of the electromagnetic anechoic chamber is

in the range of 15 ~ 25 °C.

**B.1.4. Limits**

**Table B-2: Limits**

Frequency Range (MHz)	E-field Strength Limit @ 30 m (μV/m)	E-field Strength Limit @ 3 m (dBμV/m)
13.560 ± 0.007	+15,848	124
13.410 to 13.553 13.567 to 13.710	+334	90
13.110 to 13.410 13.710 to 14.010	+106	81

Note: Where the limits have been defined at one distance, and a signal level measured at another, the limits have been extrapolated using the following formula:  

$$\text{Extrapolation (dB)} = 40 \log_{10}(\text{Measurement Distance} / \text{Specification Distance})$$

**B.1.5. Measurement Results**

Measurement results of normal conditions see Figure B-2 for different set-ups of EUT. The results displayed take into account applicable antenna factors and cable losses.

**Conclusions: Set.NFC02, PASS.**

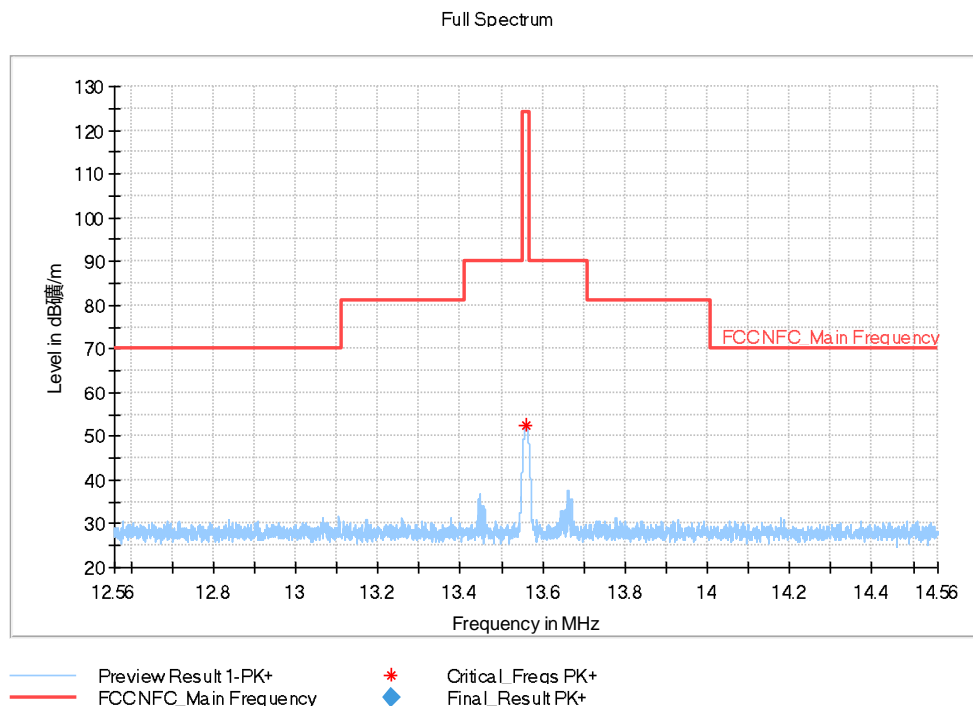

**Figure B-2: Measurement results for Electric Field Strength of Fundamental and Outside the Allocated bands**

**Figure B-3: Final\_Result**

Frequency (MHz)	MaxPeak (dBμV/m)	Limit (dBμV/m)	Margin (dB)	Pol	Azimuth (deg)
13.558250	52.65	124.00	71.35	V	175.0

## **B.2. Electric Field Radiated Emissions (< 30MHz)**

### **B.2.1. Reference**

See CFR 47 Part 15 § 15.209

See Clause 6.4 of ANSI C63.10-2013 specifically.

See Clause 4 and Clause 5 of ANSI C63.10-2013 generally.

### **B.2.2. Measurement Methods**

The transmitter carrier output levels (E-Field) from the EUT are measured in a semi-anechoic chamber. The EUT is placed on a non-conductive stand of 80cm high, and at a measurement distance of 3m from the receiving antenna. The center of the receiving loop antenna is 1.0 meter above the ground. The E-field is measured with a shielded loop antenna connected to a measurement receiver. Detected E-field was maximized by rotating the EUT through 360° and adjusting the receiving antenna polarizations. The maximization processes were repeated with the EUT positioned respectively in its three orthogonal axes. The measurements were performed with the peak detector and if required, the quasi-peak detector.

The measurement bandwidth is:

Frequency of Emission (MHz)	RBW/VBW
0.009-0.15	100/300 Hz
0.15-30	10/30 kHz

The E-field measured at 3m is calculated as:

$$\text{E-field (dB}\mu\text{V/m)} = \text{Rx (dB}\mu\text{V)} + \text{Cable Loss (dB)} + \text{AF@3m (dB/m)}$$

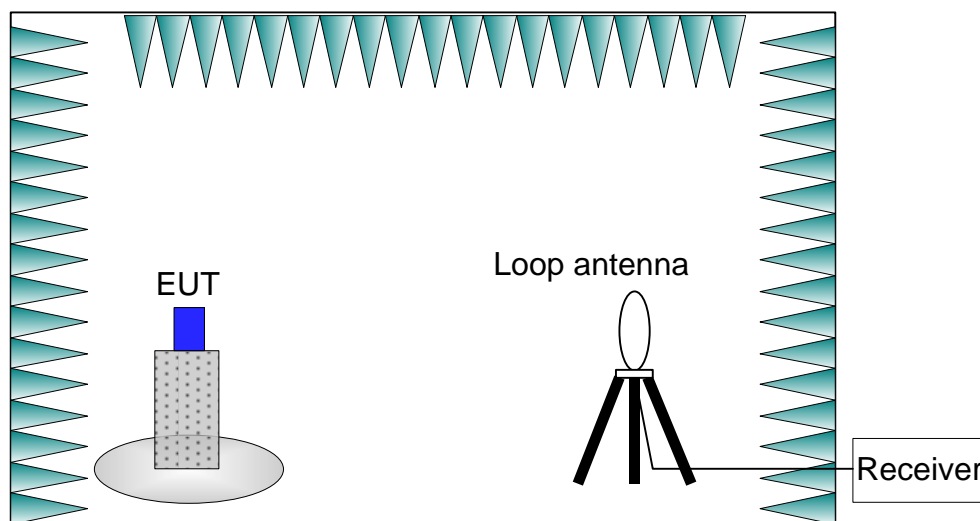

**Figure B-4: Measurement Setup**

### **B.2.3. EUT Operating Mode and Test Conditions**

The measurement of EUT is carried out under the transmit state of NFC(See 3.4).



The EUT is powered by a travel adapter.

During the measurements, the ambient temperature of the electromagnetic anechoic chamber is in the range of 15 ~ 25 °C.

**B.2.4. Limits**

Frequency Range (MHz)	E-field Strength Limit @ 30m (mV/m)	E-field Strength Limit @ 3m (dBµV/m)
0.009-0.490	2400/F(kHz)	129-94
0.490-1.705	24000/F(kHz)	74-63
1.705-30	30	70

Note: Where the limits have been defined at one distance, and a signal level measured at another, the limits have been extrapolated using the following formula:

$$\text{Extrapolation(dB)} = 40\log_{10}(\text{Measurement Distance}/\text{Specification Distance})$$

**B.2.5. Measurement Results**

Measurement results of normal conditions see Figure B-4 for different set-ups of EUT. The results displayed take into account applicable antenna factors and cable losses.

**Conclusions:** Set.NFC01, **PASS**.

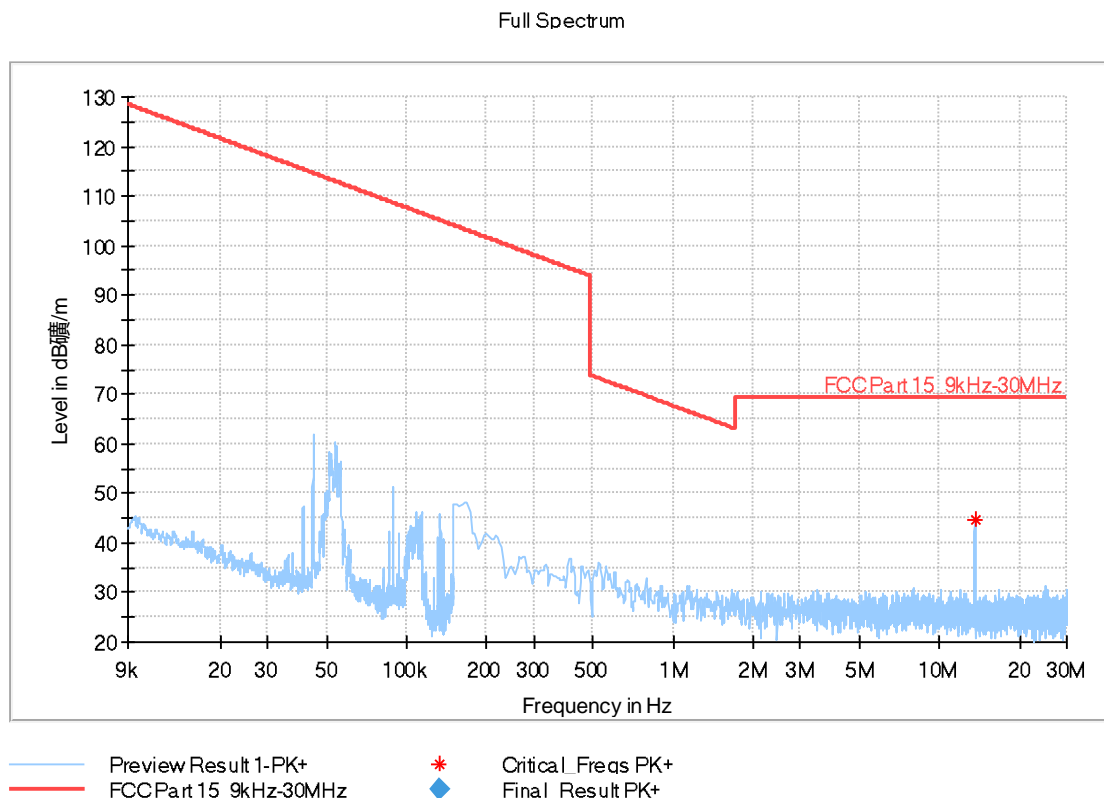

**Figure B-5: Measurement results for Electric Field Radiated Emissions (< 30MHz)**

**Final\_Result**

Frequency (MHz)	MaxPeak (dBµV/m)	Limit (dBµV/m)	Margin (dB)	Pol	Azimuth (deg)
13.560113	44.53	69.50	24.97	V	90.0

### **B.3. Electric Field Radiated Emissions ( $\geq 30\text{MHz}$ )**

#### **B.3.1. Reference**

See CFR 47 Part 15 § 15.209

See Clause 6.5 of ANSI C63.10-2013 specifically.

See Clause 4 and Clause 5 of ANSI C63.10-2013 generally.

#### **B.3.2. Measurement Methods**

The electric field radiated emissions from the EUT are measured in a semi-anechoic chamber. The EUT is placed on a non-conductive stand of 80cm high, and at a measurement distance of 10m from the receiving antenna. The receiving antennas connected to a measurement receiver. In order to search for maximum field strength emitted from the EUT, the receiving antenna can be moved between the height of 1.0 m to 4.0 m. Detected E-field was maximized at each frequency by rotating the EUT through 360° and adjusting the receiving antenna positions for both vertical and horizontal antenna polarizations. The maximization processes were repeated with the EUT positioned respectively in its three orthogonal axes. The measurements were performed with the peak detector and if required, the quasi-peak detector.

The measurement bandwidth is:

Frequency of Emission (MHz)	RBW/VBW
30-1000	120kHz

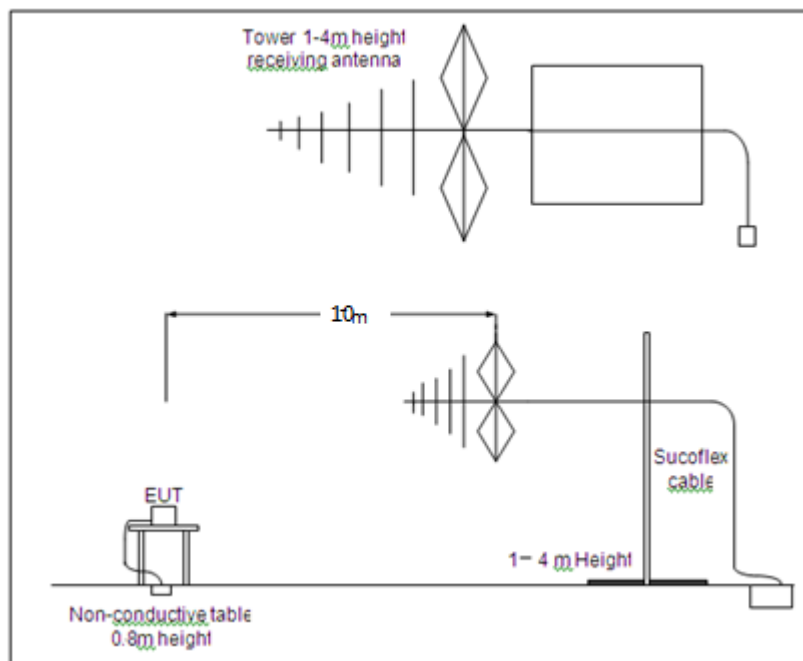

**Figure B-6: Measurement Setup**

#### **B.3.3. EUT Operating Mode and Test Conditions**

The measurement of EUT is carried out under the transmit state of NFC(See 3.4).

The EUT had been connected to a travel adapter.

During the measurements, the ambient temperature of the electromagnetic anechoic chamber is

in the range of 15 ~ 25 °C.

**B.3.4. Limits**

Frequency Range (MHz)	E-field Strength Limit @ 3m (mV/m)	E-field Strength Limit @ 3m (dBµV/m)	E-field Strength Limit @ 10m (dBµV/m)
30-88	100	40	30
88-216	150	43.5	33.5
216-960	200	46	36
960-1000	500	54	44

**B.3.5. Measurement Results**

Measurement results of normal conditions see Figure B-6 for different set-ups of EUT. The results displayed take into account applicable antenna factors and cable losses.

**Conclusions: Set.NFC01, PASS.**

RE FCC\_30MHz-1GHz\_10m\_Direct\_testing\_FP5b

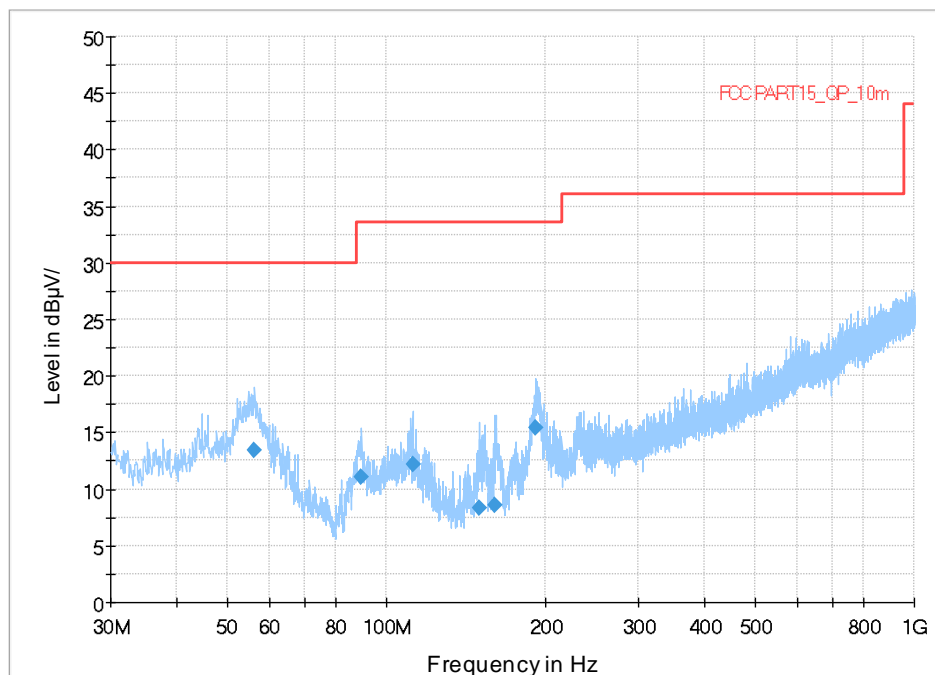

**Figure B-7: Measurement results for Electric Field Radiated Emissions (≥30MHz)**

**Final\_Result**

Frequency (MHz)	QuasiPeak (dBµV/m)	Limit (dBµV/m)	Margin (dB)	Height (cm)	Pol	Azimuth (deg)
56.287000	13.4	30.0	10.9	100.0	V	130.0
89.752000	11.1	33.5	18.1	125.0	V	270.0
112.062000	12.2	33.5	16.6	100.0	V	309.0
150.086000	8.3	33.5	17.6	100.0	V	55.0
160.271000	8.6	33.5	16.9	125.0	V	135.0
191.893000	15.4	33.5	13.7	100.0	V	27.0

## **B.4. Frequency Tolerance**

### **B.4.1. Reference**

See CFR 47 Part 15 § 15.225(e)

See Clause 6.8 of ANSI C63.10-2013 specifically.

See Clause 4 and Clause 5 of ANSI C63.10-2013 generally.

### **B.4.2. Measurement Methods**

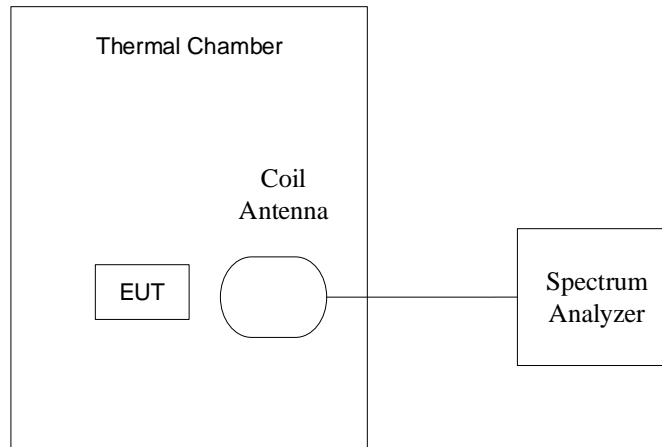

**Figure B-8: Measurement Setup**

The transmitter output signal was picked up by coil antenna connected to the spectrum analyzer. The center frequency was measured with 30Hz RBW and 1kHz span. During the test, the EUT was placed in a thermal chamber until thermal balance and lasting appropriate time.

### **B.4.3. EUT Operating Mode and Test Conditions**

The measurement of EUT was carried out under the transmit state of without modulation(See 3.4). EUT had not been connected to a travel adapter. The frequency stability was measured with the different voltage and temperature combinations:

- a) The nominal voltage 3.85V(See 3.1)was used and the temperature was varied from -20°C to +50°C in 10°C increments using an environmental chamber.
- b) The 20°C was used and the voltages were 3.6V, 3.85V and 4.2V (The extreme low voltage ,the normal voltage and the normal voltage defined in section 3.1).

The details were as following:

**Table B-3: Combinations of Voltage andTemperature**

Test items	Voltage	Temperature
Frequency stability with respect to ambient temperature	3.85V	-20°C
		-10°C
		0°C
		10°C
		20°C
		30°C

		40°C
		50°C
Frequency stability when varying supply voltage	3.6 V	20°C
	3.85V	
	4.2V	

#### B.4.4. Test Layouts

See B.4.2.

#### B.4.5. Limits

The frequency tolerance of the carrier signal shall be maintained within +/- 0.01% of the operating frequency.

#### B.4.6. Measurement Results

Measurement results see Table B-4 for different test conditions.

**Conclusions:** Set.NFC03, **PASS**.

**Table B-4: Measurement results for Frequency Tolerance**

Temperature	Voltage	Frequency (MHz)			
		Startup	2 Min Later	5 Min Later	10 Min Later
-20°C	3.85V	13.559860000	13.559860000	13.559840000	13.559840000
-10°C	3.85V	13.559860000	13.559860000	13.559880000	13.559880000
0°C	3.85V	13.559832000	13.559832000	13.559840000	13.559840000
10°C	3.85V	13.559776000	13.559804000	13.559804000	13.559804000
20°C	3.85V	13.559741000	13.559760000	13.559780000	13.559780000
30°C	3.85V	13.559780000	13.559760000	13.559741000	13.559741000
40°C	3.85V	13.559721000	13.559721000	13.559681000	13.559681000
50°C	3.85V	13.559701000	13.559701000	13.559701000	13.559641000
20°C	3.6V	13.559741000	13.559741000	13.559760000	13.559760000
20°C	4.2V	13.559760000	13.559760000	13.559760000	13.559780000

Temperature	Voltage	Frequency Error (%)			
		Startup	2 Min Later	5 Min Later	10 Min Later
-20°C	3.85V	-0.001	-0.001	-0.001	-0.001
-10°C	3.85V	-0.001	-0.001	-0.001	-0.001
0°C	3.85V	-0.001	-0.001	-0.001	-0.001
10°C	3.85V	-0.002	-0.001	-0.001	-0.001
20°C	3.85V	-0.002	-0.002	-0.002	-0.002
30°C	3.85V	-0.002	-0.002	-0.002	-0.002
40°C	3.85V	-0.002	-0.002	-0.002	-0.002
50°C	3.85V	-0.002	-0.002	-0.002	-0.003
20°C	3.6V	-0.002	-0.002	-0.002	-0.002
20°C	4.2V	-0.002	-0.002	-0.002	-0.002

#### B.4.7. Measurement Uncertainty

Measurement uncertainty:  $U = 73 \text{ Hz}$ ,  $k=2$

### B.5. 20dB Bandwidth

#### B.5.1. Reference

See CFR 47 Part 15 § 15.215(c)

See Clause 6.9 of ANSI C63.10-2013 specifically.

See Clause 4 and Clause 5 of ANSI C63.10-2013 generally.

#### B.5.2. Measurement Methods

The transmitter output signal was picked up by coil antenna connected to the spectrum analyzer. The bandwidth of the center frequency was measured with 150Hz RBW, 470Hz VBW and 10kHz span.

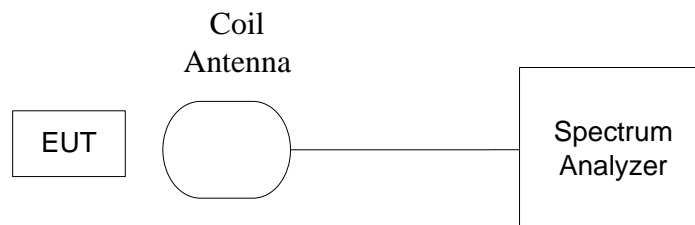

**Figure B-9: Measurement Setup**

#### B.5.3. EUT Operating Mode and Test Conditions

The measurement of EUT was carried out under the transmit state of NFC (See 3.4).

EUT had not been connected to a travel adapter.

During the measurements, the ambient temperature was in the range of 15 ~ 25 °C.

#### B.5.4. Test Layouts

See B.5.2.

#### B.5.5. Limits

The 20dB bandwidth shall be less than 80% of the permitted frequency band. For 13.56 MHz NFC, the permitted frequency band is 14kHz, so the limit is 11.2 kHz.

#### B.5.6. Measurement Results

Measurement results see Figure B-9.

**Conclusions:** Set.NFC03, **PASS**.

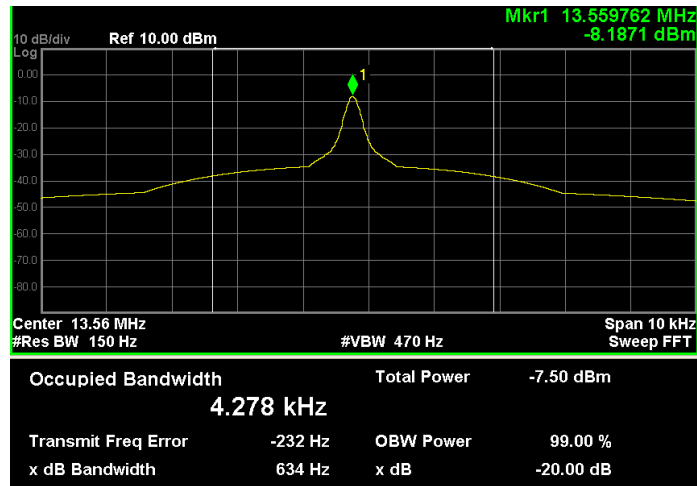

Figure B-10: Measurement results for 20dB Bandwidth

### B.5.7. Measurement Uncertainty

Measurement uncertainty:  $U = 74$  Hz,  $k=2$

## B.6. Conducted emission

### B.6.1. Reference

See CFR 47 Part 15 § 15.207

See Clause 6.2 of ANSI C63.10-2013 specifically.

See Clause 4 and Clause 5 of ANSI C63.10-2013 generally.

### B.6.2. Measurement Methods

The conducted emissions from the AC port of the EUT are measured in a shielding room. The EUT is connected to a Line Impedance Stabilization Network (LISN). An overview sweep with peak detection was performed. The measurements were performed with a quasi-peak detector and if required, an average detector.

The conducted emission measurements were made with the following detector of the test receiver: Quasi-Peak / Average Detector.

The measurement bandwidth is:

Table B-5: Measurement Bandwidth

Frequency of Emission (MHz)	RBW/VBW
0.15-30	9kHz

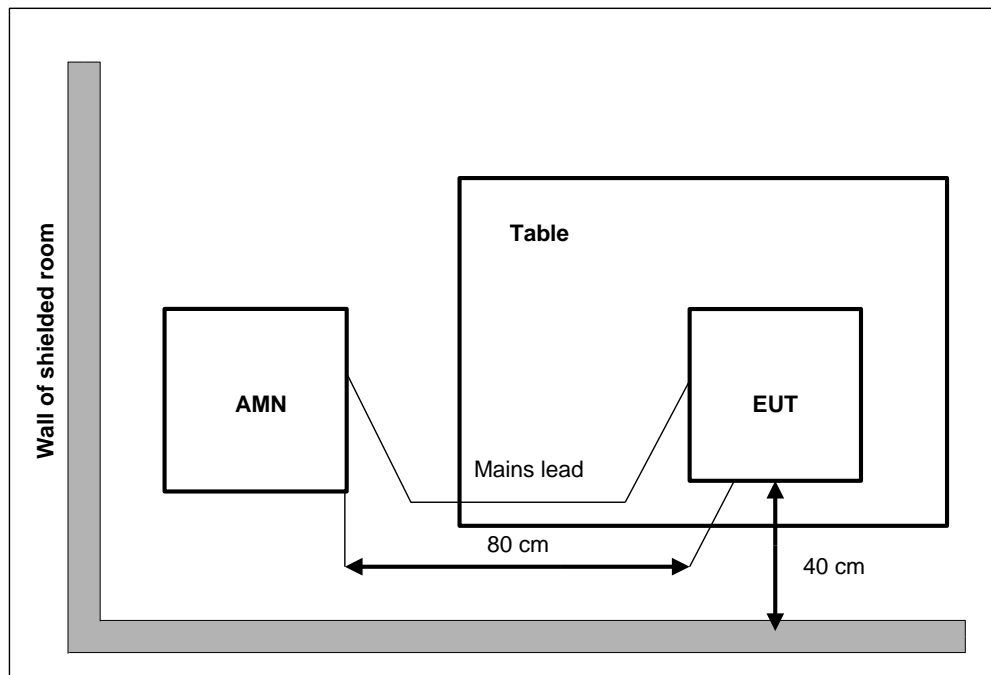

**Figure B-11: Measurement Setup**

### B.6.3. EUT Operating Mode and Test Conditions

The measurement of EUT is carried out under the transmit state of NFC(See 3.4).

The EUT is powered by a travel adapter.

During the measurements, the ambient temperature is in the range of 15 ~ 25 °C.

### B.6.4. Limits

Frequency range (MHz)	Quasi-peak Limit (dB $\mu$ V)	Average Limit (dB $\mu$ V)
0.15 to 0.5	66 to 56	56 to 46
0.5 to 5	56	46
5 to 30	60	50

### B.6.5. Measurement Results

Measurement results see Figure B-11.

**Conclusions:** Set.NFC01, **PASS**.



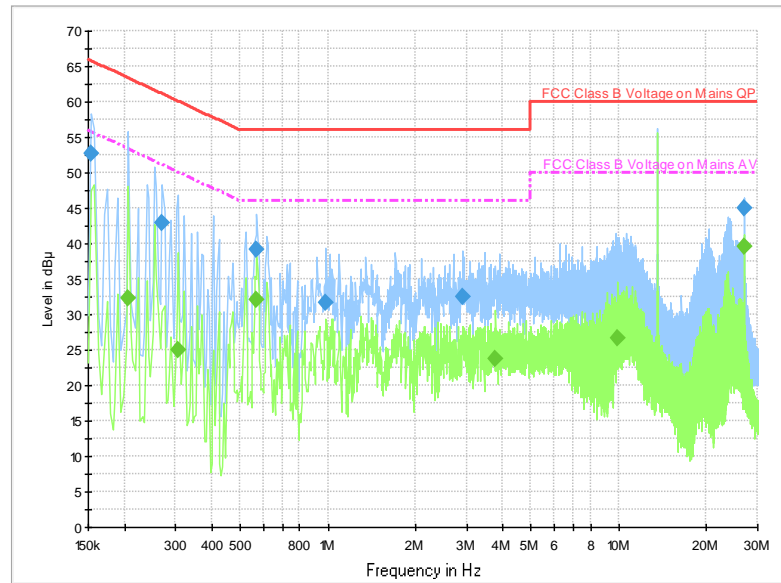

Figure B-12: Measurement results for Conducted Emission

Final Result 1

Frequency (MHz)	QuasiPeak (dBμV)	Meas. Time (ms)	Bandwidth (kHz)	Filter	Line	Corr. (dB)	Margin (dB)	Limit (dBμV)
0.154000	52.7	2000.0	9.000	On	L1	19.9	13.1	65.8
0.270000	42.9	2000.0	9.000	On	N	19.7	18.3	61.1
0.570000	39.2	2000.0	9.000	On	N	19.7	16.8	56.0
0.986000	31.7	2000.0	9.000	On	N	19.6	24.3	56.0
2.902000	32.5	2000.0	9.000	On	L1	19.6	23.5	56.0
27.118000	45.1	2000.0	9.000	On	N	19.8	14.9	60.0

Final Result 2

Frequency (MHz)	QuasiPeak (dBμV)	Meas. Time (ms)	Bandwidth (kHz)	Filter	Line	Corr. (dB)	Margin (dB)	Limit (dBμV)
0.206000	32.2	2000.0	9.000	On	N	19.7	21.1	53.4
0.306000	24.9	2000.0	9.000	On	N	19.7	25.2	50.1
0.570000	32.1	2000.0	9.000	On	N	19.7	13.9	46.0
3.778000	23.7	2000.0	9.000	On	N	19.6	22.3	46.0
9.918000	26.7	2000.0	9.000	On	L1	19.7	23.3	50.0
27.118000	39.5	2000.0	9.000	On	L1	19.9	10.5	50.0

**ANNEX C: Persons involved in this testing**

Test Item	Tester
20dB Bandwidth	Miao Qinghua
Frequency Tolerance	Miao Qinghua
Electric Field Strength of Fundamental and Outside the Allocated bands	Ding Zai
Electric Field Radiated Emissions (< 30MHz)	Ding Zai
Electric Field Radiated Emissions ( $\geq 30$ MHz)	Ding Zai
Conducted Emissions	Zhang Tianli

## ANNEX D: Accreditation Certificate

<p>United States Department of Commerce National Institute of Standards and Technology</p> <p><b>NVLAP</b>® </p> <hr/> <p><b>Certificate of Accreditation to ISO/IEC 17025:2017</b></p> <hr/> <p>NVLAP LAB CODE: 600118-0</p> <p><b>Telecommunication Technology Labs, CAICT</b> Beijing China</p> <p><i>is accredited by the National Voluntary Laboratory Accreditation Program for specific services, listed on the Scope of Accreditation, for:</i></p> <p><b>Electromagnetic Compatibility &amp; Telecommunications</b></p> <p><i>This laboratory is accredited in accordance with the recognized International Standard ISO/IEC 17025:2017. This accreditation demonstrates technical competence for a defined scope and the operation of a laboratory quality management system (refer to joint ISO-ILAC-IAF Communique dated January 2009).</i></p> <hr/> <p>2022-10-01 through 2023-09-30 <i>Effective Dates</i></p> <p style="text-align: center;"></p> <p style="text-align: right;"> <i>For the National Voluntary Laboratory Accreditation Program</i></p>	
--	--

\*\*\*END OF REPORT\*\*\*