



FCC PART 15C TEST REPORT

BLUETOOTH LOW ENERGY (BLE) PART

No. I22Z60731-IOT03

for

Wingtech Group (Hong Kong) Limited

4G Mobile phone

Model Name: WTCKT01

FCC ID: 2APXW-WTCKT01

with

Hardware Version: V1.1

Software Version: WTCKT01_0.01.12

Issued Date: 2022-6-23

Note:

The test results in this test report relate only to the devices specified in this report. This report shall not be reproduced except in full without the written approval of CTTL.

The report must not be used by the client to claim product certification, approval, or endorsement by NVLAP, NIST, or any agency of the U.S. Government.

Test Laboratory:

CTTL, Telecommunication Technology Labs, CAICT

No.52, HuayuanNorth Road, Haidian District, Beijing, P. R. China 100191.

Tel:+86(0)10-62304633-2512,Fax:+86(0)10-62304633-2504

Email:cttl_terminals@caict.ac.cn, website: www.chinattl.com



REPORT HISTORY

| Report Number | Revision | Description | Issue Date |
|----------------------|-----------------|--------------------|-------------------|
| I22Z60731-IOT03 | Rev.0 | 1st edition | 2022-6-23 |

CONTENTS

| | | |
|------|---|----|
| 1. | Test Laboratory | 5 |
| 1.1. | Introduction & Accreditation | 5 |
| 1.2. | Testing Location | 5 |
| 1.3. | Testing Environment | 6 |
| 1.4. | Project data | 6 |
| 1.5. | Signature | 6 |
| 2. | Client Information | 7 |
| 2.1. | Applicant Information | 7 |
| 2.2. | Manufacturer Information | 7 |
| 3. | Equipment Under Test (EUT) and Ancillary Equipment (AE) | 8 |
| 3.1. | About EUT | 8 |
| 3.2. | Internal Identification of EUT | 8 |
| 3.3. | Internal Identification of AE | 8 |
| 3.4. | Normal Accessory setting | 8 |
| 3.5. | General Description | 9 |
| 4. | Reference Documents | 10 |
| 4.1. | Documents supplied by applicant | 10 |
| 4.2. | Reference Documents for testing | 10 |
| 5. | Test Results | 11 |
| 5.1. | Summary of EUT Mode | 11 |
| 5.2. | Summary of Test Results | 11 |
| 5.3. | Statements | 11 |
| 6. | Test Facilities Utilized | 12 |
| 7. | Measurement Uncertainty | 13 |
| 7.1. | Peak Output Power - Conducted | 13 |
| 7.2. | Frequency Band Edges - Conducted | 13 |
| 7.3. | Frequency Band Edges - Radiated | 13 |
| 7.4. | Transmitter Spurious Emission - Conducted | 13 |
| 7.5. | Transmitter Spurious Emission - Radiated | 13 |
| 7.6. | 6dB Bandwidth | 13 |
| 7.7. | Maximum Power Spectral Density Level | 14 |
| 7.8. | AC Powerline Conducted Emission | 14 |
| | ANNEX A: EUT parameters | 15 |
| | ANNEX B: Detailed Test Results | 16 |
| | B.1. Measurement Method | 16 |
| | B.2. Peak Output Power | 17 |
| | B.3. Frequency Band Edges - Conducted | 18 |
| | B.4. Frequency Band Edges –Radiated | 20 |
| | B.5. Transmitter Spurious Emission - Conducted | 23 |
| | B.6. Transmitter Spurious Emission - Radiated | 32 |
| | B.7. 6dB Bandwidth | 37 |
| | B.8. Maximum Power Spectral Density Level | 40 |



B.9. AC Powerline Conducted Emission 43
ANNEX C: Accreditation Certificate 47



1. Test Laboratory

1.1. Introduction & Accreditation

Telecommunication Technology Labs, CAICT is an ISO/IEC 17025:2017 accredited test laboratory under NATIONAL VOLUNTARY LABORATORY ACCREDITATION PROGRAM (NVLAP) with lab code 600118-0, and is also an FCC accredited test laboratory (CN5017), and ISED accredited test laboratory (ISED#: 24849). The detail accreditation scope can be found on NVLAP website.

1.2. Testing Location

Conducted testing Location: CTTL(huayuan North Road)

Address: No. 52, Huayuan North Road, Haidian District, Beijing,
100191, P. R. China

Radiated testing Location: CTTL(huayuan North Road)

Address: No. 52, Huayuan North Road, Haidian District, Beijing,
100191, P. R. China

1.3. Testing Environment

Normal Temperature: 20-27°C
Relative Humidity: 20-50%

1.4. Project data

Testing Start Date: 2022-4-11
Testing End Date: 2022-6-23

1.5. Signature

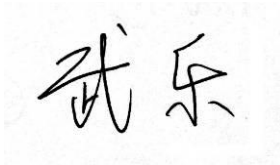

Wu Le
(Prepared this test report)



Sun Zhenyu
(Reviewed this test report)



Hu Xiaoyu
(Approved this test report)



2. Client Information

2.1. Applicant Information

Company Name: Wingtech Group (Hong Kong) Limited
Address /Post: Flat/RM 1802 18/F, Podium Plaza, 5 Hanoi Road, Tsim Sha Tsui, KL,
HK
City: Hong Kong
Postal Code: /
Country: China
Telephone: +86-21-53529900
Fax: /

2.2. Manufacturer Information

Company Name: Wingtech Group (Hong Kong) Limited
Address /Post: Flat/RM 1802 18/F, Podium Plaza, 5 Hanoi Road, Tsim Sha Tsui, KL,
HK
City: Hong Kong
Postal Code: /
Country: China
Telephone: +86-21-53529900
Fax: /

3. Equipment Under Test (EUT) and Ancillary Equipment (AE)

3.1. About EUT

| | |
|-----------------------------|-----------------------------|
| Description | 4G Mobile phone |
| Model Name | WTCKT01 |
| FCC ID | 2APXW-WTCKT01 |
| Frequency Band | ISM 2400MHz~2483.5MHz |
| Type of Modulation(LE mode) | GFSK (Bluetooth Low Energy) |
| Number of Channels(LE mode) | 40 |
| Power Supply | 3.85V DC by Battery |
| Antenna gain | 0.61dBi |

3.2. Internal Identification of EUT

| EUT ID* | SN or IMEI | HW Version | SW Version | Date of receipt |
|---------|-----------------|------------|-----------------|-----------------|
| EUT1 | 861024060013909 | V1.1 | WTCKT01_0.01.12 | 2022-4-11 |
| EUT2 | 861024060010400 | V1.1 | WTCKT01_0.01.12 | 2022-4-11 |

*EUT ID: is used to identify the test sample in the lab internally.

3.3. Internal Identification of AE

| AE ID* | Description | | |
|--------|-------------|---|---|
| AE1 | Battery | / | / |
| AE2 | Charger | / | |
| AE3 | USB Cable | / | |

AE1

| | |
|-----------------|---|
| Model | JU001 |
| Manufacturer | Jiade Energy Technology (Zhuhai) Co.,Ltd. |
| Capacity | 4000mAh |
| Nominal Voltage | 3.85V |

AE2

| | |
|-----------------|--------------------------------------|
| Model | TPA-46B050100UU |
| Manufacturer | SHENZHEN TIANYIN ELECTRONICS CO.,LTD |
| Length of cable | / |

AE3

| | |
|-----------------|------------------------------------|
| Model | USB TYPE A to C 2.0 Cable |
| Manufacturer | Huizhou Washin Electronics Co.,Ltd |
| Length of cable | / |

*AE ID: is used to identify the test sample in the lab internally.

3.4. Normal Accessory setting

Fully charged battery is used during the test.



3.5. General Description

The Equipment Under Test (EUT) is a model of 4G Mobile phone with integrated antenna. It consists of normal options: lithium battery, charger. Manual and specifications of the EUT were provided to fulfill the test. Samples undergoing test were selected by the Client.

4. Reference Documents

4.1. Documents supplied by applicant

EUT parameters, referring to Annex A for detailed information, is supplied by the client or manufacturer, which is the basis of testing.

4.2. Reference Documents for testing

The following documents listed in this section are referred for testing.

| Reference | Title | Version |
|-------------|--|-----------|
| FCC Part15 | FCC CFR 47, Part 15, Subpart C: 15.205 Restricted bands of operation; 15.209 Radiated emission limits, general requirements; 15.247 Operation within the bands 902–928MHz, 2400–2483.5 MHz, and 5725–5850 MHz. | 2019 |
| ANSI C63.10 | American National Standard of Procedures for Compliance Testing of Unlicensed Wireless Devices | June,2013 |

5. Test Results

5.1. Summary of EUT Mode

Two modes are provided:

| Mode | Conditions |
|--------|------------|
| Mode A | 1Mbps |
| Mode B | 2Mbps |

*For the test results, the EUT had been tested all conditions. But only the worst case (Mode A) was shown in test report except the " Peak Output Power " test was shown all conditions.

5.2. Summary of Test Results

Abbreviations used in this clause:

- P** Pass, The EUT complies with the essential requirements in the standard.
- F** Fail, The EUT does not comply with the essential requirements in the standard
- NA** Not Applicable, The test was not applicable
- NP** Not Performed, The test was not performed by CTTL

| SUMMARY OF MEASUREMENT RESULTS | Sub-clause | Verdict |
|---|------------------------|----------|
| Peak Output Power | 15.247 (b)(1) | P |
| Frequency Band Edges- Conducted | 15.247 (d) | P |
| Frequency Band Edges- Radiated | 15.247, 15.205, 15.209 | P |
| Transmitter Spurious Emission - Conducted | 15.247 (d) | P |
| Transmitter Spurious Emission - Radiated | 15.247, 15.205, 15.209 | P |
| 6dB Bandwidth | 15.247 (a)(2) | P |
| Maximum Power Spectral Density Level | 15.247(e) | P |
| AC Powerline Conducted Emission | 15.107, 15.207 | P |

Please refer to **ANNEX A** for detail.

The measurement is made according to ANSI C63.10.

5.3. Statements

CTTL has evaluated the test cases requested by the applicant /manufacturer as listed in section 5.1 of this report for the EUT specified in section 3 according to the standards or reference documents listed in section 4.2

6. Test Facilities Utilized

Conducted test system

| No. | Equipment | Model | Serial Number | Manufacturer | Calibration Period | Calibration Due date |
|-----|------------------------|--------|---------------|--------------|--------------------|----------------------|
| 1 | Vector Signal Analyzer | FSQ26 | 100024 | R&S | 1 year | 2023-03-23 |
| 2 | Test Receiver | ESCI | 100344 | R&S | 1 year | 2023-03-21 |
| 3 | LISN | ENV216 | 101200 | R&S | 1 year | 2022-06-29 |
| 4 | Shielding Room | S81 | / | ETS-Lindgren | / | / |

Radiated emission test system

| No. | Equipment | Model | Serial Number | Manufacturer | Calibration Period | Calibration Due date |
|-----|---------------|-----------|---------------|--------------|--------------------|----------------------|
| 1 | Test Receiver | ESW44 | 103023 | R&S | 1 year | 2022-10-28 |
| 2 | EMI Antenna | VULB 9163 | 302 | SCHWARZBECK | 1 year | 2022-12-28 |
| 3 | EMI Antenna | 3115 | 00167250 | ETS-Lindgren | 1 year | 2022-07-01 |

7. Measurement Uncertainty

7.1. Peak Output Power - Conducted

Measurement Uncertainty:

| | |
|-------------------------------|--------|
| Measurement Uncertainty (k=2) | 0.66dB |
|-------------------------------|--------|

7.2. Frequency Band Edges - Conducted

Measurement Uncertainty:

| | |
|-------------------------------|--------|
| Measurement Uncertainty (k=2) | 0.66dB |
|-------------------------------|--------|

7.3. Frequency Band Edges - Radiated

Measurement Uncertainty:

| | |
|-------------------------------|---|
| Measurement Uncertainty (k=2) | / |
|-------------------------------|---|

7.4. Transmitter Spurious Emission - Conducted

Measurement Uncertainty:

| Frequency Range | Uncertainty (k=2) |
|-------------------|-------------------|
| 30 MHz ~ 8 GHz | 1.22dB |
| 8 GHz ~ 12.75 GHz | 1.51dB |
| 12.7GHz ~ 26 GHz | 1.51dB |

7.5. Transmitter Spurious Emission - Radiated

Measurement Uncertainty:

| Frequency Range | Uncertainty(dBm) (k=2) |
|---|------------------------|
| 9kHz-30MHz | / |
| $30\text{MHz} \leq f \leq 1\text{GHz}$ | 5.15 |
| $1\text{GHz} \leq f \leq 18\text{GHz}$ | 5.54 |
| $18\text{GHz} \leq f \leq 40\text{GHz}$ | 5.26 |

7.6. 6dB Bandwidth

Measurement Uncertainty:

| | |
|-------------------------------|----------|
| Measurement Uncertainty (k=2) | 61.936Hz |
|-------------------------------|----------|

7.7. Maximum Power Spectral Density Level

Measurement Uncertainty:

| | |
|-------------------------------|--------|
| Measurement Uncertainty (k=2) | 0.66dB |
|-------------------------------|--------|

7.8. AC Powerline Conducted Emission

Measurement Uncertainty:

| | |
|-------------------------------|--------|
| Measurement Uncertainty (k=2) | 3.08dB |
|-------------------------------|--------|



ANNEX A: EUT parameters

Disclaimer: The antenna gain provided by the client may affect the validity of the measurement results in this report, and the client shall bear the impact and consequences arising therefrom.

ANNEX B: Detailed Test Results

B.1. Measurement Method

B.1.1. Conducted Measurements

The measurement is made according to ANSI C63.10.

- 1). Connect the EUT to the test system correctly.
- 2). Set the EUT to the required work mode (Transmitter, receiver or transmitter & receiver).
- 3). Set the EUT to the required channel.
- 4). Set the EUT hopping mode (hopping or hopping off).
- 5). Set the spectrum analyzer to start measurement.
- 6). Record the values. Vector Signal Analyzer

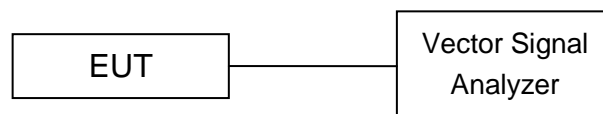

B.1.2. Radiated Emission Measurements

The measurement is made according to ANSI C63.10.

The radiated emission test is performed in semi-anechoic chamber. The distance from the EUT to the reference point of measurement antenna is 3m. The test is carried out on both vertical and horizontal polarization and only maximization result of both polarizations is kept. During the test, the turntable is rotated 360° and the measurement antenna is moved from 1m to 4m to get the maximization result.

In the case of radiated emission, the used settings are as follows,

Sweep frequency from 30 MHz to 1GHz, RBW = 100 kHz, VBW = 300 kHz;

Sweep frequency from 1 GHz to 26GHz, RBW = 1MHz, VBW = 3MHz;

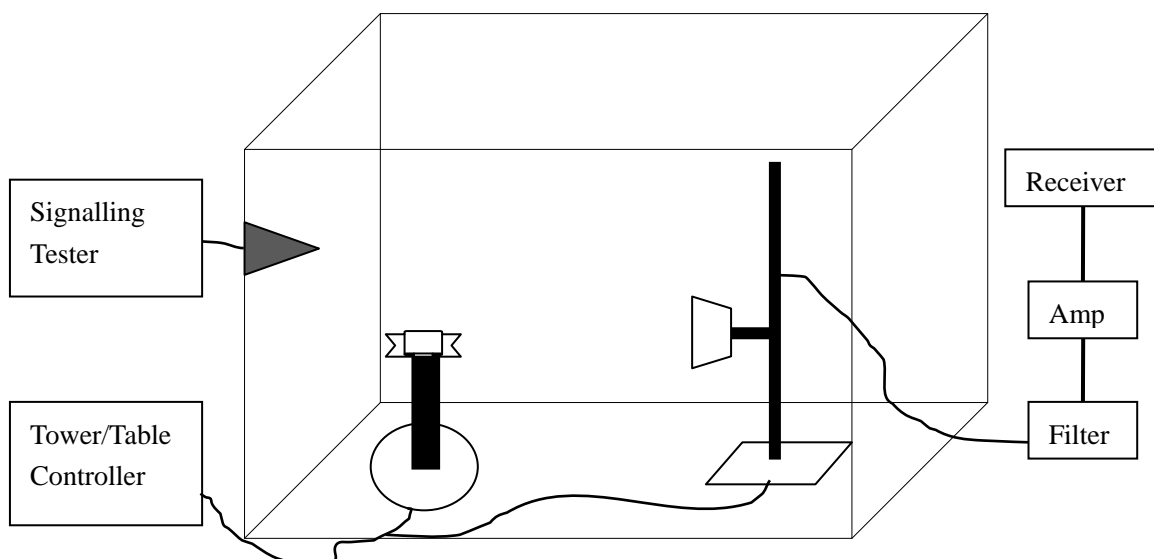

B.2. Peak Output Power

B.2.1. Peak Output Power - Conducted

Method of Measurement: See ANSI C63.10-clause 11.9.1.1

- a) Set the RBW = 3 MHz.
- b) Set VBW = 10 MHz.
- c) Set span = 10 MHz.
- d) Sweep time = auto couple.
- e) Detector = peak.
- f) Trace mode = max hold.
- g) Allow trace to fully stabilize.
- h) Use peak marker function to determine the peak amplitude level.

Measurement Limit:

| Standard | Limit (dBm) |
|-----------------------|-------------|
| FCC Part 15.247(b)(3) | < 30 |

Measurement Results:

For GFSK

| Sample Rate | Channel No. | Frequency (MHz) | Peak Conducted Output Power (dBm) | Conclusion |
|-------------|-------------|-----------------|-----------------------------------|------------|
| 1Mbps | 0 | 2402 | -4.67 | P |
| | 19 | 2440 | -4.36 | P |
| | 39 | 2480 | -3.88 | P |
| 2Mbps | 0 | 2402 | -4.70 | P |
| | 19 | 2440 | -4.48 | P |
| | 39 | 2480 | -3.70 | P |

Conclusion: PASS

B.2.2. E.I.R.P.

The radiated E.I.R.P. is listed below:

Antenna gain = 0.61dBi

For GFSK

| Sample Rate | Channel No. | Frequency (MHz) | E.I.R.P. (dBm) | Conclusion |
|-------------|-------------|-----------------|----------------|------------|
| 1Mbps | 0 | 2402 | -4.06 | P |
| | 19 | 2440 | -3.75 | P |
| | 39 | 2480 | -3.27 | P |
| 2Mbps | 0 | 2402 | -4.09 | P |
| | 19 | 2440 | -3.87 | P |
| | 39 | 2480 | -3.09 | P |

Note: E.I.R.P. are calculated with the antenna gain.

Conclusion: PASS

B.3. Frequency Band Edges - Conducted

Method of Measurement: See ANSI C63.10-clause 6.10.4

Connect the spectrum analyzer to the EUT using an appropriate RF cable connected to the EUT output. Configure the spectrum analyzer settings as described below.

- a) Set Span = 8MHz
- b) Sweep Time: Auto
- c) Set the RBW= 100 kHz
- c) Set the VBW= 300 kHz
- d) Detector: Peak
- e) Trace: Max hold

Observe the stored trace and measure the amplitude delta between the peak of the fundamental and the peak of the band-edge emission. This is not an absolute field strength measurement; it is only a relative measurement to determine the amount by which the emission drops at the band edge relative to the highest fundamental emission level.

Measurement Limit:

| Standard | Limit (dBc) |
|----------------------------|-------------|
| FCC 47 CFR Part 15.247 (d) | < -20 |

Measurement Result:

For GFSK

| Channel No. | Frequency (MHz) | Hopping | Band Edge Power (dBc) | | Conclusion |
|-------------|-----------------|-------------|------------------------|--------|------------|
| 0 | 2402 | Hopping OFF | Fig.1 | -50.80 | P |
| 39 | 2480 | Hopping OFF | Fig.2 | -51.10 | P |

Conclusion: PASS

Test graphs as below

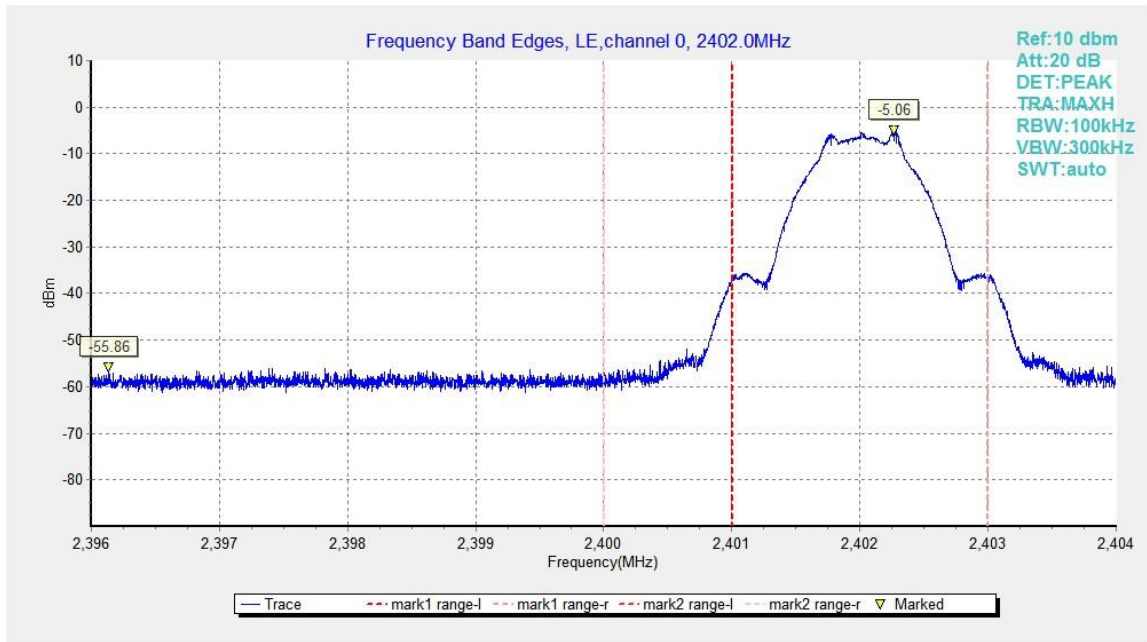

Fig.1. Frequency Band Edges: GFSK, 2402 MHz, Hopping Off

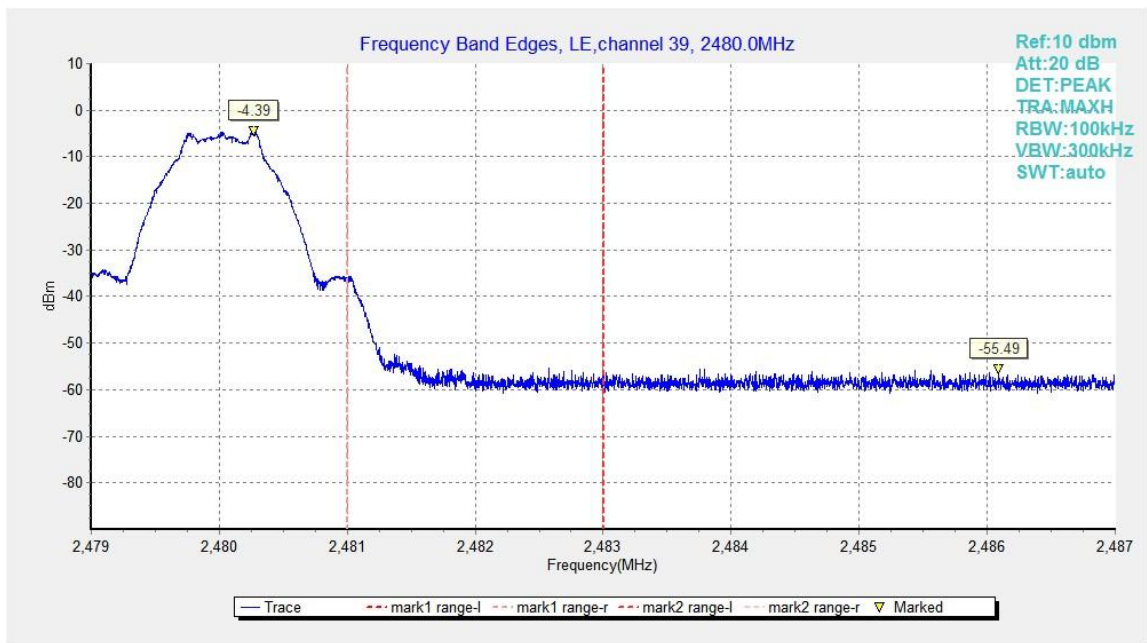

Fig.2. Frequency Band Edges: GFSK, 2480 MHz, Hopping Off

B.4. Frequency Band Edges –Radiated

Method of Measurement: See ANSI C63.10-2013-clause 6.4 &6.5 & 6.6

Measurement Limit:

| Standard | Limit |
|--|------------------------------|
| FCC 47 CFR Part 15.247, 15.205, 15.209 | 20dB below peak output power |

radiated emissions which fall in the restricted bands, as defined in § 15.205(a), must also comply with the radiated emission limits specified in § 15.209(a) (see § 15.205(c)).

Limit in restricted band:

| Frequency (MHz) | Field strength(μ V/m) | Measurement distance (m) |
|-----------------|----------------------------|--------------------------|
| 0.009 - 0.490 | 2400/F(kHz) | 300 |
| 0.490 - 1.705 | 24000/F(kHz) | 30 |
| 1.705 – 30.0 | 30 | 30 |

| Frequency of emission (MHz) | Field strength(uV/m) | Field strength(dBuV/m) |
|-----------------------------|----------------------|------------------------|
| 30-88 | 100 | 40 |
| 88-216 | 150 | 43.5 |
| 216-960 | 200 | 46 |
| Above 960 | 500 | 54 |

Set up:

Tabletop devices shall be placed on a nonconducting platform with nominal top surface dimensions 1 m by 1.5 m and the table height shall be 1.5 m.

The EUT and transmitting antenna shall be centered on the turntable.

Test Condition

The EUT shall be tested 1 near top, 1 near middle, and 1 near bottom. Set the unlicensed wireless device to operate in continuous transmit mode. For unlicensed wireless devices unable to be configured for 100% duty cycle even in test mode, configure the system for the maximum duty cycle supported.

When required for unlicensed wireless devices, measurements of the variation of the input power or the radiated signal level of the fundamental frequency component of the emission, as appropriate, shall be performed with the supply voltage varied between 85% and 115% of the nominal rated supply voltage.

Exploratory radiated emissions measurements

Exploratory radiated measurements shall be performed at the measurement distance or at a closer distance than that specified for compliance to determine the emission characteristics of the EUT and, if applicable, the EUT configuration that produces the maximum level of emissions. The frequencies of maximum emission may be determined by manually positioning the antenna close to the EUT, and then moving the antenna over all sides of the EUT while observing a spectral

display. It is advantageous to have prior knowledge of the frequencies of emissions, although this may be determined from such a near-field scan. The near-field scan shall only be used to determine the frequency but not the amplitude of the emissions. Where exploratory measurements are not adequate to determine the worst-case operating modes and are used only to identify the frequencies of the highest emissions, additional preliminary tests can be required.

For emissions from the EUT, the maximum level shall be determined by rotating the EUT and its antenna through 0° to 360°. For each mode of operation required to be tested, the frequency spectrum (based on findings from exploratory measurements) shall be monitored.

Broadband antennas and a spectrum analyzer or a radio-noise meter with a panoramic display are often useful in this type of test. If either antenna height or EUT azimuth are not fully measured during exploratory testing, then complete testing can be required at the OATS or semi-anechoic chamber when the final full spectrum testing is performed.

Final radiated emissions measurements

The final measurements are using the orientation and equipment arrangement of the EUT based on the measurement results found during the preliminary (exploratory) measurements, the EUT arrangement, appropriate modulation, and modes of operation that produce the emissions that have the highest amplitude relative to the limit shall be selected for the final measurement.

For emissions from the EUT, the maximum level shall be determined by rotating the EUT and its antenna through 0° to 360°. Final measurements for the EUT require a measurement antenna height scan of 1 m to 4 m and the antenna rotated to repeat the measurements for both the horizontal and vertical antenna polarizations. For each mode of operation required to be tested, the frequency spectrum (based on findings from exploratory measurements) shall be monitored.

For each mode selected, record the frequency and amplitude of the highest fundamental emission (if applicable), as well as the frequency and amplitude of the six highest spurious emissions relative to the limit. Emissions more than 20 dB below the limit do not need to be reported.

This maximization process was repeated with the EUT positioned in each of its three orthogonal orientations.

The receiver references:

| Frequency of emission (MHz) | RBW/VBW | Sweep Time(s) |
|-----------------------------|---------------|---------------|
| 30-1000 | 100kHz/300kHz | 5 |
| 1000-4000 | 1MHz/3MHz | 15 |
| 4000-18000 | 1MHz/3MHz | 40 |
| 18000-26500 | 1MHz/3MHz | 20 |

EUT ID: EUT1

Measurement Results:

| Mode | Channel | Frequency Range | Test Results | Conclusion |
|------|---------|------------------|--------------|------------|
| GFSK | 0 | 2.31GHz ~2.43GHz | Fig.3 | P |
| | 39 | 2.45GHz ~2.5GHz | Fig.4 | P |

Conclusion: PASS

Test graphs as below

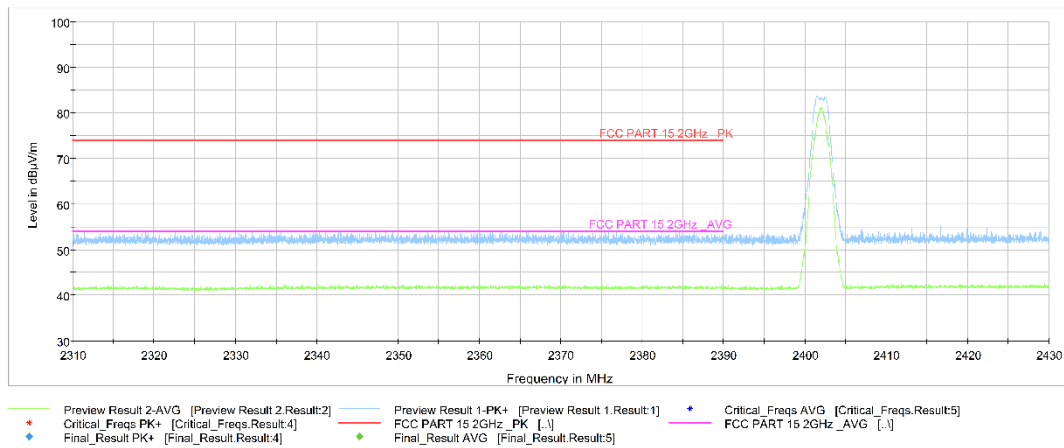

Fig.3. Frequency Band Edges: GFSK, 2402 MHz, Hopping Off, 2.31 GHz – 2.43GHz

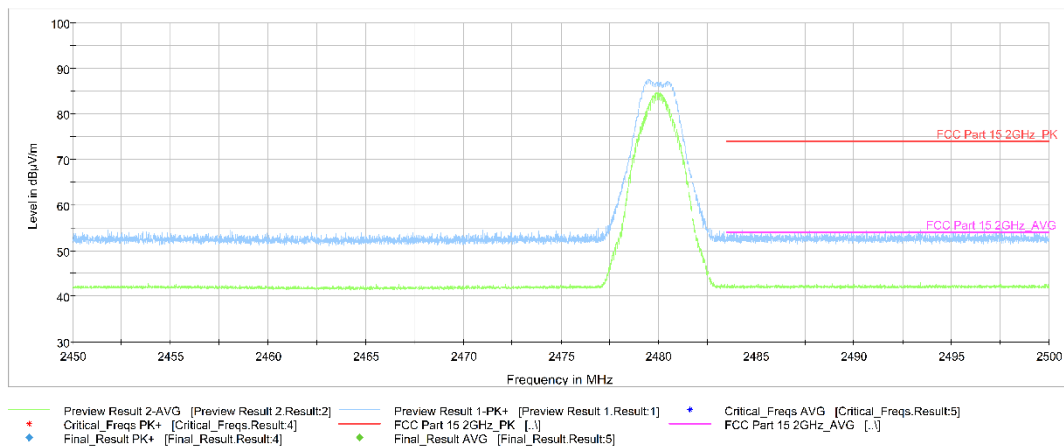

Fig.4. Frequency Band Edges: GFSK, 2480 MHz, Hopping Off, 2.45 GHz - 2.50GHz

B.5. Transmitter Spurious Emission - Conducted

Method of Measurement: See ANSI C63.10-clause 11.11.2 and clause 11.11.3

Measurement Procedure – Reference Level

1. Set the RBW = 100 kHz.
2. Set the VBW = 300 kHz.
3. Set the span to ≥ 1.5 times the DTS bandwidth.
4. Detector = peak.
5. Sweep time = auto couple.
6. Trace mode = max hold.
7. Allow trace to fully stabilize.
8. Use the peak marker function to determine the maximum PSD level. Next, determine the power in 100 kHz band segments outside of the authorized frequency band using the following measurement:

Measurement Procedure - Unwanted Emissions

1. Set RBW = 100 kHz.
 2. Set VBW = 300 kHz.
 3. Set span to encompass the spectrum to be examined.
 4. Detector = peak.
 5. Trace Mode = max hold.
 6. Sweep = auto couple.
 7. Allow the trace to stabilize (this may take some time, depending on the extent of the span).
- Ensure that the amplitude of all unwanted emissions outside of the authorized frequency band (excluding restricted frequency bands) is attenuated by at least the minimum requirements specified above.

Measurement Limit:

| Standard | Limit |
|----------------------------|---|
| FCC 47 CFR Part 15.247 (d) | 20dB below peak output power in 100 kHz bandwidth |

**Measurement Results:
For GFSK**

| Channel No. | Frequency (MHz) | Frequency Range | Test Results | Conclusion |
|-------------|-----------------|------------------|--------------|------------|
| 0 | 2402 | Center Frequency | Fig.5 | P |
| | | 30 MHz ~ 1 GHz | Fig.6 | P |
| | | 1 GHz ~ 3 GHz | Fig.7 | P |
| | | 3 GHz ~ 10 GHz | Fig.8 | P |
| | | 10GHz ~ 26 GHz | Fig.9 | P |
| 19 | 2440 | Center Frequency | Fig.10 | P |
| | | 30 MHz ~ 1 GHz | Fig.11 | P |
| | | 1 GHz ~ 3 GHz | Fig.12 | P |
| | | 3 GHz ~ 10 GHz | Fig.13 | P |
| | | 10GHz ~ 26 GHz | Fig.14 | P |
| 39 | 2480 | Center Frequency | Fig.15 | P |
| | | 30 MHz ~ 1 GHz | Fig.16 | P |
| | | 1 GHz ~ 3GHz | Fig.17 | P |
| | | 3 GHz ~ 10 GHz | Fig.18 | P |
| | | 10 GHz ~ 26 GHz | Fig.19 | P |

Conclusion: PASS

Test graphs as below

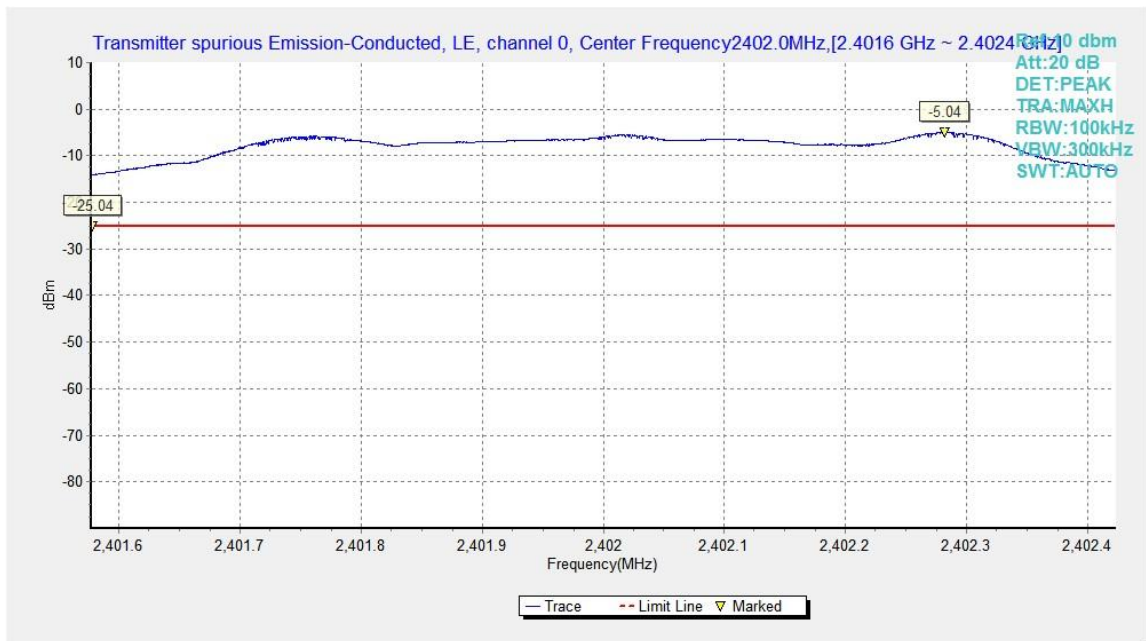

Fig.5. Transmitter Spurious Emission - Conducted: GFSK,2402MHz

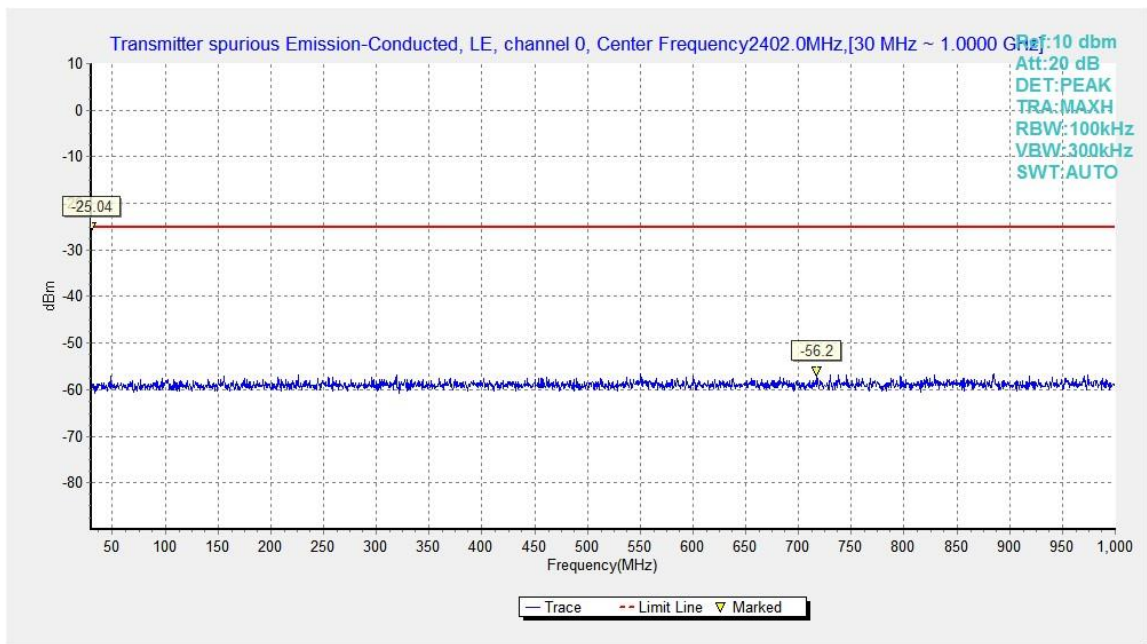

Fig.6. Transmitter Spurious Emission - Conducted: GFSK, 2402 MHz, 30MHz - 1GHz

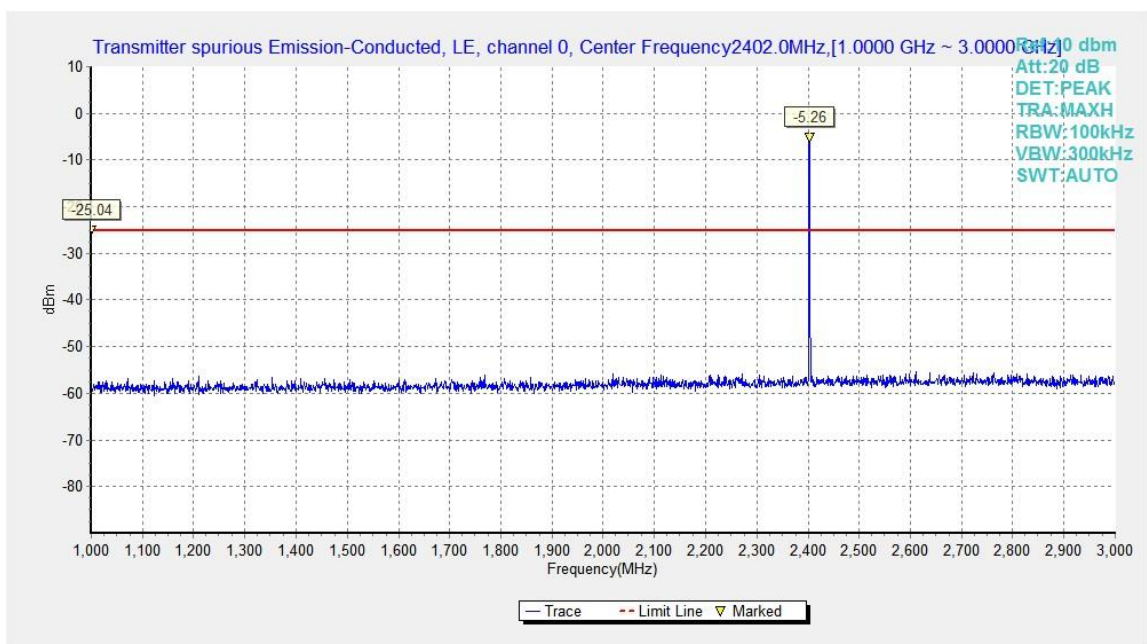

Fig.7. Transmitter Spurious Emission - Conducted: GFSK, 2402 MHz, 1GHz - 3GHz

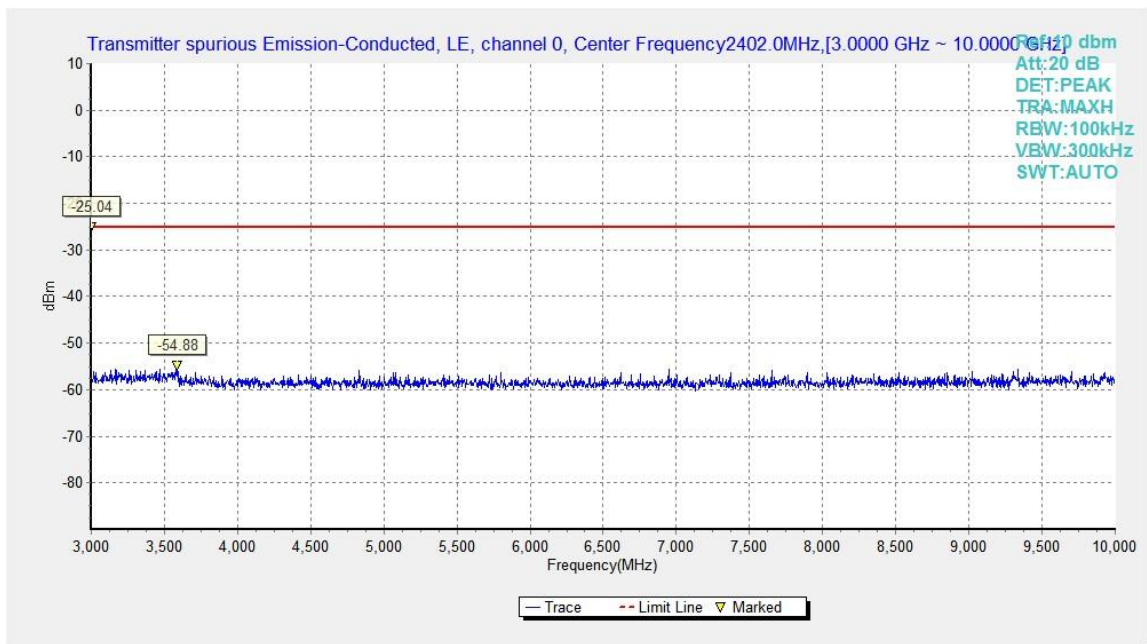

Fig.8. Transmitter Spurious Emission - Conducted: GFSK, 2402 MHz, 3GHz - 10GHz

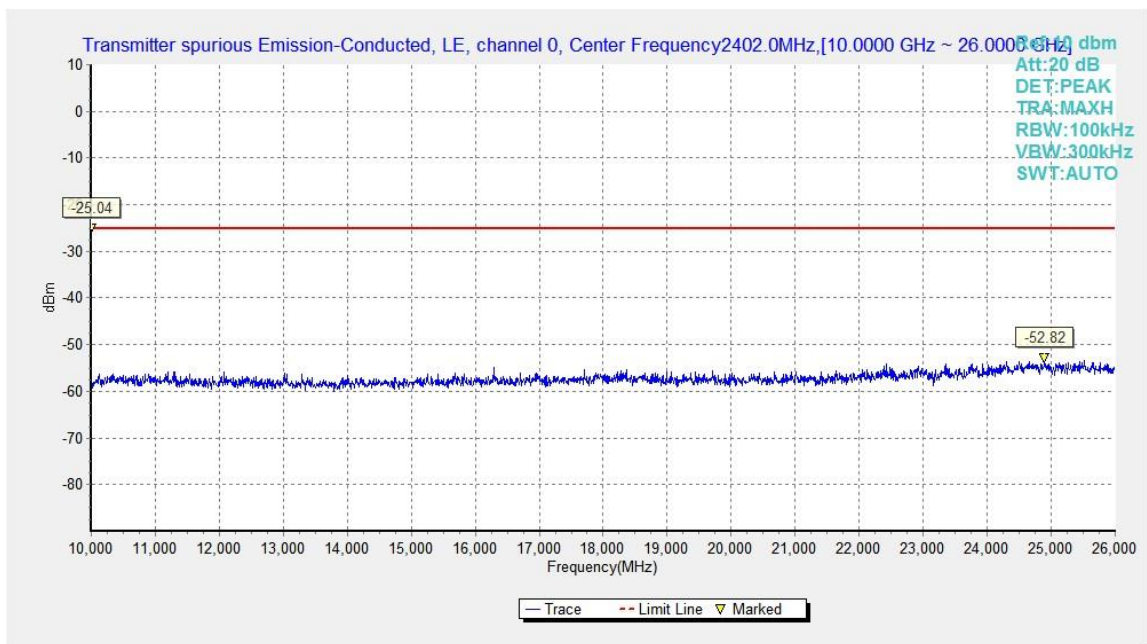

Fig.9. Transmitter Spurious Emission - Conducted: GFSK, 2402 MHz, 10GHz - 26GHz

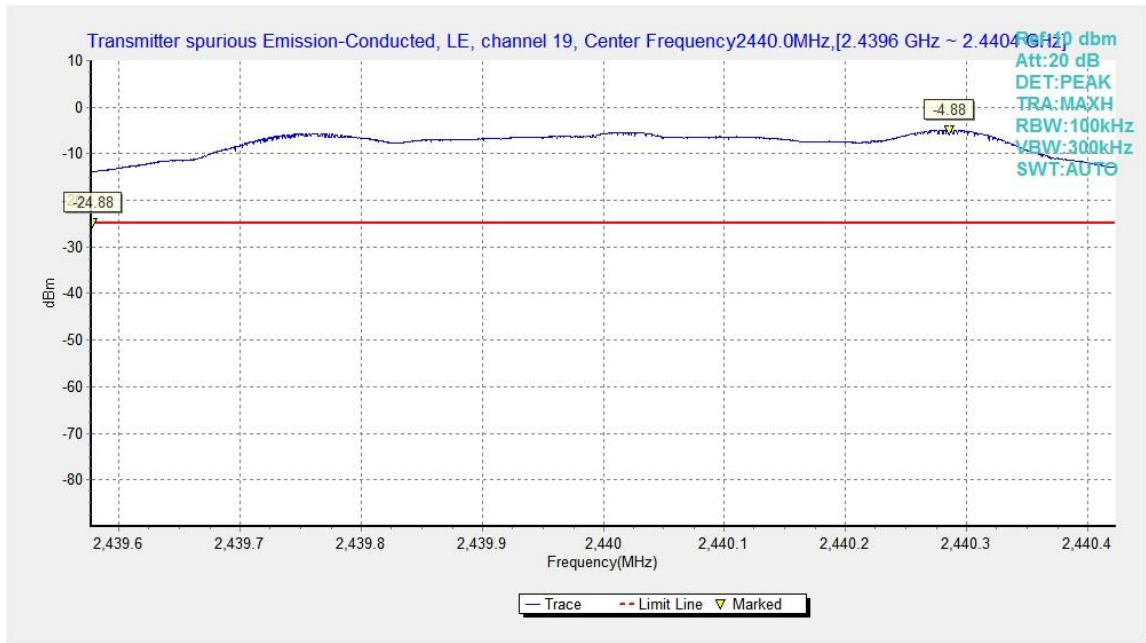

Fig.10. Transmitter Spurious Emission - Conducted: GFSK, 2440MHz

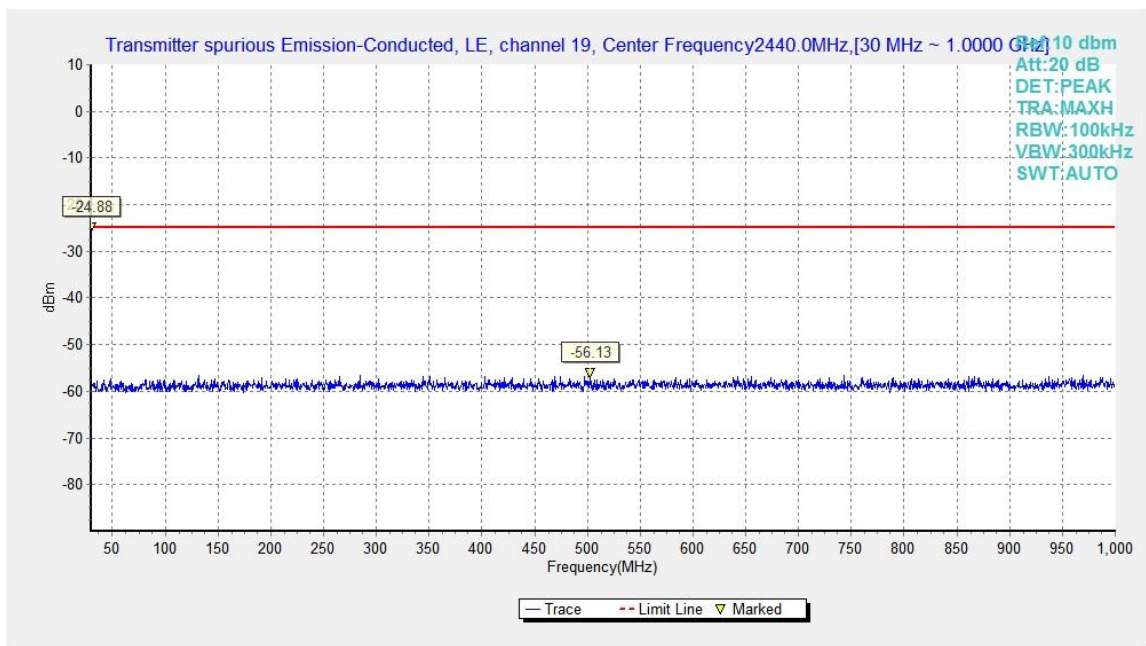

Fig.11. Transmitter Spurious Emission - Conducted: GFSK, 2440 MHz, 30MHz - 1GHz

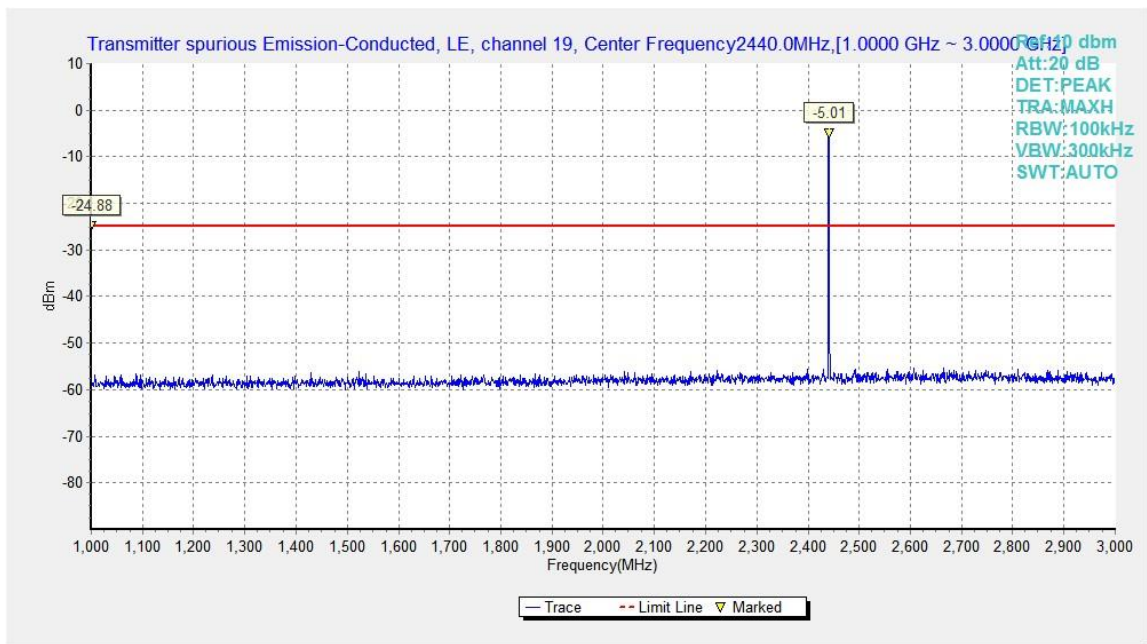

Fig.12. Transmitter Spurious Emission - Conducted: GFSK, 2440 MHz, 1GHz – 3GHz

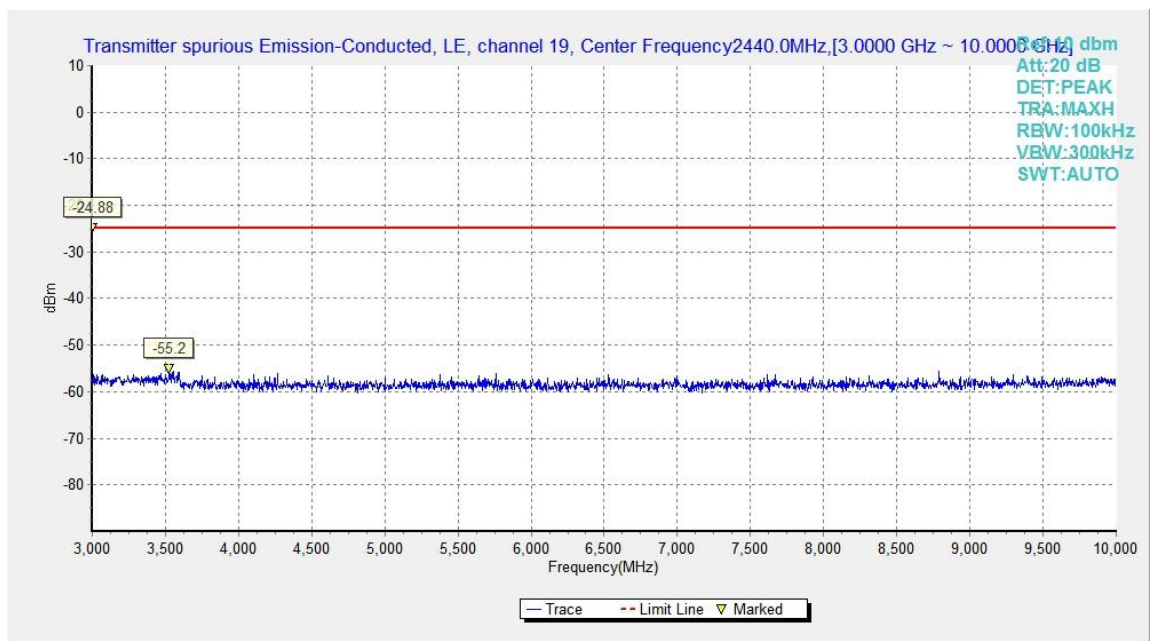

Fig.13. Transmitter Spurious Emission - Conducted: GFSK, 2440 MHz, 3GHz – 10GHz

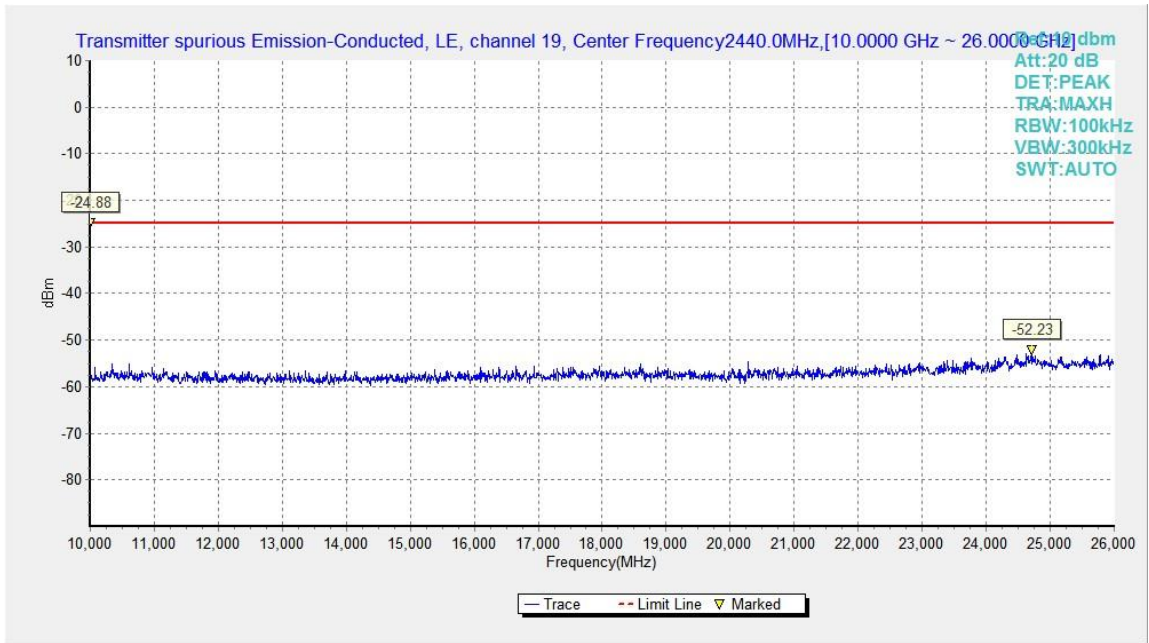

Fig.14. Transmitter Spurious Emission - Conducted: GFSK, 2440 MHz, 10GHz – 26GHz

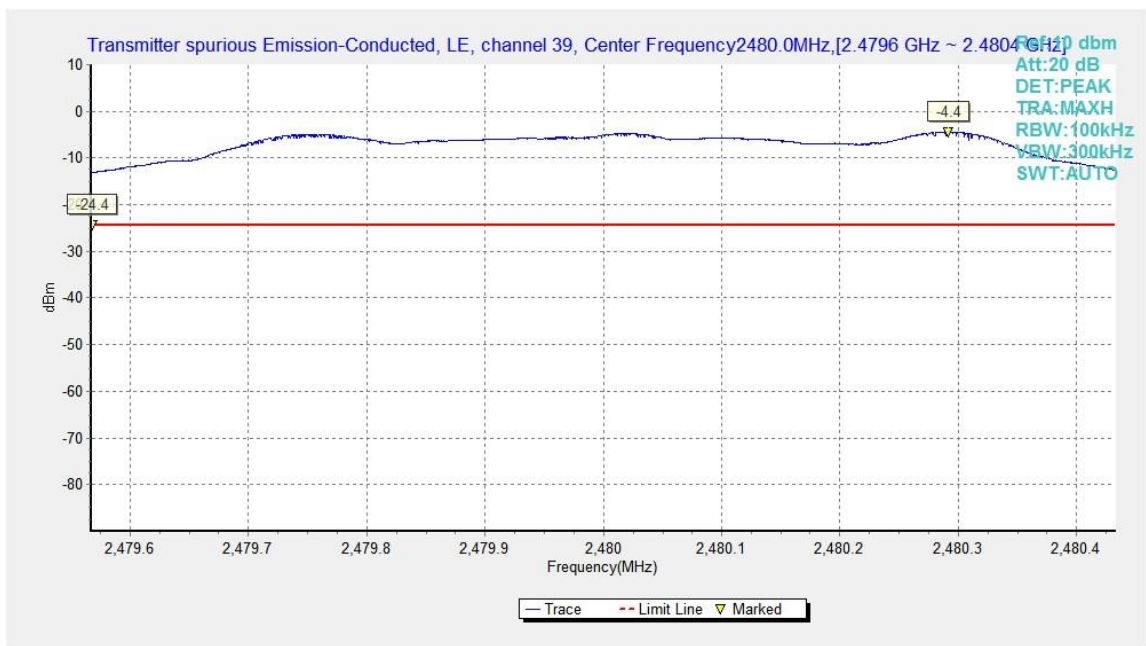

Fig.15. Transmitter Spurious Emission - Conducted: GFSK, 2480 MHz

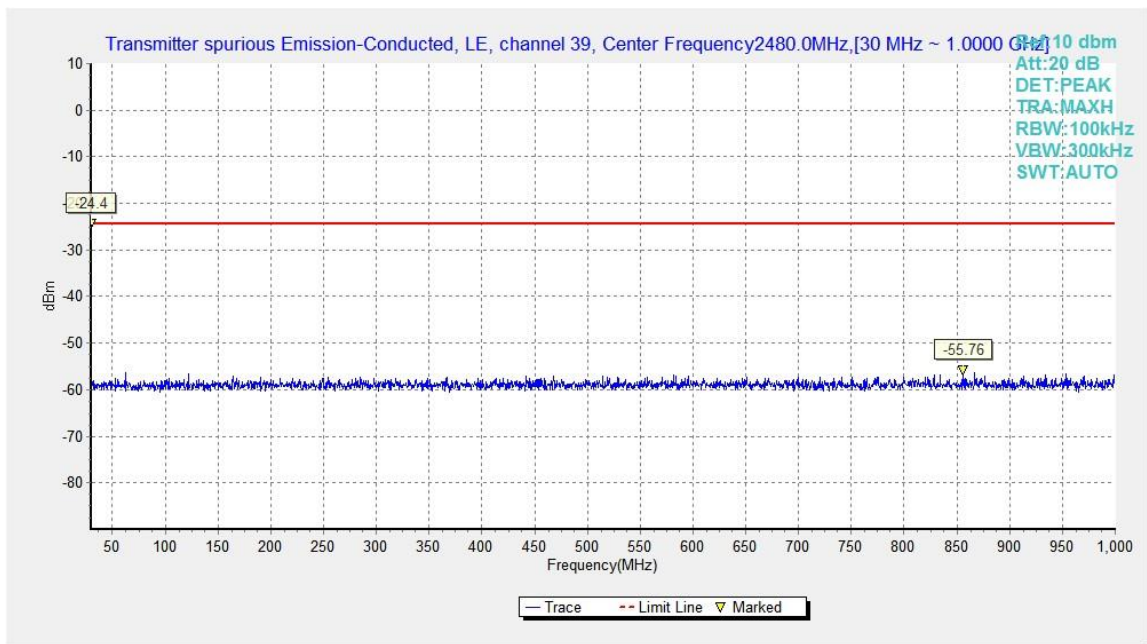

Fig.16. Transmitter Spurious Emission - Conducted: GFSK, 2480 MHz, 30MHz - 1GHz

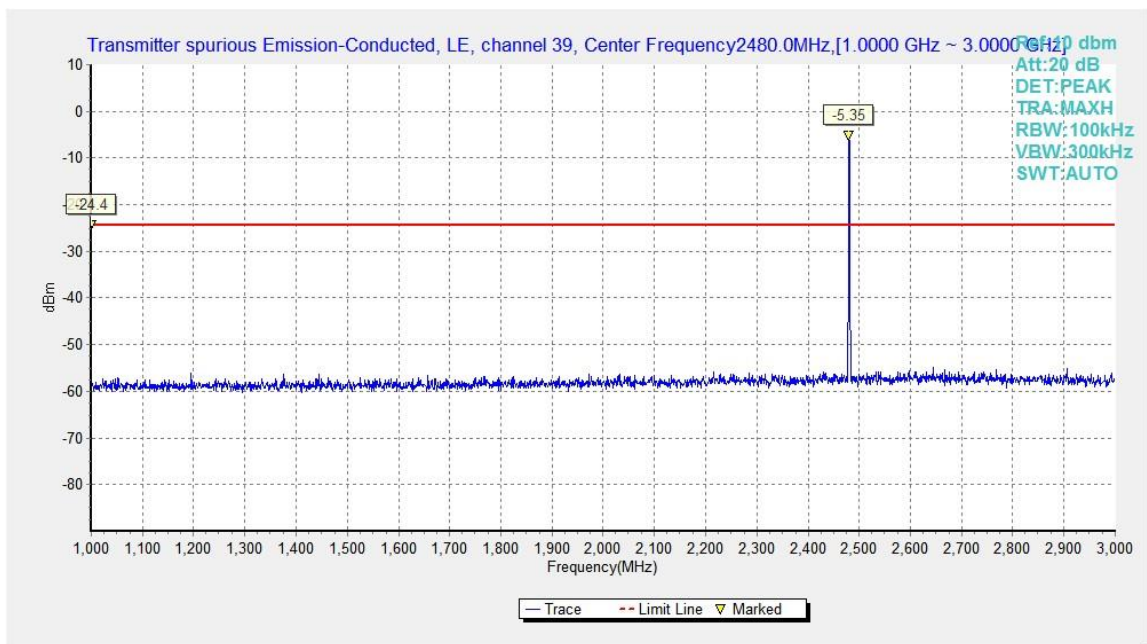

Fig.17. Transmitter Spurious Emission - Conducted: GFSK, 2480 MHz, 1GHz - 3GHz

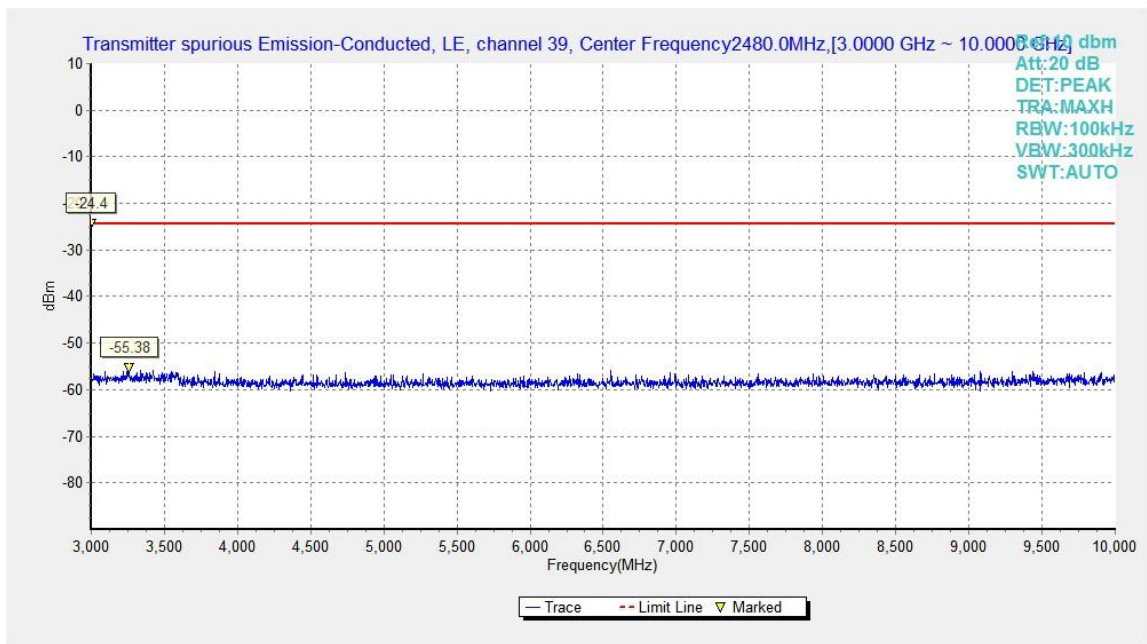

Fig.18. Transmitter Spurious Emission - Conducted: GFSK, 2480 MHz, 3GHz - 10GHz

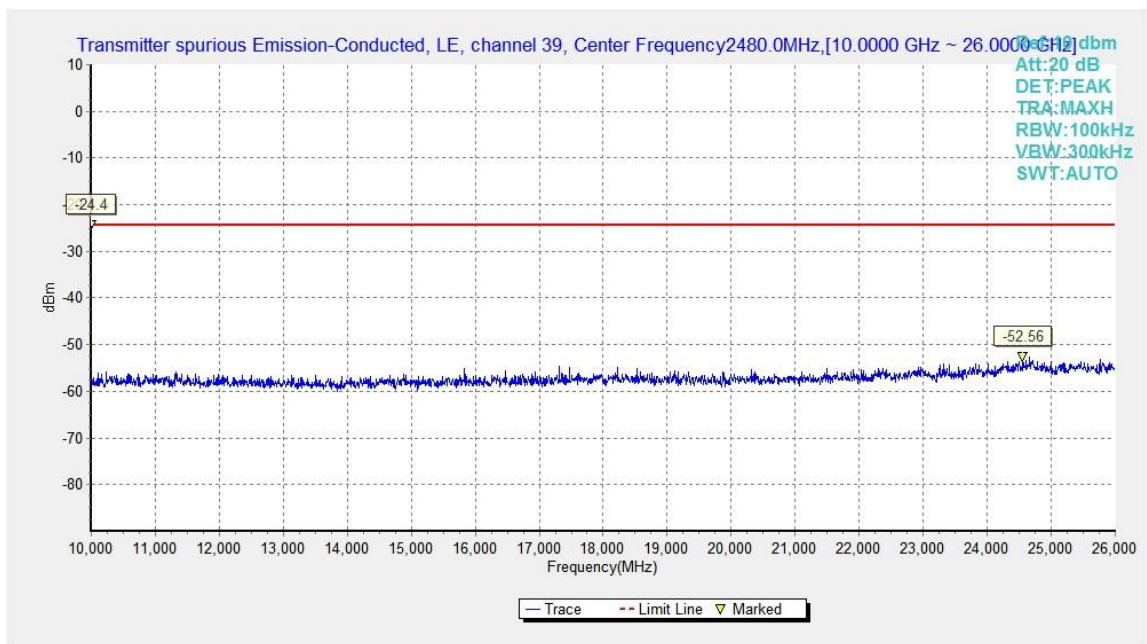

Fig.19. Transmitter Spurious Emission - Conducted: GFSK, 2480 MHz, 10GHz - 26GHz

B.6. Transmitter Spurious Emission - Radiated

Method of Measurement: See ANSI C63.10-2013-clause 6.4 & 6.5 & 6.6

Measurement Limit:

| Standard | Limit |
|--|------------------------------|
| FCC 47 CFR Part 15.247, 15.205, 15.209 | 20dB below peak output power |

radiated emissions which fall in the restricted bands, as defined in § 15.205(a), must also comply with the radiated emission limits specified in § 15.209(a) (see § 15.205(c)).

Limit in restricted band:

| Frequency (MHz) | Field strength($\mu\text{V}/\text{m}$) | Measurement distance (m) |
|-----------------|--|--------------------------|
| 0.009 - 0.490 | 2400/F(kHz) | 300 |
| 0.490 - 1.705 | 24000/F(kHz) | 30 |
| 1.705 – 30.0 | 30 | 30 |

| Frequency of emission (MHz) | Field strength($\mu\text{V}/\text{m}$) | Field strength(dBuV/m) |
|-----------------------------|--|------------------------|
| 30-88 | 100 | 40 |
| 88-216 | 150 | 43.5 |
| 216-960 | 200 | 46 |
| Above 960 | 500 | 54 |

Set up:

Tabletop devices shall be placed on a nonconducting platform with nominal top surface dimensions 1 m by 1.5 m. For emissions testing at or below 1 GHz, the table height shall be 80 cm above the reference ground plane. For emission measurements above 1 GHz, the table height shall be 1.5 m

The EUT and transmitting antenna shall be centered on the turntable.

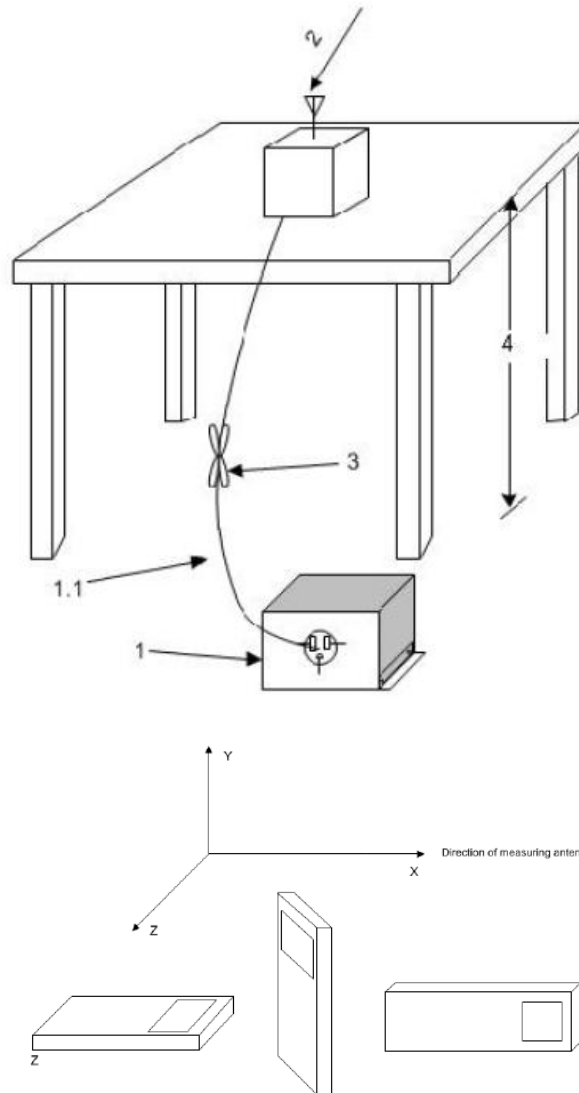

Test Condition

The EUT shall be tested 1 near top, 1 near middle, and 1 near bottom. Set the unlicensed wireless device to operate in continuous transmit mode. For unlicensed wireless devices unable to be configured for 100% duty cycle even in test mode, configure the system for the maximum duty cycle supported.

When required for unlicensed wireless devices, measurements of the variation of the input power or the radiated signal level of the fundamental frequency component of the emission, as appropriate, shall be performed with the supply voltage varied between 85% and 115% of the nominal rated supply voltage.

Exploratory radiated emissions measurements

Exploratory radiated measurements shall be performed at the measurement distance or at a closer distance than that specified for compliance to determine the emission characteristics of the EUT and, if applicable, the EUT configuration that produces the maximum level of emissions. The frequencies of maximum emission may be determined by manually positioning the antenna close to the EUT, and then moving the antenna over all sides of the EUT while observing a spectral display. It is advantageous to have prior knowledge of the frequencies of emissions, although this

may be determined from such a near-field scan. The near-field scan shall only be used to determine the frequency but not the amplitude of the emissions. Where exploratory measurements are not adequate to determine the worst-case operating modes and are used only to identify the frequencies of the highest emissions, additional preliminary tests can be required.

For emissions from the EUT, the maximum level shall be determined by rotating the EUT and its antenna through 0° to 360°. For each mode of operation required to be tested, the frequency spectrum (based on findings from exploratory measurements) shall be monitored.

Broadband antennas and a spectrum analyzer or a radio-noise meter with a panoramic display are often useful in this type of test. If either antenna height or EUT azimuth are not fully measured during exploratory testing, then complete testing can be required at the OATS or semi-anechoic chamber when the final full spectrum testing is performed.

Final radiated emissions measurements

The final measurements are using the orientation and equipment arrangement of the EUT based on the measurement results found during the preliminary (exploratory) measurements, the EUT arrangement, appropriate modulation, and modes of operation that produce the emissions that have the highest amplitude relative to the limit shall be selected for the final measurement.

For each mode of operation required to be tested, the frequency spectrum (based on findings from exploratory measurements) shall be monitored. The highest signal levels relative to the limit shall be determined by rotating the EUT from 0° to 360° and with varying the measurement antenna height between 1 m and 4 m in vertical and horizontal polarizations.

For each mode selected, record the frequency and amplitude of the highest fundamental emission (if applicable), as well as the frequency and amplitude of the six highest spurious emissions relative to the limit. Emissions more than 20 dB below the limit do not need to be reported.

This maximization process was repeated with the EUT positioned in each of its three orthogonal orientations.

The receiver references:

| Frequency of emission (MHz) | RBW/VBW | Sweep Time(s) |
|-----------------------------|---------------|---------------|
| 30-1000 | 100kHz/300kHz | 5 |
| 1000-4000 | 1MHz/3MHz | 15 |
| 4000-18000 | 1MHz/3MHz | 40 |
| 18000-26500 | 1MHz/3MHz | 20 |

P_{Mea} is the field strength recorded from the instrument.

The measurement results are obtained as described below:

Result= P_{Mea} + Cable Loss + Antenna Factor

Where:

P_{Mea} field strength recorded from the instrument

Average Measurement results

GFSK 2402MHz

| Frequency | Measurement | Cable | Antenna | Receiver | Limit | Margin | Antenna |
|-----------|-------------|-------|---------|----------|-------|--------|---------|
|-----------|-------------|-------|---------|----------|-------|--------|---------|

| (MHz) | Result (dBuV/m) | Loss (dB) | Factor (dB/m) | Reading (dBuV) | (dBuV/m) | (dB) | Pol. (H/V) |
|-----------|--------------------|--------------|------------------|-------------------|----------|-------|---------------|
| 17692.500 | 41.00 | -25.70 | 46.00 | 20.80 | 54.00 | 13.00 | V |
| 13610.000 | 39.07 | -29.50 | 40.40 | 28.17 | 54.00 | 14.93 | H |
| 12844.000 | 36.62 | -30.70 | 39.10 | 28.12 | 54.00 | 17.38 | V |
| 9120.000 | 34.22 | -33.80 | 38.10 | 30.02 | 54.00 | 19.78 | V |
| 7983.500 | 33.04 | -34.80 | 37.10 | 30.74 | 54.00 | 20.96 | V |
| 2350.700 | 42.36 | -20.10 | 28.00 | 34.46 | 54.00 | 11.64 | V |

GFSK 2440MHz

| Frequency (MHz) | Measurement Result (dBuV/m) | Cable Loss (dB) | Antenna Factor (dB/m) | Receiver Reading (dBuV) | Limit (dBuV/m) | Margin (dB) | Antenna Pol. (H/V) |
|--------------------|-----------------------------------|-----------------------|-----------------------------|-------------------------------|-------------------|----------------|--------------------------|
| 17774.500 | 41.10 | -25.50 | 46.70 | 19.90 | 54.00 | 12.90 | H |
| 13600.000 | 39.13 | -29.50 | 40.40 | 28.23 | 54.00 | 14.87 | V |
| 12852.500 | 36.71 | -30.70 | 39.10 | 28.21 | 54.00 | 17.29 | V |
| 9108.500 | 34.13 | -33.80 | 38.10 | 29.93 | 54.00 | 19.87 | H |
| 7234.500 | 33.20 | -35.50 | 36.40 | 32.30 | 54.00 | 20.80 | H |
| 4959.500 | 27.89 | -37.10 | 33.30 | 31.69 | 54.00 | 26.11 | H |

GFSK 2480MHz

| Frequency (MHz) | Measurement Result (dBuV/m) | Cable Loss (dB) | Antenna Factor (dB/m) | Receiver Reading (dBuV) | Limit (dBuV/m) | Margin (dB) | Antenna Pol. (H/V) |
|--------------------|-----------------------------------|-----------------------|-----------------------------|-------------------------------|-------------------|----------------|--------------------------|
| 17725.000 | 40.96 | -25.70 | 46.00 | 20.76 | 54.00 | 13.04 | H |
| 13591.000 | 38.91 | -29.50 | 40.40 | 28.01 | 54.00 | 15.09 | H |
| 12863.000 | 36.86 | -30.70 | 39.10 | 28.36 | 54.00 | 17.14 | V |
| 9318.500 | 34.39 | -33.90 | 38.00 | 30.29 | 54.00 | 19.61 | V |
| 7988.000 | 32.95 | -34.80 | 37.10 | 30.65 | 54.00 | 21.05 | V |
| 2497.500 | 42.83 | -20.00 | 28.30 | 34.53 | 54.00 | 11.17 | H |

Peak Measurement results
GFSK 2402MHz

| Frequency (MHz) | Measurement Result (dBuV/m) | Cable Loss (dB) | Antenna Factor (dB/m) | Receiver Reading (dBuV) | Limit (dBuV/m) | Margin (dB) | Antenna Pol. (H/V) |
|-----------------|-----------------------------|-----------------|-----------------------|-------------------------|----------------|-------------|--------------------|
| 17288.500 | 52.57 | -25.90 | 44.40 | 34.17 | 74.00 | 21.43 | H |
| 13607.500 | 50.30 | -29.50 | 40.40 | 39.40 | 74.00 | 23.70 | H |
| 12440.500 | 47.52 | -31.20 | 38.90 | 39.82 | 74.00 | 26.48 | H |
| 9240.500 | 45.16 | -33.70 | 38.00 | 40.86 | 74.00 | 28.84 | H |
| 7989.000 | 44.64 | -34.80 | 37.10 | 42.34 | 74.00 | 29.36 | V |
| 2384.200 | 54.48 | -20.00 | 28.10 | 46.48 | 74.00 | 19.52 | V |

GFSK 2440MHz

| Frequency (MHz) | Measurement Result (dBuV/m) | Cable Loss (dB) | Antenna Factor (dB/m) | Receiver Reading (dBuV) | Limit (dBuV/m) | Margin (dB) | Antenna Pol. (H/V) |
|-----------------|-----------------------------|-----------------|-----------------------|-------------------------|----------------|-------------|--------------------|
| 17992.000 | 52.21 | -25.50 | 46.70 | 31.01 | 74.00 | 21.79 | V |
| 14098.500 | 50.45 | -29.40 | 41.70 | 38.25 | 74.00 | 23.55 | V |
| 12853.000 | 48.30 | -30.70 | 39.10 | 39.80 | 74.00 | 25.70 | V |
| 9111.000 | 45.65 | -33.80 | 38.10 | 41.45 | 74.00 | 28.35 | V |
| 7230.000 | 44.64 | -35.50 | 36.40 | 43.74 | 74.00 | 29.36 | V |
| 4994.000 | 39.32 | -36.60 | 33.40 | 42.52 | 74.00 | 34.68 | V |

GFSK 2480MHz

| Frequency (MHz) | Measurement Result (dBuV/m) | Cable Loss (dB) | Antenna Factor (dB/m) | Receiver Reading (dBuV) | Limit (dBuV/m) | Margin (dB) | Antenna Pol. (H/V) |
|-----------------|-----------------------------|-----------------|-----------------------|-------------------------|----------------|-------------|--------------------|
| 17800.000 | 52.81 | -25.50 | 46.70 | 31.61 | 74.00 | 21.19 | V |
| 14268.500 | 50.31 | -28.40 | 42.30 | 36.41 | 74.00 | 23.69 | H |
| 12424.500 | 48.22 | -31.20 | 38.90 | 40.52 | 74.00 | 25.78 | V |
| 9641.500 | 45.65 | -33.10 | 38.00 | 40.75 | 74.00 | 28.35 | V |
| 7040.000 | 43.97 | -35.40 | 36.20 | 43.07 | 74.00 | 30.03 | H |
| 2496.700 | 54.63 | -20.00 | 28.30 | 46.33 | 74.00 | 19.37 | H |

Conclusion: PASS

B.7. 6dB Bandwidth

Method of Measurement:

The measurement is made according to ANSI C63.10 clause 11.8.1

1. Set RBW = 100 kHz.
2. Set the video bandwidth (VBW) = 300 kHz.
3. Detector = Peak.
4. Trace mode = max hold.
5. Sweep = auto couple.
6. Allow the trace to stabilize.
7. Measure the maximum width of the emission that is constrained by the frequencies associated with the two outermost amplitude points (upper and lower frequencies) that are attenuated by 6 dB relative to the maximum level measured in the fundamental emission.

Measurement Limit:

| Standard | Limit |
|------------------------------|----------------------|
| FCC 47 CFR Part 15.247(a)(2) | $\geq 500\text{kHz}$ |

Measurement Results:

For GFSK

| Channel No. | Frequency (MHz) | 6dB Bandwidth (kHz) | | Conclusion |
|-------------|-----------------|---------------------|--------|------------|
| 0 | 2402 | Fig.20 | 663.50 | P |
| 19 | 2440 | Fig.21 | 665.50 | P |
| 39 | 2480 | Fig.22 | 669.00 | P |

Conclusion: PASS

Test graphs as below:

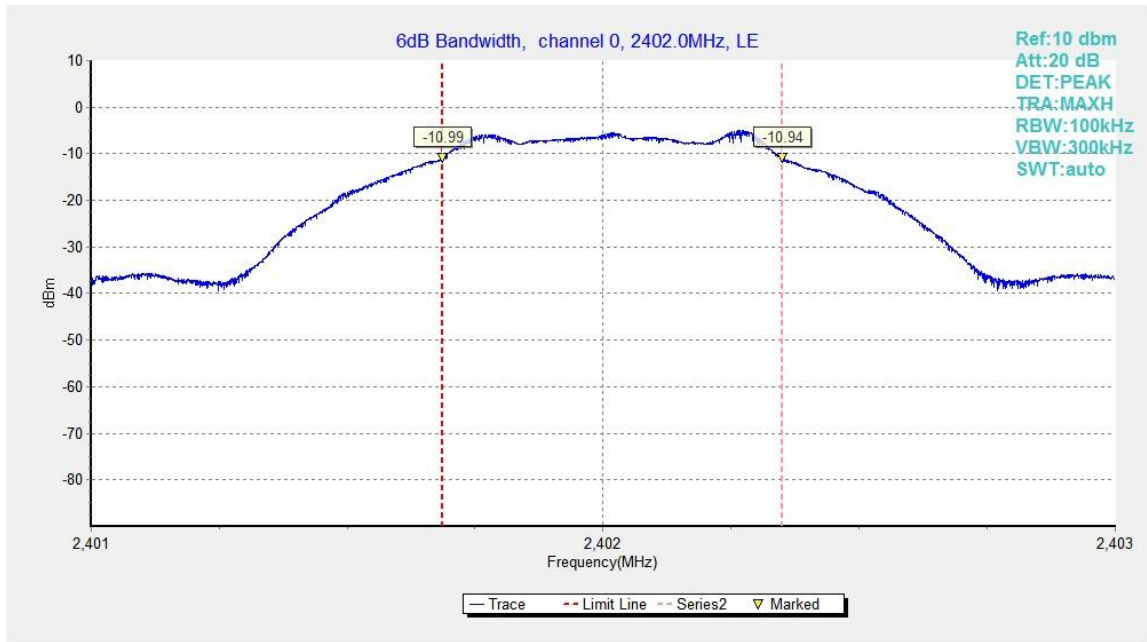

Fig.20. 6dB Bandwidth: GFSK, 2402 MHz

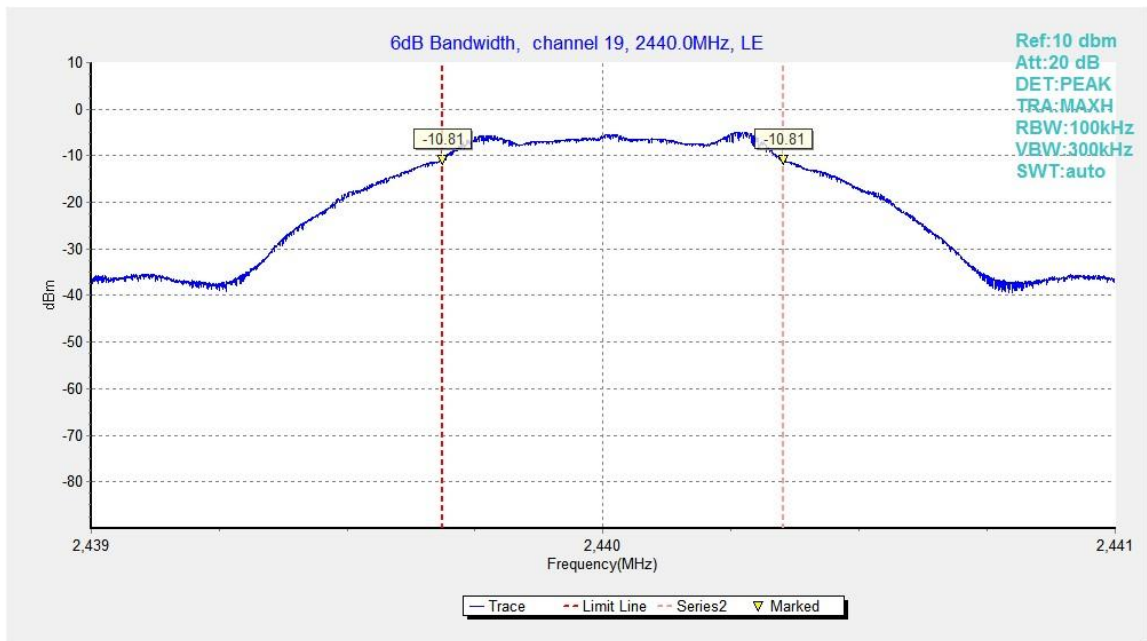

Fig.21. 6dB Bandwidth: GFSK, 2440 MHz

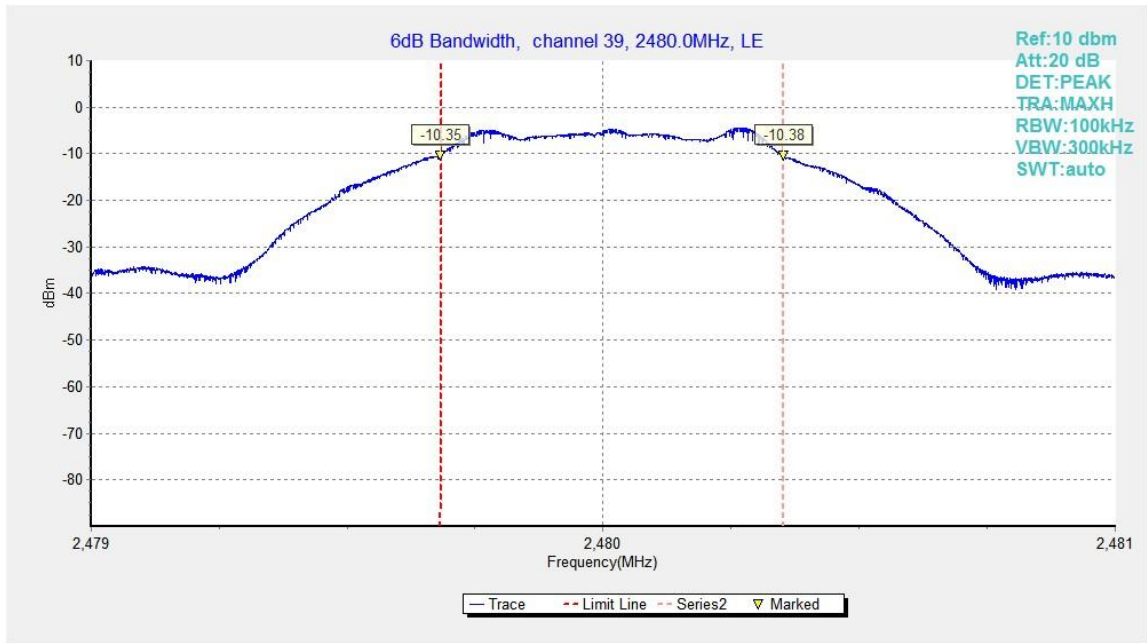

Fig.22. 6dB Bandwidth: GFSK, 2480 MHz

B.8. Maximum Power Spectral Density Level

Method of Measurement:

The measurement is made according to ANSI C63.10 clause 11.10.2

1. Set the RBW = 3 kHz.
2. Set the VBW = 10 kHz.
3. Set the span to 2 times the DTS bandwidth.
4. Detector = peak.
5. Sweep time = auto couple.
6. Trace mode = max hold.
7. Allow trace to fully stabilize.
8. Use the peak marker function to determine the maximum amplitude level within the RBW.

Measurement Limit:

| Standard | Limit |
|---------------------------|-----------------------------|
| FCC 47 CFR Part 15.247(e) | $\leq 8.0 \text{ dBm/3kHz}$ |

Measurement Results:

For GFSK

| Channel No. | Frequency (MHz) | Maximum Power Spectral Density Level(dBm/3kHz) | | Conclusion |
|-------------|-----------------|--|--------|------------|
| | | Fig.23 | Fig.24 | |
| 0 | 2402 | Fig.23 | -21.36 | P |
| 19 | 2440 | Fig.24 | -21.09 | P |
| 39 | 2480 | Fig.25 | -20.47 | P |

Test graphs as below:

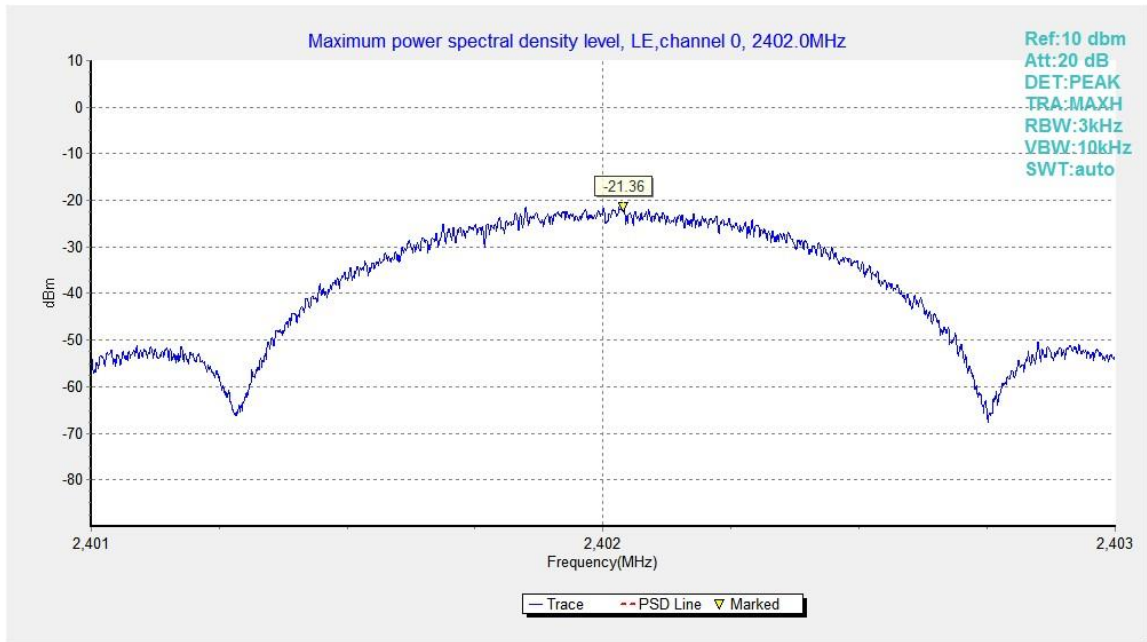

Fig.23. Maximum Power Spectral Density Level Function: GFSK, 2402 MHz

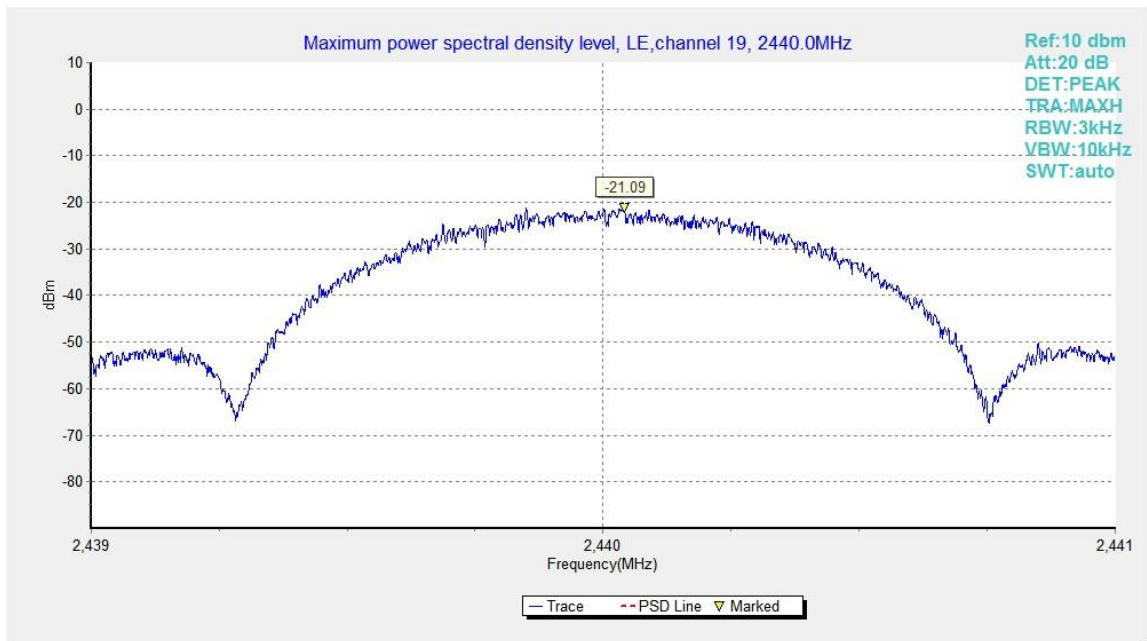

Fig.24. Maximum Power Spectral Density Level Function: GFSK, 2440 MHz

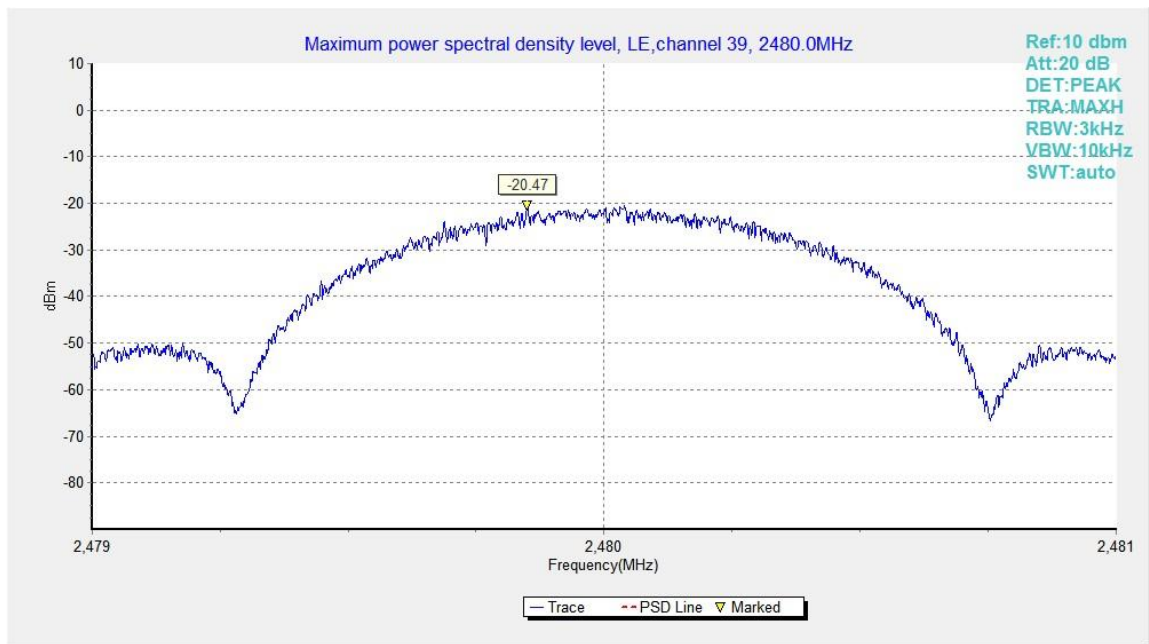

Fig.25. Maximum Power Spectral Density Level Function: GFSK, 2480 MHz

B.9. AC Powerline Conducted Emission

Method of Measurement: See ANSI C63.10-clause 6.2

Setup:

A stand-alone EUT shall be placed in the center along the back edge of the tabletop. For multiunit tabletop systems, the EUT shall be centered laterally (left to right facing the tabletop) on the tabletop and its rear shall be flush with the rear of the table.

Accessories that are part of an EUT system tested on a tabletop shall be placed in a test arrangement on one or both sides of the host with a 10 cm separation between the nearest points of the cabinets. The rear of the host and accessories shall be flush with the back of the supporting tabletop unless that would not be typical of normal use. If more than two accessories are present, then an equipment test arrangement shall be chosen that maintains 10 cm spacing between cabinets unless the equipment is normally located closer together.

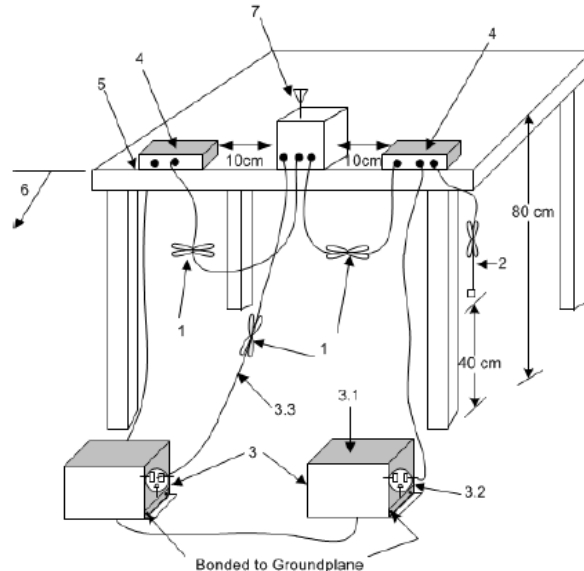

Exploratory ac power-line conducted emission measurements

Exploratory measurements shall be used to identify the frequency of the emission that has the highest amplitude relative to the limit by operating the EUT in a range of typical modes of operation, cable positions, and with a typical system equipment configuration and arrangement. For each mode of operation and for each ac power current-carrying conductor, cable manipulation shall be performed within the range of likely configurations. For this measurement or series of measurements, the frequency spectrum of interest shall be monitored looking for the emission that has the highest amplitude relative to the limit. Once that emission is found for each current-carrying conductor of each power cord associated with the EUT (but not the cords associated with non-EUT equipment in the overall system), the one configuration and arrangement and mode of operation that produces the emission closest to the limit over all of the measured conductors shall be recorded.

Final ac power-line conducted emission measurements

Based on the exploratory tests of the EUT, the one EUT cable configuration and arrangement and mode of operation that produced the emission with the highest amplitude relative to the limit is selected for the final measurement, while applying the appropriate modulating signal to the EUT. If the EUT is relocated from an exploratory test site to a final test site, the highest emissions shall be

remaximized at the final test location before final ac power-line conducted emission measurements are performed. The final test on all current-carrying conductors of all of the power cords to the equipment that comprises the EUT (but not the cords associated with other non-EUT equipment in the system) is then performed for the full frequency range for which the EUT is being tested for compliance without further variation of the EUT arrangement, cable positions, or EUT mode of operation. If the EUT is composed of equipment units that have their own separate ac power connections (e.g., floor-standing equipment with independent power cords for each shelf that are able to connect directly to the ac power network), then each current-carrying conductor of one unit is measured while the other units are connected to a second (or more) LISN(s). All units shall be measured separately. If a power strip is provided by the manufacturer, to supply all of the units making up the EUT, only the conductors in the power cord of the power strip shall be measured.

Test Condition:

| Voltage (V) | Frequency (Hz) |
|-------------|----------------|
| 120 | 60 |

Measurement Result and limit:

EUT ID: EUT1

Bluetooth (Quasi-peak Limit)

| Frequency range (MHz) | Quasi-peak Limit (dB μ V) | Result (dB μ V) | | Conclusion |
|-----------------------|-------------------------------|---------------------|-----------|------------|
| | | With charger | | |
| | | bluetooth | Idle | |
| 0.15 to 0.5 | 66 to 56 | Fig.B.9.1 | Fig.B.9.2 | P |
| 0.5 to 5 | 56 | | | |
| 5 to 30 | 60 | | | |

NOTE: The limit decreases linearly with the logarithm of the frequency in the range 0.15 MHz to 0.5 MHz.

Bluetooth (Average Limit)

| Frequency range (MHz) | Average Limit (dB μ V) | Result (dB μ V) | | Conclusion |
|-----------------------|----------------------------|---------------------|-----------|------------|
| | | With charger | | |
| | | bluetooth | Idle | |
| 0.15 to 0.5 | 56 to 46 | Fig.B.9.1 | Fig.B.9.2 | P |
| 0.5 to 5 | 46 | | | |
| 5 to 30 | 50 | | | |

NOTE: The limit decreases linearly with the logarithm of the frequency in the range 0.15 MHz to 0.5 MHz.

Conclusion: Pass

Test graphs as below:

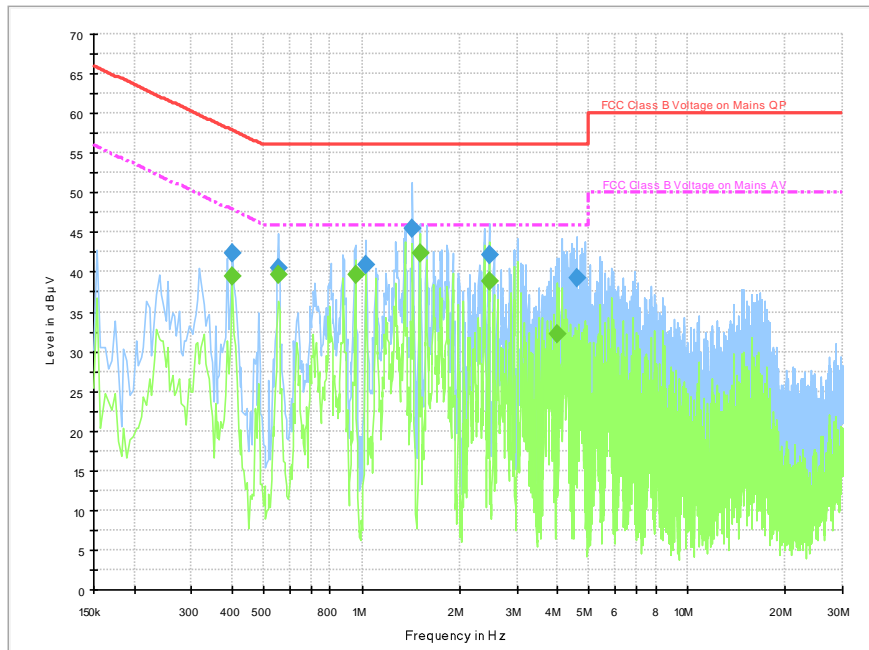

Fig.B.9.1 AC Powerline Conducted Emission- bluetooth

Note: The graphic result above is the maximum of the measurements for both phase line and neutral line.

Final Result 1

| Frequency (MHz) | QuasiPeak (dBuV) | Meas. Time (ms) | Bandwidth (kHz) | Filter | Line | Corr. (dB) | Margin (dB) | Limit (dBuV) | Comment |
|-----------------|------------------|-----------------|-----------------|--------|------|------------|-------------|--------------|---------|
| 0.402000 | 42.5 | 5000.0 | 9.000 | On | N | 19.8 | 15.4 | 57.8 | |
| 0.554000 | 40.5 | 5000.0 | 9.000 | On | N | 19.8 | 15.5 | 56.0 | |
| 1.034000 | 41.0 | 5000.0 | 9.000 | On | N | 19.6 | 15.0 | 56.0 | |
| 1.434000 | 45.4 | 5000.0 | 9.000 | On | N | 19.6 | 10.6 | 56.0 | |
| 2.462000 | 42.1 | 5000.0 | 9.000 | On | N | 19.6 | 13.9 | 56.0 | |
| 4.586000 | 39.3 | 5000.0 | 9.000 | On | L1 | 19.5 | 16.7 | 56.0 | |

Final Result 2

| Frequency (MHz) | QuasiPeak (dBuV) | Meas. Time (ms) | Bandwidth (kHz) | Filter | Line | Corr. (dB) | Margin (dB) | Limit (dBuV) | Comment |
|-----------------|------------------|-----------------|-----------------|--------|------|------------|-------------|--------------|---------|
| 0.398000 | 39.4 | 5000.0 | 9.000 | On | L1 | 19.7 | 8.5 | 47.9 | |
| 0.554000 | 39.7 | 5000.0 | 9.000 | On | L1 | 19.7 | 6.3 | 46.0 | |
| 0.954000 | 39.8 | 5000.0 | 9.000 | On | L1 | 19.7 | 6.2 | 46.0 | |
| 1.506000 | 42.3 | 5000.0 | 9.000 | On | L1 | 19.7 | 3.7 | 46.0 | |
| 2.458000 | 38.9 | 5000.0 | 9.000 | On | L1 | 19.6 | 7.1 | 46.0 | |
| 3.966000 | 32.2 | 5000.0 | 9.000 | On | L1 | 19.6 | 13.8 | 46.0 | |

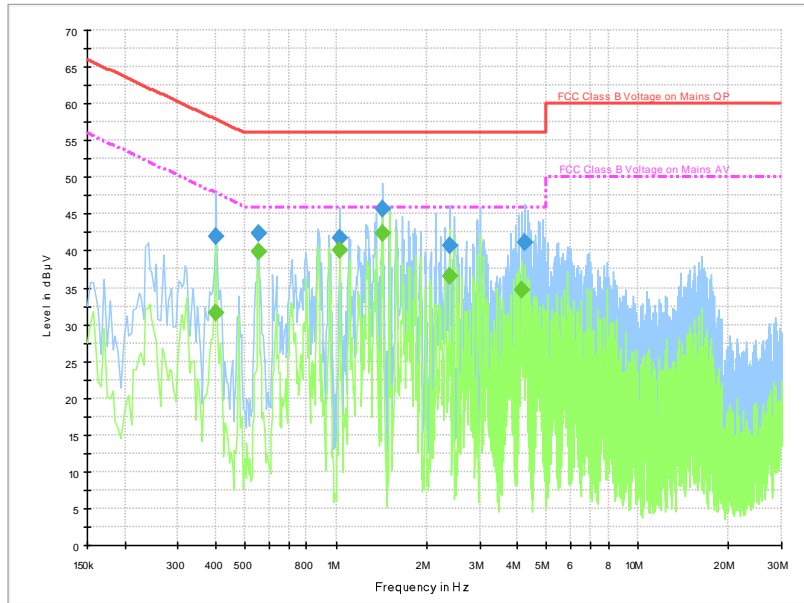

Fig.B.9.2 AC Powerline Conducted Emission-Idle

Note: The graphic result above is the maximum of the measurements for both phase line and neutral line.

Final Result 1

| Frequency (MHz) | QuasiPeak (dBµV) | Meas. Time (ms) | Bandwidth (kHz) | Filter | Line | Corr. (dB) | Margin (dB) | Limit (dBµV) | Comment |
|-----------------|------------------|-----------------|-----------------|--------|------|------------|-------------|--------------|---------|
| 0.402000 | 42.0 | 5000.0 | 9.000 | On | N | 19.8 | 15.8 | 57.8 | |
| 0.554000 | 42.3 | 5000.0 | 9.000 | On | L1 | 19.7 | 13.7 | 56.0 | |
| 1.030000 | 41.8 | 5000.0 | 9.000 | On | N | 19.6 | 14.2 | 56.0 | |
| 1.434000 | 45.7 | 5000.0 | 9.000 | On | N | 19.6 | 10.3 | 56.0 | |
| 2.390000 | 40.8 | 5000.0 | 9.000 | On | N | 19.7 | 15.2 | 56.0 | |
| 4.214000 | 41.1 | 5000.0 | 9.000 | On | L1 | 19.6 | 14.9 | 56.0 | |

Final Result 2

| Frequency (MHz) | QuasiPeak (dBµV) | Meas. Time (ms) | Bandwidth (kHz) | Filter | Line | Corr. (dB) | Margin (dB) | Limit (dBµV) | Comment |
|-----------------|------------------|-----------------|-----------------|--------|------|------------|-------------|--------------|---------|
| 0.402000 | 31.7 | 5000.0 | 9.000 | On | N | 19.8 | 16.2 | 47.8 | |
| 0.554000 | 40.0 | 5000.0 | 9.000 | On | L1 | 19.7 | 6.0 | 46.0 | |
| 1.030000 | 40.1 | 5000.0 | 9.000 | On | L1 | 19.8 | 5.9 | 46.0 | |
| 1.430000 | 42.5 | 5000.0 | 9.000 | On | L1 | 19.7 | 3.5 | 46.0 | |
| 2.378000 | 36.6 | 5000.0 | 9.000 | On | L1 | 19.6 | 9.5 | 46.0 | |
| 4.118000 | 34.7 | 5000.0 | 9.000 | On | L1 | 19.6 | 11.3 | 46.0 | |

ANNEX C: Accreditation Certificate

| | |
|---|---|
| <p>United States Department of Commerce National Institute of Standards and Technology</p>   | |
| <hr/> Certificate of Accreditation to ISO/IEC 17025:2017 <hr/> | |
| NVLAP LAB CODE: 600118-0 | |
| Telecommunication Technology Labs, CAICT Beijing China | |
| <i>is accredited by the National Voluntary Laboratory Accreditation Program for specific services, listed on the Scope of Accreditation, for:</i> | |
| Electromagnetic Compatibility & Telecommunications | |
| <i>This laboratory is accredited in accordance with the recognized International Standard ISO/IEC 17025:2017. This accreditation demonstrates technical competence for a defined scope and the operation of a laboratory quality management system (refer to joint ISO-ILAC-IAF Communique dated January 2009).</i> | |
| 2021-09-29 through 2022-09-30 <i>Effective Dates</i> |   <i>For the National Voluntary Laboratory Accreditation Program</i> |

END OF REPORT