

**Product : Internal Antenna**

**Model Name : WTATTRW2**

**Date : 2023.06.14**

---

## Table of Contents

	Page
1. Manufacturer -----	3
2. Model Name -----	3
3. Antenna Type -----	3
4. Electrical Performance Data -----	3
5. Matching circuit -----	13
6. Electrical Graph( VSWR/Return loss)-----	15
7. External Drawing -----	17

## 1. Manufacturer

- Kunshan Innwave Communication Technology Co.,Ltd
- Huizhou speed wireless technology co.,ltd.

## 2. Model Name

- Basic Model: WTATTRW2

## 3. Antenna Type

IFA

## 4. Electric Performance Data

### 4.1 Specification Sheet

#### Electronic Specification

Band	Avg gain(dBi)	Max gain (dBi)	Type
WCDMA B1	0.5	1.5	FPC
WCDMA B2	1.2	1.5	FPC
WCDMA B4	1	2.1	FPC
WCDMA B5	-0.6	0.4	FPC
WCDMA B8	0.3	1.2	FPC
LTE B2	1.2	1.5	FPC
LTE B3	1.6	2.1	FPC
LTE B4	1	2.1	FPC
LTE B5	-0.6	0.4	FPC
LTE B7	-0.6	1	FPC
LTE B12	-1.7	-1	FPC
LTE B14	-1.1	-0.7	FPC
LTE B20	-0.8	-0.1	FPC
LTE B30	0.2	0.7	FPC
WiFi 2.4G	0.75	1.63	FPC
WiFi 5G	-0.8	0.2	FPC
BT	0.75	1.63	FPC
GPS	0.72	0.99	FPC

## 4.2 Antenna Pattern Drawing

**B2**

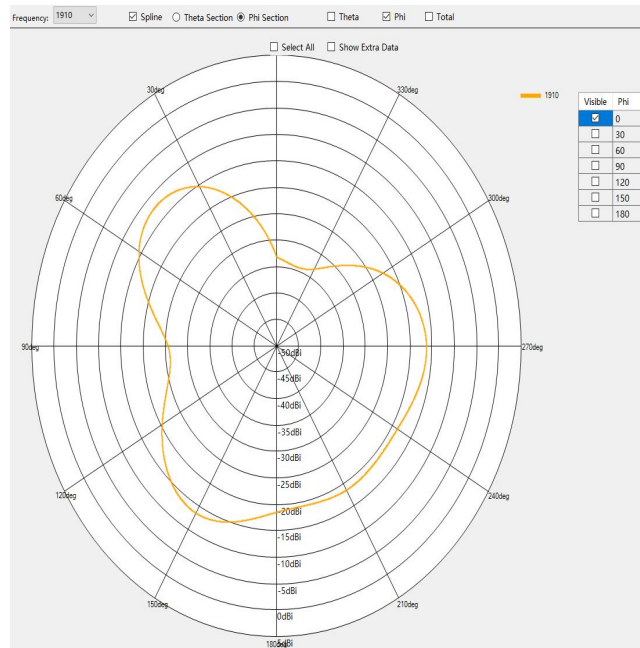

Phi=0.00deg

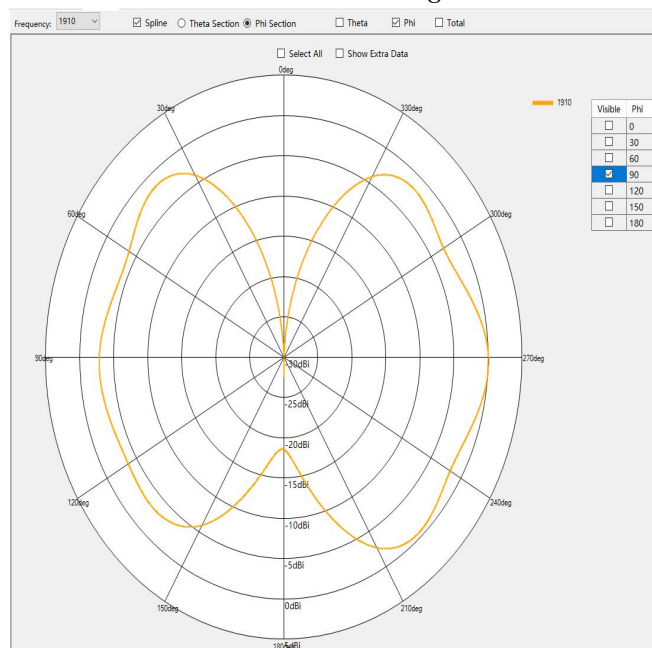

Phi=90.00deg

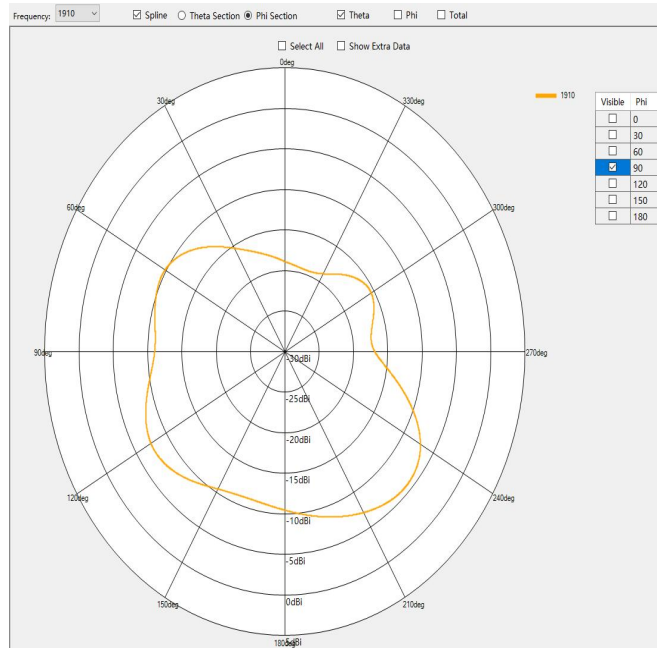

Theta=90.00deg

### B3

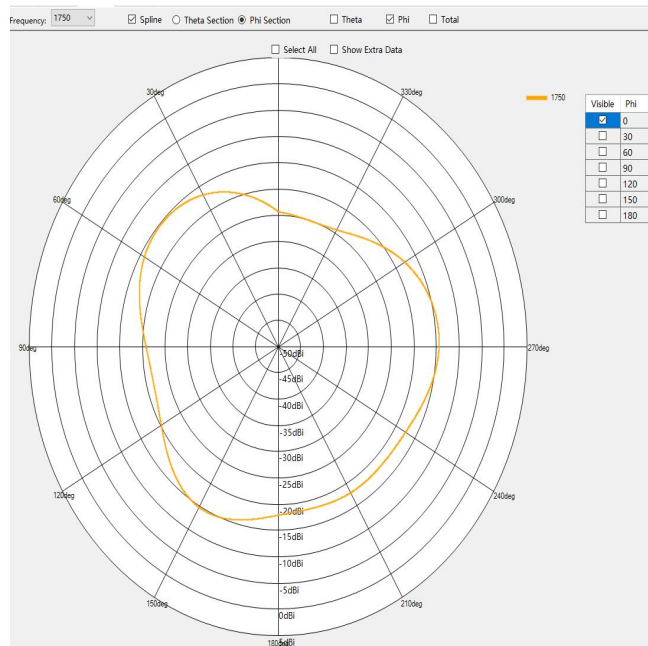

Phi=0.00deg

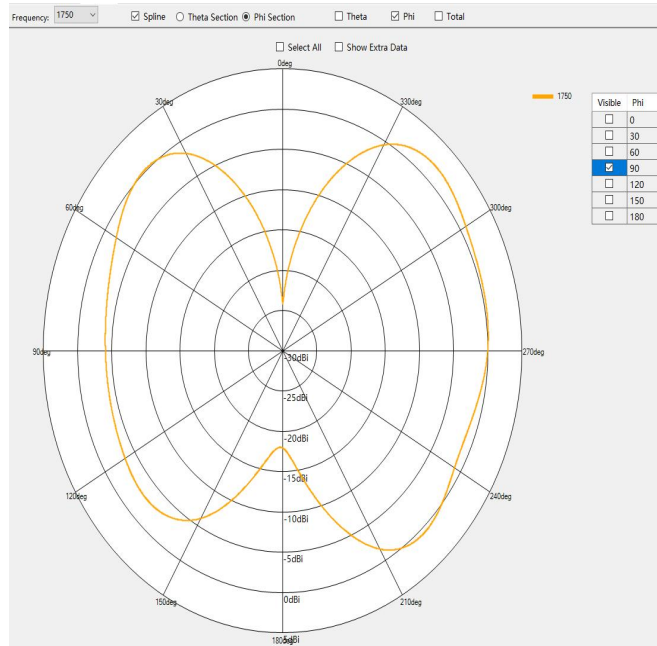

Phi=90.00deg

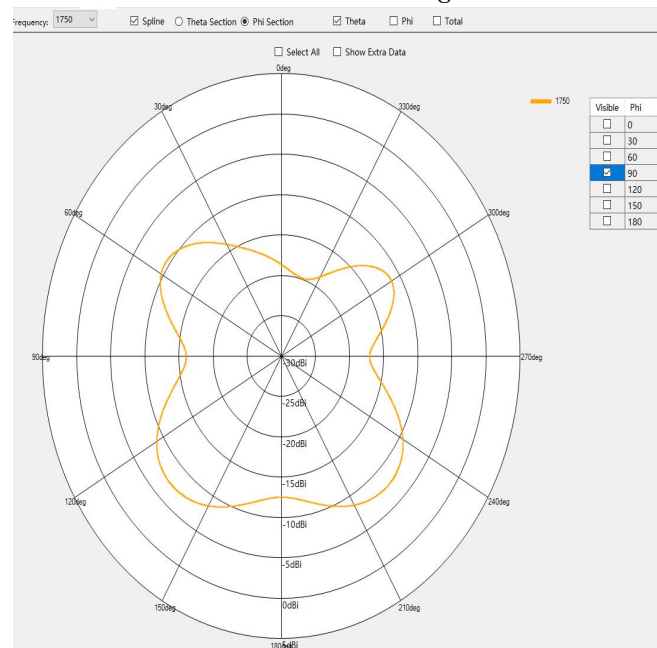

Theta=90.00deg

# B4

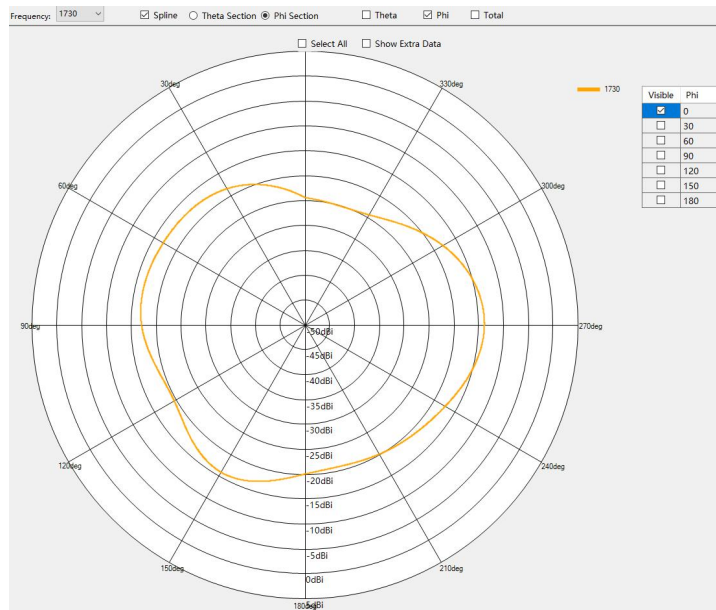

Phi=0.00deg

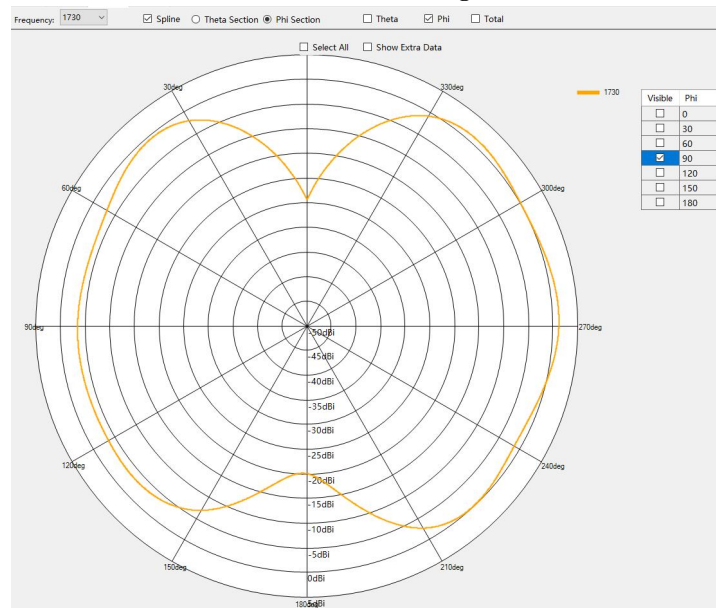

Phi=90.00deg

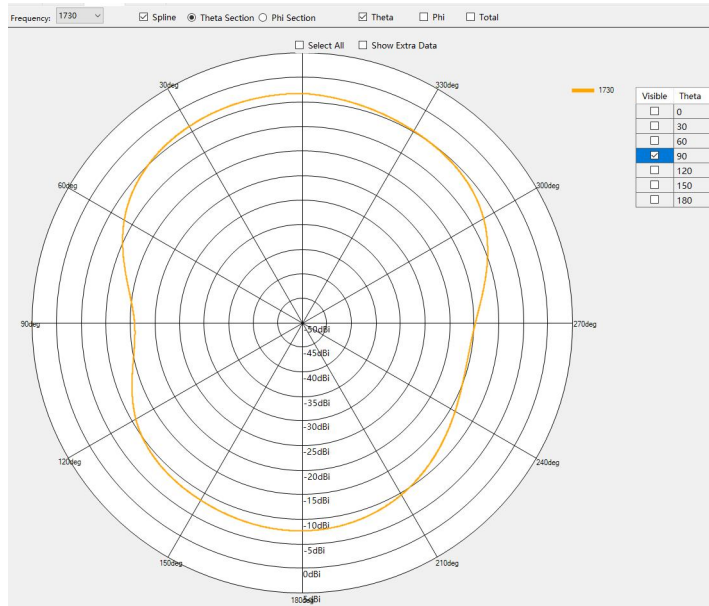

Theta=90.00deg

### B5

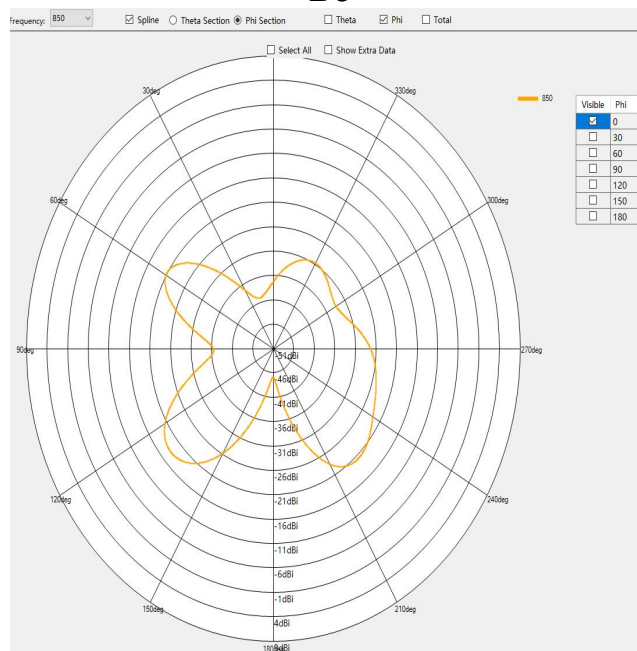

Phi=0.00deg



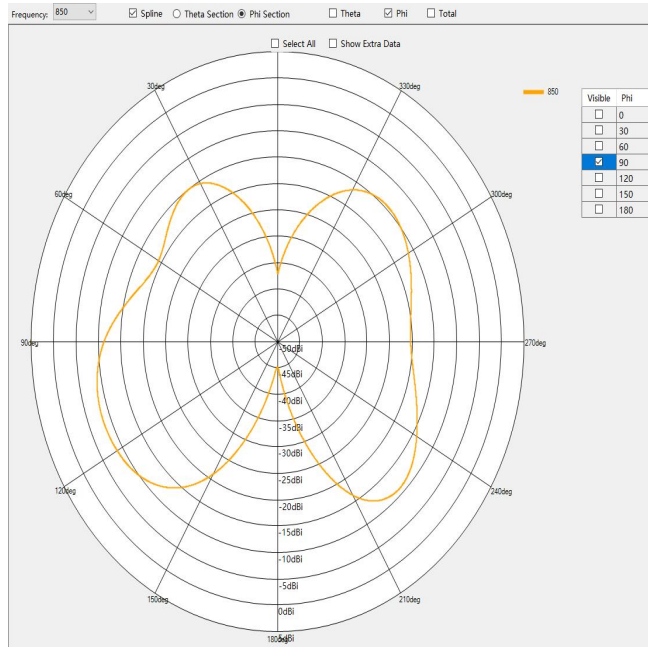

Phi=90.00deg

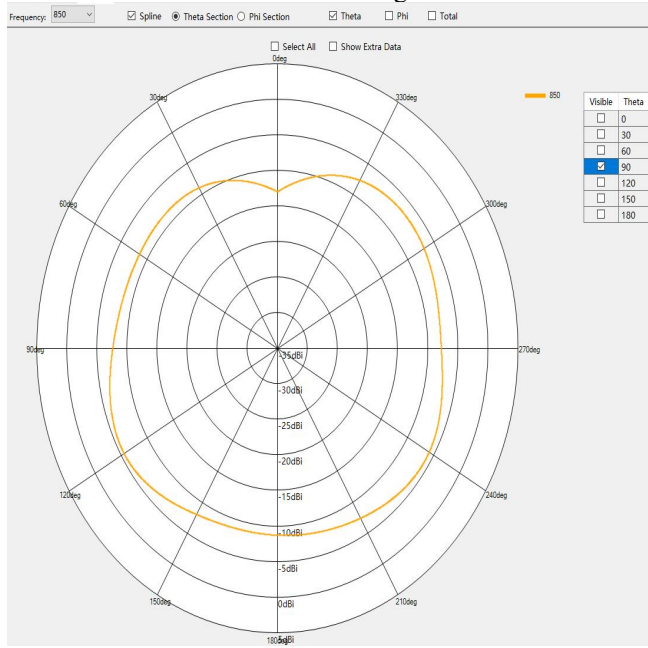

Theta=90.00deg

**B7**

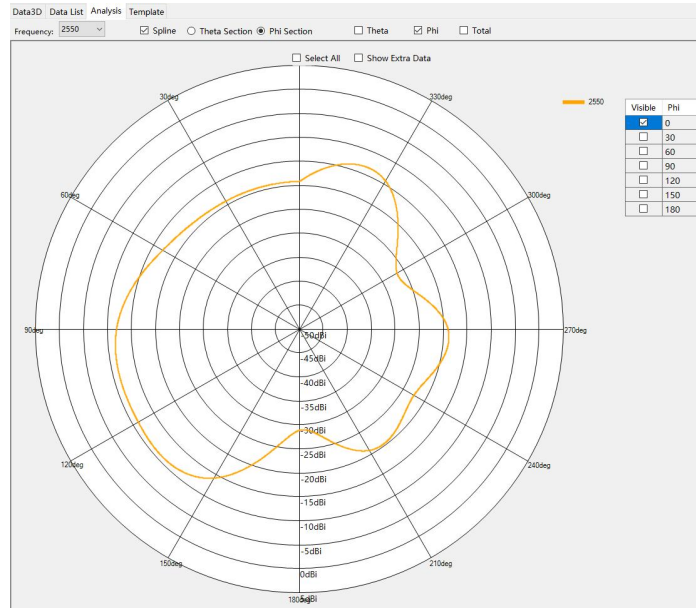

Phi=0.00deg

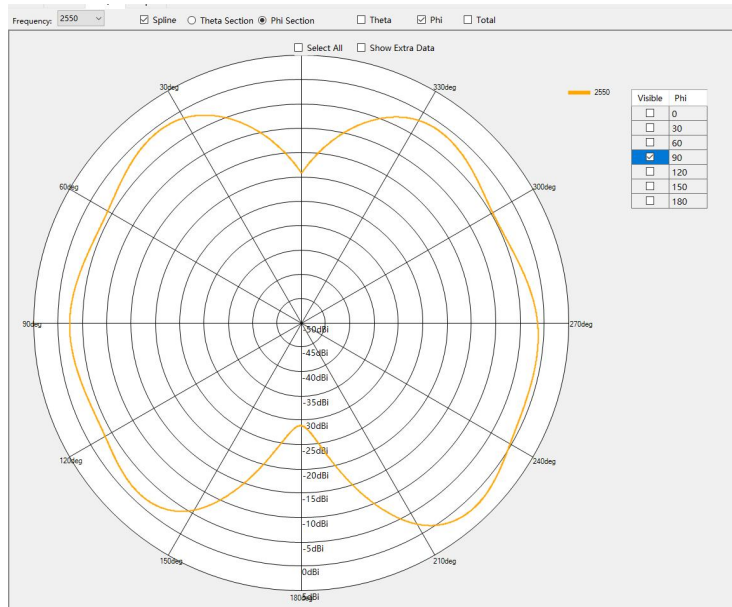

Phi=90.00deg

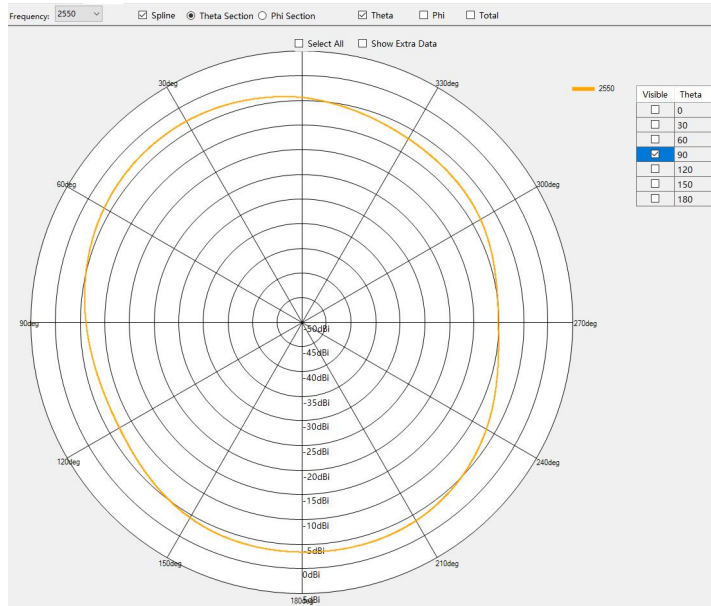

Theta=90.00deg

## B12

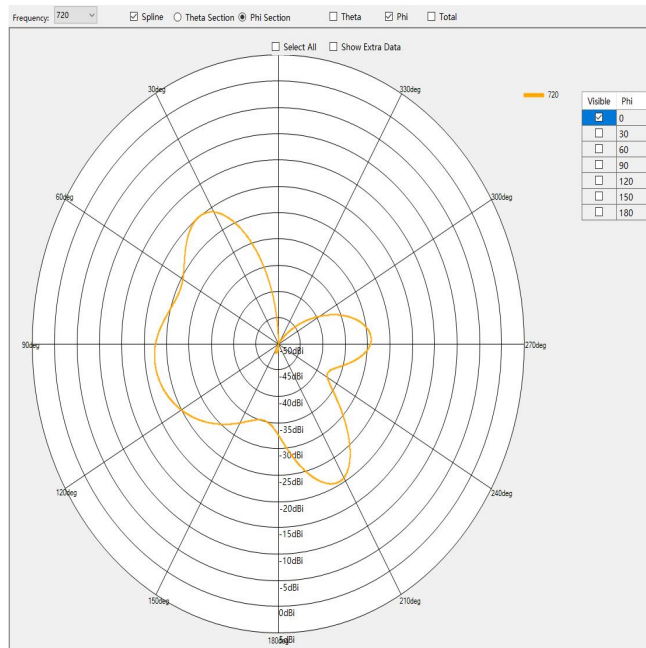

Phi=0.00deg

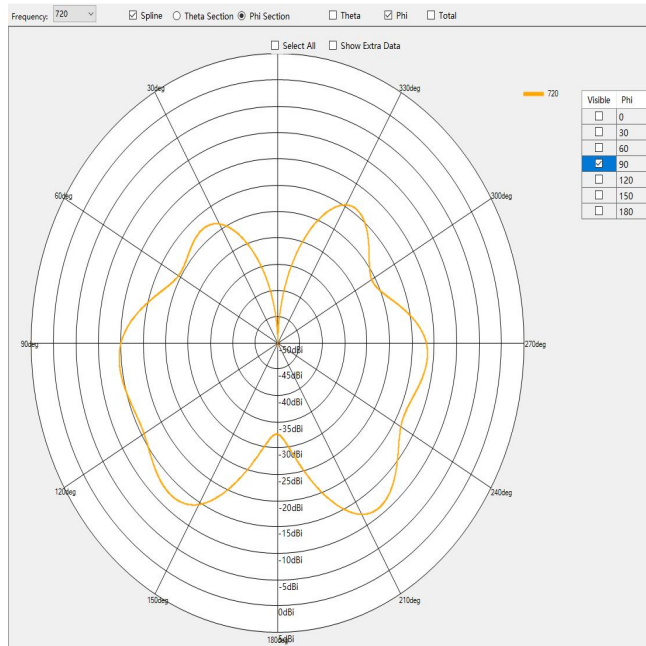

**Phi=90.00deg**

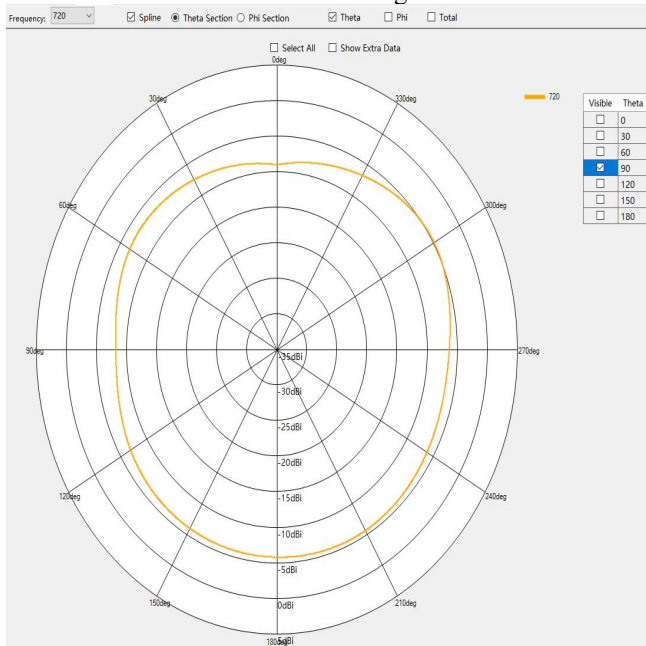

**Theta=90.00deg**

# B14

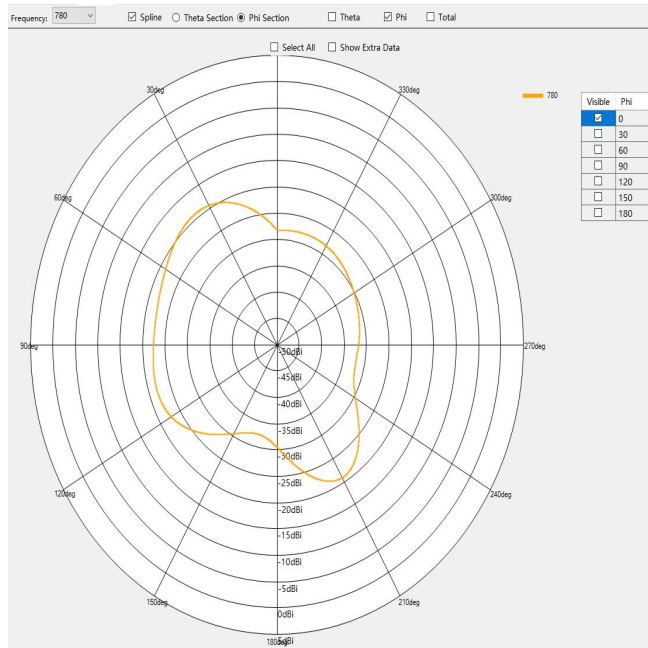

Phi=0.00deg

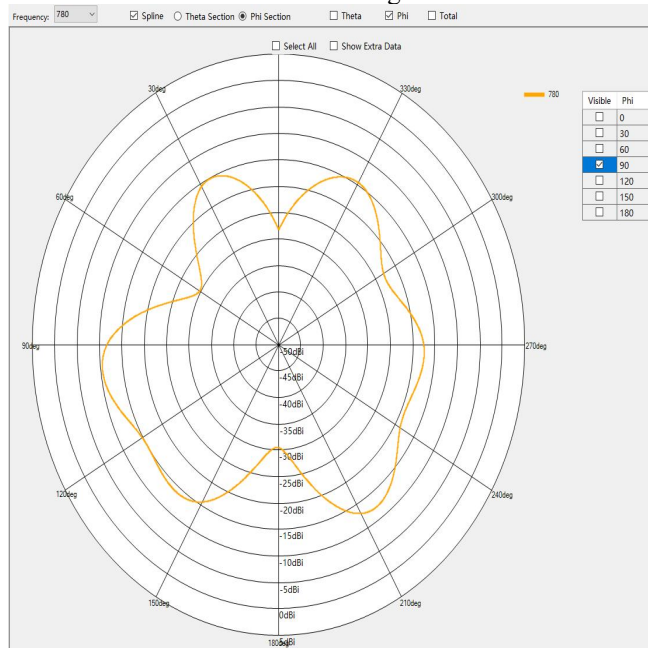

Phi=90.00deg

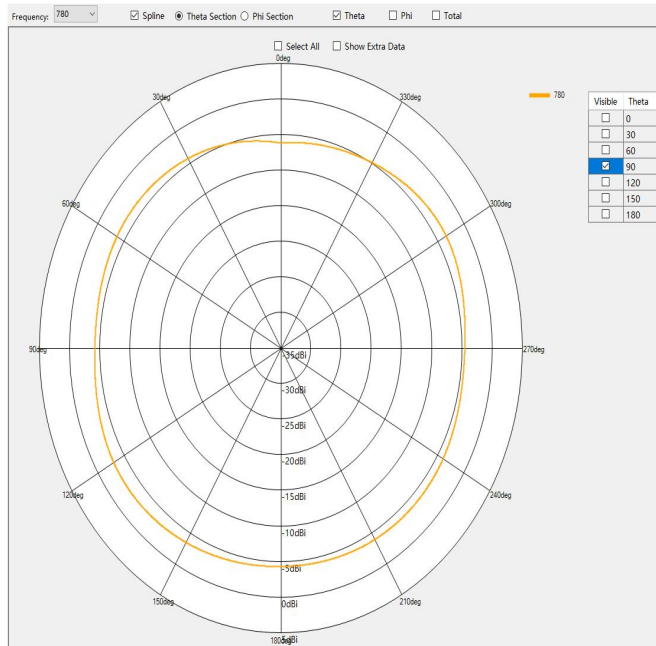

Theta=90.00deg

### B30

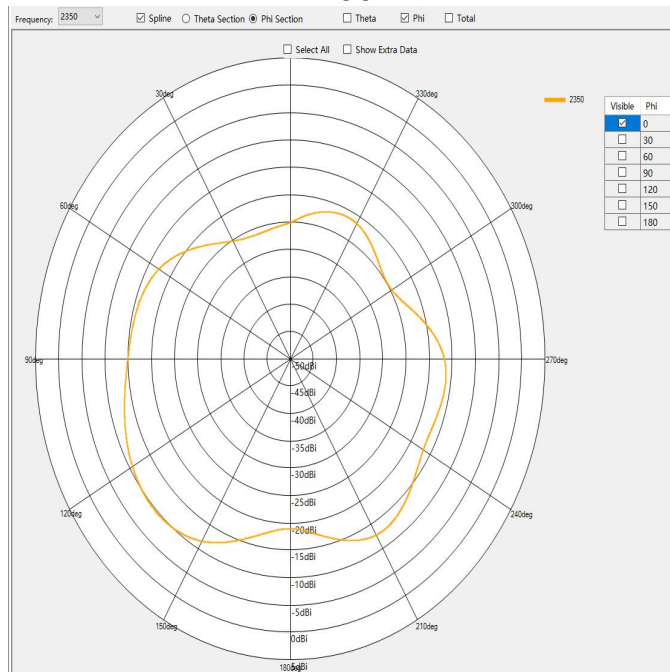

Phi=0.00deg

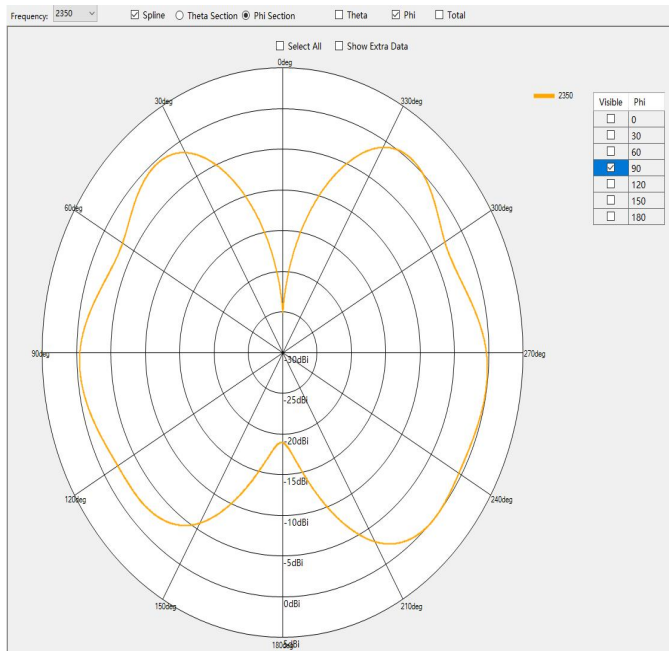

**Phi=90.00deg**

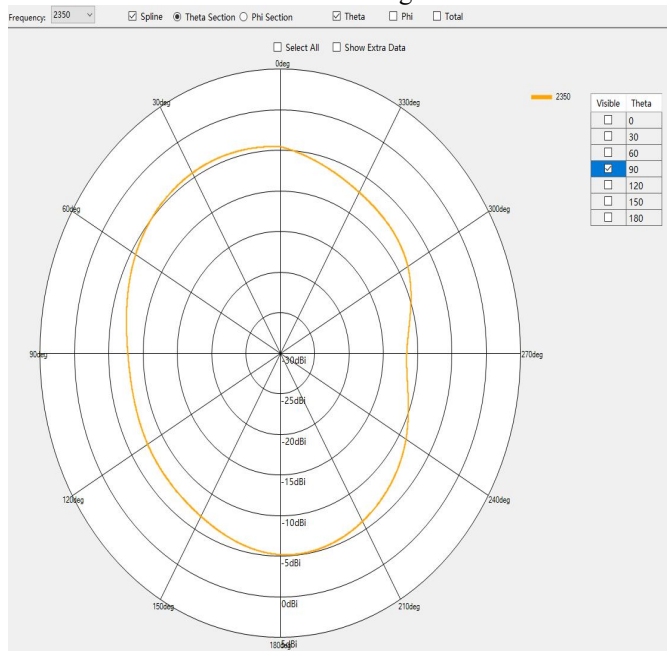

**Theta=90.00deg**

# WIFI 2.4G/BT

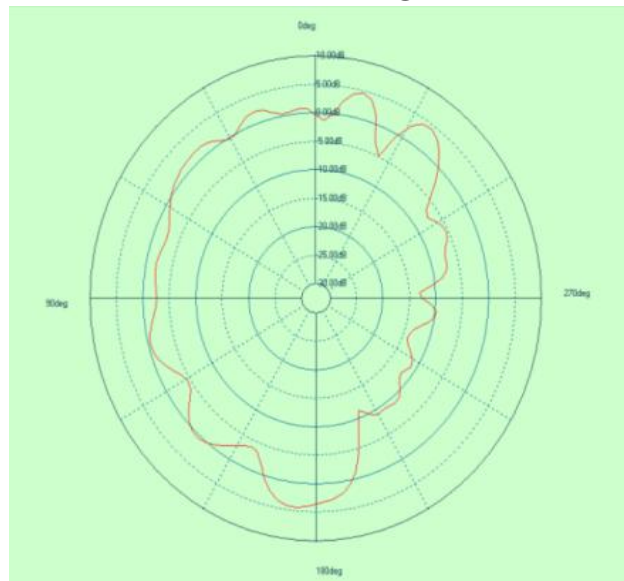

$\Phi = 0.00^\circ$

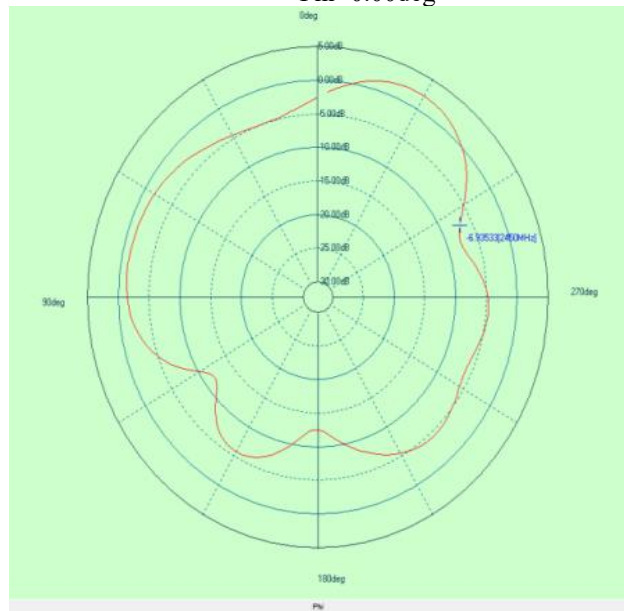

$\Phi = 90.00^\circ$

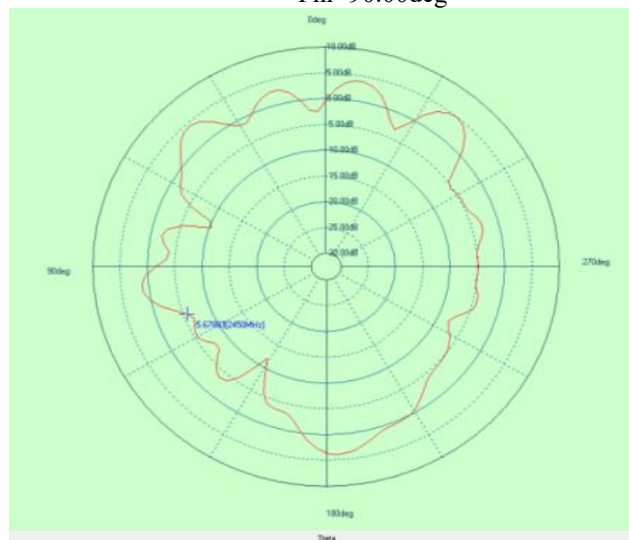



Theta=90.00deg

### WIFI 5G

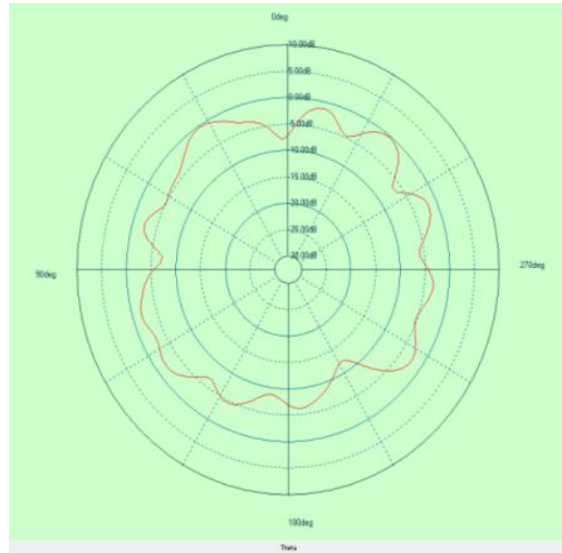

Phi=0.00deg

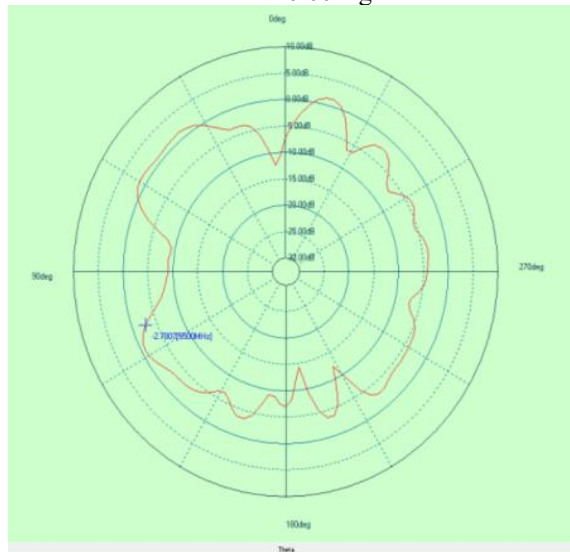

Phi=90.00deg

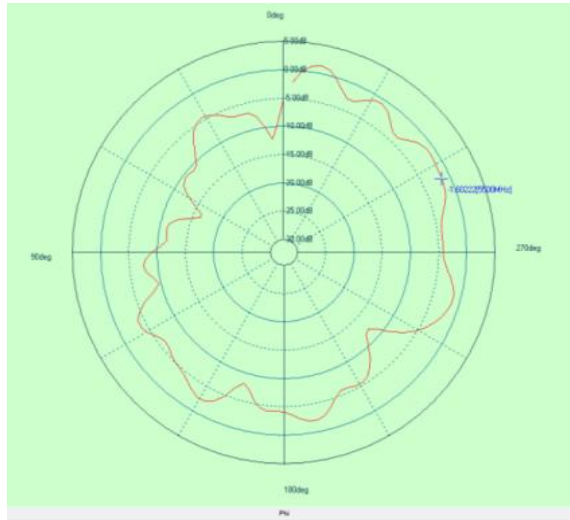

Theta=90.00deg  
**GPS**

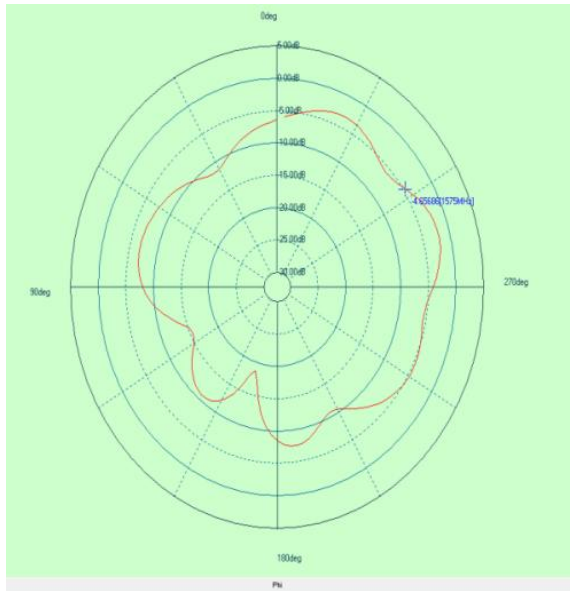

Phi=0.00deg

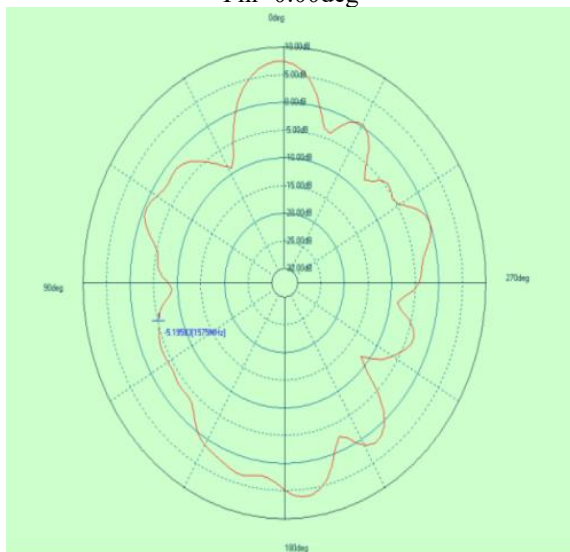

Phi=90.00deg

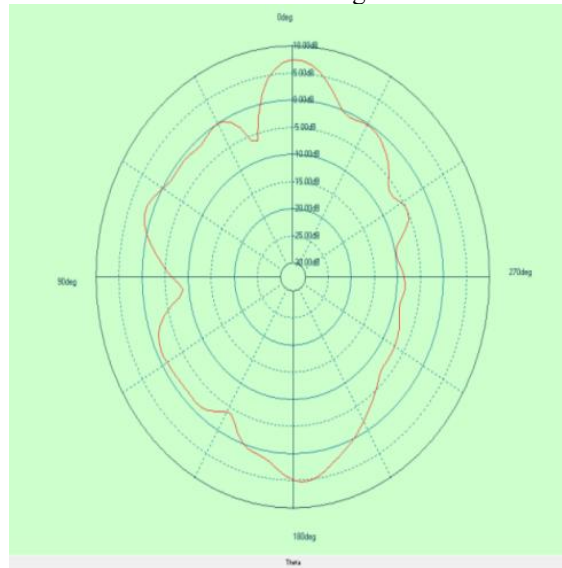

Theta=90.00deg

## 5. Matching circuit

### 5.1 Main Antenna

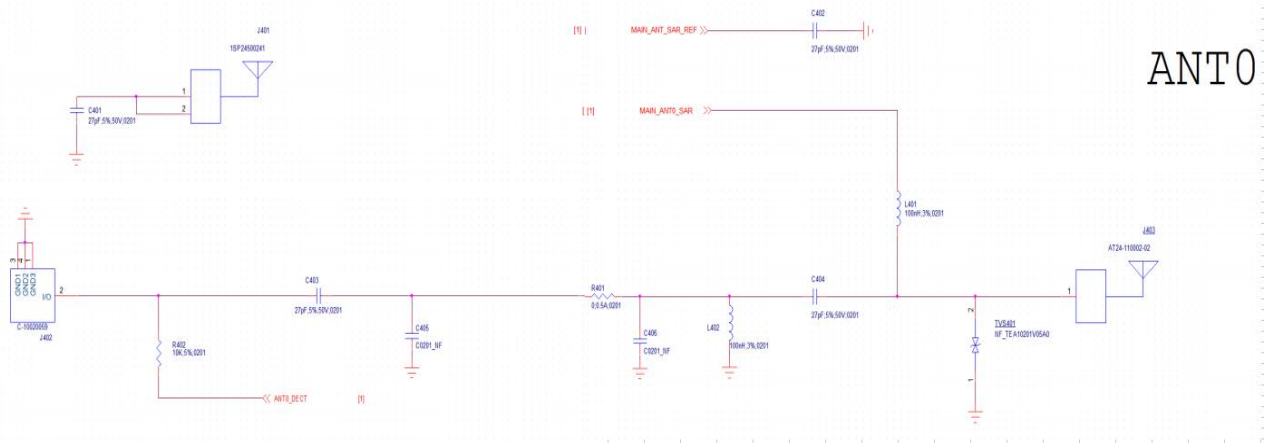

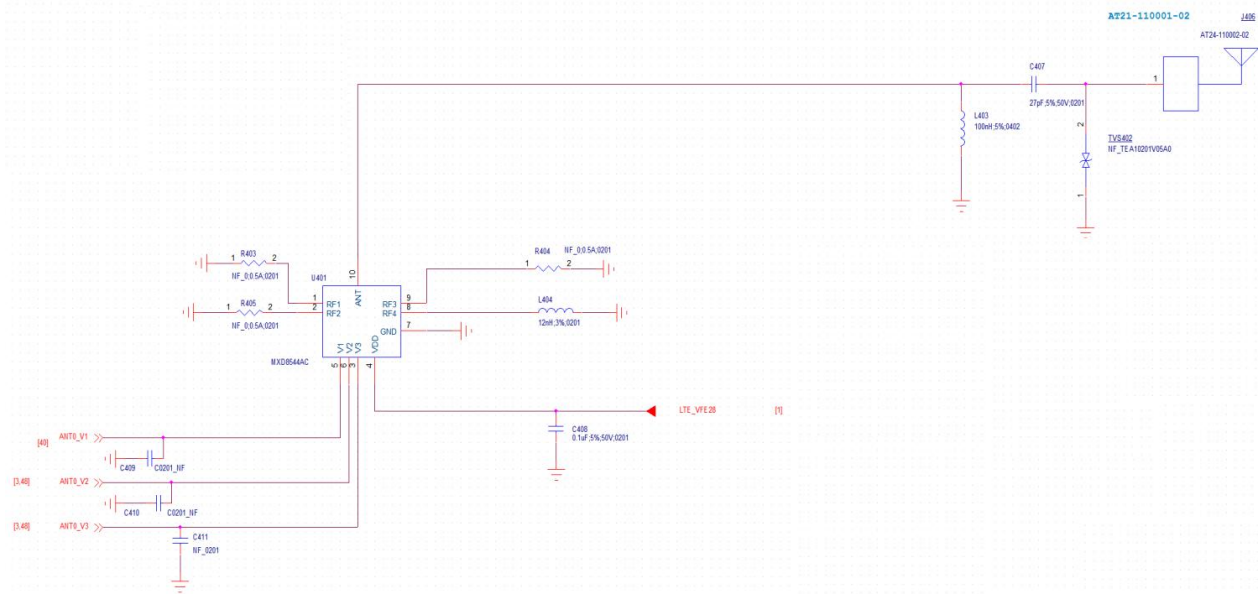

## 5.2 Div Antenna

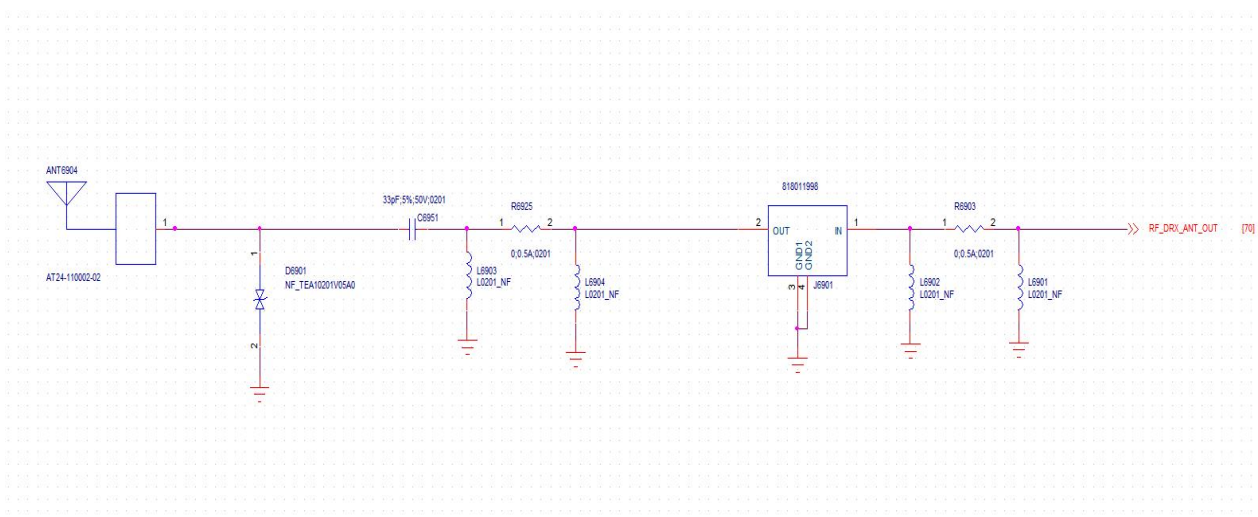

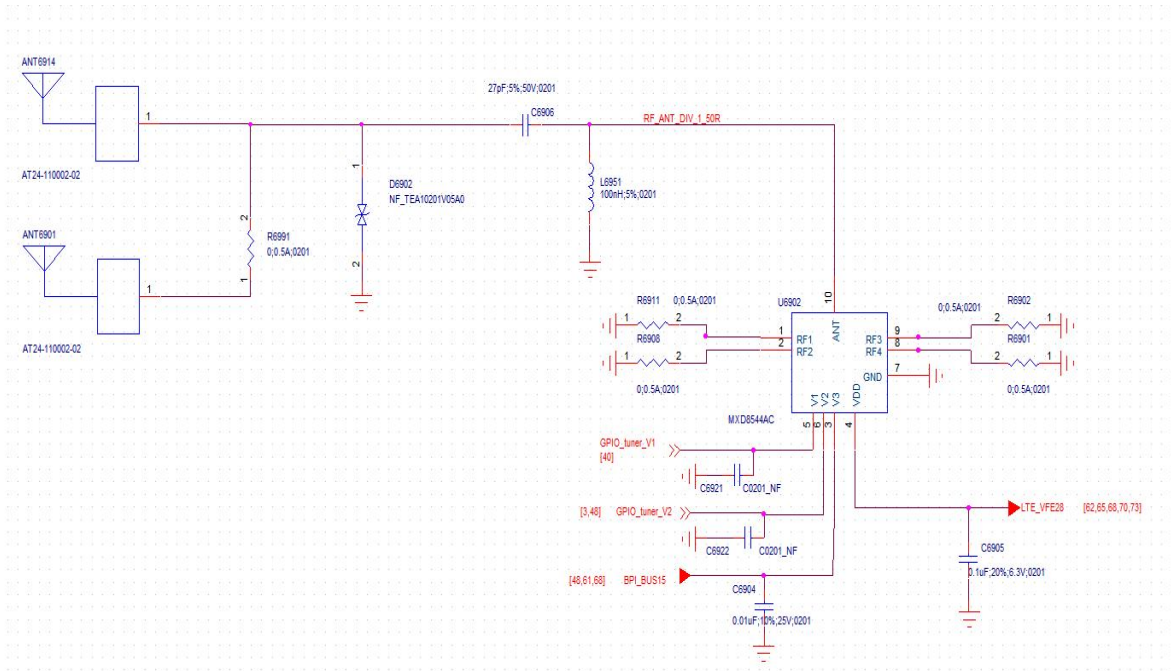

### 5.3 WiFi/GPS/BT Antenna

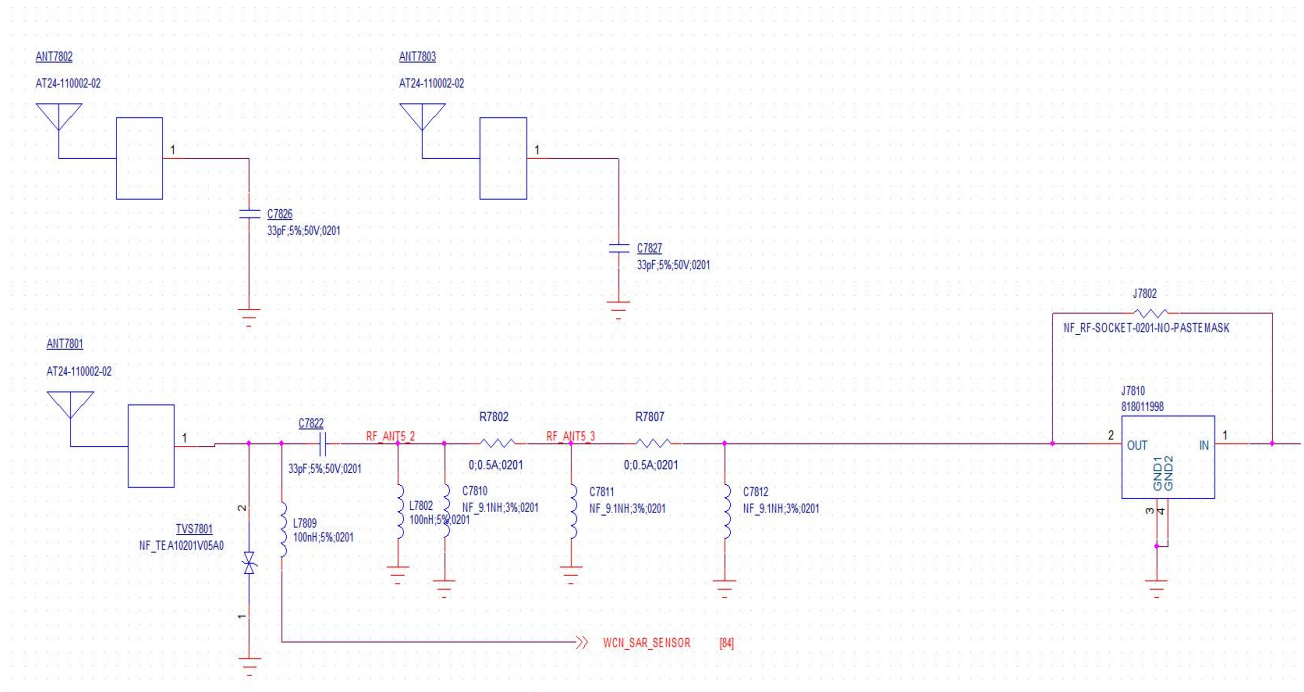

## 6. ElectricalGraph( Returnloss)

### 6.1 Main Antenna

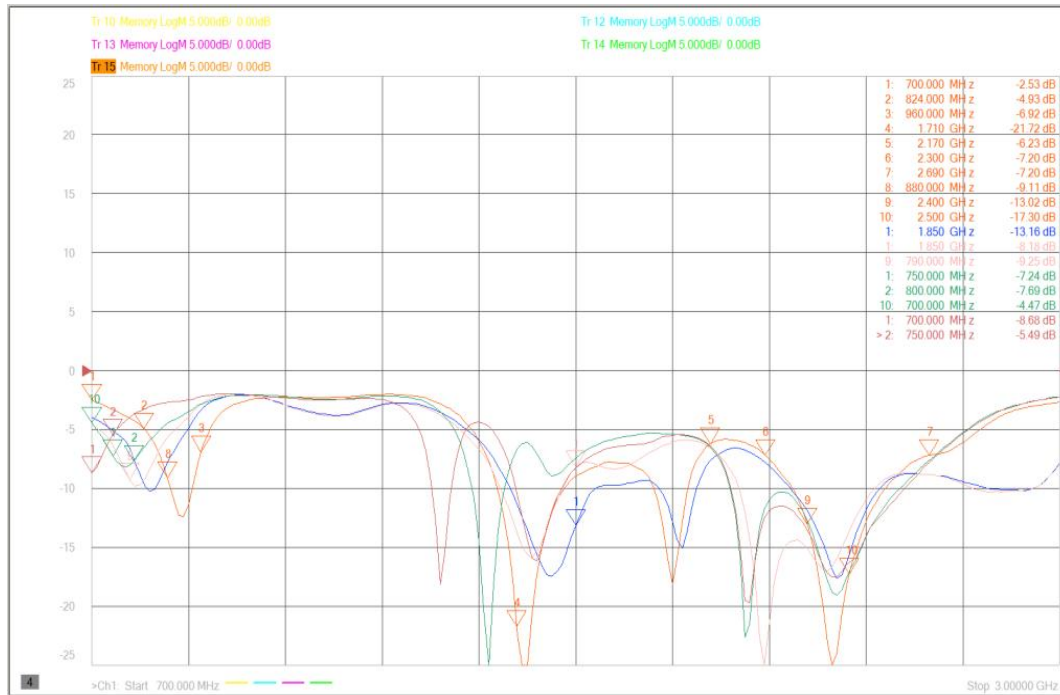

### 6.2 DIV Antenna

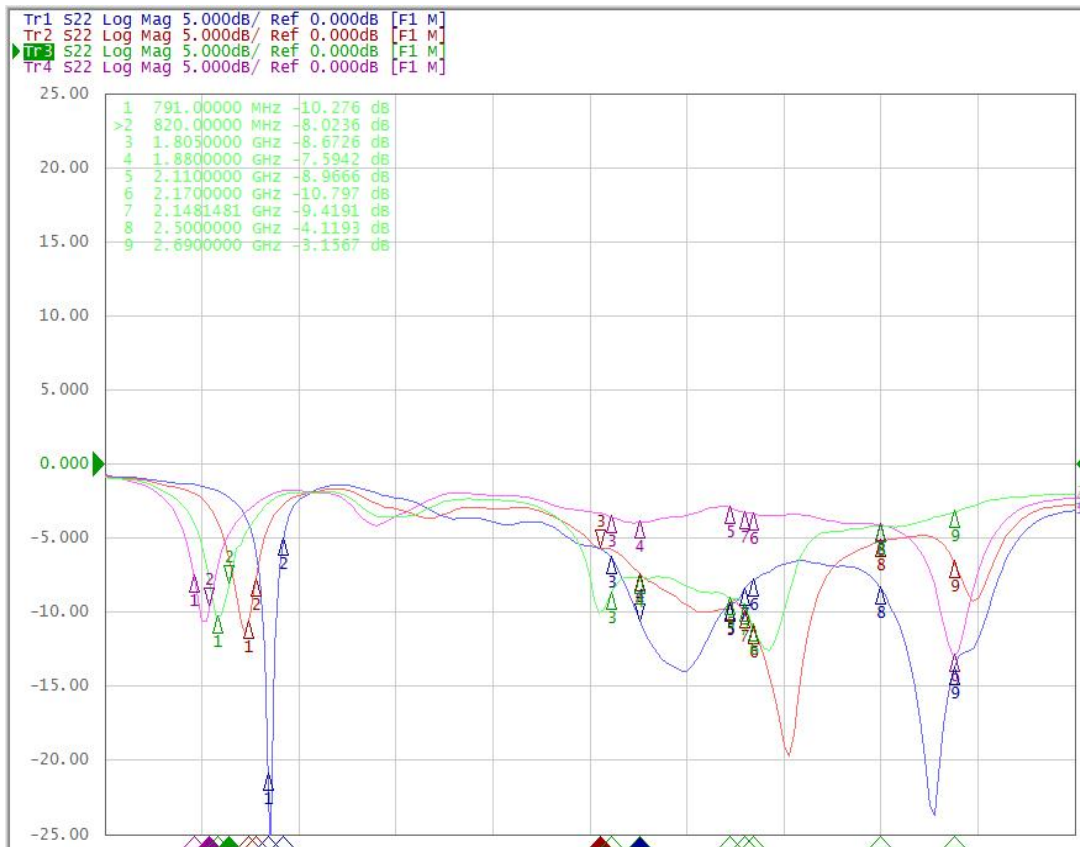

### 6.3 2.4G WIFI/GPS/BT Antenna

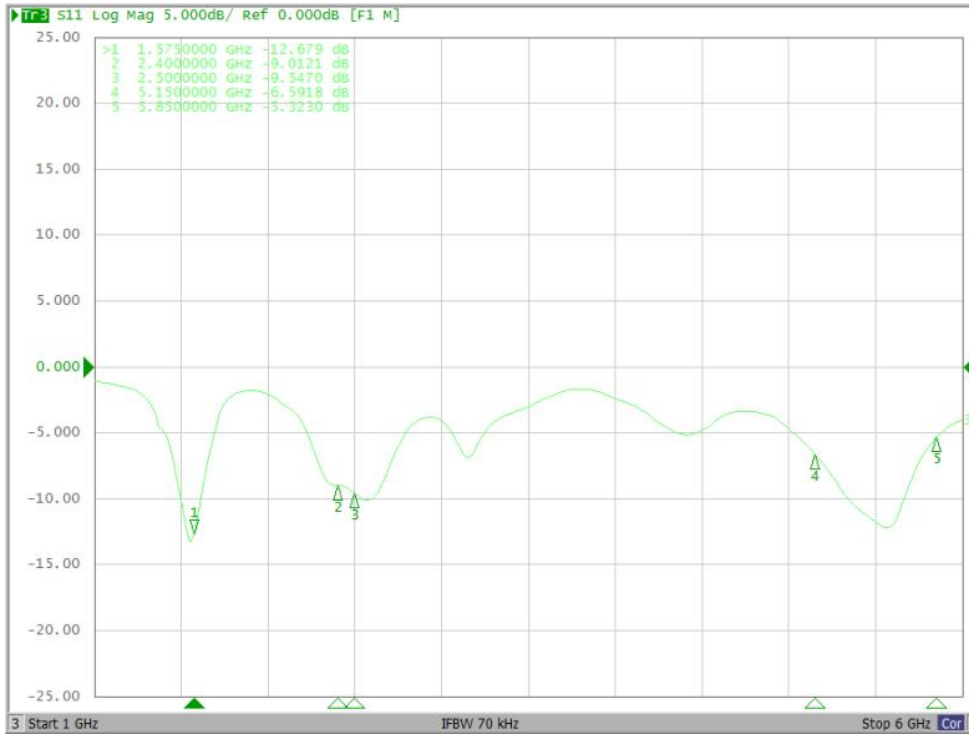

## 7. External Drawing

### 7.1 Main Antenna

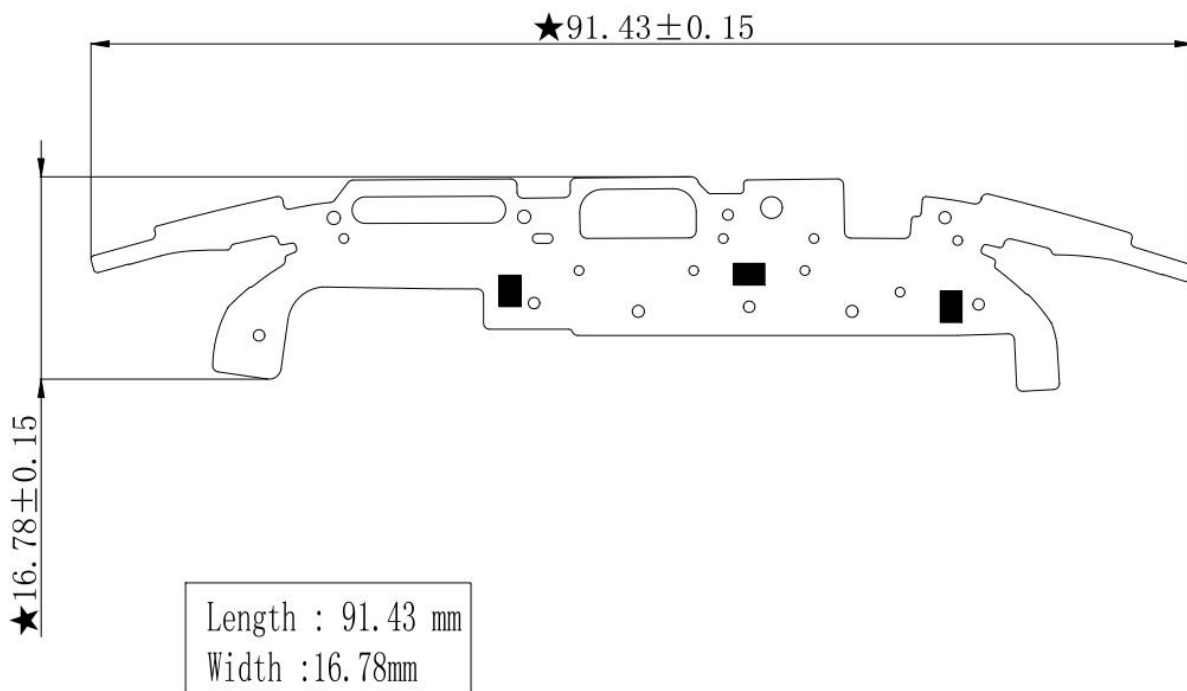

### 7.2 DIV Antenna

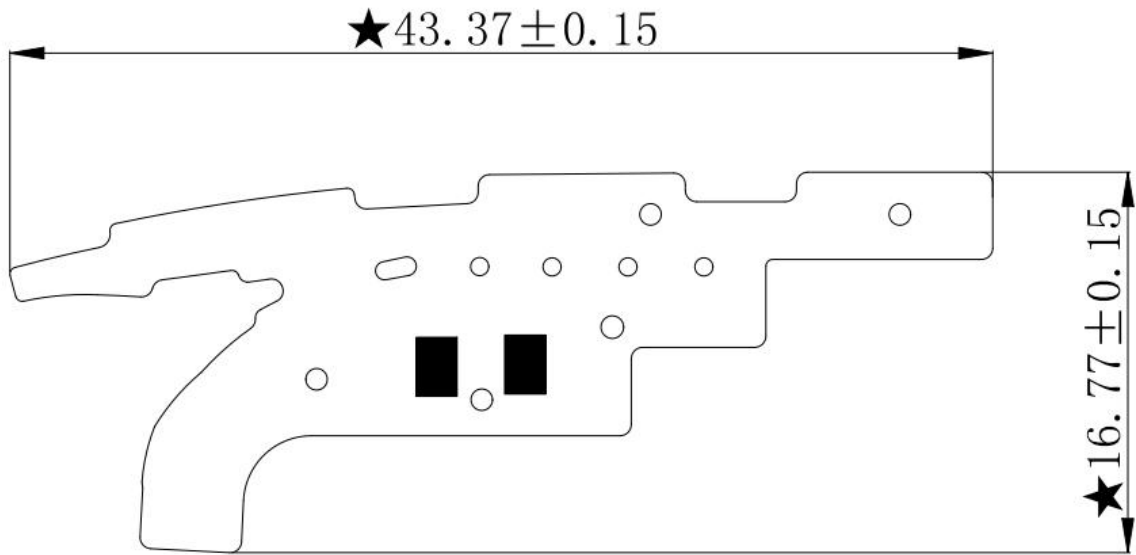

Length : 43.37 mm  
Width : 16.77mm

### 7.2 WIFI/GPS/BT Antenna

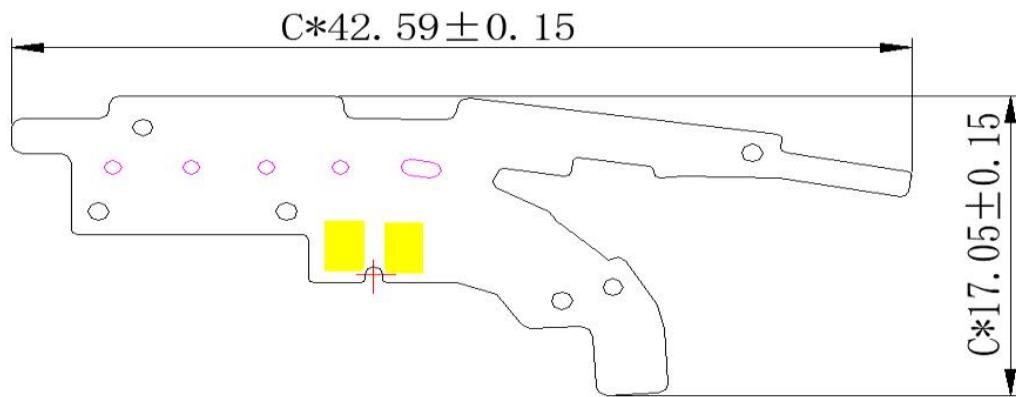

Length: 42.59mm  
Width: 17.05mm