



# SAR TEST REPORT

No. I21Z61109-SEM03

For

**Wingtech Group (Hong Kong) Limited**

**4G Mobile Phone**

**Model name: TMRVL4G**

With

**Hardware Version: 98117\_1\_10**

**Software Version: TMRVL4G\_0.01.01**

**FCC ID: 2APXW-TMRVL4G**

**Issued Date: 2021-8-17**

**Note:**

The test results in this test report relate only to the devices specified in this report. This report shall not be reproduced except in full without the written approval of CTTL.

The report must not be used by the client to claim product certification, approval, or endorsement by NVLAP, NIST, or any agency of the U.S. Government.

**Test Laboratory:**

CTTL, Telecommunication Technology Labs, CAICT

No. 51, Xueyuan Road, Haidian District, Beijing, P. R. China 100191.

Tel:+86(0)10-62304633-2512, Fax:+86(0)10-62304633-2504

Email: [ctl\\_terminals@caict.ac.cn](mailto:ctl_terminals@caict.ac.cn), website: [www.caict.ac.cn](http://www.caict.ac.cn)

**REPORT HISTORY**

<b>Report Number</b>	<b>Revision</b>	<b>Issue Date</b>	<b>Description</b>
I21Z61109-SEM03	Rev.0	2021-8-5	Initial creation of test report
I21Z61109-SEM03	Rev.0	2021-8- <del>17</del> <sup>5</sup>	Update the information for KDB 616217 D04 on Page10.

## TABLE OF CONTENT

<b>1 TEST LABORATORY</b> .....	<b>5</b>
1.1 TESTING LOCATION .....	5
1.2 TESTING ENVIRONMENT.....	5
1.3 PROJECT DATA .....	5
1.4 SIGNATURE.....	5
<b>2 STATEMENT OF COMPLIANCE</b> .....	<b>6</b>
<b>3 CLIENT INFORMATION</b> .....	<b>8</b>
3.1 APPLICANT INFORMATION .....	8
3.2 MANUFACTURER INFORMATION .....	8
<b>4 EQUIPMENT UNDER TEST (EUT) AND ANCILLARY EQUIPMENT (AE)</b> .....	<b>9</b>
4.1 ABOUT EUT .....	9
4.2 INTERNAL IDENTIFICATION OF EUT USED DURING THE TEST .....	9
4.3 INTERNAL IDENTIFICATION OF AE USED DURING THE TEST .....	9
<b>5 TEST METHODOLOGY</b> .....	<b>10</b>
5.1 APPLICABLE LIMIT REGULATIONS .....	10
5.2 APPLICABLE MEASUREMENT STANDARDS.....	10
<b>6 SPECIFIC ABSORPTION RATE (SAR)</b> .....	<b>11</b>
6.1 INTRODUCTION.....	11
6.2 SAR DEFINITION.....	11
<b>7 TISSUE SIMULATING LIQUIDS</b> .....	<b>12</b>
7.1 TARGETS FOR TISSUE SIMULATING LIQUID .....	12
7.2 DIELECTRIC PERFORMANCE .....	12
<b>8 SYSTEM VERIFICATION</b> .....	<b>17</b>
8.1 SYSTEM SETUP.....	17
8.2 SYSTEM VERIFICATION.....	18
<b>9 MEASUREMENT PROCEDURES</b> .....	<b>19</b>
9.1 TESTS TO BE PERFORMED .....	19
9.2 GENERAL MEASUREMENT PROCEDURE.....	21
9.3 WCDMA MEASUREMENT PROCEDURES FOR SAR .....	22
9.4 SAR MEASUREMENT FOR LTE.....	23
9.5 BLUETOOTH & WI-FI MEASUREMENT PROCEDURES FOR SAR .....	25
9.6 POWER DRIFT.....	25
<b>10 AREA SCAN BASED 1-G SAR</b> .....	<b>26</b>
10.1 REQUIREMENT OF KDB.....	26
10.2 FAST SAR ALGORITHMS .....	26

<b>11 CONDUCTED OUTPUT POWER .....</b>	<b>27</b>
11.1 GSM MEASUREMENT RESULT .....	27
11.2 WCDMA MEASUREMENT RESULT.....	30
11.3 LTE MEASUREMENT RESULT .....	32
11.4 WI-FI AND BT MEASUREMENT RESULT .....	64
<b>12 SIMULTANEOUS TX SAR CONSIDERATIONS .....</b>	<b>66</b>
12.1 TRANSMIT ANTENNA SEPARATION DISTANCES .....	66
12.2 SAR MEASUREMENT POSITIONS .....	66
12.3 STANDALONE SAR TEST EXCLUSION CONSIDERATIONS .....	67
<b>13 EVALUATION OF SIMULTANEOUS.....</b>	<b>68</b>
<b>14 SAR TEST RESULT .....</b>	<b>69</b>
14.1 SAR RESULTS FOR FAST SAR.....	70
14.2 SAR RESULTS FOR STANDARD PROCEDURE .....	81
14.3 WLAN EVALUATION FOR 2.4G .....	86
14.4 WLAN EVALUATION FOR 5G.....	89
14.5 SAR RESULTS FOR FAST BT .....	95
14.6 SAR EVALUATION FOR PHABLET .....	96
<b>15 SAR MEASUREMENT VARIABILITY.....</b>	<b>98</b>
<b>16 MEASUREMENT UNCERTAINTY .....</b>	<b>99</b>
16.1 MEASUREMENT UNCERTAINTY FOR NORMAL SAR TESTS (300MHZ~3GHZ) .....	99
16.2 MEASUREMENT UNCERTAINTY FOR NORMAL SAR TESTS (3~6GHZ) .....	100
16.3 MEASUREMENT UNCERTAINTY FOR FAST SAR TESTS (300MHZ~3GHZ) .....	101
16.4 MEASUREMENT UNCERTAINTY FOR FAST SAR TESTS (3~6GHZ).....	102
<b>17 MAIN TEST INSTRUMENTS .....</b>	<b>103</b>
<b>ANNEX A GRAPH RESULTS .....</b>	<b>104</b>
<b>ANNEX B SYSTEM VERIFICATION RESULTS.....</b>	<b>142</b>
<b>ANNEX C SAR MEASUREMENT SETUP .....</b>	<b>154</b>
<b>ANNEX D POSITION OF THE WIRELESS DEVICE IN RELATION TO THE PHANTOM .....</b>	<b>160</b>
<b>ANNEX E EQUIVALENT MEDIA RECIPES .....</b>	<b>163</b>
<b>ANNEX F SYSTEM VALIDATION.....</b>	<b>164</b>
<b>ANNEX G PROBE CALIBRATION CERTIFICATE .....</b>	<b>165</b>
<b>ANNEX H DIPOLE CALIBRATION CERTIFICATE.....</b>	<b>174</b>
<b>ANNEX I SENSOR TRIGGERING DATA SUMMARY .....</b>	<b>226</b>
<b>ANNEX J ACCREDITATION CERTIFICATE.....</b>	<b>229</b>

## 1 Test Laboratory

### 1.1 Testing Location

Company Name:	CTTL(Shouxiang)
Address:	No. 51 Shouxiang Science Building, Xueyuan Road, Haidian District, Beijing, P. R. China100191

### 1.2 Testing Environment

Temperature:	18°C~25°C,
Relative humidity:	30%~ 70%
Ground system resistance:	< 0.5 $\Omega$
Ambient noise & Reflection:	< 0.012 W/kg

### 1.3 Project Data

Project Leader:	Qi Dianyuan
Test Engineer:	Lin Xiaojun
Testing Start Date:	July 13, 2021
Testing End Date:	August 1, 2021

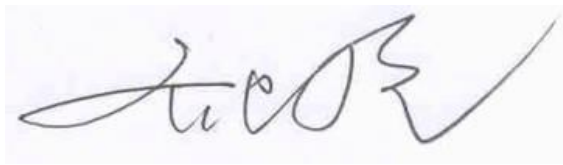
### 1.4 Signature



---

Lin Xiaojun

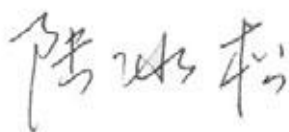
(Prepared this test report)



---

Qi Dianyuan

(Reviewed this test report)



---

Lu Bingsong

Deputy Director of the laboratory

(Approved this test report)

## 2 Statement of Compliance

The maximum results of Specific Absorption Rate (SAR) found during testing for Wingtech Group (Hong Kong) Limited 4G Mobile Phone TMRVL4G are as follows.

**Table 2.1: Highest Reported SAR (1g)**

Antenna	Band	Head	Body	Product Specific
		1g SAR(W/kg)	1g SAR(W/kg)	10g SAR(W/kg)
Main antenna	GSM 850	0.52	0.92	/
	PCS 1900	0.36	0.77	/
	UMTS FDD 2	0.49	1.14	/
	UMTS FDD 4	0.42	0.87	/
	UMTS FDD 5	0.40	0.82	/
	LTE Band 12	0.24	0.44	/
	LTE Band 25	0.38	0.91	/
	LTE Band 26	0.32	0.56	/
	LTE Band 41(Power Class 3)	0.26	0.74	/
	LTE Band 41(Power Class 2)	0.36	<b>1.43</b>	2.63
	LTE Band 66	0.36	0.76	/
	LTE Band 71	0.18	0.43	/
WiFi antenna	WiFi 2.4G	0.88	0.49	/
	WiFi 5G	0.78	0.45	/

The SAR values found for the Mobile Phone are below the maximum recommended levels of 1.6 W/kg as averaged over any 1g tissue according to the ANSI C95.1-1992.

For body operation, this device has been tested and meets FCC RF exposure guidelines when used with any accessory that contains no metal and which provides a minimum separation distance of 10/14 mm between this device and the body of the user. Use of other accessories may not ensure compliance with FCC RF exposure guidelines.

The EUT battery must be fully charged and checked periodically during the test to ascertain uniform power output.

The measurement together with the test system set-up is described in annex C of this test report. A detailed description of the equipment under test can be found in chapter 4 of this test report. The highest reported SAR value is obtained at the case of **(Table 2.1)**, and the values are: **1.43 W/kg(1g)**.

**Table 2.2: The sum of SAR values for Main antenna + WiFi-2.4G**

	Position	Band	Cellular antenna	WiFi-2.4G	Sum
<b>Highest reported SAR value for Head</b>	Left hand, Cheek	WCDMA1900	0.55	0.76	<b>1.31</b>
<b>Highest SAR value for Body</b>	Rear 10mm	GSM850	0.92	0.49	<b>1.41</b>

**Table 2.3: The sum of SAR values for Main antenna + WiFi-5G**

	Position	Band	Cellular antenna	WiFi-5G	Sum
<b>Highest SAR value for Head</b>	Left hand, Cheek	WCDMA1900	0.55	0.78	<b>1.33</b>
<b>Maximum reported SAR value for Body</b>	Rear 10mm	GSM850	0.92	0.41	<b>1.33</b>

**Table 2.4: The sum of SAR values for Main antenna + WiFi-5G +BT**

	Position	Band	Cellular antenna	WiFi-5G	BT	Sum
<b>Highest SAR value for Head</b>	Left hand, Cheek	WCDMA1900	0.55	0.78	<0.01	<b>1.33</b>
<b>Maximum reported SAR value for Body</b>	Rear 10mm	GSM850	0.92	0.41	<0.01	<b>1.33</b>

Note1: the test positions of above tables are for the worse case that have been evaluated.

[1] – The SAR of BT is too low to get it, so the “<0.01” is used to indicate the head SAR of BT.

According to the above tables, the highest sum of reported SAR values is **1.41 W/kg (1g)**. The detail for simultaneous transmission consideration is described in chapter 13.



### 3 Client Information

#### 3.1 Applicant Information

Company Name:	Wingtech Group (Hong Kong) Limited
Address/Post:	Flat/RM 1903, 19/F, Podium Plaza 5 Hanoi Road, Tsim Sha Tsui Kowloon, Hong Kong
Contact Person:	/
Contact Email:	/
Telephone:	/
Fax	/

#### 3.2 Manufacturer Information

Company Name:	Wingtech Group (Hong Kong) Limited
Address/Post:	Flat/RM 1903, 19/F, Podium Plaza 5 Hanoi Road, Tsim Sha Tsui Kowloon, Hong Kong
Contact Person:	/
Contact Email:	/
Telephone:	/
Fax	/



## 4 Equipment Under Test (EUT) and Ancillary Equipment (AE)

### 4.1 About EUT

Description:	4G Mobile Phone
Model name:	TMRVL4G
Operating mode(s):	GSM 850/900/1800/1900, UMTS FDD 1/2/4/5, BT, Wi-Fi(2.4/5G) LTE Band 2/4/5/12/25/26/41/66/71
Tested Tx Frequency:	824 – 849 MHz (GSM 850)
	1850 – 1910 MHz (GSM 1900)
	824–849 MHz (WCDMA 850 Band V)
	1710 – 1755 MHz (WCDMA 1700 Band IV)
	1850–1910 MHz (WCDMA1900 Band II)
	699 – 716 MHz (LTE Band 12)
	1850.7 – 1914.3 MHz (LTE Band 25)
	814.7 – 848.3 MHz (LTE Band 26)
	2498.5 – 2687.5 MHz (LTE Band 41)
	1710.7 – 1779.3 MHz (LTE Band 66)
	665.5 – 695.5 MHz (LTE Band 71)
	2412 – 2462 MHz (Wi-Fi 2.4G)
5150-5825 MHz (Wi-Fi 5G)	
GPRS/EGPRS Multislot Class:	12
GPRS capability Class:	B
Test device Production information:	Production unit
Device type:	Portable device
Antenna type:	Integrated antenna
HUPE	Support

### 4.2 Internal Identification of EUT used during the test

EUT ID*	IMEI	HW	SW Version
EUT1	863892050007372	98117_1_10	TMRVL4G_0.01.01
EUT2	863892050008909	98117_1_10	TMRVL4G_0.01.01
EUT3	863892050007216	98117_1_10	TMRVL4G_0.01.01
EUT4	863892050025804	98117_1_10	TMRVL4G_0.01.01
EUT5	863892050006805	98117_1_10	TMRVL4G_0.01.01

\*EUT ID: is used to identify the test sample in the lab internally.

**Note:** It is performed to test SAR with the EUT1~3 and conducted power with the EUT4~5.

### 4.3 Internal Identification of AE used during the test

AE ID*	Description	Model	SN	Manufacturer
AE1	Battery	JU001	/	Jiade Energy Technology (Zhuhai) Co.,Ltd.

\*AE ID: is used to identify the test sample in the lab internally.

## 5 TEST METHODOLOGY

### 5.1 Applicable Limit Regulations

**ANSI C95.1–1992:** IEEE Standard for Safety Levels with Respect to Human Exposure to Radio Frequency Electromagnetic Fields, 3 kHz to 300 GHz.

It specifies the maximum exposure limit of **1.6 W/kg** as averaged over any 1 gram of tissue for portable devices being used within 20 cm of the user in the uncontrolled environment.

### 5.2 Applicable Measurement Standards

**IEEE 1528–2013:** Recommended Practice for Determining the Peak Spatial-Average Specific Absorption Rate (SAR) in the Human Head from Wireless Communications Devices: Measurement Techniques.

**KDB447498 D01: General RF Exposure Guidance v06:** Mobile and Portable Devices RF Exposure Procedures and Equipment Authorization Policies.

**KDB648474 D04 Handset SAR v01r03:** SAR Evaluation Considerations for Wireless Handsets.

**KDB941225 D01 SAR test for 3G devices v03r01:** SAR Measurement Procedures for 3G Devices

**KDB941225 D05 SAR for LTE Devices v02r05:** SAR Evaluation Considerations for LTE Devices

**KDB941225 D06 Hotspot Mode SAR v02r01:** SAR Evaluation Procedures for Portable Devices with Wireless Router Capabilities

**KDB248227 D01 802.11 Wi-Fi SAR v02r02:** SAR GUIDANCE FOR IEEE 802.11 (Wi-Fi) TRANSMITTERS

**KDB865664 D01 SAR measurement 100 MHz to 6 GHz v01r04:** SAR Measurement Requirements for 100 MHz to 6 GHz.

**KDB865664 D02 RF Exposure Reporting v01r02:** RF Exposure Compliance Reporting and Documentation Considerations

**KDB616217 D04 SAR for laptop and tablets v01r02:** SAR Evaluation Considerations for Laptop, Notebook, Notebook and Tablet Computers.

## 6 Specific Absorption Rate (SAR)

### 6.1 Introduction

SAR is related to the rate at which energy is absorbed per unit mass in an object exposed to a radio field. The SAR distribution in a biological body is complicated and is usually carried out by experimental techniques or numerical modeling. The standard recommends limits for two tiers of groups, occupational/controlled and general population/uncontrolled, based on a person's awareness and ability to exercise control over his or her exposure. In general, occupational/controlled exposure limits are higher than the limits for general population/uncontrolled.

### 6.2 SAR Definition

The SAR definition is the time derivative (rate) of the incremental energy ( $dW$ ) absorbed by (dissipated in) an incremental mass ( $dm$ ) contained in a volume element ( $dv$ ) of a given density ( $\rho$ ). The equation description is as below:

$$SAR = \frac{d}{dt} \left( \frac{dW}{dm} \right) = \frac{d}{dt} \left( \frac{dW}{\rho dv} \right)$$

SAR is expressed in units of Watts per kilogram (W/kg)

SAR measurement can be either related to the temperature elevation in tissue by

$$SAR = c \left( \frac{\delta T}{\delta t} \right)$$

Where:  $C$  is the specific heat capacity,  $\delta T$  is the temperature rise and  $\delta t$  is the exposure duration, or related to the electrical field in the tissue by

$$SAR = \frac{\sigma |E|^2}{\rho}$$

Where:  $\sigma$  is the conductivity of the tissue,  $\rho$  is the mass density of tissue and  $E$  is the RMS electrical field strength.

However for evaluating SAR of low power transmitter, electrical field measurement is typically applied.

## 7 Tissue Simulating Liquids

### 7.1 Targets for tissue simulating liquid

**Table 7.1: Targets for tissue simulating liquid**

Frequency(MHz)	Liquid Type	Conductivity( $\sigma$ )	$\pm 10\%$ Range	Permittivity( $\epsilon$ )	$\pm 10\%$ Range
750	Head	0.89	0.80~0.98	41.94	37.75~46.13
835	Head	0.90	0.81~0.99	41.5	37.35~45.65
1750	Head	1.40	1.26~1.54	40.0	36~44
1900	Head	1.40	1.26~1.54	40.0	36~44
2450	Head	1.80	1.62~1.98	39.2	35.28~43.12
2600	Head	1.96	1.76~2.16	39.01	35.11~42.91

**Table 7.2: Targets for tissue simulating liquid**

Frequency(MHz)	Liquid Type	Conductivity( $\sigma$ )	$\pm 5\%$ Range	Permittivity( $\epsilon$ )	$\pm 5\%$ Range
5250	Head	4.71	4.47~4.95	35.93	34.13~37.73
5600	Head	5.07	4.82~5.32	35.53	33.8~37.3
5750	Head	5.22	4.96~5.48	35.36	33.59~37.13

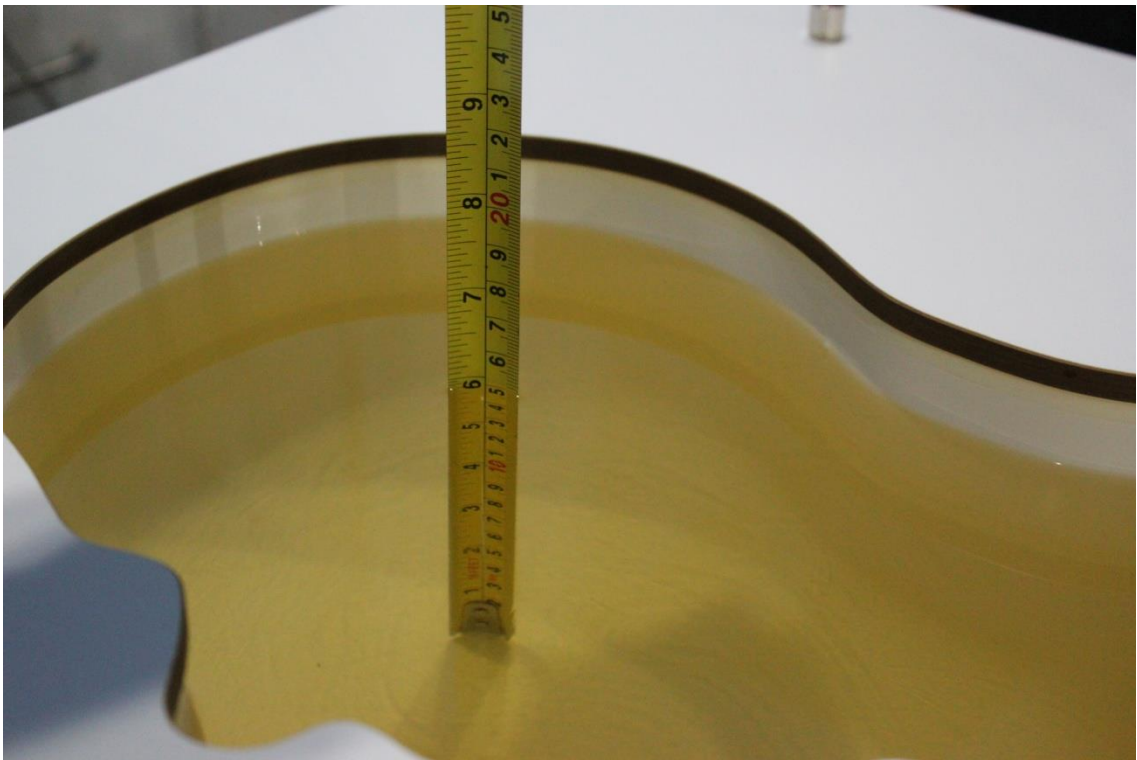
The dielectric constant ( $\epsilon_r$ ) and conductivity( $\sigma$ ) of typical tissue-equivalent media recipes are expected to be within  $\pm 5\%$  of the required target values; but for SAR measurement systems that have implemented the SAR error compensation algorithms documented in IEEE Std 1528-2013, to automatically compensate the measured SAR results for deviations between the measured and required tissue dielectric parameters the tolerance for  $\epsilon_r$  and  $\sigma$  may be relaxed to  $\pm 10\%$ . This is limited to frequencies  $\leq 3$  GHz.

### 7.2 Dielectric Performance

**Table 7.2: Dielectric Performance of Tissue Simulating Liquid**

Measurement Date (yyyy-mm-dd)	Type	Frequency	Permittivity $\epsilon$	Drift (%)	Conductivity $\sigma$ (S/m)	Drift (%)
2021-7-18	Head	750 MHz	44.61	6.37	0.8285	-6.91
2021-7-13	Head	835 MHz	44.23	6.58	0.8628	-4.13
2021-7-15	Head	1750 MHz	41.62	3.84	1.378	0.58
2021-7-17	Head	1900 MHz	41.35	3.38	1.459	4.21
2021-7-31	Head	2450 MHz	41.59	6.10	1.865	3.61
2021-7-12	Head	2600 MHz	39.96	2.44	2.035	3.83
2021-8-1	Head	5250 MHz	35.68	-0.70	4.622	-1.87
2021-7-21	Head	5600 MHz	35.57	0.11	5.037	-0.65
2021-8-1	Head	5600 MHz	35.12	-1.15	5.115	0.89
2021-7-21	Head	5750 MHz	35.29	-0.20	5.214	-0.11
2021-8-1	Head	5750 MHz	35.09	-0.76	5.236	0.31

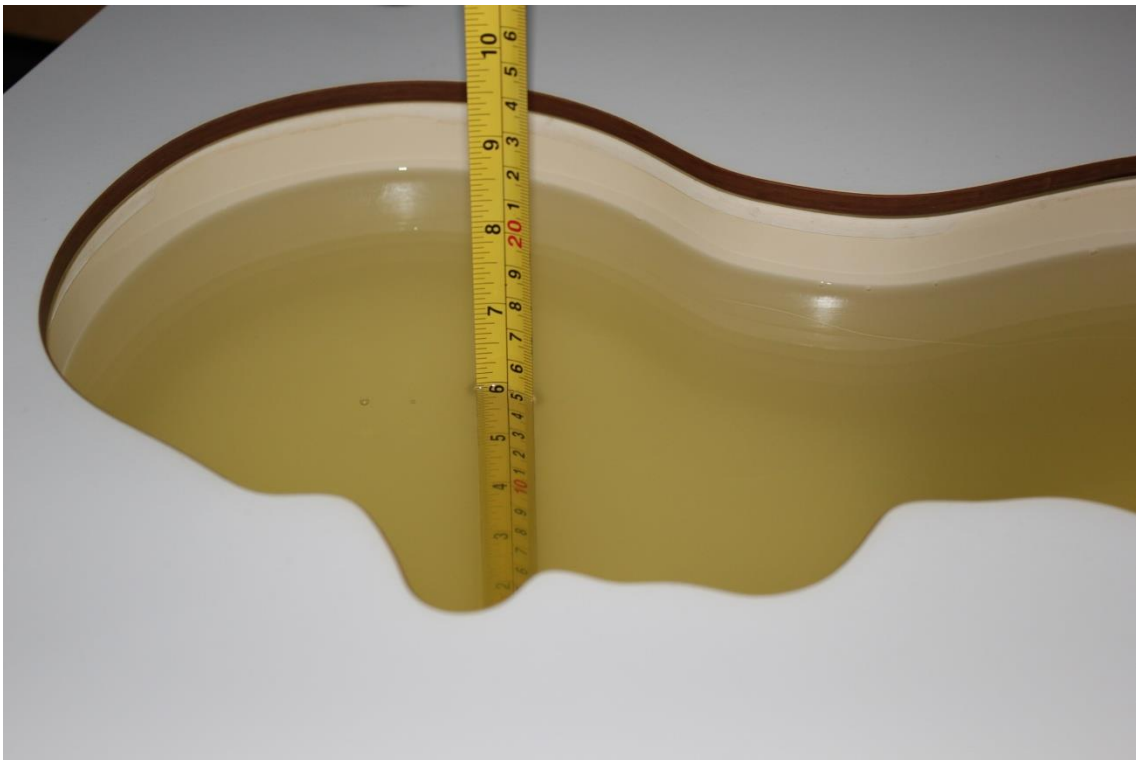
Note: The liquid temperature is 22.0°C



Picture 7-1 Liquid depth in the Head Phantom (750MHz)



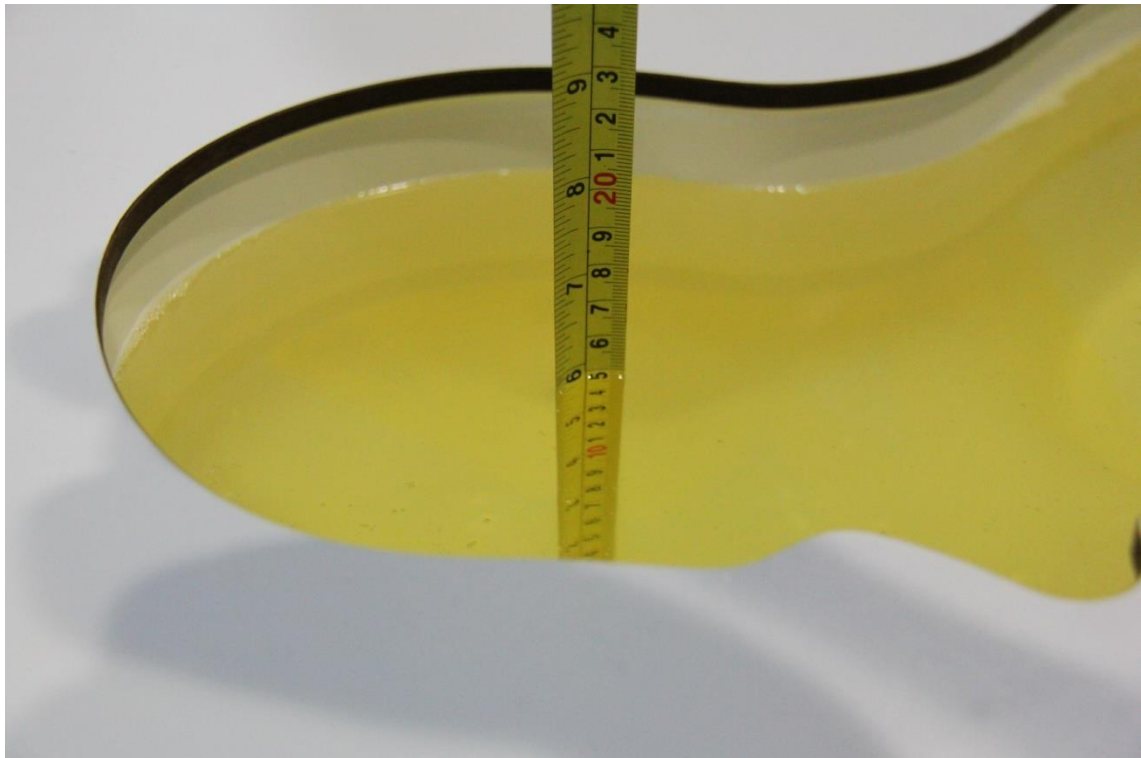
Picture 7-2 Liquid depth in the Head Phantom (835 MHz)



**Picture 7-3 Liquid depth in the Head Phantom (1750 MHz)**



**Picture 7-4 Liquid depth in the Head Phantom (1900 MHz)**



**Picture 7-5 Liquid depth in the Head Phantom (2450MHz)**



**Picture 7-6 Liquid depth in the Head Phantom (2600 MHz)**



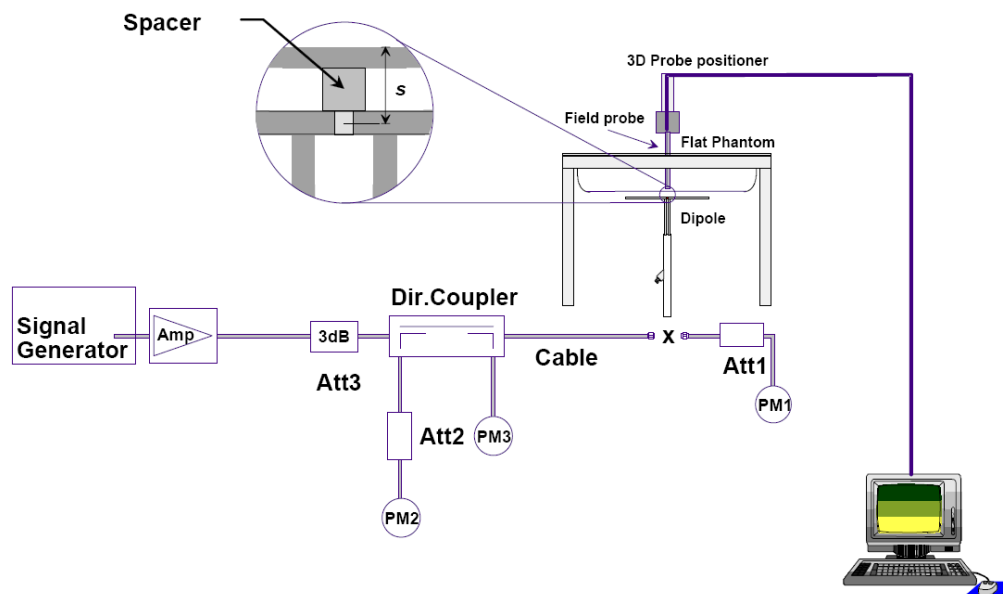
Picture 7-7 Liquid depth in the Head Phantom (5GHz)



## 8 System verification

### 8.1 System Setup

In the simplified setup for system evaluation, the DUT is replaced by a calibrated dipole and the power source is replaced by a continuous wave that comes from a signal generator. The calibrated dipole must be placed beneath the flat phantom section of the SAM twin phantom with the correct distance holder. The distance holder should touch the phantom surface with a light pressure at the reference marking and be oriented parallel to the long side of the phantom. The equipment setup is shown below:



Picture 8.1 System Setup for System Evaluation



Picture 8.2 Photo of Dipole Setup

## 8.2 System Verification

SAR system verification is required to confirm measurement accuracy, according to the tissue dielectric media, probe calibration points and other system operating parameters required for measuring the SAR of a test device. The system verification must be performed for each frequency band and within the valid range of each probe calibration point required for testing the device.

The system verification results are required that the area scan estimated 1-g SAR is within 3% of the zoom scan 1-g SAR. The details are presented in annex B.

**Table 8.1: System Verification of Head**

Measurement Date (yyyy-mm-dd)	Frequency	Target value (W/kg)		Measured value(W/kg)		Deviation	
		10 g Average	1 g Average	10 g Average	1 g Average	10 g Average	1 g Average
2021-7-18	750 MHz	5.76	8.59	5.44	8.12	-5.56%	-5.47%
2021-7-13	835 MHz	6.11	9.49	6.04	9.08	-1.15%	-4.32%
2021-7-15	1750 MHz	18.9	36.4	18.9	35.6	0.11%	-2.31%
2021-7-17	1900 MHz	20.3	40.1	19.8	38.0	-2.46%	-5.14%
2021-7-31	2450 MHz	24.0	53.1	23.4	50.0	-2.67%	-5.84%
2021-7-12	2600 MHz	25.3	57.0	24.7	55.6	-2.29%	-2.46%
2021-8-1	5250 MHz	22.5	78.5	21.4	74.8	-4.89%	-4.71%
2021-7-21	5600 MHz	23.3	81.6	23.0	77.8	-1.29%	-4.66%
2021-8-1	5600 MHz	23.3	81.6	22.4	78.0	-3.86%	-4.41%
2021-7-21	5750 MHz	21.8	76.7	21.2	74.1	-2.75%	-3.39%
2021-8-1	5750 MHz	21.8	76.7	21.3	74.5	-2.29%	-2.87%

## 9 Measurement Procedures

### 9.1 Tests to be performed

In order to determine the highest value of the peak spatial-average SAR of a handset, all device positions, configurations and operational modes shall be tested for each frequency band according to steps 1 to 3 below. A flowchart of the test process is shown in picture 9.1.

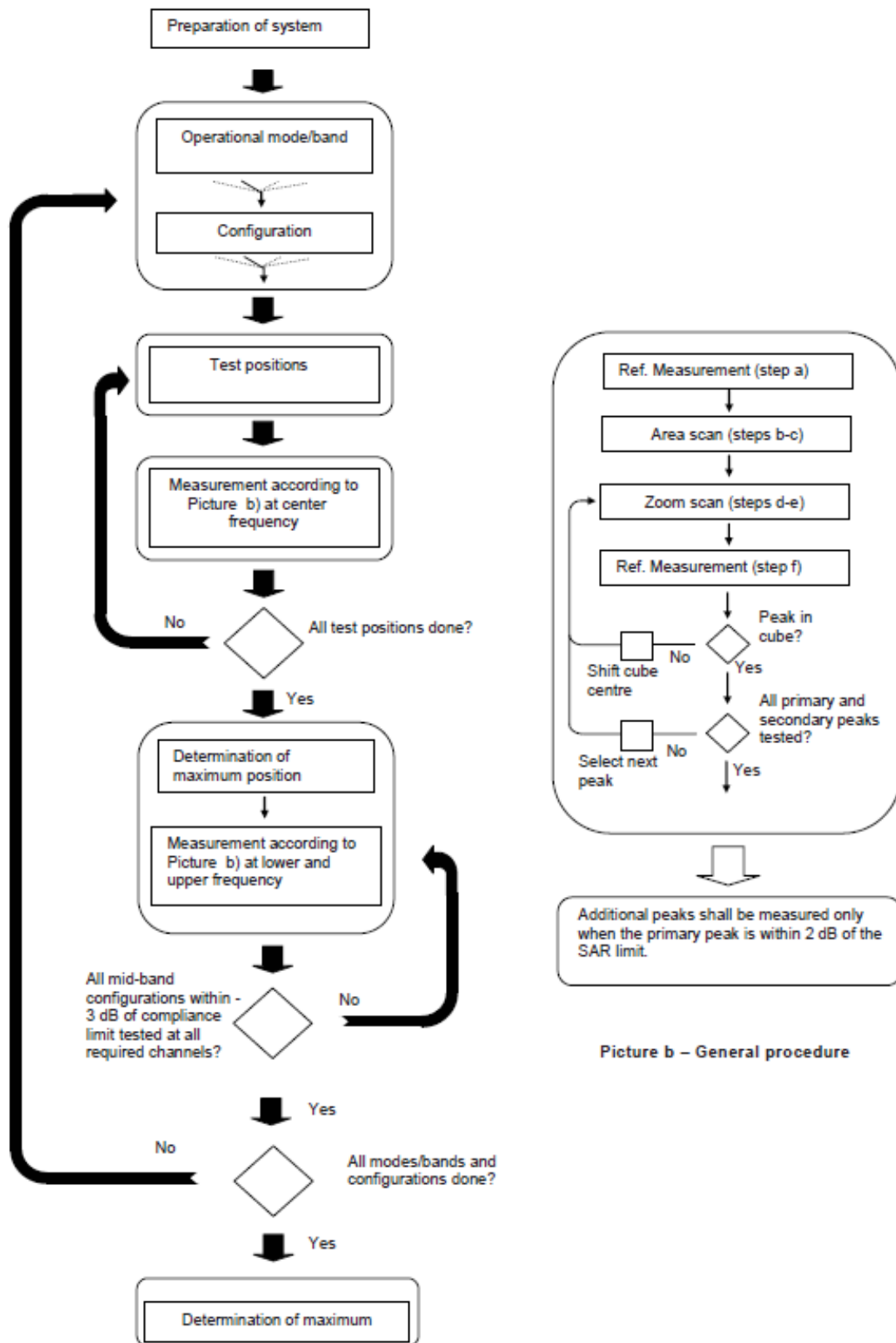
**Step 1:** The tests described in 9.2 shall be performed at the channel that is closest to the centre of the transmit frequency band ( $f_c$ ) for:

- a) all device positions (cheek and tilt, for both left and right sides of the SAM phantom, as described in annex D),
- b) all configurations for each device position in a), e.g., antenna extended and retracted, and
- c) all operational modes, e.g., analogue and digital, for each device position in a) and configuration in b) in each frequency band.

If more than three frequencies need to be tested according to 11.1 (i.e.,  $N_c > 3$ ), then all frequencies, configurations and modes shall be tested for all of the above test conditions.

**Step 2:** For the condition providing highest peak spatial-average SAR determined in Step 1, perform all tests described in 9.2 at all other test frequencies, i.e., lowest and highest frequencies. In addition, for all other conditions (device position, configuration and operational mode) where the peak spatial-average SAR value determined in Step 1 is within 3 dB of the applicable SAR limit, it is recommended that all other test frequencies shall be tested as well.

**Step 3:** Examine all data to determine the highest value of the peak spatial-average SAR found in Steps 1 to 2.



Picture a – Tests to be performed

Picture b – General procedure

Picture 9.1 Block diagram of the tests to be performed

## 9.2 General Measurement Procedure

The area and zoom scan resolutions specified in the table below must be applied to the SAR measurements and fully documented in SAR reports to qualify for TCB approval. Probe boundary effect error compensation is required for measurements with the probe tip closer than half a probe tip diameter to the phantom surface. Both the probe tip diameter and sensor offset distance must satisfy measurement protocols; to ensure probe boundary effect errors are minimized and the higher fields closest to the phantom surface can be correctly measured and extrapolated to the phantom surface for computing 1-g SAR. Tolerances of the post-processing algorithms must be verified by the test laboratory for the scan resolutions used in the SAR measurements, according to the reference distribution functions specified in IEEE Std 1528-2013. The results should be documented as part of the system validation records and may be requested to support test results when all the measurement parameters in the following table are not satisfied.

		$\leq 3$ GHz	$> 3$ GHz	
Maximum distance from closest measurement point (geometric center of probe sensors) to phantom surface		$5 \pm 1$ mm	$\frac{1}{2} \cdot \delta \cdot \ln(2) \pm 0.5$ mm	
Maximum probe angle from probe axis to phantom surface normal at the measurement location		$30^\circ \pm 1^\circ$	$20^\circ \pm 1^\circ$	
Maximum area scan spatial resolution: $\Delta x_{Area}$ , $\Delta y_{Area}$		$\leq 2$ GHz: $\leq 15$ mm 2 – 3 GHz: $\leq 12$ mm	3 – 4 GHz: $\leq 12$ mm 4 – 6 GHz: $\leq 10$ mm	
		When the x or y dimension of the test device, in the measurement plane orientation, is smaller than the above, the measurement resolution must be $\leq$ the corresponding x or y dimension of the test device with at least one measurement point on the test device.		
Maximum zoom scan spatial resolution: $\Delta x_{Zoom}$ , $\Delta y_{Zoom}$		$\leq 2$ GHz: $\leq 8$ mm 2 – 3 GHz: $\leq 5$ mm*	3 – 4 GHz: $\leq 5$ mm* 4 – 6 GHz: $\leq 4$ mm*	
Maximum zoom scan spatial resolution, normal to phantom surface	uniform grid: $\Delta z_{Zoom}(n)$	$\leq 5$ mm	3 – 4 GHz: $\leq 4$ mm 4 – 5 GHz: $\leq 3$ mm 5 – 6 GHz: $\leq 2$ mm	
	graded grid	$\Delta z_{Zoom}(1)$ : between 1 <sup>st</sup> two points closest to phantom surface	$\leq 4$ mm	3 – 4 GHz: $\leq 3$ mm 4 – 5 GHz: $\leq 2.5$ mm 5 – 6 GHz: $\leq 2$ mm
		$\Delta z_{Zoom}(n>1)$ : between subsequent points	$\leq 1.5 \cdot \Delta z_{Zoom}(n-1)$	
Minimum zoom scan volume	x, y, z	$\geq 30$ mm	3 – 4 GHz: $\geq 28$ mm 4 – 5 GHz: $\geq 25$ mm 5 – 6 GHz: $\geq 22$ mm	
Note: $\delta$ is the penetration depth of a plane-wave at normal incidence to the tissue medium; see draft standard IEEE P1528-2011 for details. * When zoom scan is required and the <i>reported</i> SAR from the area scan based 1-g SAR estimation procedures of KDB 447498 is $\leq 1.4$ W/kg, $\leq 8$ mm, $\leq 7$ mm and $\leq 5$ mm zoom scan resolution may be applied, respectively, for 2 GHz to 3 GHz, 3 GHz to 4 GHz and 4 GHz to 6 GHz.				

### 9.3 WCDMA Measurement Procedures for SAR

The following procedures are applicable to WCDMA handsets operating under 3GPP Release99, Release 5 and Release 6. The default test configuration is to measure SAR with an established radio link between the DUT and a communication test set using a 12.2kbps RMC (reference measurement channel) configured in Test Loop Mode 1. SAR is selectively confirmed for other physical channel configurations (DPCCH & DPDCH<sub>n</sub>), HSDPA and HSPA (HSUPA/HSDPA) modes according to output power, exposure conditions and device operating capabilities. Both uplink and downlink should be configured with the same RMC or AMR, when required. SAR for Release 5 HSDPA and Release 6 HSPA are measured using the applicable FRC (fixed reference channel) and E-DCH reference channel configurations. Maximum output power is verified according to applicable versions of 3GPP TS 34.121 and SAR must be measured according to these maximum output conditions. When Maximum Power Reduction (MPR) is not implemented according to Cubic Metric (CM) requirements for Release 6 HSPA, the following procedures do not apply.

#### For Release 5 HSDPA Data Devices:

Sub-test	$\beta_c$	$\beta_d$	$\beta_d$ (SF)	$\beta_c / \beta_d$	$\beta_{hs}$	CM/dB
1	2/15	15/15	64	2/15	4/15	0.0
2	12/15	15/15	64	12/15	24/25	1.0
3	15/15	8/15	64	15/8	30/15	1.5
4	15/15	4/15	64	15/4	30/15	1.5

#### For Release 6 HSPA Data Devices

Sub-test	$\beta_c$	$\beta_d$	$\beta_d$ (SF)	$\beta_c / \beta_d$	$\beta_{hs}$	$\beta_{ec}$	$\beta_{ed}$	$\beta_{ed}$ (SF)	$\beta_{ed}$ (codes)	CM (dB)	MPR (dB)	AG Index	E-TFCI
1	11/15	15/15	64	11/15	22/15	209/225	1039/225	4	1	1.5	1.5	20	75
2	6/15	15/15	64	6/15	12/15	12/15	12/15	4	1	1.5	1.5	12	67
3	15/15	9/15	64	15/9	30/15	30/15	$\beta_{ed1}:47/15$ $\beta_{ed2}:47/15$	4	2	1.5	1.5	15	92
4	2/15	15/15	64	2/15	4/15	4/15	56/75	4	1	1.5	1.5	17	71
5	15/15	15/15	64	15/15	24/15	30/15	134/15	4	1	1.5	1.5	21	81

#### Rel.8 DC-HSDPA (Cat 24)

SAR test exclusion for Rel.8 DC-HSDPA must satisfy the SAR test exclusion requirements of Rel.5 HSDPA. SAR test exclusion for DC-HSDPA devices is determined by power measurements according to the H-Set 12, Fixed Reference Channel (FRC) configuration in Table C.8.1.12 of 3GPP TS 34.121-1. A primary and a secondary serving HS-DSCH Cell are required to perform the power measurement and for the results to qualify for SAR test exclusion.

## 9.4 SAR Measurement for LTE

SAR tests for LTE are performed with a base station simulator, Rohde & Schwarz CMW500. Closed loop power control was used so the UE transmits with maximum output power during SAR testing. All powers were measured with the CMW 500.

It is performed for conducted power and SAR based on the KDB941225 D05.

SAR is evaluated separately according to the following procedures for the different test positions in each exposure condition – head, body, body-worn accessories and other use conditions. The procedures in the following subsections are applied separately to test each LTE frequency band.

### 1) QPSK with 1 RB allocation

Start with the largest channel bandwidth and measure SAR for QPSK with 1 RB allocation, using the RB offset and required test channel combination with the highest maximum output power among RB offsets at the upper edge, middle and lower edge of each required test channel. When the reported SAR is  $\leq 0.8$  W/kg, testing of the remaining RB offset configurations and required test channels is not required for 1 RB allocation; otherwise, SAR is required for the remaining required test channels and only for the RB offset configuration with the highest output power for that channel. When the reported SAR of a required test channel is  $> 1.45$  W/kg, SAR is required for all three RB offset configurations for that required test channel.

### 2) QPSK with 50% RB allocation

The procedures required for 1 RB allocation in 1) are applied to measure the SAR for QPSK with 50% RB allocation.

### 3) QPSK with 100% RB allocation

For QPSK with 100% RB allocation, SAR is not required when the highest maximum output power for 100 % RB allocation is less than the highest maximum output power in 50% and 1 RB allocations and the highest reported SAR for 1 RB and 50% RB allocation in 1) and 2) are  $\leq 0.8$  W/kg. Otherwise, SAR is measured for the highest output power channel; and if the reported SAR is  $> 1.45$  W/kg, the remaining required test channels must also be tested.

## TDD test:

TDD testing is performed using guidance from FCC KDB 941225 D05 and the SAR test guidance provided in April 2013 TCB works hop notes. TDD is tested at the highest duty factor using UL-DL configuration 0 with special subframe configuration 6 and applying the FDD LTE procedures in KDB 941225 D05. SAR testing is performed using the extended cyclic prefix listed in 3GPP TS 36.211.

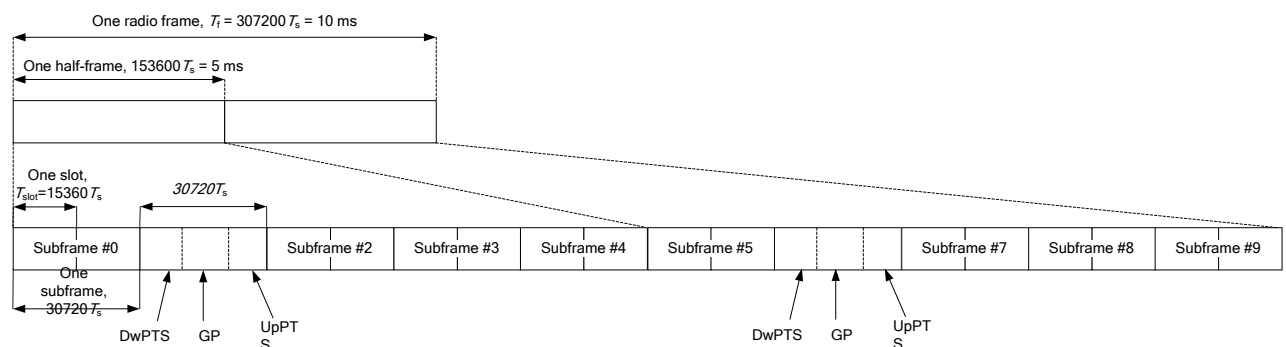


Figure 9.2: Frame structure type 2 (for 5 ms switch-point periodicity)

**Table 9.1: Configuration of special subframe (lengths of DwPTS/GP/UpPTS)**

Special subframe configuration	Normal cyclic prefix in downlink			Extended cyclic prefix in downlink		
	DwPTS	UpPTS		DwPTS	UpPTS	
		Normal cyclic prefix in uplink	Extended cyclic prefix in uplink		Normal cyclic prefix in uplink	Extended cyclic prefix in uplink
0	$6592 \cdot T_s$	$2192 \cdot T_s$	$2560 \cdot T_s$	$7680 \cdot T_s$	$2192 \cdot T_s$	$2560 \cdot T_s$
1	$19760 \cdot T_s$			$20480 \cdot T_s$		
2	$21952 \cdot T_s$			$23040 \cdot T_s$		
3	$24144 \cdot T_s$			$25600 \cdot T_s$		
4	$26336 \cdot T_s$	$4384 \cdot T_s$	$5120 \cdot T_s$	$7680 \cdot T_s$	$4384 \cdot T_s$	$5120 \cdot T_s$
5	$6592 \cdot T_s$			$20480 \cdot T_s$		
6	$19760 \cdot T_s$			$23040 \cdot T_s$		
7	$21952 \cdot T_s$			$12800 \cdot T_s$		
8	$24144 \cdot T_s$			-		
9	$13168 \cdot T_s$	-	-	-	-	-

**Table 9.2: Uplink-downlink configurations**

Uplink-downlink configuration	Downlink-to-Uplink Switch-point periodicity	Subframe number										
		0	1	2	3	4	5	6	7	8	9	
0	5 ms	D	S	U	U	U	D	S	U	U	U	
1	5 ms	D	S	U	U	D	D	S	U	U	D	
2	5 ms	D	S	U	D	D	D	S	U	D	D	
3	10 ms	D	S	U	U	U	D	D	D	D	D	
4	10 ms	D	S	U	U	D	D	D	D	D	D	
5	10 ms	D	S	U	D	D	D	D	D	D	D	
6	5 ms	D	S	U	U	U	D	S	U	U	D	

Duty factor is calculated by:

$$\begin{aligned}
 \text{Duty factor} &= \text{uplink frame} \cdot 6 + \text{UpPTS} \cdot 2 / \text{one frame length} \\
 &= (30720 \cdot T_s \cdot 6 + 5120 \cdot T_s \cdot 2) / 307200 \cdot T_s \\
 &= 0.633
 \end{aligned}$$



## 9.5 Bluetooth & Wi-Fi Measurement Procedures for SAR

Normal network operating configurations are not suitable for measuring the SAR of 802.11 transmitters in general. Unpredictable fluctuations in network traffic and antenna diversity conditions can introduce undesirable variations in SAR results. The SAR for these devices should be measured using chipset based test mode software to ensure that the results are consistent and reliable.

Chipset based test mode software is hardware dependent and generally varies among manufacturers. The device operating parameters established in a test mode for SAR measurements must be identical to those programmed in production units, including output power levels, amplifier gain settings and other RF performance tuning parameters. The test frequencies should correspond to actual channel frequencies defined for domestic use. SAR for devices with switched diversity should be measured with only one antenna transmitting at a time during each SAR measurement, according to a fixed modulation and data rate. The same data pattern should be used for all measurements.

## 9.6 Power Drift

To control the output power stability during the SAR test, DASY4 system calculates the power drift by measuring the E-field at the same location at the beginning and at the end of the measurement for each test position. These drift values can be found in section 14 labeled as: (Power Drift [dB]). This ensures that the power drift during one measurement is within 5%.

## 10 Area Scan Based 1-g SAR

### 10.1 Requirement of KDB

According to the KDB447498 D01 v06, when the implementation is based the specific polynomial fit algorithm as presented at the 29th Bioelectromagnetics Society meeting (2007) and the estimated 1-gSAR is  $\leq 1.2$  W/kg, a zoom scan measurement is not required provided it is also not needed for any other purpose; for example, if the peak SAR location required for simultaneous transmission SAR test exclusion can be determined accurately by the SAR system or manually to discriminate between distinctive peaks and scattered noisy SAR distributions from area scans.

There must not be any warning or alert messages due to various measurement concerns identified by the SAR system; for example, noise in measurements, peaks too close to scan boundary, peaks are too sharp, spatial resolution and uncertainty issues etc. The SAR system verification must also demonstrate that the area scan estimated 1-g SAR is within 3% of the zoom scan 1-g SAR (See Annex B). When all the SAR results for each exposure condition in a frequency band and wireless mode are based on estimated 1-g SAR, the 1-g SAR for the highest SAR configuration must be determined by a zoom scan.

### 10.2 Fast SAR Algorithms

The approach is based on the area scan measurement applying a frequency dependent attenuation parameter. This attenuation parameter was empirically determined by analyzing a large number of phones. The MOTOROLA FAST SAR was developed and validated by the MOTOROLA Research Group in Ft. Lauderdale.

In the initial study, an approximation algorithm based on Linear fit was developed. The accuracy of the algorithm has been demonstrated across a broad frequency range (136-2450 MHz) and for both 1- and 10-g averaged SAR using a sample of 264 SAR measurements from 55 wireless handsets. For the sample size studied, the root-mean-squared errors of the algorithm are 1.2% and 5.8% for 1- and 10-g averaged SAR, respectively. The paper describing the algorithm in detail is expected to be published in August 2004 within the Special Issue of Transactions on MTT.

In the second step, the same research group optimized the fitting algorithm to an Polynomial fit whereby the frequency validity was extended to cover the range 30-6000MHz. Details of this study can be found in the BEMS 2007 Proceedings.

Both algorithms are implemented in DASY software.

## 11 Conducted Output Power

**Table: Summary of Receiver detection mechanism**

Antenna	Sensor deactive (head scenario+ Body scenario)	Sensor active (Body scenario)
Main antenna	Power Level A1	Power Level B1

### 11.1 GSM Measurement result

During the process of testing, the EUT was controlled via Agilent Digital Radio Communication tester (E5515C) to ensure the maximum power transmission and proper modulation. This result contains conducted output power for the EUT. In all cases, the measured peak output power should be greater and within 5% than EMI measurement.

**Table 11.1-1: The conducted power measurement results for GSM, GPRS and EGPRS- Level A1/B1**

GSM 850 Speech (GMSK)	Measured Power (dBm)			Tune up	calculation	Averaged Power (dBm)		
	251	190	128			251	190	128
1 Txslot	32.70	32.74	32.72	33.50	/	/	/	/
GSM 850 GPRS (GMSK)	Measured Power (dBm)				calculation	Averaged Power (dBm)		
	251	190	128			251	190	128
1 Txslot	32.40	32.42	32.38	33.50	-9.03	23.37	23.39	23.35
<b>2 Txslots</b>	<b>31.42</b>	<b>31.46</b>	<b>31.43</b>	<b>32.50</b>	<b>-6.02</b>	<b>25.40</b>	<b>25.44</b>	<b>25.41</b>
3Txslots	29.41	29.45	29.45	30.50	-4.26	25.15	25.19	25.19
4 Txslots	28.34	28.40	28.39	29.50	-3.01	25.33	25.39	25.38
GSM 850 EGPRS (GMSK)	Measured Power (dBm)				calculation	Averaged Power (dBm)		
	251	190	128			251	190	128
1 Txslot	32.40	32.42	32.38	33.50	-9.03	23.37	23.39	23.35
2 Txslots	31.42	31.46	31.44	32.50	-6.02	25.40	25.44	25.42
3Txslots	29.41	29.45	29.45	30.50	-4.26	25.15	25.19	25.19
4 Txslots	28.34	28.40	28.39	29.50	-3.01	25.33	25.39	25.38
GSM 850 EGPRS (8PSK)	Measured Power (dBm)				calculation	Averaged Power (dBm)		
	251	190	128			251	190	128
1 Txslot	25.82	25.75	26.19	27.00	-9.03	16.79	16.72	17.16
2 Txslots	24.63	25.93	25.03	26.00	-6.02	18.61	19.91	19.01
3Txslots	23.73	23.05	23.65	24.50	-4.26	19.47	18.79	19.39
4 Txslots	21.75	21.52	21.86	22.50	-3.01	18.74	18.51	18.85

NOTES:

1) Division Factors

To average the power, the division factor is as follows:

1TX-slot = 1 transmit time slot out of 8 time slots=> conducted power divided by (8/1) => -9.03dB

2TX-slots = 2 transmit time slots out of 8 time slots=> conducted power divided by (8/2) => -6.02dB

3TX-slots = 3 transmit time slots out of 8 time slots=> conducted power divided by (8/3) => -4.26dB

4TX-slots = 4 transmit time slots out of 8 time slots=> conducted power divided by (8/4) => -3.01dB

According to the conducted power as above, the body measurements are performed with 2Txslots for GSM850.

**Table 11.1-2: The conducted power measurement results for GSM, GPRS and EGPRS- Level**

A1

PCS1900 Speech (GMSK)	Measured Power (dBm)			Tune up	calculation	Averaged Power (dBm)		
	810	661	512			810	661	512
1 Txslot	28.93	28.73	28.99	30.00	/	/	/	/
PCS1900 GPRS (GMSK)	Measured Power (dBm)				calculation	Averaged Power (dBm)		
	810	661	512			810	661	512
1 Txslot	28.92	28.72	28.98	30.00	-9.03	19.89	19.69	19.95
<b>2 Txslots</b>	<b>28.11</b>	<b>27.87</b>	<b>28.07</b>	<b>29.00</b>	<b>-6.02</b>	<b>22.09</b>	<b>21.85</b>	<b>22.05</b>
3Txslots	26.14	25.92	26.11	27.00	-4.26	21.88	21.66	21.85
4 Txslots	25.09	24.84	25.01	26.00	-3.01	22.08	21.83	22.00
PCS1900 EGPRS (GMSK)	Measured Power (dBm)				calculation	Averaged Power (dBm)		
	810	661	512			810	661	512
1 Txslot	28.92	28.72	28.97	30.00	-9.03	19.89	19.69	19.94
2 Txslots	28.07	27.84	28.07	29.00	-6.02	22.05	21.82	22.05
3Txslots	26.13	25.92	26.11	27.00	-4.26	21.87	21.66	21.85
4 Txslots	25.09	24.84	25.01	26.00	-3.01	22.08	21.83	22.00
PCS1900 EGPRS (8PSK)	Measured Power (dBm)				calculation	Averaged Power (dBm)		
	810	661	512			810	661	512
1 Txslot	24.43	24.52	24.76	25.50	-9.03	15.40	15.49	15.73
2 Txslots	23.79	23.96	23.52	24.50	-6.02	17.77	17.94	17.50
3Txslots	21.37	21.43	21.29	22.50	-4.26	17.11	17.17	17.03
4 Txslots	20.13	20.20	20.16	21.00	-3.01	17.12	17.19	17.15

NOTES:

1) Division Factors

To average the power, the division factor is as follows:

1TX-slot = 1 transmit time slot out of 8 time slots=> conducted power divided by (8/1) => -9.03dB

2TX-slots = 2 transmit time slots out of 8 time slots=> conducted power divided by (8/2) => -6.02dB

3TX-slots = 3 transmit time slots out of 8 time slots=> conducted power divided by (8/3) => -4.26dB

4TX-slots = 4 transmit time slots out of 8 time slots=> conducted power divided by (8/4) => -3.01dB

According to the conducted power as above, the body measurements are performed with 2Txslots for GSM1900.

**Table 11.1-3: The conducted power measurement results for GSM, GPRS and EGPRS- Level B1**

PCS1900 Speech (GMSK)	Measured Power (dBm)			Tune up	calculation	Averaged Power (dBm)		
	810	661	512			810	661	512
1 Txslot	26.33	26.21	26.25	27.00	/	/	/	/
PCS1900 GPRS (GMSK)	Measured Power (dBm)				calculation	Averaged Power (dBm)		
	810	661	512			810	661	512
1 Txslot	26.33	26.21	26.25	27.00	-9.03	17.30	17.18	17.22
2 Txslots	25.54	25.42	25.44	26.00	-6.02	19.52	19.40	19.42
3Txslots	23.78	23.65	23.63	24.00	-4.26	19.52	19.39	19.37
<b>4 Txslots</b>	<b>22.80</b>	<b>22.66</b>	<b>22.58</b>	<b>23.00</b>	<b>-3.01</b>	<b>19.79</b>	<b>19.65</b>	<b>19.57</b>
PCS1900 EGPRS (GMSK)	Measured Power (dBm)				calculation	Averaged Power (dBm)		
	810	661	512			810	661	512
1 Txslot	26.32	26.21	26.22	27.00	-9.03	17.29	17.18	17.19
2 Txslots	25.53	25.41	25.41	26.00	-6.02	19.51	19.39	19.39
3Txslots	23.77	23.65	23.60	24.00	-4.26	19.51	19.39	19.34
4 Txslots	22.79	22.66	22.54	23.00	-3.01	19.78	19.65	19.53
PCS1900 EGPRS (8PSK)	Measured Power (dBm)				calculation	Averaged Power (dBm)		
	810	661	512			810	661	512
1 Txslot	22.98	23.15	22.77	23.50	-9.03	13.95	14.12	13.74
2 Txslots	21.78	21.84	21.68	22.50	-6.02	15.76	15.82	15.66
3Txslots	19.64	19.64	19.53	20.50	-4.26	15.38	15.38	15.27
4 Txslots	18.38	18.41	18.61	20.00	-3.01	15.37	15.40	15.60

NOTES:

1) Division Factors

To average the power, the division factor is as follows:

1TX-slot = 1 transmit time slot out of 8 time slots=> conducted power divided by (8/1) => -9.03dB

2TX-slots = 2 transmit time slots out of 8 time slots=> conducted power divided by (8/2) => -6.02dB

3TX-slots = 3 transmit time slots out of 8 time slots=> conducted power divided by (8/3) => -4.26dB

4TX-slots = 4 transmit time slots out of 8 time slots=> conducted power divided by (8/4) => -3.01dB

**According to the conducted power as above, the body measurements are performed with 4Txslots for GSM1900.**

## 11.2 WCDMA Measurement result

Table 11.2-1: The conducted Power for WCDMA- Level A1/B1

Item	band	FDDV result			
	ARFCN	4233 (846.6MHz)	4182 (836.4MHz)	4132 (826.4MHz)	Tune up
WCDMA	\	23.49	23.44	23.48	25.00
HSUPA	1	20.56	20.47	20.47	21.50
	2	20.52	20.46	20.43	21.50
	3	21.5	20.47	21.46	22.00
	4	20.06	19.99	19.97	21.00
	5	21.44	21.43	21.43	22.50
DC-HSDPA	1	21.62	21.60	21.63	22.00
	2	21.42	21.42	21.61	22.00
	3	21.1	21.09	21.12	22.00
	4	21.01	21.06	21.08	22.00

Table 11.2-2: The conducted Power for WCDMA- Level A1

Item	band	FDDIV result			
	ARFCN	1513 (1752.6MHz)	1412(1732.4MHz)	1312 (1712.4MHz)	Tune up
WCDMA	\	23.56	23.49	23.38	25.00
HSUPA	1	20.29	20.32	20.33	21.50
	2	20.29	20.33	20.32	21.50
	3	21.33	21.32	21.31	22.00
	4	19.84	19.86	19.84	21.00
	5	21.28	21.27	21.26	22.50
DC-HSDPA	1	21.37	21.47	21.40	22.00
	2	21.21	21.33	21.33	22.00
	3	20.8	20.92	20.88	22.00
	4	20.86	20.92	20.85	22.00
Item	band	FDDII result			
	ARFCN	9538 (1907.6MHz)	9400 (1880MHz)	9262 (1852.4MHz)	Tune up
WCDMA	\	23.39	23.46	23.51	24.50
HSUPA	1	20.19	20.22	20.28	21.50
	2	20.18	20.20	20.24	21.50
	3	21.15	21.20	21.28	22.00
	4	19.71	19.73	19.77	21.00
	5	21.26	21.26	21.25	22.50
DC-HSDPA	1	21.31	21.34	21.42	22.00
	2	21.11	21.21	21.38	22.00
	3	20.75	20.80	20.90	22.00
	4	20.75	20.77	20.93	22.00

Table 11.2-3: The conducted Power for WCDMA- Level B1

Item	band	FDDIV result			
	ARFCN	1513 (1752.6MHz)	1412(1732.4MHz)	1312 (1712.4MHz)	Tune up
WCDMA	\	20.42	20.36	20.44	22.00
HSUPA	1	18.75	18.73	18.77	20.50
	2	18.74	18.76	18.77	20.50
	3	18.74	18.74	18.79	21.50
	4	18.72	18.78	18.79	20.00
	5	18.73	18.75	18.78	21.50
DC-HSDPA	1	19.33	19.35	19.35	21.50
	2	19.1	19.12	19.15	21.50
	3	18.74	18.74	18.77	21.50
	4	18.77	18.73	18.74	21.50
Item	band	FDDII result			
	ARFCN	9538 (1907.6MHz)	9400 (1880MHz)	9262 (1852.4MHz)	Tune up
WCDMA	\	19.30	19.27	19.35	19.50
HSUPA	1	17.56	17.61	17.70	18.00
	2	17.58	17.61	17.68	18.00
	3	17.58	17.61	17.71	19.00
	4	17.58	17.60	17.70	17.50
	5	17.58	17.61	17.73	19.00
DC-HSDPA	1	18.13	18.15	18.25	19.00
	2	17.98	17.99	18.17	19.00
	3	17.58	17.61	17.74	19.00
	4	17.56	17.56	17.68	19.00

### 11.3 LTE Measurement result

**Table 13.3-1: Maximum Power Reduction (MPR) for LTE**

Modulation	Channel bandwidth / Transmission bandwidth configuration [RB]						MPR (dB)
	1.4 MHz	3 MHz	5 MHz	10 MHz	15 MHz	20 MHz	
QPSK	> 5	> 4	> 8	> 12	> 16	> 18	1
16 QAM	≤ 5	≤ 4	≤ 8	≤ 12	≤ 16	≤ 18	1
16 QAM	> 5	> 4	> 8	> 12	> 16	> 18	2
64 QAM	≤ 5	≤ 4	≤ 8	≤ 12	≤ 16	≤ 18	2
64 QAM	> 5	> 4	> 8	> 12	> 16	> 18	3

**Table 13.3-2: The tune up for LTE –Level A1/B1**

Band	Tune up
LTE Band 12	25
LTE Band 41(PC2)	28
LTE Band 41(PC3)	25
LTE Band 71	25

**Table 13.3-3: The tune up for LTE –Level A1**

Band	Tune up
LTE Band 25	25
LTE Band 26	25
LTE Band 66	25

**Table 13.3-4: The tune up for LTE – Level B1**

Band	Tune up
LTE Band 25	20.5
LTE Band 26	24
LTE Band 66	22



## Power Level A1/B1

Band 12						
Bandwidth (MHz)	RB allocation	Frequency (MHz)	QPSK	16QAM	64QAM	
	RB offset (Start RB)		Actual output power (dBm)	Actual output power (dBm)	Actual output power (dBm)	
1.4 MHz	1RB High (5)	715.3	24.31	23.53	22.44	
		707.5	24.34	23.61	22.52	
		699.7	24.42	23.69	22.57	
	1RB Middle (3)	715.3	24.47	23.59	22.60	
		707.5	24.44	23.77	22.56	
		699.7	24.51	23.77	22.63	
	1RB Low (0)	715.3	24.32	23.50	22.44	
		707.5	24.33	23.63	22.52	
		699.7	24.45	23.70	22.59	
	3RB High (3)	715.3	24.46	23.31	22.51	
		707.5	24.46	23.35	22.56	
		699.7	24.56	23.48	22.58	
	3RB Middle (1)	715.3	24.46	23.39	22.54	
		707.5	24.50	23.45	22.54	
		699.7	24.55	23.57	22.62	
	3RB Low (0)	715.3	24.46	23.33	22.48	
		707.5	24.43	23.44	22.53	
		699.7	24.53	23.43	22.60	
	6RB (0)	715.3	23.47	22.52	21.40	
		707.5	23.44	22.51	21.43	
		699.7	23.54	22.59	21.54	
	3 MHz	1RB High (14)	714.5	24.38	23.57	22.53
			707.5	24.34	23.56	22.60
			700.5	24.49	23.73	22.63
		1RB Middle (7)	714.5	24.55	23.63	22.71
			707.5	24.56	23.88	22.74
			700.5	24.66	23.96	22.75
1RB Low (0)		714.5	24.39	23.61	22.49	
		707.5	24.41	23.59	22.60	
		700.5	24.51	23.80	22.60	
8RB High (7)		714.5	23.44	22.45	21.49	
		707.5	23.44	22.47	21.47	
		700.5	23.52	22.56	21.58	
8RB Middle (4)		714.5	23.51	22.51	21.52	
		707.5	23.49	22.53	21.52	
		700.5	23.58	22.59	21.63	
8RB Low (0)		714.5	23.43	22.49	21.47	
		707.5	23.45	22.50	21.52	
		700.5	23.54	22.57	21.61	
15RB (0)		714.5	23.44	22.42	21.41	
		707.5	23.43	22.44	21.44	
		700.5	23.54	22.54	21.54	

5 MHz	1RB High (24)	713.5	24.31	23.47	22.44	
		707.5	24.33	23.55	22.45	
		701.5	24.38	23.54	22.49	
	1RB Middle (12)	713.5	24.57	23.68	22.74	
		707.5	24.66	23.81	22.75	
		701.5	24.68	23.85	22.85	
	1RB Low (0)	713.5	24.34	23.54	22.47	
		707.5	24.41	23.66	22.58	
		701.5	24.44	23.67	22.62	
	12RB High (13)	713.5	23.45	22.41	21.48	
		707.5	23.44	22.42	21.46	
		701.5	23.51	22.49	21.59	
	12RB Middle (6)	713.5	23.49	22.48	21.52	
		707.5	23.51	22.51	21.53	
		701.5	23.60	22.57	21.61	
	12RB Low (0)	713.5	23.52	22.47	21.51	
		707.5	23.51	22.48	21.50	
		701.5	23.58	22.56	21.58	
	25RB (0)	713.5	23.51	22.47	21.49	
		707.5	23.49	22.48	21.49	
		701.5	23.56	22.55	21.57	
	10 MHz	1RB High (49)	711	24.24	23.38	22.50
			707.5	24.21	23.36	22.59
			704	24.27	23.49	22.56
1RB Middle (24)		711	24.35	23.66	22.71	
		707.5	24.42	23.73	22.75	
		704	24.47	23.67	22.74	
1RB Low (0)		711	24.32	23.49	22.63	
		707.5	24.38	23.57	22.75	
		704	24.38	23.65	22.72	
25RB High (25)		711	23.33	22.30	21.48	
		707.5	23.34	22.30	21.51	
		704	23.40	22.40	21.56	
25RB Middle (12)		711	23.38	22.37	21.57	
		707.5	23.40	22.42	21.55	
		704	23.45	22.42	21.61	
25RB Low (0)		711	23.44	22.42	21.57	
		707.5	23.44	22.43	21.58	
		704	23.51	22.48	21.65	
50RB (0)		711	23.36	22.37	21.56	
		707.5	23.37	22.38	21.56	
		704	23.47	22.45	21.57	

## Power Level A1

Band 25						
Bandwidth (MHz)	RB allocation	Frequency (MHz)	QPSK	16QAM	64QAM	
	RB offset (Start RB)		Actual output power (dBm)	Actual output power (dBm)	Actual output power (dBm)	
1.4 MHz	1RB High (5)	1914.3	24.09	23.28	22.27	
		1882.5	24.15	23.50	22.34	
		1850.7	24.13	23.36	22.33	
	1RB Middle (3)	1914.3	24.18	23.46	22.42	
		1882.5	24.29	23.58	22.40	
		1850.7	24.26	23.63	22.42	
	1RB Low (0)	1914.3	24.08	23.32	22.27	
		1882.5	24.12	23.43	22.34	
		1850.7	24.11	23.40	22.34	
	3RB High (3)	1914.3	24.19	23.16	22.27	
		1882.5	24.26	23.28	22.33	
		1850.7	24.25	23.24	22.30	
	3RB Middle (1)	1914.3	24.27	23.25	22.35	
		1882.5	24.31	23.30	22.39	
		1850.7	24.29	23.33	22.39	
	3RB Low (0)	1914.3	24.21	23.08	22.30	
		1882.5	24.26	23.27	22.36	
		1850.7	24.21	23.25	22.32	
	6RB (0)	1914.3	23.32	22.35	21.25	
		1882.5	23.31	22.39	21.30	
		1850.7	23.30	22.35	21.22	
	3 MHz	1RB High (14)	1913.5	24.16	23.40	22.40
			1882.5	24.25	23.55	22.39
			1851.5	24.21	23.53	22.40
		1RB Middle (7)	1913.5	24.34	23.58	22.63
			1882.5	24.44	23.76	22.63
			1851.5	24.39	23.69	22.59
1RB Low (0)		1913.5	24.23	23.45	22.48	
		1882.5	24.24	23.46	22.45	
		1851.5	24.21	23.56	22.39	
8RB High (7)		1913.5	23.26	22.33	21.30	
		1882.5	23.33	22.35	21.33	
		1851.5	23.30	22.36	21.30	
8RB Middle (4)		1913.5	23.34	22.36	21.37	
		1882.5	23.38	22.38	21.41	
		1851.5	23.33	22.39	21.33	
8RB Low (0)		1913.5	23.31	22.38	21.34	
		1882.5	23.35	22.37	21.34	
		1851.5	23.31	22.35	21.34	
15RB (0)		1913.5	23.32	22.31	21.28	
		1882.5	23.35	22.30	21.29	

5 MHz	1RB High (24)	1851.5	23.30	22.29	21.31	
		1912.5	24.07	23.29	22.26	
		1882.5	24.14	23.46	22.36	
	1RB Middle (12)	1852.5	24.10	23.47	22.40	
		1912.5	24.37	23.58	22.59	
		1882.5	24.38	23.76	22.68	
	1RB Low (0)	1852.5	24.38	23.69	22.70	
		1912.5	24.17	23.39	22.38	
		1882.5	24.14	23.45	22.36	
	12RB High (13)	1852.5	24.16	23.43	22.44	
		1912.5	23.25	22.25	21.27	
		1882.5	23.31	22.28	21.29	
	12RB Middle (6)	1852.5	23.31	22.27	21.31	
		1912.5	23.37	22.37	21.35	
		1882.5	23.38	22.37	21.42	
	12RB Low (0)	1852.5	23.37	22.32	21.33	
		1912.5	23.37	22.37	21.35	
		1882.5	23.35	22.32	21.34	
	25RB (0)	1852.5	23.30	22.28	21.29	
		1912.5	23.34	22.32	21.31	
		1882.5	23.35	22.33	21.31	
	10 MHz	1RB High (49)	1852.5	23.32	22.30	21.28
			1910	24.17	23.38	22.37
			1882.5	24.23	23.48	22.19
		1RB Middle (24)	1855	24.19	23.46	22.47
			1910	24.38	23.67	22.58
			1882.5	24.35	23.60	22.39
1RB Low (0)		1855	24.30	23.52	22.55	
		1910	24.22	23.58	22.45	
		1882.5	24.25	23.53	22.25	
25RB High (25)		1855	24.24	23.49	22.42	
		1910	23.30	22.26	21.25	
		1882.5	23.35	22.35	21.32	
25RB Middle (12)		1855	23.37	22.33	21.36	
		1910	23.43	22.41	21.40	
		1882.5	23.40	22.40	21.36	
25RB Low (0)		1855	23.35	22.34	21.37	
		1910	23.50	22.48	21.47	
		1882.5	23.41	22.41	21.37	
50RB (0)		1855	23.32	22.34	21.26	
		1910	23.38	22.39	21.38	
		1882.5	23.39	22.38	21.36	
15 MHz		1RB High (74)	1855	23.36	22.33	21.34
			1907.5	24.16	23.34	22.38
			1882.5	24.18	23.43	22.41
		1RB Middle (37)	1857.5	24.21	23.45	22.41
			1907.5	24.34	23.65	22.57
			1882.5	24.33	23.64	22.54

	1RB Low (0)	1857.5	24.30	23.51	22.58
		1907.5	24.24	23.52	22.46
		1882.5	24.27	23.48	22.43
		1857.5	24.20	23.55	22.48
	36RB High (38)	1907.5	23.35	22.29	21.28
		1882.5	23.40	22.34	21.33
		1857.5	23.41	22.38	21.36
	36RB Middle (19)	1907.5	23.45	22.40	21.40
		1882.5	23.43	22.37	21.38
		1857.5	23.38	22.32	21.34
	36RB Low (0)	1907.5	23.46	22.38	21.39
		1882.5	23.47	22.38	21.42
		1857.5	23.36	22.29	21.30
	75RB (0)	1907.5	23.42	22.38	21.33
		1882.5	23.42	22.37	21.35
1857.5		23.36	22.33	21.32	
20 MHz	1RB High (99)	1905	23.99	23.17	22.35
		1882.5	24.03	23.19	22.37
		1860	24.10	23.44	22.40
	1RB Middle (50)	1905	24.33	23.60	22.71
		1882.5	24.33	23.60	22.65
		1860	24.43	23.58	22.62
	1RB Low (0)	1905	24.06	23.40	22.45
		1882.5	24.09	23.42	22.44
		1860	24.17	23.41	22.45
	50RB High (50)	1905	23.02	22.03	21.17
		1882.5	23.19	22.19	21.32
		1860	23.34	22.34	21.45
	50RB Middle (25)	1905	23.25	22.25	21.40
		1882.5	23.29	22.28	21.43
		1860	23.38	22.38	21.40
	50RB Low (0)	1905	23.20	22.22	21.34
		1882.5	23.33	22.32	21.45
		1860	23.27	22.25	21.29
	100RB (0)	1905	23.11	22.08	21.27
		1882.5	23.23	22.21	21.37
		1860	23.29	22.29	21.38

## Power Level B1

Band 25						
Bandwidth (MHz)	RB allocation	Frequency (MHz)	QPSK	16QAM	64QAM	
	RB offset (Start RB)		Actual output power (dBm)	Actual output power (dBm)	Actual output power (dBm)	
1.4 MHz	1RB High (5)	1914.3	19.67	19.06	17.97	
		1882.5	19.75	19.02	17.93	
		1850.7	19.67	18.86	17.91	
	1RB Middle (3)	1914.3	19.79	19.10	18.02	
		1882.5	19.87	19.15	18.08	
		1850.7	19.79	19.09	18.06	
	1RB Low (0)	1914.3	19.70	19.02	17.85	
		1882.5	19.74	19.05	17.92	
		1850.7	19.66	18.90	17.96	
	3RB High (3)	1914.3	19.84	18.78	17.91	
		1882.5	19.85	18.80	17.94	
		1850.7	19.75	18.79	17.88	
	3RB Middle (1)	1914.3	19.86	18.83	17.96	
		1882.5	19.92	18.87	18.00	
		1850.7	19.81	18.76	17.88	
	3RB Low (0)	1914.3	19.80	18.80	17.96	
		1882.5	19.82	18.88	17.96	
		1850.7	19.75	18.77	17.88	
	6RB (0)	1914.3	18.77	17.89	16.76	
		1882.5	18.82	17.97	16.84	
		1850.7	18.73	17.90	16.73	
	3 MHz	1RB High (14)	1913.5	19.81	19.11	18.04
			1882.5	19.85	19.05	18.07
			1851.5	19.77	18.96	18.05
		1RB Middle (7)	1913.5	19.94	19.26	18.12
			1882.5	20.01	19.34	18.10
			1851.5	19.82	19.08	18.14
1RB Low (0)		1913.5	19.80	19.09	17.98	
		1882.5	19.79	19.02	17.99	
		1851.5	19.75	18.95	17.91	
8RB High (7)		1913.5	18.75	17.85	16.82	
		1882.5	18.81	17.92	16.83	
		1851.5	18.74	17.87	16.81	
8RB Middle (4)		1913.5	18.82	17.93	16.87	
		1882.5	18.86	17.95	16.89	
		1851.5	18.77	17.89	16.81	
8RB Low (0)		1913.5	18.79	17.88	16.82	
		1882.5	18.81	17.93	16.88	
		1851.5	18.74	17.88	16.78	
15RB (0)		1913.5	18.76	17.83	16.79	
		1882.5	18.80	17.84	16.83	

5 MHz	1RB High (24)	1851.5	18.73	17.80	16.77	
		1912.5	19.67	19.00	17.87	
		1882.5	19.73	19.02	17.87	
	1RB Middle (12)	1852.5	19.64	19.01	17.83	
		1912.5	20.02	19.29	18.22	
		1882.5	20.01	19.25	18.05	
	1RB Low (0)	1852.5	19.95	19.15	18.13	
		1912.5	19.70	19.04	17.92	
		1882.5	19.73	19.02	18.49	
	12RB High (13)	1852.5	19.66	18.95	17.82	
		1912.5	18.76	17.80	16.81	
		1882.5	18.83	17.84	17.46	
	12RB Middle (6)	1852.5	18.78	17.81	16.81	
		1912.5	18.85	17.88	16.87	
		1882.5	18.89	17.91	17.49	
	12RB Low (0)	1852.5	18.81	17.81	16.81	
		1912.5	18.83	17.88	16.86	
		1882.5	18.84	17.85	17.42	
	25RB (0)	1852.5	18.73	17.77	16.77	
		1912.5	18.81	17.85	16.82	
		1882.5	18.83	17.87	16.83	
	10 MHz	1RB High (49)	1852.5	18.75	17.80	16.74
			1910	19.77	19.12	17.93
			1882.5	19.79	19.08	17.99
		1RB Middle (24)	1855	19.77	19.08	18.04
			1910	19.93	19.33	18.11
			1882.5	19.93	19.19	18.13
1RB Low (0)		1855	19.86	19.11	18.12	
		1910	19.80	19.15	17.97	
		1882.5	19.80	19.05	17.99	
25RB High (25)		1855	19.75	18.98	17.98	
		1910	18.81	17.89	16.83	
		1882.5	18.86	17.92	16.89	
25RB Middle (12)		1855	18.86	17.91	16.86	
		1910	18.86	17.94	16.91	
		1882.5	18.87	17.93	16.90	
25RB Low (0)		1855	18.85	17.88	16.83	
		1910	18.95	17.95	16.95	
		1882.5	18.86	17.92	16.90	
50RB (0)		1855	18.77	17.78	16.81	
		1910	18.85	17.94	16.89	
		1882.5	18.84	17.89	16.89	
15 MHz		1RB High (74)	1855	18.83	17.85	16.86
			1907.5	19.75	19.08	17.99
			1882.5	19.77	18.99	17.96
		1RB Middle (37)	1857.5	19.73	18.95	17.93
			1907.5	19.86	19.23	18.11
			1882.5	19.87	19.12	18.04

		1857.5	19.79	19.03	18.08
	1RB Low (0)	1907.5	19.79	19.15	18.03
		1882.5	19.79	18.99	17.93
		1857.5	19.74	19.01	17.94
	36RB High (38)	1907.5	18.84	17.87	16.86
		1882.5	18.85	17.89	16.86
		1857.5	18.87	17.88	16.88
	36RB Middle (19)	1907.5	18.89	17.89	16.90
		1882.5	18.85	17.88	16.86
		1857.5	18.82	17.87	16.84
	36RB Low (0)	1907.5	18.91	17.92	16.92
		1882.5	18.87	17.89	16.90
		1857.5	18.77	17.79	16.79
	75RB (0)	1907.5	18.85	17.91	16.90
		1882.5	18.87	17.91	16.88
1857.5		18.83	17.86	16.83	
20 MHz	1RB High (99)	1905	19.59	18.91	17.77
		1882.5	19.56	18.83	17.81
		1860	19.54	18.89	17.81
	1RB Middle (50)	1905	19.78	19.09	18.03
		1882.5	19.75	19.15	17.91
		1860	19.82	19.20	17.95
	1RB Low (0)	1905	19.60	18.89	17.83
		1882.5	19.61	18.83	17.86
		1860	19.55	18.88	17.80
	50RB High (50)	1905	18.60	17.66	16.63
		1882.5	18.73	17.77	16.75
		1860	18.73	17.77	16.72
	50RB Middle (25)	1905	18.75	17.80	16.80
		1882.5	18.71	17.78	16.74
		1860	18.74	17.82	16.79
	50RB Low (0)	1905	18.70	17.78	16.73
		1882.5	18.75	17.81	16.78
		1860	18.65	17.67	16.64
	100RB (0)	1905	18.66	17.69	16.70
		1882.5	18.75	17.78	16.77
		1860	18.68	17.71	16.69



## Power Level A1

Band 26					
Bandwidth (MHz)	RB allocation	Frequency (MHz)	QPSK	16QAM	64QAM
	RB offset (Start RB)		Actual output power (dBm)	Actual output power (dBm)	Actual output power (dBm)
1.4 MHz	1RB High (5)	848.3	24.14	23.23	22.37
		831.5	24.13	23.46	22.39
		814.7	24.16	23.48	22.41
	1RB Middle (3)	848.3	24.28	23.36	22.45
		831.5	24.22	23.56	22.40
		814.7	24.27	23.56	22.54
	1RB Low (0)	848.3	24.12	23.36	22.33
		831.5	24.13	23.48	22.37
		814.7	24.16	23.38	22.34
	3RB High (3)	848.3	24.24	23.24	22.31
		831.5	24.24	23.24	22.38
		814.7	24.29	23.26	22.34
	3RB Middle (1)	848.3	24.32	23.30	22.37
		831.5	24.30	23.27	22.40
		814.7	24.32	23.34	22.40
	3RB Low (0)	848.3	24.25	23.20	22.35
		831.5	24.25	23.24	22.38
		814.7	24.25	23.21	22.36
	6RB (0)	848.3	23.31	22.36	21.25
		831.5	23.24	22.33	21.27
		814.7	23.33	22.39	21.30
3 MHz	1RB High (14)	847.5	23.80	23.34	22.37
		831.5	24.20	23.44	22.44
		815.5	24.19	23.23	22.50
	1RB Middle (7)	847.5	24.42	23.51	22.58
		831.5	24.41	23.64	22.57
		815.5	24.32	23.64	22.59
	1RB Low (0)	847.5	24.22	23.54	22.52
		831.5	24.23	23.53	22.41
		815.5	24.24	23.55	22.45
	8RB High (7)	847.5	23.31	22.31	21.32
		831.5	23.33	22.38	21.38
		815.5	23.30	22.37	21.35
	8RB Middle (4)	847.5	23.34	22.35	21.36
		831.5	23.32	22.38	21.32
		815.5	23.33	22.38	21.33
	8RB Low (0)	847.5	23.34	22.40	21.34
		831.5	23.31	22.35	21.32
		815.5	23.30	22.33	21.27
15RB (0)	847.5	23.33	22.27	21.30	
	831.5	23.31	22.31	21.29	

5 MHz	1RB High (24)	815.5	23.31	22.31	21.27	
		846.5	24.10	23.28	22.34	
		831.5	24.10	23.40	22.39	
	1RB Middle (12)	816.5	24.13	23.31	22.29	
		846.5	24.38	23.67	22.56	
		831.5	24.38	23.70	22.63	
	1RB Low (0)	816.5	24.40	23.55	22.56	
		846.5	24.14	23.44	22.29	
		831.5	24.13	23.46	22.30	
	12RB High (13)	816.5	24.15	23.41	22.39	
		846.5	23.21	22.18	21.23	
		831.5	23.27	22.28	21.29	
	12RB Middle (6)	816.5	23.28	22.27	21.31	
		846.5	23.36	22.33	21.36	
		831.5	23.35	22.37	21.34	
	12RB Low (0)	816.5	23.39	22.37	21.39	
		846.5	23.36	22.34	21.35	
		831.5	23.29	22.27	21.32	
	25RB (0)	816.5	23.28	22.28	21.26	
		846.5	23.35	22.29	21.29	
		831.5	23.30	22.31	21.30	
	10 MHz	1RB High (49)	816.5	23.33	22.33	21.33
			844	24.17	23.44	22.35
			831.5	24.17	23.37	22.41
1RB Middle (24)		820	24.17	23.44	22.35	
		844	24.35	23.64	22.57	
		831.5	24.31	23.53	22.52	
1RB Low (0)		820	24.33	23.59	22.43	
		844	24.20	23.43	22.36	
		831.5	24.23	23.54	22.46	
25RB High (25)		820	24.23	23.55	22.43	
		844	23.22	22.20	21.20	
		831.5	23.37	22.39	21.38	
25RB Middle (12)		820	23.37	22.32	21.31	
		844	23.37	22.37	21.38	
		831.5	23.32	22.34	21.32	
25RB Low (0)		820	23.40	22.36	21.35	
		844	23.44	22.42	21.40	
		831.5	23.30	22.27	21.33	
50RB (0)		820	23.45	22.42	21.43	
		844	23.33	22.32	21.30	
		831.5	23.36	22.36	21.36	
15 MHz		1RB High (74)	820	23.38	22.35	21.36
			841.5	24.09	23.28	22.29
			831.5	24.05	23.41	22.42
	1RB Middle	822.5	24.11	23.39	22.40	
		1907.5	24.18	23.60	22.61	
		1882.5	24.22	23.58	22.59	



	(37)	1857.5	24.17	23.44	22.45
	1RB Low (0)	1907.5	24.08	23.36	22.37
		1882.5	24.14	23.38	22.39
		1857.5	24.13	23.32	22.33
	36RB High (38)	1907.5	23.17	22.15	21.16
		1882.5	23.24	22.21	21.22
		1857.5	23.29	22.23	21.24
	36RB Middle (19)	1907.5	23.30	22.26	21.27
		1882.5	23.30	22.26	21.27
		1857.5	23.31	22.27	21.28
	36RB Low (0)	1907.5	23.32	22.28	21.29
		1882.5	23.29	22.27	21.28
		1857.5	23.34	22.30	21.31
	75RB (0)	1907.5	23.27	22.27	21.28
		1882.5	23.27	22.25	21.26
		1857.5	23.34	22.30	21.31

## Power Level B1

Band 26						
Bandwidth (MHz)	RB allocation	Frequency (MHz)	QPSK	16QAM	64QAM	
	RB offset (Start RB)		Actual output power (dBm)	Actual output power (dBm)	Actual output power (dBm)	
1.4 MHz	1RB High (5)	848.3	23.03	22.31	21.09	
		831.5	23.07	22.31	21.21	
		814.7	23.10	22.26	21.30	
	1RB Middle (3)	848.3	23.15	22.44	21.35	
		831.5	23.15	22.44	21.28	
		814.7	23.19	22.48	21.32	
	1RB Low (0)	848.3	23.07	22.23	21.30	
		831.5	23.05	22.32	21.17	
		814.7	23.10	22.26	21.28	
	3RB High (3)	848.3	23.14	22.05	21.21	
		831.5	23.12	22.16	21.17	
		814.7	23.17	22.15	21.26	
	3RB Middle (1)	848.3	23.21	22.13	21.28	
		831.5	23.22	22.18	21.30	
		814.7	23.26	22.24	21.30	
	3RB Low (0)	848.3	23.15	22.12	21.20	
		831.5	23.12	22.12	21.21	
		814.7	23.19	22.11	21.26	
	6RB (0)	848.3	22.17	21.23	20.17	
		831.5	22.14	21.20	20.13	
		814.7	22.21	21.24	20.18	
	3 MHz	1RB High (14)	847.5	23.02	22.30	21.20
			831.5	23.01	22.29	21.27
			815.5	23.01	22.33	21.26
1RB Middle (7)		847.5	23.21	22.54	21.46	
		831.5	23.18	22.45	21.51	
		815.5	23.24	22.60	21.35	
1RB Low (0)		847.5	23.05	22.29	21.22	
		831.5	23.07	22.44	21.25	
		815.5	23.10	22.33	21.31	
8RB High (7)		847.5	22.08	21.12	20.16	
		831.5	22.03	21.14	20.17	
		815.5	22.10	21.15	20.17	
8RB Middle (4)		847.5	22.14	21.20	20.21	
		831.5	22.12	21.21	20.22	
		815.5	22.13	21.20	20.21	
8RB Low (0)		847.5	22.10	21.22	20.22	
		831.5	22.07	21.17	20.18	
		815.5	22.10	21.17	20.17	
15RB (0)		847.5	22.06	21.14	20.12	
		831.5	22.04	21.09	20.11	

5 MHz	1RB High (24)	815.5	22.09	21.09	20.11
		846.5	22.92	22.26	21.06
		831.5	22.89	22.16	21.10
	1RB Middle (12)	816.5	23.00	22.28	21.21
		846.5	23.26	22.45	21.42
		831.5	23.19	22.47	21.41
	1RB Low (0)	816.5	23.25	22.40	21.44
		846.5	22.97	22.19	21.17
		831.5	22.97	22.23	21.07
	12RB High (13)	816.5	23.02	22.19	21.20
		846.5	21.95	20.93	20.90
		831.5	22.03	21.04	20.07
	12RB Middle (6)	816.5	22.13	21.14	20.20
		846.5	22.12	21.10	20.14
		831.5	22.12	21.13	20.14
	12RB Low (0)	816.5	22.18	21.15	20.20
		846.5	22.05	21.02	20.98
		831.5	22.06	21.06	20.10
	25RB (0)	816.5	22.16	21.12	20.19
		846.5	22.04	21.04	20.05
		831.5	22.05	21.05	20.06
10 MHz	1RB High (49)	816.5	22.18	21.15	20.18
		844	23.03	22.17	21.25
		831.5	22.98	22.14	21.12
	1RB Middle (24)	820	23.03	22.22	21.14
		844	23.15	22.32	21.31
		831.5	23.19	22.42	21.28
	1RB Low (0)	820	23.21	22.51	21.35
		844	23.04	22.12	21.19
		831.5	23.10	22.35	21.20
	25RB High (25)	820	23.10	22.31	21.28
		844	22.07	21.07	20.12
		831.5	22.05	21.06	20.09
	25RB Middle (12)	820	22.15	21.15	20.23
		844	22.11	21.12	20.13
		831.5	22.10	21.08	20.13
	25RB Low (0)	820	22.16	21.15	20.19
		844	22.14	21.15	20.16
		831.5	22.10	21.11	20.15
	50RB (0)	820	22.13	21.11	20.18
		844	22.10	21.12	20.14
		831.5	22.07	21.08	20.10
15 MHz	1RB High (74)	820	22.14	21.16	20.16
		841.5	22.93	22.22	21.01
		831.5	22.88	22.10	21.07
	1RB Middle	822.5	22.95	22.20	21.09
		1907.5	23.03	22.30	21.19
		1882.5	23.04	22.32	21.29



	(37)	1857.5	23.09	22.33	21.28
	1RB Low (0)	1907.5	22.93	22.15	21.06
1882.5		23.00	22.27	21.12	
1857.5		23.02	22.23	21.18	
	36RB High (38)	1907.5	22.12	21.11	20.14
1882.5		22.03	20.99	20.06	
1857.5		22.07	21.03	20.09	
	36RB Middle (19)	1907.5	22.08	21.04	20.12
1882.5		22.09	21.08	20.11	
1857.5		22.12	21.09	20.12	
	36RB Low (0)	1907.5	22.17	21.12	20.18
1882.5		22.10	21.08	20.13	
1857.5		22.09	21.07	20.12	
	75RB (0)	1907.5	22.14	21.11	20.12
1882.5		22.05	21.03	20.03	
1857.5		22.08	21.05	20.09	

## Power Level A1/B1

Band 41 – PC2					
Bandwidth (MHz)	RB allocation	Frequency (MHz)	QPSK	16QAM	64QAM
	RB offset (Start RB)		Actual output power (dBm)	Actual output power (dBm)	Actual output power (dBm)
5 MHz	1RB High (24)	2687.5	27.09	26.29	25.10
		2640.3	27.07	26.24	25.06
		2593	27.05	26.24	25.05
		2545.8	27.05	26.18	25.02
		2498.5	26.94	26.09	24.90
	1RB Middle (12)	2687.5	27.26	26.43	25.25
		2640.3	27.20	26.35	25.16
		2593	27.25	26.40	25.20
		2545.8	27.13	26.29	25.11
		2498.5	27.12	26.25	25.02
	1RB Low (0)	2687.5	27.12	26.31	25.12
		2640.3	27.06	26.25	25.04
		2593	27.11	26.29	25.11
		2545.8	27.01	26.16	24.99
		2498.5	26.99	26.11	24.94
	12RB High (13)	2687.5	26.23	25.24	24.31
		2640.3	26.17	25.21	24.26
		2593	26.19	25.23	24.25
		2545.8	26.11	25.13	24.18
		2498.5	26.09	25.07	24.14
	12RB Middle (6)	2687.5	26.30	25.33	24.37
		2640.3	26.20	25.22	24.27
		2593	26.27	25.27	24.33
		2545.8	26.16	25.16	24.24
		2498.5	26.15	25.12	24.16
	12RB Low (0)	2687.5	26.28	25.29	24.34
		2640.3	26.16	25.17	24.23
		2593	26.20	25.22	24.27
		2545.8	26.11	25.13	24.17
		2498.5	26.09	25.06	24.09
25RB (0)	2687.5	26.23	25.29	24.36	
	2640.3	26.16	25.22	24.29	
	2593	26.19	25.23	24.29	
	2545.8	26.10	25.14	24.21	
	2498.5	26.03	25.10	24.11	

10 MHz	1RB High (49)	2685	27.16	26.39	25.18
		2639	27.14	26.31	25.12
		2593	27.12	26.31	25.07
		2547	27.11	26.29	25.09
		2501	26.96	26.15	24.92
	1RB Middle (24)	2685	27.30	26.52	25.30
		2639	27.23	26.42	25.21
		2593	27.28	26.47	25.25
		2547	27.20	26.37	25.16
		2501	27.12	26.25	25.07
	1RB Low (0)	2685	27.25	26.46	25.25
		2639	27.15	26.35	25.13
		2593	27.24	26.43	25.21
		2547	27.10	26.26	25.07
		2501	27.07	26.21	25.01
	25RB High (25)	2685	26.28	25.30	24.38
		2639	26.22	25.24	24.32
		2593	26.22	25.24	24.30
		2547	26.13	25.17	24.25
		2501	26.05	25.07	24.09
	25RB Middle (12)	2685	26.30	25.35	24.42
		2639	26.19	25.21	24.29
		2593	26.25	25.27	24.34
		2547	26.15	25.19	24.27
		2501	26.08	25.10	24.17
	25RB Low (0)	2685	26.35	25.37	24.42
		2639	26.22	25.28	24.32
		2593	26.30	25.31	24.38
		2547	26.18	25.23	24.27
		2501	26.08	25.12	24.15
50RB (0)	2685	26.35	25.38	24.35	
	2639	26.24	25.31	24.28	
	2593	26.26	25.32	24.30	
	2547	26.20	25.21	24.22	
	2501	26.08	25.13	24.12	
15 MHz	1RB High (74)	2682.5	27.07	26.28	25.07
		2637.8	27.05	26.23	25.02
		2593	27.01	26.18	24.98
		2548.3	27.03	26.21	25.03
		2503.5	26.86	26.03	24.82
	1RB	2682.5	27.26	26.43	25.23



	Middle (37)	2637.8	27.16	26.34	25.14
		2593	27.20	26.37	25.17
		2548.3	27.17	26.33	25.13
		2503.5	27.00	26.17	24.97
	1RB Low (0)	2682.5	27.18	26.38	25.18
		2637.8	27.10	26.28	25.09
		2593	27.20	26.36	25.18
		2548.3	27.03	26.21	24.99
		2503.5	26.98	26.12	24.93
	36RB High (38)	2682.5	26.23	25.21	24.23
		2637.8	26.19	25.13	24.17
		2593	26.16	25.13	24.15
		2548.3	26.17	25.11	24.13
		2503.5	26.02	24.97	23.99
	36RB Middle (19)	2682.5	26.27	25.26	24.27
		2637.8	26.19	25.15	24.18
		2593	26.23	25.20	24.22
		2548.3	26.15	25.13	24.15
		2503.5	26.06	25.00	24.02
	36RB Low (0)	2682.5	26.30	25.28	24.29
2637.8		26.19	25.16	24.18	
2593		26.27	25.24	24.26	
2548.3		26.14	25.10	24.14	
2503.5		26.04	24.97	24.01	
75RB (0)	2682.5	26.25	25.27	24.27	
	2637.8	26.19	25.14	24.22	
	2593	26.20	25.21	24.23	
	2548.3	26.12	25.13	24.13	
	2503.5	26.01	25.02	24.03	
20 MHz	1RB High (99)	2680	27.00	26.21	25.03
		2636.5	26.90	26.09	24.96
		2593	26.87	26.07	24.90
		2549.5	26.92	26.10	24.98
		2506	26.66	25.86	24.77
	1RB Middle (50)	2680	27.26	26.46	25.30
		2636.5	27.15	26.36	25.23
		2593	27.21	26.44	25.25
		2549.5	27.09	26.28	25.21
		2506	26.94	26.13	25.03
	1RB Low (0)	2680	27.08	26.26	25.14
		2636.5	27.01	26.20	25.06
		2593	27.08	26.26	25.16

		2549.5	26.82	26.00	24.93
		2506	26.86	26.00	24.89
	50RB High (50)	2680	26.17	25.24	24.21
		2636.5	26.01	25.10	24.18
		2593	26.07	25.09	24.14
		2549.5	26.02	25.05	24.16
		2506	25.86	24.87	24.00
		2680	26.19	25.29	24.31
	50RB Middle (25)	2636.5	26.11	25.18	24.23
		2593	26.15	25.21	24.27
		2549.5	26.02	25.07	24.19
		2506	25.87	24.89	24.05
		2680	26.18	25.26	24.31
	50RB Low (0)	2636.5	26.14	25.17	24.22
		2593	26.20	25.21	24.34
		2549.5	26.03	25.06	24.16
		2506	25.96	24.97	24.00
		2680	26.18	25.22	24.27
	100RB (0)	2636.5	26.14	25.13	24.22
		2593	26.10	25.14	24.23
2549.5		26.01	25.04	24.14	
2506		25.92	24.91	24.02	

## Power Level A1/B1

Band 41 – PC3					
Bandwidth (MHz)	RB allocation	Frequency (MHz)	QPSK	16QAM	64QAM
	RB offset (Start RB)		Actual output power (dBm)	Actual output power (dBm)	Actual output power (dBm)
5 MHz	1RB High (24)	2687.5	24.14	23.29	21.88
		2640.3	24.12	23.25	21.86
		2593	24.12	23.29	21.86
		2545.8	24.07	23.23	21.82
		2498.5	23.98	23.13	21.65
	1RB Middle (12)	2687.5	24.39	23.49	22.14
		2640.3	24.30	23.45	22.03
		2593	24.35	23.51	22.08
		2545.8	24.34	23.50	22.09
		2498.5	24.28	23.45	22.04
	1RB Low (0)	2687.5	24.19	23.32	21.95
		2640.3	24.10	23.25	21.86
		2593	24.20	23.34	21.90
		2545.8	24.05	23.21	21.80
		2498.5	24.02	23.17	21.76
	12RB High (13)	2687.5	23.23	22.22	21.32
		2640.3	23.26	22.20	21.26
		2593	23.27	22.20	21.26
		2545.8	23.16	22.10	21.22
		2498.5	23.13	22.06	21.17
	12RB Middle (6)	2687.5	23.34	22.31	21.40
		2640.3	23.31	22.24	21.30
		2593	23.36	22.30	21.33
		2545.8	23.26	22.19	21.25
		2498.5	23.19	22.14	21.17
	12RB Low (0)	2687.5	23.31	22.25	21.35
		2640.3	23.24	22.17	21.28
		2593	23.33	22.27	21.31
		2545.8	23.17	22.12	21.23
		2498.5	23.15	22.09	21.16
25RB (0)	2687.5	23.29	22.33	21.39	
	2640.3	23.27	22.27	21.35	
	2593	23.31	22.29	21.28	
	2545.8	23.18	22.21	21.24	
	2498.5	23.19	22.14	21.17	

10 MHz	1RB High (49)	2685	24.25	23.36	21.97
		2639	24.17	23.33	21.93
		2593	24.18	23.31	21.88
		2547	24.16	23.34	21.90
		2501	24.04	23.17	21.73
	1RB Middle (24)	2685	24.39	23.48	22.11
		2639	24.31	23.45	22.02
		2593	24.36	23.48	22.06
		2547	24.26	23.34	21.97
		2501	24.08	23.21	21.81
	1RB Low (0)	2685	24.31	23.41	22.07
		2639	24.21	23.35	21.93
		2593	24.31	23.46	22.01
		2547	24.13	23.28	21.87
		2501	24.04	23.23	21.83
	25RB High (25)	2685	23.29	22.34	21.37
		2639	23.32	22.31	21.34
		2593	23.30	22.29	21.35
		2547	23.19	22.19	21.26
		2501	23.09	22.16	21.18
	25RB Middle (12)	2685	23.36	22.42	21.40
		2639	23.32	22.23	21.39
		2593	23.35	22.35	21.35
		2547	23.28	22.21	21.29
		2501	23.18	22.15	21.19
	25RB Low (0)	2685	23.33	22.37	21.40
		2639	23.30	22.30	21.34
		2593	23.41	22.36	21.42
		2547	23.23	22.24	21.30
		2501	23.17	22.17	21.18
50RB (0)	2685	23.37	22.45	21.43	
	2639	23.32	22.41	21.33	
	2593	23.31	22.48	21.37	
	2547	23.22	22.32	21.24	
	2501	23.17	22.22	21.14	
15 MHz	1RB High (74)	2682.5	24.13	23.26	21.91
		2637.8	24.08	23.23	21.83
		2593	24.07	23.23	21.78
		2548.3	24.07	23.23	21.77
		2503.5	23.87	23.04	21.58
	1RB	2682.5	24.29	23.42	22.07

	Middle (37)	2637.8	24.25	23.36	21.94
		2593	24.24	23.40	21.96
		2548.3	24.16	23.33	21.90
		2503.5	24.06	23.16	21.72
	1RB Low (0)	2682.5	24.22	23.39	21.97
		2637.8	24.13	23.32	21.87
		2593	24.21	23.41	21.99
		2548.3	24.05	23.19	21.77
		2503.5	24.01	23.14	21.75
	36RB High (38)	2682.5	23.27	22.25	21.28
		2637.8	23.27	22.22	21.24
		2593	23.23	22.24	21.21
		2548.3	23.25	22.15	21.18
		2503.5	23.05	22.07	21.01
	36RB Middle (19)	2682.5	23.28	22.40	21.33
		2637.8	23.29	22.22	21.23
		2593	23.31	22.27	21.29
		2548.3	23.23	22.18	21.16
		2503.5	23.10	22.07	21.06
	36RB Low (0)	2682.5	23.34	22.35	21.38
2637.8		23.27	22.20	21.30	
2593		23.35	22.33	21.33	
2548.3		23.20	22.20	21.19	
2503.5		23.10	22.10	21.05	
75RB (0)	2682.5	23.27	22.30	21.41	
	2637.8	23.28	22.27	21.30	
	2593	23.29	22.31	21.39	
	2548.3	23.18	22.32	21.24	
	2503.5	23.08	22.17	21.07	
20 MHz	1RB High (99)	2680	24.08	23.19	21.78
		2636.5	23.97	23.10	21.74
		2593	23.93	23.19	21.68
		2549.5	23.98	23.11	21.77
		2506	23.68	22.87	21.52
	1RB Middle (50)	2680	24.36	23.48	22.04
		2636.5	24.20	23.35	22.04
		2593	24.26	23.37	22.07
		2549.5	24.17	23.31	22.01
		2506	24.01	23.12	21.83
	1RB Low (0)	2680	24.17	23.33	21.95
		2636.5	24.08	23.22	21.82
		2593	24.15	23.30	21.92

		2549.5	23.84	23.02	21.69
		2506	23.86	23.01	21.66
	50RB High (50)	2680	23.19	22.35	21.32
		2636.5	23.12	22.21	21.23
		2593	23.17	22.27	21.25
		2549.5	23.08	22.23	21.18
		2506	22.91	22.03	21.08
		2680	23.30	22.39	21.46
	50RB Middle (25)	2636.5	23.20	22.31	21.31
		2593	23.23	22.33	21.32
		2549.5	23.07	22.19	21.22
		2506	22.96	22.02	21.03
		2680	23.28	22.35	21.41
	50RB Low (0)	2636.5	23.23	22.34	21.32
		2593	23.30	22.41	21.41
		2549.5	23.15	22.19	21.19
		2506	23.01	22.04	21.09
		2680	23.31	22.36	21.34
	100RB (0)	2636.5	23.15	22.25	21.30
		2593	23.20	22.95	21.35
2549.5		23.14	22.22	21.21	
2506		22.97	22.08	21.05	

## Power Level A1

Band 66					
Bandwidth (MHz)	RB allocation	Frequency (MHz)	QPSK	16QAM	64QAM
	RB offset (Start RB)		Actual output power (dBm)	Actual output power (dBm)	Actual output power (dBm)
1.4 MHz	1RB High (5)	1779.3	24.13	23.36	22.23
		1745	24.22	23.45	22.41
		1710.7	24.24	23.40	22.39
	1RB Middle (3)	1779.3	24.24	23.42	22.41
		1745	24.30	23.56	22.46
		1710.7	24.33	23.51	22.49
	1RB Low (0)	1779.3	24.13	23.41	22.29
		1745	24.20	23.43	22.38
		1710.7	24.23	23.41	22.37
	3RB High (3)	1779.3	24.23	23.19	22.28
		1745	24.28	23.24	22.39
		1710.7	24.34	23.22	22.39
	3RB Middle (1)	1779.3	24.28	23.22	22.31
		1745	24.34	23.32	22.40
		1710.7	24.36	23.31	22.43
	3RB Low (0)	1779.3	24.22	23.13	22.24
		1745	24.29	23.29	22.33
		1710.7	24.32	23.29	22.34
	6RB (0)	1779.3	23.24	22.27	21.16
		1745	23.29	22.41	21.27
		1710.7	23.34	22.40	21.27
3 MHz	1RB High (14)	1778.5	24.18	23.32	22.37
		1745	24.26	23.51	22.37
		1711.5	24.27	23.51	22.42
	1RB Middle (7)	1778.5	24.35	23.47	22.44
		1745	24.38	23.73	22.61
		1711.5	24.44	23.58	22.61
	1RB Low (0)	1778.5	24.21	23.42	22.36
		1745	24.27	23.49	22.39
		1711.5	24.30	23.58	22.41
	8RB High (7)	1778.5	23.20	22.29	21.26
		1745	23.27	22.37	21.36
		1711.5	23.30	22.38	21.33
	8RB Middle (4)	1778.5	23.26	22.34	21.31
		1745	23.34	22.38	21.36
		1711.5	23.38	22.39	21.40
8RB Low (0)	1778.5	23.25	22.30	21.28	
	1745	23.30	22.37	21.35	
	1711.5	23.31	22.36	21.37	
15RB	1778.5	23.27	22.24	21.21	

5 MHz	(0)	1745	23.29	22.27	21.29
		1711.5	23.33	22.31	21.33
	1RB High (24)	1777.5	24.08	23.36	22.24
		1745	24.17	23.36	22.36
		1712.5	24.18	23.46	22.32
	1RB Middle (12)	1777.5	24.34	23.65	22.46
		1745	24.43	23.69	22.63
		1712.5	24.44	23.66	22.58
	1RB Low (0)	1777.5	24.14	23.43	22.26
		1745	24.18	23.49	22.38
		1712.5	24.21	23.43	22.33
	12RB High (13)	1777.5	23.20	22.20	21.21
		1745	23.27	22.27	21.28
		1712.5	23.33	22.29	21.32
	12RB Middle (6)	1777.5	23.29	22.29	21.32
		1745	23.37	22.32	21.37
		1712.5	23.37	22.34	21.39
	12RB Low (0)	1777.5	23.30	22.25	21.28
		1745	23.31	22.29	21.32
		1712.5	23.31	22.27	21.33
25RB (0)	1777.5	23.26	22.26	21.24	
	1745	23.31	22.29	21.29	
	1712.5	23.32	22.34	21.33	
10 MHz	1RB High (49)	1775	24.19	23.36	22.33
		1745	24.27	23.53	22.46
		1715	24.23	23.52	22.46
	1RB Middle (24)	1775	24.33	23.48	22.51
		1745	24.39	23.66	22.49
		1715	24.39	23.68	22.55
	1RB Low (0)	1775	24.25	23.49	22.45
		1745	24.28	23.56	22.46
		1715	24.28	23.59	22.41
	25RB High (25)	1775	23.21	22.19	21.20
		1745	23.34	22.33	21.32
		1715	23.37	22.34	21.35
	25RB Middle (12)	1775	23.31	22.31	21.33
		1745	23.36	22.35	21.35
		1715	23.38	22.34	21.37
	25RB Low (0)	1775	23.39	22.36	21.36
		1745	23.39	22.38	21.38
		1715	23.41	22.35	21.38
	50RB (0)	1775	23.31	22.29	21.30
		1745	23.39	22.38	21.38
1715		23.40	22.36	21.37	
15 MHz	1RB High (74)	1772.5	24.10	23.39	22.26
		1745	24.24	23.53	22.38
		1717.5	24.20	23.42	22.37
	1RB	1772.5	24.26	23.49	22.45



	Middle (37)	1745	24.30	23.52	22.45	
		1717.5	24.30	23.60	22.54	
	1RB Low (0)	1772.5	24.22	23.54	22.33	
		1745	24.24	23.50	22.39	
	36RB High (38)	1717.5	24.24	23.48	22.45	
		1772.5	23.26	22.23	21.24	
		1745	23.35	22.31	21.30	
	36RB Middle (19)	1717.5	23.33	22.30	21.33	
		1772.5	23.34	22.30	21.35	
		1745	23.41	22.39	21.40	
	36RB Low (0)	1717.5	23.38	22.32	21.41	
		1772.5	23.34	22.30	21.31	
		1745	23.38	22.34	21.37	
	75RB (0)	1717.5	23.41	22.34	21.37	
		1772.5	23.28	22.28	21.27	
		1745	23.37	22.35	21.34	
	<b>20 MHz</b>	1RB High (99)	1717.5	23.35	22.33	21.35
			1770	24.12	23.31	22.18
			1745	24.07	23.40	22.29
		1RB Middle (50)	1720	24.02	23.19	22.32
1770			24.34	23.59	22.52	
1745			24.26	23.49	22.60	
1RB Low (0)		1720	24.20	23.49	22.49	
		1770	24.11	23.33	22.29	
		1745	24.16	23.43	22.29	
50RB High (50)		1720	24.03	23.27	22.33	
		1770	23.18	22.13	21.17	
		1745	23.17	22.16	21.29	
50RB Middle (25)		1720	23.24	22.23	21.34	
		1770	23.31	22.17	21.31	
		1745	23.25	22.26	21.39	
50RB Low (0)		1720	23.20	22.17	21.36	
		1770	23.28	22.28	21.30	
		1745	23.25	22.23	21.37	
100RB (0)		1720	23.24	22.20	21.38	
		1770	23.22	22.18	21.23	
	1745	23.20	22.17	21.28		
		1720	23.24	22.20	21.33	

## Power Level B1

Band 66					
Bandwidth (MHz)	RB allocation	Frequency (MHz)	QPSK	16QAM	64QAM
	RB offset (Start RB)		Actual output power (dBm)	Actual output power (dBm)	Actual output power (dBm)
1.4 MHz	1RB High (5)	1779.3	21.08	20.41	19.23
		1745	21.14	20.48	19.23
		1710.7	21.17	20.49	19.29
	1RB Middle (3)	1779.3	21.21	20.53	19.38
		1745	21.27	20.47	19.50
		1710.7	21.28	20.64	19.43
	1RB Low (0)	1779.3	21.08	20.34	19.20
		1745	21.13	20.37	19.40
		1710.7	21.18	20.47	19.35
	3RB High (3)	1779.3	21.16	20.19	19.21
		1745	21.24	20.24	19.31
		1710.7	21.25	20.28	19.29
	3RB Middle (1)	1779.3	21.21	20.22	19.28
		1745	21.29	20.31	19.30
		1710.7	21.29	20.36	19.40
	3RB Low (0)	1779.3	21.17	20.18	19.20
		1745	21.22	20.17	19.29
		1710.7	21.27	20.25	19.36
	6RB (0)	1779.3	20.15	19.25	18.13
		1745	20.21	19.33	18.23
		1710.7	20.25	19.35	18.22
3 MHz	1RB High (14)	1778.5	21.11	20.38	19.29
		1745	21.18	20.51	19.39
		1711.5	21.17	20.44	19.28
	1RB Middle (7)	1778.5	21.33	20.58	19.48
		1745	21.40	20.74	19.60
		1711.5	21.37	20.62	19.58
	1RB Low (0)	1778.5	21.16	20.49	19.28
		1745	21.17	20.58	19.36
		1711.5	21.24	20.44	19.34
	8RB High (7)	1778.5	20.17	19.21	18.21
		1745	20.21	19.27	18.28
		1711.5	20.23	19.27	18.33
	8RB Middle (4)	1778.5	20.19	19.23	18.25
		1745	20.24	19.29	18.33
		1711.5	20.28	19.34	18.32
8RB Low (0)	1778.5	20.14	19.25	18.22	
	1745	20.22	19.27	18.29	
	1711.5	20.25	19.31	18.32	
15RB	1778.5	20.14	19.14	18.17	

	(0)	1745	20.19	19.22	18.21	
		1711.5	20.19	19.19	18.24	
5 MHz	1RB High (24)	1777.5	21.05	20.27	19.24	
		1745	21.09	20.40	19.23	
		1712.5	21.11	20.43	19.30	
	1RB Middle (12)	1777.5	21.34	20.54	19.56	
		1745	21.42	20.67	19.51	
		1712.5	21.36	20.65	19.58	
	1RB Low (0)	1777.5	21.06	20.34	19.21	
		1745	21.13	20.45	19.25	
		1712.5	21.13	20.46	19.30	
	12RB High (13)	1777.5	20.16	19.15	18.19	
		1745	20.21	19.19	18.24	
		1712.5	20.20	19.21	18.24	
	12RB Middle (6)	1777.5	20.24	19.23	18.26	
		1745	20.27	19.27	18.30	
		1712.5	20.29	19.27	18.29	
	12RB Low (0)	1777.5	20.22	19.20	18.22	
		1745	20.25	19.23	18.29	
		1712.5	20.21	19.20	18.25	
	25RB (0)	1777.5	20.19	19.20	18.19	
		1745	20.24	19.22	18.23	
		1712.5	20.21	19.22	18.23	
	10 MHz	1RB High (49)	1775	21.18	20.44	19.31
			1745	21.25	20.58	19.47
			1715	21.26	20.53	19.32
1RB Middle (24)		1775	21.29	20.56	19.38	
		1745	21.32	20.68	19.51	
		1715	21.30	20.51	19.51	
1RB Low (0)		1775	21.24	20.63	19.43	
		1745	21.25	20.61	19.39	
		1715	21.26	20.61	19.48	
25RB High (25)		1775	20.23	19.21	18.25	
		1745	20.30	19.28	18.32	
		1715	20.24	19.25	18.27	
25RB Middle (12)		1775	20.24	19.25	18.27	
		1745	20.30	19.29	18.33	
		1715	20.27	19.29	18.30	
25RB Low (0)		1775	20.31	19.31	18.33	
		1745	20.32	19.32	18.33	
		1715	20.27	19.27	18.30	
50RB (0)		1775	20.28	19.28	18.28	
		1745	20.36	19.31	18.34	
		1715	20.27	19.27	18.28	
15 MHz		1RB High (74)	1772.5	21.16	20.51	19.36
			1745	21.24	20.50	19.38
			1717.5	21.20	20.43	19.34
	1RB	1772.5	21.28	20.60	19.40	

	Middle (37)	1745	21.34	20.70	19.46	
		1717.5	21.27	20.50	19.44	
	1RB Low (0)	1772.5	21.23	20.47	19.33	
		1745	21.29	20.51	19.46	
	36RB High (38)	1717.5	21.24	20.47	19.36	
		1772.5	20.25	19.23	18.29	
		1745	20.34	19.29	18.31	
	36RB Middle (19)	1717.5	20.31	19.26	18.29	
		1772.5	20.34	19.29	18.31	
		1745	20.38	19.33	18.39	
	36RB Low (0)	1717.5	20.32	19.27	18.29	
		1772.5	20.36	19.28	18.33	
		1745	20.36	19.32	18.36	
	75RB (0)	1717.5	20.32	19.29	18.32	
		1772.5	20.31	19.28	18.28	
		1745	20.35	19.32	18.36	
	<b>20 MHz</b>	1RB High (99)	1717.5	20.28	19.27	18.28
			1770	21.18	20.55	19.35
			1745	21.23	20.53	19.36
		1RB Middle (50)	1720	21.24	20.51	19.30
1770			21.48	20.85	19.60	
1745			21.49	20.67	19.59	
1RB Low (0)		1720	21.40	20.75	19.61	
		1770	21.28	20.56	19.35	
		1745	21.27	20.63	19.32	
50RB High (50)		1720	21.27	20.54	19.39	
		1770	20.29	19.27	18.28	
		1745	20.32	19.32	18.30	
50RB Middle (25)		1720	20.36	19.36	18.35	
		1770	20.43	19.41	18.40	
		1745	20.44	19.43	18.43	
50RB Low (0)		1720	20.36	19.35	18.34	
		1770	20.41	19.39	18.39	
		1745	20.44	19.40	18.40	
100RB (0)		1720	20.37	19.37	18.35	
		1770	20.38	19.34	18.32	
	1745	20.36	19.34	18.33		
		1720	20.38	19.33	18.33	

## Power Level A1/ B1

Band 71						
Bandwidth (MHz)	RB allocation	Frequency (MHz)	QPSK	16QAM	64QAM	
	RB offset (Start RB)		Actual output power (dBm)	Actual output power (dBm)	Actual output power (dBm)	
5 MHz	1RB High (24)	695.5	24.01	23.21	22.27	
		680.5	24.05	23.32	22.23	
		665.5	24.10	23.37	22.22	
	1RB Middle (12)	695.5	24.34	23.60	22.60	
		680.5	24.33	23.64	22.47	
		665.5	24.33	23.60	22.47	
	1RB Low (0)	695.5	24.03	23.27	22.22	
		680.5	24.13	23.38	22.26	
		665.5	24.09	23.35	22.23	
	12RB High (13)	695.5	23.16	22.15	21.18	
		680.5	23.21	22.22	21.21	
		665.5	23.28	22.24	21.25	
	12RB Middle (6)	695.5	23.24	22.25	21.24	
		680.5	23.27	22.27	21.26	
		665.5	23.31	22.26	21.28	
	12RB Low (0)	695.5	23.21	22.20	21.22	
		680.5	23.25	22.20	21.25	
		665.5	23.20	22.17	21.17	
	25RB (0)	695.5	23.21	22.23	21.22	
		680.5	23.23	22.25	21.23	
		665.5	23.25	22.21	21.23	
	10 MHz	1RB High (49)	693	24.09	23.27	22.18
			680.5	24.12	23.40	22.34
			668	24.18	23.47	22.37
1RB Middle (24)		693	24.26	23.49	22.43	
		680.5	24.32	23.47	22.53	
		668	24.33	23.60	22.43	
1RB Low (0)		693	24.16	23.41	22.25	
		680.5	24.20	23.47	22.38	
		668	24.20	23.44	22.31	
25RB High (25)		693	23.19	22.17	21.17	
		680.5	23.24	22.23	21.23	
		668	23.33	22.35	21.33	
25RB Middle (12)		693	23.25	22.23	21.22	
		680.5	23.27	22.29	21.27	
		668	23.33	22.30	21.31	
25RB Low (0)		693	23.36	22.34	21.34	
		680.5	23.33	22.32	21.31	
		668	23.28	22.26	21.24	
50RB		693	23.25	22.25	21.24	

	(0)	680.5	23.28	22.29	21.28
		668	23.32	22.30	21.30
15 MHz	1RB High (74)	690.5	24.06	23.24	22.27
		680.5	24.10	23.34	22.22
		670.5	24.09	23.32	22.27
	1RB Middle (37)	690.5	24.17	23.42	22.40
		680.5	24.21	23.41	22.38
		670.5	24.26	23.56	22.42
	1RB Low (0)	690.5	24.16	23.40	22.34
		680.5	24.20	23.46	22.35
		670.5	24.17	23.37	22.35
	36RB High (38)	690.5	23.21	22.19	21.18
		680.5	23.21	22.19	21.21
		670.5	23.27	22.21	21.22
	36RB Middle (19)	690.5	23.22	22.21	21.20
		680.5	23.26	22.25	21.23
		670.5	23.29	22.25	21.27
	36RB Low (0)	690.5	23.27	22.20	21.25
		680.5	23.30	22.29	21.30
		670.5	23.26	22.23	21.24
	75RB (0)	690.5	23.23	22.26	21.21
		680.5	23.26	22.24	21.24
		670.5	23.23	22.23	21.21
20 MHz	1RB High (99)	688	23.92	23.21	22.24
		683	23.98	23.19	22.14
		673	23.97	23.23	22.15
	1RB Middle (50)	688	24.27	23.57	22.41
		683	24.26	23.45	22.39
		673	24.29	23.50	22.41
	1RB Low (0)	688	24.13	23.35	22.36
		683	24.14	23.46	22.29
		673	24.08	23.36	22.29
	50RB High (50)	688	23.13	22.15	21.12
		683	23.18	22.21	21.17
		673	23.16	22.21	21.16
	50RB Middle (25)	688	23.25	22.28	21.25
		683	23.27	22.26	21.23
		673	23.27	22.25	21.25
	50RB Low (0)	688	23.25	22.25	21.25
		683	23.33	22.33	21.30
		673	23.14	22.19	21.17
	100RB (0)	688	23.16	22.18	21.21
		683	23.27	22.27	21.25
		673	23.18	22.18	21.11

Uplink maximum output power is measured with downlink carrier aggregation active, using the channel with highest measured maximum output power when downlink carrier aggregation is inactive. SAR test is not required since maximum output power when downlink carrier aggregation active is not more than ¼ dB higher than the maximum output power measured when downlink carrier aggregation inactive.

UL LTE CA Class	PCC				SCC				Power	
	PCC Bandwidth	channel	RB	RB OFFSET	SCC Bandwidth	channel	RB	RB OFFSET	tune up	conducted power (dBm)
CA 41C	20M	39750	1	99	5M	39867	1	0	25	23.1
CA 41C	15M	39725	1	74	10M	39845	1	0	25	23.84
CA 41C	20M	39750	1	99	10M	39894	1	0	25	23.79
CA 41C	20M	39750	1	99	15M	39921	1	0	25	23.82
CA 41C	20M	39750	1	99	20M	39948	1	0	25	23.8
CA 41C	15M	41515	1	74	10M	41395	1	0	25	24.16
CA 41C	15M	39725	1	0	10M	39845	1	49	25	23.88
CA 41C	20M	41490	1	0	5M	41373	1	24	25	23.3
CA 41C	15M	41515	1	0	10M	41395	1	49	25	24.27
CA 41C	20M	41490	1	0	10M	41346	1	49	25	24.25
CA 41C	15M	41515	1	0	15M	41365	1	74	25	24.24
CA 41C	20M	41490	1	0	15M	41319	1	74	25	24.22
CA 41C	20M	41490	1	0	20M	41292	1	99	25	24.26

The conducted power measurement results of downlink LTE CA Conducted Power are as below (Normal Power):

DL LTE CA Class	PCC								SCC			Power	
	PC Band	PCC Band width (MHz)	PCC UL RB size	PCC UL RB offset	PCC DL RB size	PCC DL RB offset	PCC UL Channel	PCC DL Channel	SCC Band	SCC Band width (MHz)	SCC DL Channel	Rel 8 LTE Tx Power (dBm)	Rel 10 DL LTE CA Tx Power (dBm)
41C PC2	41	20	1	50	100	0	41490	41490	41	20	41292	27.26	24.37
41A-41A PC2	41	20	1	50	100	0	41490	41490	41	20	39750	27.26	24.36
41C PC3	41	20	1	50	100	0	41490	41490	41	20	41292	24.36	24.38
41A-41A PC3	41	20	1	50	100	0	41490	41490	41	20	39750	24.36	24.37
66C	66	20	1	50	100	0	132572	67036	66	20	66838	24.34	24.27
66B	66	10	1	24	50	0	132622	1775	66	10	66987	24.33	24.29
66A-5A	66	3	1	7	15	0	131987	66451	5	10	2525	24.44	24.42
66A-12A	66	3	1	7	15	0	131987	66451	12	10	5095	24.44	24.38
66A-71A	66	3	1	7	15	0	131987	66451	71	20	68786	24.44	24.40
66A-66A	66	20	1	50	100	0	132572	67036	66	20	66536	24.34	24.41
12A-66A	12	5	1	12	25	0	23035	5035	66	20	66786	24.68	24.61
71A-66A	71	5	1	12	25	0	133447	68911	66	20	66786	24.34	22.32

The conducted power measurement results of downlink LTE CA Conducted Power are as below (Low Power):

DL LTE CA Class	PCC								SCC			Power	
	PC Band	PCC Band width (MHz)	PCC UL RB size	PCC UL RB offset	PCC DL RB size	PCC DL RB offset	PCC UL Channel	PCC DL Channel	SCC Band	SCC Band width (MHz)	SCC DL Channel	Rel 8 LTE Tx Power (dBm)	Rel 10 DL LTE CA Tx Power (dBm)
66C	66	20	1	50	100	0	132572	67036	66	20	66838	21.48	21.24
66B	66	10	1	24	50	0	132622	1775	66	10	66987	21.29	21.13
66A-5A	66	20	1	50	100	0	132322	66786	5	10	2525	21.49	21.1
66A-12A	66	20	1	50	100	0	132322	66786	12	10	5095	21.49	21.33
66A-71A	66	20	1	50	100	0	132322	66786	71	20	68786	21.49	21.25
66A-66A	66	20	1	50	100	0	132572	67036	66	20	66536	21.48	21.13



### 11.4 Wi-Fi and BT Measurement result

The maximum output power of BT is 9.26dBm.

The maximum tune up of BT is 10dBm.

Normal power by Receiver off, Low power by Receiver on.

The average conducted power for Wi-Fi is as following:

Normal Power

802.11b(dBm)								
Channel\data rate	1Mbps	2Mbps	5.5Mbps	11Mbps				
11(2462MHz)	21.43	/	/	/				
6(2437MHz)	21.52	21.49	21.29	21.22				
1(2412MHz)	20.95	/	/	/				
Tune up	21.80	21.80	21.80	21.80				
802.11g(dBm)								
Channel\data rate	6Mbps	9Mbps	12Mbps	18Mbps	24Mbps	36Mbps	48Mbps	54Mbps
11(2462MHz)	19.65	/	/	/	/	/	/	/
6(2437MHz)	19.73	19.49	19.39	19.45	18.65	18.78	17.26	17.15
1(2412MHz)	19.10	/	/	/	/	/	/	/
Tune up	19.80	19.80	19.80	19.80	18.80	18.80	17.80	17.80
802.11n(dBm)-20MHz								
Channel\data rate	MCS0	MCS1	MCS2	MCS3	MCS4	MCS5	MCS6	MCS7
11(2462MHz)	18.48	18.34	18.35	18.31	18.29	17.09	17.01	16.93
6(2437MHz)	18.39	/	/	/	/	/	/	/
1(2412MHz)	17.64	/	/	/	/	/	/	/
Tune up	18.80	18.80	18.80	18.80	18.80	17.80	17.80	17.80

Channel\data rate	6Mbps	9Mbps	12Mbps	18Mbps	24Mbps	36Mbps	48Mbps	54Mbps
36(5180 MHz)	18.60	18.58	18.52	17.30	17.28	17.29	16.10	16.01
40(5200 MHz)	18.55							
44(5220 MHz)	18.20							
48(5240 MHz)	<b>17.90</b>							
52(5260 MHz)	<b>18.00</b>							
56(5280 MHz)	18.11							
60(5300 MHz)	18.27							
64(5320 MHz)	18.46	18.45	18.30	17.12	17.10	17.08	15.82	15.70
Tune up	19.50	19.50	19.50	18.50	18.50	18.50	17.50	17.50
100(5500 MHz)	19.12							
104(5520 MHz)	18.90							
108(5540 MHz)	<b>18.70</b>							
112(5560 MHz)	18.63							
116(5580 MHz)	18.46							
120(5600 MHz)	18.45							
124(5620 MHz)	18.90							
128(5640 MHz)	18.95							
132(5660 MHz)	19.10							
136(5680 MHz)	19.20							
140(5700 MHz)	19.64	19.62	19.58	18.40	18.39	18.35	17.12	17.14
144(5720 MHz)	19.52							
Tune up	20.00	20.00	20.00	18.50	18.50	18.50	17.50	17.50
149(5745 MHz)	19.20							
153(5765 MHz)	19.15							
157(5785 MHz)	19.07							
161(5805 MHz)	<b>19.89</b>	19.50	19.43	18.26	18.25	18.12	17.00	16.96
165(5825 MHz)	19.78							
Tune up	20.00	20.00	20.00	18.50	18.50	18.50	17.50	17.50





Low Power

802.11b(dBm)								
Channel\data rate	1Mbps	2Mbps	5.5Mbps	11Mbps				
11(2462MHz)	17.69	17.55	17.46	17.41				
6(2437MHz)	17.66							
1(2412MHz)	17.11							
Tune up	18.80	18.80	18.80	18.80				

802.11g(dBm)								
Channel\data rate	6Mbps	9Mbps	12Mbps	18Mbps	24Mbps	36Mbps	48Mbps	54Mbps
11(2462MHz)	17.48	17.47	17.46	17.43	16.47	16.49	15.54	15.55
6(2437MHz)	17.45	/	/	/	/	/	/	/
1(2412MHz)	16.70	/	/	/	/	/	/	/
Tune up	17.80	17.80	17.80	17.80	16.80	16.80	15.80	15.80

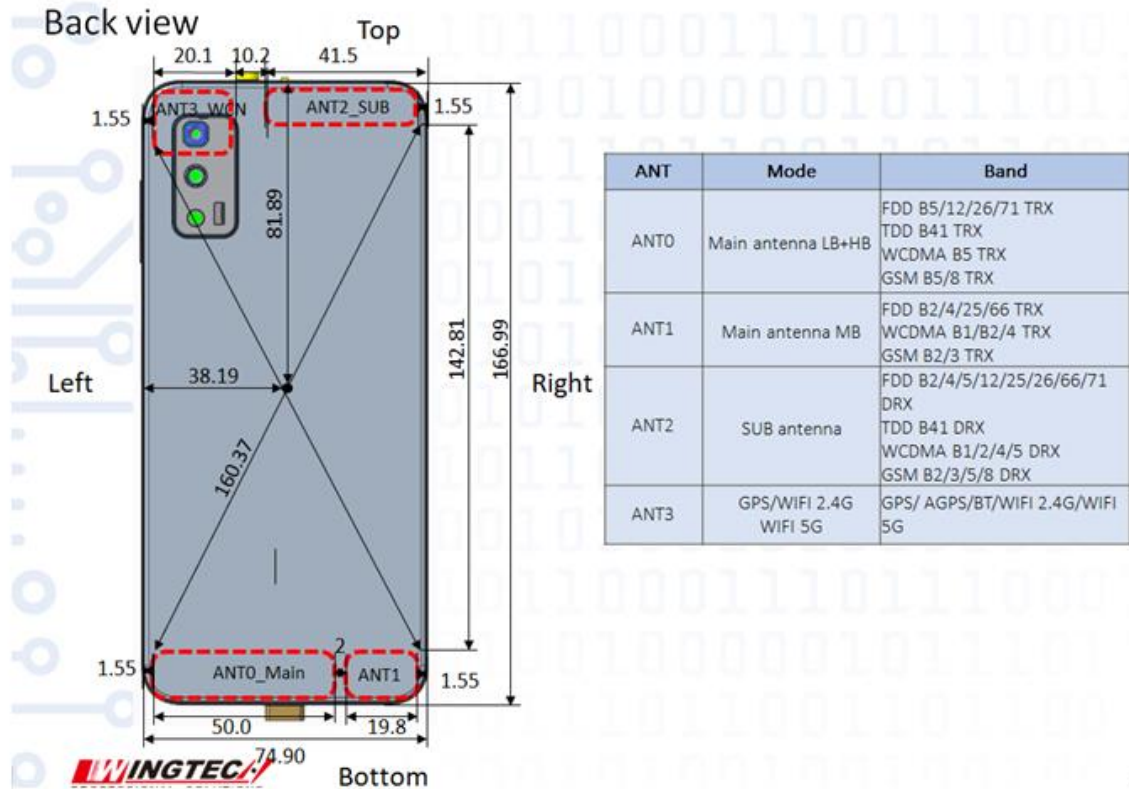
  

802.11n(dBm)-20MHz								
Channel\data rate	MCS0	MCS1	MCS2	MCS3	MCS4	MCS5	MCS6	MCS7
11(2462MHz)	16.86	16.83	16.82	16.83	16.81	15.36	15.38	15.39
6(2437MHz)	16.84	/	/	/	/	/	/	/
1(2412MHz)	16.11	/	/	/	/	/	/	/
Tune up	17.00	17.00	17.00	17.00	17.00	15.80	15.80	15.80

802.11ac(dBm)-80MHz										
Channel\data rate	MCS0	MCS1	MCS2	MCS3	MCS4	MCS5	MCS6	MCS7	MCS8	MCS9
42(5210 MHz)	<b>13.83</b>	13.80	13.82	13.81	13.78	13.44	13.43	13.41	12.43	11.45
58(5290 MHz)	<b>13.65</b>	13.62	13.59	13.58	13.57	13.10	13.09	13.11	12.25	11.24
106(5530 MHz)	<b>13.30</b>	/	/	/	/	/	/	/	/	/
122(5610 MHz)	13.55	/	/	/	/	/	/	/	/	/
138(5690 MHz)	14.20	14.13	14.15	14.19	13.90	14.12	14.07	14.04	13.15	12.19
155(5775 MHz)	<b>13.91</b>	13.43	13.63	13.42	13.52	12.78	13.07	13.04	12.46	11.45
Tune up	15.00	15.00	15.00	15.00	15.00	15.00	15.00	15.00	14.00	13.00

## 12 Simultaneous TX SAR Considerations

### 12.1 Transmit Antenna Separation Distances



Picture 12.1 Antenna Locations

### 12.2 SAR Measurement Positions

According to the KDB941225 D06 Hot Spot SAR v01, the edges with less than 2.5 cm distance to the antennas need to be tested for SAR.

SAR measurement positions						
Mode	Front	Rear	Left edge	Right edge	Top edge	Bottom edge
ANT0	Yes	Yes	Yes	Yes	No	Yes
ANT1	Yes	Yes	Yes	No	No	Yes
ANT3	Yes	Yes	Yes	No	Yes	No

### 12.3 Standalone SAR Test Exclusion Considerations

Standalone 1-g head or body SAR evaluation by measurement or numerical simulation is not required when the corresponding SAR Exclusion Threshold condition, listed below, is satisfied. The 1-g SAR test exclusion threshold for 100 MHz to 6 GHz at test separation distances  $\leq 50$  mm are determined by:

$[(\text{max. power of channel, including tune-up tolerance, mW}) / (\text{min. test separation distance, mm})] \cdot [\sqrt{f(\text{GHz})}] \leq 3.0$  for 1-g SAR, where

- $f(\text{GHz})$  is the RF channel transmit frequency in GHz
- Power and distance are rounded to the nearest mW and mm before calculation
- The result is rounded to one decimal place for comparison

**Table 12.1: Standalone SAR test exclusion considerations**

Band/Mode	F(GHz)	Position	SAR test exclusion threshold(mW)	RF output power		SAR test exclusion
				dBm	mW	
Bluetooth	2.441	Head	9.60	10	10.00	No
		Body	19.20	10	10.00	No
2.4GHz WLAN	2.45	Head	9.58	21.8	151.36	No
		Body	19.17	21.8	151.36	No
5GHz WLAN	5.2	Head	6.58	19.5	89.13	No
		Body	13.16	19.5	89.13	No
	5.3	Head	6.52	19.5	89.13	No
		Body	13.03	19.5	89.13	No
	5.6	Head	6.34	20	100.00	No
		Body	12.68	20	100.00	No
	5.8	Head	6.23	20	100.00	No
		Body	12.46	20	100.00	No

### 13 Evaluation of Simultaneous

**Table 13.1: The sum of SAR values for Main antenna + WiFi-2.4G**

	Position	Band	Cellular antenna	WiFi-2.4G	Sum
<b>Highest reported SAR value for Head</b>	Left hand, Cheek	WCDMA1900	0.55	0.76	<b>1.31</b>
<b>Highest SAR value for Body</b>	Rear 10mm	GSM850	0.92	0.49	<b>1.41</b>

**Table 13.2: The sum of SAR values for Main antenna + WiFi-5G**

	Position	Band	Cellular antenna	WiFi-5G	Sum
<b>Highest SAR value for Head</b>	Left hand, Cheek	WCDMA1900	0.55	0.78	<b>1.33</b>
<b>Maximum reported SAR value for Body</b>	Rear 10mm	GSM850	0.92	0.41	<b>1.33</b>

**Table 13.3: The sum of SAR values for Main antenna + WiFi-5G +BT**

	Position	Band	Cellular antenna	WiFi-5G	BT	Sum
<b>Highest SAR value for Head</b>	Left hand, Cheek	WCDMA1900	0.55	0.78	<0.01	<b>1.33</b>
<b>Maximum reported SAR value for Body</b>	Rear 10mm	GSM850	0.92	0.41	<0.01	<b>1.33</b>

Note1: the test positions of above tables are for the worse case that have been evaluated.

[1] – The SAR of BT is too low to get it, so the “<0.01” is used to indicate the head SAR of BT.

## 14 SAR Test Result

It is determined by user manual for the distance between the EUT and the phantom bottom. The distance is 10 mm or 15mm and just applied to the condition of body worn accessory.

It is performed for all SAR measurements with area scan based 1-g SAR estimation (Fast SAR). A zoom scan measurement is added when the estimated 1-gSAR is the highest measured SAR in each exposure configuration, wireless mode and frequency band combination or more than 1.2W/kg.

The calculated SAR is obtained by the following formula:

$$\text{Reported SAR} = \text{Measured SAR} \times 10^{(P_{\text{Target}} - P_{\text{Measured}})/10}$$

Where  $P_{\text{Target}}$  is the power of manufacturing upper limit;

$P_{\text{Measured}}$  is the measured power in chapter 11.

**Table 14.1: Duty Cycle**

<b>Mode</b>	<b>Duty Cycle</b>
Speech for GSM850/1900	1:4
GPRS&EGPRS for GSM850	1:4
GPRS&EGPRS for GSM1900	1:2
WCDMA&LTE FDD	1:1
LTE B41 PC2	1:2.309
LTE B41 PC3	1:1.58

### 14.1 SAR results for Fast SAR

**Table 14.1-1: SAR Values (GSM 850 MHz Band - Head)**

Frequency		Side	Test Position	Figure No.	Conducted Power (dBm)	Max. tune-up Power (dBm)	Measured SAR(10g) (W/kg)	Reported SAR(10g) (W/kg)	Measured SAR(1g) (W/kg)	Reported SAR(1g) (W/kg)	Power Drift (dB)
Ch.	MHz										
190	836.6	Left	Touch	/	31.46	32.50	0.271	<b>0.34</b>	0.347	<b>0.44</b>	-0.18
190	836.6	Left	Tilt	/	31.46	32.50	0.151	<b>0.19</b>	0.186	<b>0.24</b>	-0.06
251	848.8	Right	Touch	Fig.1	31.42	32.50	0.324	<b>0.42</b>	0.409	<b>0.52</b>	0.03
190	836.6	Right	Touch	/	31.46	32.50	0.290	<b>0.37</b>	0.379	<b>0.48</b>	0.12
128	824.2	Right	Touch	/	31.43	32.50	0.285	<b>0.36</b>	0.361	<b>0.46</b>	-0.18
190	836.6	Right	Tilt	/	31.46	32.50	0.169	<b>0.21</b>	0.208	<b>0.26</b>	0.16

Note: the head SAR of GSM850 is tested with GPRS (2Txslots) mode because of VoIP.

**Table 14.1-2: SAR Values (GSM 850 MHz Band - Body)**

Frequency		Mode (number of timeslots)	Test Position	Figure No.	Conducted Power (dBm)	Max. tune-up Power (dBm)	Measured SAR(10g) (W/kg)	Reported SAR(10g) (W/kg)	Measured SAR(1g) (W/kg)	Reported SAR(1g) (W/kg)	Power Drift (dB)
Ch.	MHz										
190	836.6	GPRS (2)	Front	/	31.46	32.50	0.267	<b>0.34</b>	0.435	<b>0.55</b>	0.09
251	848.8	GPRS (2)	Rear	/	31.42	32.50	0.392	<b>0.50</b>	0.686	<b>0.88</b>	-0.12
190	836.6	GPRS (2)	Rear	Fig.2	31.46	32.50	0.433	<b>0.55</b>	0.723	<b>0.92</b>	-0.12
128	824.2	GPRS (2)	Rear	/	31.43	32.50	0.405	<b>0.52</b>	0.673	<b>0.86</b>	-0.10
190	836.6	GPRS (2)	Left	/	31.46	32.50	0.146	<b>0.19</b>	0.217	<b>0.28</b>	0.05
190	836.6	GPRS (2)	Right	/	31.46	32.50	0.267	<b>0.34</b>	0.411	<b>0.52</b>	-0.13
190	836.6	GPRS (2)	Bottom	/	31.46	32.50	0.303	<b>0.38</b>	0.552	<b>0.70</b>	-0.06
190	836.6	EGPRS (2)	Rear	/	31.46	32.50	0.420	<b>0.53</b>	0.716	<b>0.91</b>	0.11

Note: The distance between the EUT and the phantom bottom is 10mm.

**Table 14.1-3: SAR Values (GSM 1900 MHz Band - Head)**

Frequency		Side	Test Position	Figure No.	Conducted Power (dBm)	Max. tune-up Power (dBm)	Measured SAR(10g) (W/kg)	Reported SAR(10g) (W/kg)	Measured SAR(1g) (W/kg)	Reported SAR(1g) (W/kg)	Power Drift (dB)
Ch.	MHz										
810	1909.8	Left	Touch	Fig.3	28.11	29.00	0.185	<b>0.23</b>	0.290	<b>0.36</b>	-0.17
661	1880	Left	Touch	/	27.87	29.00	0.143	<b>0.19</b>	0.221	<b>0.29</b>	0.04
512	1850.2	Left	Touch	/	28.07	29.00	0.124	<b>0.15</b>	0.192	<b>0.24</b>	0.19
661	1880	Left	Tilt	/	27.87	29.00	0.078	<b>0.10</b>	0.179	<b>0.23</b>	-0.19
661	1880	Right	Touch	/	27.87	29.00	0.080	<b>0.10</b>	0.179	<b>0.23</b>	-0.04
661	1880	Right	Tilt	/	27.87	29.00	0.070	<b>0.09</b>	0.120	<b>0.16</b>	-0.11

Note: the head SAR of GSM1900 is tested with GPRS (2Txslots) mode because of VoIP.

**Table 14.1-4: SAR Values (GSM 1900 MHz Band - Body)**

Frequency		Mode (number of timeslots)	Test Position	Figure No./ Note	Conducte d Power (dBm)	Max. tune-up Power (dBm)	Measured SAR(10g) (W/kg)	Reported SAR(10g) (W/kg)	Measured SAR(1g) (W/kg)	Reported SAR(1g) (W/kg)	Power Drift (dB)
Ch.	MHz										
661	1880	GPRS (2)	Front	Note1	27.87	29.00	0.294	<b>0.38</b>	0.481	<b>0.62</b>	0.13
810	1909.8	GPRS (2)	Rear	Note1	28.11	29.00	0.309	<b>0.38</b>	0.517	<b>0.63</b>	0.12
661	1880	GPRS (2)	Rear	Note1 Fig.4	27.87	29.00	0.340	<b>0.44</b>	0.59	<b>0.77</b>	0.16
512	1850.2	GPRS (2)	Rear	Note1	28.07	29.00	0.230	<b>0.28</b>	0.388	<b>0.48</b>	0.09
661	1880	GPRS (2)	Left	/	27.87	29.00	0.286	<b>0.37</b>	0.494	<b>0.64</b>	0.19
661	1880	GPRS (2)	Bottom	Note1	27.87	29.00	0.249	<b>0.32</b>	0.412	<b>0.53</b>	0.18
661	1880	GPRS (4)	Front	/	22.66	23.00	0.326	<b>0.35</b>	0.541	<b>0.59</b>	0.13
661	1880	GPRS (4)	Rear	/	22.66	23.00	0.317	<b>0.34</b>	0.573	<b>0.62</b>	-0.01
661	1880	GPRS (4)	Bottom	/	22.66	23.00	0.247	<b>0.27</b>	0.449	<b>0.49</b>	-0.12
661	1880	EGPRS (2)	Rear	Note1	27.84	29.00	0.321	<b>0.42</b>	0.564	<b>0.74</b>	0.11

Note: The distance between the EUT and the phantom bottom is 10mm.

Note1: The distance between the EUT and the phantom bottom is 14mm.

**Table 14.1-5: SAR Values (WCDMA 1900 MHz Band - Head)**

Frequency		Side	Test Position	Figure No.	Conducted Power (dBm)	Max. tune-up Power (dBm)	Measured SAR(10g) (W/kg)	Reported SAR(10g) (W/kg)	Measured SAR(1g) (W/kg)	Reported SAR(1g) (W/kg)	Power Drift (dB)
Ch.	MHz										
9938	1907.6	Left	Touch	/	23.39	24.50	0.218	<b>0.28</b>	0.328	<b>0.42</b>	0.01
9800	1880	Left	Touch	Fig.5	23.46	24.50	0.252	<b>0.32</b>	0.383	<b>0.49</b>	0.00
9662	1852.4	Left	Touch	/	23.51	24.50	0.219	<b>0.28</b>	0.329	<b>0.41</b>	0.05
9800	1880	Left	Tilt	/	23.46	24.50	0.160	<b>0.20</b>	0.248	<b>0.32</b>	-0.01
9800	1880	Right	Touch	/	23.46	24.50	0.166	<b>0.21</b>	0.257	<b>0.33</b>	0.06
9800	1880	Right	Tilt	/	23.46	24.50	0.114	<b>0.14</b>	0.184	<b>0.23</b>	0.17

**Table 14.1-6: SAR Values (WCDMA 1900 MHz Band - Body)**

Frequency		Test Position	Figure No./ Note	Conducte d Power (dBm)	Max. tune-up Power (dBm)	Measured SAR(10g) (W/kg)	Reported SAR(10g) (W/kg)	Measured SAR(1g) (W/kg)	Reported SAR(1g) (W/kg)	Power Drift (dB)
Ch.	MHz									
9800	1880	Front	Note1	23.46	24.50	0.364	<b>0.46</b>	0.557	<b>0.71</b>	0.17
9938	1907.6	Rear	Note1 Fig.6	23.39	24.50	0.500	<b>0.65</b>	0.882	<b>1.14</b>	-0.07
9800	1880	Rear	Note1	23.46	24.50	0.435	<b>0.55</b>	0.775	<b>0.98</b>	0.12
9662	1852.4	Rear	Note1	23.51	24.50	0.367	<b>0.46</b>	0.658	<b>0.83</b>	-0.08
9800	1880	Left	/	23.46	24.50	0.279	<b>0.35</b>	0.484	<b>0.61</b>	-0.15
9800	1880	Bottom	Note1	23.46	24.50	0.309	<b>0.39</b>	0.552	<b>0.70</b>	-0.13
9800	1880	Front	/	19.30	21.00	0.230	<b>0.34</b>	0.355	<b>0.53</b>	0.14
9938	1907.6	Rear	/	19.30	21.00	0.339	<b>0.50</b>	0.635	<b>0.94</b>	0.19

9800	1880	Rear	/	19.27	21.00	0.352	<b>0.52</b>	0.643	<b>0.96</b>	0.03
9662	1852.4	Rear	/	19.35	21.00	0.324	<b>0.47</b>	0.594	<b>0.87</b>	0.07
9800	1880	Bottom	/	19.27	21.00	0.244	<b>0.36</b>	0.429	<b>0.64</b>	0.17

Note: The distance between the EUT and the phantom bottom is 10mm.

Note1: The distance between the EUT and the phantom bottom is 14mm.

**Table 14.1-7: SAR Values (WCDMA 1700 MHz Band - Head)**

Frequency		Side	Test Position	Figure No.	Conducted Power (dBm)	Max. tune-up Power (dBm)	Measured SAR(10g) (W/kg)	Reported SAR(10g) (W/kg)	Measured SAR(1g) (W/kg)	Reported SAR(1g) (W/kg)	Power Drift (dB)
Ch.	MHz										
1513	1752.6	Left	Touch	Fig.7	23.56	25.00	0.203	<b>0.28</b>	0.300	<b>0.42</b>	-0.16
1412	1732.4	Left	Touch	/	23.49	25.00	0.166	<b>0.24</b>	0.245	<b>0.35</b>	0.03
1312	1712.4	Left	Touch	/	23.38	25.00	0.196	<b>0.28</b>	0.291	<b>0.42</b>	-0.01
1412	1732.4	Left	Tilt	/	23.49	25.00	0.101	<b>0.14</b>	0.146	<b>0.21</b>	-0.12
1412	1732.4	Right	Touch	/	23.49	25.00	0.150	<b>0.21</b>	0.221	<b>0.31</b>	-0.15
1412	1732.4	Right	Tilt	/	23.49	25.00	0.065	<b>0.09</b>	0.103	<b>0.15</b>	0.09

**Table 14.1-8: SAR Values (WCDMA 1700 MHz Band - Body)**

Frequency		Test Position	Figure No./ Note	Conducted Power (dBm)	Max. tune-up Power (dBm)	Measured SAR(10g) (W/kg)	Reported SAR(10g) (W/kg)	Measured SAR(1g) (W/kg)	Reported SAR(1g) (W/kg)	Power Drift (dB)
Ch.	MHz									
9800	1880	Front	Note1	23.49	25.00	0.201	<b>0.28</b>	0.321	<b>0.45</b>	0.12
9800	1880	Rear	Note1	23.49	25.00	0.323	<b>0.46</b>	0.485	<b>0.69</b>	0.18
9800	1880	Left	/	23.49	25.00	0.233	<b>0.33</b>	0.364	<b>0.52</b>	-0.15
9800	1880	Bottom	Note1	23.49	25.00	0.313	<b>0.44</b>	0.456	<b>0.65</b>	0.07
9938	1907.6	Front	/	20.42	22.00	0.250	<b>0.36</b>	0.415	<b>0.60</b>	0.13
9800	1880	Front	/	20.36	22.00	0.352	<b>0.51</b>	0.568	<b>0.83</b>	0.16
9662	1852.4	Front	/	20.44	22.00	0.291	<b>0.42</b>	0.485	<b>0.69</b>	0.09
9938	1907.6	Rear	/	20.42	22.00	0.267	<b>0.38</b>	0.435	<b>0.63</b>	0.08
9800	1880	Rear	Fig.8	20.36	22.00	0.376	<b>0.55</b>	0.595	<b>0.87</b>	-0.18
9662	1852.4	Rear	/	20.44	22.00	0.311	<b>0.45</b>	0.508	<b>0.73</b>	0.18
9800	1880	Bottom	/	20.36	22.00	0.298	<b>0.43</b>	0.488	<b>0.71</b>	-0.05

Note: The distance between the EUT and the phantom bottom is 10mm.

Note1: The distance between the EUT and the phantom bottom is 14mm.



**Table 14.1-9: SAR Values (WCDMA 850 MHz Band - Head)**

Frequency		Side	Test Position	Figure No.	Conducted Power (dBm)	Max. tune-up Power (dBm)	Measured SAR(10g) (W/kg)	Reported SAR(10g) (W/kg)	Measured SAR(1g) (W/kg)	Reported SAR(1g) (W/kg)	Power Drift (dB)
Ch.	MHz										
4182	836.4	Left	Touch	/	23.44	25.00	0.192	<b>0.27</b>	0.247	<b>0.35</b>	-0.05
4182	836.4	Left	Tilt	/	23.44	25.00	0.107	<b>0.15</b>	0.131	<b>0.19</b>	-0.02
4233	846.6	Right	Touch	/	23.49	25.00	0.214	<b>0.30</b>	0.270	<b>0.38</b>	-0.04
4182	836.4	Right	Touch	Fig.9	23.44	25.00	0.224	<b>0.32</b>	0.282	<b>0.40</b>	0.05
4132	826.4	Right	Touch	/	23.48	25.00	0.213	<b>0.30</b>	0.268	<b>0.38</b>	-0.06
4182	836.4	Right	Tilt	/	23.44	25.00	0.120	<b>0.17</b>	0.147	<b>0.21</b>	-0.06

**Table 14.1-10: SAR Values (WCDMA 850 MHz Band - Body)**

Frequency		Test Position	Figure No.	Conducted Power (dBm)	Max. tune-up Power (dBm)	Measured SAR(10g) (W/kg)	Reported SAR(10g) (W/kg)	Measured SAR(1g) (W/kg)	Reported SAR(1g) (W/kg)	Power Drift (dB)
Ch.	MHz									
4182	836.4	Front	/	23.44	25.00	0.191	<b>0.27</b>	0.322	<b>0.46</b>	0.07
4233	846.6	Rear	/	23.49	25.00	0.303	<b>0.43</b>	0.505	<b>0.71</b>	0.17
4182	836.4	Rear	Fig.10	23.44	25.00	0.336	<b>0.48</b>	0.570	<b>0.82</b>	-0.05
4132	826.4	Rear	/	23.48	25.00	0.325	<b>0.46</b>	0.546	<b>0.77</b>	-0.17
4182	836.4	Left	/	23.44	25.00	0.120	<b>0.17</b>	0.185	<b>0.26</b>	0.10
4182	836.4	Right	/	23.44	25.00	0.223	<b>0.32</b>	0.336	<b>0.48</b>	-0.07
4182	836.4	Bottom	/	23.44	25.00	0.237	<b>0.34</b>	0.438	<b>0.63</b>	0.17

Note: The distance between the EUT and the phantom bottom is 10mm.

**Table 14.1-11: SAR Values (LTE Band12 - Head)**

Frequency		Mode	Side	Test Position	Figure No.	Conducted Power (dBm)	Max. tune-up Power (dBm)	Measured SAR(10g) (W/kg)	Reported SAR(10g) (W/kg)	Measured SAR(1g) (W/kg)	Reported SAR(1g) (W/kg)	Power Drift (dB)
Ch.	MHz											
23060	704	1RB_Mid	Left	Touch	/	24.47	25.00	0.167	<b>0.19</b>	0.205	<b>0.23</b>	-0.17
23060	704	1RB_Mid	Left	Tilt	/	24.47	25.00	0.113	<b>0.13</b>	0.137	<b>0.15</b>	0.11
23060	704	1RB_Mid	Right	Touch	Fig.11	24.47	25.00	0.170	<b>0.19</b>	0.209	<b>0.24</b>	-0.18
23060	704	1RB_Mid	Right	Tilt	/	24.47	25.00	0.064	<b>0.07</b>	0.077	<b>0.09</b>	-0.17
23060	704	25RB_Low	Left	Touch	/	23.51	24.00	0.127	<b>0.14</b>	0.156	<b>0.17</b>	-0.11
23060	704	25RB_Low	Left	Tilt	/	23.51	24.00	0.087	<b>0.10</b>	0.105	<b>0.12</b>	0.08
23060	704	25RB_Low	Right	Touch	/	23.51	24.00	0.130	<b>0.15</b>	0.154	<b>0.17</b>	-0.15
23060	704	25RB_Low	Right	Tilt	/	23.51	24.00	0.044	<b>0.05</b>	0.054	<b>0.06</b>	0.12

Note1: The LTE mode is QPSK\_10MHz.

**Table 14.1-12: SAR Values (LTE Band12 - Body)**

Frequency		Mode	Test Position	Figure No.	Conduct ed Power (dBm)	Max. tune-up Power (dBm)	Measured SAR(10g) (W/kg)	Reported SAR(10g) (W/kg)	Measured SAR(1g) (W/kg)	Reported SAR(1g) (W/kg)	Power Drift (dB)
Ch.	MHz										
23060	704	1RB_Mid	Front	/	24.47	25.00	0.164	<b>0.19</b>	0.208	<b>0.23</b>	-0.01
23060	704	1RB_Mid	Rear	Fig.12	24.47	25.00	0.305	<b>0.34</b>	0.386	<b>0.44</b>	-0.12
23060	704	1RB_Mid	Left	/	24.47	25.00	0.200	<b>0.23</b>	0.275	<b>0.31</b>	0.13
23060	704	1RB_Mid	Right	/	24.47	25.00	0.209	<b>0.24</b>	0.290	<b>0.33</b>	0
23060	704	1RB_Mid	Bottom	/	24.47	25.00	0.116	<b>0.13</b>	0.205	<b>0.23</b>	0.15
23060	704	25RB_Low	Front	/	23.51	24.00	0.135	<b>0.15</b>	0.172	<b>0.19</b>	0.12
23060	704	25RB_Low	Rear	/	23.51	24.00	0.227	<b>0.25</b>	0.293	<b>0.33</b>	-0.05
23060	704	25RB_Low	Left	/	23.51	24.00	0.249	<b>0.28</b>	0.344	<b>0.39</b>	0.04
23060	704	25RB_Low	Right	/	23.51	24.00	0.115	<b>0.13</b>	0.217	<b>0.24</b>	0.05
23060	704	25RB_Low	Bottom	/	23.51	24.00	0.093	<b>0.10</b>	0.166	<b>0.19</b>	-0.05

Note1: The distance between the EUT and the phantom bottom is 10mm

Note2: The LTE mode is QPSK\_10MHz.

**Table 14.1-13: SAR Values (LTE Band25 - Head)**

Frequency		Mode	Side	Test Position	Figure No.	Conducte d Power (dBm)	Max. tune-up Power (dBm)	Measure d SAR(10g) (W/kg)	Reported SAR(10g) (W/kg)	Measure d SAR(1g) (W/kg)	Reporte d SAR(1g) (W/kg)	Powe r Drift (dB)
Ch.	MHz											
26140	1860	1RB_Mid	Left	Touch	Fig.13	24.43	25.00	0.221	<b>0.25</b>	0.331	<b>0.38</b>	-0.02
26140	1860	1RB_Mid	Left	Tilt	/	24.43	25.00	0.115	<b>0.13</b>	0.185	<b>0.21</b>	0.02
26140	1860	1RB_Mid	Right	Touch	/	24.43	25.00	0.065	<b>0.07</b>	0.109	<b>0.12</b>	0.08
26140	1860	1RB_Mid	Right	Tilt	/	24.43	25.00	0.081	<b>0.09</b>	0.103	<b>0.12</b>	0.08
26140	1860	50RB_Mid	Left	Touch	/	23.38	24.00	0.171	<b>0.20</b>	0.275	<b>0.32</b>	-0.05
26140	1860	50RB_Mid	Left	Tilt	/	23.38	24.00	0.089	<b>0.10</b>	0.103	<b>0.12</b>	-0.05
26140	1860	50RB_Mid	Right	Touch	/	23.38	24.00	0.052	<b>0.06</b>	0.086	<b>0.10</b>	-0.16
26140	1860	50RB_Mid	Right	Tilt	/	23.38	24.00	0.063	<b>0.07</b>	0.112	<b>0.13</b>	-0.06

Note1: The LTE mode is QPSK\_20MHz.

**Table 14.1-14: SAR Values (LTE Band25 - Body)**

Frequency		Mode	Test Position	Figure No.	Conducted Power (dBm)	Max. tune-up Power (dBm)	Measured SAR(10g) (W/kg)	Reported SAR(10g) (W/kg)	Measured SAR(1g) (W/kg)	Reported SAR(1g) (W/kg)	Power Drift (dB)
Ch.	MHz										
26100	1860	1RB_Mid	Front	Note1	24.43	25.00	0.278	<b>0.32</b>	0.455	<b>0.52</b>	0.13
26590	1905	1RB_Mid	Rear	Note1	24.33	25.00	0.413	<b>0.48</b>	0.661	<b>0.77</b>	-0.02
26365	1882.5	1RB_Mid	Rear	Note1	24.33	25.00	0.413	<b>0.48</b>	0.673	<b>0.79</b>	-0.1
26100	1860	1RB_Mid	Rear	Note1 Fig.14	24.43	25.00	0.458	<b>0.52</b>	0.794	<b>0.91</b>	0.02
26100	1860	1RB_Mid	Left	/	24.43	25.00	0.251	<b>0.29</b>	0.411	<b>0.47</b>	0.05
26100	1860	1RB_Mid	Bottom	Note1	24.43	25.00	0.256	<b>0.29</b>	0.427	<b>0.49</b>	-0.09
26100	1860	50RB_Mid	Front	Note1	23.38	24.00	0.220	<b>0.25</b>	0.349	<b>0.40</b>	0.14
26100	1860	50RB_Mid	Rear	Note1	23.38	24.00	0.335	<b>0.39</b>	0.581	<b>0.67</b>	-0.03
26100	1860	50RB_Mid	Left	/	23.38	24.00	0.175	<b>0.20</b>	0.312	<b>0.36</b>	-0.1
26100	1860	50RB_Mid	Bottom	Note1	23.38	24.00	0.192	<b>0.22</b>	0.317	<b>0.37</b>	0.16
26100	1860	100RB	Rear	/	23.29	24.00	0.281	<b>0.33</b>	0.479	<b>0.56</b>	0.16
26100	1860	1RB_Mid	Front	/	19.82	20.50	0.196	<b>0.23</b>	0.300	<b>0.35</b>	0.15
26100	1860	1RB_Mid	Rear	/	19.82	20.50	0.291	<b>0.34</b>	0.535	<b>0.63</b>	-0.02
26100	1860	1RB_Mid	Bottom	/	19.82	20.50	0.212	<b>0.25</b>	0.386	<b>0.45</b>	-0.09
26100	1860	50RB_Low	Front	/	18.75	19.50	0.161	<b>0.19</b>	0.263	<b>0.31</b>	0.07
26100	1860	50RB_Low	Rear	/	18.75	19.50	0.211	<b>0.25</b>	0.389	<b>0.46</b>	-0.11
26100	1860	50RB_Low	Bottom	/	18.75	19.50	0.158	<b>0.19</b>	0.285	<b>0.34</b>	-0.19

Note: The distance between the EUT and the phantom bottom is 10mm.

Note1: The distance between the EUT and the phantom bottom is 14mm.

Note2: The LTE mode is QPSK\_20MHz.

**Table 14.1-15: SAR Values (LTE Band26 - Head)**

Frequency		Mode	Side	Test Position	Figure No.	Conducted Power (dBm)	Max. tune-up Power (dBm)	Measured SAR(10g) (W/kg)	Reported SAR(10g) (W/kg)	Measured SAR(1g) (W/kg)	Reported SAR(1g) (W/kg)	Power Drift (dB)
Ch.	MHz											
26865	831.5	1RB_Mid	Left	Touch	/	24.22	25.00	0.215	<b>0.26</b>	0.269	<b>0.32</b>	-0.06
26865	831.5	1RB_Mid	Left	Tilt	/	24.22	25.00	0.112	<b>0.13</b>	0.136	<b>0.16</b>	0.01
26865	831.5	1RB_Mid	Right	Touch	Fig.15	24.22	25.00	0.215	<b>0.26</b>	0.270	<b>0.32</b>	-0.13
26865	831.5	1RB_Mid	Right	Tilt	/	24.22	25.00	0.126	<b>0.15</b>	0.163	<b>0.20</b>	-0.16
26775	821.5	36RB_Low	Left	Touch	/	23.34	24.00	0.164	<b>0.19</b>	0.205	<b>0.24</b>	0.02
26775	821.5	36RB_Low	Left	Tilt	/	23.34	24.00	0.090	<b>0.10</b>	0.110	<b>0.13</b>	-0.02
26775	821.5	36RB_Low	Right	Touch	/	23.34	24.00	0.143	<b>0.17</b>	0.179	<b>0.21</b>	-0.03
26775	821.5	36RB_Low	Right	Tilt	/	23.34	24.00	0.087	<b>0.10</b>	0.128	<b>0.15</b>	-0.07

Note1: The LTE mode is QPSK\_15MHz.

**Table 14.1-16: SAR Values (LTE Band26 - Body)**

Frequency		Mode	Test Position	Figure No.	Conduct ed Power (dBm)	Max. tune-up Power (dBm)	Measured SAR(10g) (W/kg)	Reported SAR(10g) (W/kg)	Measured SAR(1g) (W/kg)	Reported SAR(1g) (W/kg)	Power Drift (dB)
Ch.	MHz										
26865	831.5	1RB_Mid	Front	Note1	24.22	25.00	0.165	<b>0.20</b>	0.215	<b>0.26</b>	-0.03
26865	831.5	1RB_Mid	Rear	Note1	24.22	25.00	0.209	<b>0.25</b>	0.345	<b>0.41</b>	-0.07
26865	831.5	1RB_Mid	Left	/	24.22	25.00	0.118	<b>0.14</b>	0.176	<b>0.21</b>	0.09
26865	831.5	1RB_Mid	Right	/	24.22	25.00	0.204	<b>0.24</b>	0.297	<b>0.36</b>	-0.19
26865	831.5	1RB_Mid	Bottom	Note1	24.22	25.00	0.134	<b>0.16</b>	0.224	<b>0.27</b>	-0.07
26865	831.5	36RB_Low	Front	Note1	23.34	24.00	0.136	<b>0.16</b>	0.177	<b>0.21</b>	0.03
26865	831.5	36RB_Low	Rear	Note1	23.34	24.00	0.158	<b>0.18</b>	0.264	<b>0.31</b>	-0.01
26865	831.5	36RB_Low	Left	/	23.34	24.00	0.104	<b>0.12</b>	0.151	<b>0.18</b>	-0.16
26865	831.5	36RB_Low	Right	/	23.34	24.00	0.171	<b>0.20</b>	0.251	<b>0.29</b>	0.17
26865	831.5	36RB_Low	Bottom	Note1	23.34	24.00	0.094	<b>0.11</b>	0.156	<b>0.18</b>	-0.1
26865	831.5	1RB_Mid	Front	/	23.09	24.00	0.134	<b>0.17</b>	0.215	<b>0.27</b>	-0.03
26865	831.5	1RB_Mid	Rear	Fig.16	23.09	24.00	0.266	<b>0.33</b>	0.455	<b>0.56</b>	0.12
26865	831.5	1RB_Mid	Bottom	/	23.09	24.00	0.155	<b>0.19</b>	0.280	<b>0.35</b>	0.14
26965	841.5	36RB_Low	Front	/	22.17	23.00	0.120	<b>0.15</b>	0.192	<b>0.23</b>	0.00
26965	841.5	36RB_Low	Rear	/	22.17	23.00	0.227	<b>0.27</b>	0.374	<b>0.45</b>	0.01
26965	841.5	36RB_Low	Bottom	/	22.17	23.00	0.114	<b>0.14</b>	0.204	<b>0.25</b>	-0.05

Note: The distance between the EUT and the phantom bottom is 10mm

Note1: The distance between the EUT and the phantom bottom is 14mm

Note2: The LTE mode is QPSK\_15MHz.

**Table 14.1-17: SAR Values (LTE Band41 PC2 - Head)**

Frequency		Mode	Side	Test Position	Figure No.	Conduct ed Power (dBm)	tune-up Power (dBm)	Measured SAR(10g) (W/kg)	Reported SAR(10g) (W/kg)	Measured SAR(1g) (W/kg)	Reported SAR(1g) (W/kg)	Power Drift (dB)
Ch.	MHz											
41490	2680	1RB_Mid	Left	Touch	Fig.17	27.26	28.00	0.157	<b>0.19</b>	0.300	<b>0.36</b>	0.17
41490	2680	1RB_Mid	Left	Tilt	/	27.26	28.00	0.107	<b>0.13</b>	0.205	<b>0.24</b>	0.13
41490	2680	1RB_Mid	Right	Touch	/	27.26	28.00	0.147	<b>0.17</b>	0.283	<b>0.34</b>	0.03
41490	2680	1RB_Mid	Right	Tilt	/	27.26	28.00	0.064	<b>0.08</b>	0.116	<b>0.14</b>	0.06
40620	2593	50RB_Low	Left	Touch	/	26.20	27.00	0.109	<b>0.13</b>	0.202	<b>0.24</b>	-0.06
40620	2593	50RB_Low	Left	Tilt	/	26.20	27.00	0.083	<b>0.10</b>	0.156	<b>0.19</b>	0.14
40620	2593	50RB_Low	Right	Touch	/	26.20	27.00	0.119	<b>0.14</b>	0.159	<b>0.19</b>	-0.02
40620	2593	50RB_Low	Right	Tilt	/	26.20	27.00	0.043	<b>0.05</b>	0.077	<b>0.09</b>	-0.02

Note1: The LTE mode is QPSK\_20MHz.

**Table 14.1-18: SAR Values (LTE Band41 PC2 - Body)**

Frequency		Mode	Test Position	Figure No.	Conduct ed Power (dBm)	tune-up Power (dBm)	Measured SAR(10g) (W/kg)	Reported SAR(10g) (W/kg)	Measured SAR(1g) (W/kg)	Reported SAR(1g) (W/kg)	Power Drift (dB)
Ch.	MHz										
41490	2680	1RB_Mid	Front	/	27.26	28.00	0.364	<b>0.43</b>	0.722	<b>0.86</b>	-0.05
41055	2636.5	1RB_Mid	Front	/	27.15	28.00	0.314	<b>0.38</b>	0.622	<b>0.76</b>	0.17
40620	2593	1RB_Mid	Front	/	27.21	28.00	0.316	<b>0.38</b>	0.628	<b>0.75</b>	0.06
40185	2549.5	1RB_Mid	Front	/	27.09	28.00	0.322	<b>0.40</b>	0.640	<b>0.79</b>	0.13
39750	2506	1RB_Mid	Front	/	26.94	28.00	0.368	<b>0.47</b>	0.729	<b>0.93</b>	-0.11
41490	2680	1RB_Mid	Rear	/	27.26	28.00	0.324	<b>0.38</b>	0.650	<b>0.77</b>	0.07
41490	2680	1RB_Mid	Left	/	27.26	28.00	0.116	<b>0.14</b>	0.214	<b>0.25</b>	0.14
41490	2680	1RB_Mid	Right	/	27.26	28.00	0.109	<b>0.13</b>	0.206	<b>0.24</b>	-0.11
41490	2680	1RB_Mid	Bottom	/	27.26	28.00	0.424	<b>0.50</b>	0.844	<b>1.00</b>	0.16
41055	2636.5	1RB_Mid	Bottom	/	27.15	28.00	0.430	<b>0.52</b>	0.816	<b>0.99</b>	0.16
40620	2593	1RB_Mid	Bottom	/	27.21	28.00	0.443	<b>0.53</b>	0.844	<b>1.01</b>	0.08
40185	2549.5	1RB_Mid	Bottom	/	27.09	28.00	0.519	<b>0.64</b>	1.012	<b>1.25</b>	0.17
39750	2506	1RB_Mid	Bottom	Fig.18	26.94	28.00	0.563	<b>0.72</b>	1.120	<b>1.43</b>	0.03
40620	2593	50RB_Low	Front	/	26.20	27.00	0.311	<b>0.37</b>	0.653	<b>0.79</b>	0.17
40620	2593	50RB_Low	Rear	/	26.20	27.00	0.301	<b>0.36</b>	0.626	<b>0.75</b>	0.18
40620	2593	50RB_Low	Left	/	26.20	27.00	0.136	<b>0.16</b>	0.248	<b>0.30</b>	-0.1
40620	2593	50RB_Low	Right	/	26.20	27.00	0.143	<b>0.17</b>	0.269	<b>0.32</b>	0.08
41490	2680	50RB_Low	Bottom	/	26.18	27.00	0.399	<b>0.48</b>	0.790	<b>0.95</b>	0.1
41055	2636.5	50RB_Low	Bottom	/	26.14	27.00	0.350	<b>0.43</b>	0.703	<b>0.86</b>	0.16
40620	2593	50RB_Low	Bottom	/	26.20	27.00	0.429	<b>0.52</b>	0.849	<b>1.02</b>	0.1
40185	2549.5	50RB_Low	Bottom	/	26.03	27.00	0.412	<b>0.52</b>	0.853	<b>1.07</b>	0.02
39750	2506	50RB_Low	Bottom	/	25.96	27.00	0.339	<b>0.43</b>	0.686	<b>0.87</b>	0.11
41055	2636.5	100RB	Front	/	26.18	27.00	0.312	<b>0.38</b>	0.603	<b>0.73</b>	-0.09
41055	2636.5	100RB	Bottom	/	26.18	27.00	0.349	<b>0.42</b>	0.702	<b>0.85</b>	0.18
39750	2506	1RB_Mid	Bottom	Headset	26.94	28.00	0.517	<b>0.66</b>	0.967	<b>1.23</b>	0.11

Note: The distance between the EUT and the phantom bottom is 10mm.

Note1: The LTE mode is QPSK\_20MHz.

**Table 14.1-19: SAR Values (LTE Band41 PC3 - Head)**

Frequency		Mode	Side	Test Position	Figure No.	Conduct ed Power (dBm)	tune-up Power (dBm)	Measured SAR(10g) (W/kg)	Reported SAR(10g) (W/kg)	Measured SAR(1g) (W/kg)	Reported SAR(1g) (W/kg)	Power Drift (dB)
Ch.	MHz											
41490	2680	1RB_Mid	Left	Touch	Fig.19	24.36	25.00	0.116	<b>0.13</b>	0.222	<b>0.26</b>	0.07
41490	2680	1RB_Mid	Left	Tilt	/	24.36	25.00	0.057	<b>0.07</b>	0.117	<b>0.14</b>	0.13
41490	2680	1RB_Mid	Right	Touch	/	24.36	25.00	0.057	<b>0.07</b>	0.118	<b>0.14</b>	0.09
41490	2680	1RB_Mid	Right	Tilt	/	24.36	25.00	0.055	<b>0.06</b>	0.106	<b>0.12</b>	-0.12
40620	2593	50RB_Low	Left	Touch	/	23.30	24.00	0.102	<b>0.12</b>	0.193	<b>0.23</b>	0.17
40620	2593	50RB_Low	Left	Tilt	/	23.30	24.00	0.048	<b>0.06</b>	0.099	<b>0.12</b>	-0.04
40620	2593	50RB_Low	Right	Touch	/	23.30	24.00	0.047	<b>0.06</b>	0.095	<b>0.11</b>	-0.11
40620	2593	50RB_Low	Right	Tilt	/	23.30	24.00	0.036	<b>0.04</b>	0.070	<b>0.08</b>	0.05
41515	2682.5	1RB_Low	Left	Touch	ULCA	24.27	25.00	0.103	<b>0.12</b>	0.191	<b>0.23</b>	0.07

Note1: The LTE mode is QPSK\_20MHz.

**Table 14.1-20: SAR Values (LTE Band41 PC3 - Body)**

Frequency		Mode	Test Position	Figure No.	Conduct ed Power (dBm)	tune-up Power (dBm)	Measured SAR(10g) (W/kg)	Reported SAR(10g) (W/kg)	Measured SAR(1g) (W/kg)	Reported SAR(1g) (W/kg)	Power Drift (dB)
Ch.	MHz										
41490	2680	1RB_Mid	Front	/	24.36	25.00	0.120	<b>0.14</b>	0.230	<b>0.27</b>	-0.03
41490	2680	1RB_Mid	Rear	/	24.36	25.00	0.226	<b>0.26</b>	0.486	<b>0.56</b>	-0.03
41490	2680	1RB_Mid	Left	/	24.36	25.00	0.069	<b>0.08</b>	0.132	<b>0.15</b>	-0.01
41490	2680	1RB_Mid	Right	/	24.36	25.00	0.094	<b>0.11</b>	0.172	<b>0.20</b>	-0.19
41490	2680	1RB_Mid	Bottom	Fig.20	24.36	25.00	0.312	<b>0.36</b>	0.640	<b>0.74</b>	0.12
40620	2593	50RB_Low	Front	/	23.30	24.00	0.068	<b>0.08</b>	0.133	<b>0.16</b>	0.12
40620	2593	50RB_Low	Rear	/	23.30	24.00	0.105	<b>0.12</b>	0.319	<b>0.37</b>	-0.03
40620	2593	50RB_Low	Left	/	23.30	24.00	0.073	<b>0.09</b>	0.133	<b>0.16</b>	-0.05
40620	2593	50RB_Low	Right	/	23.30	24.00	0.082	<b>0.10</b>	0.152	<b>0.18</b>	0.15
40620	2593	50RB_Low	Bottom	/	23.30	24.00	0.249	<b>0.29</b>	0.495	<b>0.58</b>	0.19
41515	2682.5	1RB_Low	Bottom	ULCA	24.27	25.00	0.297	<b>0.35</b>	0.611	<b>0.72</b>	0.07

Note: The distance between the EUT and the phantom bottom is 10mm.

Note1: The LTE mode is QPSK\_20MHz.

**Table 14.1-21: SAR Values (LTE Band66 - Head)**

Frequency		Mode	Side	Test Position	Figure No.	Conducted Power (dBm)	Max. tune-up Power (dBm)	Measured SAR(10g) (W/kg)	Reported SAR(10g) (W/kg)	Measured SAR(1g) (W/kg)	Reported SAR(1g) (W/kg)	Power Drift (dB)
Ch.	MHz											
132572	1770	1RB_Mid	Left	Touch	Fig.21	24.34	25.00	0.207	<b>0.24</b>	0.307	<b>0.36</b>	-0.06
132572	1770	1RB_Mid	Left	Tilt	/	24.34	25.00	0.117	<b>0.14</b>	0.126	<b>0.15</b>	0.19
132572	1770	1RB_Mid	Right	Touch	/	24.34	25.00	0.135	<b>0.16</b>	0.189	<b>0.22</b>	0.01
132572	1770	1RB_Mid	Right	Tilt	/	24.34	25.00	0.077	<b>0.09</b>	0.114	<b>0.13</b>	-0.05
132572	1770	50RB_Mid	Left	Touch	/	23.31	24.00	0.158	<b>0.19</b>	0.233	<b>0.27</b>	-0.06
132572	1770	50RB_Mid	Left	Tilt	/	23.31	24.00	0.093	<b>0.11</b>	0.139	<b>0.16</b>	0.02
132572	1770	50RB_Mid	Right	Touch	/	23.31	24.00	0.102	<b>0.12</b>	0.142	<b>0.17</b>	0.14
132572	1770	50RB_Mid	Right	Tilt	/	23.31	24.00	0.058	<b>0.07</b>	0.087	<b>0.10</b>	0.08

Note1: The LTE mode is QPSK\_20MHz.

**Table 14.1-22: SAR Values (LTE Band66 - Body)**

Frequency		Mode	Test Position	Figure No.	Conducted Power (dBm)	Max. tune-up Power (dBm)	Measured SAR(10g) (W/kg)	Reported SAR(10g) (W/kg)	Measured SAR(1g) (W/kg)	Reported SAR(1g) (W/kg)	Power Drift (dB)
Ch.	MHz										
132572	1770	1RB_Mid	Front	Note1	24.34	25.00	0.366	<b>0.43</b>	0.564	<b>0.66</b>	0.13
132572	1770	1RB_Mid	Rear	Note1 Fig.22	24.34	25.00	0.426	<b>0.50</b>	0.650	<b>0.76</b>	0.12
132572	1770	1RB_Mid	Left	/	24.34	25.00	0.238	<b>0.28</b>	0.362	<b>0.42</b>	0.02
132572	1770	1RB_Mid	Bottom	Note1	24.34	25.00	0.293	<b>0.34</b>	0.439	<b>0.51</b>	0.02
132572	1770	50RB_Mid	Front	Note1	23.31	24.00	0.324	<b>0.38</b>	0.506	<b>0.59</b>	0.19
132572	1770	50RB_Mid	Rear	Note1	23.31	24.00	0.324	<b>0.38</b>	0.495	<b>0.58</b>	0.16
132572	1770	50RB_Mid	Left	/	23.31	24.00	0.143	<b>0.17</b>	0.211	<b>0.25</b>	-0.16
132572	1770	50RB_Mid	Bottom	Note1	23.31	24.00	0.274	<b>0.32</b>	0.409	<b>0.48</b>	0.06
132322	1745	1RB_Mid	Front	/	21.49	22.00	0.231	<b>0.26</b>	0.359	<b>0.40</b>	0.15
132322	1745	1RB_Mid	Rear	/	21.49	22.00	0.269	<b>0.30</b>	0.477	<b>0.54</b>	0.00
132322	1745	1RB_Mid	Bottom	/	21.49	22.00	0.208	<b>0.23</b>	0.348	<b>0.39</b>	0.09
132322	1745	50RB_Mid	Front	/	20.44	22.00	0.179	<b>0.26</b>	0.278	<b>0.40</b>	0.17
132322	1745	50RB_Mid	Rear	/	20.44	22.00	0.202	<b>0.29</b>	0.329	<b>0.47</b>	-0.16
132322	1745	50RB_Mid	Bottom	/	20.44	22.00	0.196	<b>0.28</b>	0.339	<b>0.49</b>	0.09

Note: The distance between the EUT and the phantom bottom is 10mm.

Note1: The distance between the EUT and the phantom bottom is 14mm.

Note2: The LTE mode is QPSK\_20MHz.

**Table 14.1-23: SAR Values (LTE Band71 - Head)**

Frequency		Mode	Side	Test Position	Figure No.	Conducted Power (dBm)	tune-up Power (dBm)	Measured SAR(10g) (W/kg)	Reported SAR(10g) (W/kg)	Measured SAR(1g) (W/kg)	Reported SAR(1g) (W/kg)	Power Drift (dB)
Ch.	MHz											
133222	673	1RB_Mid	Left	Touch	Fig.23	24.29	25.00	0.127	<b>0.15</b>	0.156	<b>0.18</b>	-0.01
133222	673	1RB_Mid	Left	Tilt	/	24.29	25.00	0.046	<b>0.05</b>	0.060	<b>0.07</b>	-0.03
133222	673	1RB_Mid	Right	Touch	/	24.29	25.00	0.091	<b>0.11</b>	0.127	<b>0.15</b>	-0.13
133222	673	1RB_Mid	Right	Tilt	/	24.29	25.00	0.057	<b>0.07</b>	0.076	<b>0.09</b>	-0.16
133322	683	50RB_Low	Left	Touch	/	23.33	24.00	0.085	<b>0.10</b>	0.118	<b>0.14</b>	-0.09
133322	683	50RB_Low	Left	Tilt	/	23.33	24.00	0.000	<b>0.00</b>	0.000	<b>0.00</b>	-0.05
133322	683	50RB_Low	Right	Touch	/	23.33	24.00	0.063	<b>0.07</b>	0.087	<b>0.10</b>	-0.11
133322	683	50RB_Low	Right	Tilt	/	23.33	24.00	0.036	<b>0.04</b>	0.046	<b>0.05</b>	-0.04

Note1: The LTE mode is QPSK\_20MHz.

**Table 14.1-24: SAR Values (LTE Band71 - Body)**

Frequency		Mode	Test Position	Figure No.	Conducted Power (dBm)	tune-up Power (dBm)	Measured SAR(10g) (W/kg)	Reported SAR(10g) (W/kg)	Measured SAR(1g) (W/kg)	Reported SAR(1g) (W/kg)	Power Drift (dB)
Ch.	MHz										
133222	673	1RB_Mid	Front	/	24.29	25.00	0.152	<b>0.18</b>	0.210	<b>0.25</b>	-0.09
133222	673	1RB_Mid	Rear	/	24.29	25.00	0.210	<b>0.25</b>	0.267	<b>0.31</b>	-0.18
133222	673	1RB_Mid	Left	/	24.29	25.00	0.150	<b>0.18</b>	0.230	<b>0.27</b>	-0.07
133222	673	1RB_Mid	Right	Fig.24	24.29	25.00	0.256	<b>0.30</b>	0.364	<b>0.43</b>	0.05
133222	673	1RB_Mid	Bottom	/	24.29	25.00	0.081	<b>0.10</b>	0.152	<b>0.18</b>	0.05
133322	683	50RB_Low	Front	/	23.33	24.00	0.108	<b>0.13</b>	0.150	<b>0.18</b>	0.18
133322	683	50RB_Low	Rear	/	23.33	24.00	0.151	<b>0.18</b>	0.209	<b>0.24</b>	-0.11
133322	683	50RB_Low	Left	/	23.33	24.00	0.103	<b>0.12</b>	0.156	<b>0.18</b>	0.04
133322	683	50RB_Low	Right	/	23.33	24.00	0.207	<b>0.24</b>	0.313	<b>0.37</b>	0.19
133322	683	50RB_Low	Bottom	/	23.33	24.00	0.059	<b>0.07</b>	0.126	<b>0.15</b>	0.06

Note: The distance between the EUT and the phantom bottom is 10mm.

Note1: The LTE mode is QPSK\_20MHz.



## 14.2 SAR results for Standard procedure

There is zoom scan measurement to be added for the highest measured SAR in each exposure configuration/band.

**Table 14.2-1: SAR Values (GSM 850 MHz Band - Head)**

Frequency		Side	Test Position	Figure No.	Conducted Power (dBm)	Max. tune-up Power (dBm)	Measured SAR(10g) (W/kg)	Reported SAR(10g) (W/kg)	Measured SAR(1g) (W/kg)	Reported SAR(1g) (W/kg)	Power Drift (dB)
Ch.	MHz										
251	848.8	Right	Touch	Fig.1	31.42	32.50	0.324	<b>0.42</b>	0.409	<b>0.52</b>	0.03

Note: the head SAR of GSM850 is tested with GPRS (2Txslots) mode because of VoIP.

**Table 14.2-2: SAR Values (GSM 850 MHz Band - Body)**

Frequency		Mode (number of timeslots)	Test Position	Figure No.	Conducted Power (dBm)	Max. tune-up Power (dBm)	Measured SAR(10g) (W/kg)	Reported SAR(10g) (W/kg)	Measured SAR(1g) (W/kg)	Reported SAR(1g) (W/kg)	Power Drift (dB)
Ch.	MHz										
190	836.6	GPRS (2)	Rear	Fig.2	31.46	32.50	0.433	<b>0.55</b>	0.723	<b>0.92</b>	-0.12

Note: The distance between the EUT and the phantom bottom is 10mm.

**Table 14.2-3: SAR Values (GSM 1900 MHz Band - Head)**

Frequency		Side	Test Position	Figure No.	Conducted Power (dBm)	Max. tune-up Power (dBm)	Measured SAR(10g) (W/kg)	Reported SAR(10g) (W/kg)	Measured SAR(1g) (W/kg)	Reported SAR(1g) (W/kg)	Power Drift (dB)
Ch.	MHz										
810	1909.8	Left	Touch	Fig.3	28.11	29.00	0.185	<b>0.23</b>	0.290	<b>0.36</b>	-0.17

Note: the head SAR of GSM1900 is tested with GPRS (2Txslots) mode because of VoIP.

**Table 14.2-4: SAR Values (GSM 1900 MHz Band - Body)**

Frequency		Mode (number of timeslots)	Test Position	Figure No./ Note	Conducted Power (dBm)	Max. tune-up Power (dBm)	Measured SAR(10g) (W/kg)	Reported SAR(10g) (W/kg)	Measured SAR(1g) (W/kg)	Reported SAR(1g) (W/kg)	Power Drift (dB)
Ch.	MHz										
661	1880	GPRS (2)	Rear	Note1 Fig.4	27.87	29.00	0.340	<b>0.44</b>	0.59	<b>0.77</b>	0.16

Note1: The distance between the EUT and the phantom bottom is 14mm.

**Table 14.2-5: SAR Values (WCDMA 1900 MHz Band - Head)**

Frequency		Side	Test Position	Figure No.	Conducted Power (dBm)	Max. tune-up Power (dBm)	Measured SAR(10g) (W/kg)	Reported SAR(10g) (W/kg)	Measured SAR(1g) (W/kg)	Reported SAR(1g) (W/kg)	Power Drift (dB)
Ch.	MHz										
9800	1880	Left	Touch	Fig.5	23.46	25.00	0.252	<b>0.36</b>	0.383	<b>0.55</b>	0.00

**Table 14.2-6: SAR Values (WCDMA 1900 MHz Band - Body)**

Frequency		Test Position	Figure No./ Note	Conducted Power (dBm)	Max. tune-up Power (dBm)	Measured SAR(10g) (W/kg)	Reported SAR(10g)(W/kg)	Measured SAR(1g) (W/kg)	Reported SAR(1g) (W/kg)	Power Drift (dB)
Ch.	MHz									
9938	1907.6	Rear	Note1 Fig.6	23.39	25.00	0.500	<b>0.72</b>	0.882	<b>1.28</b>	-0.07

Note1: The distance between the EUT and the phantom bottom is 14mm.

**Table 14.2-7: SAR Values (WCDMA 1700 MHz Band - Head)**

Frequency		Side	Test Position	Figure No.	Conducted Power (dBm)	Max. tune-up Power (dBm)	Measured SAR(10g) (W/kg)	Reported SAR(10g) (W/kg)	Measured SAR(1g) (W/kg)	Reported SAR(1g) (W/kg)	Power Drift (dB)
Ch.	MHz										
1513	1752.6	Left	Touch	Fig.7	23.56	25.00	0.203	<b>0.28</b>	0.300	<b>0.42</b>	-0.16

**Table 14.2-8: SAR Values (WCDMA 1700 MHz Band - Body)**

Frequency		Test Position	Figure No./ Note	Conducted Power (dBm)	Max. tune-up Power (dBm)	Measured SAR(10g) (W/kg)	Reported SAR(10g)(W/kg)	Measured SAR(1g) (W/kg)	Reported SAR(1g) (W/kg)	Power Drift (dB)
Ch.	MHz									
9800	1880	Rear	Fig.8	20.36	22.00	0.376	<b>0.55</b>	0.595	<b>0.87</b>	-0.18

Note: The distance between the EUT and the phantom bottom is 10mm.

**Table 14.2-9: SAR Values (WCDMA 850 MHz Band - Head)**

Frequency		Side	Test Position	Figure No.	Conducted Power (dBm)	Max. tune-up Power (dBm)	Measured SAR(10g) (W/kg)	Reported SAR(10g) (W/kg)	Measured SAR(1g) (W/kg)	Reported SAR(1g) (W/kg)	Power Drift (dB)
Ch.	MHz										
4182	836.4	Right	Touch	Fig.9	23.44	25.00	0.224	<b>0.32</b>	0.282	<b>0.40</b>	0.05

**Table 14.2-10: SAR Values (WCDMA 850 MHz Band - Body)**

Frequency		Test Position	Figure No.	Conducted Power (dBm)	Max. tune-up Power (dBm)	Measured SAR(10g) (W/kg)	Reported SAR(10g) (W/kg)	Measured SAR(1g) (W/kg)	Reported SAR(1g) (W/kg)	Power Drift (dB)
Ch.	MHz									
4182	836.4	Rear	Fig.10	23.44	25.00	0.336	<b>0.48</b>	0.570	<b>0.82</b>	-0.05

Note: The distance between the EUT and the phantom bottom is 10mm.

**Table 14.2-11: SAR Values (LTE Band12 - Head)**

Frequency		Mode	Side	Test Position	Figure No.	Conducted Power (dBm)	Max. tune-up Power (dBm)	Measured SAR(10g) (W/kg)	Reported SAR(10g) (W/kg)	Measured SAR(1g) (W/kg)	Reported SAR(1g) (W/kg)	Power Drift (dB)
Ch.	MHz											
23060	704	1RB_Mid	Right	Touch	Fig.11	24.47	25.00	0.170	<b>0.19</b>	0.209	<b>0.24</b>	-0.18

Note1: The LTE mode is QPSK\_10MHz.

**Table 14.2-12: SAR Values (LTE Band12 - Body)**

Frequency		Mode	Test Position	Figure No.	Conducted Power (dBm)	Max. tune-up Power (dBm)	Measured SAR(10g) (W/kg)	Reported SAR(10g) (W/kg)	Measured SAR(1g) (W/kg)	Reported SAR(1g) (W/kg)	Power Drift (dB)
Ch.	MHz										
23060	704	1RB_Mid	Rear	Fig.12	24.47	25.00	0.305	<b>0.34</b>	0.386	<b>0.44</b>	-0.12

Note1: The distance between the EUT and the phantom bottom is 10mm

Note2: The LTE mode is QPSK\_10MHz.

**Table 14.2-13: SAR Values (LTE Band25 - Head)**

Frequency		Mode	Side	Test Position	Figure No.	Conducted Power (dBm)	Max. tune-up Power (dBm)	Measured SAR(10g) (W/kg)	Reported SAR(10g) (W/kg)	Measured SAR(1g) (W/kg)	Reported SAR(1g) (W/kg)	Power Drift (dB)
Ch.	MHz											
26140	1860	1RB_Mid	Left	Touch	Fig.13	24.43	25.00	0.221	<b>0.25</b>	0.331	<b>0.38</b>	-0.02

Note1: The LTE mode is QPSK\_20MHz.

**Table 14.2-14: SAR Values (LTE Band25 - Body)**

Frequency		Mode	Test Position	Figure No.	Conducted Power (dBm)	Max. tune-up Power (dBm)	Measured SAR(10g) (W/kg)	Reported SAR(10g) (W/kg)	Measured SAR(1g) (W/kg)	Reported SAR(1g) (W/kg)	Power Drift (dB)
Ch.	MHz										
26100	1860	1RB_Mid	Rear	Note1 Fig.14	24.43	25.00	0.458	<b>0.52</b>	0.794	<b>0.91</b>	0.02

Note1: The distance between the EUT and the phantom bottom is 14mm.

Note2: The LTE mode is QPSK\_20MHz.

**Table 14.2-15: SAR Values (LTE Band26 - Head)**

Frequency		Mode	Side	Test Position	Figure No.	Conducted Power (dBm)	Max. tune-up Power (dBm)	Measured SAR(10g) (W/kg)	Reported SAR(10g) (W/kg)	Measured SAR(1g) (W/kg)	Reported SAR(1g) (W/kg)	Power Drift (dB)
Ch.	MHz											
26865	831.5	1RB_Mid	Right	Touch	Fig.15	24.22	25.00	0.215	<b>0.26</b>	0.270	<b>0.32</b>	-0.13

Note1: The LTE mode is QPSK\_15MHz.

**Table 14.2-16: SAR Values (LTE Band26 - Body)**

Frequency		Mode	Test Position	Figure No.	Conduct ed Power (dBm)	Max. tune-up Power (dBm)	Measured SAR(10g) (W/kg)	Reported SAR(10g) (W/kg)	Measured SAR(1g) (W/kg)	Reported SAR(1g) (W/kg)	Power Drift (dB)
Ch.	MHz										
26865	831.5	1RB_Mid	Rear	Fig.16	23.09	24.00	0.266	<b>0.33</b>	0.455	<b>0.56</b>	0.12

Note: The distance between the EUT and the phantom bottom is 10mm

Note2: The LTE mode is QPSK\_15MHz.

**Table 14.2-17: SAR Values (LTE Band41 PC2 - Head)**

Frequency		Mode	Side	Test Position	Figure No.	Conduct ed Power (dBm)	tune-up Power (dBm)	Measured SAR(10g) (W/kg)	Reported SAR(10g) (W/kg)	Measured SAR(1g) (W/kg)	Reported SAR(1g) (W/kg)	Power Drift (dB)
Ch.	MHz											
41490	2680	1RB_Mid	Left	Touch	Fig.17	27.26	28.00	0.157	<b>0.19</b>	0.300	<b>0.36</b>	0.17

Note1: The LTE mode is QPSK\_20MHz.

**Table 14.2-18: SAR Values (LTE Band41 PC2 - Body)**

Frequency		Mode	Test Position	Figure No.	Conduct ed Power (dBm)	tune-up Power (dBm)	Measured SAR(10g) (W/kg)	Reported SAR(10g) (W/kg)	Measured SAR(1g) (W/kg)	Reported SAR(1g) (W/kg)	Power Drift (dB)
Ch.	MHz										
39750	2506	1RB_Mid	Bottom	Fig.18	26.94	28.00	0.563	<b>0.72</b>	1.120	<b>1.43</b>	0.03

Note: The distance between the EUT and the phantom bottom is 10mm.

Note1: The LTE mode is QPSK\_20MHz.

**Table 14.2-19: SAR Values (LTE Band41 PC3 - Head)**

Frequency		Mode	Side	Test Position	Figure No.	Conduct ed Power (dBm)	tune-up Power (dBm)	Measured SAR(10g) (W/kg)	Reported SAR(10g) (W/kg)	Measured SAR(1g) (W/kg)	Reported SAR(1g) (W/kg)	Power Drift (dB)
Ch.	MHz											
41490	2680	1RB_Mid	Left	Touch	Fig.19	24.36	25.00	0.116	<b>0.13</b>	0.222	<b>0.26</b>	0.07

Note1: The LTE mode is QPSK\_20MHz.

**Table 14.2-20: SAR Values (LTE Band41 PC3 - Body)**

Frequency		Mode	Test Position	Figure No.	Conduct ed Power (dBm)	tune-up Power (dBm)	Measured SAR(10g) (W/kg)	Reported SAR(10g) (W/kg)	Measured SAR(1g) (W/kg)	Reported SAR(1g) (W/kg)	Power Drift (dB)
Ch.	MHz										
41490	2680	1RB_Mid	Bottom	Fig.20	24.36	25.00	0.312	<b>0.36</b>	0.640	<b>0.74</b>	0.12

Note: The distance between the EUT and the phantom bottom is 10mm.

Note1: The LTE mode is QPSK\_20MHz.

**Table 14.2-21: SAR Values (LTE Band66 - Head)**

Frequency		Mode	Side	Test Position	Figure No.	Conducted Power (dBm)	Max. tune-up Power (dBm)	Measured SAR(10g) (W/kg)	Reported SAR(10g) (W/kg)	Measured SAR(1g) (W/kg)	Reported SAR(1g) (W/kg)	Power Drift (dB)
Ch.	MHz											
132572	1770	1RB_Mid	Left	Touch	Fig.21	24.34	25.00	0.207	<b>0.24</b>	0.307	<b>0.36</b>	-0.06

Note1: The LTE mode is QPSK\_20MHz.

**Table 14.2-22: SAR Values (LTE Band66 - Body)**

Frequency		Mode	Test Position	Figure No.	Conducted Power (dBm)	Max. tune-up Power (dBm)	Measured SAR(10g) (W/kg)	Reported SAR(10g) (W/kg)	Measured SAR(1g) (W/kg)	Reported SAR(1g) (W/kg)	Power Drift (dB)
Ch.	MHz										
132572	1770	1RB_Mid	Rear	Note1 Fig.22	24.34	25.00	0.426	<b>0.50</b>	0.650	<b>0.76</b>	0.12

Note1: The distance between the EUT and the phantom bottom is 14mm.

Note2: The LTE mode is QPSK\_20MHz.

**Table 14.2-23: SAR Values (LTE Band71 - Head)**

Frequency		Mode	Side	Test Position	Figure No.	Conducted Power (dBm)	Max. tune-up Power (dBm)	Measured SAR(10g) (W/kg)	Reported SAR(10g) (W/kg)	Measured SAR(1g) (W/kg)	Reported SAR(1g) (W/kg)	Power Drift (dB)
Ch.	MHz											
133222	673	1RB_Mid	Left	Touch	Fig.23	24.29	25.00	0.127	<b>0.15</b>	0.156	<b>0.18</b>	-0.01

Note1: The LTE mode is QPSK\_20MHz.

**Table 14.2-24: SAR Values (LTE Band71 - Body)**

Frequency		Mode	Test Position	Figure No.	Conducted Power (dBm)	Max. tune-up Power (dBm)	Measured SAR(10g) (W/kg)	Reported SAR(10g) (W/kg)	Measured SAR(1g) (W/kg)	Reported SAR(1g) (W/kg)	Power Drift (dB)
Ch.	MHz										
133222	673	1RB_Mid	Right	Fig.24	24.29	25.00	0.256	<b>0.30</b>	0.364	<b>0.43</b>	0.05

Note: The distance between the EUT and the phantom bottom is 10mm.

Note1: The LTE mode is QPSK\_20MHz.

### 14.3 WLAN Evaluation for 2.4G

According to the KDB248227 D01, SAR is measured for 2.4GHz 802.11b DSSS using the initial test position procedure.

#### Head Evaluation

**Table 14.3-1: SAR Values (WLAN - Head)– 802.11b (Fast SAR)**

Ambient Temperature: 22.9 °C						Liquid Temperature: 22.5 °C					
Frequency		Side	Test Position	Figure No.	Conducted Power (dBm)	Max. tune-up Power (dBm)	Measured SAR(10g) (W/kg)	Reported SAR(10g) (W/kg)	Measured SAR(1g) (W/kg)	Reported SAR(1g)(W/kg)	Power Drift (dB)
MHz	Ch.										
2462	11	Left	Touch	/	17.69	18.80	0.297	<b>0.38</b>	0.588	<b>0.76</b>	0.19
2462	11	Left	Tilt	/	17.69	18.80	0.312	<b>0.40</b>	0.692	<b>0.89</b>	0.15
2437	6	Left	Tilt		17.66	18.80	0.278	<b>0.36</b>	0.569	<b>0.74</b>	0.07
2462	11	Right	Touch	/	17.69	18.80	0.190	<b>0.25</b>	0.346	<b>0.45</b>	0.13
2462	11	Right	Tilt	/	17.69	18.80	0.194	<b>0.25</b>	0.388	<b>0.50</b>	0.19

As shown above table, the initial test position for head is “Left Tilt”. So the head SAR of WLAN is presented as below:

**Table 14.3-2: SAR Values (WLAN - Head)– 802.11b (Full SAR)**

Ambient Temperature: 22.9 °C						Liquid Temperature: 22.5 °C					
Frequency		Side	Test Position	Figure No.	Conducted Power (dBm)	Max. tune-up Power (dBm)	Measured SAR(10g) (W/kg)	Reported SAR(10g) (W/kg)	Measured SAR(1g) (W/kg)	Reported SAR(1g)(W/kg)	Power Drift (dB)
MHz	Ch.										
2462	11	Left	Touch	/	17.69	18.80	0.295	<b>0.38</b>	0.590	<b>0.76</b>	0.19
2462	11	Left	Tilt	Fig.25	17.69	18.80	0.305	<b>0.39</b>	0.684	<b>0.88</b>	0.15
2437	6	Left	Tilt	/	17.66	18.80	0.255	<b>0.33</b>	0.523	<b>0.68</b>	0.01

Note1: When the reported SAR of the initial test position is > 0.4 W/kg, SAR is repeated for the 802.11 transmission mode configuration tested in the initial test position using subsequent highest estimated 1-g SAR conditions determined by area scans, on the highest maximum output power channel, until the reported SAR is  $\leq$  0.8 W/kg.

Note2: For all positions/configurations tested using the initial test position and subsequent test positions, when the reported SAR is > 0.8 W/kg, SAR is measured for these test positions/configurations on the subsequent next highest measured output power channel until the reported SAR is  $\leq$  1.2 W/kg or all required channels are tested.

According to the KDB248227 D01, The reported SAR must be scaled to 100% transmission duty factor to determine compliance at the maximum tune-up tolerance limit. The scaled reported SAR is presented as below.

**Table 14.3-3: SAR Values (WLAN - Head) – 802.11b (Scaled Reported SAR)**

Ambient Temperature: 22.9 °C						Liquid Temperature: 22.5 °C	
Frequency		Side	Test Position	Actual duty factor	maximum duty factor	Reported SAR (1g)(W/kg)	Scaled reported SAR (1g)(W/kg)
MHz	Ch.						
2462	11	Left	Tilt	100%	100%	<b>0.88</b>	<b>0.88</b>

SAR is not required for OFDM because the 802.11b adjusted SAR  $\leq$  1.2 W/kg.

**Body Evaluation**
**Table 14.3-4: SAR Values (WLAN - Body)– 802.11b (Fast SAR)**

Frequency		Test Position	Figure No.	Conducted Power (dBm)	Max. tune-up Power (dBm)	Ambient Temperature: 22.9 °C		Liquid Temperature: 22.5 °C		Power Drift (dB)
MHz	Ch.					Measured SAR(10g) (W/kg)	Reported SAR(10g) (W/kg)	Measured SAR(1g) (W/kg)	Reported SAR(1g) (W/kg)	
2437	6	Front	/	21.52	21.80	0.111	<b>0.12</b>	0.207	<b>0.22</b>	0.17
2437	6	Rear	/	21.52	21.80	0.250	<b>0.27</b>	0.501	<b>0.53</b>	-0.10
2437	6	Right	/	21.52	21.80	0.100	<b>0.11</b>	0.191	<b>0.20</b>	0.03
2437	6	Top	/	21.52	21.80	0.128	<b>0.14</b>	0.251	<b>0.27</b>	0.07

As shown above table, the initial test position for body is “Rear”. So the body SAR of WLAN is presented as below:

**Table 14.3-5: SAR Values (WLAN - Body)– 802.11b (Full SAR)**

Frequency		Test Position	Figure No.	Conducted Power (dBm)	Max. tune-up Power (dBm)	Ambient Temperature: 22.9 °C		Liquid Temperature: 22.5 °C		Power Drift (dB)
MHz	Ch.					Measured SAR(10g) (W/kg)	Reported SAR(10g) (W/kg)	Measured SAR(1g) (W/kg)	Reported SAR(1g) (W/kg)	
2437	6	Rear	Fig.26	21.52	21.80	0.227	<b>0.24</b>	0.461	<b>0.49</b>	-0.10
2437	6	Rear	Note3	21.52	21.80	0.086	<b>0.09</b>	0.167	<b>0.18</b>	0.11
2437	6	Top	/	21.52	21.80	0.122	<b>0.13</b>	0.235	<b>0.25</b>	0.07

Note1: When the reported SAR of the initial test position is > 0.4 W/kg, SAR is repeated for the 802.11 transmission mode configuration tested in the initial test position using subsequent highest estimated 1-g SAR conditions determined by area scans, on the highest maximum output power channel, until the reported SAR is  $\leq$  0.8 W/kg.

Note2: For all positions/configurations tested using the initial test position and subsequent test positions, when the reported SAR is > 0.8 W/kg, SAR is measured for these test positions/configurations on the subsequent next highest measured output power channel until the reported SAR is  $\leq$  1.2 W/kg or all required channels are tested.

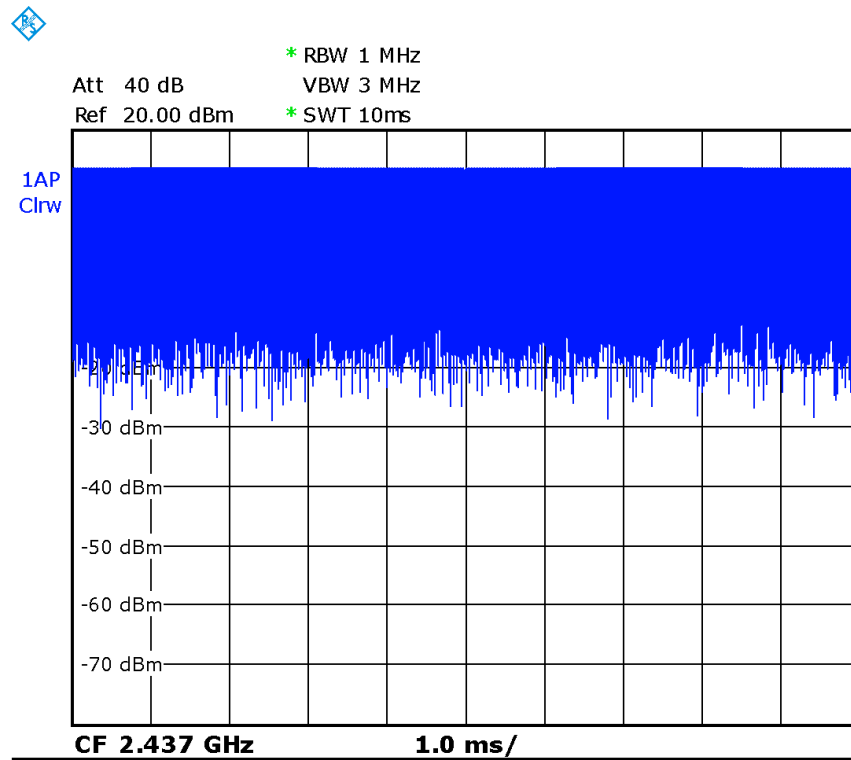
Note3: he distance between the EUT and the phantom bottom is 17mm.

According to the KDB248227 D01, The reported SAR must be scaled to 100% transmission duty factor to determine compliance at the maximum tune-up tolerance limit. The scaled reported SAR is presented as below.

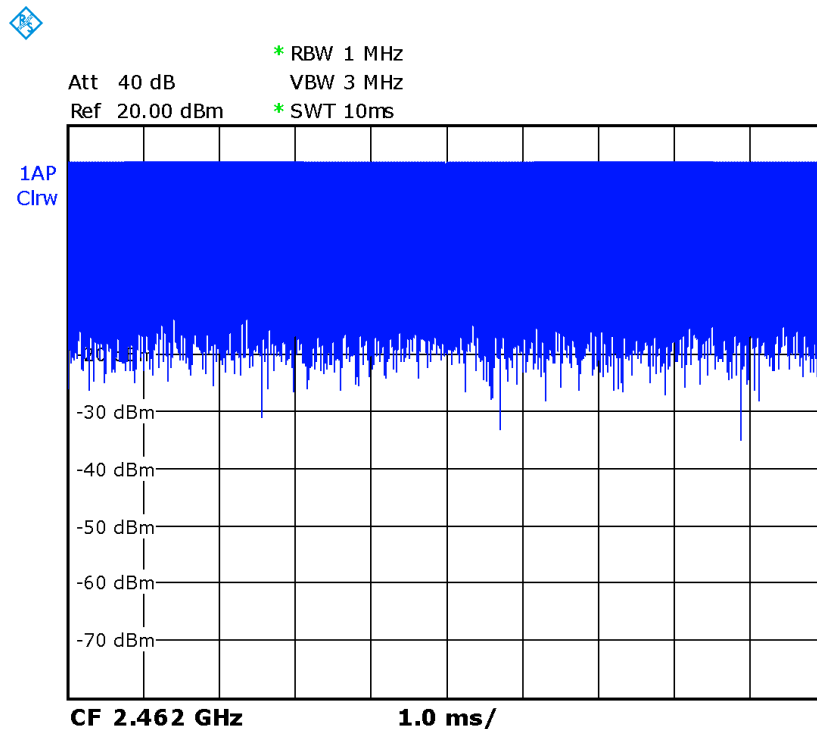
**Table 14.3-6: SAR Values (WLAN - Body) – 802.11b (Scaled Reported SAR)**

Frequency		Test Position	Ambient Temperature: 22.9 °C		Liquid Temperature: 22.5 °C	
MHz	Ch.		Actual duty factor	maximum duty factor	Reported SAR (1g)(W/kg)	Scaled reported SAR (1g)(W/kg)
2437	6	Rear	100%	100%	<b>0.49</b>	<b>0.49</b>

SAR is not required for OFDM because the 802.11b adjusted SAR  $\leq$  1.2 W/kg.



Picture 14.1 Duty factor plot



Picture 14.2 Duty factor plot



## 14.4 WLAN Evaluation For 5G

**Table 14.4-1: OFDM mode specified maximum output power of WLAN antenna**

802.11 mode	a	g	n		ac			
Ch. BW(MHz)	20	20	20	40	20	40	80	160
U-NII-1	X		X	X	X	X	X	
U-NII-2A	X		X	X	X	X	X	
U-NII-2C	X		X	X	X	X	X	
U-NII-3	X		X	X	X	X	X	
§ 15.247 (5.8 GHz)								

X: maximum(conducted) output power(mW), including tolerance, specified for production units

**Table 14.4-2: Maximum output power specified of WLAN antenna for Normal Power**

802.11 mode	a	g	n		ac			
Ch. BW(MHz)	20	20	20	40	20	40	80	160
U-NII-1	89		89	56	71	71	56	
U-NII-2A	89		89	56	71	71	56	
U-NII-2C	100		89	56	71	71	56	
U-NII-3	100		89	56	71	71	56	
§ 15.247 (5.8 GHz)								

- The maximum output power specified for production units is the same for all channels, modulations and data rates in each channel bandwidth configuration of the 802.11a/g/n/ac modes.
- The blue highlighted cells represent highest output configurations in each standalone or aggregated frequency band, with tune-up tolerance included.

**Table 14.4-3: Maximum output power specified of WLAN antenna for Low Power**

802.11 mode	a	g	n		ac			
Ch. BW(MHz)	20	20	20	40	20	40	80	160
U-NII-1	32		32	32	32	32	32	
U-NII-2A	32		32	32	32	32	32	
U-NII-2C	32		32	32	32	32	32	
U-NII-3	32		32	32	32	32	32	
§ 15.247 (5.8 GHz)								

- The maximum output power specified for production units is the same for all channels, modulations and data rates in each channel bandwidth configuration of the 802.11a/g/n/ac modes.
- The blue highlighted cells represent highest output configurations in each standalone or aggregated frequency band, with tune-up tolerance included.

**Table 14.4-4: Maximum output power measured of WLAN antenna, for the applicable OFDM configurations according to the default power measurement procedures for selection initial test configurations - Normal Power**

802.11 mode	a		n		ac	
	20	20	40	20	40	80
U-NII-1	36/40/44/48 <b>72/72/66/62</b>	36/40/44/48 Lower power	38/46 Lower power	36/40/44/48 Lower power	38/46 Lower power	42 Lower power
U-NII-2A	52/56/60/64 <b>63/65/67/70</b>	52/56/60/64 Lower power	54/62 Lower power	52/56/60/64 Lower power	54/62 Lower power	58 Lower power
U-NII-2C	100/104/108/112 116/120/124/128 132/136/140/144 <b>82/78/74/73/70/70/78/79/81/83/92/90</b>	100/104/108/112 116/132/136/140 Lower power	102/110/134 Lower power	100/104/108 /112 116/132/136/ 140 Lower power	102/110/134 Lower power	106/122/138 Lower power
U-NII-3	149/153/157/161/165 <b>83/82/81/97/95</b>	149/153/157/161/165 Lower power	151/159 Lower power	149/153/157 /161/165 Lower power	151/159 Lower power	155 Lower power

- The **bold numbers** is the maximum output measured power (mW).
- Channels with measured maximum power within 0.25dB are considered to have the same measured output. Channels selected for initial test configuration are **highlighted in yellow**.

**Table 14.4-5: Maximum output power measured of WLAN antenna, for the applicable OFDM configurations according to the default power measurement procedures for selection initial test configurations – Low Power**

802.11 mode	a		n		ac	
	20	20	40	20	40	80
U-NII-1	36/40/44/48 Lower power	36/40/44/48 Lower power	38/46 Lower power	36/40/44/48 Lower power	38/46 Lower power	42 24
U-NII-2A	52/56/60/64 Lower power	52/56/60/64 Lower power	54/62 Lower power	52/56/60/64 Lower power	54/62 Lower power	58 23
U-NII-2C	100/104/108/112 116/120/124/128 132/136/140/144 Lower power	100/104/108/112 116/132/136/140 Lower power	102/110/134 Lower power	100/104/108 /112 116/132/136/ 140 Lower power	102/110/134 Lower power	106/122/138 21/23/26
U-NII-3	149/153/157/161/165 Lower power	149/153/157/161/165 Lower power	151/159 Lower power	149/153/157 /161/165 Lower power	151/159 Lower power	155 25

- The **bold numbers** is the maximum output measured power (mW).
- Channels with measured maximum power within 0.25dB are considered to have the same measured output. Channels selected for initial test configuration are **highlighted in yellow**.

**Table 14.4-6: Reported SAR of initial test configuration for Head**

802.11 mode	a	n		ac		
BW(MHz)	20	20	40	20	40	80
U-NII-1	36/40/44/48	36/40/44/48	38/46	36/40/44/48	38/46	42 UNII-2A exclusion applied
U-NII-2A	52/56/60/64	52/56/60/64	54/62	52/56/60/64	54/62	58 0.64
U-NII-2C	100/104/108/112/1 16/120/124/128/13 2/136/140/144	100/104/108/112 116/132/136/140	102/110/11 8/126/134	100/104/108/112 116/132/136/140	102/110/ 134	106/122/138 0.65
U-NII-3	149/153/157/161/1 65	149/153/157/161/1 65	151/159	149/153/157/161 /165	151/159	155 0.78

Highest measured output power channel tested initially are in **yellow highlight**.

The tune up of UNII-1 is less than UNII-2A. SAR is measured for UNII-2A band first. Adjusted SAR of UNII-2A band is  $\leq 1.2$  W/kg. SAR is not required for UNII-1 band.

**Table 14.4-7: Reported SAR of initial test configuration for Body**

802.11 mode	a	n		ac		
BW(MHz)	20	20	40	20	40	80
U-NII-1	36/40/44/48 UNII-2A exclusion applied	36/40/44/48	38/46	36/40/44/48	38/46	42
U-NII-2A	52/56/60/64 0.44	52/56/60/64	54/62	52/56/60/64	54/62	58
U-NII-2C	100/104/108/112/1 16/120/124/128/13 2/136/140/144 0.45	100/104/108/112 116/132/136/140	102/110/11 8/126/134	100/104/108/112 116/132/136/140	102/110/ 134	106/122/138
U-NII-3	149/153/157/161/1 65 0.37	149/153/157/161/1 65	151/159	149/153/157/161 /165	151/159	155

Highest measured output power channel tested initially are in **yellow highlight**.

The tune up of UNII-1 is less than UNII-2A. SAR is measured for UNII-2A band first. Adjusted SAR of UNII-2A band is  $\leq 1.2$  W/kg. SAR is not required for UNII-1 band.

**Table 14.4-8: SAR Values (WLAN - Normal Power Head)**

Frequency		Side	Test Position	Figure No.	Conducted Power (dBm)	Max. tune-up Power (dBm)	Measured SAR(10g) (W/kg)	Reported SAR(10g) (W/kg)	Measured SAR(1g) (W/kg)	Reported SAR(1g) (W/kg)	Power Drift (dB)
MHz	Ch.										
58	5290	Left	Touch	/	13.65	15.00	0.176	<b>0.24</b>	0.472	<b>0.64</b>	0.16
58	5290	Left	Tilt	/	13.65	15.00	0.118	<b>0.16</b>	0.303	<b>0.41</b>	0.13
58	5290	Right	Touch	/	13.65	15.00	0.052	<b>0.07</b>	0.126	<b>0.17</b>	0.18
58	5290	Right	Tilt	/	13.65	15.00	0.052	<b>0.07</b>	0.125	<b>0.17</b>	0.11
138	5690	Left	Touch	/	14.20	15.00	0.167	<b>0.20</b>	0.537	<b>0.65</b>	0.03
138	5690	Left	Tilt	/	14.20	15.00	0.152	<b>0.18</b>	0.515	<b>0.62</b>	-0.04
138	5690	Right	Touch	/	14.20	15.00	0.135	<b>0.16</b>	0.386	<b>0.46</b>	0.13
138	5690	Right	Tilt	/	14.20	15.00	0.133	<b>0.16</b>	0.359	<b>0.43</b>	0.09
155	5775	Left	Touch	Fig.27	13.91	15.00	0.167	<b>0.21</b>	0.606	<b>0.78</b>	0.08
155	5775	Left	Tilt	/	13.91	15.00	0.126	<b>0.16</b>	0.445	<b>0.57</b>	0.16
155	5775	Right	Touch	/	13.91	15.00	0.135	<b>0.17</b>	0.396	<b>0.51</b>	-0.14
155	5775	Right	Tilt	/	13.91	15.00	0.122	<b>0.16</b>	0.302	<b>0.39</b>	0.09

**Table 14.4-9: SAR Values (WLAN - Body)**

Frequency		Test Position	Figure No.	Conducted Power (dBm)	Max. tune-up Power (dBm)	Measured SAR(10g) (W/kg)	Reported SAR(10g) (W/kg)	Measured SAR(1g) (W/kg)	Reported SAR(1g) (W/kg)	Power Drift (dB)
MHz	Ch.									
64	5320	Front	/	18.46	19.50	0.103	<b>0.13</b>	0.258	<b>0.33</b>	0.16
64	5320	Rear	/	18.46	19.50	0.077	<b>0.10</b>	0.198	<b>0.25</b>	0.08
64	5320	Right	/	18.46	19.50	0.132	<b>0.17</b>	0.346	<b>0.44</b>	0.10
64	5320	Top	/	18.46	19.50	0.082	<b>0.10</b>	0.208	<b>0.26</b>	-0.11
140	5700	Front	/	19.64	20.00	0.121	<b>0.13</b>	0.327	<b>0.36</b>	0.15
140	5700	Rear	/	19.64	20.00	0.130	<b>0.14</b>	0.374	<b>0.41</b>	0.09
140	5700	Right	Fig.28	19.64	20.00	0.158	<b>0.17</b>	0.410	<b>0.45</b>	0.17
140	5700	Top	/	19.64	20.00	0.123	<b>0.13</b>	0.362	<b>0.39</b>	0.03
161	5805	Front	/	19.89	20.00	0.115	<b>0.12</b>	0.308	<b>0.32</b>	0.16
161	5805	Rear	/	19.89	20.00	0.123	<b>0.13</b>	0.359	<b>0.37</b>	0.14
161	5805	Right	/	19.89	20.00	0.128	<b>0.13</b>	0.342	<b>0.35</b>	-0.09
161	5805	Top	/	19.89	20.00	0.122	<b>0.13</b>	0.343	<b>0.35</b>	0.17
140	5700	Rear	Note2	19.64	20.00	0.063	<b>0.07</b>	0.166	<b>0.18</b>	0.13

Note1: The distance between the EUT and the phantom bottom is 10mm.

Note2: The distance between the EUT and the phantom bottom is 17mm.

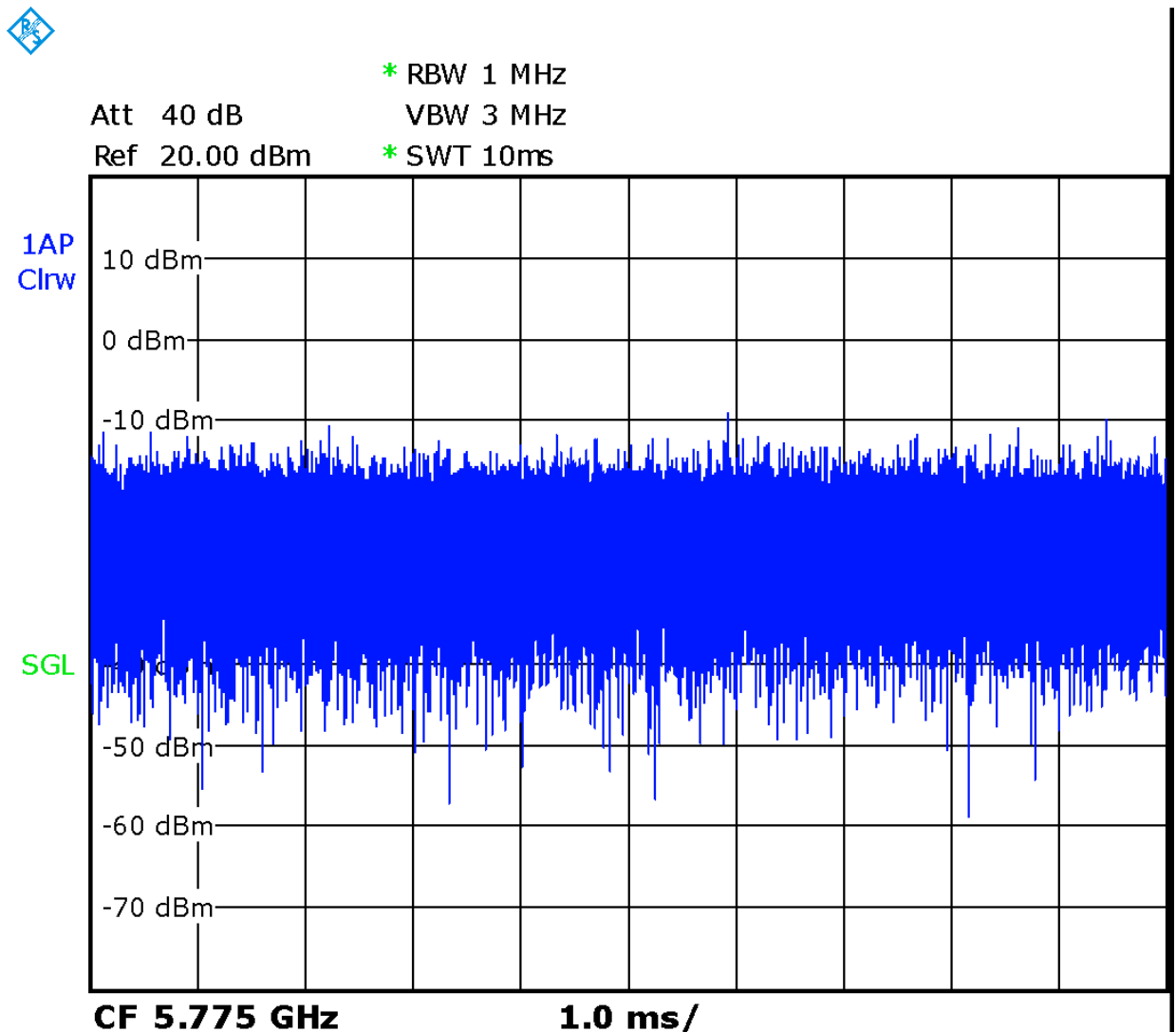
According to the KDB248227 D01, The reported SAR must be scaled to 100% transmission duty factor to determine compliance at the maximum tune-up tolerance limit. The scaled reported SAR is presented as below.

**Table 14.4-10: SAR Values (WLAN - Head) - Scaled Reported SAR**

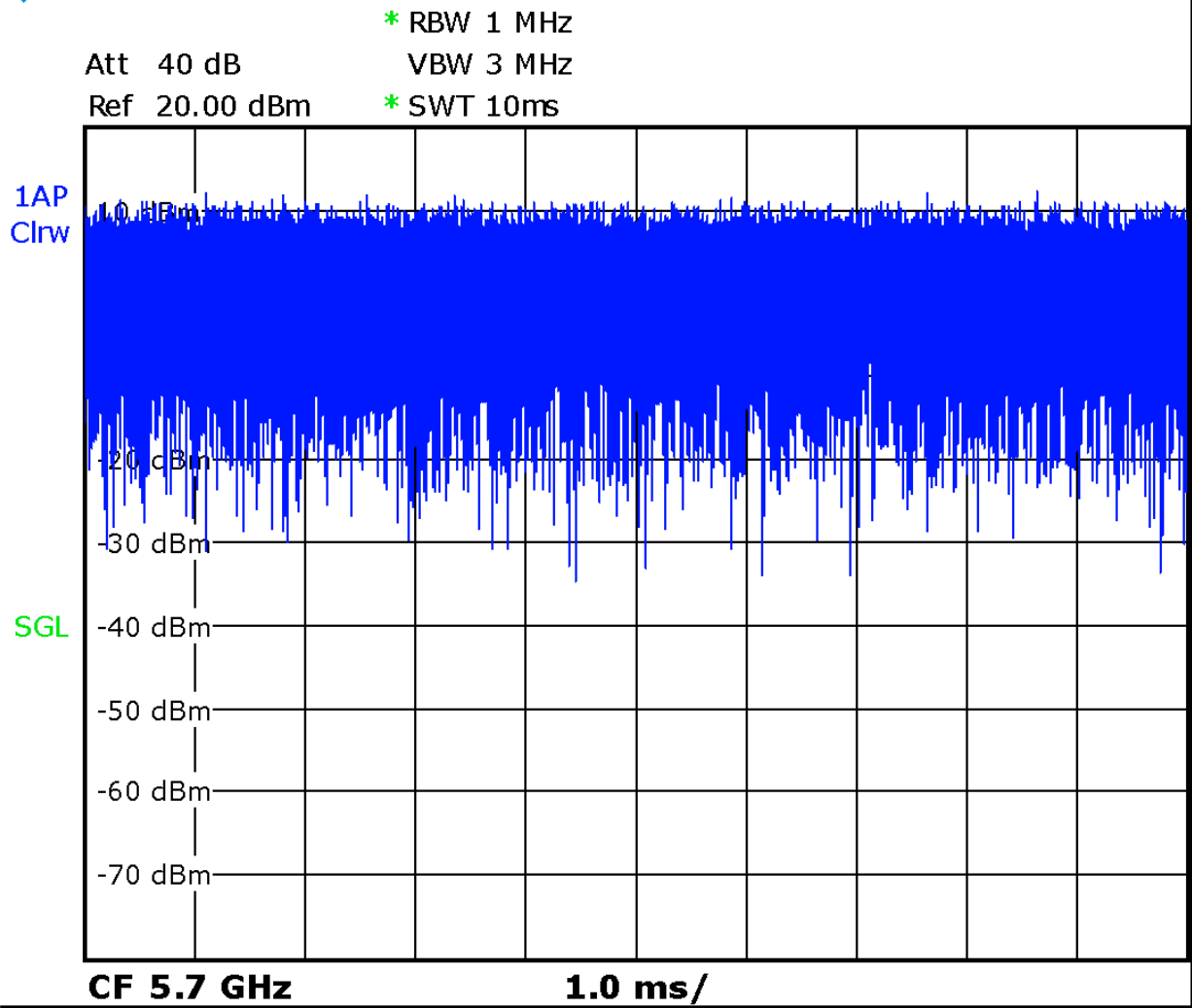
Frequency		Side	Test Position	Actual duty factor	maximum duty factor	Reported SAR (1g) (W/kg)	Scaled reported SAR (1g) (W/kg)
MHz	Ch.						
155	5775	Left	Touch	100%	100%	<b>0.78</b>	<b>0.78</b>

**Table 14.4-11: SAR Values (WLAN - Body) – Scaled Reported SAR**

Frequency		Test Position	D (mm)	Actual duty factor	maximum duty factor	Reported SAR (1g) (W/kg)	Scaled reported SAR (1g) (W/kg)
MHz	Ch.						
140	5700	Right	10	100%	100%	<b>0.45</b>	<b>0.45</b>



Picture 14.3 The plot of duty factor



Picture 14.4 The plot of duty factor

### 14.5 SAR results for Fast BT

**Table 14.5-1: SAR Values (Bluetooth - Head)**

Frequency		Side	Test Position	Figure No.	Conducted Power (dBm)	Max. tune-up Power (dBm)	Measured SAR(10g) (W/kg)	Reported SAR(10g) (W/kg)	Measured SAR(1g) (W/kg)	Reported SAR(1g) (W/kg)	Power Drift (dB)
Ch.	MHz										
39	2441	Left	Touch	/	9.26	10	< 0.01	<b>&lt; 0.01</b>	< 0.01	<b>&lt; 0.01</b>	/
39	2441	Left	Tilt	/	9.26	10	< 0.01	<b>&lt; 0.01</b>	< 0.01	<b>&lt; 0.01</b>	/
39	2441	Right	Touch	/	9.26	10	< 0.01	<b>&lt; 0.01</b>	< 0.01	<b>&lt; 0.01</b>	/
39	2441	Right	Tilt	/	9.26	10	< 0.01	<b>&lt; 0.01</b>	< 0.01	<b>&lt; 0.01</b>	/

**Table 14.5-2: SAR Values (Bluetooth - Body)**

Frequency		Test Position	Figure No.	Conducted Power (dBm)	Max. tune-up Power (dBm)	Measured SAR(10g) (W/kg)	Reported SAR(10g) (W/kg)	Measured SAR(1g) (W/kg)	Reported SAR(1g) (W/kg)	Power Drift (dB)	
Ch	MHz										
Ambient Temperature: 22.2 °C					Liquid Temperature: 22 °C						
39	2441	Front	/	9.26	10	< 0.01	<b>&lt; 0.01</b>	< 0.01	<b>&lt; 0.01</b>	/	
39	2441	Rear	/	9.26	10	< 0.01	<b>&lt; 0.01</b>	< 0.01	<b>&lt; 0.01</b>	/	
39	2441	Left	/	9.26	10	< 0.01	<b>&lt; 0.01</b>	< 0.01	<b>&lt; 0.01</b>	/	
39	2441	Top	/	9.26	10	< 0.01	<b>&lt; 0.01</b>	< 0.01	<b>&lt; 0.01</b>	/	

Note1: The distance between the EUT and the phantom bottom is 10mm

#### 14.6 SAR Evaluation for Phablet

According to the KDB648474 D04, for smart phones, with a display diagonal dimension > 15.0 cm or an overall diagonal dimension > 16.0 cm, that can provide similar mobile web access and multimedia support found in mini-tablets or UMPC mini-tablets and support voice calls next to the ear, unless it is confirmed otherwise through KDB inquiries, the following phablet procedures should be applied to evaluate SAR compliance for each applicable wireless modes and frequency band. Devices marketed as phablets, regardless of form factors and operating characteristics must be tested as a phablet to determine SAR compliance.

1. The normally required head and body-worn accessory SAR test procedures for handsets, including hotspot mode, must be applied.
2. The UMPC mini-tablet procedures must also be applied to test the SAR of all surfaces and edges with an antenna located at  $\leq 25$  mm from that surface or edge, in direct contact with a flat phantom, for 10-g extremity SAR according to the body-equivalent tissue dielectric parameters in KDB Publication 865664 D01 to address interactive hand use exposure conditions. When hotspot mode applies, 10-g extremity SAR is required only for the surfaces and edges with hotspot mode 1-g reported SAR > 1.2 W/kg; however, when power reduction applies to hotspot mode the measured SAR must be scaled to the maximum output power, including tolerance, allowed for phablet modes to compare with the 1.2 W/kg SAR test reduction threshold. The normal tablet procedures in KDB Publication 616217 are required when the overall diagonal dimension of the device is > 20.0 cm. Hotspot mode SAR is not required when normal tablet procedures are applied. Extremity 10-g SAR is also not required for the front (top) surface of larger form factor full size tablets. The more conservative normal tablet SAR results can be used to support phablet mode 10-g extremity SAR.
3. The simultaneous transmission operating configurations applicable to voice and data transmissions for both phone and mini-tablet modes must be taken into consideration separately for 1-g and 10-g SAR to determine the simultaneous transmission SAR test exclusion and measurement requirements for the relevant wireless modes and exposure conditions



For the device of this project, the display diagonal dimension is 166.2 cm (> 15.0 cm) and the overall diagonal dimension is 183.69 cm (> 16.0 cm), so this device is a phone as “phablet”.

**Table 14.6-1: SAR Values for 10g extremity SAR**

Frequency			Mode/ Figure No.	Conducted Power (dBm)	Max. tune-up Power (dBm)	Measured SAR(10g) (W/kg)	Reported SAR(10g) (W/kg)	Power Drift (dB)	Limited (W/kg)	
Band	Ch.	MHz								
Ambient Temperature: 22.9 °C			Liquid Temperature: 22.5 °C							
LTE Band41-PC2	41090	2680	Bottom	27.26	28.00	1.85	<b>2.19</b>	0.16		
LTE Band41-PC2	41055	2636.5	Bottom	27.15	28.00	1.81	<b>2.20</b>	0.08		
LTE Band41-PC2	40620	2593	Bottom	27.21	28.00	1.74	<b>2.09</b>	0.07		
LTE Band41-PC2	40185	2549.5	Bottom	27.09	28.00	1.67	<b>2.06</b>	0.03		
LTE Band41-PC2	39750	2506	Bottom	26.94	28.00	2.06	<b>2.63</b>	0.16		

Note1: The distance between the EUT and the phantom bottom is 0mm.

**Table 14.6-2: The sum of SAR values for 10g extremity SAR**

	Position	Main antenna	WiFi-2.4G	Sum	Limited
<b>10-g extremity SAR (Separation Distance 0mm)</b>	Bottom (LTE Band41-PC2)	2.63	/	<b>2.63</b>	4.0

**Table 14.6-3: The sum of SAR values for 10g extremity SAR**

	Position	Main antenna	WiFi-5G	Sum	Limited
<b>10-g extremity SAR (Separation Distance 0mm)</b>	Bottom (LTE Band41-PC2)	2.63	/	<b>2.63</b>	4.0

## 15 SAR Measurement Variability

SAR measurement variability must be assessed for each frequency band, which is determined by the SAR probe calibration point and tissue-equivalent medium used for the device measurements. When both head and body tissue-equivalent media are required for SAR measurements in a frequency band, the variability measurement procedures should be applied to the tissue medium with the highest measured SAR, using the highest measured SAR configuration for that tissue-equivalent medium.

The following procedures are applied to determine if repeated measurements are required.

- 1) Repeated measurement is not required when the original highest measured SAR is  $< 0.80$  W/kg; steps 2) through 4) do not apply.
- 2) When the original highest measured SAR is  $\geq 0.80$  W/kg, repeat that measurement once.
- 3) Perform a second repeated measurement only if the ratio of largest to smallest SAR for the original and first repeated measurements is  $> 1.20$  or when the original or repeated measurement is  $\geq 1.45$  W/kg ( $\sim 10\%$  from the 1-g SAR limit).
- 4) Perform a third repeated measurement only if the original, first or second repeated measurement is  $\geq 1.5$  W/kg and the ratio of largest to smallest SAR for the original, first and second repeated measurements is  $> 1.20$ .

**Table 15.1: SAR Measurement Variability for Body WCDMA1900 (1g)**

Frequency		Test Position	Spacing (mm)	Original SAR (W/kg)	First Repeated SAR (W/kg)	The Ratio	Second Repeated SAR (W/kg)
Ch.	MHz						
9538	1907.6	Rear	10	0.882	0.871	1.01	/

**Table 15.2: SAR Measurement Variability for Body LTE Band41-PC2(1g)**

Frequency		Test Position	Spacing (mm)	Original SAR (W/kg)	First Repeated SAR (W/kg)	The Ratio	Second Repeated SAR (W/kg)
Ch.	MHz						
39750	2506	Bottom	10	1.12	1.07	1.05	/

## 16 Measurement Uncertainty

### 16.1 Measurement Uncertainty for Normal SAR Tests (300MHz~3GHz)

No.	Error Description	Type	Uncertainty value	Probably Distribution	Div.	(Ci) 1g	(Ci) 10g	Std. Unc. (1g)	Std. Unc. (10g)	Degree of freedom
<b>Measurement system</b>										
1	Probe calibration	B	6.0	N	1	1	1	6.0	6.0	$\infty$
2	Isotropy	B	4.7	R	$\sqrt{3}$	0.7	0.7	1.9	1.9	$\infty$
3	Boundary effect	B	1.0	R	$\sqrt{3}$	1	1	0.6	0.6	$\infty$
4	Linearity	B	4.7	R	$\sqrt{3}$	1	1	2.7	2.7	$\infty$
5	Detection limit	B	1.0	N	1	1	1	0.6	0.6	$\infty$
6	Readout electronics	B	0.3	R	$\sqrt{3}$	1	1	0.3	0.3	$\infty$
7	Response time	B	0.8	R	$\sqrt{3}$	1	1	0.5	0.5	$\infty$
8	Integration time	B	2.6	R	$\sqrt{3}$	1	1	1.5	1.5	$\infty$
9	RF ambient conditions-noise	B	0	R	$\sqrt{3}$	1	1	0	0	$\infty$
10	RFambient conditions-reflection	B	0	R	$\sqrt{3}$	1	1	0	0	$\infty$
11	Probe positioned mech. restrictions	B	0.4	R	$\sqrt{3}$	1	1	0.2	0.2	$\infty$
12	Probe positioning with respect to phantom shell	B	2.9	R	$\sqrt{3}$	1	1	1.7	1.7	$\infty$
13	Post-processing	B	1.0	R	$\sqrt{3}$	1	1	0.6	0.6	$\infty$
<b>Test sample related</b>										
14	Test sample positioning	A	3.3	N	1	1	1	3.3	3.3	71
15	Device holder uncertainty	A	3.4	N	1	1	1	3.4	3.4	5
16	Drift of output power	B	5.0	R	$\sqrt{3}$	1	1	2.9	2.9	$\infty$
<b>Phantom and set-up</b>										
17	Phantom uncertainty	B	4.0	R	$\sqrt{3}$	1	1	2.3	2.3	$\infty$
18	Liquid conductivity (target)	B	5.0	R	$\sqrt{3}$	0.64	0.43	1.8	1.2	$\infty$
19	Liquid conductivity (meas.)	A	2.06	N	1	0.64	0.43	1.32	0.89	43
20	Liquid permittivity (target)	B	5.0	R	$\sqrt{3}$	0.6	0.49	1.7	1.4	$\infty$
21	Liquid permittivity (meas.)	A	1.6	N	1	0.6	0.49	1.0	0.8	521

Combined standard uncertainty	$u_c = \sqrt{\sum_{i=1}^{21} c_i^2 u_i^2}$							9.55	9.43	257
Expanded uncertainty (confidence interval of 95 %)	$u_e = 2u_c$							19.1	18.9	

### 16.2 Measurement Uncertainty for Normal SAR Tests (3~6GHz)

No.	Error Description	Type	Uncertainty value	Probably Distribution	Div.	(Ci) 1g	(Ci) 10g	Std. Unc. (1g)	Std. Unc. (10g)	Degree of freedom
<b>Measurement system</b>										
1	Probe calibration	B	6.55	N	1	1	1	6.55	6.55	$\infty$
2	Isotropy	B	4.7	R	$\sqrt{3}$	0.7	0.7	1.9	1.9	$\infty$
3	Boundary effect	B	2.0	R	$\sqrt{3}$	1	1	1.2	1.2	$\infty$
4	Linearity	B	4.7	R	$\sqrt{3}$	1	1	2.7	2.7	$\infty$
5	Detection limit	B	1.0	R	$\sqrt{3}$	1	1	0.6	0.6	$\infty$
6	Readout electronics	B	0.3	R	$\sqrt{3}$	1	1	0.3	0.3	$\infty$
7	Response time	B	0.8	R	$\sqrt{3}$	1	1	0.5	0.5	$\infty$
8	Integration time	B	2.6	R	$\sqrt{3}$	1	1	1.5	1.5	$\infty$
9	RF ambient conditions-noise	B	0	R	$\sqrt{3}$	1	1	0	0	$\infty$
10	RFambient conditions-reflection	B	0	R	$\sqrt{3}$	1	1	0	0	$\infty$
11	Probe positioned mech. restrictions	B	0.8	R	$\sqrt{3}$	1	1	0.5	0.5	$\infty$
12	Probe positioning with respect to phantom shell	B	6.7	R	$\sqrt{3}$	1	1	3.9	3.9	$\infty$
13	Post-processing	B	4.0	R	$\sqrt{3}$	1	1	2.3	2.3	$\infty$
<b>Test sample related</b>										
14	Test sample positioning	A	3.3	N	1	1	1	3.3	3.3	71
15	Device holder uncertainty	A	3.4	N	1	1	1	3.4	3.4	5
16	Drift of output power	B	5.0	R	$\sqrt{3}$	1	1	2.9	2.9	$\infty$
<b>Phantom and set-up</b>										
17	Phantom uncertainty	B	4.0	R	$\sqrt{3}$	1	1	2.3	2.3	$\infty$
18	Liquid conductivity (target)	B	5.0	R	$\sqrt{3}$	0.64	0.43	1.8	1.2	$\infty$
19	Liquid conductivity (meas.)	A	2.06	N	1	0.64	0.43	1.32	0.89	43
20	Liquid permittivity	B	5.0	R	$\sqrt{3}$	0.6	0.49	1.7	1.4	$\infty$

	(target)									
21	Liquid permittivity (meas.)	A	1.6	N	1	0.6	0.49	1.0	0.8	521
Combined standard uncertainty		$u_c = \sqrt{\sum_{i=1}^{21} c_i^2 u_i^2}$						10.7	10.6	257
Expanded uncertainty (confidence interval of 95 %)		$u_e = 2u_c$						21.4	21.1	

### 16.3 Measurement Uncertainty for Fast SAR Tests (300MHz~3GHz)

No.	Error Description	Type	Uncertainty value	Probably Distribution	Div.	(Ci) 1g	(Ci) 10g	Std. Unc. (1g)	Std. Unc. (10g)	Degree of freedom
<b>Measurement system</b>										
1	Probe calibration	B	6.0	N	1	1	1	6.0	6.0	$\infty$
2	Isotropy	B	4.7	R	$\sqrt{3}$	0.7	0.7	1.9	1.9	$\infty$
3	Boundary effect	B	1.0	R	$\sqrt{3}$	1	1	0.6	0.6	$\infty$
4	Linearity	B	4.7	R	$\sqrt{3}$	1	1	2.7	2.7	$\infty$
5	Detection limit	B	1.0	R	$\sqrt{3}$	1	1	0.6	0.6	$\infty$
6	Readout electronics	B	0.3	R	$\sqrt{3}$	1	1	0.3	0.3	$\infty$
7	Response time	B	0.8	R	$\sqrt{3}$	1	1	0.5	0.5	$\infty$
8	Integration time	B	2.6	R	$\sqrt{3}$	1	1	1.5	1.5	$\infty$
9	RF ambient conditions-noise	B	0	R	$\sqrt{3}$	1	1	0	0	$\infty$
10	RFambient conditions-reflection	B	0	R	$\sqrt{3}$	1	1	0	0	$\infty$
11	Probe positioned mech. Restrictions	B	0.4	R	$\sqrt{3}$	1	1	0.2	0.2	$\infty$
12	Probe positioning with respect to phantom shell	B	2.9	R	$\sqrt{3}$	1	1	1.7	1.7	$\infty$
13	Post-processing	B	1.0	R	$\sqrt{3}$	1	1	0.6	0.6	$\infty$
14	Fast SAR z-Approximation	B	7.0	R	$\sqrt{3}$	1	1	4.0	4.0	$\infty$
<b>Test sample related</b>										
15	Test sample positioning	A	3.3	N	1	1	1	3.3	3.3	71
16	Device holder uncertainty	A	3.4	N	1	1	1	3.4	3.4	5
17	Drift of output power	B	5.0	R	$\sqrt{3}$	1	1	2.9	2.9	$\infty$
<b>Phantom and set-up</b>										
18	Phantom uncertainty	B	4.0	R	$\sqrt{3}$	1	1	2.3	2.3	$\infty$

19	Liquid conductivity (target)	B	5.0	R	$\sqrt{3}$	0.64	0.43	1.8	1.2	$\infty$
20	Liquid conductivity (meas.)	A	2.06	N	1	0.64	0.43	1.32	0.89	43
21	Liquid permittivity (target)	B	5.0	R	$\sqrt{3}$	0.6	0.49	1.7	1.4	$\infty$
22	Liquid permittivity (meas.)	A	1.6	N	1	0.6	0.49	1.0	0.8	521
Combined standard uncertainty		$u_c = \sqrt{\sum_{i=1}^{22} c_i^2 u_i^2}$						10.4	10.3	257
Expanded uncertainty (confidence interval of 95 %)		$u_e = 2u_c$						20.8	20.6	

#### 16.4 Measurement Uncertainty for Fast SAR Tests (3~6GHz)

No.	Error Description	Type	Uncertainty value	Probably Distribution	Div.	(Ci) 1g	(Ci) 10g	Std. Unc. (1g)	Std. Unc. (10g)	Degree of freedom
<b>Measurement system</b>										
1	Probe calibration	B	6.55	N	1	1	1	6.55	6.55	$\infty$
2	Isotropy	B	4.7	R	$\sqrt{3}$	0.7	0.7	1.9	1.9	$\infty$
3	Boundary effect	B	2.0	R	$\sqrt{3}$	1	1	1.2	1.2	$\infty$
4	Linearity	B	4.7	R	$\sqrt{3}$	1	1	2.7	2.7	$\infty$
5	Detection limit	B	1.0	R	$\sqrt{3}$	1	1	0.6	0.6	$\infty$
6	Readout electronics	B	0.3	R	$\sqrt{3}$	1	1	0.3	0.3	$\infty$
7	Response time	B	0.8	R	$\sqrt{3}$	1	1	0.5	0.5	$\infty$
8	Integration time	B	2.6	R	$\sqrt{3}$	1	1	1.5	1.5	$\infty$
9	RF ambient conditions-noise	B	0	R	$\sqrt{3}$	1	1	0	0	$\infty$
10	RF ambient conditions-reflection	B	0	R	$\sqrt{3}$	1	1	0	0	$\infty$
11	Probe positioned mech. Restrictions	B	0.8	R	$\sqrt{3}$	1	1	0.5	0.5	$\infty$
12	Probe positioning with respect to phantom shell	B	6.7	R	$\sqrt{3}$	1	1	3.9	3.9	$\infty$
13	Post-processing	B	1.0	R	$\sqrt{3}$	1	1	0.6	0.6	$\infty$
14	Fast SAR z-Approximation	B	14.0	R	$\sqrt{3}$	1	1	8.1	8.1	$\infty$
<b>Test sample related</b>										
15	Test sample positioning	A	3.3	N	1	1	1	3.3	3.3	71

16	Device holder uncertainty	A	3.4	N	1	1	1	3.4	3.4	5
17	Drift of output power	B	5.0	R	$\sqrt{3}$	1	1	2.9	2.9	$\infty$
<b>Phantom and set-up</b>										
18	Phantom uncertainty	B	4.0	R	$\sqrt{3}$	1	1	2.3	2.3	$\infty$
19	Liquid conductivity (target)	B	5.0	R	$\sqrt{3}$	0.64	0.43	1.8	1.2	$\infty$
20	Liquid conductivity (meas.)	A	2.06	N	1	0.64	0.43	1.32	0.89	43
21	Liquid permittivity (target)	B	5.0	R	$\sqrt{3}$	0.6	0.49	1.7	1.4	$\infty$
22	Liquid permittivity (meas.)	A	1.6	N	1	0.6	0.49	1.0	0.8	521
Combined standard uncertainty		$u_c = \sqrt{\sum_{i=1}^{22} c_i^2 u_i^2}$						13.5	13.4	257
Expanded uncertainty (confidence interval of 95 %)		$u_e = 2u_c$						27.0	26.8	

## 17 MAIN TEST INSTRUMENTS

**Table 17.1: List of Main Instruments**

No.	Name	Type	Serial Number	Calibration Date	Valid Period
01	Network analyzer	E5071C	MY46110673	January 14, 2021	One year
02	Power meter	NRVD	102083	October 23, 2020	One year
03	Power sensor	NRV-Z5	100542		
04	Signal Generator	E4438C	MY49071430	February 1, 2021	One Year
05	Amplifier	60S1G4	0331848	No Calibration Requested	
06	BTS	CMW500	159890	January 25 2021	One year
07	BTS	CMW500	159889	January 13 2021	One year
08	E-field Probe	SPEAG EX3DV4	7600	November 30, 2020	One year
09	DAE	SPEAG DAE4	1525	September 2, 2020	One year
10	Dipole Validation Kit	SPEAG D750V3	1132	December 23, 2020	One year
11	Dipole Validation Kit	SPEAG D835V2	4d120	June 23, 2021	One year
12	Dipole Validation Kit	SPEAG D1750V2	1023	June 23, 2021	One year
13	Dipole Validation Kit	SPEAG D1900V2	5d142	June 25, 2021	One year
14	Dipole Validation Kit	SPEAG D2450V2	869	June 22, 2021	One year
15	Dipole Validation Kit	SPEAG D2600V2	1012	July 21, 2020	One year
16	Dipole Validation Kit	SPEAG D5GHzV2	1203	December 22, 2020	One year

\*\*\*END OF REPORT BODY\*\*\*

## ANNEX A Graph Results

### GSM850\_CH251 Right Cheek

Date: 7/13/2021

Electronics: DAE4 Sn1525

Medium: H835

Medium parameters used (interpolated):  $f = 848.8$  MHz;  $\sigma = 0.869$  S/m;  $\epsilon_r = 44.161$ ;  $\rho = 1000$  kg/m<sup>3</sup>

Ambient Temperature: 22.7°C      Liquid Temperature: 22.3°C

Communication System: GSM850 2TX Frequency: 848.8 MHz Duty Cycle: 1:4.00037

Probe: EX3DV4 - SN7600 ConvF(10.88, 10.88, 10.88)

Area Scan (81x141x1): Interpolated grid: dx=1.500 mm, dy=1.500 mm

Maximum value of SAR (interpolated) = 0.482 W/kg

Zoom Scan (5x5x7)/Cube 0: Measurement grid: dx=8mm, dy=8mm, dz=5mm

Reference Value = 8.706 V/m; Power Drift = 0.03 dB

Peak SAR (extrapolated) = 0.529 W/kg

SAR(1 g) = 0.409 W/kg; SAR(10 g) = 0.324 W/kg

Maximum value of SAR (measured) = 0.482 W/kg

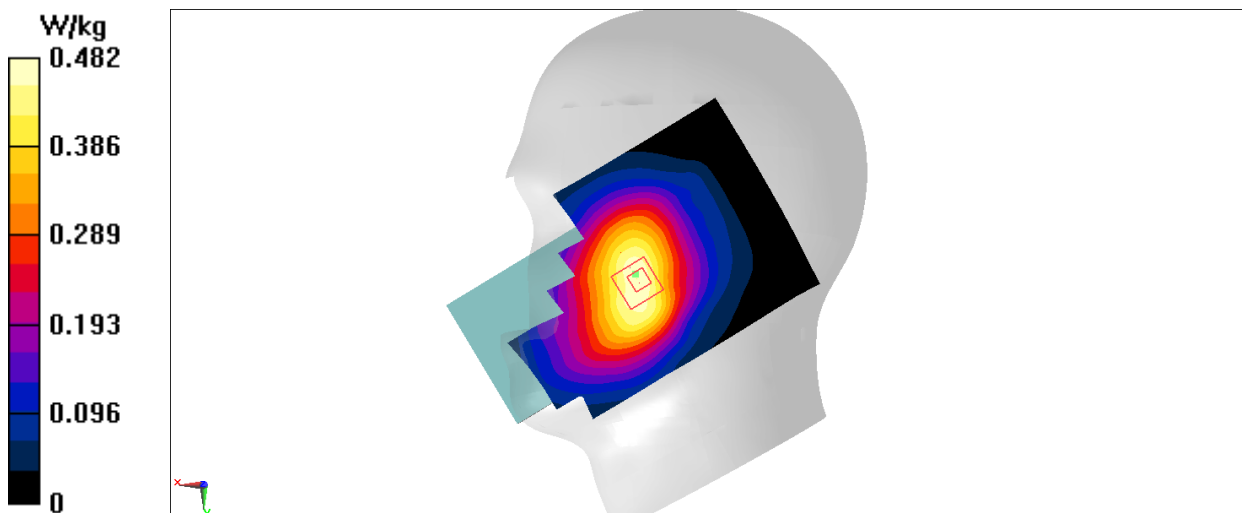


Fig A.1



**GSM850\_CH190 Rear**

Date: 7/13/2021

Electronics: DAE4 Sn1525

Medium: H835

Medium parameters used (interpolated):  $f = 836.6$  MHz;  $\sigma = 0.863$  S/m;  $\epsilon_r = 44.23$ ;  $\rho = 1000$  kg/m<sup>3</sup>

Ambient Temperature: 22.7°C      Liquid Temperature: 22.3°C

Communication System: GSM850 2TX Frequency: 836.6 MHz Duty Cycle: 1:4.00037

Probe: EX3DV4 - SN7600 ConvF(10.88, 10.88, 10.88)

Area Scan (81x131x1): Interpolated grid: dx=1.500 mm, dy=1.500 mm

Maximum value of SAR (interpolated) = 1.07 W/kg

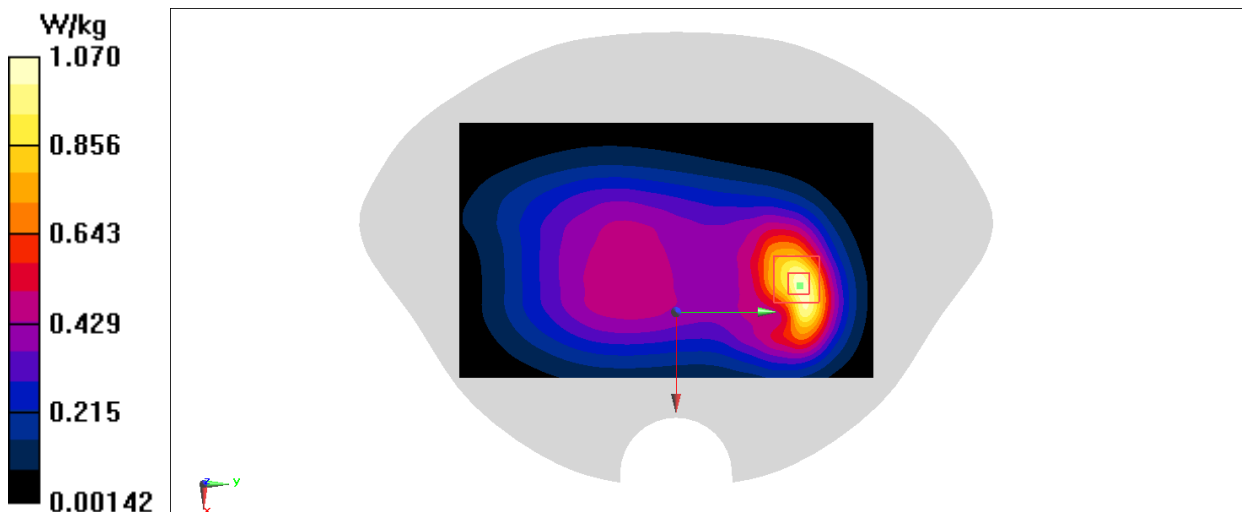
Zoom Scan (5x5x7)/Cube 0: Measurement grid: dx=8mm, dy=8mm, dz=5mm

Reference Value = 23.64 V/m; Power Drift = -0.12 dB

Peak SAR (extrapolated) = 1.35 W/kg

SAR(1 g) = 0.723 W/kg; SAR(10 g) = 0.433 W/kg

Maximum value of SAR (measured) = 1.07 W/kg



**Fig A.2**

**PCS1900\_CH810 Left Cheek**

Date: 7/17/2021

Electronics: DAE4 Sn1525

Medium: H1900

Medium parameters used:  $f = 1910$  MHz;  $\sigma = 1.467$  S/m;  $\epsilon_r = 41.329$ ;  $\rho = 1000$  kg/m<sup>3</sup>

Ambient Temperature: 22.5oC      Liquid Temperature: 22.4oC

Communication System: GSM1900 2TX Frequency: 1909.8 MHz Duty Cycle: 1:4.00037

Probe: EX3DV4 - SN7600 ConvF(8.7, 8.7, 8.7)

Area Scan (81x141x1): Interpolated grid: dx=1.500 mm, dy=1.500 mm

Maximum value of SAR (interpolated) = 0.417 W/kg

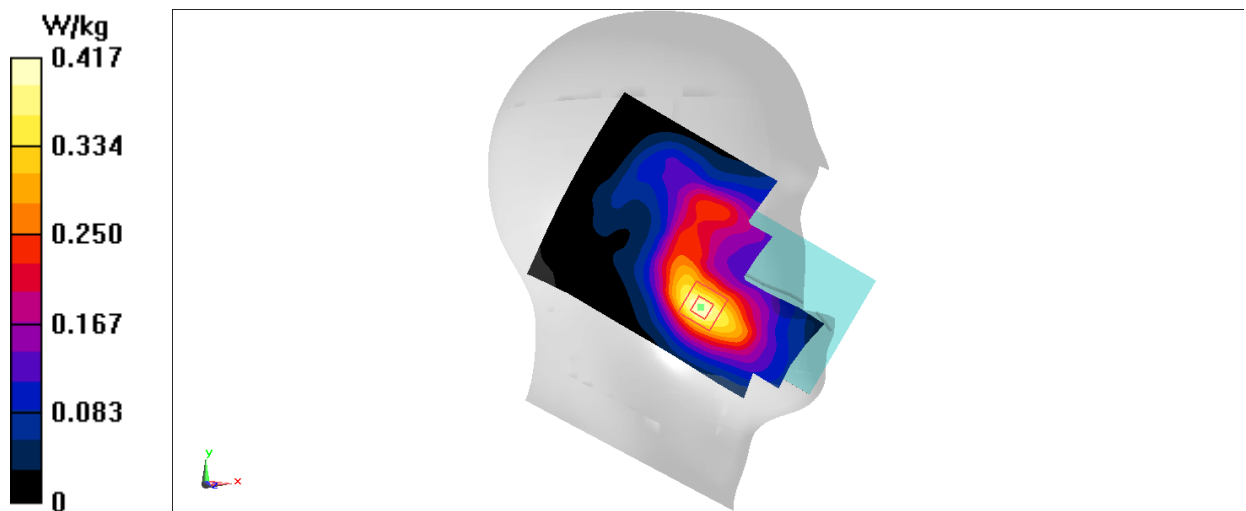
Zoom Scan (5x5x7)/Cube 0: Measurement grid: dx=8mm, dy=8mm, dz=5mm

Reference Value = 6.625 V/m; Power Drift = -0.17 dB

Peak SAR (extrapolated) = 0.462 W/kg

SAR(1 g) = 0.290 W/kg; SAR(10 g) = 0.185 W/kg

Maximum value of SAR (measured) = 0.402 W/kg

**Fig A.3**

**PCS1900\_CH661 Rear**

Date: 7/17/2021

Electronics: DAE4 Sn1525

Medium: H1900

Medium parameters used:  $f = 1880$  MHz;  $\sigma = 1.444$  S/m;  $\epsilon_r = 41.379$ ;  $\rho = 1000$  kg/m<sup>3</sup>

Ambient Temperature: 22.5oC      Liquid Temperature: 22.4oC

Communication System: GSM1900 2TX Frequency: 1880 MHz Duty Cycle: 1:4.00037

Probe: EX3DV4 - SN7600 ConvF(8.7, 8.7, 8.7)

Area Scan (81x141x1): Interpolated grid: dx=1.500 mm, dy=1.500 mm

Maximum value of SAR (interpolated) = 0.930 W/kg

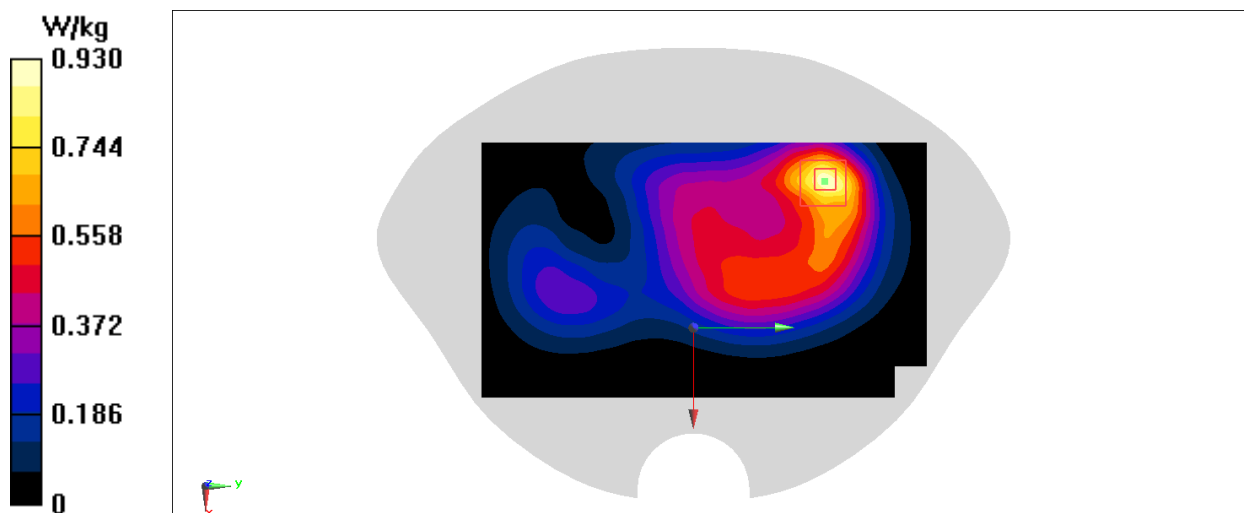
Zoom Scan (5x5x7)/Cube 0: Measurement grid: dx=8mm, dy=8mm, dz=5mm

Reference Value = 13.77 V/m; Power Drift = 0.16 dB

Peak SAR (extrapolated) = 1.06 W/kg

SAR(1 g) = 0.590 W/kg; SAR(10 g) = 0.340 W/kg

Maximum value of SAR (measured) = 0.887 W/kg

**Fig A.4**

**WCDMA1900-BII\_CH9400 Left Cheek**

Date: 7/17/2021

Electronics: DAE4 Sn1525

Medium: H1900

Medium parameters used:  $f = 1880$  MHz;  $\sigma = 1.444$  S/m;  $\epsilon_r = 41.379$ ;  $\rho = 1000$  kg/m<sup>3</sup>

Ambient Temperature: 22.5oC      Liquid Temperature: 22.4oC

Communication System: WCDMA1900(B2) Frequency: 1880 MHz Duty Cycle: 1:1

Probe: EX3DV4 - SN7600 ConvF(8.7, 8.7, 8.7)

Area Scan (81x141x1): Interpolated grid: dx=1.500 mm, dy=1.500 mm

Maximum value of SAR (interpolated) = 0.510 W/kg

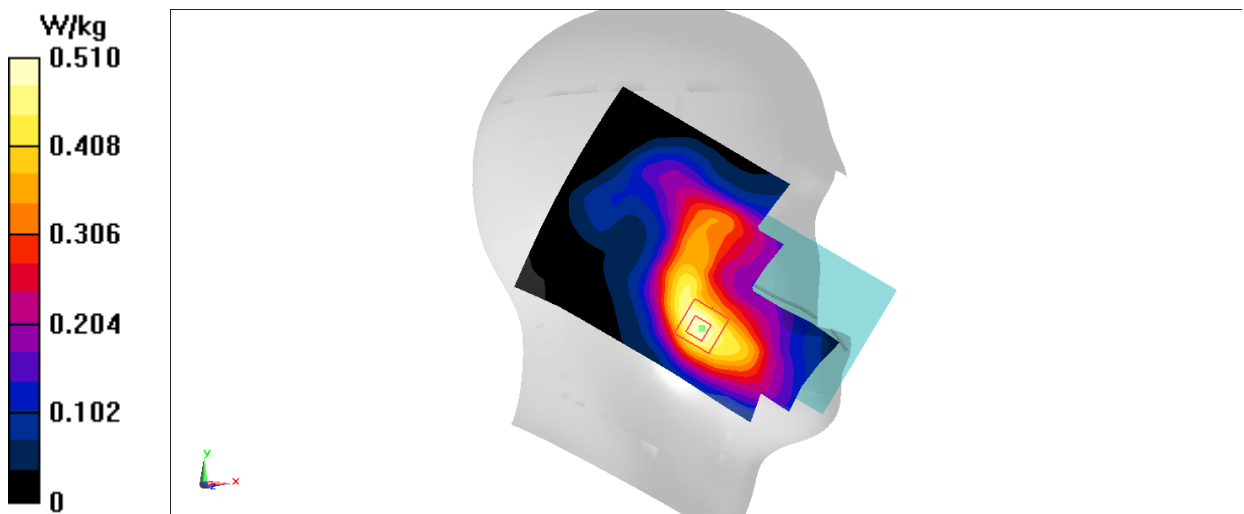
Zoom Scan (5x5x7)/Cube 0: Measurement grid: dx=8mm, dy=8mm, dz=5mm

Reference Value = 8.619 V/m; Power Drift = 0.00 dB

Peak SAR (extrapolated) = 0.590 W/kg

SAR(1 g) = 0.383 W/kg; SAR(10 g) = 0.252 W/kg

Maximum value of SAR (measured) = 0.518 W/kg

**Fig A.5**

**WCDMA1900-BII\_CH9538 Rear**

Date: 7/17/2021

Electronics: DAE4 Sn1525

Medium: H1900

Medium parameters used (interpolated):  $f = 1907.6$  MHz;  $\sigma = 1.467$  S/m;  $\epsilon_r = 41.329$ ;  $\rho = 1000$  kg/m<sup>3</sup>

Ambient Temperature: 22.5oC      Liquid Temperature: 22.4oC

Communication System: WCDMA1900(B2) Frequency: 1907.6 MHz Duty Cycle: 1:1

Probe: EX3DV4 - SN7600 ConvF(8.7, 8.7, 8.7)

Area Scan (81x131x1): Interpolated grid: dx=1.500 mm, dy=1.500 mm

Maximum value of SAR (interpolated) = 1.31 W/kg

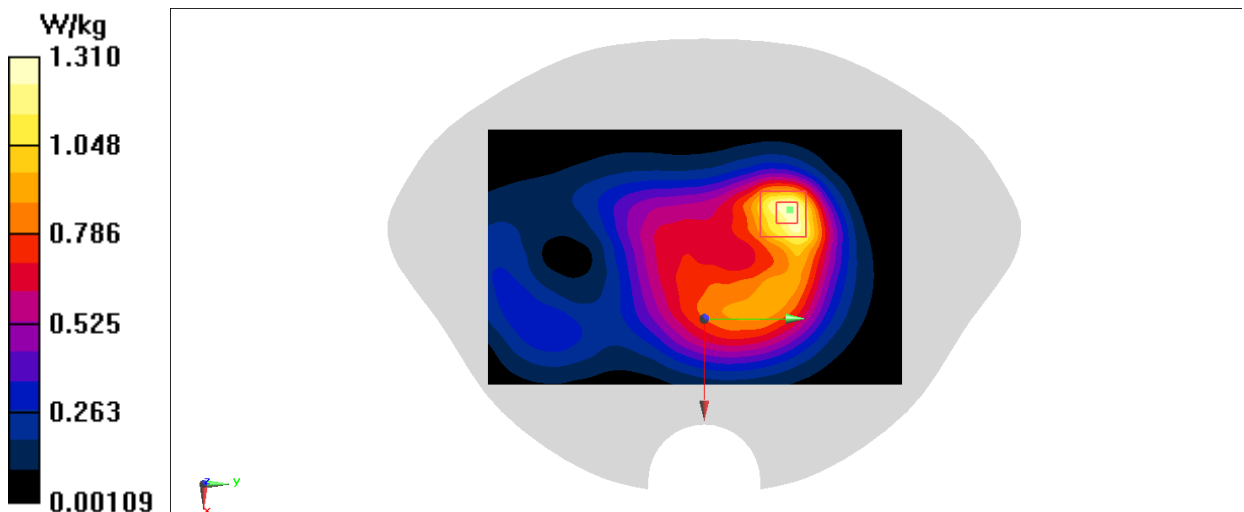
Zoom Scan (5x5x7)/Cube 0: Measurement grid: dx=8mm, dy=8mm, dz=5mm

Reference Value = 23.84 V/m; Power Drift = -0.07 dB

Peak SAR (extrapolated) = 1.63 W/kg

SAR(1 g) = 0.882 W/kg; SAR(10 g) = 0.500 W/kg

Maximum value of SAR (measured) = 1.30 W/kg

**Fig A.6**

**WCDMA1700-BIV\_CH1513 Left Cheek**

Date: 7/15/2021

Electronics: DAE4 Sn1525

Medium: H1750

Medium parameters used (interpolated):  $f = 1752.6$  MHz;  $\sigma = 1.38$  S/m;  $\epsilon_r = 41.609$ ;  $\rho = 1000$  kg/m<sup>3</sup>

Ambient Temperature: 22.9°C      Liquid Temperature: 22.6°C

Communication System: WCDMA1700(B4) Frequency: 1752.6 MHz Duty Cycle: 1:1

Probe: EX3DV4 - SN7600 ConvF(9.01, 9.01, 9.01)

Area Scan (81x141x1): Interpolated grid: dx=1.500 mm, dy=1.500 mm

Maximum value of SAR (interpolated) = 0.396 W/kg

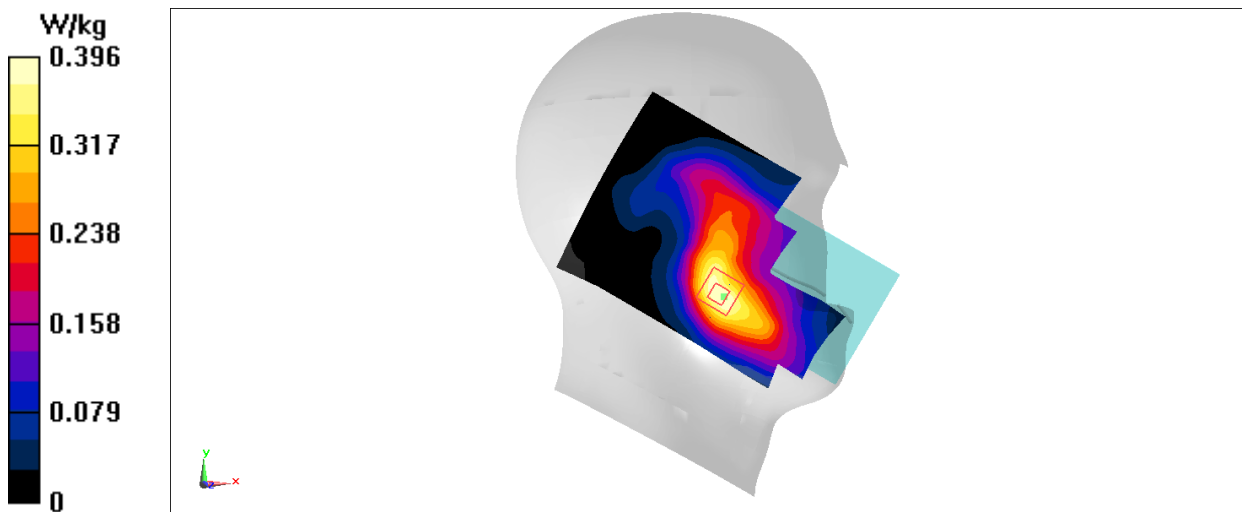
oom Scan (5x5x7)/Cube 0: Measurement grid: dx=8mm, dy=8mm, dz=5mm

Reference Value = 7.504 V/m; Power Drift = -0.16 dB

Peak SAR (extrapolated) = 0.443 W/kg

SAR(1 g) = 0.300 W/kg; SAR(10 g) = 0.203 W/kg

Maximum value of SAR (measured) = 0.394 W/kg

**Fig A.7**

**WCDMA1700-BIV\_CH1513 Rear**

Date: 7/15/2021

Electronics: DAE4 Sn1525

Medium: H1750

Medium parameters used (interpolated):  $f = 1732.5$  MHz;  $\sigma = 1.366$  S/m;  $\epsilon_r = 41.659$ ;  $\rho = 1000$  kg/m<sup>3</sup>

Ambient Temperature: 22.9°C      Liquid Temperature: 22.6°C

Communication System: WCDMA1700(B4) Frequency: 1732.5 MHz Duty Cycle: 1:1

Probe: EX3DV4 - SN7600 ConvF(9.01, 9.01, 9.01)

Area Scan (81x131x1): Interpolated grid: dx=1.500 mm, dy=1.500 mm

Maximum value of SAR (interpolated) = 1.02 W/kg

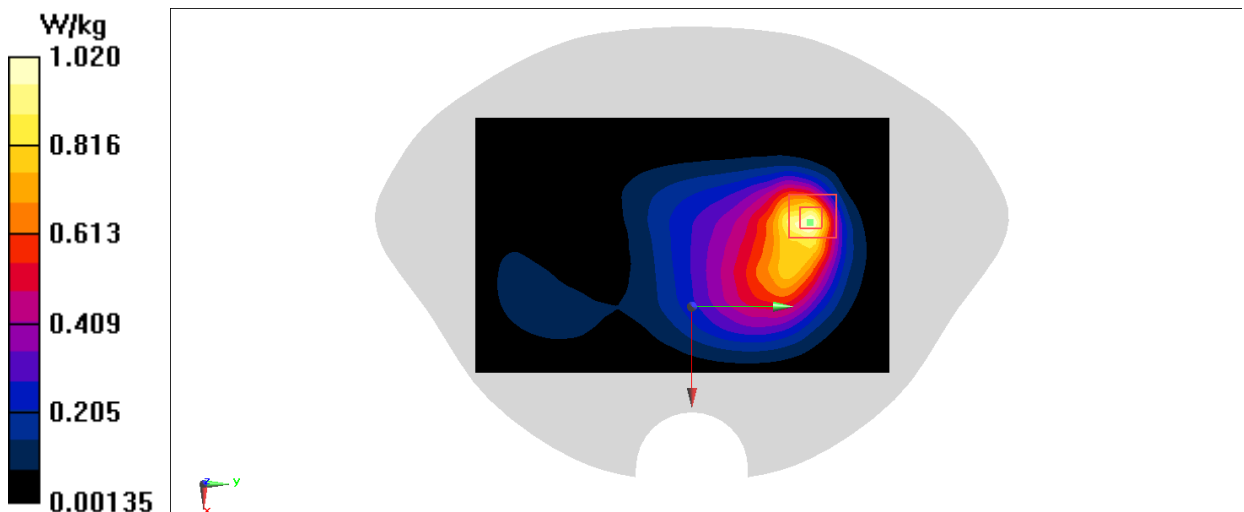
Zoom Scan (6x6x7)/Cube 0: Measurement grid: dx=8mm, dy=8mm, dz=5mm

Reference Value = 15.45 V/m; Power Drift = -0.18 dB

Peak SAR (extrapolated) = 1.04 W/kg

SAR(1 g) = 0.595 W/kg; SAR(10 g) = 0.376 W/kg

Maximum value of SAR (measured) = 0.835 W/kg

**Fig A.8**

**WCDMA850-BV\_CH4183 Right Cheek**

Date: 7/13/2021

Electronics: DAE4 Sn1525

Medium: H835

Medium parameters used (interpolated):  $f = 836.6$  MHz;  $\sigma = 0.863$  S/m;  $\epsilon_r = 44.23$ ;  $\rho = 1000$  kg/m<sup>3</sup>

Ambient Temperature: 22.7°C      Liquid Temperature: 22.3°C

Communication System: WCDMA850(B5) Frequency: 836.6 MHz Duty Cycle: 1:1

Probe: EX3DV4 - SN7600 ConvF(10.88, 10.88, 10.88)

Area Scan (81x141x1): Interpolated grid: dx=1.500 mm, dy=1.500 mm

Maximum value of SAR (interpolated) = 0.338 W/kg

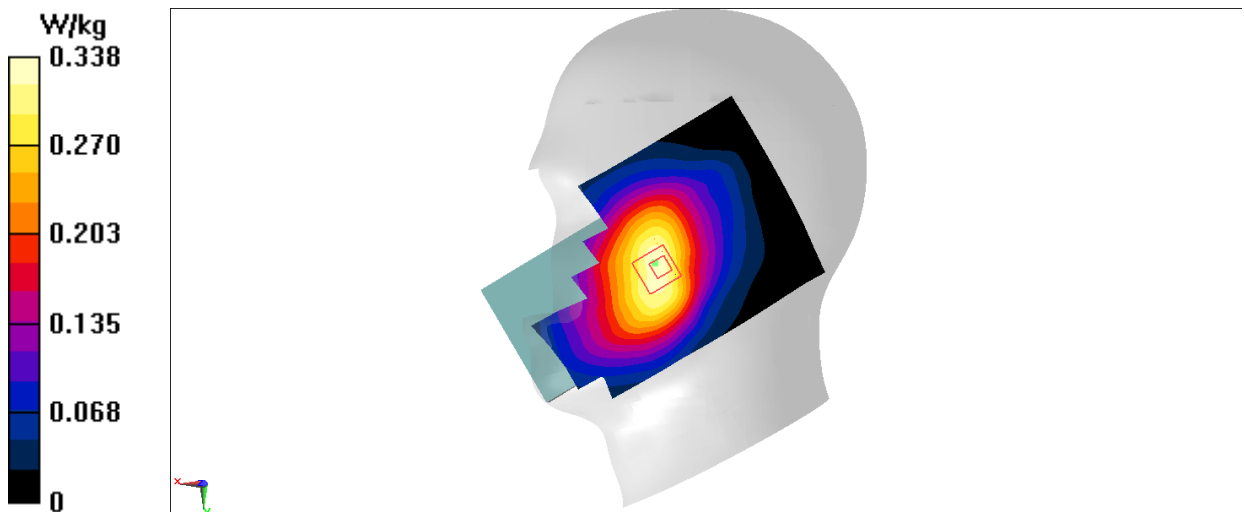
Zoom Scan (5x5x7)/Cube 0: Measurement grid: dx=8mm, dy=8mm, dz=5mm

Reference Value = 8.457 V/m; Power Drift = 0.05 dB

Peak SAR (extrapolated) = 0.377 W/kg

SAR(1 g) = 0.282 W/kg; SAR(10 g) = 0.224 W/kg

Maximum value of SAR (measured) = 0.339 W/kg

**Fig A.9**



**WCDMA850-BV\_CH4183 Rear**

Date: 7/13/2021

Electronics: DAE4 Sn1525

Medium: H835

Medium parameters used (interpolated):  $f = 836.6$  MHz;  $\sigma = 0.863$  S/m;  $\epsilon_r = 44.23$ ;  $\rho = 1000$  kg/m<sup>3</sup>

Ambient Temperature: 22.7°C      Liquid Temperature: 22.3°C

Communication System: WCDMA850(B5) Frequency: 836.6 MHz Duty Cycle: 1:1

Probe: EX3DV4 - SN7600 ConvF(10.88, 10.88, 10.88)

Area Scan (81x131x1): Interpolated grid: dx=1.500 mm, dy=1.500 mm

Maximum value of SAR (interpolated) = 0.794 W/kg

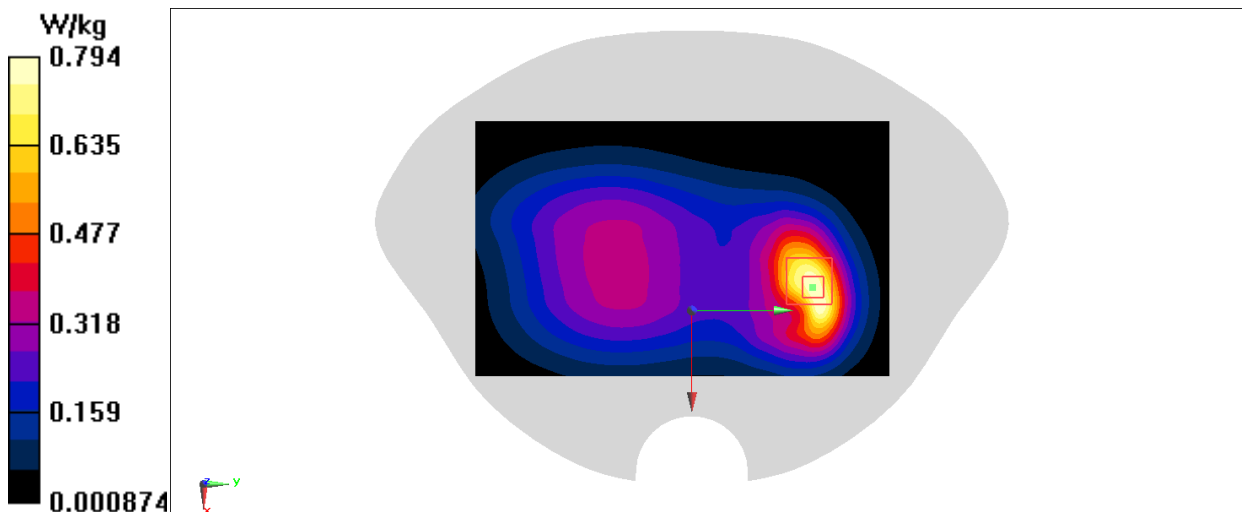
Zoom Scan (5x5x7)/Cube 0: Measurement grid: dx=8mm, dy=8mm, dz=5mm

Reference Value = 17.35 V/m; Power Drift = -0.05 dB

Peak SAR (extrapolated) = 1.08 W/kg

SAR(1 g) = 0.570 W/kg; SAR(10 g) = 0.336 W/kg

Maximum value of SAR (measured) = 0.850 W/kg

**Fig A.10**

**LTE750-FDD12\_CH23060 Right Cheek**

Date: 7/18/2021

Electronics: DAE4 Sn1525

Medium: H750

Medium parameters used (interpolated):  $f = 704$  MHz;  $\sigma = 0.811$  S/m;  $\epsilon_r = 44.843$ ;  $\rho = 1000$  kg/m<sup>3</sup>

Ambient Temperature: 22.7°C      Liquid Temperature: 22.4°C

Communication System: LTE Band12 Frequency: 704 MHz Duty Cycle: 1:1

Probe: EX3DV4 - SN7600 ConvF(10.88, 10.88, 10.88)

Area Scan (81x141x1): Interpolated grid:  $dx=1.500$  mm,  $dy=1.500$  mm

Maximum value of SAR (interpolated) = 0.245 W/kg

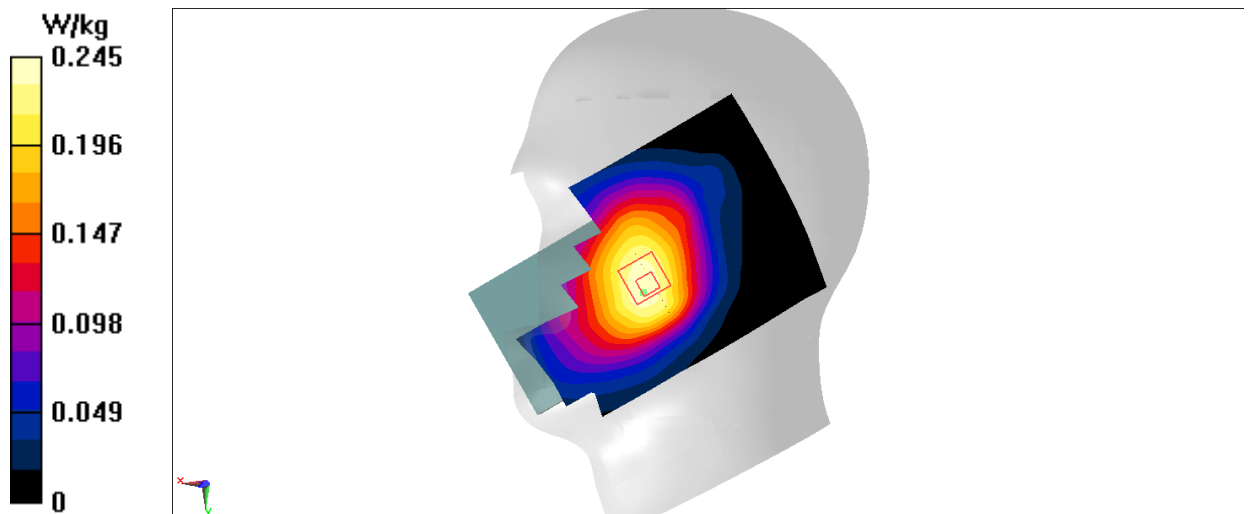
Zoom Scan (6x6x7)/Cube 0: Measurement grid:  $dx=8$ mm,  $dy=8$ mm,  $dz=5$ mm

Reference Value = 5.109 V/m; Power Drift = -0.18 dB

Peak SAR (extrapolated) = 0.264 W/kg

SAR(1 g) = 0.209 W/kg; SAR(10 g) = 0.170 W/kg

Maximum value of SAR (measured) = 0.242 W/kg

**Fig A.11**

**LTE750-FDD12\_CH23060 Rear**

Date: 7/18/2021

Electronics: DAE4 Sn1525

Medium: H750

Medium parameters used (interpolated):  $f = 704$  MHz;  $\sigma = 0.811$  S/m;  $\epsilon_r = 44.843$ ;  $\rho = 1000$  kg/m<sup>3</sup>

Ambient Temperature: 22.7°C      Liquid Temperature: 22.4°C

Communication System: LTE Band12 Frequency: 704 MHz Duty Cycle: 1:1

Probe: EX3DV4 - SN7600 ConvF(10.88, 10.88, 10.88)

Area Scan (81x131x1): Interpolated grid: dx=1.500 mm, dy=1.500 mm

Maximum value of SAR (interpolated) = 0.467 W/kg

Zoom Scan (5x5x7)/Cube 0: Measurement grid: dx=8mm, dy=8mm, dz=5mm

Reference Value = 22.43 V/m; Power Drift = -0.12 dB

Peak SAR (extrapolated) = 0.509 W/kg

SAR(1 g) = 0.386 W/kg; SAR(10 g) = 0.305 W/kg

Maximum value of SAR (measured) = 0.460 W/kg

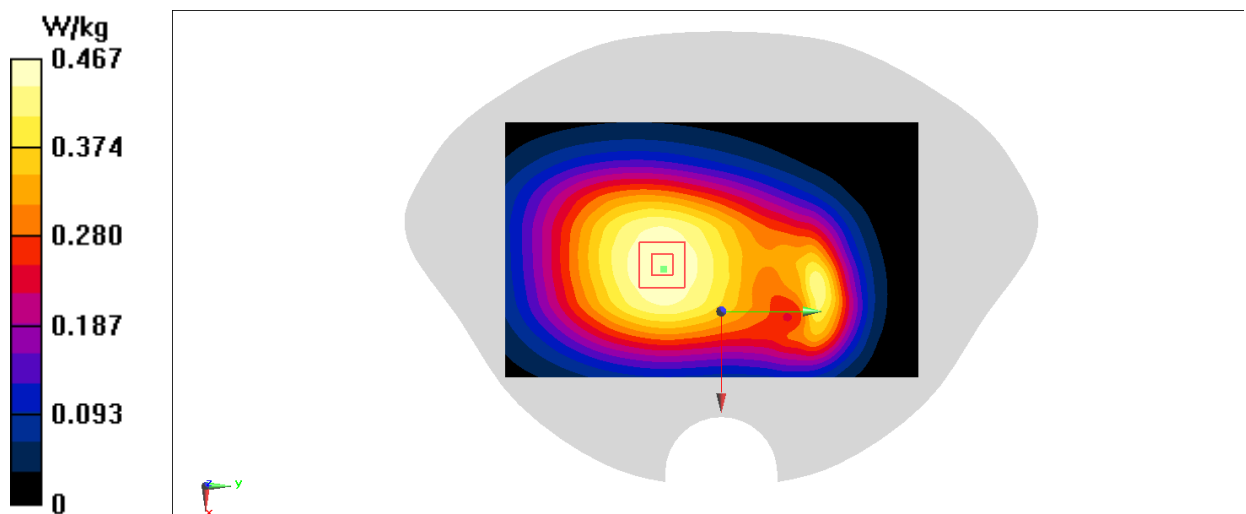


Fig A.12

**LTE1900-FDD25\_CH26100 Left Cheek**

Date: 7/17/2021

Electronics: DAE4 Sn1525

Medium: H1900

Medium parameters used:  $f = 1860$  MHz;  $\sigma = 1.43$  S/m;  $\epsilon_r = 41.384$ ;  $\rho = 1000$  kg/m<sup>3</sup>

Ambient Temperature: 22.5°C      Liquid Temperature: 22.4°C

Communication System: LTE Band25 Frequency: 1860 MHz Duty Cycle: 1:1

Probe: EX3DV4 - SN7600 ConvF(8.7, 8.7, 8.7)

Area Scan (81x141x1): Interpolated grid: dx=1.500 mm, dy=1.500 mm

Maximum value of SAR (interpolated) = 0.431 W/kg

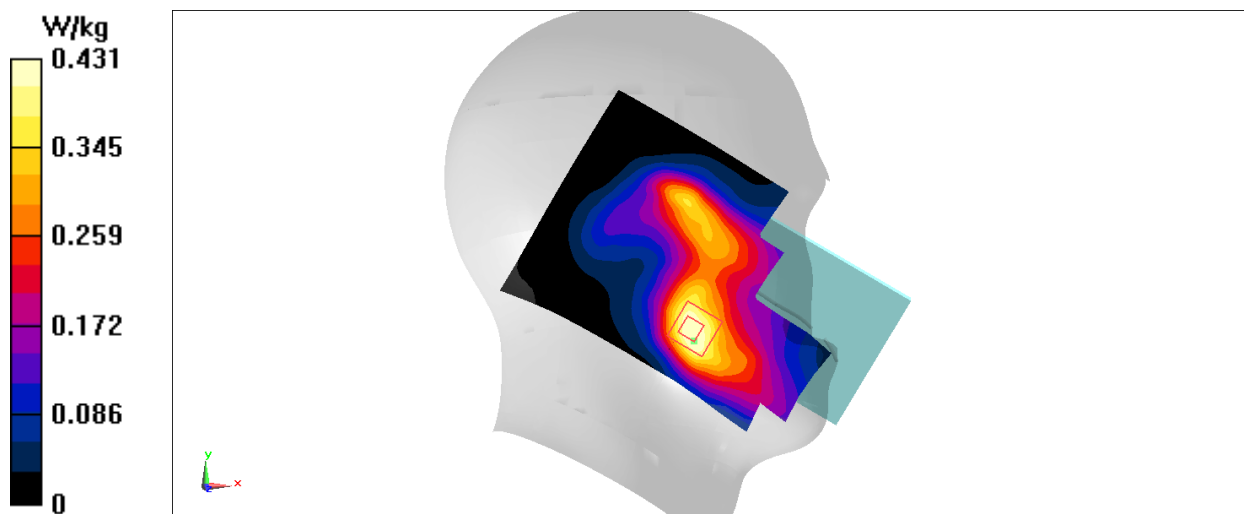
Zoom Scan (6x5x7)/Cube 0: Measurement grid: dx=8mm, dy=8mm, dz=5mm

Reference Value = 9.298 V/m; Power Drift = -0.02 dB

Peak SAR (extrapolated) = 0.481 W/kg

SAR(1 g) = 0.331 W/kg; SAR(10 g) = 0.221 W/kg

Maximum value of SAR (measured) = 0.423 W/kg



**Fig A.13**

**LTE1900-FDD25\_CH26100 Rear**

Date: 7/17/2021

Electronics: DAE4 Sn1525

Medium: H1900

Medium parameters used:  $f = 1860$  MHz;  $\sigma = 1.43$  S/m;  $\epsilon_r = 41.384$ ;  $\rho = 1000$  kg/m<sup>3</sup>

Ambient Temperature: 22.5oC      Liquid Temperature: 22.4oC

Communication System: LTE Band25 Frequency: 1860 MHz Duty Cycle: 1:1

Probe: EX3DV4 - SN7600 ConvF(8.7, 8.7, 8.7)

Area Scan (81x131x1): Interpolated grid: dx=1.500 mm, dy=1.500 mm

Maximum value of SAR (interpolated) = 1.26 W/kg

Zoom Scan (5x5x7)/Cube 0: Measurement grid: dx=8mm, dy=8mm, dz=5mm

Reference Value = 23.83 V/m; Power Drift = 0.02 dB

Peak SAR (extrapolated) = 1.46 W/kg

SAR(1 g) = 0.794 W/kg; SAR(10 g) = 0.458 W/kg

Maximum value of SAR (measured) = 1.21 W/kg

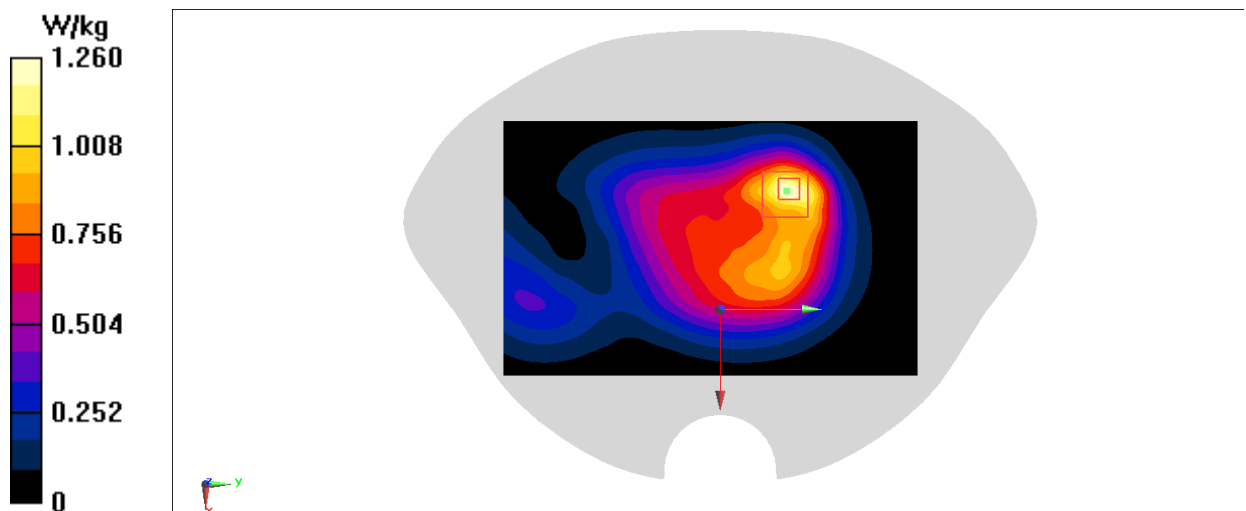


Fig A.14

**LTE850-FDD26\_CH26865 Right Cheek**

Date: 7/13/2021

Electronics: DAE4 Sn1525

Medium: H835

Medium parameters used (interpolated):  $f = 831.5$  MHz;  $\sigma = 0.861$  S/m;  $\epsilon_r = 44.241$ ;  $\rho = 1000$  kg/m<sup>3</sup>

Ambient Temperature: 22.7°C      Liquid Temperature: 22.3°C

Communication System: LTE Band26 15M Frequency: 831.5 MHz Duty Cycle: 1:1

Probe: EX3DV4 - SN7600 ConvF(10.88, 10.88, 10.88)

Area Scan (81x141x1): Interpolated grid: dx=1.500 mm, dy=1.500 mm

Maximum value of SAR (interpolated) = 0.318 W/kg

Zoom Scan (5x5x7)/Cube 0: Measurement grid: dx=8mm, dy=8mm, dz=5mm

Reference Value = 5.897 V/m; Power Drift = -0.13 dB

Peak SAR (extrapolated) = 0.347 W/kg

SAR(1 g) = 0.270 W/kg; SAR(10 g) = 0.215 W/kg

Maximum value of SAR (measured) = 0.315 W/kg

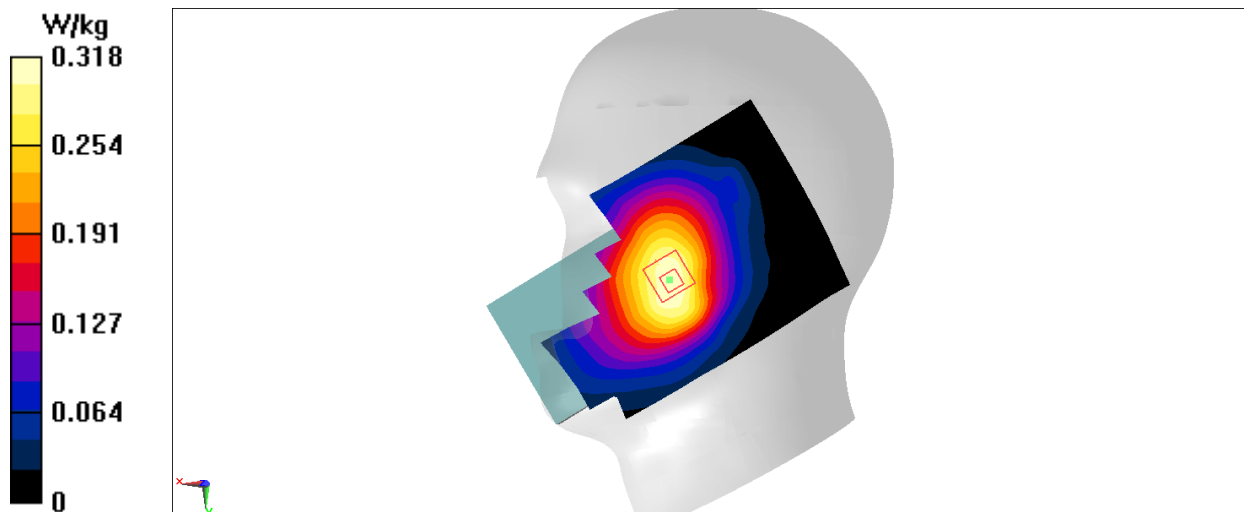


Fig A.15

**LTE850-FDD26\_CH26965 Rear**

Date: 7/13/2021

Electronics: DAE4 Sn1525

Medium: H835

Medium parameters used (interpolated):  $f = 831.5$  MHz;  $\sigma = 0.861$  S/m;  $\epsilon_r = 44.241$ ;  $\rho = 1000$  kg/m<sup>3</sup>

Ambient Temperature: 22.7°C      Liquid Temperature: 22.3°C

Communication System: LTE Band26 15M Frequency: 831.5 MHz Duty Cycle: 1:1

Probe: EX3DV4 - SN7600 ConvF(10.88, 10.88, 10.88)

Area Scan (81x131x1): Interpolated grid: dx=1.500 mm, dy=1.500 mm

Maximum value of SAR (interpolated) = 0.655 W/kg

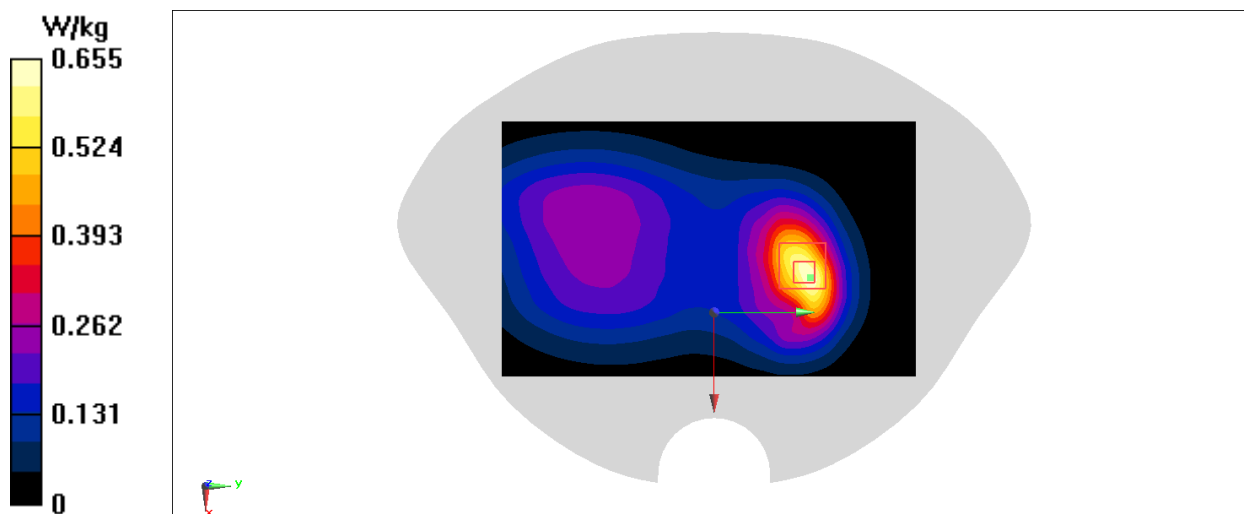
Zoom Scan (6x6x7)/Cube 0: Measurement grid: dx=8mm, dy=8mm, dz=5mm

Reference Value = 11.54 V/m; Power Drift = 0.12 dB

Peak SAR (extrapolated) = 0.845 W/kg

SAR(1 g) = 0.455 W/kg; SAR(10 g) = 0.266 W/kg

Maximum value of SAR (measured) = 0.651 W/kg



**Fig A.16**

**LTE2600-TDD41\_CH41090 Left Cheek**

Date: 7/12/2021

Electronics: DAE4 Sn1525

Medium: H2600

Medium parameters used:  $f = 2680$  MHz;  $\sigma = 2.094$  S/m;  $\epsilon_r = 39.733$ ;  $\rho = 1000$  kg/m<sup>3</sup>

Ambient Temperature: 22.8oC      Liquid Temperature: 22.6oC

Communication System: LTE Band41 Frequency: 2680 MHz Duty Cycle: 1:1.5787

Probe: EX3DV4 - SN7600 ConvF(7.67, 7.67, 7.67)

Area Scan (101x171x1): Interpolated grid: dx=1.200 mm, dy=1.200 mm

Maximum value of SAR (interpolated) = 0.333 W/kg

Zoom Scan (7x7x7)/Cube 0: Measurement grid: dx=5mm, dy=5mm, dz=5mm

Reference Value = 2.366 V/m; Power Drift = 0.07 dB

Peak SAR (extrapolated) = 0.403 W/kg

SAR(1 g) = 0.222 W/kg; SAR(10 g) = 0.116 W/kg

Maximum value of SAR (measured) = 0.336 W/kg

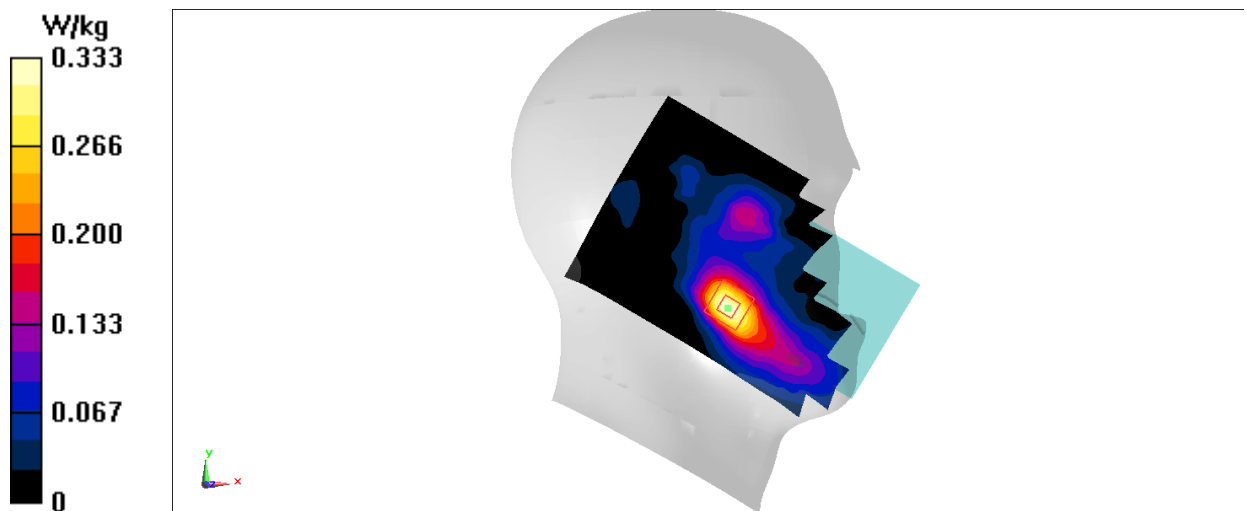


Fig A.17



**LTE2600-TDD41\_CH41490 Bottom**

Date: 7/12/2021

Electronics: DAE4 Sn1525

Medium: H2600

Medium parameters used:  $f = 2680$  MHz;  $\sigma = 2.094$  S/m;  $\epsilon_r = 39.733$ ;  $\rho = 1000$  kg/m<sup>3</sup>

Ambient Temperature: 22.8oC      Liquid Temperature: 22.6oC

Communication System: LTE Band41 Frequency: 2680 MHz Duty Cycle: 1:1.5787

Probe: EX3DV4 - SN7600 ConvF(7.67, 7.67, 7.67)

Area Scan (101x161x1): Interpolated grid: dx=1.200 mm, dy=1.200 mm

Maximum value of SAR (interpolated) = 1.05 W/kg

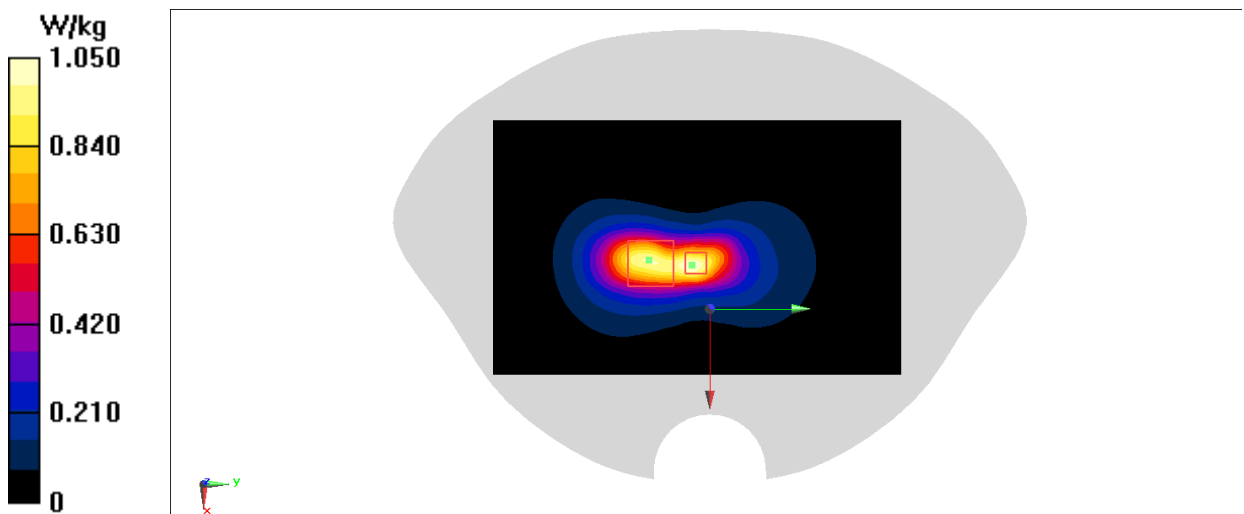
Zoom Scan (7x11x7)/Cube 0: Measurement grid: dx=5mm, dy=5mm, dz=5mm

Reference Value = 19.98 V/m; Power Drift = 0.12 dB

Peak SAR (extrapolated) = 1.42 W/kg

SAR(1 g) = 0.640 W/kg; SAR(10 g) = 0.312 W/kg

Maximum value of SAR (measured) = 1.11 W/kg



**Fig A.18**

**LTE2600-TDD41\_CH41090 Left Cheek**

Date: 7/12/2021

Electronics: DAE4 Sn1525

Medium: H2600

Medium parameters used:  $f = 2680$  MHz;  $\sigma = 2.094$  S/m;  $\epsilon_r = 39.733$ ;  $\rho = 1000$  kg/m<sup>3</sup>

Ambient Temperature: 22.8oC      Liquid Temperature: 22.6oC

Communication System: LTE Band41 Frequency: 2680 MHz Duty Cycle: 1:1.5787

Probe: EX3DV4 - SN7600 ConvF(7.67, 7.67, 7.67)

Area Scan (101x171x1): Interpolated grid: dx=1.200 mm, dy=1.200 mm

Maximum value of SAR (interpolated) = 0.441 W/kg

Zoom Scan (7x7x7)/Cube 0: Measurement grid: dx=5mm, dy=5mm, dz=5mm

Reference Value = 2.992 V/m; Power Drift = 0.17 dB

Peak SAR (extrapolated) = 0.541 W/kg

SAR(1 g) = 0.300 W/kg; SAR(10 g) = 0.157 W/kg

Maximum value of SAR (measured) = 0.453 W/kg

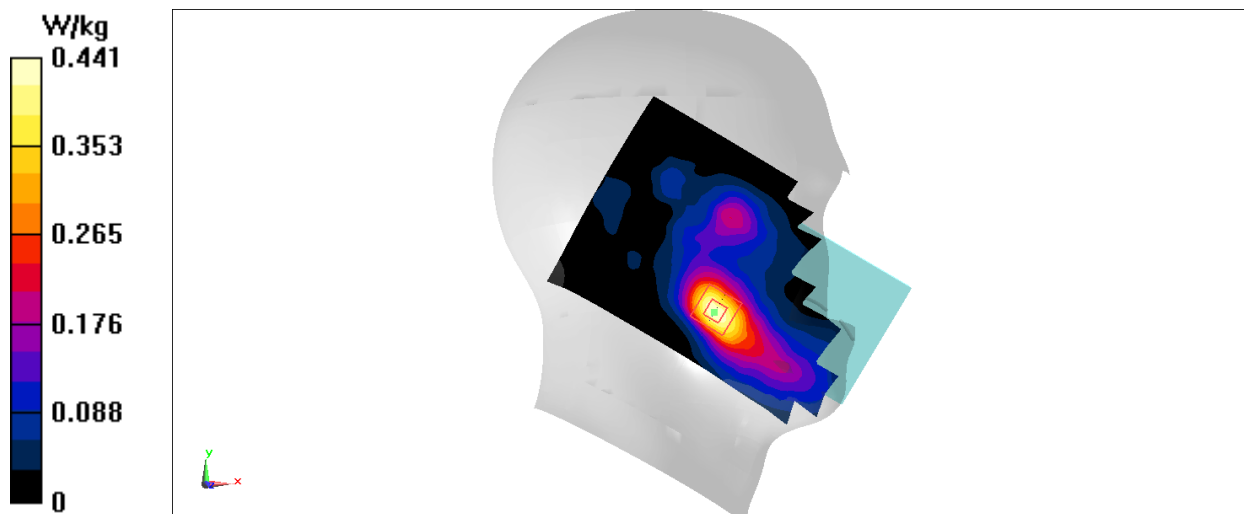


Fig A.19

**LTE2600-TDD41\_CH41490 Bottom**

Date: 7/12/2021

Electronics: DAE4 Sn1525

Medium: H2600

Medium parameters used:  $f = 2680$  MHz;  $\sigma = 2.094$  S/m;  $\epsilon_r = 39.733$ ;  $\rho = 1000$  kg/m<sup>3</sup>

Ambient Temperature: 22.8oC      Liquid Temperature: 22.6oC

Communication System: LTE Band41 Frequency: 2680 MHz Duty Cycle: 1:1.5787

Probe: EX3DV4 - SN7600 ConvF(7.67, 7.67, 7.67)

Area Scan (81x151x1): Interpolated grid: dx=1.200 mm, dy=1.200 mm

Maximum value of SAR (interpolated) = 1.79 W/kg

Zoom Scan (7x7x7)/Cube 0: Measurement grid: dx=5mm, dy=5mm, dz=5mm

Reference Value = 13.76 V/m; Power Drift = 0.03 dB

Peak SAR (extrapolated) = 2.19 W/kg

SAR(1 g) = 1.12 W/kg; SAR(10 g) = 0.563 W/kg

Maximum value of SAR (measured) = 1.78 W/kg

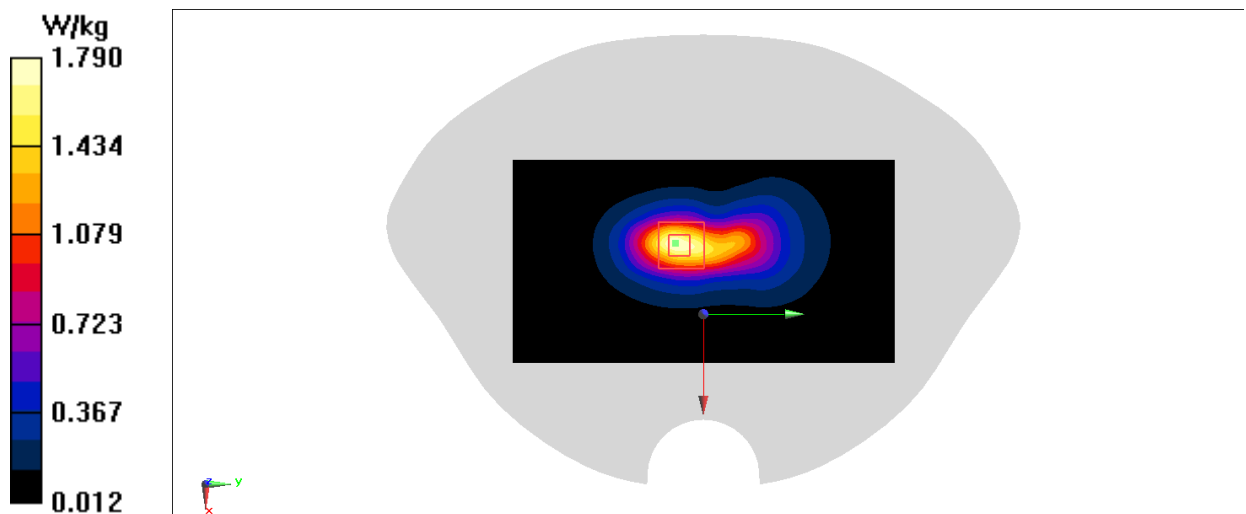


Fig A.20

**LTE1700-FDD66\_CH132572 Left Cheek**

Date: 7/15/2021

Electronics: DAE4 Sn1525

Medium: H1750

Medium parameters used:  $f = 1770$  MHz;  $\sigma = 1.388$  S/m;  $\epsilon_r = 41.544$ ;  $\rho = 1000$  kg/m<sup>3</sup>

Ambient Temperature: 22.9oC      Liquid Temperature: 22.6oC

Communication System: LTE Band66 Frequency: 1770 MHz Duty Cycle: 1:1

Probe: EX3DV4 - SN7600 ConvF(9.01, 9.01, 9.01)

Area Scan (81x141x1): Interpolated grid: dx=1.500 mm, dy=1.500 mm

Maximum value of SAR (interpolated) = 0.414 W/kg

Zoom Scan (5x5x7)/Cube 0: Measurement grid: dx=8mm, dy=8mm, dz=5mm

Reference Value = 6.954 V/m; Power Drift = -0.06 dB

Peak SAR (extrapolated) = 0.457 W/kg

SAR(1 g) = 0.307 W/kg; SAR(10 g) = 0.207 W/kg

Maximum value of SAR (measured) = 0.407 W/kg

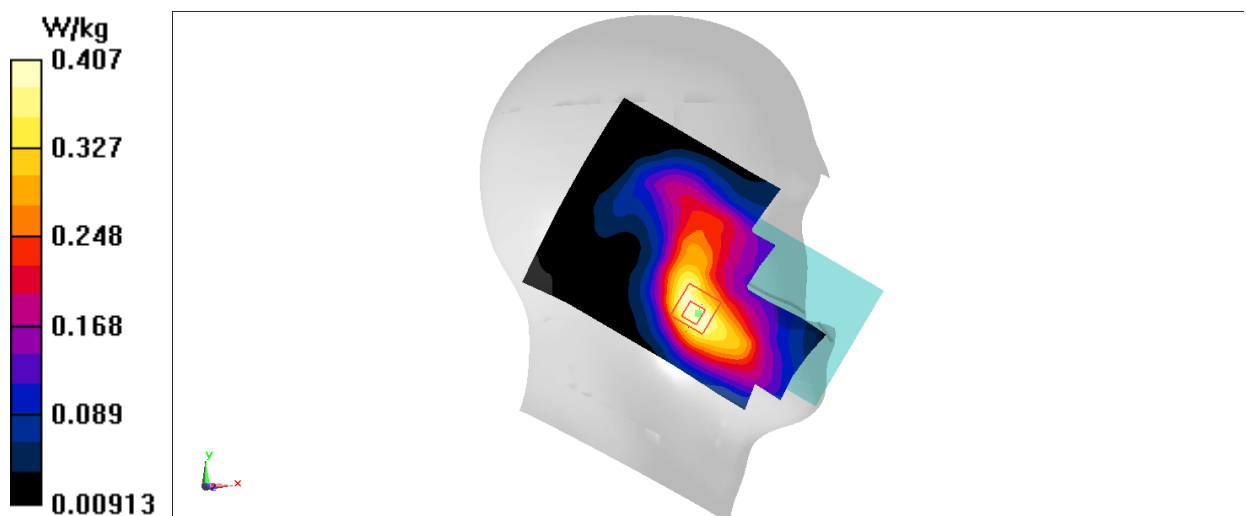


Fig A.21

**LTE1700-FDD66\_CH132572 Rear**

Date: 7/15/2021

Electronics: DAE4 Sn1525

Medium: H1750

Medium parameters used:  $f = 1770$  MHz;  $\sigma = 1.388$  S/m;  $\epsilon_r = 41.544$ ;  $\rho = 1000$  kg/m<sup>3</sup>

Ambient Temperature: 22.9oC      Liquid Temperature: 22.6oC

Communication System: LTE Band66 Frequency: 1770 MHz Duty Cycle: 1:1

Probe: EX3DV4 - SN7600 ConvF(9.01, 9.01, 9.01)

Area Scan (81x121x1): Interpolated grid: dx=1.500 mm, dy=1.500 mm

Maximum value of SAR (interpolated) = 0.897 W/kg

Zoom Scan (5x6x7)/Cube 0: Measurement grid: dx=8mm, dy=8mm, dz=5mm

Reference Value = 20.75 V/m; Power Drift = 0.12 dB

Peak SAR (extrapolated) = 1.03 W/kg

SAR(1 g) = 0.650 W/kg; SAR(10 g) = 0.426 W/kg

Maximum value of SAR (measured) = 0.882 W/kg

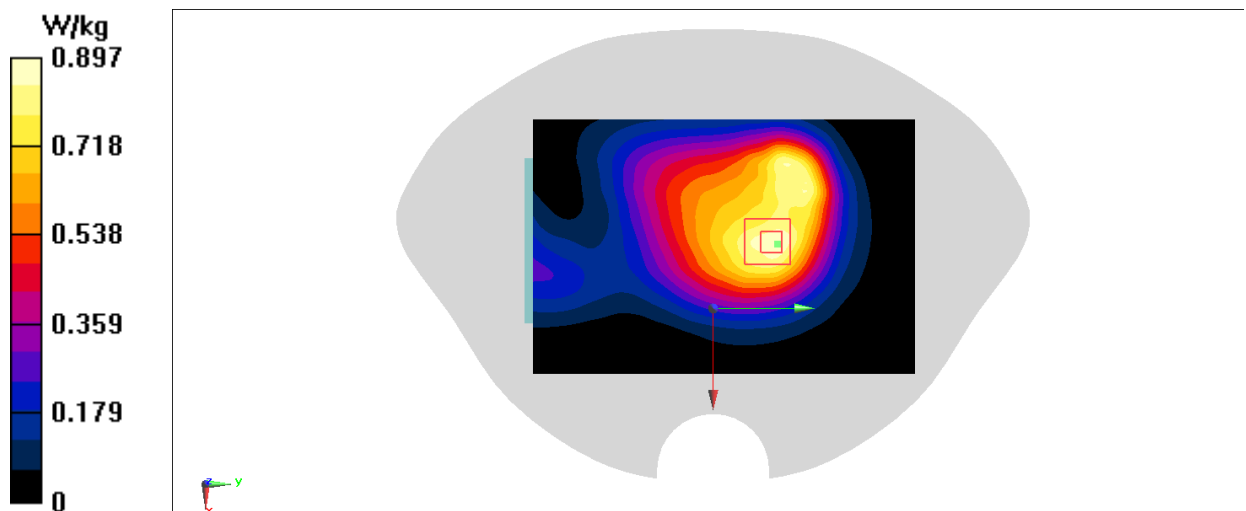


Fig A.22

**LTE700-FDD71\_CH133322 Left Cheek**

Date: 7/18/2021

Electronics: DAE4 Sn1525

Medium: H750

Medium parameters used (extrapolated):  $f = 673$  MHz;  $\sigma = 0.805$  S/m;  $\epsilon_r = 44.95$ ;  $\rho = 1000$  kg/m<sup>3</sup>

Ambient Temperature: 22.7°C      Liquid Temperature: 22.4°C

Communication System: LTE Band71 Frequency: 673 MHz Duty Cycle: 1:1

Probe: EX3DV4 - SN7600 ConvF(10.88, 10.88, 10.88)

Area Scan (81x141x1): Interpolated grid: dx=1.500 mm, dy=1.500 mm

Maximum value of SAR (interpolated) = 0.180 W/kg

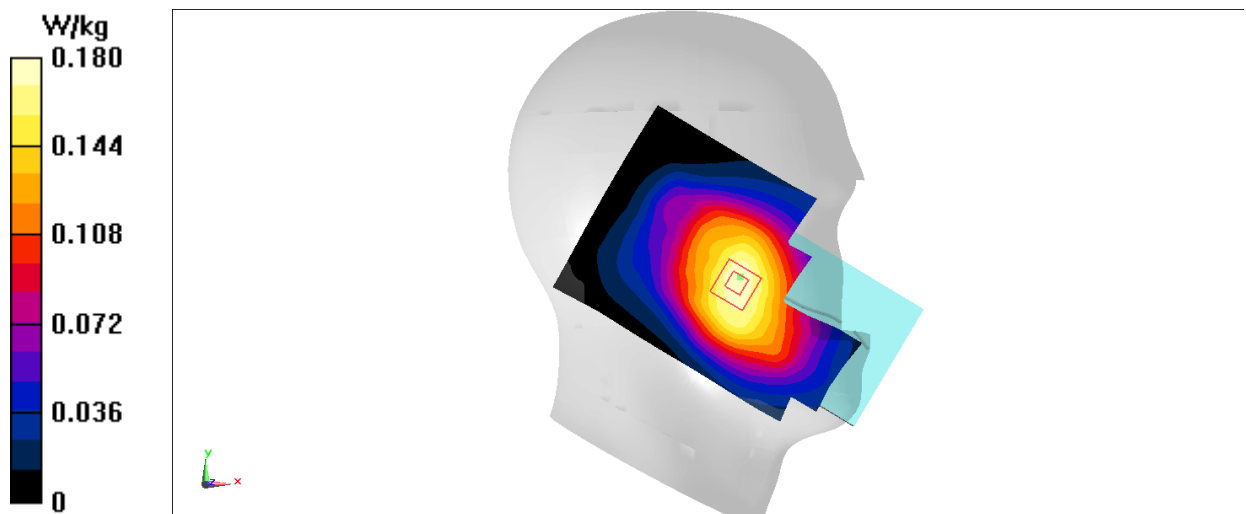
Zoom Scan (5x5x7)/Cube 0: Measurement grid: dx=8mm, dy=8mm, dz=5mm

Reference Value = 7.228 V/m; Power Drift = -0.01 dB

Peak SAR (extrapolated) = 0.194 W/kg

SAR(1 g) = 0.156 W/kg; SAR(10 g) = 0.127 W/kg

Maximum value of SAR (measured) = 0.181 W/kg

**Fig A.23**

**LTE700-FDD71\_CH133322 Right**

Date: 7/18/2021

Electronics: DAE4 Sn1525

Medium: H750

Medium parameters used (extrapolated):  $f = 673$  MHz;  $\sigma = 0.805$  S/m;  $\epsilon_r = 44.95$ ;  $\rho = 1000$  kg/m<sup>3</sup>

Ambient Temperature: 22.7°C      Liquid Temperature: 22.4°C

Communication System: LTE Band71 Frequency: 673 MHz Duty Cycle: 1:1

Probe: EX3DV4 - SN7600 ConvF(10.88, 10.88, 10.88)

Area Scan (81x121x1): Interpolated grid: dx=1.500 mm, dy=1.500 mm

Maximum value of SAR (interpolated) = 0.479 W/kg

Zoom Scan (6x13x7)/Cube 0: Measurement grid: dx=8mm, dy=8mm, dz=5mm

Reference Value = 23.03 V/m; Power Drift = 0.05 dB

Peak SAR (extrapolated) = 0.547 W/kg

SAR(1 g) = 0.364 W/kg; SAR(10 g) = 0.256 W/kg

Maximum value of SAR (measured) = 0.479 W/kg

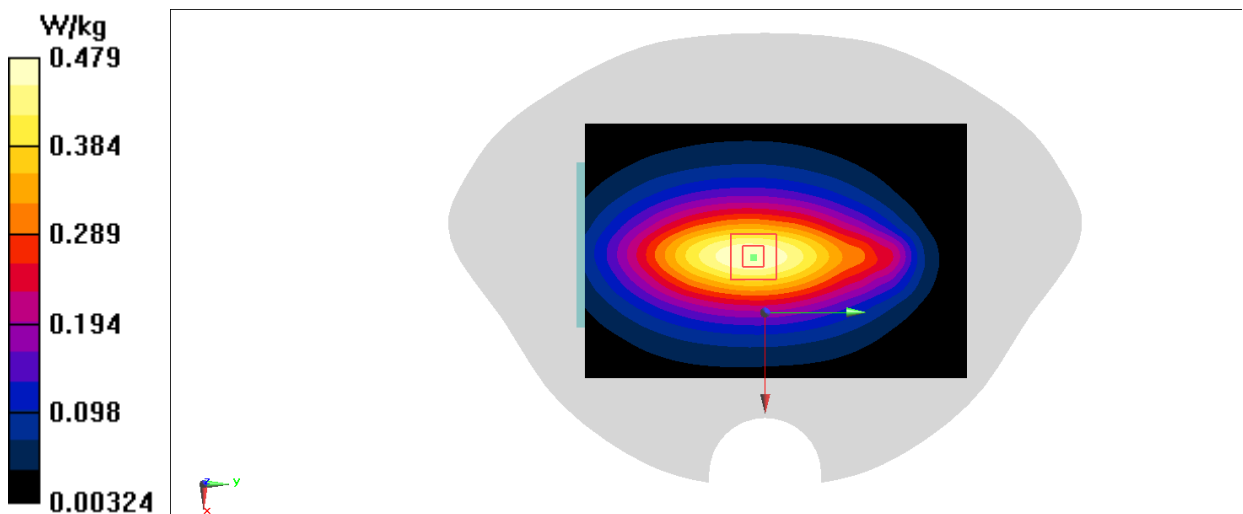


Fig A.24

**WLAN2450\_CH11 Left Tilt**

Date: 7/31/2021

Electronics: DAE4 Sn1525

Medium: H2450

Medium parameters used (interpolated):  $f = 2462$  MHz;  $\sigma = 1.875$  S/m;  $\epsilon_r = 41.568$ ;  $\rho = 1000$  kg/m<sup>3</sup>

Ambient Temperature: 22.7°C      Liquid Temperature: 22.3°C

Communication System: WIFI 2450 Frequency: 2462 MHz Duty Cycle: 1:1

Probe: EX3DV4 - SN7600 ConvF(7.79, 7.79, 7.79)

Area Scan (101x161x1): Interpolated grid: dx=1.200 mm, dy=1.200 mm

Maximum value of SAR (interpolated) = 1.38 W/kg

Zoom Scan (7x7x7)/Cube 0: Measurement grid: dx=5mm, dy=5mm, dz=5mm

Reference Value = 11.49 V/m; Power Drift = 0.15 dB

Peak SAR (extrapolated) = 1.61 W/kg

SAR(1 g) = 0.684 W/kg; SAR(10 g) = 0.305 W/kg

Maximum value of SAR (measured) = 1.15 W/kg

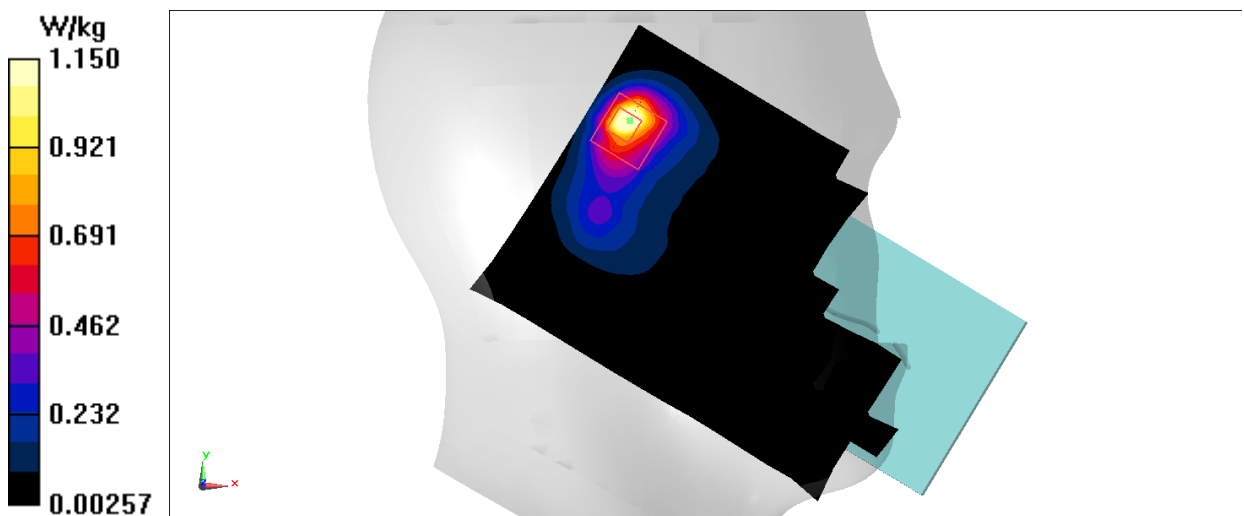


Fig A.25



**WLAN2450\_CH6 Rear**

Date: 7/31/2021

Electronics: DAE4 Sn1525

Medium: H2450

Medium parameters used (interpolated):  $f = 2437$  MHz;  $\sigma = 1.854$  S/m;  $\epsilon_r = 41.732$ ;  $\rho = 1000$  kg/m<sup>3</sup>

Ambient Temperature: 22.7°C      Liquid Temperature: 22.3°C

Communication System: WIFI 2450 Frequency: 2437 MHz Duty Cycle: 1:1

Probe: EX3DV4 - SN7600 ConvF(7.79, 7.79, 7.79)

Area Scan (81x101x1): Interpolated grid: dx=1.200 mm, dy=1.200 mm

Maximum value of SAR (interpolated) = 0.805 W/kg

Zoom Scan (7x8x7)/Cube 0: Measurement grid: dx=5mm, dy=5mm, dz=5mm

Reference Value = 10.55 V/m; Power Drift = -0.10 dB

Peak SAR (extrapolated) = 0.983 W/kg

SAR(1 g) = 0.461 W/kg; SAR(10 g) = 0.227 W/kg

Maximum value of SAR (measured) = 0.755 W/kg

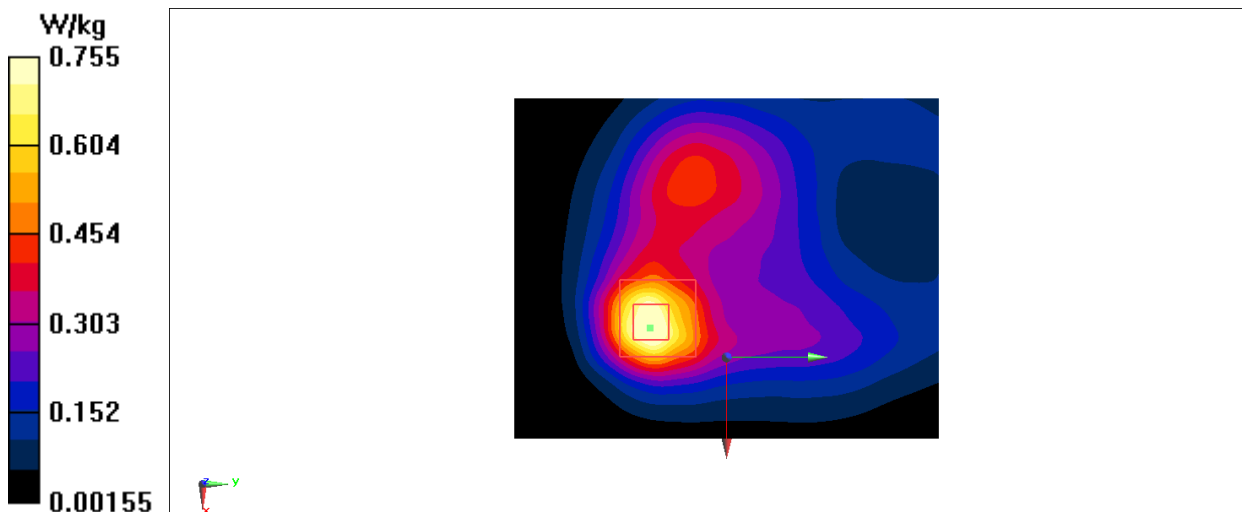


Fig A.26

**WLAN5G\_CH155 Left Cheek**

Date: 8/1/2021

Electronics: DAE4 Sn1525

Medium: H5G

Medium parameters used:  $f = 5775$  MHz;  $\sigma = 5.2$  S/m;  $\epsilon_r = 35.031$ ;  $\rho = 1000$  kg/m<sup>3</sup>

Ambient Temperature: 23.1oC      Liquid Temperature: 22.7oC

Communication System: WLAN5G Frequency: 5775 MHz Duty Cycle: 1:1

Probe: EX3DV4 - SN7600 ConvF(5.07, 5.07, 5.07)

Area Scan (121x201x1): Interpolated grid: dx=1.000 mm, dy=1.000 mm

Maximum value of SAR (interpolated) = 1.30 W/kg

Zoom Scan (7x7x7)/Cube 0: Measurement grid: dx=4mm, dy=4mm, dz=1.4mm

Reference Value = 4.568 V/m; Power Drift = 0.08 dB

Peak SAR (extrapolated) = 2.77 W/kg

SAR(1 g) = 0.606 W/kg; SAR(10 g) = 0.167 W/kg

Maximum value of SAR (measured) = 1.58 W/kg

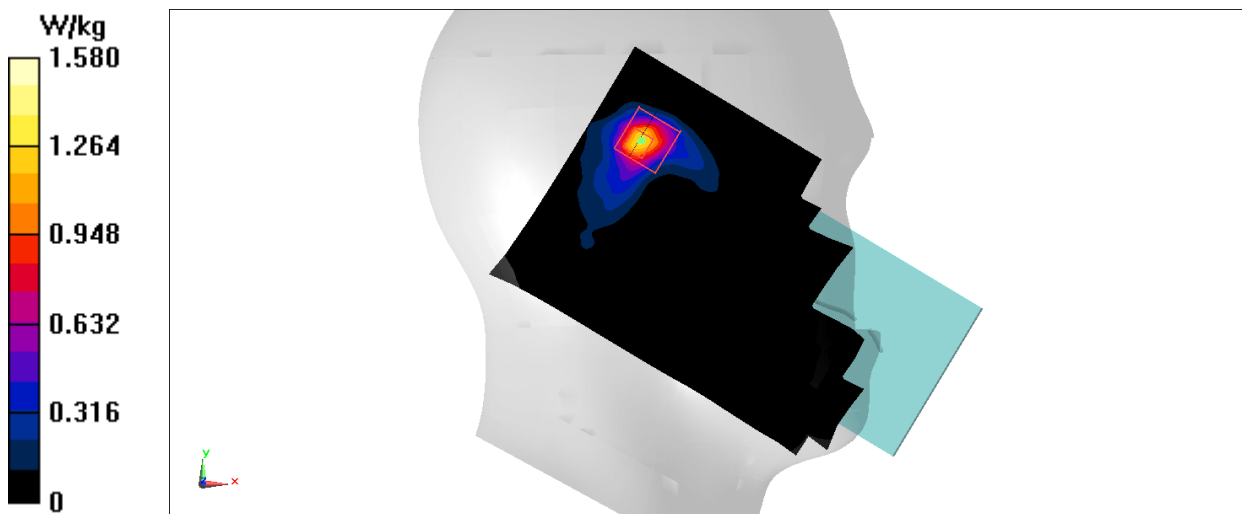


Fig A.27

**WLAN5G\_CH140 Right**

Date: 7/21/2021

Electronics: DAE4 Sn1525

Medium: H5G

Medium parameters used:  $f = 5700$  MHz;  $\sigma = 5.148$  S/m;  $\epsilon_r = 35.402$ ;  $\rho = 1000$  kg/m<sup>3</sup>

Ambient Temperature: 22.9oC      Liquid Temperature: 22.5oC

Communication System: WLAN5G Frequency: 5700 MHz Duty Cycle: 1:1

Probe: EX3DV4 - SN7600 ConvF(5.11, 5.11, 5.11)

Area Scan (101x121x1): Interpolated grid: dx=1.000 mm, dy=1.000 mm

Maximum value of SAR (interpolated) = 0.945 W/kg

Zoom Scan (9x10x7)/Cube 0: Measurement grid: dx=4mm, dy=4mm, dz=1.4mm

Reference Value = 8.365 V/m; Power Drift = 0.17 dB

Peak SAR (extrapolated) = 1.80 W/kg

SAR(1 g) = 0.410 W/kg; SAR(10 g) = 0.158 W/kg

Maximum value of SAR (measured) = 0.971 W/kg

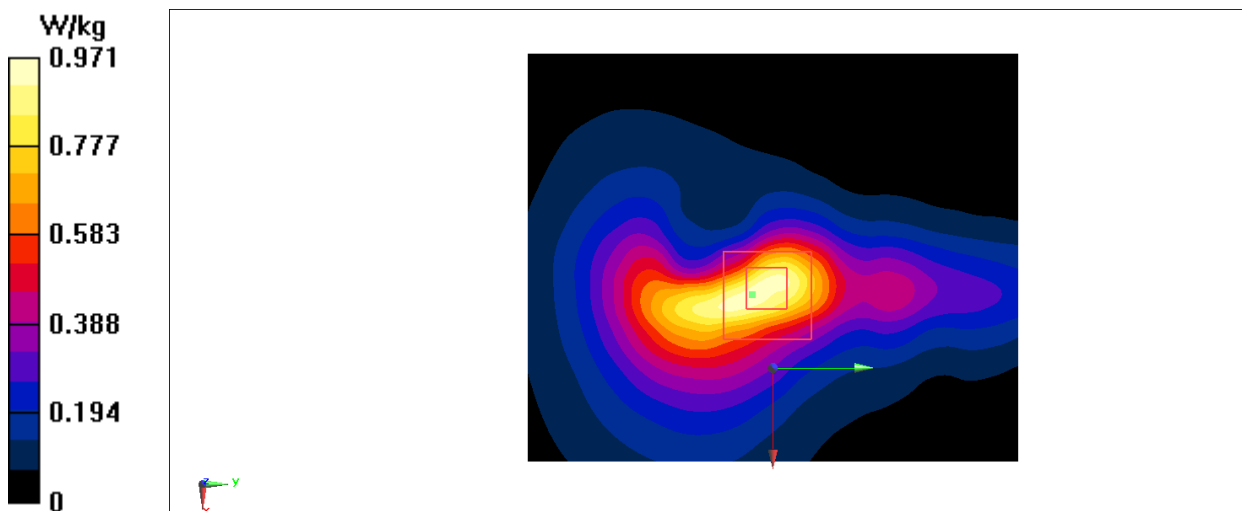
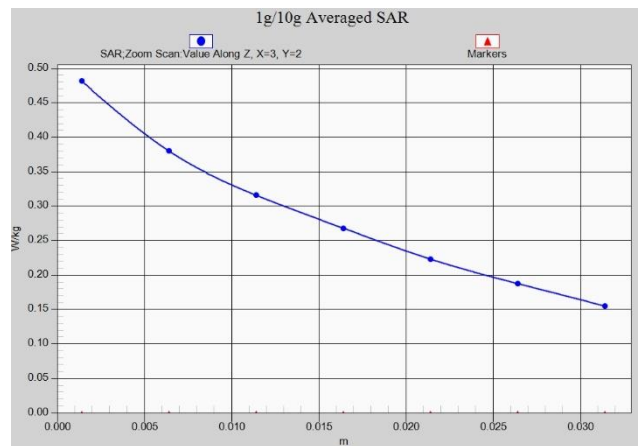
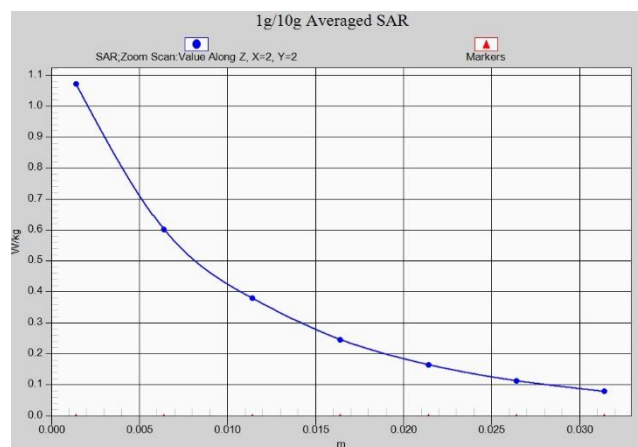


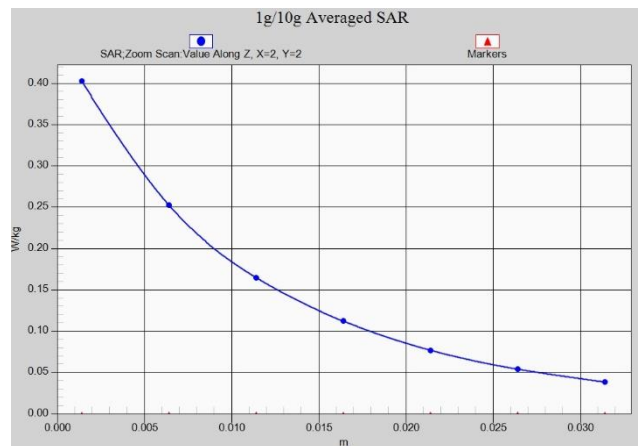
Fig A.28



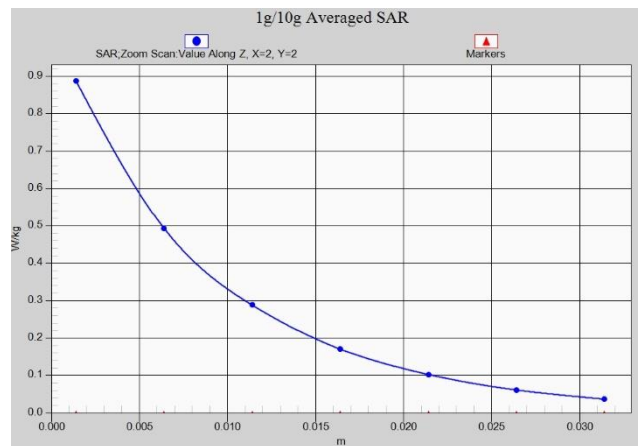
**Fig. 1-1 Z-Scan at power reference point (GSM850)**



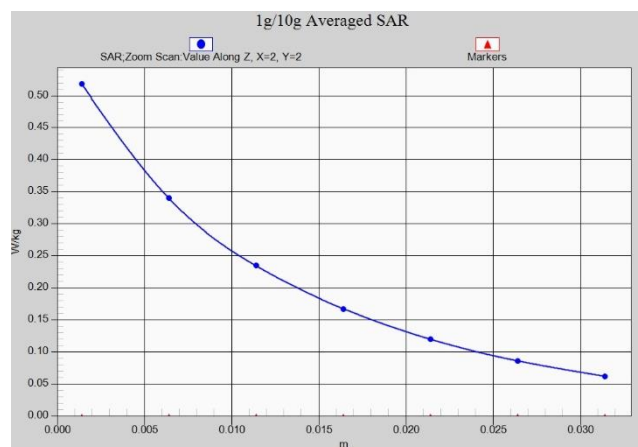
**Fig. 1-2 Z-Scan at power reference point (GSM850)**



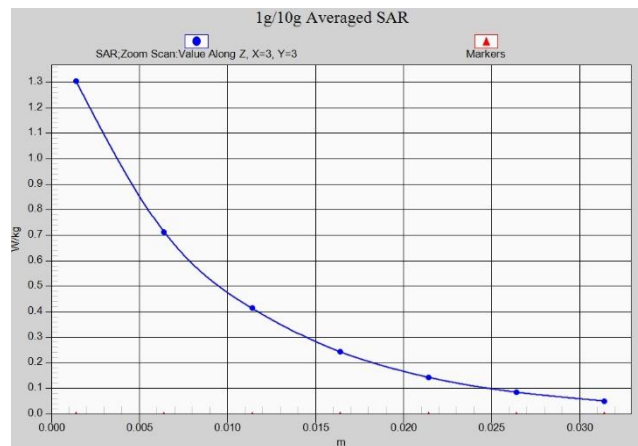
**Fig. 1-3 Z-Scan at power reference point (PCS1900)**



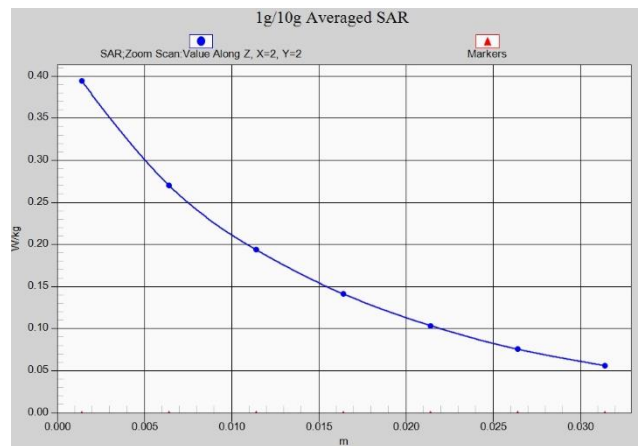
**Fig. 1-4 Z-Scan at power reference point (PCS1900)**



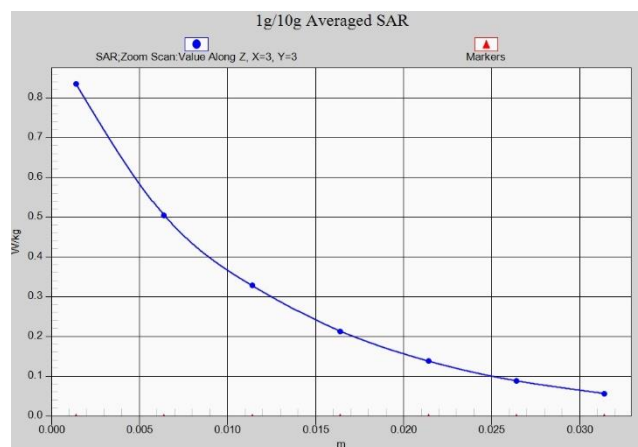
**Fig. 1-5 Z-Scan at power reference point (WCDMA1900)**



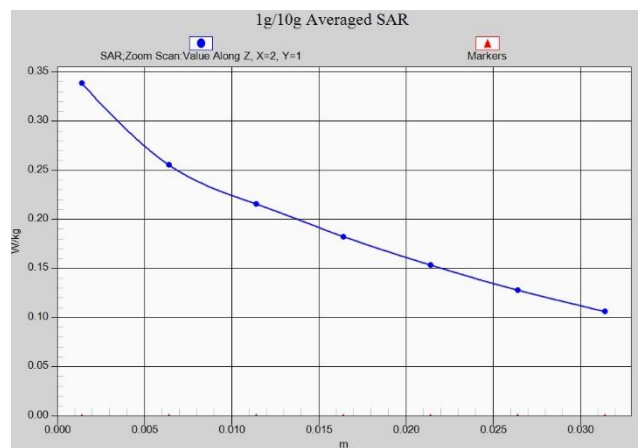
**Fig. 1-6 Z-Scan at power reference point (WCDMA1900)**



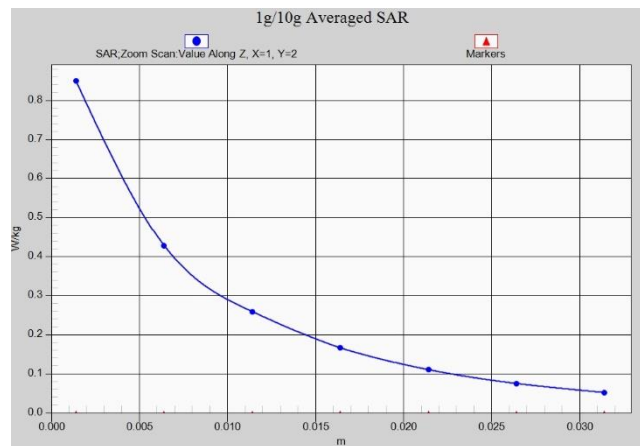
**Fig. 1-7 Z-Scan at power reference point (WCDMA1700)**



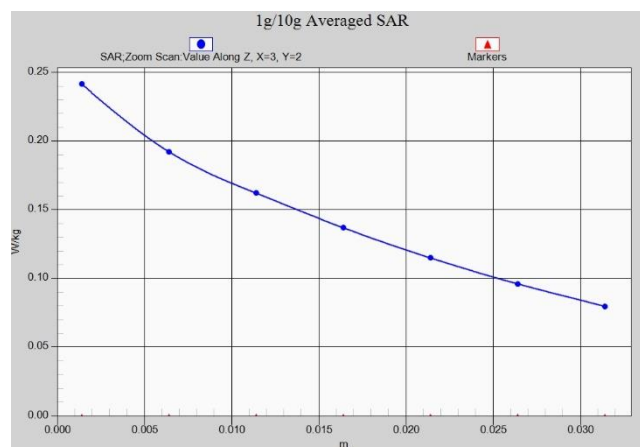
**Fig. 1-8 Z-Scan at power reference point (WCDMA1700)**



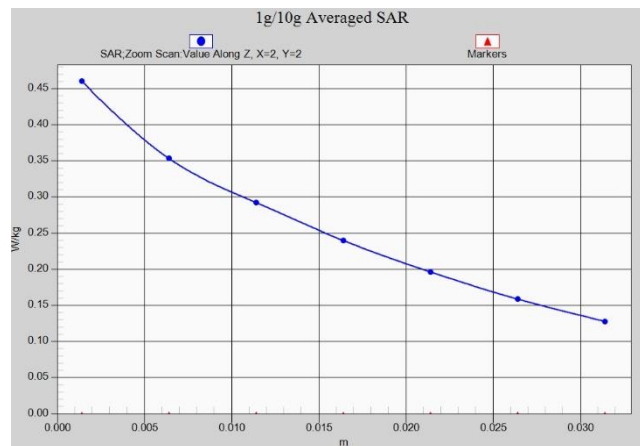
**Fig. 1-9 Z-Scan at power reference point (WCDMA850)**



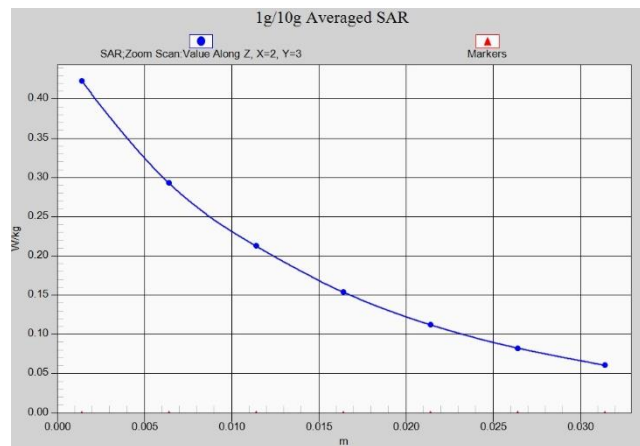
**Fig. 1-10 Z-Scan at power reference point (WCDMA850)**



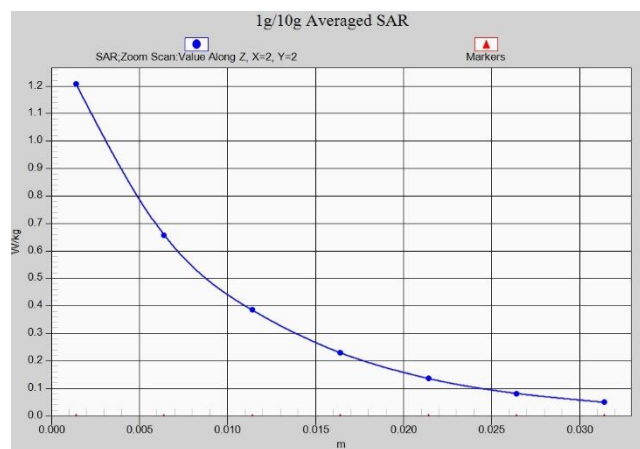
**Fig. 1-11 Z-Scan at power reference point (LTE Band12)**



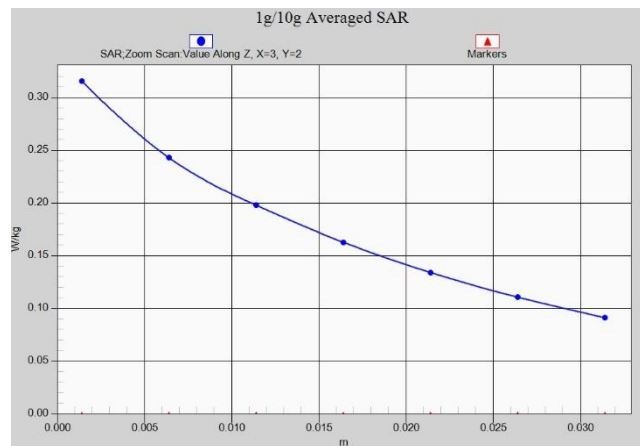
**Fig. 1-12 Z-Scan at power reference point (LTE Band12)**



**Fig. 1-13 Z-Scan at power reference point (LTE Band25)**

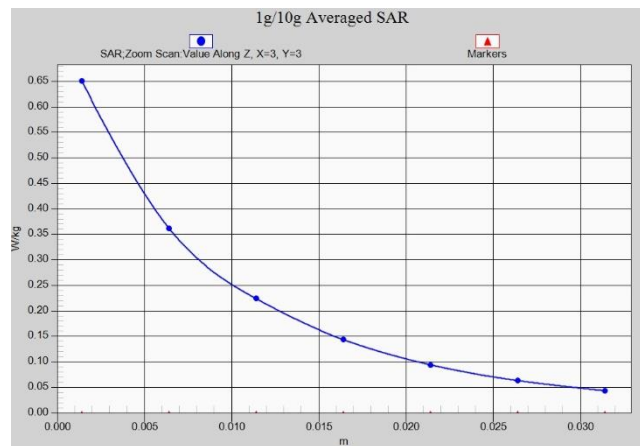


**Fig. 1-14 Z-Scan at power reference point (LTE Band25)**

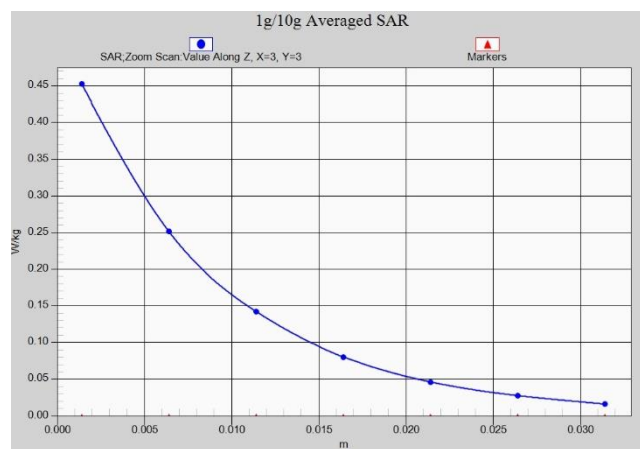


**Fig. 1-15 Z-Scan at power reference point (LTE Band26)**

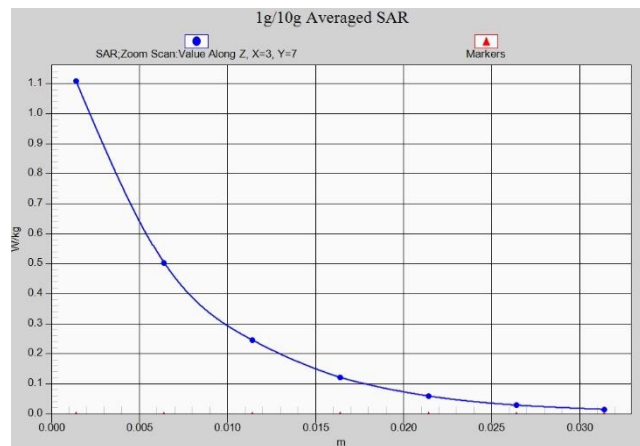




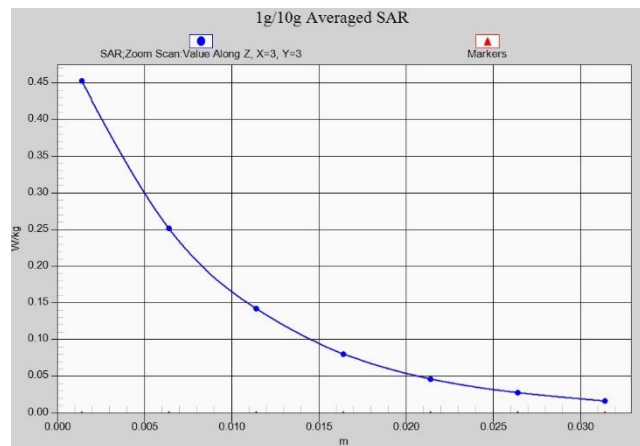
**Fig. 1-16 Z-Scan at power reference point (LTE Band26)**



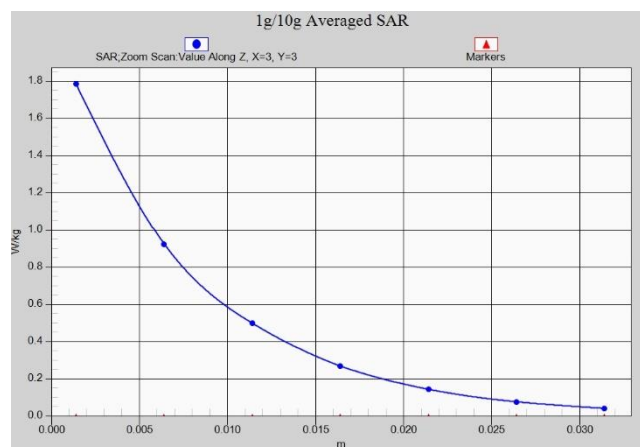
**Fig. 1-17 Z-Scan at power reference point (LTE Band41 PC3)**



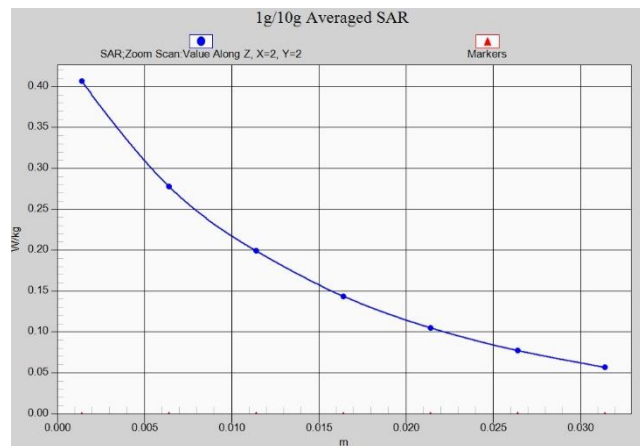
**Fig. 1-18 Z-Scan at power reference point (LTE Band41 PC3)**



**Fig. 1-19 Z-Scan at power reference point (LTE Band41 PC2)**



**Fig. 1-20 Z-Scan at power reference point (LTE Band41 PC2)**



**Fig. 1-21 Z-Scan at power reference point (LTE Band66)**

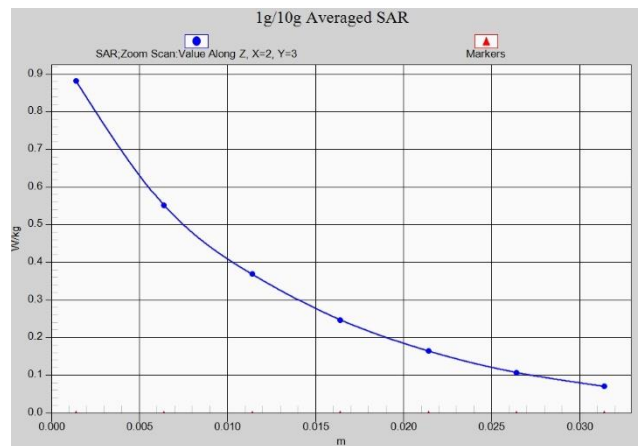


Fig. 1-22 Z-Scan at power reference point (LTE Band66)

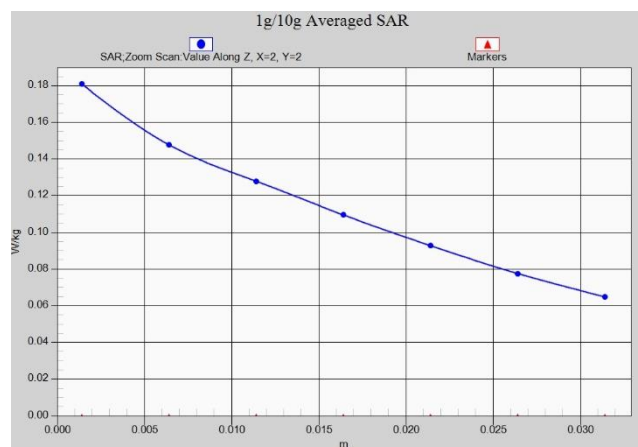


Fig. 1-23 Z-Scan at power reference point (LTE Band71)

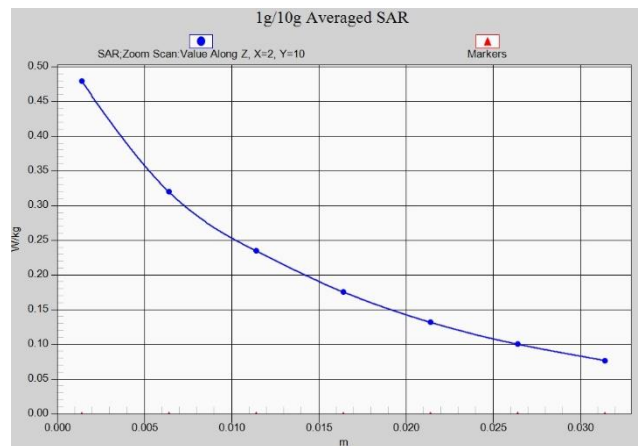
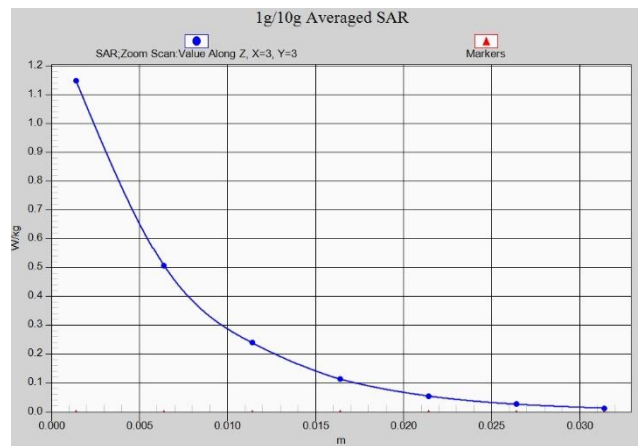
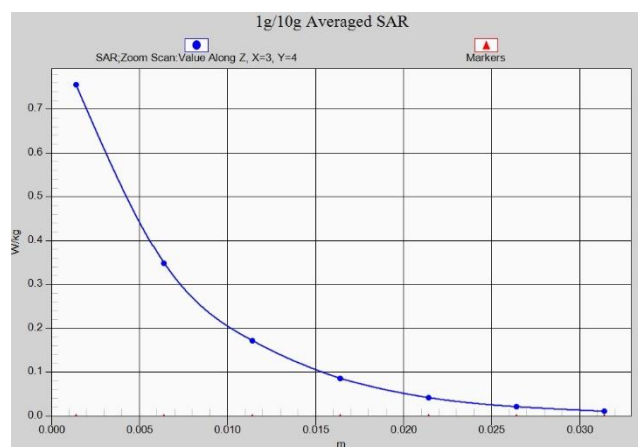


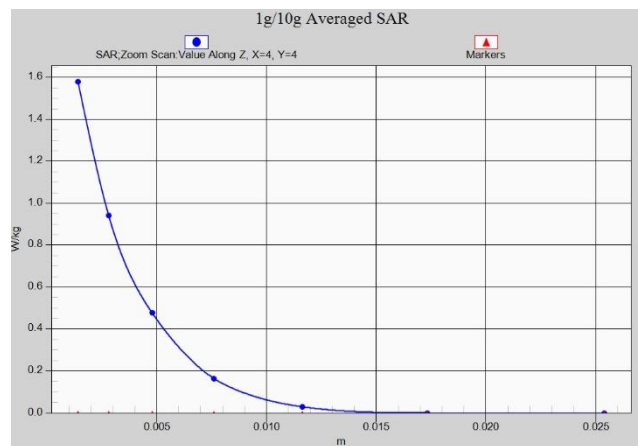
Fig. 1-24 Z-Scan at power reference point (LTE Band71)



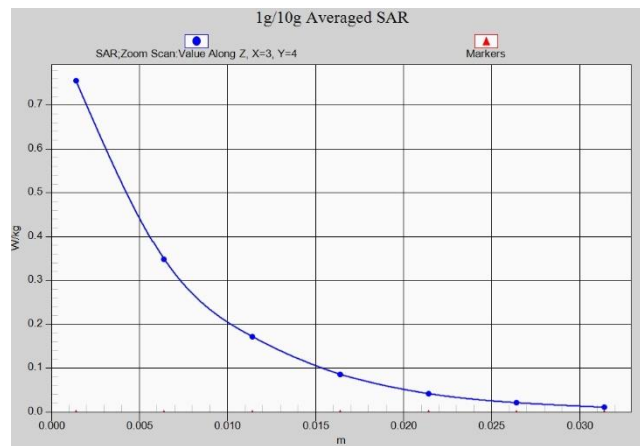
**Fig. 1-25 Z-Scan at power reference point (wifi2450)**



**Fig. 1-26 Z-Scan at power reference point (wifi2450)**



**Fig. 1-27 Z-Scan at power reference point (wifi5G)**



**Fig. 1-28 Z-Scan at power reference point (wifi5G)**

## ANNEX B System Verification Results

### 750 MHz

Date: 7/18/2021

Electronics: DAE4 Sn1525

Medium: H750

Medium parameters used:  $f = 750 \text{ MHz}$ ;  $\sigma = 0.829 \text{ S/m}$ ;  $\epsilon_r = 44.607$ ;  $\rho = 1000 \text{ kg/m}^3$

Ambient Temperature:  $22.7^\circ\text{C}$       Liquid Temperature:  $22.4^\circ\text{C}$

Communication System: CW Frequency: 750 MHz Duty Cycle: 1:1

Probe: EX3DV4 - SN7600 ConvF(10.88, 10.88, 10.88)

Area Scan (131x51x1): Interpolated grid:  $dx=1.500 \text{ mm}$ ,  $dy=1.500 \text{ mm}$

Reference Value =  $51.26 \text{ V/m}$ ; Power Drift =  $-0.11 \text{ dB}$

Fast SAR: SAR(1 g) =  $2.04 \text{ W/kg}$ ; SAR(10 g) =  $1.35 \text{ W/kg}$

Maximum value of SAR (interpolated) =  $2.64 \text{ W/kg}$

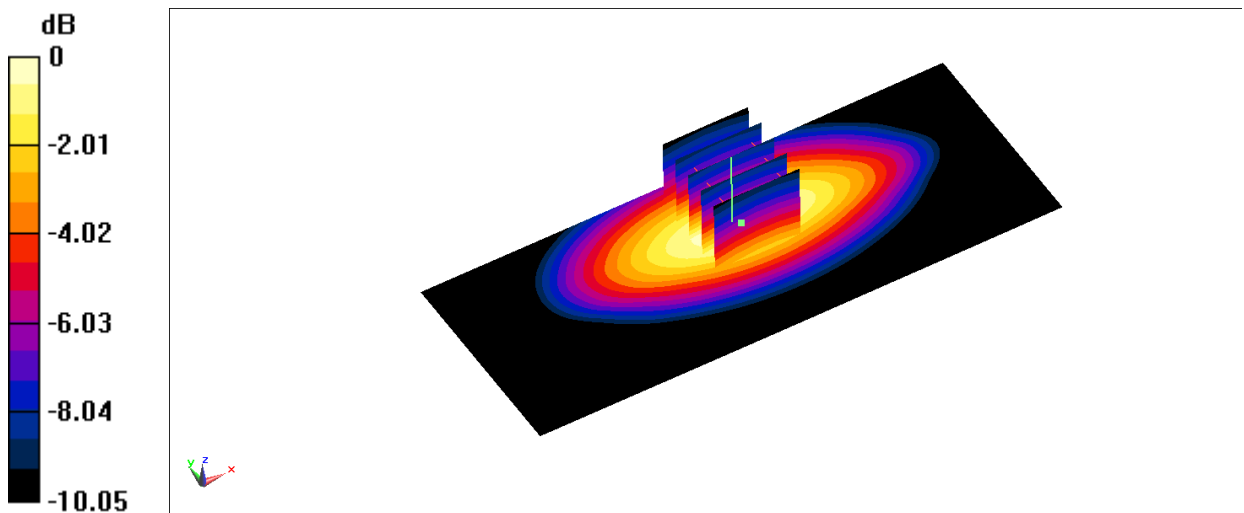
Zoom Scan (5x5x7)/Cube 0: Measurement grid:  $dx=8\text{mm}$ ,  $dy=8\text{mm}$ ,  $dz=5\text{mm}$

Reference Value =  $51.26 \text{ V/m}$ ; Power Drift =  $-0.11 \text{ dB}$

Peak SAR (extrapolated) =  $3.09 \text{ W/kg}$

SAR(1 g) =  $2.03 \text{ W/kg}$ ; SAR(10 g) =  $1.36 \text{ W/kg}$

Maximum value of SAR (measured) =  $2.71 \text{ W/kg}$



$$0 \text{ dB} = 2.71 \text{ W/kg} = 4.33 \text{ dBW/kg}$$

**Fig.B.1 validation 750 MHz 250mW**

## 835 MHz

Date: 7/13/2021

Electronics: DAE4 Sn1525

Medium: H835

Medium parameters used:  $f = 835$  MHz;  $\sigma = 0.873$  S/m;  $\epsilon_r = 44.898$ ;  $\rho = 1000$  kg/m<sup>3</sup>

Ambient Temperature: 22.7°C      Liquid Temperature: 22.3°C

Communication System: CW    Frequency: 835 MHz    Duty Cycle: 1:1

Probe: EX3DV4 - SN7600 ConvF(10.88, 10.88, 10.88)

Area Scan (131x51x1): Interpolated grid:  $dx=1.500$  mm,  $dy=1.500$  mm

Reference Value = 59.12 V/m; Power Drift = -0.12 dB

Fast SAR: SAR(1 g) = 2.38 W/kg; SAR(10 g) = 1.55 W/kg

Maximum value of SAR (interpolated) = 3.09 W/kg

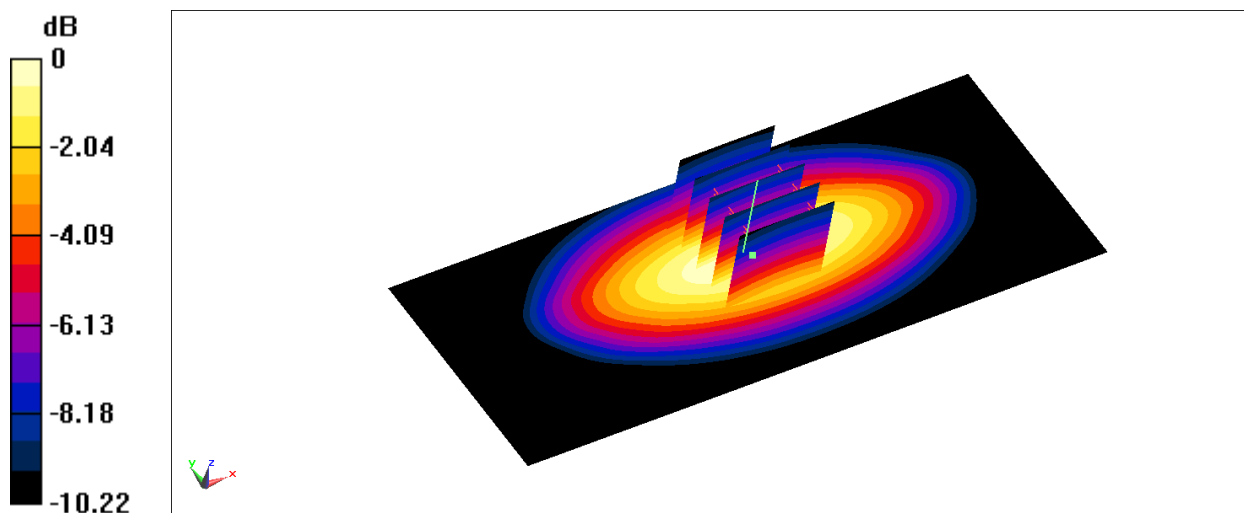
Zoom Scan (5x5x7)/Cube 0: Measurement grid:  $dx=8$ mm,  $dy=8$ mm,  $dz=5$ mm

Reference Value = 59.12 V/m; Power Drift = -0.12 dB

Peak SAR (extrapolated) = 3.48 W/kg

SAR(1 g) = 2.27 W/kg; SAR(10 g) = 1.51 W/kg

Maximum value of SAR (measured) = 3.00 W/kg



0 dB = 3.00 W/kg = 4.77 dBW/kg

**Fig.B.2 validation 835 MHz 250mW**

## 1750 MHz

Date: 7/15/2021

Electronics: DAE4 Sn1525

Medium: H1750

Medium parameters used:  $f = 1750$  MHz;  $\sigma = 1.378$  S/m;  $\epsilon_r = 41.618$ ;  $\rho = 1000$  kg/m<sup>3</sup>

Ambient Temperature: 22.9°C      Liquid Temperature: 22.6°C

Communication System: CW Frequency: 1750 MHz Duty Cycle: 1:1

Probe: EX3DV4 - SN7600 ConvF(9.01, 9.01, 9.01)

Area Scan (51x101x1): Interpolated grid: dx=1.500 mm, dy=1.500 mm

Reference Value = 98.07 V/m; Power Drift = -0.04 dB

Fast SAR: SAR(1 g) = 8.86 W/kg; SAR(10 g) = 4.68 W/kg

Maximum value of SAR (interpolated) = 13.6 W/kg

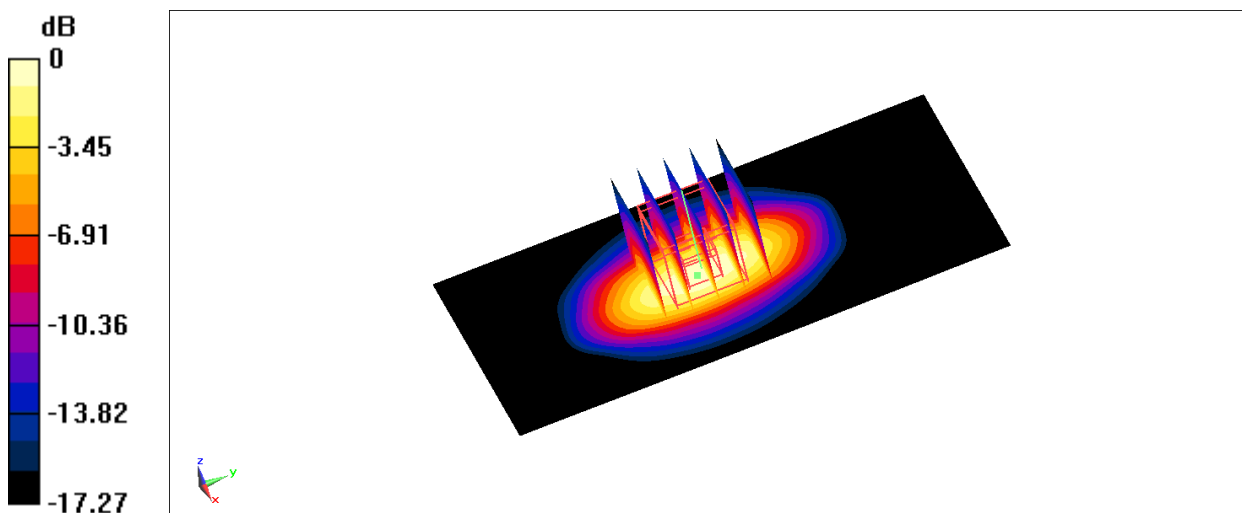
Zoom Scan (5x5x7)/Cube 0: Measurement grid: dx=8mm, dy=8mm, dz=5mm

Reference Value = 98.07 V/m; Power Drift = -0.04 dB

Peak SAR (extrapolated) = 16.3 W/kg

SAR(1 g) = 8.89 W/kg; SAR(10 g) = 4.73 W/kg

Maximum value of SAR (measured) = 13.3 W/kg



$$0 \text{ dB} = 13.3 \text{ W/kg} = 11.24 \text{ dBW/kg}$$

**Fig.B.3 validation 1750 MHz 250mW**



## 1900 MHz

Date: 7/17/2021

Electronics: DAE4 Sn1525

Medium: H1900

Medium parameters used:  $f = 1900$  MHz;  $\sigma = 1.459$  S/m;  $\epsilon_r = 41.353$ ;  $\rho = 1000$  kg/m<sup>3</sup>

Ambient Temperature: 22.5°C      Liquid Temperature: 22.4°C

Communication System: CW Frequency: 1900 MHz Duty Cycle: 1:1

Probe: EX3DV4 - SN7600 ConvF(8.7, 8.7, 8.7)

Area Scan (51x81x1): Interpolated grid: dx=1.500 mm, dy=1.500 mm

Reference Value = 103.2 V/m; Power Drift = -0.11 dB

Fast SAR: SAR(1 g) = 10 W/kg; SAR(10 g) = 5.09 W/kg

Maximum value of SAR (interpolated) = 15.6 W/kg

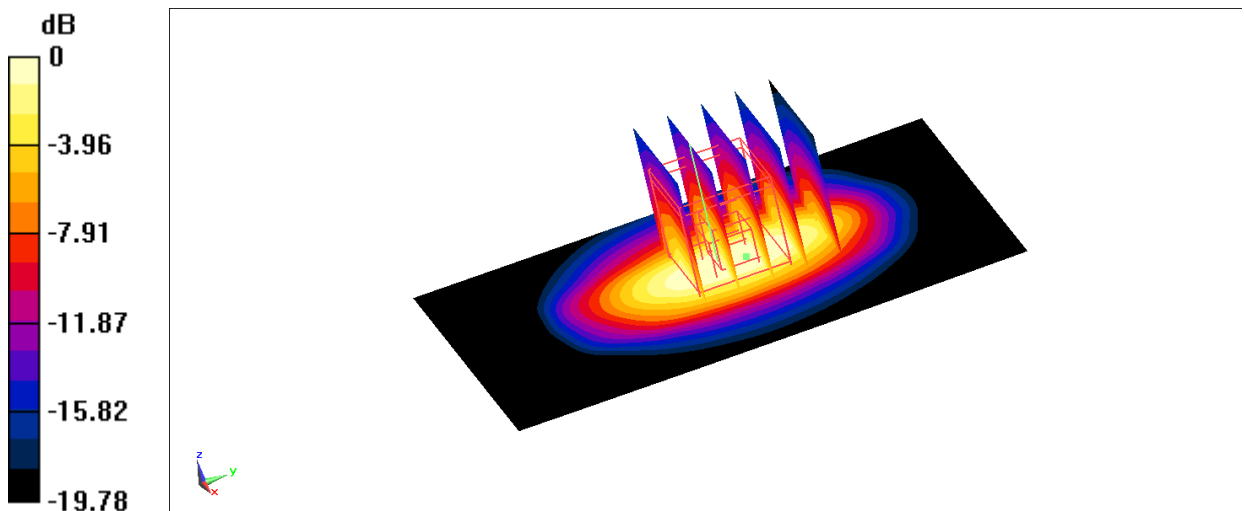
Zoom Scan (5x5x7)/Cube 0: Measurement grid: dx=8mm, dy=8mm, dz=5mm

Reference Value = 103.2 V/m; Power Drift = -0.11 dB

Peak SAR (extrapolated) = 17.7 W/kg

SAR(1 g) = 9.51 W/kg; SAR(10 g) = 4.95 W/kg

Maximum value of SAR (measured) = 14.1 W/kg



$$0 \text{ dB} = 14.1 \text{ W/kg} = 11.49 \text{ dBW/kg}$$

**Fig.B.4 validation 1900 MHz 250mW**

## 2450 MHz

Date: 7/31/2021

Electronics: DAE4 Sn1525

Medium: H2450

Medium parameters used:  $f = 2450$  MHz;  $\sigma = 1.865$  S/m;  $\epsilon_r = 41.587$ ;  $\rho = 1000$  kg/m<sup>3</sup>

Ambient Temperature: 22.7°C      Liquid Temperature: 22.3°C

Communication System: CW Frequency: 2450 MHz Duty Cycle: 1:1

Probe: EX3DV4 - SN7600 ConvF(7.79, 7.79, 7.79)

Area Scan (61x121x1): Interpolated grid:  $dx=1.200$  mm,  $dy=1.200$  mm

Reference Value = 101.7 V/m; Power Drift = 0.12 dB

Fast SAR: SAR(1 g) = 11.9 W/kg; SAR(10 g) = 5.72 W/kg

Maximum value of SAR (interpolated) = 19.7 W/kg

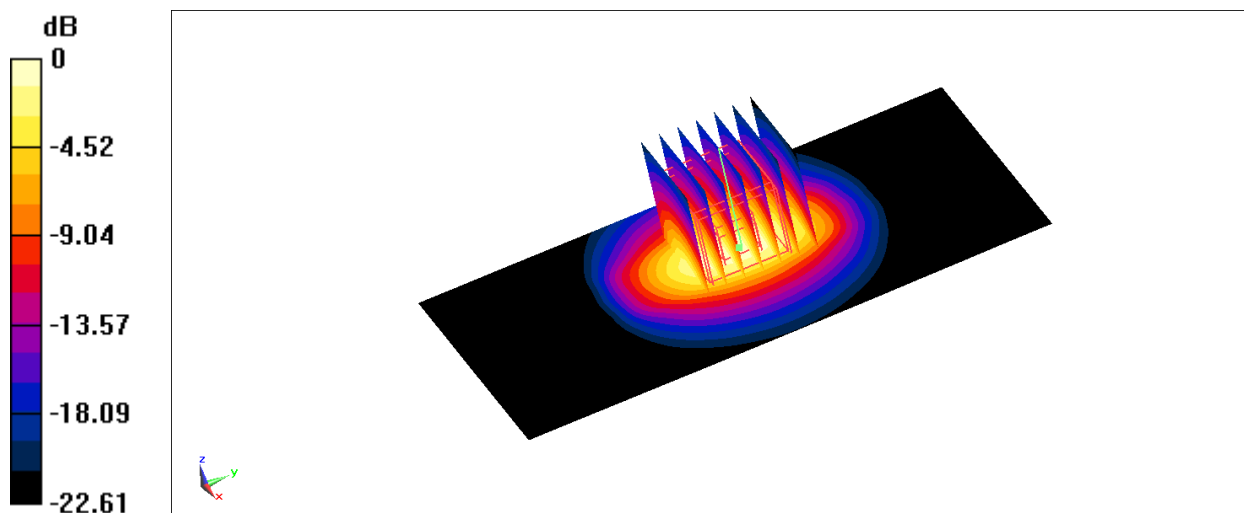
Zoom Scan (7x7x7)/Cube 0: Measurement grid:  $dx=5$ mm,  $dy=5$ mm,  $dz=5$ mm

Reference Value = 101.7 V/m; Power Drift = 0.12 dB

Peak SAR (extrapolated) = 25.7 W/kg

SAR(1 g) = 12.5 W/kg; SAR(10 g) = 5.84 W/kg

Maximum value of SAR (measured) = 20.5 W/kg



$$0 \text{ dB} = 20.5 \text{ W/kg} = 13.12 \text{ dBW/kg}$$

**Fig.B.5 validation 2450 MHz 250Mw**

## 2600 MHz

Date: 7/12/2021

Electronics: DAE4 Sn1525

Medium: H2600

Medium parameters used:  $f = 2600$  MHz;  $\sigma = 2.035$  S/m;  $\epsilon_r = 39.958$ ;  $\rho = 1000$  kg/m<sup>3</sup>

Ambient Temperature: 22.8oC      Liquid Temperature: 22.6oC

Communication System: CW Frequency: 2600 MHz Duty Cycle: 1:1

Probe: EX3DV4 - SN7600 ConvF(7.67, 7.67, 7.67)

Area Scan (61x121x1): Interpolated grid: dx=1.200 mm, dy=1.200 mm

Reference Value = 112.1 V/m; Power Drift = -0.11 dB

Fast SAR: SAR(1 g) = 14.3 W/kg; SAR(10 g) = 6.36 W/kg

Maximum value of SAR (interpolated) = 24.4 W/kg

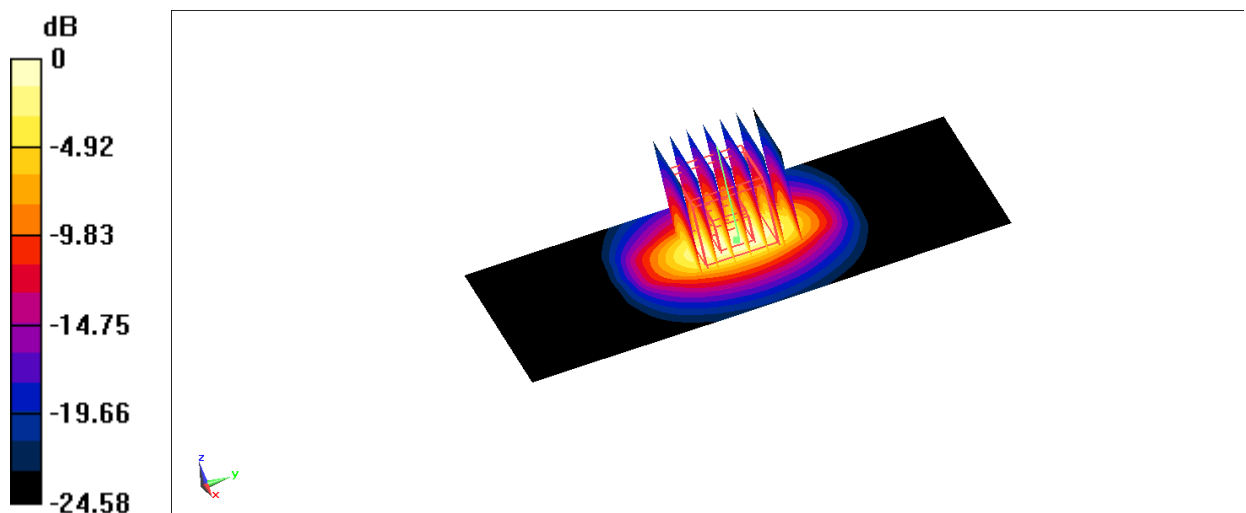
Zoom Scan (7x7x7)/Cube 0: Measurement grid: dx=5mm, dy=5mm, dz=5mm

Reference Value = 112.1 V/m; Power Drift = -0.11 dB

Peak SAR (extrapolated) = 30.6 W/kg

SAR(1 g) = 13.9 W/kg; SAR(10 g) = 6.18 W/kg

Maximum value of SAR (measured) = 23.7 W/kg



0 dB = 23.7 W/kg = 13.75 dBW/kg

**Fig.B.6 validation 2600 MHz 250mW**

## 5250 MHz

Date: 8/1/2021

Electronics: DAE4 Sn1525

Medium: H5G

Medium parameters used:  $f = 5250$  MHz;  $\sigma = 4.622$  S/m;  $\epsilon_r = 35.684$ ;  $\rho = 1000$  kg/m<sup>3</sup>

Ambient Temperature: 23.1°C      Liquid Temperature: 22.7°C

Communication System: CW Frequency: 5250 MHz Duty Cycle: 1:1

Probe: EX3DV4 - SN7600 ConvF(5.68, 5.68, 5.68)

Area Scan (101x101x1): Interpolated grid:  $dx=1.000$  mm,  $dy=1.000$  mm

Maximum value of SAR (interpolated) = 18.9 W/kg

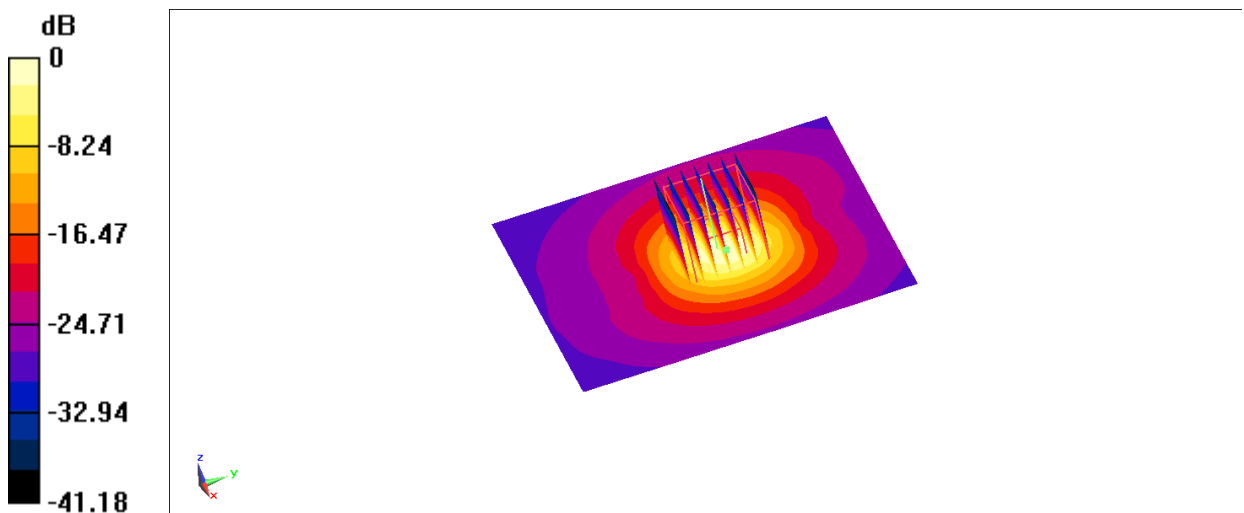
Zoom Scan (4x4x1.4mm, graded),  $dist=1.4$ mm (7x7x7)/Cube 0: Measurement grid:  
 $dx=4$ mm,  $dy=4$ mm,  $dz=1.4$ mm

Reference Value = 57.66 V/m; Power Drift = -0.17 dB

Peak SAR (extrapolated) = 31.3 W/kg

SAR(1 g) = 7.48 W/kg; SAR(10 g) = 2.14 W/kg

Maximum value of SAR (measured) = 17.5 W/kg



0 dB = 17.5 W/kg = 12.43 dBW/kg

**Fig.B.7 validation 5250 MHz 100mW**

## 5600 MHz

Date: 7/21/2021

Electronics: DAE4 Sn1525

Medium: H5G

Medium parameters used:  $f = 5600$  MHz;  $\sigma = 5.037$  S/m;  $\epsilon_r = 35.571$ ;  $\rho = 1000$  kg/m<sup>3</sup>

Ambient Temperature: 22.9°C      Liquid Temperature: 22.5°C

Communication System: CW Frequency: 5600 MHz Duty Cycle: 1:1

Probe: EX3DV4 - SN7600 ConvF(5.11, 5.11, 5.11)

Area Scan (101x101x1): Interpolated grid: dx=1.000 mm, dy=1.000 mm

Maximum value of SAR (interpolated) = 19.5 W/kg

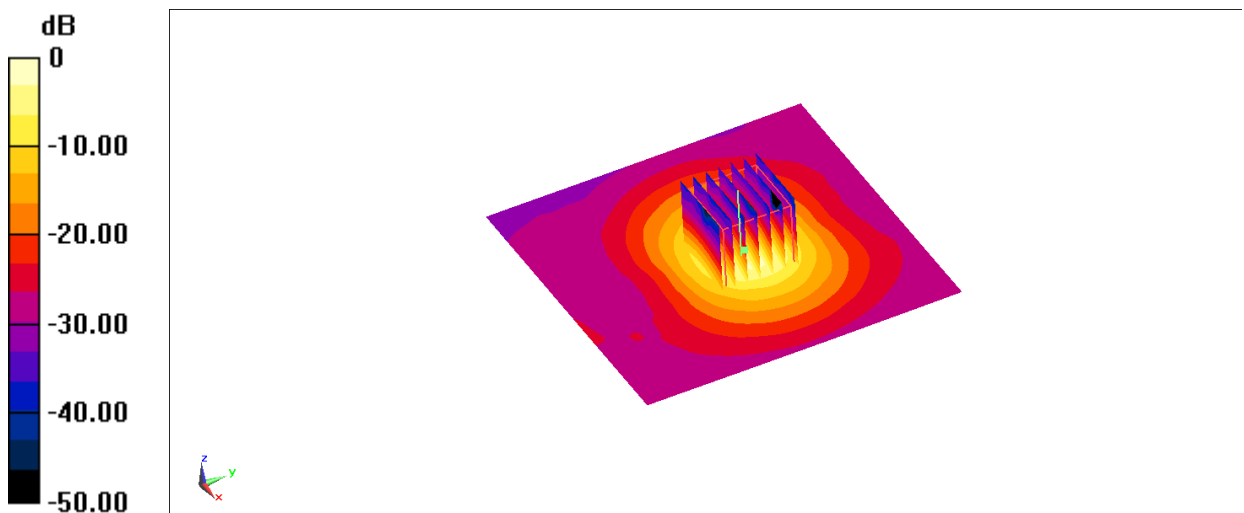
Zoom Scan (4x4x1.4mm, graded), dist=1.4mm (7x7x7)/Cube 0: Measurement grid:  
dx=4mm, dy=4mm, dz=1.4mm

Reference Value = 56.17 V/m; Power Drift = -0.15 dB

Peak SAR (extrapolated) = 34.9 W/kg

SAR(1 g) = 7.78 W/kg; SAR(10 g) = 2.3 W/kg

Maximum value of SAR (measured) = 18.9 W/kg



0 dB = 18.9 W/kg = 12.76 dBW/kg

**Fig.B.8 validation 5600 MHz 100mW**

## 5600 MHz

Date: 8/1/2021

Electronics: DAE4 Sn1525

Medium: H5G

Medium parameters used:  $f = 5600$  MHz;  $\sigma = 5.115$  S/m;  $\epsilon_r = 35.125$ ;  $\rho = 1000$  kg/m<sup>3</sup>

Ambient Temperature: 23.1°C      Liquid Temperature: 22.7°C

Communication System: CW Frequency: 5600 MHz Duty Cycle: 1:1

Probe: EX3DV4 - SN7600 ConvF(5.11, 5.11, 5.11)

Area Scan (101x101x1): Interpolated grid:  $dx=1.000$  mm,  $dy=1.000$  mm

Maximum value of SAR (interpolated) = 19.7 W/kg

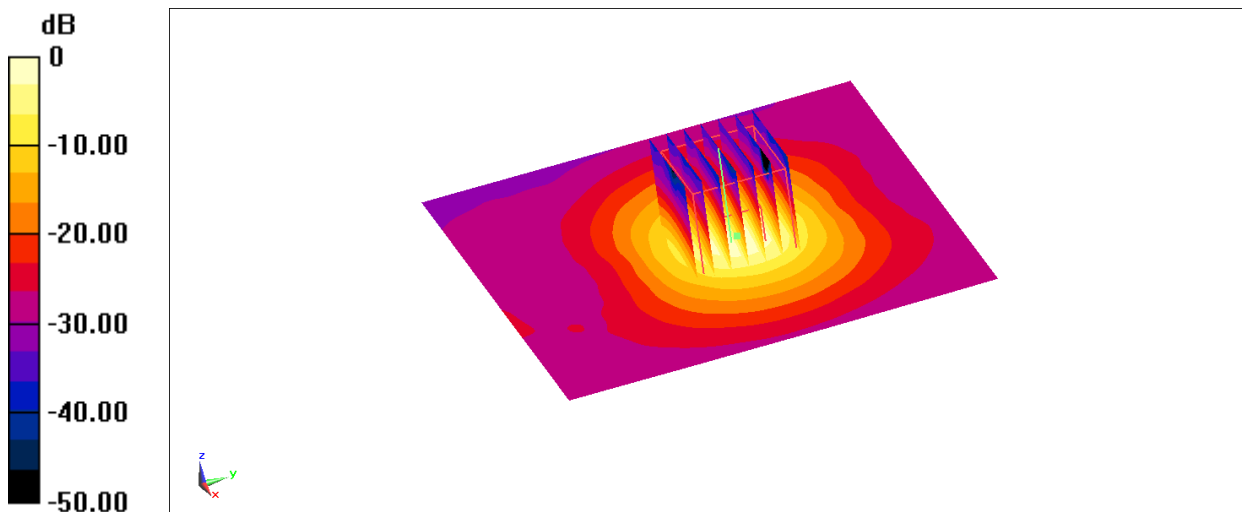
Zoom Scan (4x4x1.4mm, graded),  $dist=1.4$ mm (7x7x7)/Cube 0: Measurement grid:  
 $dx=4$ mm,  $dy=4$ mm,  $dz=1.4$ mm

Reference Value = 55.87 V/m; Power Drift = -0.15 dB

Peak SAR (extrapolated) = 35.4 W/kg

SAR(1 g) = 7.8 W/kg; SAR(10 g) = 2.24 W/kg

Maximum value of SAR (measured) = 19.2 W/kg



0 dB = 19.2 W/kg = 12.83 dBW/kg

**Fig.B.9 validation 5600 MHz 100mW**

## 5750 MHz

Date: 7/21/2021

Electronics: DAE4 Sn1525

Medium: H5G

Medium parameters used:  $f = 5750$  MHz;  $\sigma = 5.214$  S/m;  $\epsilon_r = 35.289$ ;  $\rho = 1000$  kg/m<sup>3</sup>

Ambient Temperature: 22.9°C      Liquid Temperature: 22.5°C

Communication System: CW Frequency: 5750 MHz Duty Cycle: 1:1

Probe: EX3DV4 - SN7600 ConvF(5.07, 5.07, 5.07)

Area Scan (101x101x1): Interpolated grid: dx=1.000 mm, dy=1.000 mm

Maximum value of SAR (interpolated) = 19.5 W/kg

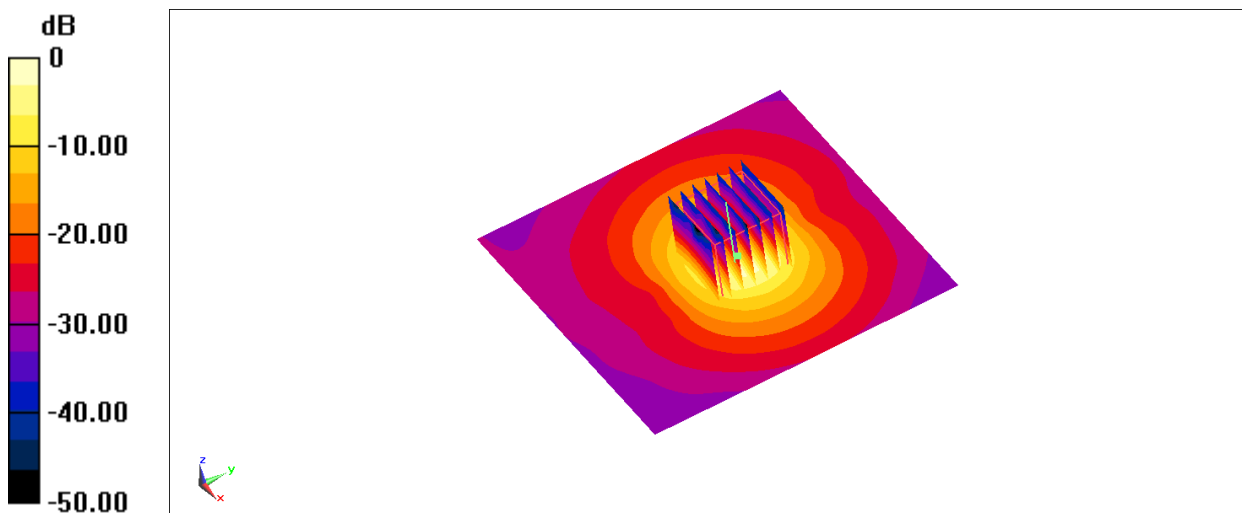
Zoom Scan (4x4x1.4mm, graded), dist=1.4mm (7x7x7)/Cube 0: Measurement grid:  
dx=4mm, dy=4mm, dz=1.4mm

Reference Value = 55.14 V/m; Power Drift = 0.12 dB

Peak SAR (extrapolated) = 34.6 W/kg

SAR(1 g) = 7.41 W/kg; SAR(10 g) = 2.12 W/kg

Maximum value of SAR (measured) = 18.4 W/kg



0 dB = 18.4 W/kg = 12.65 dBW/kg

**Fig.B.10 validation 5750 MHz 100mW**

## 5750 MHz

Date: 8/1/2021

Electronics: DAE4 Sn1525

Medium: H5G

Medium parameters used:  $f = 5750$  MHz;  $\sigma = 5.236$  S/m;  $\epsilon_r = 35.094$ ;  $\rho = 1000$  kg/m<sup>3</sup>

Ambient Temperature: 23.1oC      Liquid Temperature: 22.5oC

Communication System: CW    Frequency: 5750 MHz Duty Cycle: 1:1

Probe: EX3DV4 - SN7600 ConvF(5.07, 5.07, 5.07)

Area Scan (101x101x1): Interpolated grid: dx=1.000 mm, dy=1.000 mm

Maximum value of SAR (interpolated) = 19.6 W/kg

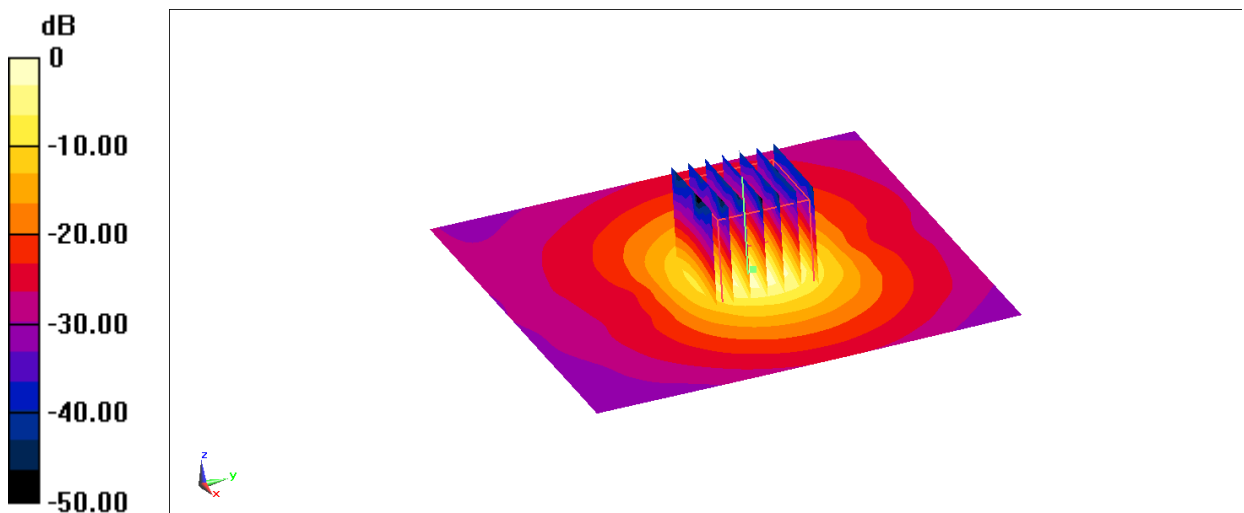
Zoom Scan (4x4x1.4mm, graded), dist=1.4mm (7x7x7)/Cube 0: Measurement grid:  
dx=4mm, dy=4mm, dz=1.4mm

Reference Value = 54.01 V/m; Power Drift = -0.05 dB

Peak SAR (extrapolated) = 34.7 W/kg

SAR(1 g) = 7.45 W/kg; SAR(10 g) = 2.13 W/kg

Maximum value of SAR (measured) = 18.5 W/kg



0 dB = 18.5 W/kg = 12.67 dBW/kg

**Fig.B.11 validation 5750 MHz 100mW**





The SAR system verification must be required that the area scan estimated 1-g SAR is within 3% of the zoom scan 1-g SAR.

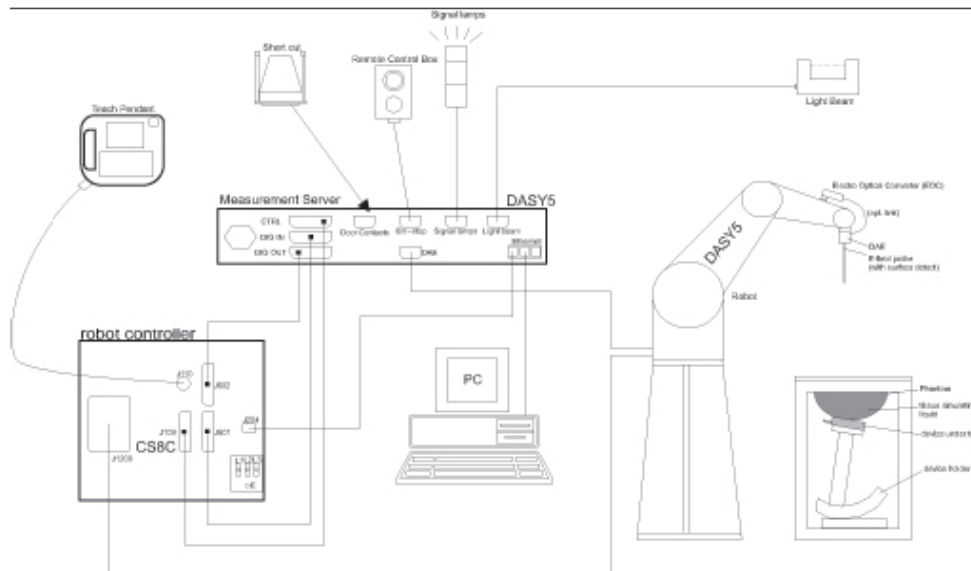
**Table B.1 Comparison between area scan and zoom scan for system verification**

<b>Date</b>	<b>Band</b>	<b>Position</b>	<b>Area scan (1g)</b>	<b>Zoom scan (1g)</b>	<b>Drift (%)</b>
2021-7-18	750 MHz	Head	1.35	1.36	-0.74
2021-7-13	835 MHz	Head	1.55	1.51	2.65
2021-7-15	1750 MHz	Head	4.68	4.73	-1.06
2021-7-17	1900 MHz	Head	5.09	4.95	2.83
2021-7-31	2450 MHz	Head	5.72	5.84	-2.05
2021-7-12	2600 MHz	Head	6.36	6.18	2.91

## ANNEX C SAR Measurement Setup

### C.1 Measurement Set-up

The Dasy5 or DASY6 system for performing compliance tests is illustrated above graphically. This system consists of the following items:



Picture C.1 SAR Lab Test Measurement Set-up

- A standard high precision 6-axis robot (StäubliTX=RX family) with controller, teach pendant and software. An arm extension for accommodating the data acquisition electronics (DAE).
- An isotropic field probe optimized and calibrated for the targeted measurement.
- A data acquisition electronics (DAE) which performs the signal amplification, signal multiplexing, AD-conversion, offset measurements, mechanical surface detection, collision detection, etc. The unit is battery powered with standard or rechargeable batteries. The signal is optically transmitted to the EOC.
- The Electro-optical converter (EOC) performs the conversion from optical to electrical signals for the digital communication to the DAE. To use optical surface detection, a special version of the EOC is required. The EOC signal is transmitted to the measurement server.
- The function of the measurement server is to perform the time critical tasks such as signal filtering, control of the robot operation and fast movement interrupts.
- The Light Beam used is for probe alignment. This improves the (absolute) accuracy of the probe positioning.
- A computer running WinXP and the DASY5 or DASY6 software.
- Remote control and teach pendant as well as additional circuitry for robot safety such as
- warning lamps, etc.
- The phantom, the device holder and other accessories according to the targeted measurement.

## C.2 Dasy5 E-field Probe System

The SAR measurements were conducted with the dosimetric probe designed in the classical triangular configuration and optimized for dosimetric evaluation. The probe is constructed using the thick film technique; with printed resistive lines on ceramic substrates. The probe is equipped with an optical multifiber line ending at the front of the probe tip. It is connected to the EOC box on the robot arm and provides an automatic detection of the phantom surface. Half of the fibers are connected to a pulsed infrared transmitter, the other half to a synchronized receiver. As the probe approaches the surface, the reflection from the surface produces a coupling from the transmitting to the receiving fibers. This reflection increases first during the approach, reaches maximum and then decreases. If the probe is flatly touching the surface, the coupling is zero. The distance of the coupling maximum to the surface is independent of the surface reflectivity and largely independent of the surface to probe angle. The DASY5 or DASY6 software reads the reflection during a software approach and looks for the maximum using 2<sup>nd</sup> order curve fitting. The approach is stopped at reaching the maximum.

### Probe Specifications:

<b>Model:</b>	<b>ES3DV3, EX3DV4</b>
<b>Frequency</b>	<b>10MHz — 6.0GHz(EX3DV4)</b>
<b>Range:</b>	<b>10MHz — 4GHz(ES3DV3)</b>
<b>Calibration:</b>	<b>In head and body simulating tissue at Frequencies from 835 up to 5800MHz</b>
<b>Linearity:</b>	<b>± 0.2 dB(30 MHz to 6 GHz) for EX3DV4 ± 0.2 dB(30 MHz to 4 GHz) for ES3DV3</b>
<b>DynamicRange:</b>	<b>10 mW/kg — 100W/kg</b>
<b>Probe Length:</b>	<b>330 mm</b>
<b>Probe Tip</b>	
<b>Length:</b>	<b>20 mm</b>
<b>Body Diameter:</b>	<b>12 mm</b>
<b>Tip Diameter:</b>	<b>2.5 mm (3.9 mm for ES3DV3)</b>
<b>Tip-Center:</b>	<b>1 mm (2.0mm for ES3DV3)</b>
<b>Application:</b>	<b>SAR Dosimetry Testing Compliance tests of mobile phones Dosimetry in strong gradient fields</b>



Picture C.2 Near-field Probe



Picture C.3 E-field Probe

## C.3 E-field Probe Calibration

Each E-Probe/Probe Amplifier combination has unique calibration parameters. A TEM cell calibration procedure is conducted to determine the proper amplifier settings to enter in the probe parameters. The amplifier settings are determined for a given frequency by subjecting the probe to a known E-field density (1 mW/cm<sup>2</sup>) using an RF Signal generator, TEM cell, and RF Power Meter.

The free space E-field from amplified probe outputs is determined in a test chamber. This calibration can be performed in a TEM cell if the frequency is below 1 GHz and in a waveguide or

other methodologies above 1 GHz for free space. For the free space calibration, the probe is placed in the volumetric center of the cavity and at the proper orientation with the field. The probe is then rotated 360 degrees until the three channels show the maximum reading. The power density readings equates to 1 mW/cm<sup>2</sup>.

E-field temperature correlation calibration is performed in a flat phantom filled with the appropriate simulated brain tissue. The E-field in the medium correlates with the temperature rise in the dielectric medium. For temperature correlation calibration a RF transparent thermistor-based temperature probe is used in conjunction with the E-field probe.

$$SAR = C \frac{\Delta T}{\Delta t}$$

Where:

$\Delta t$  = Exposure time (30 seconds),

C = Heat capacity of tissue (brain or muscle),

$\Delta T$  = Temperature increase due to RF exposure.

$$SAR = \frac{|E|^2 \cdot \sigma}{\rho}$$

Where:

$\sigma$  = Simulated tissue conductivity,

$\rho$  = Tissue density (kg/m<sup>3</sup>).

## C.4 Other Test Equipment

### C.4.1 Data Acquisition Electronics(DAE)

The data acquisition electronics consist of a highly sensitive electrometer-grade preamplifier with auto-zeroing, a channel and gain-switching multiplexer, a fast 16 bit AD-converter and a command decoder with a control logic unit. Transmission to the measurement server is accomplished through an optical downlink for data and status information, as well as an optical uplink for commands and the clock.

The mechanical probe mounting device includes two different sensor systems for frontal and sideways probe contacts. They are used for mechanical surface detection and probe collision detection.

The input impedance of the DAE is 200 MOhm; the inputs are symmetrical and floating. Common mode rejection is above 80 dB.



PictureC.4: DAE

### C.4.2 Robot

The SPEAG DASY system uses the high precision robots (DASY5: RX160L) type from Stäubli SA (France). For the 6-axis controller system, the robot controller version from Stäubli is used. The Stäubli robot series have many features that are important for our application:

- High precision (repeatability 0.02mm)
- High reliability (industrial design)
- Low maintenance costs (virtually maintenance free due to direct drive gears; no belt drives)
- Jerk-free straight movements (brushless synchron motors; no stepper motors)
- Low ELF interference (motor control fields shielded via the closed metallic construction shields)



Picture C.5 DASY 5

### C.4.3 Measurement Server

The Measurement server is based on a PC/104 CPU board with CPU (DASY5: 400 MHz, Intel Celeron), chipdisk (DASY5: 128MB), RAM DASY5: 128MB). The necessary circuits for communication with the DAE electronic box, as well as the 16 bit AD converter system for optical detection and digital I/O interface are contained on the DASY I/O board, which is directly connected to the PC/104 bus of the CPU board.

The measurement server performs all real-time data evaluation of field measurements and surface detection, controls robot movements and handles safety operation. The PC operating system cannot interfere with these time critical processes. All connections are supervised by a watchdog, and disconnection of any of the cables to the measurement server will automatically disarm the robot and disable all program-controlled robot movements. Furthermore, the measurement server is equipped with an expansion port which is reserved for future applications. Please note that this expansion port does not have a standardized pinout, and therefore only devices provided by SPEAG can be connected. Devices from any other supplier could seriously damage the measurement server.



Picture C.6 Server for DASY 5

#### C.4.4 Device Holder for Phantom

The SAR in the phantom is approximately inversely proportional to the square of the distance between the source and the liquid surface. For a source at 5mm distance, a positioning uncertainty of  $\pm 0.5\text{mm}$  would produce a SAR uncertainty of  $\pm 20\%$ . Accurate device positioning is therefore crucial for accurate and repeatable measurements. The positions in which the devices must be measured are defined by the standards.

The DASY device holder is designed to cope with the different positions given in the standard. It has two scales for device rotation (with respect to the body axis) and device inclination (with respect to the line between the ear reference points). The rotation centers for both scales are the ear reference point (ERP). Thus the device needs no repositioning when changing the angles.

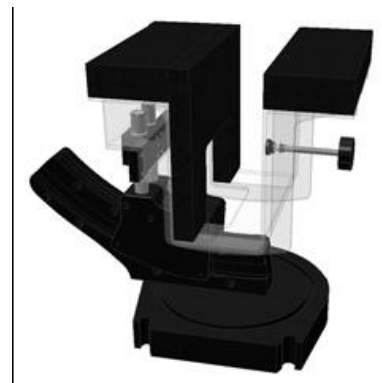
The DASY device holder is constructed of low-loss POM material having the following dielectric parameters: relative permittivity  $\epsilon = 3$  and loss tangent  $\delta = 0.02$ . The amount of dielectric material has been reduced in the closest vicinity of the device, since measurements have suggested that the influence of the clamp on the test results could thus be lowered.

<Laptop Extension Kit>

The extension is lightweight and made of POM, acrylic glass and foam. It fits easily on the upper part of the Mounting Device in place of the phone positioner. The extension is fully compatible with the Twin-SAM and ELI phantoms.



Picture C7-1: Device Holder



Picture C.7-2: Laptop Extension Kit

#### C.4.5 Phantom

The SAM Twin Phantom V4.0 is constructed of a fiberglass shell integrated in a table. The shape of the shell is based on data from an anatomical study designed to

Represent the 90<sup>th</sup> percentile of the population. The phantom enables the dissymmetric evaluation of SAR for both left and right handed handset usage, as well as body-worn usage using the flat phantom region. Reference markings on the Phantom allow the complete setup of all predefined phantom positions and measurement grids by manually teaching three points in the robot. The shell phantom has a 2mm shell thickness (except the ear region where shell thickness increases to 6 mm).

Shell Thickness:  $2 \pm 0.2$  mm

Filling Volume: Approx. 25 liters

Dimensions: 810 x 1000 x 500 mm (H x L x W)

Available: Special

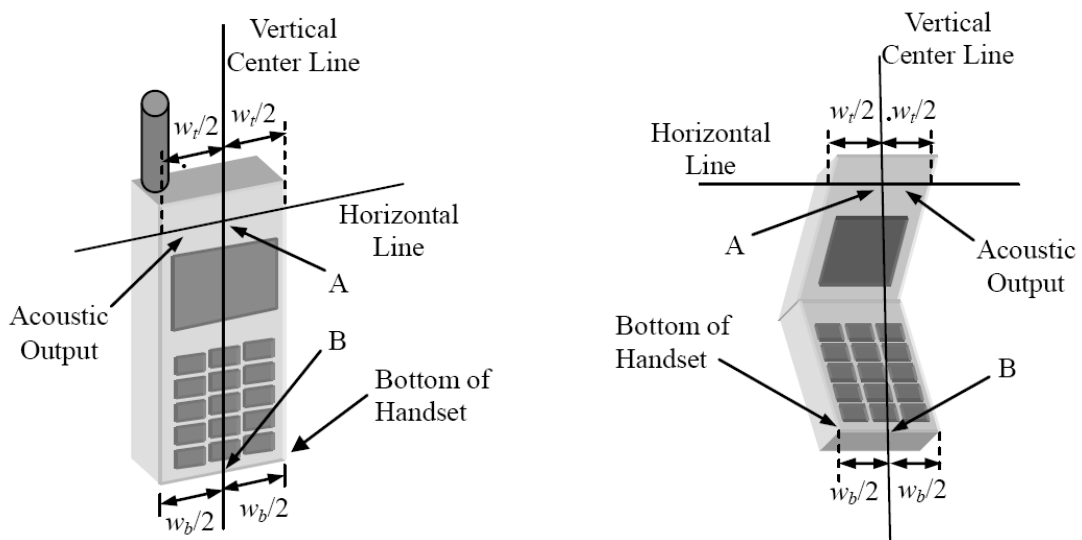


**Picture C.8: SAM Twin Phantom**

## ANNEX D Position of the wireless device in relation to the phantom

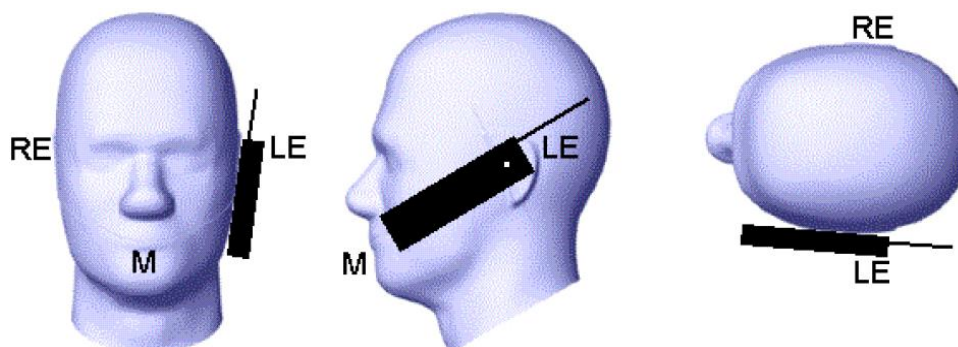
### D.1 General considerations

This standard specifies two handset test positions against the head phantom – the “cheek” position and the “tilt” position.



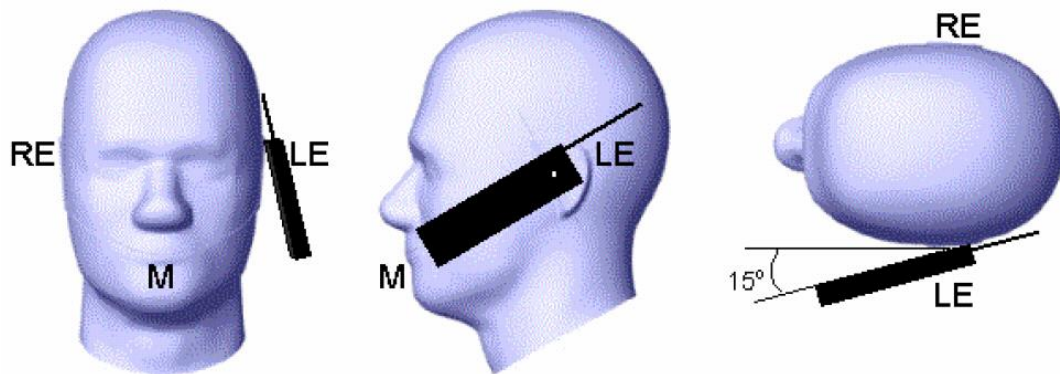
- $w_t$  Width of the handset at the level of the acoustic
- $w_b$  Width of the bottom of the handset
- A Midpoint of the width  $w_t$  of the handset at the level of the acoustic output
- B Midpoint of the width  $w_b$  of the bottom of the handset

Picture D.1-a Typical “fixed” case handset      Picture D.1-b Typical “clam-shell” case handset



Picture D.2 Cheek position of the wireless device on the left side of SAM

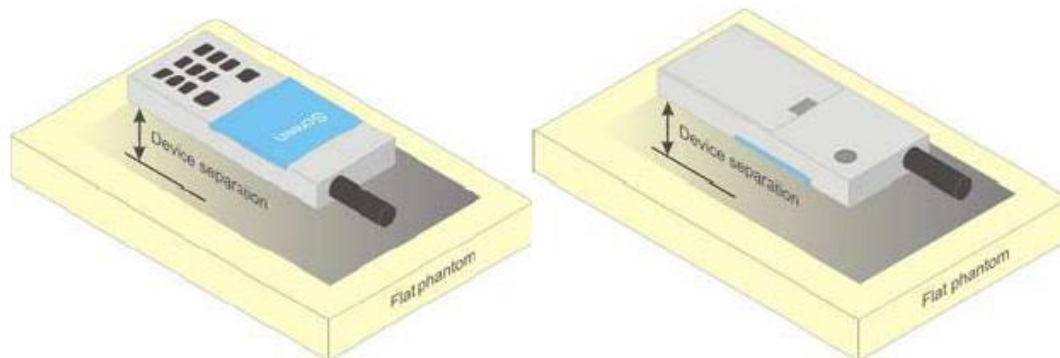




Picture D.3 Tilt position of the wireless device on the left side of SAM

## D.2 Body-worn device

A typical example of a body-worn device is a mobile phone, wireless enabled PDA or other battery operated wireless device with the ability to transmit while mounted on a person's body using a carry accessory approved by the wireless device manufacturer.

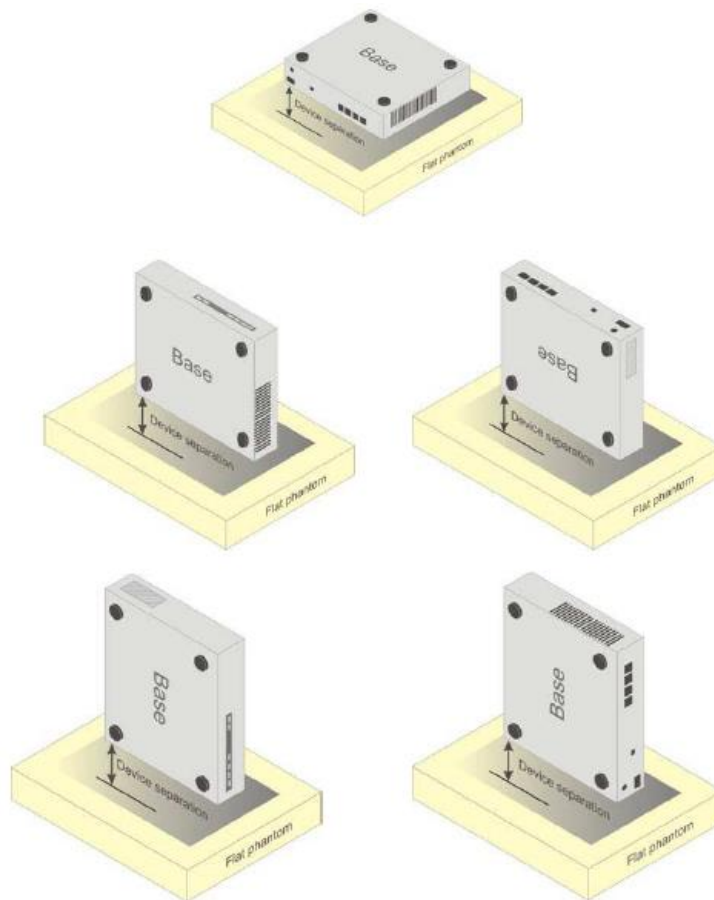


Picture D.4 Test positions for body-worn devices

## D.3 Desktop device

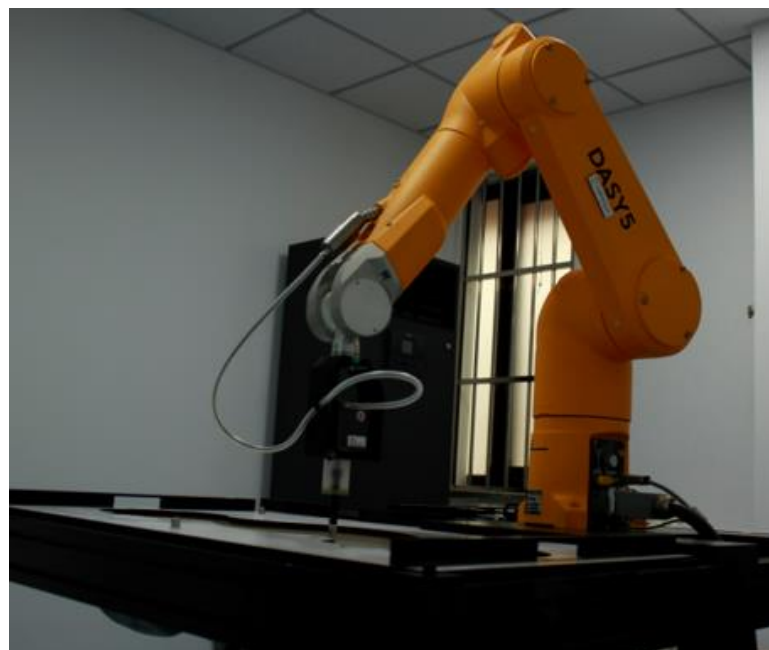
A typical example of a desktop device is a wireless enabled desktop computer placed on a table or desk when used.

The DUT shall be positioned at the distance and in the orientation to the phantom that corresponds to the intended use as specified by the manufacturer in the user instructions. For devices that employ an external antenna with variable positions, tests shall be performed for all antenna positions specified. Picture 8.5 show positions for desktop device SAR tests. If the intended use is not specified, the device shall be tested directly against the flat phantom.



Picture D.5 Test positions for desktop devices

#### D.4 DUT Setup Photos



Picture D.6

## ANNEX E Equivalent Media Recipes

The liquid used for the frequency range of 800-3000 MHz consisted of water, sugar, salt, preventol, glycol monobutyl and Cellulose. The liquid has been previously proven to be suited for worst-case. The Table E.1 shows the detail solution. It's satisfying the latest tissue dielectric parameters requirements proposed by the IEEE 1528 and IEC 62209.

**TableE.1: Composition of the Tissue Equivalent Matter**

Frequency (MHz)	835Head	835Body	1900 Head	1900 Body	2450 Head	2450 Body	5800 Head	5800 Body
Ingredients (% by weight)								
Water	41.45	52.5	55.242	69.91	58.79	72.60	65.53	65.53
Sugar	56.0	45.0	\	\	\	\	\	\
Salt	1.45	1.4	0.306	0.13	0.06	0.18	\	\
Preventol	0.1	0.1	\	\	\	\	\	\
Cellulose	1.0	1.0	\	\	\	\	\	\
Glycol Monobutyl	\	\	44.452	29.96	41.15	27.22	\	\
Diethylenglycol monohexylether	\	\	\	\	\	\	17.24	17.24
Triton X-100	\	\	\	\	\	\	17.24	17.24
Dielectric Parameters Target Value	$\epsilon=41.5$ $\sigma=0.90$	$\epsilon=55.2$ $\sigma=0.97$	$\epsilon=40.0$ $\sigma=1.40$	$\epsilon=53.3$ $\sigma=1.52$	$\epsilon=39.2$ $\sigma=1.80$	$\epsilon=52.7$ $\sigma=1.95$	$\epsilon=35.3$ $\sigma=5.27$	$\epsilon=48.2$ $\sigma=6.00$

**Note: There are a little adjustment respectively for 750, 1750, 2600, 5200, 5300 and 5600 based on the recipe of closest frequency in table E.1.**

## ANNEX F System Validation

The SAR system must be validated against its performance specifications before it is deployed. When SAR probes, system components or software are changed, upgraded or recalibrated, these must be validated with the SAR system(s) that operates with such components.

**Table F.1: System Validation for 7600**

Probe SN.	Liquid name	Validation date	Frequency point	Status (OK or Not)
7600	Head 750MHz	December 2, 2020	750 MHz	OK
7600	Head 900MHz	December 2, 2020	900 MHz	OK
7600	Head 1450MHz	December 3, 2020	1450 MHz	OK
7600	Head 1640MHz	December 3, 2020	1640 MHz	OK
7600	Head 1750MHz	December 3, 2020	1750 MHz	OK
7600	Head 1900MHz	December 4, 2020	1900 MHz	OK
7600	Head 2000MHz	December 4, 2020	2000 MHz	OK
7600	Head 2300MHz	December 4, 2020	2300 MHz	OK
7600	Head 2450MHz	December 5, 2020	2450 MHz	OK
7600	Head 2600MHz	December 5, 2020	2600 MHz	OK
7600	Head 3300MHz	December 6, 2020	3300 MHz	OK
7600	Head 3500MHz	December 6, 2020	3500 MHz	OK
7600	Head 3700MHz	December 6, 2020	3700 MHz	OK
7600	Head 3900MHz	December 7, 2020	3900 MHz	OK
7600	Head 4100MHz	December 7, 2020	4100MHz	OK
7600	Head 4200MHz	December 7, 2020	4200MHz	OK
7600	Head 4400MHz	December 8, 2020	4400MHz	OK
7600	Head 4600MHz	December 8, 2020	4600MHz	OK
7600	Head 4800MHz	December 8, 2020	4800MHz	OK
7600	Head 4950MHz	December 8, 2020	4950MHz	OK
7600	Head 5250MHz	December 9, 2020	5250MHz	OK
7600	Head 5600MHz	December 9, 2020	5600 MHz	OK
7600	Head 5750MHz	December 9, 2020	5750 MHz	OK



No.I21Z61109-SEM03

# ANNEX G Probe Calibration Certificate

## Probe 7600 Calibration Certificate



中国认可  
国际互认  
校准  
CALIBRATION  
CNAS L0570

Add: No.51 Xueyuan Road, Haidian District, Beijing, 100191, China  
Tel: +86-10-62304633-2512 Fax: +86-10-62304633-2504  
E-mail: cttl@chinattl.com [Http://www.chinattl.cn](http://www.chinattl.cn)

Client **CTTL**

Certificate No: **Z20-60421**

CALIBRATION CERTIFICATE			
Object	EX3DV4 - SN : 7600		
Calibration Procedure(s)	FF-Z11-004-02 Calibration Procedures for Dosimetric E-field Probes		
Calibration date:	November 30, 2020		
This calibration Certificate documents the traceability to national standards, which realize the physical units of measurements(SI). The measurements and the uncertainties with confidence probability are given on the following pages and are part of the certificate.			
All calibrations have been conducted in the closed laboratory facility: environment temperature(22±3)°C and humidity<70%.			
Calibration Equipment used (M&TE critical for calibration)			
Primary Standards	ID #	Cal Date(Calibrated by, Certificate No.)	Scheduled Calibration
Power Meter NRP2	101919	16-Jun-20(CTTL, No.J20X04344)	Jun-21
Power sensor NRP-Z91	101547	16-Jun-20(CTTL, No.J20X04344)	Jun-21
Power sensor NRP-Z91	101548	16-Jun-20(CTTL, No.J20X04344)	Jun-21
Reference 10dBAttenuator	18N50W-10dB	10-Feb-20(CTTL, No.J20X00525)	Feb-22
Reference 20dBAttenuator	18N50W-20dB	10-Feb-20(CTTL, No.J20X00526)	Feb-22
Reference Probe EX3DV4	SN 7307	29-May-20(SPEAG, No.EX3-7307_May20)	May-21
DAE4	SN 1556	4-Feb-20(SPEAG, No.DAE4-1556_Feb20)	Feb-21
Secondary Standards	ID #	Cal Date(Calibrated by, Certificate No.)	Scheduled Calibration
SignalGenerator MG3700A	6201052605	23-Jun-20(CTTL, No.J20X04343)	Jun-21
Network Analyzer E5071C	MY46110673	10-Feb-20(CTTL, No.J20X00515)	Feb-21
Calibrated by:	Name Yu Zongying	Function SAR Test Engineer	Signature 
Reviewed by:	Name Lin Hao	Function SAR Test Engineer	Signature 
Approved by:	Name Qi Dianyuan	Function SAR Project Leader	Signature 
Issued: December 02, 2020			
This calibration certificate shall not be reproduced except in full without written approval of the laboratory.			