

APPROVAL SPECIFICATION

Product : Internal Antenna

Model Name : TMRV5GTB

Date : 2023.05.03

Table of Contents

	Page
1. Manufacturer -----	3
2. Model Name -----	3
3. Antenna Type -----	3
4. Electrical Performance Data -----	3
5. Matching circuit -----	13
6. Electrical Graph(VSWR/Return loss)-----	15
7. External Drawing -----	17

1. Manufacturer

- Kunshan Innowave Communication Technology Co.,Ltd

2. Model Name

- Basic Model: TMRV5GTB

3. Antenna Type

ANT	Antenna type
ANT0	FPC Antenna, IFA
ANT1	FPC Antenna, IFA
ANT2	FPC Antenna, IFA
ANT3	FPC Antenna, IFA
ANT4	FPC Antenna, IFA
ANT5	FPC Antenna, IFA
ANT6	FPC Antenna, IFA

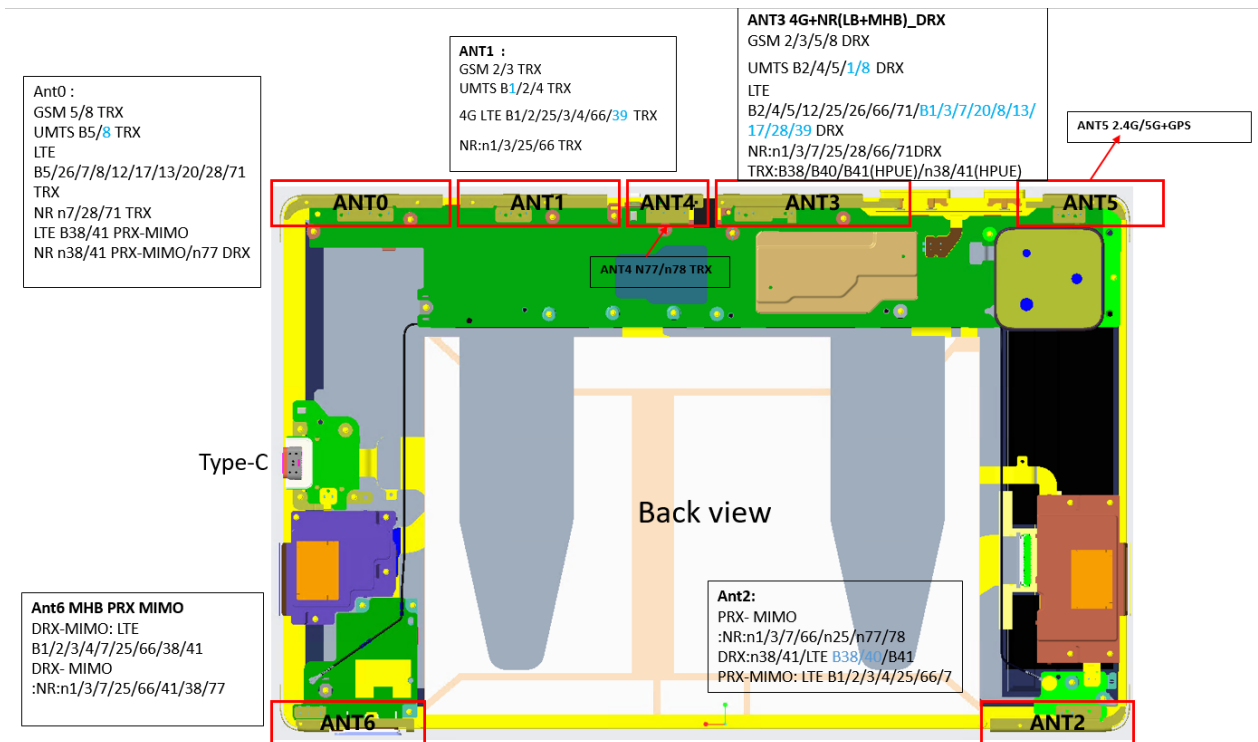

4. Electric Performance Data

4.1 Specification Sheet

Electronic Specification				
Frequency Range [MHz]	LTE B1/n1 WCDMA B1	LTE B2/WCDMA B2/PCS1900	LTE B3/n3 DCS1800	LTE B4/WCDMA B4
	1920-2170	1805-1990	1710-1880	1710-2155
ANT	ANT1	ANT1	ANT1	ANT1
Peak Gain(dBi)	0.2	0.2	0.16	0.2
Average Gain(dBi)	-0.89	-0.37	-0.63	-0.72
Frequency Range [MHz]	LTE B5/WCDMA B5/GSM850	LTE B7/n7	LTE B8/WCDMA B8/GSM 900	LTE B12
	824-894	2500-2690	880-960	699-746
ANT	ANT0	ANT0	ANT0	ANT0
Peak Gain(dBi)	-1.3	-0.6	-0.94	-7.48
Average Gain(dBi)	-1.58	-2.1	-2.2	-8.2
Frequency Range [MHz]	LTE B13	LTE B17	LTE B20	LTE B25/n25
	746-787	704-746	791-862	1850-1995
ANT	ANT0	ANT0	ANT0	ANT1
Peak Gain(dBi)	-5.9	-7.6	-1.3	0.2
Average Gain(dBi)	-6.3	-7.9	-2.2	-0.22
Frequency Range [MHz]	LTE B26	LTE B28/n28	LTE B38/n38	LTE B39
	814-894	703-803	2570-2620	1880-1920
ANT	ANT0	ANT0	ANT3	ANT1
Peak Gain(dBi)	-1.3	-3.64	0.93	0.2
Average Gain(dBi)	-1.6	-4.5	0.39	-0.13
Frequency Range [MHz]	LTE B40	LTE B41/n41	LTE B66/n66	LTE B71/n71
	2300-2400	2496-2690	1710-2180	617-698
ANT	ANT3	ANT3	ANT1	ANT0
Peak Gain(dBi)	2.9	2.93	0.2	-5.7
Average Gain(dBi)	2.73	0.56	-0.75	-8.8
Frequency Range [MHz]	n77	n78	WIFI 2.4G	WIFI 5G
	3300-4200	3300-3800	2400-2484	5150-5850
ANT	ANT4	ANT4	ANT5	ANT5
Peak Gain(dBi)	0.77	0.22	0.79	0.71
Average Gain(dBi)	-0.96	-1.14	0.24	-1.43

4.2 Antenna Pattern Drawing

ANT5 GPS(1576MHz)

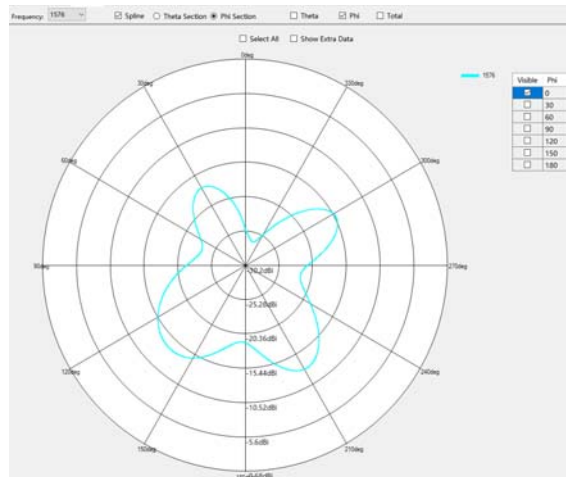
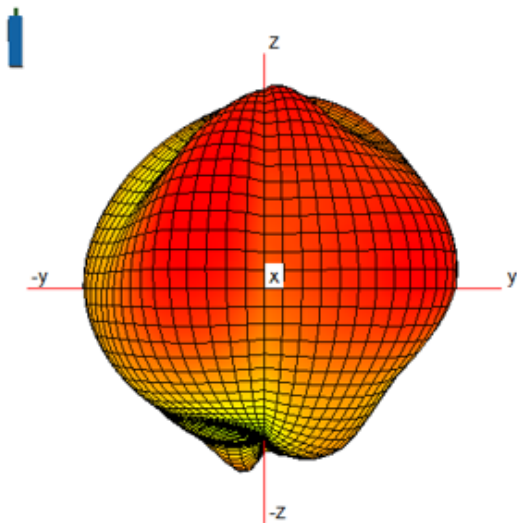

Phi=0.00deg

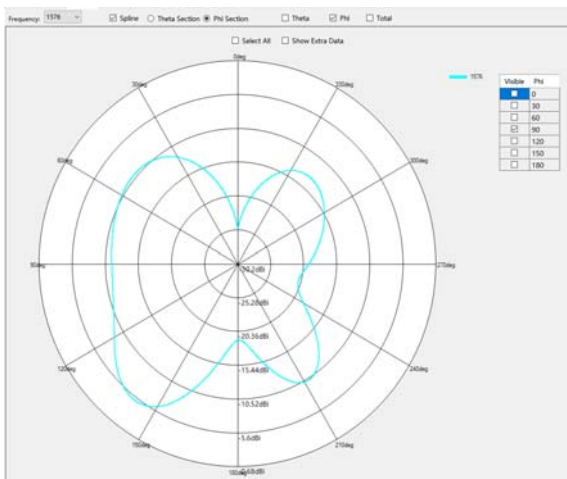

Phi=90.00deg

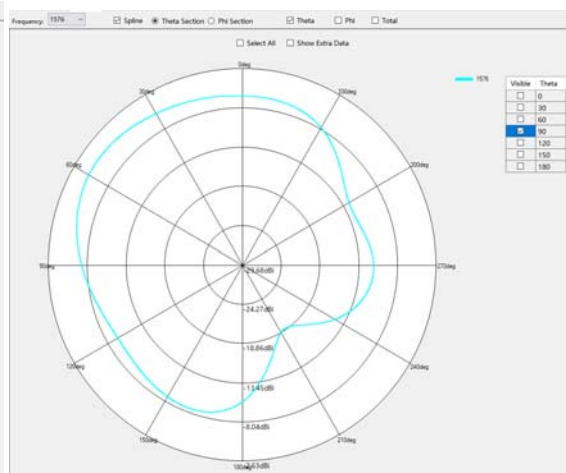

Theta=90.00deg

ANT5 WIFI 2.4G(2400MHz)

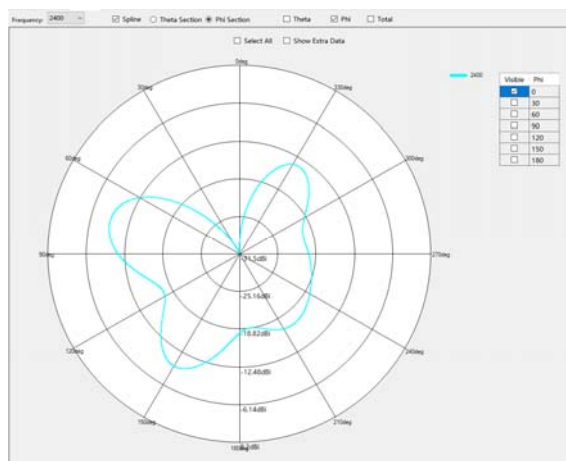
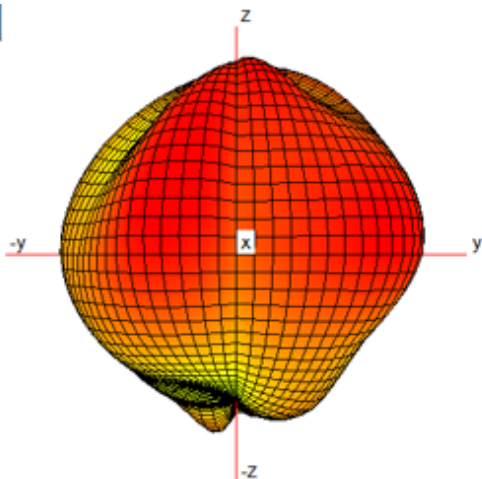

Phi=0.00deg

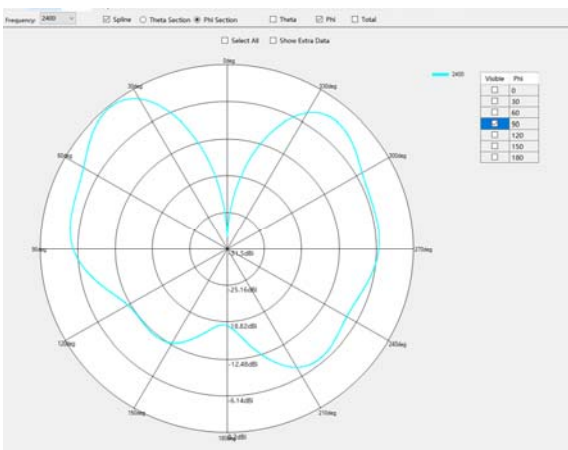

Phi=90.00deg

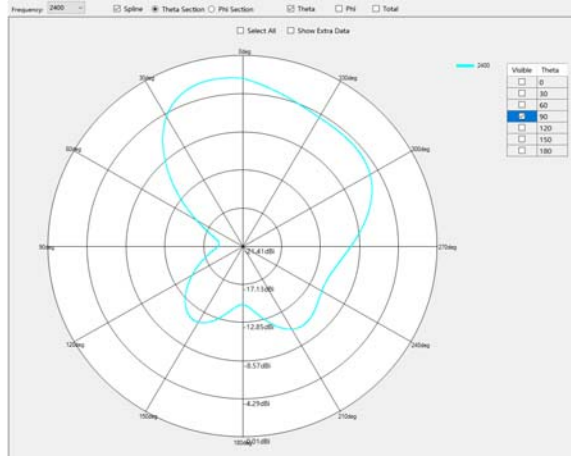

Theta=90.00deg

ANT5 WIFI 2.4G(2450MHZ)

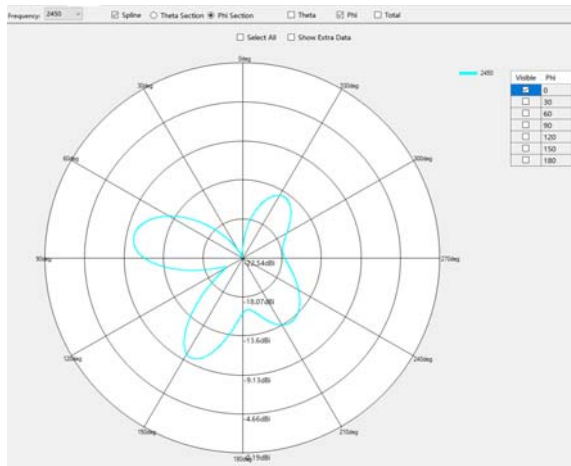
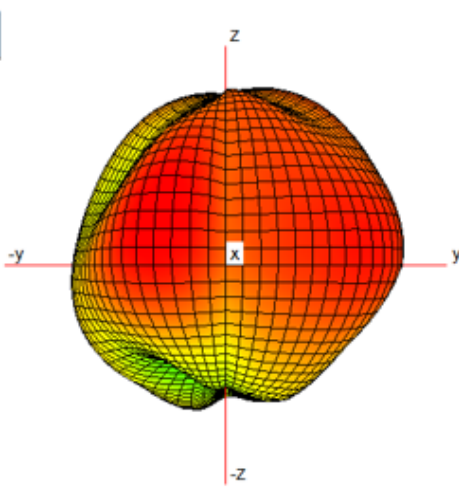

Phi=0.00deg

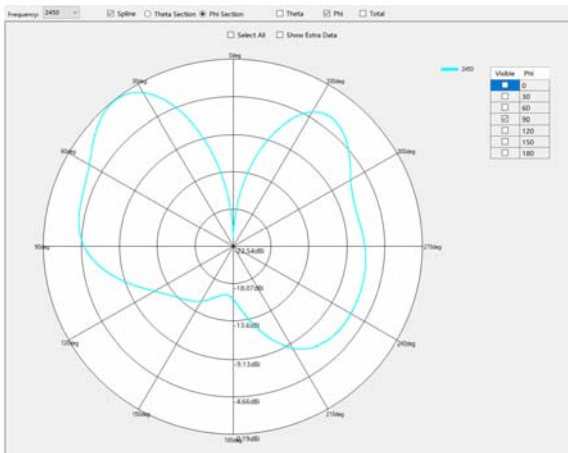

Phi=90.00deg

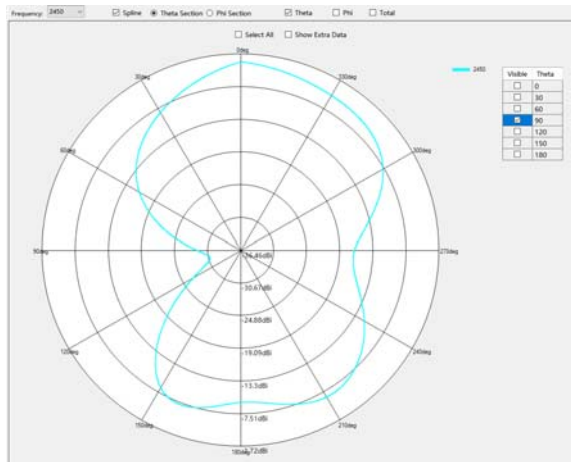

Theta=90.00deg

ANT5 WIFI 2.4G(2500MHz)

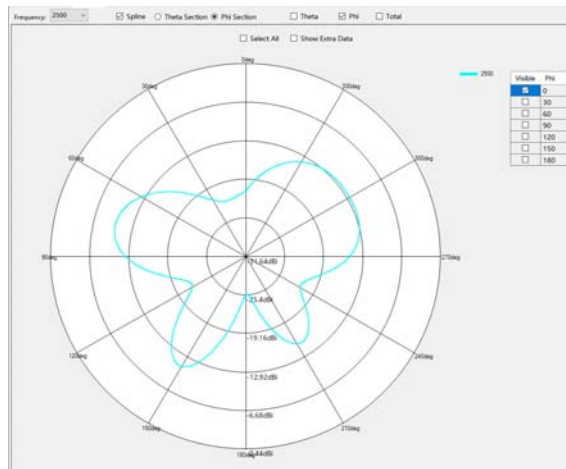
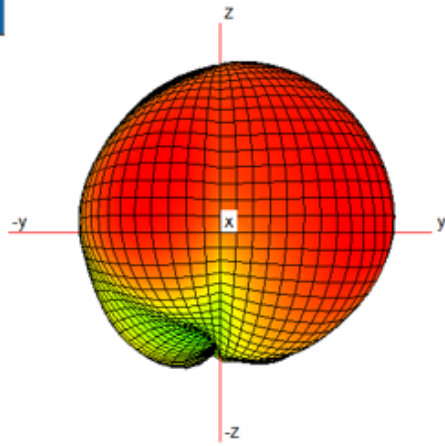

Phi=0.00deg

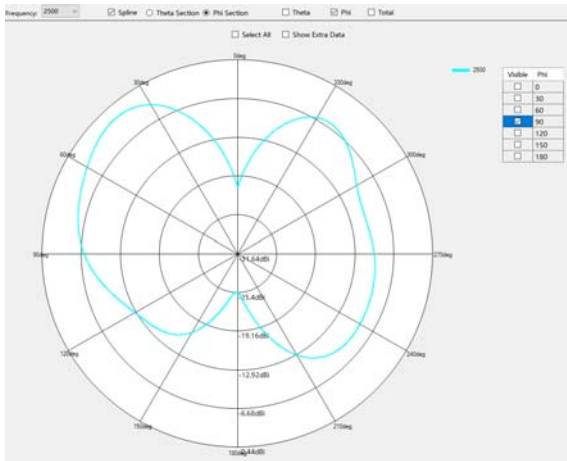

Phi=90.00deg

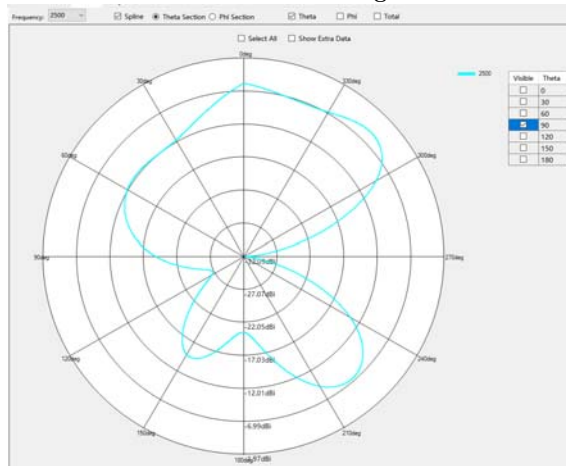

Theta=90.00deg

ANT5 WIFI 5G(5150MHz)

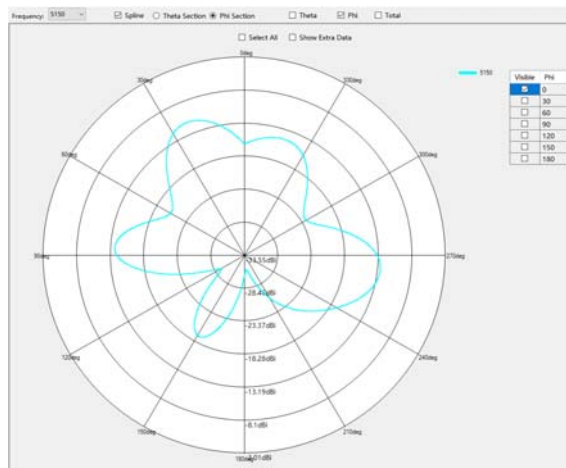
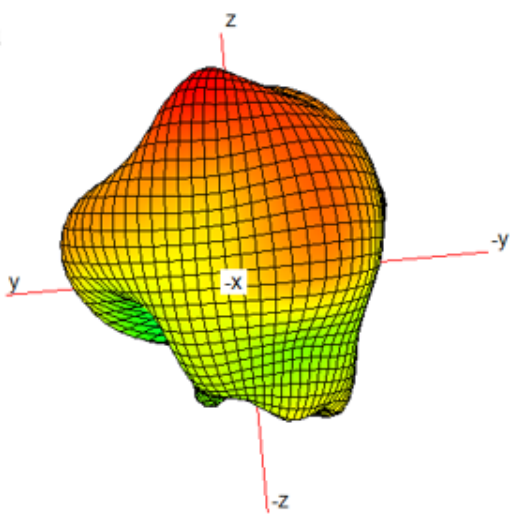

Phi=0.00deg

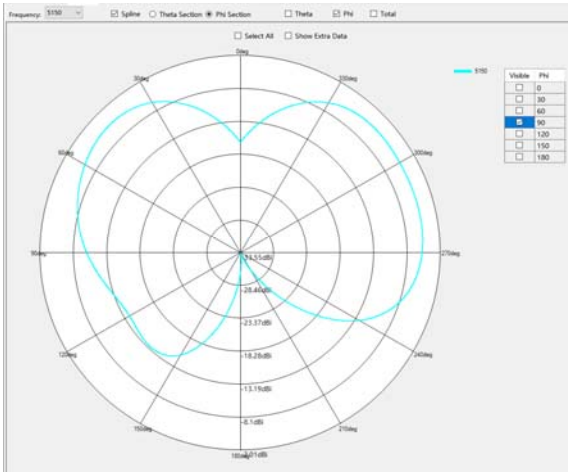

Phi=90.00deg

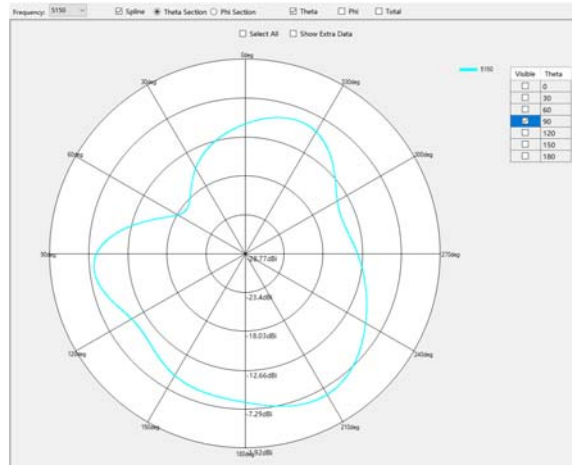

Theta=90.00deg

ANT5 WIFI 5G(5350MHZ)

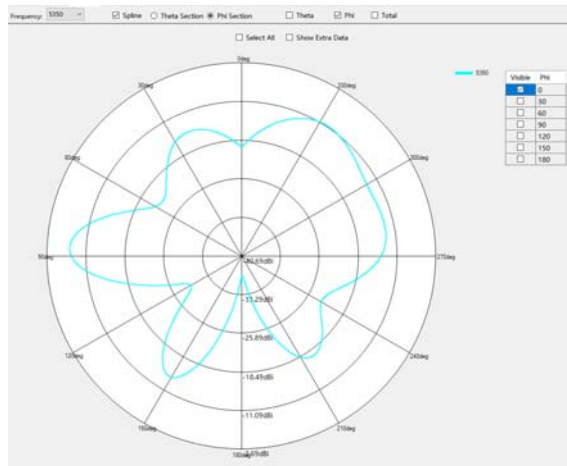
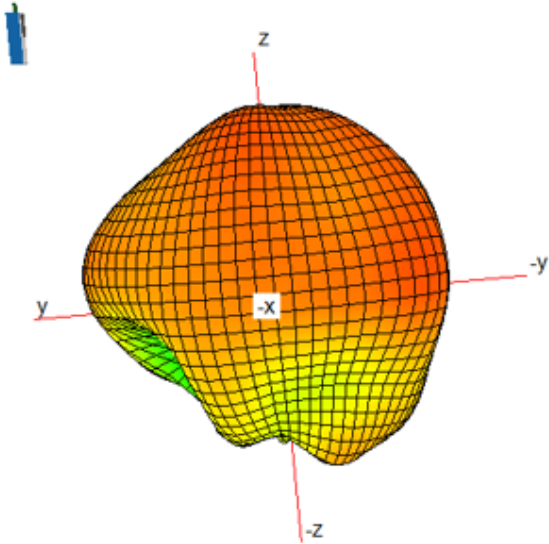

Phi=0.00deg

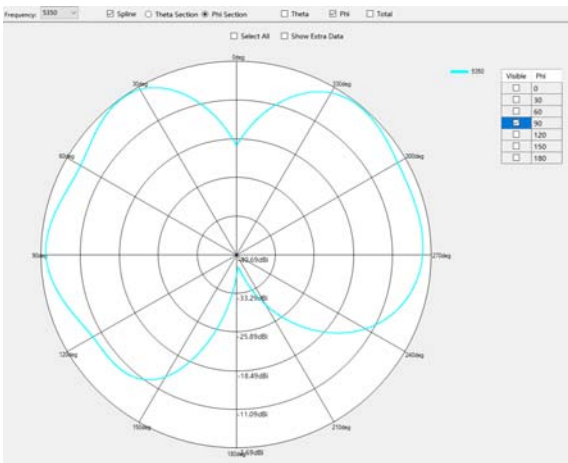

Phi=90.00deg

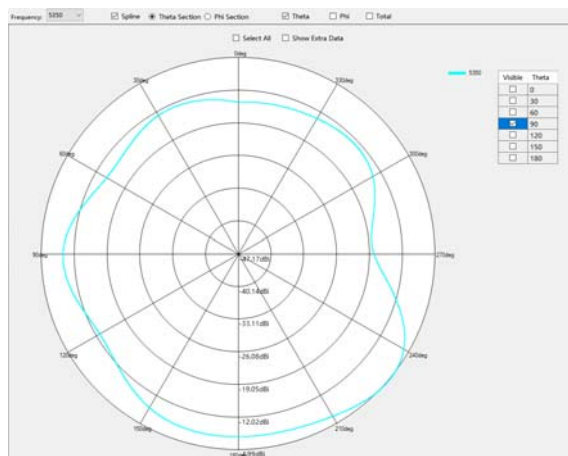

Theta=90.00deg

ANT5 WIFI 5G(5850MHz)

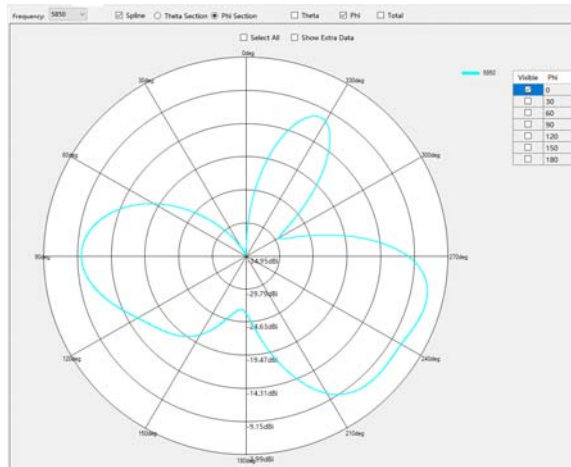
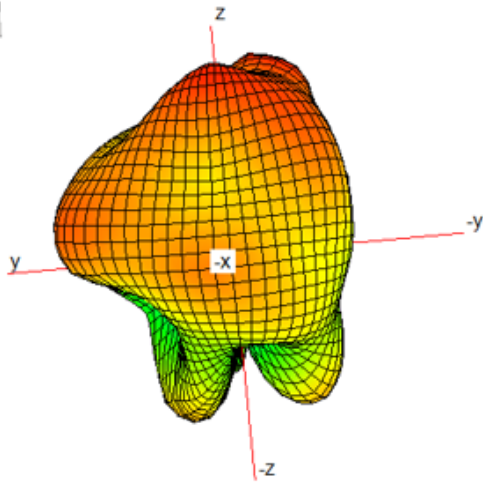

Phi=0.00deg

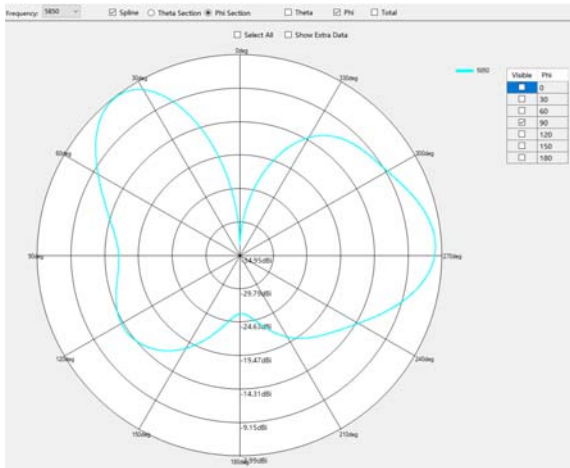

Phi=90.00deg

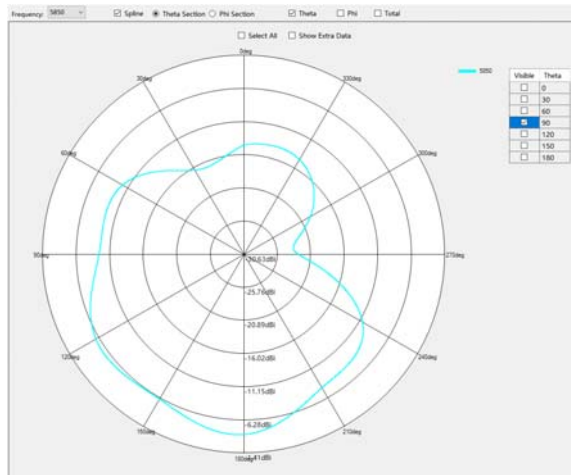

Theta=90.00deg

ANT1 Band1

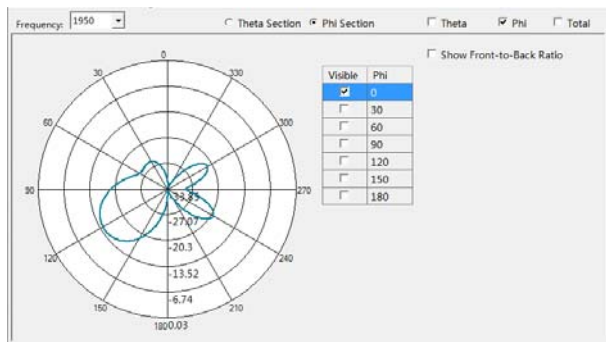
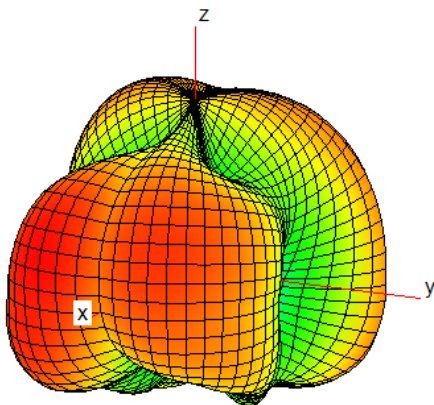

Phi=0.00deg

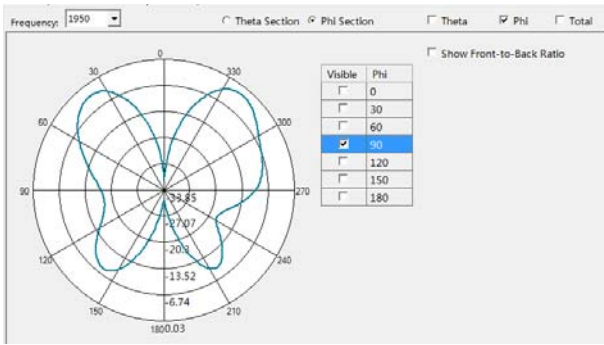

Phi=90.00deg

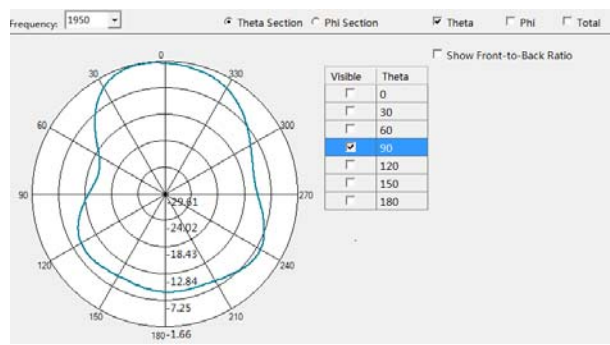

Theta=90.00deg

ANT1 Band2

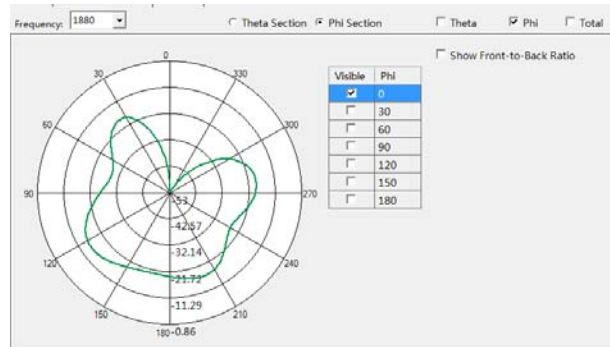
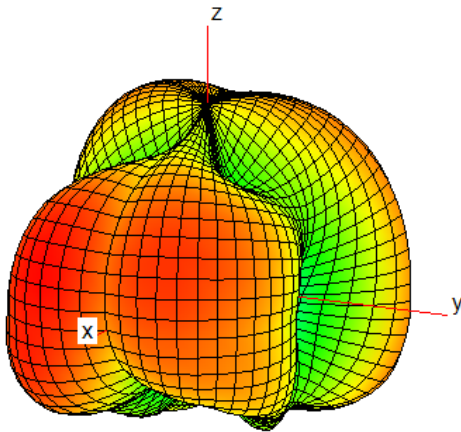

Phi=0.00deg

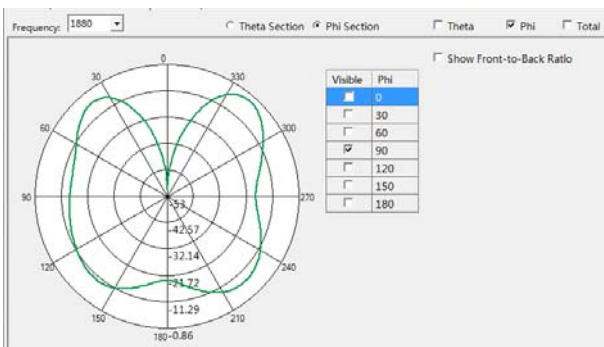

Phi=90.00deg

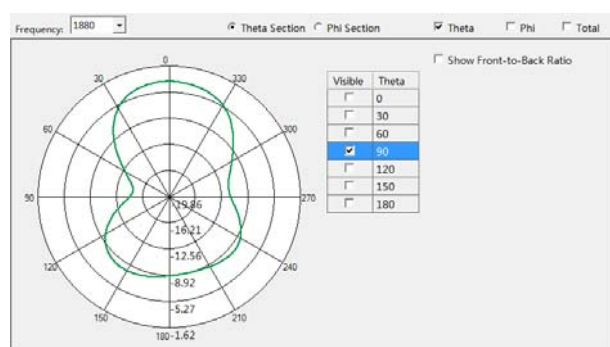

Theta=90.00deg

ANT1 Band3

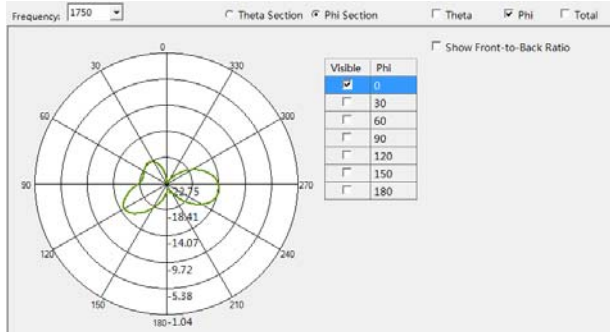
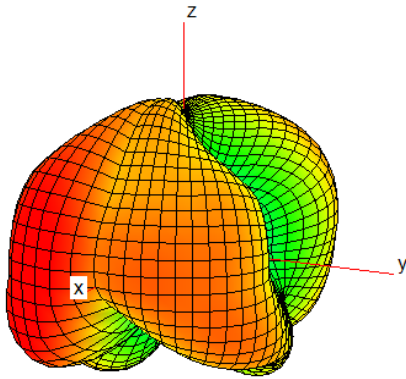

Phi=0.00deg

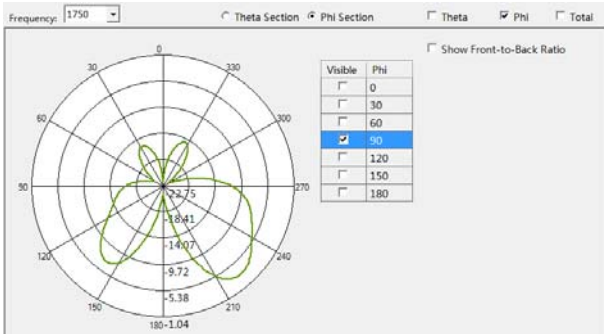

Phi=90.00deg

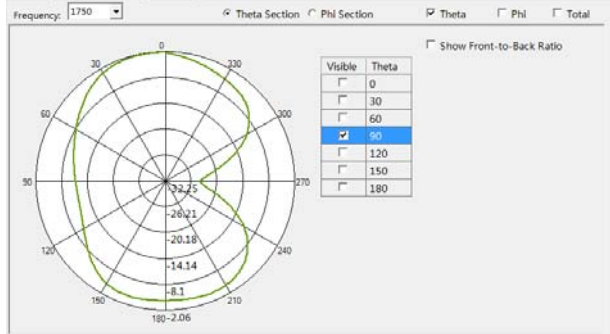

Theta=90.00deg

ANT1 Band4

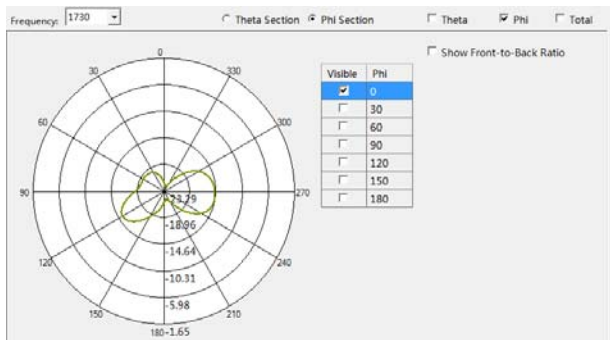
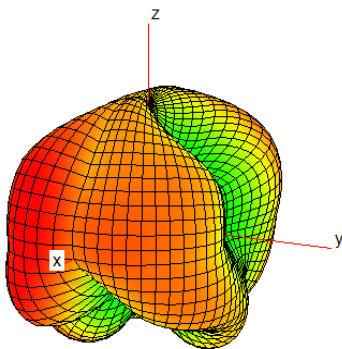

Phi=0.00deg

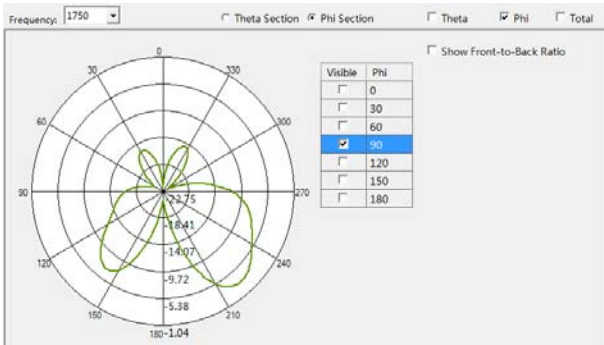

Phi=90.00deg

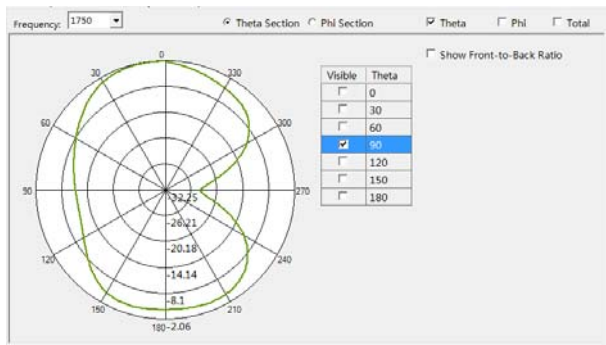

Theta=90.00deg

ANT0 Band5

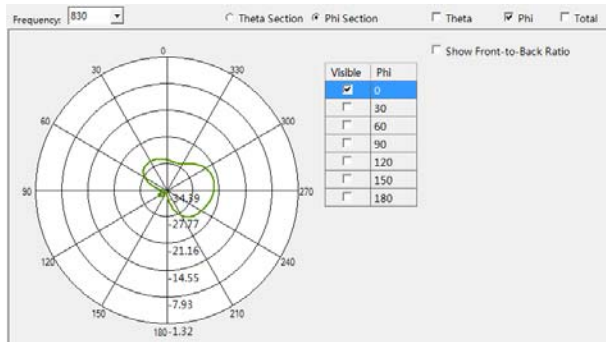
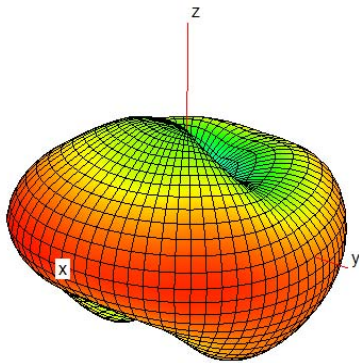

Phi=0.00deg

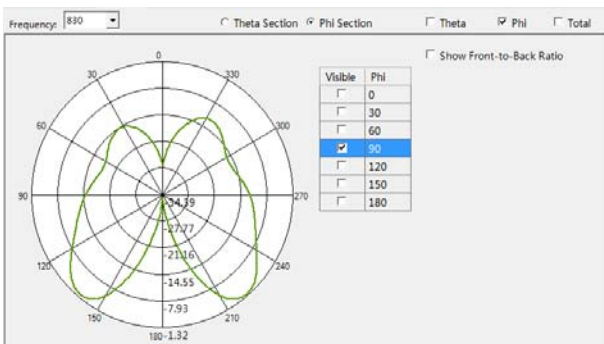

Phi=90.00deg

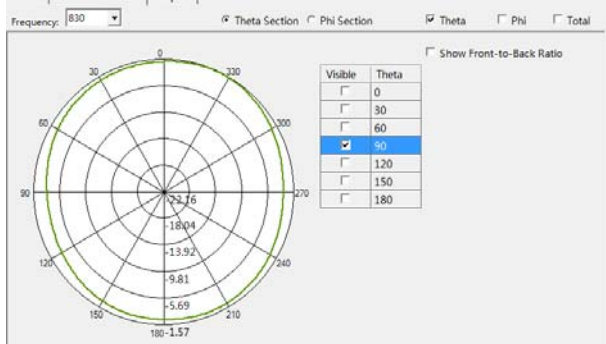

Theta=90.00deg

ANT0 Band7

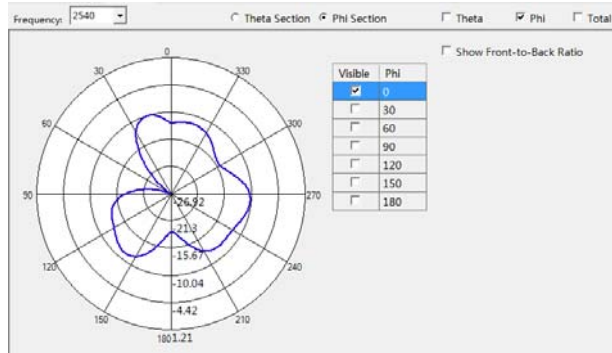
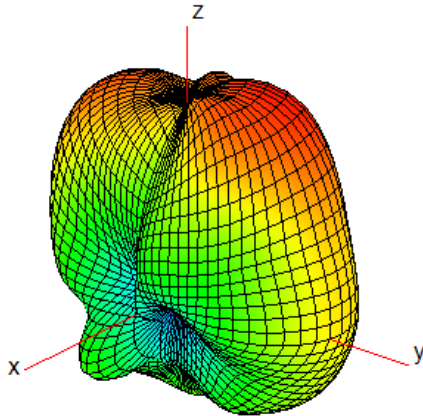

Phi=0.00deg

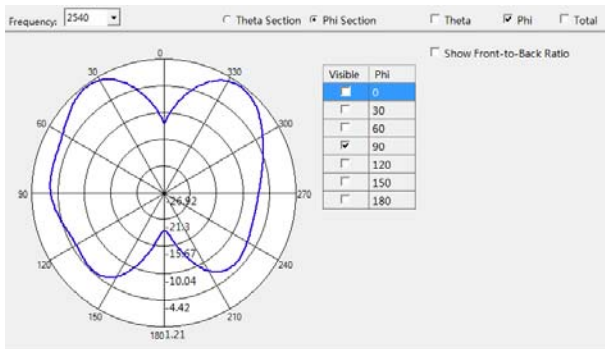

Phi=90.00deg

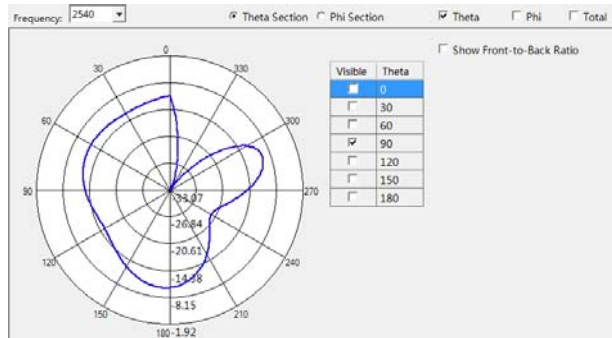

Theta=90.00deg

ANT0 Band8

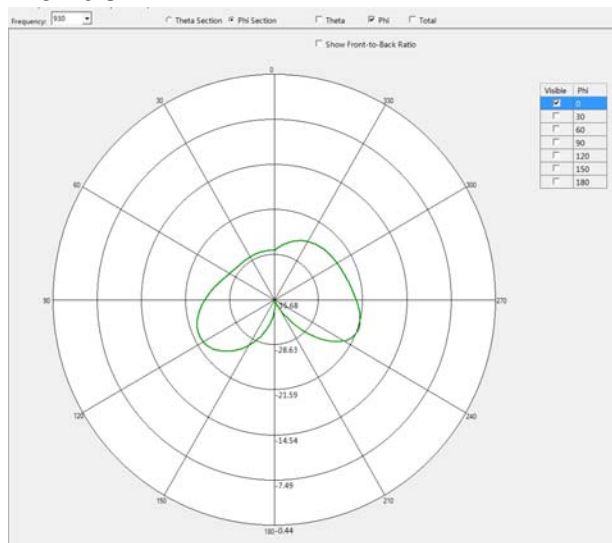
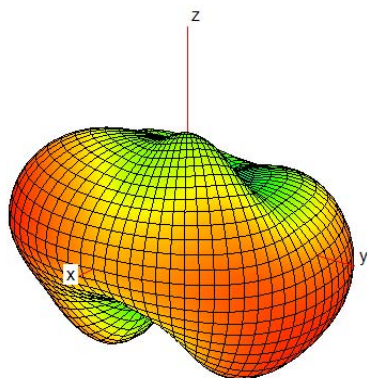

Phi=0.00deg

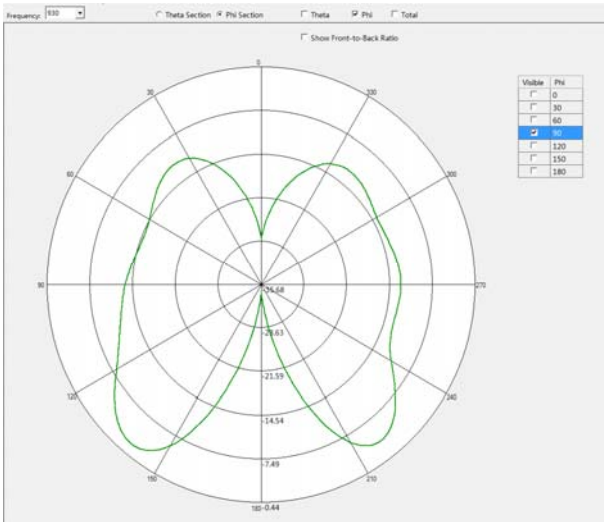

Phi=90.00deg

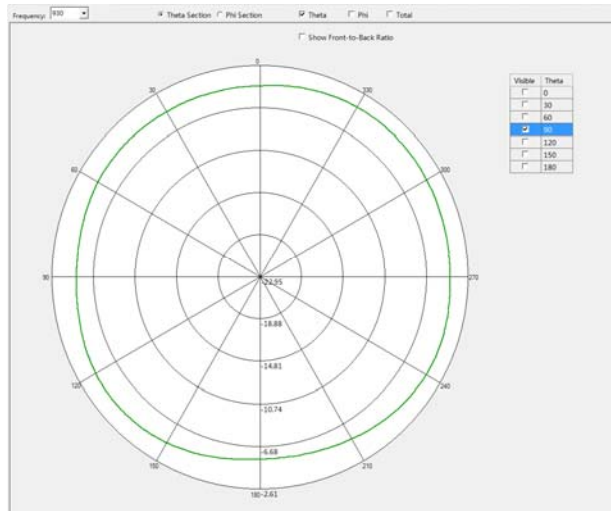

Theta=90.00deg

ANT0 Band12

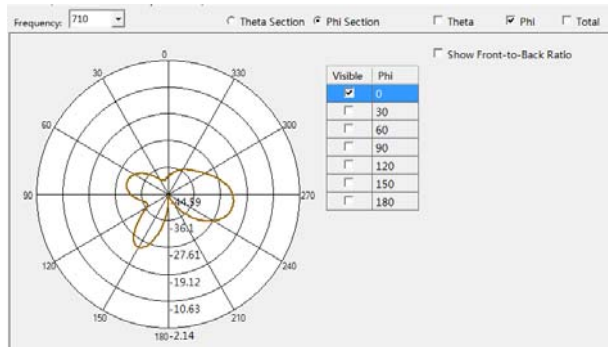
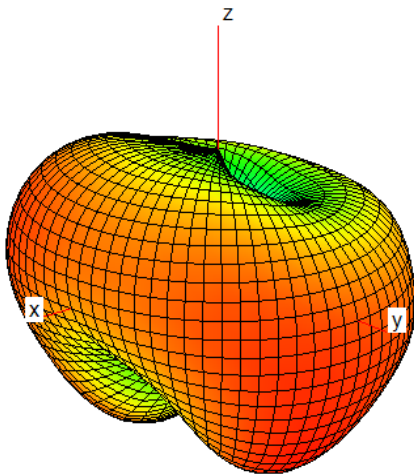

Phi=0.00deg

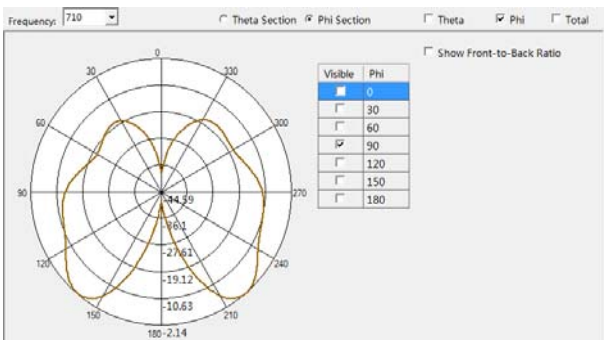

Phi=90.00deg

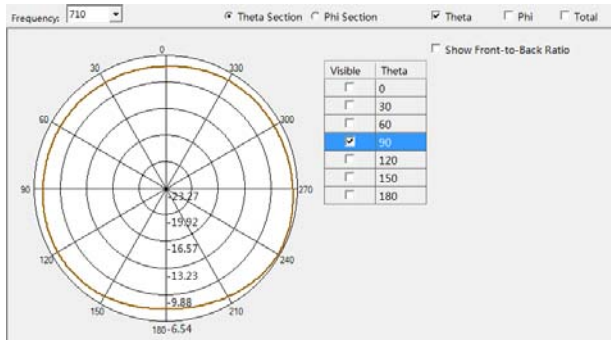

Theta=90.00deg

ANT0 Band13

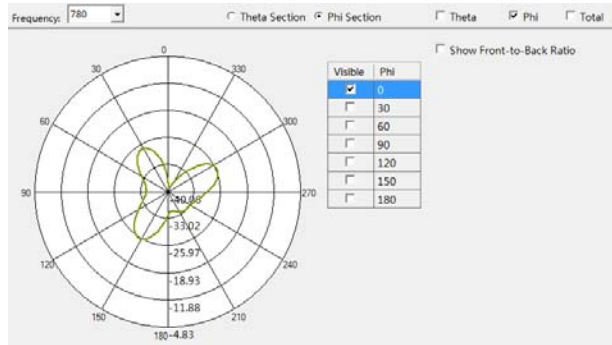
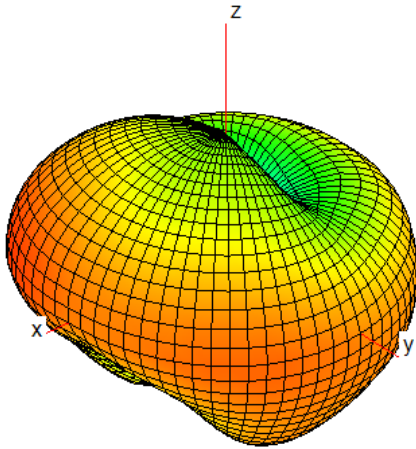

Phi=0.00deg

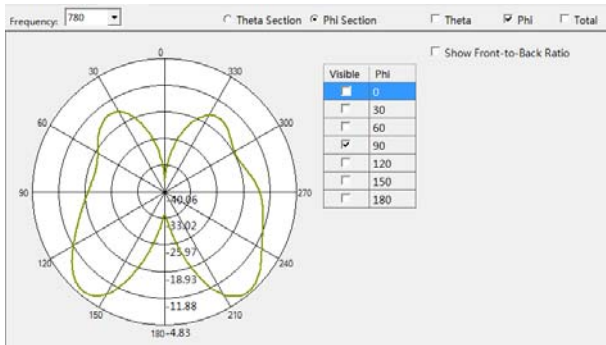

Phi=90.00deg

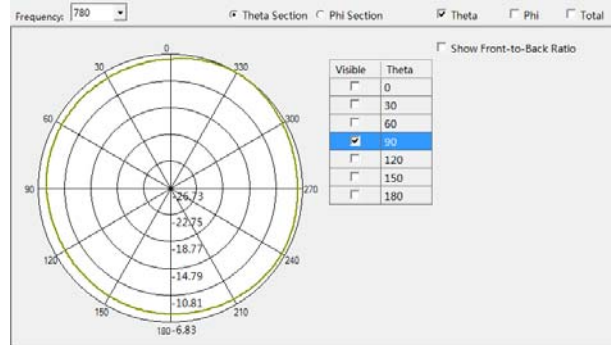

Theta=90.00deg

ANT0 Band17

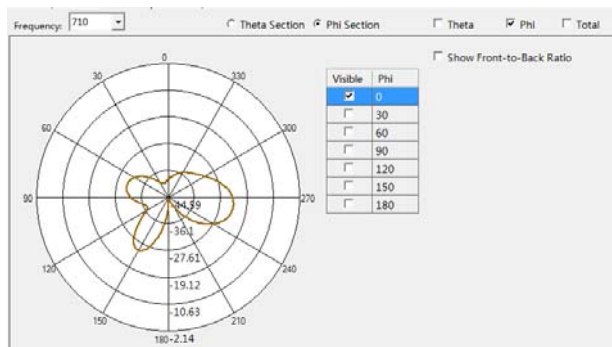
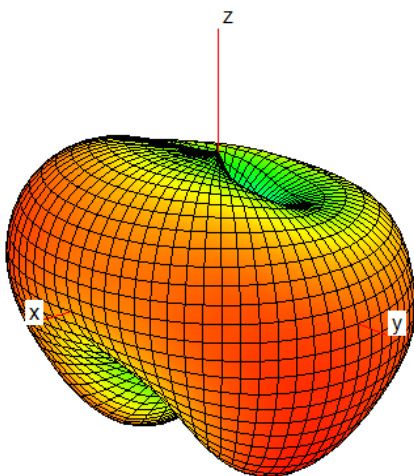

Phi=0.00deg

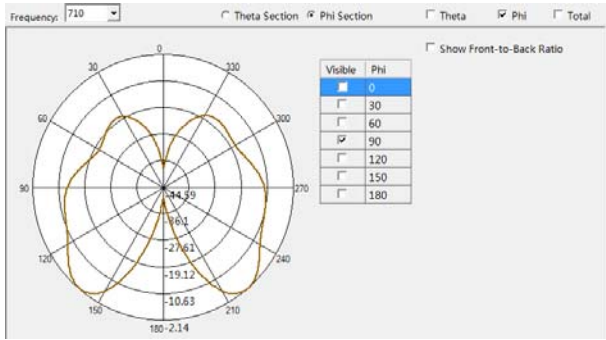

Phi=90.00deg

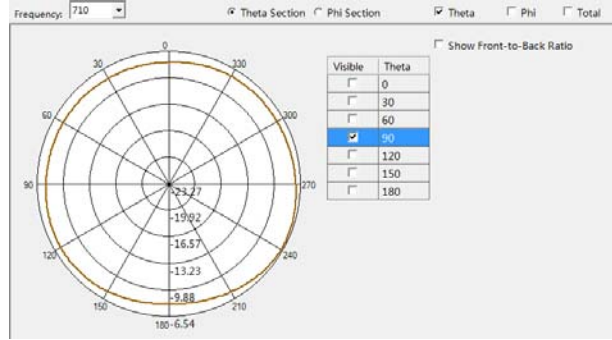

Theta=90.00deg

ANT0 Band20

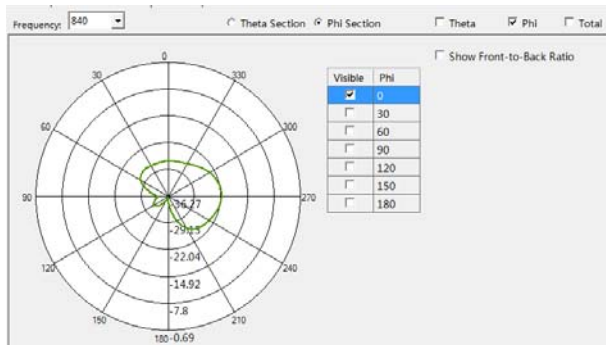
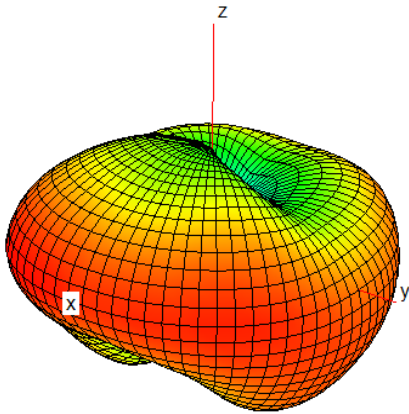

Phi=0.00deg

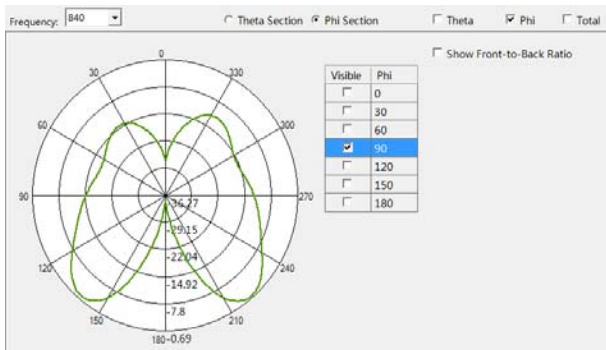

Phi=90.00deg

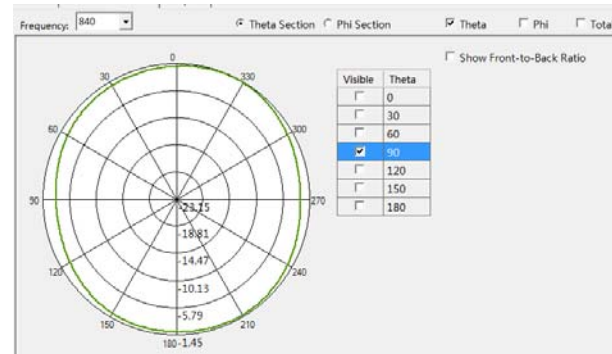

Theta=90.00deg

ANT1 Band25

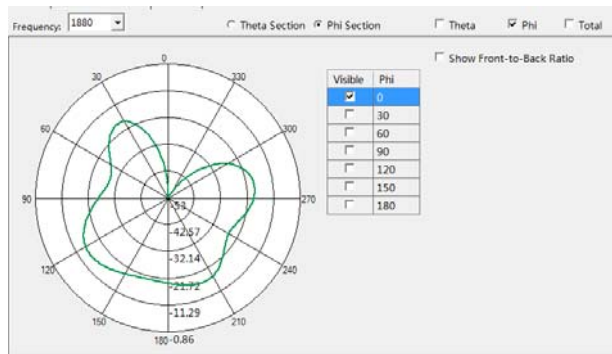
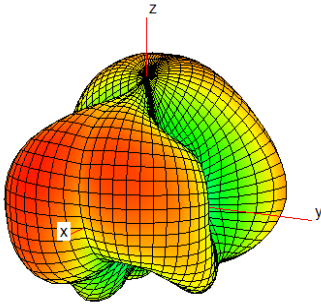

Phi=0.00deg

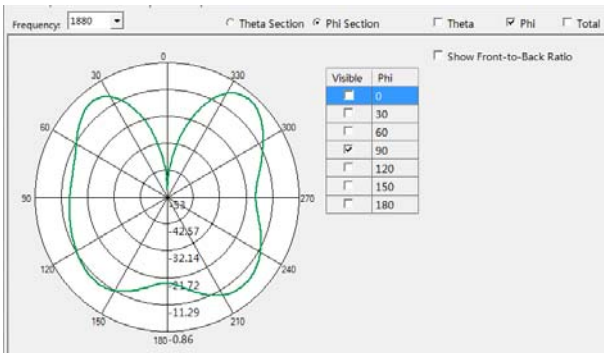

Phi=90.00deg

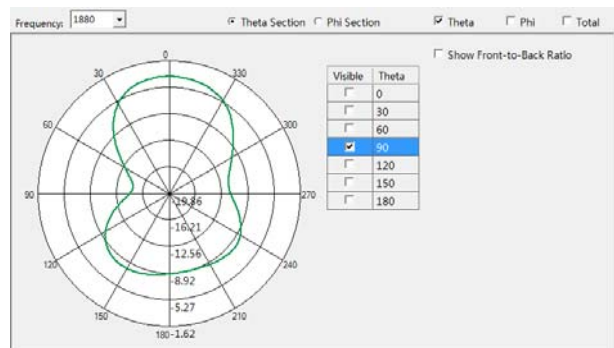

Theta=90.00deg

ANT0 Band26

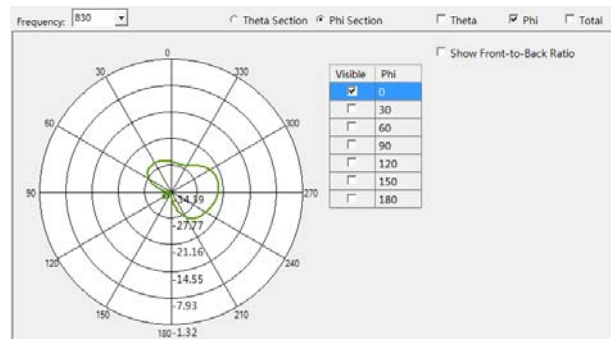
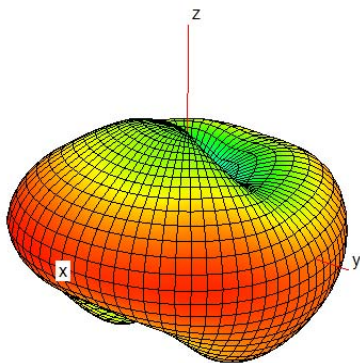

Phi=0.00deg

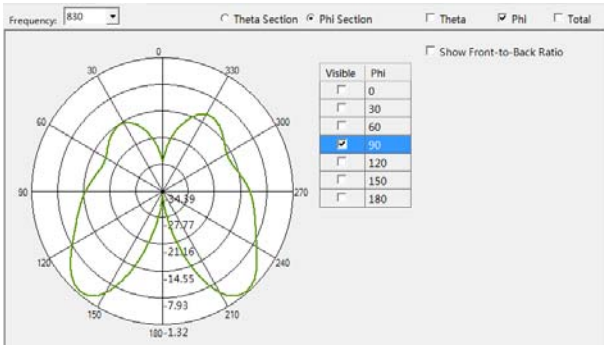

Phi=90. 00deg

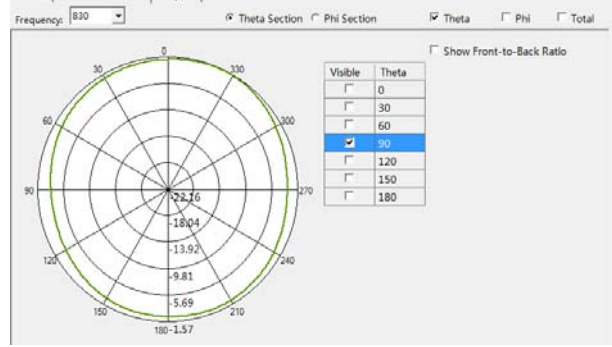

Theta=90. 00deg

ANT0 Band28

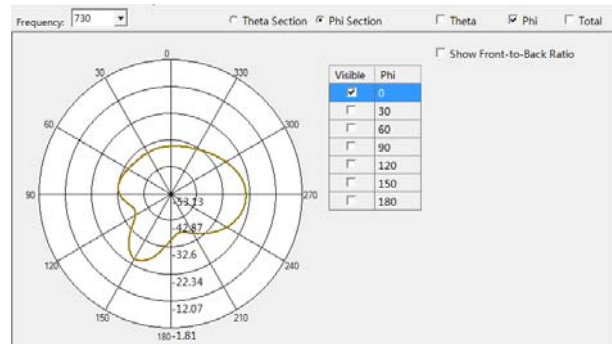
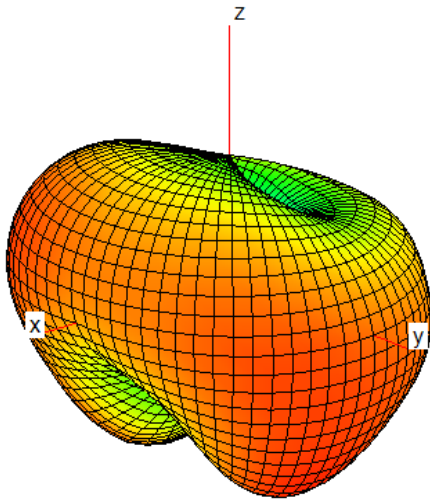

Phi=0. 00deg

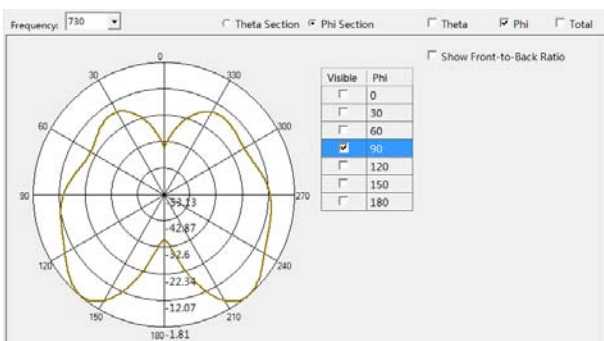

Phi=90. 00deg

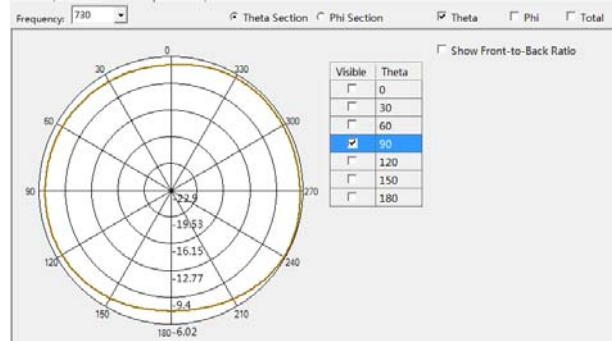

Theta=90. 00deg

ANT3 Band38

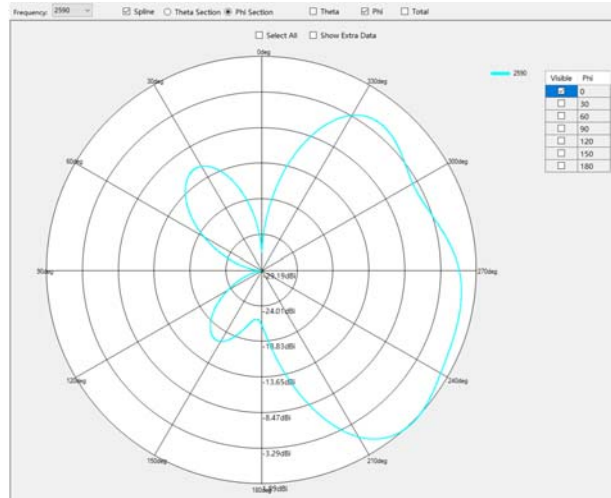
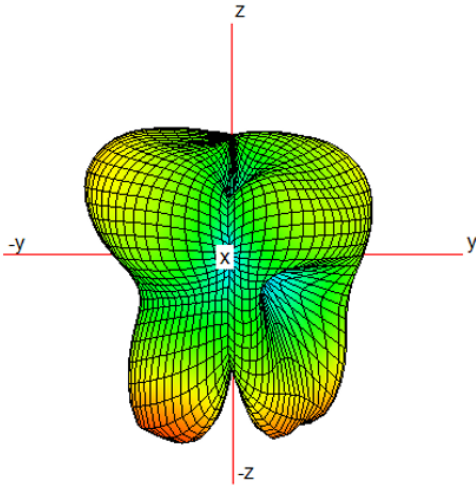

$\Phi=0.00\text{deg}$

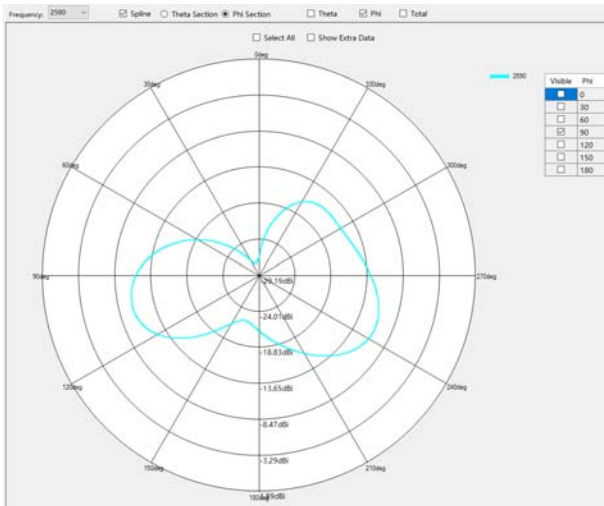

$\Phi=90.00\text{deg}$

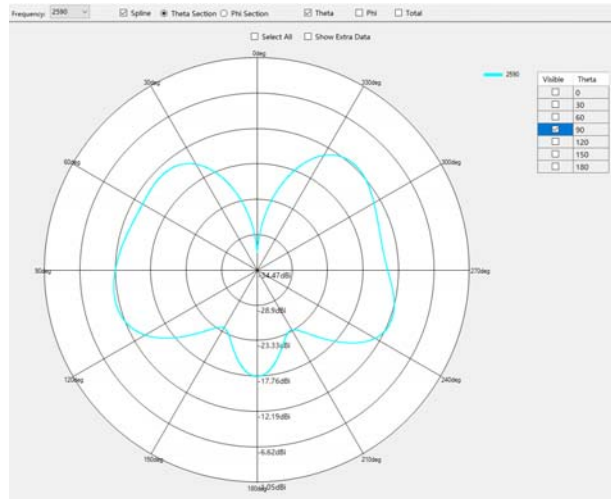

$\Theta=90.00\text{deg}$

ANT1 Band39

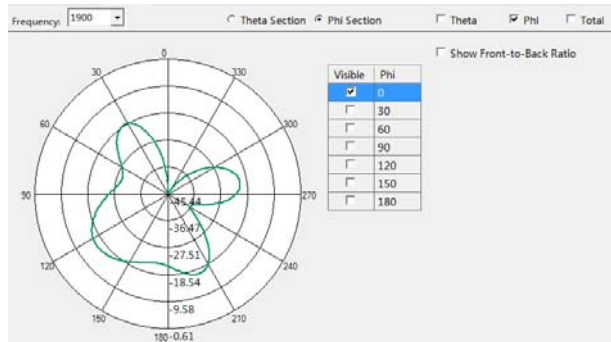
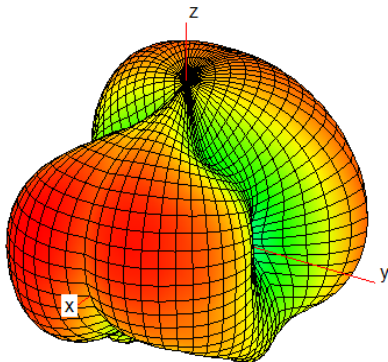

$\Phi=0.00\text{deg}$

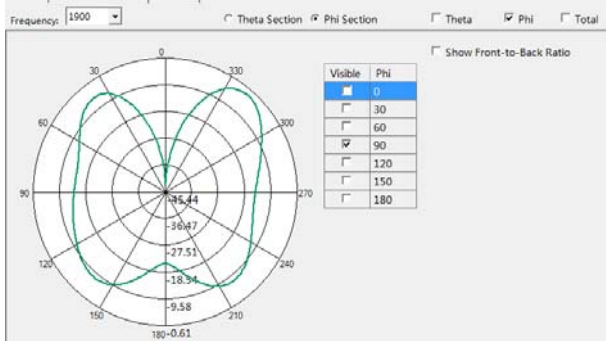

Phi=90. 00deg

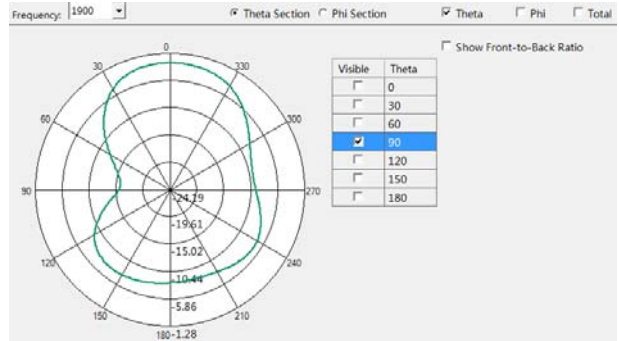

Theta=90. 00deg

ANT3 Band40

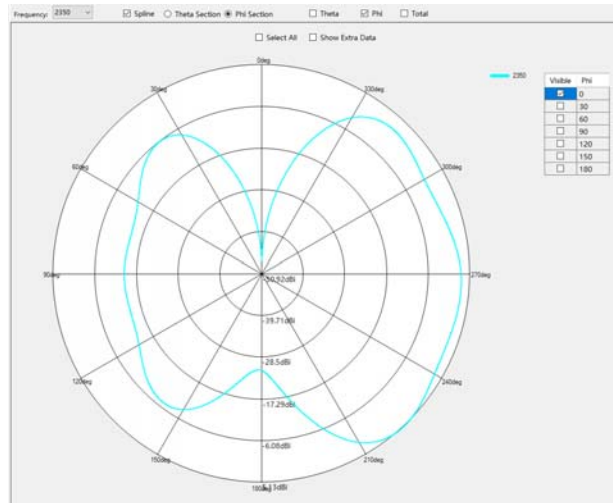
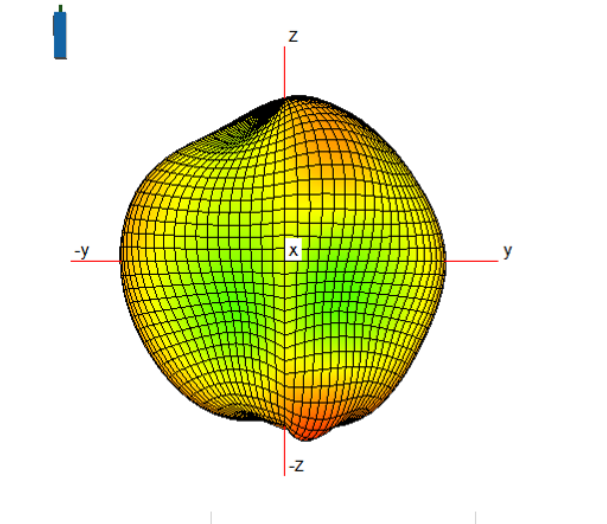

Phi=0. 00deg

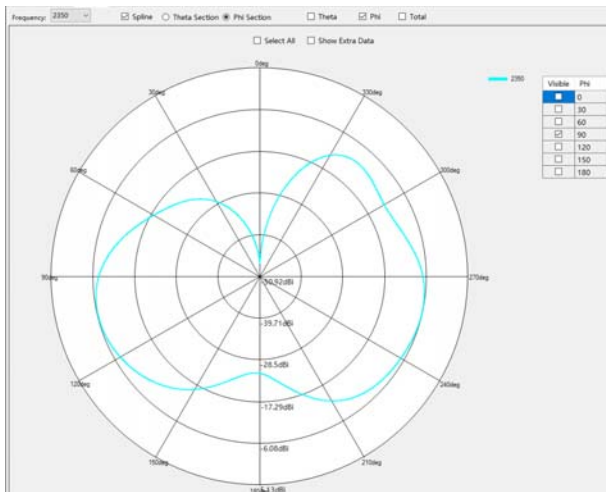

Phi=90. 00deg

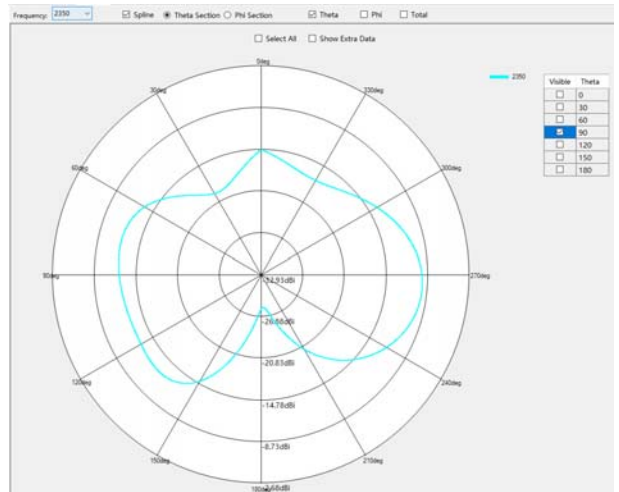

Theta=90. 00deg

ANT3 Band41

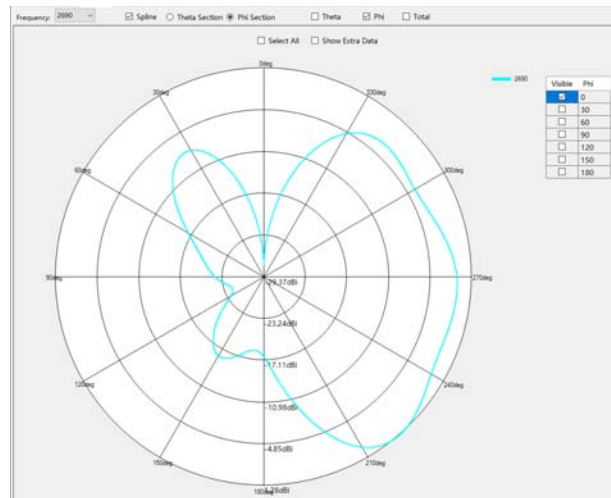
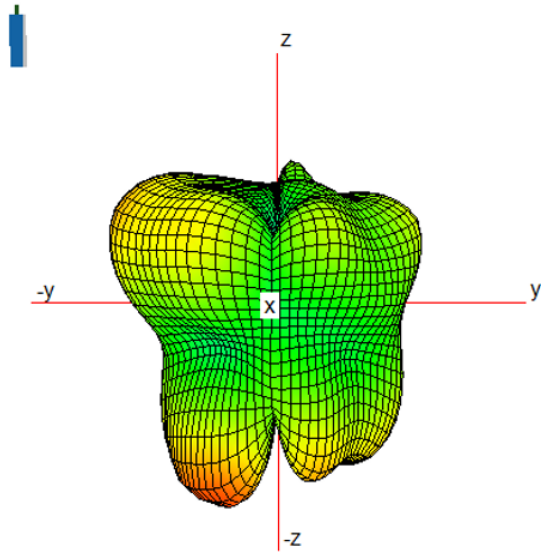

$\Phi=0.00\text{deg}$

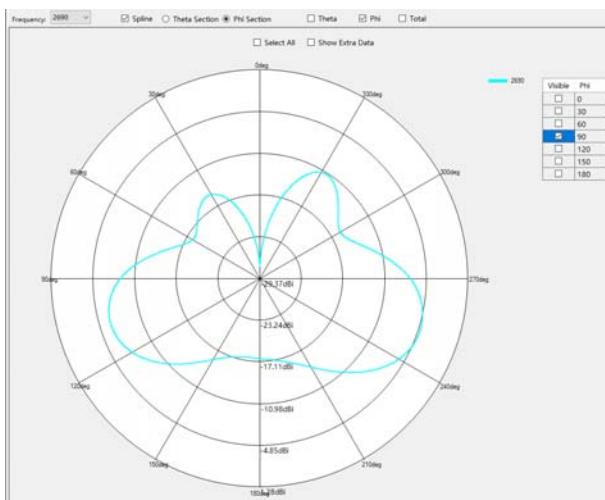

$\Phi=90.00\text{deg}$

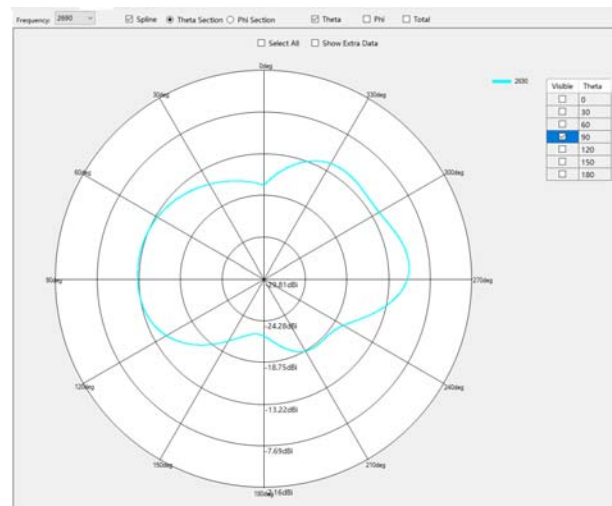

$\Theta=90.00\text{deg}$

ANT1 Band66

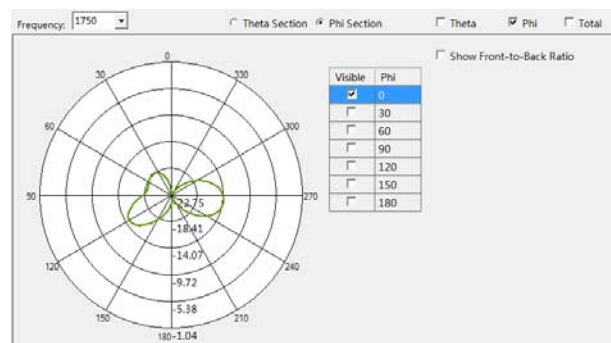
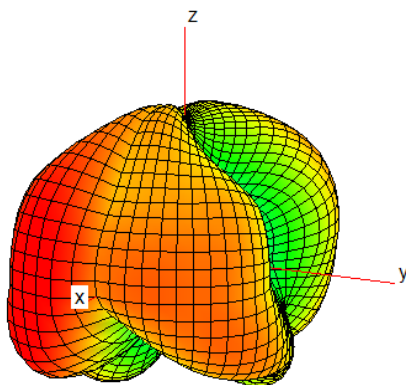

$\Phi=0.00\text{deg}$

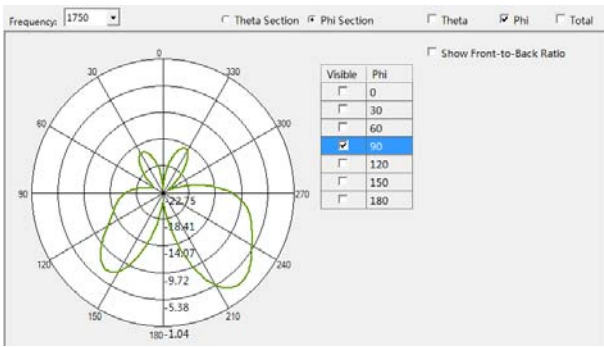

Phi=90.00deg

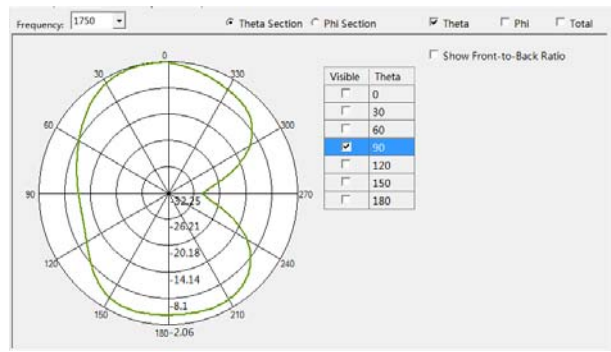

Theta=90.00deg

ANT0 Band71

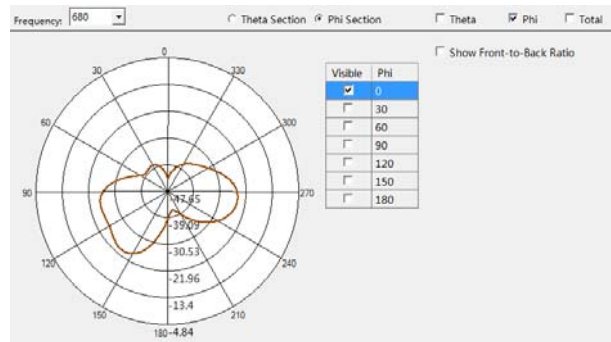
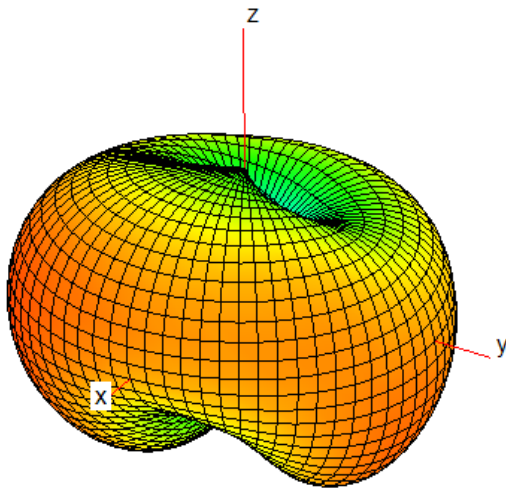

Phi=0.00deg

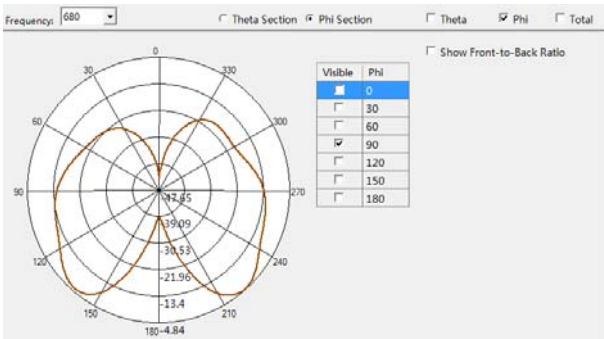

Phi=90.00deg

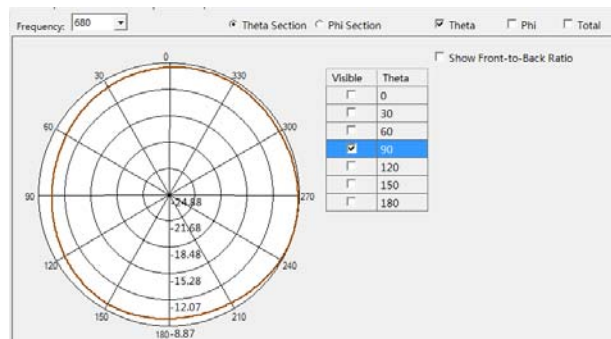

Theta=90.00deg

ANT4 Band77

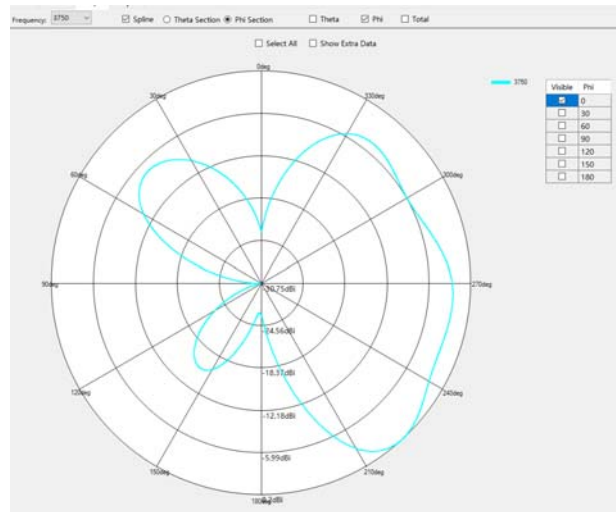
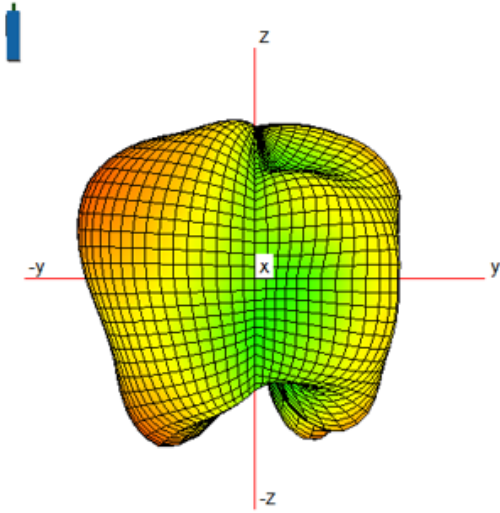

Phi=0.00deg

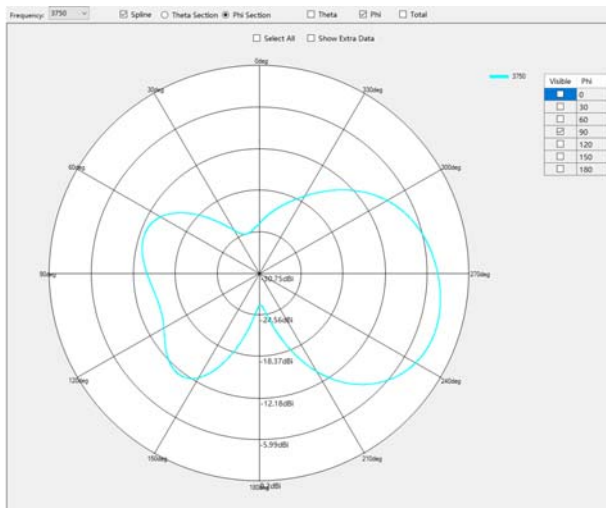

Phi=90.00deg

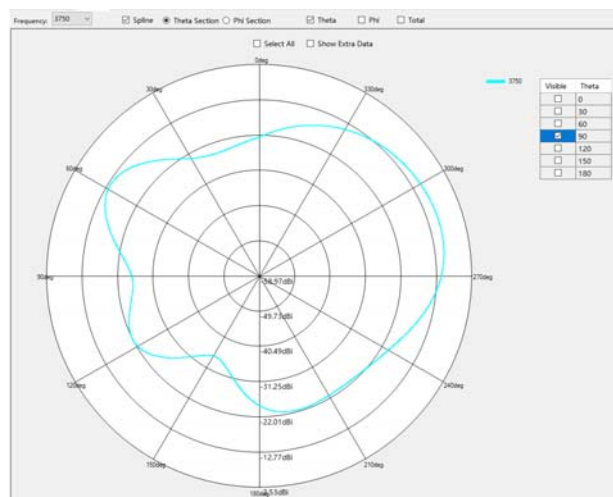

Theta=90.00deg

5.3 ANT2

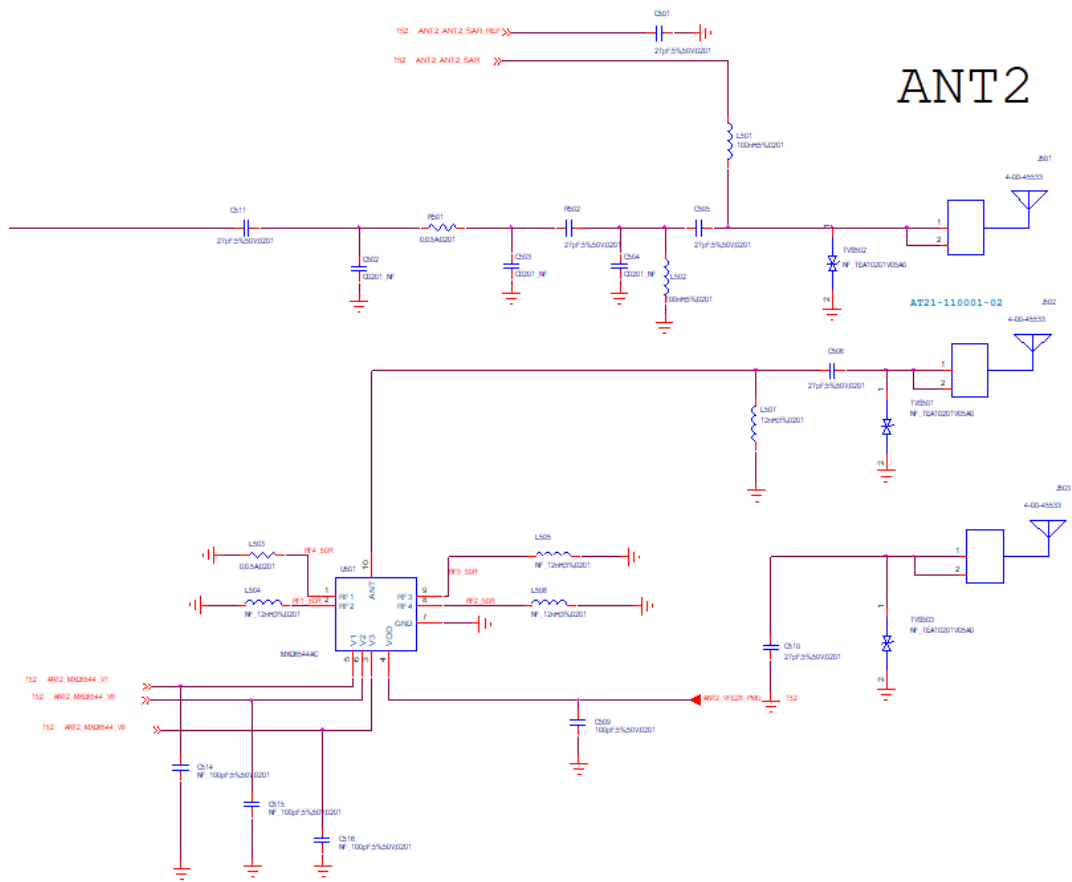

5.4 ANT3

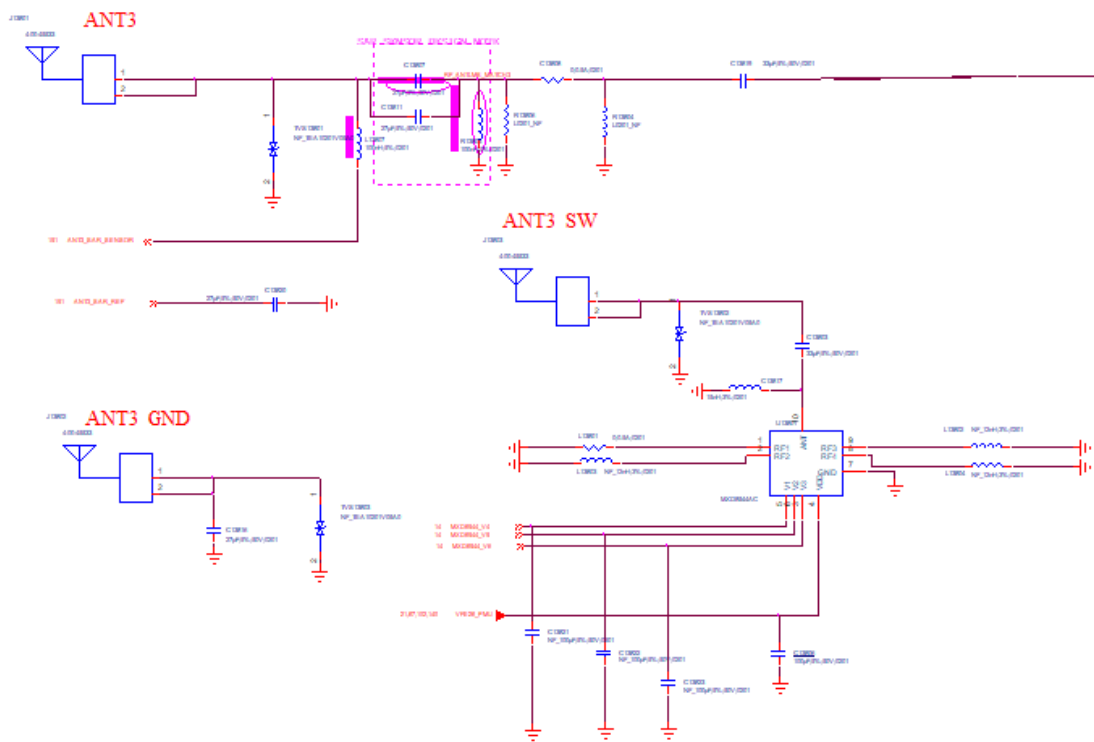

5.5 ANT4

ANT4 FEED

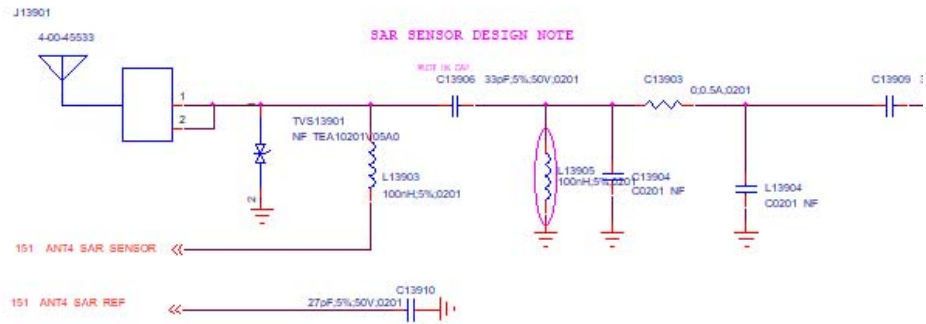

ANT4 GND

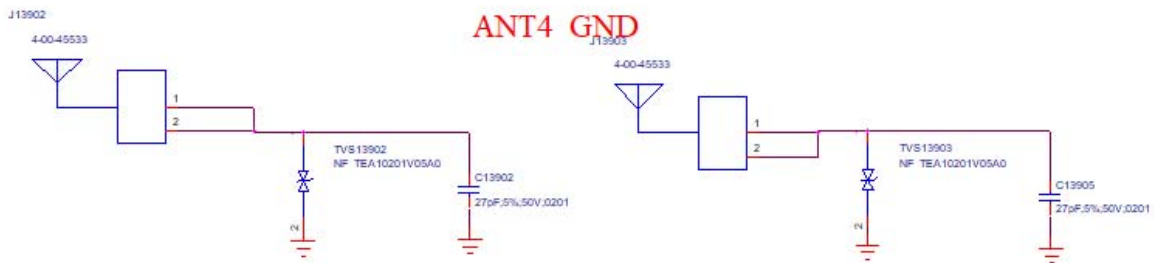

5.6 ANT5

ANT5 WIFI/GPS

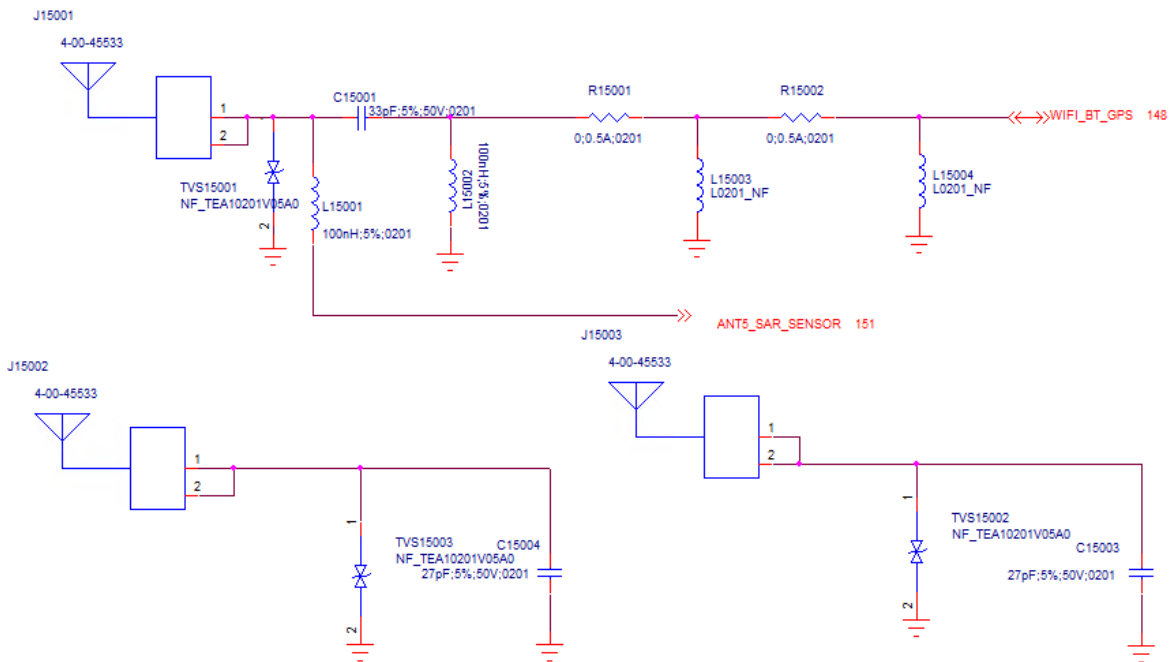

5.7 ANT6

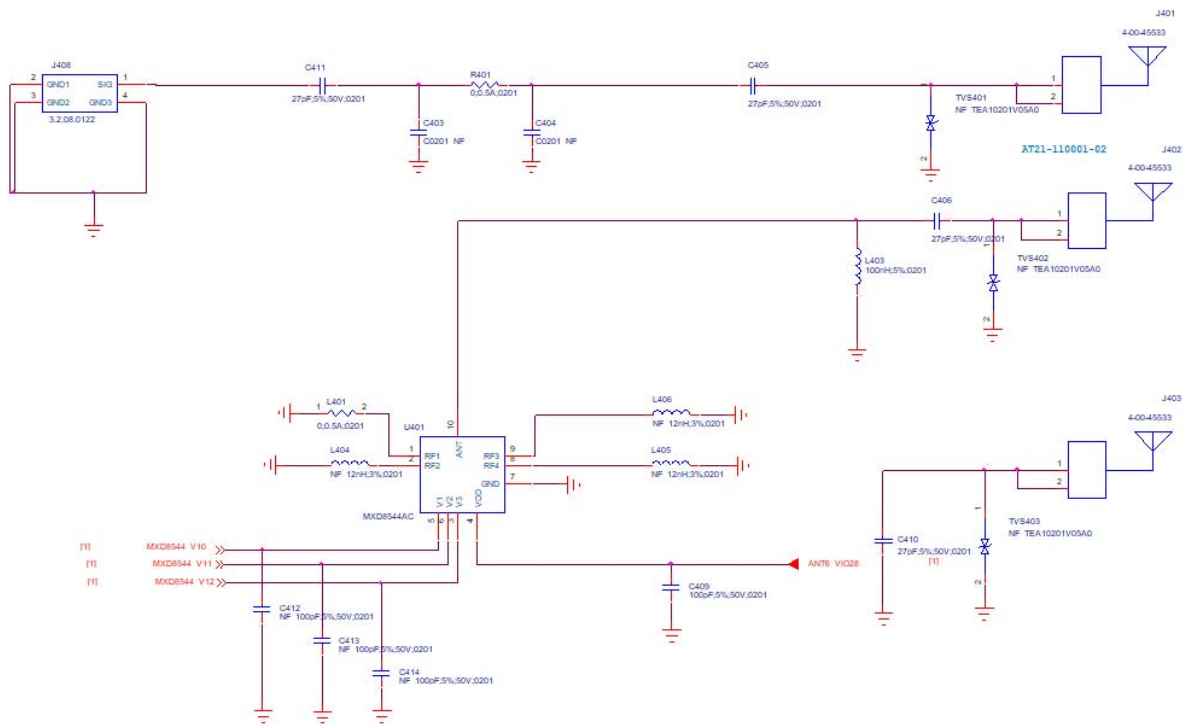

6. ElectricalGraph(Returnloss)

6.1 ANT0 Return loss

E5071C Network Analyzer

1 Active Ch/Trace 2 Response 3 Stimulus 4 Mkr/Analysis 5 Instr State

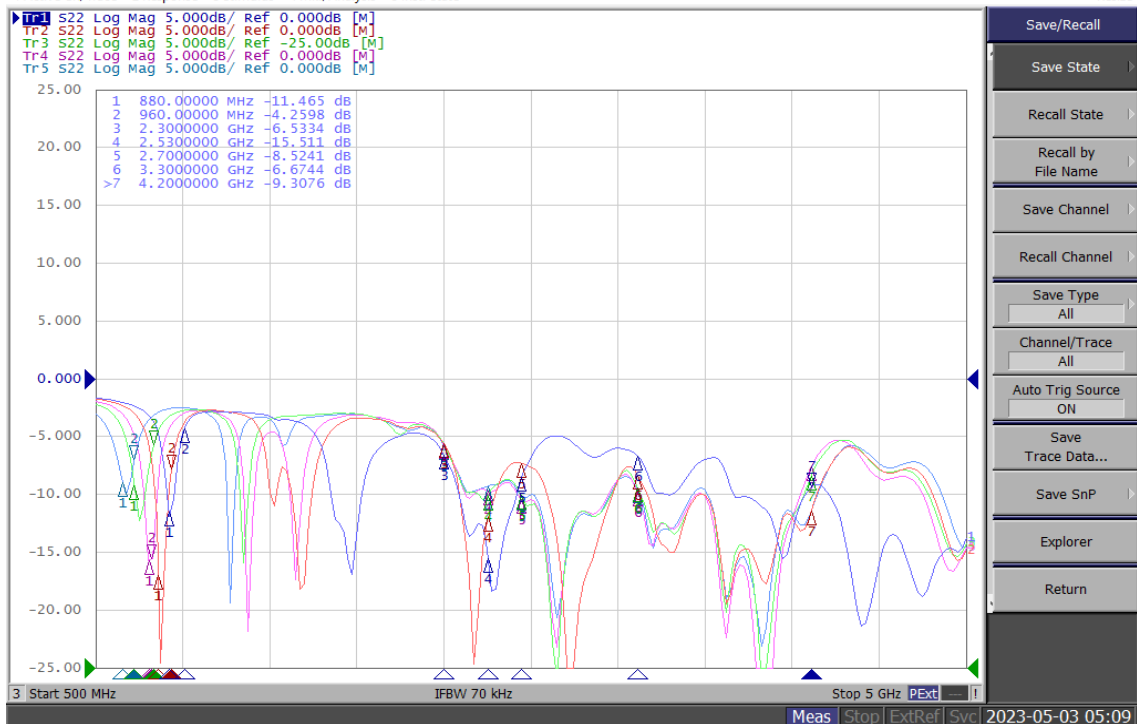

6.2 ANT1 Return loss



6.3 ANT2 Return loss

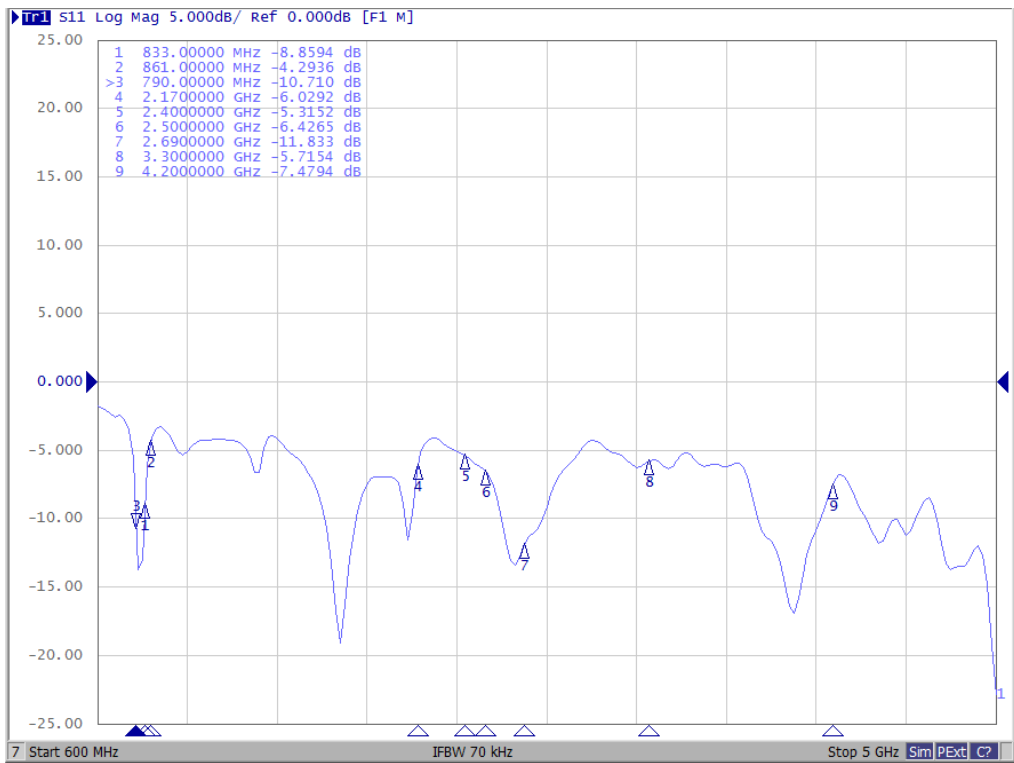

6.4 ANT3 Return loss

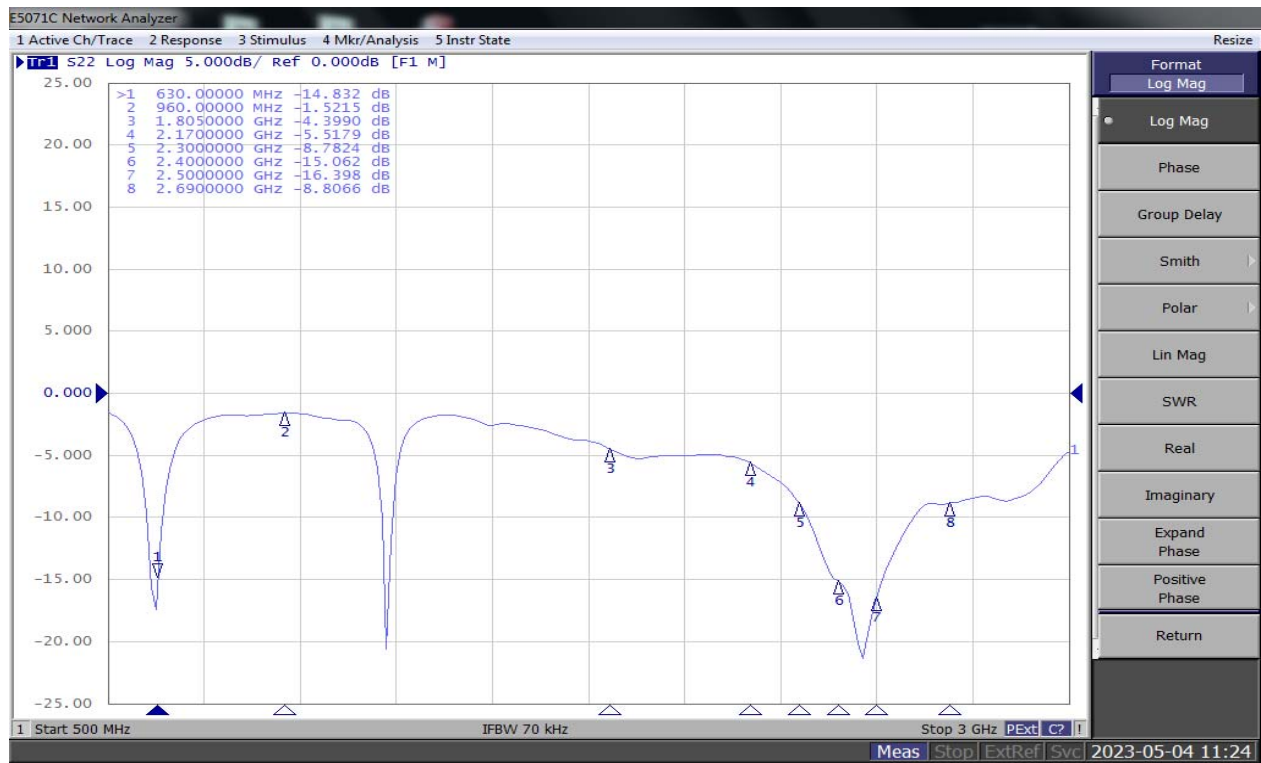

6.5 ANT4 Return loss

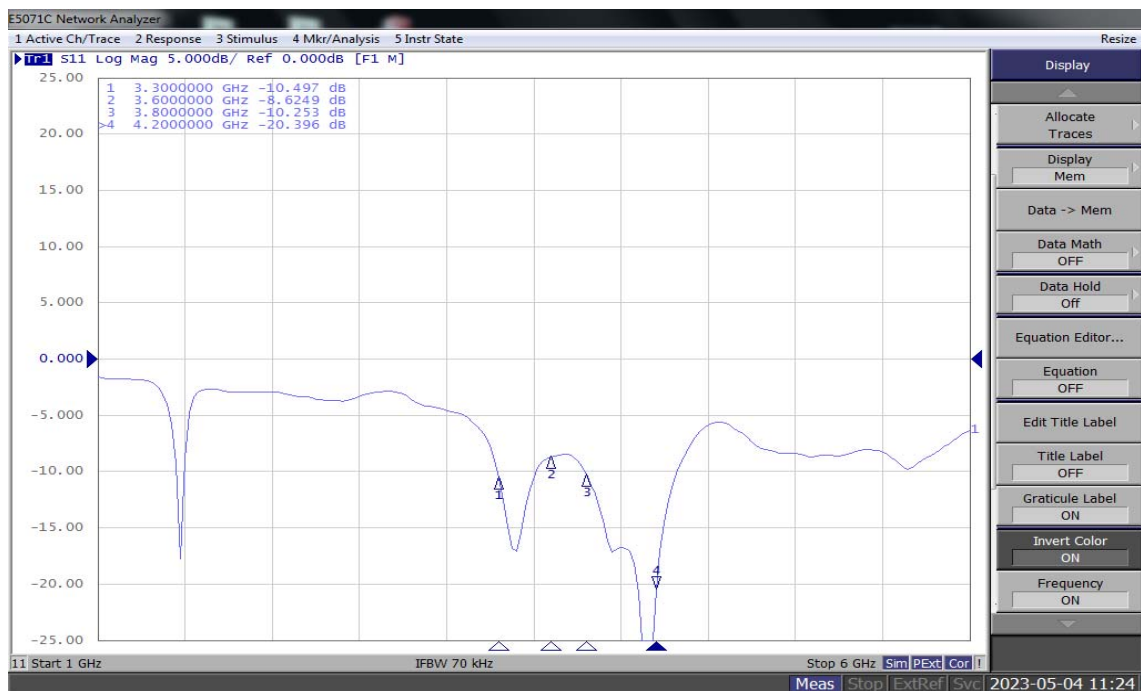

6.6 ANT5 Return loss

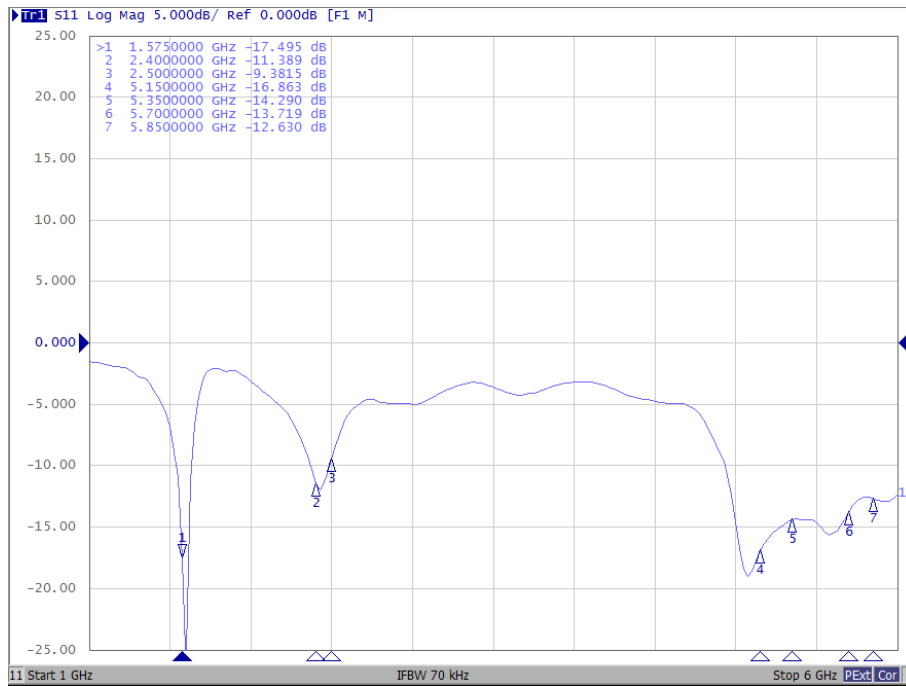

6.7 ANT6 Return loss

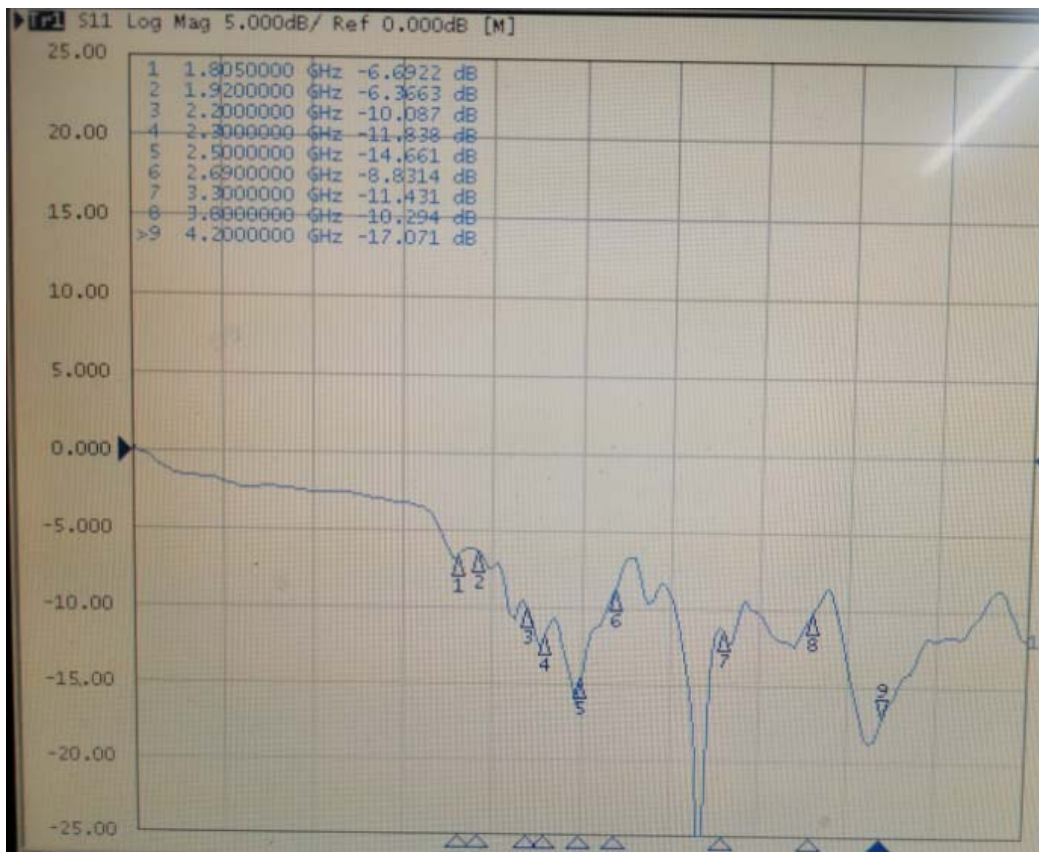

7. External Drawing

7.1 ANT0

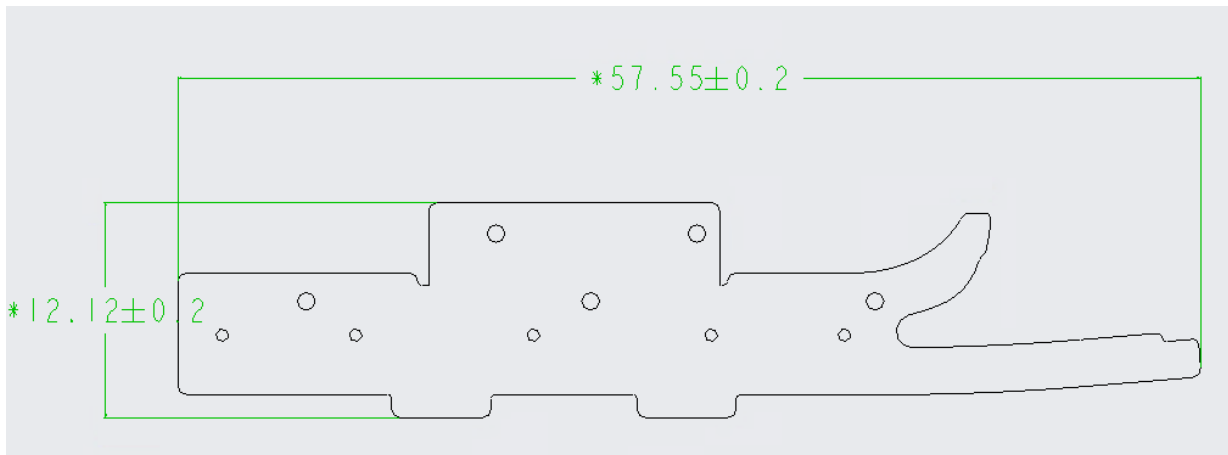

Length: 57.55 mm
Width: 12.12mm

7.2 ANT1

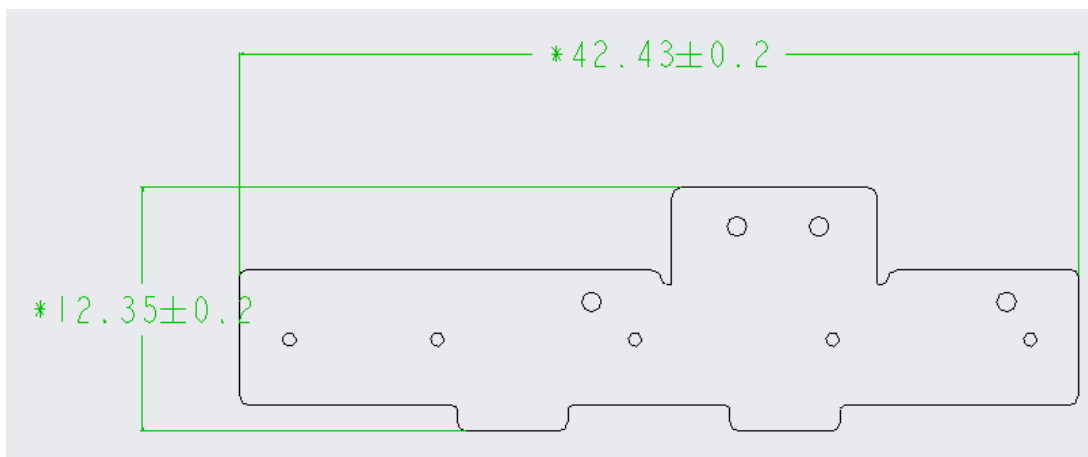

Length: 42.43mm
Width: 12.35mm

7.3 ANT2

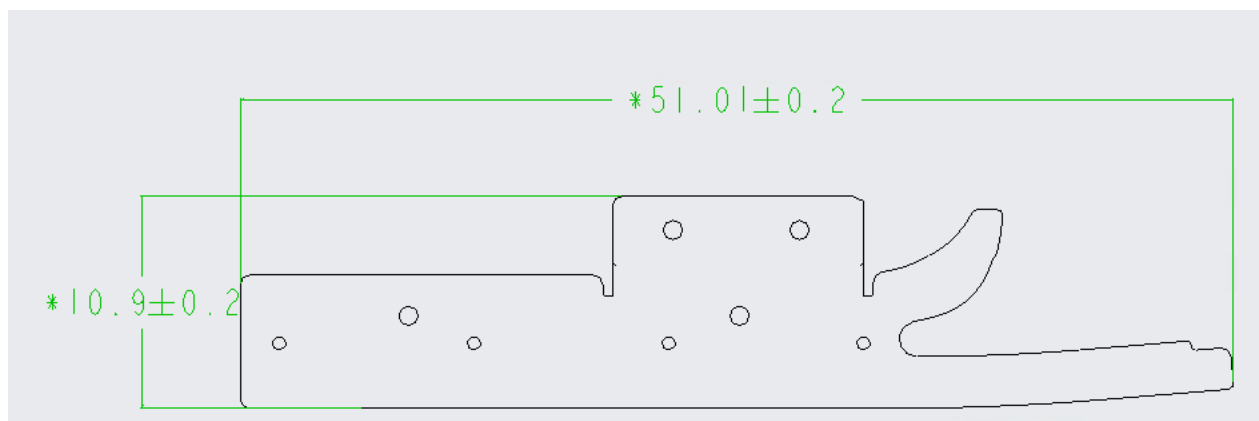

Length: 51.01mm
Width: 10.09mm

7.4 ANT3

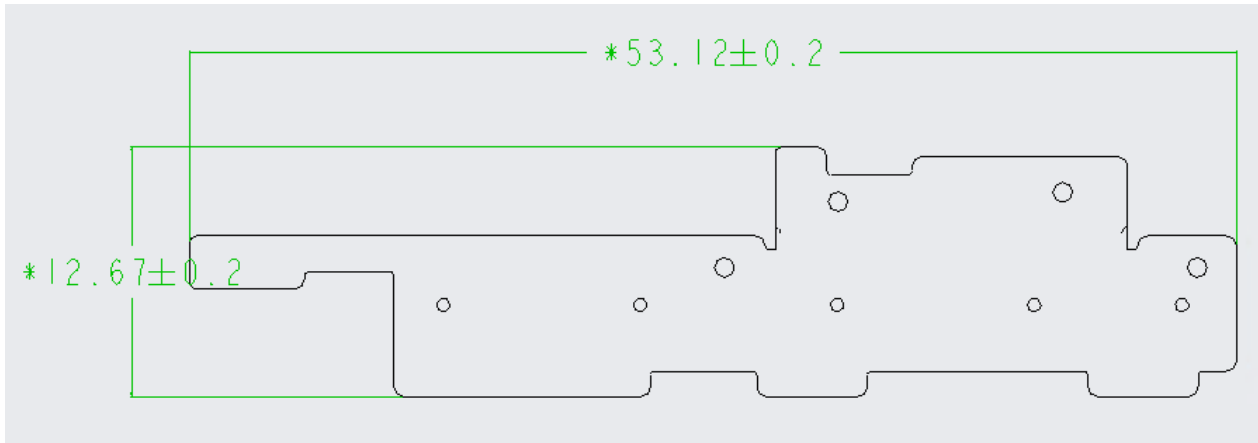

Length: 53.12mm
Width: 12.67mm

7.5 ANT4

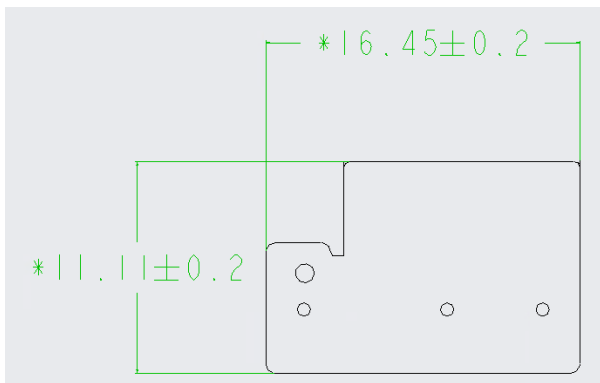

Length: 16.45mm
Width: 11.11mm

7.6 ANT5

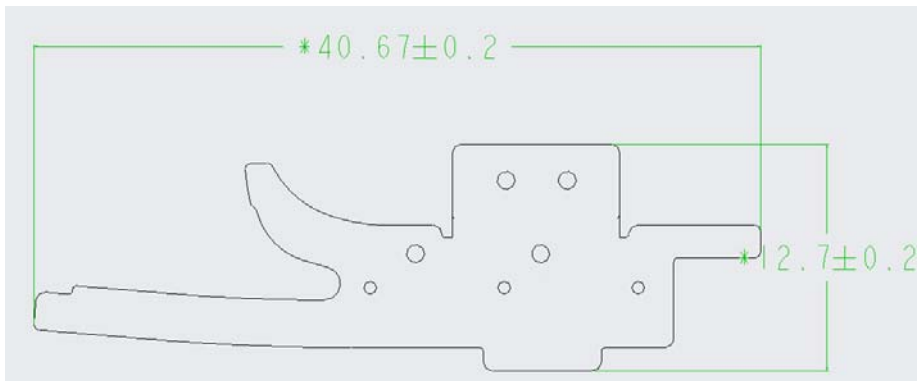

Length: 40.67mm
Width: 12.7mm

7.7 ANT6

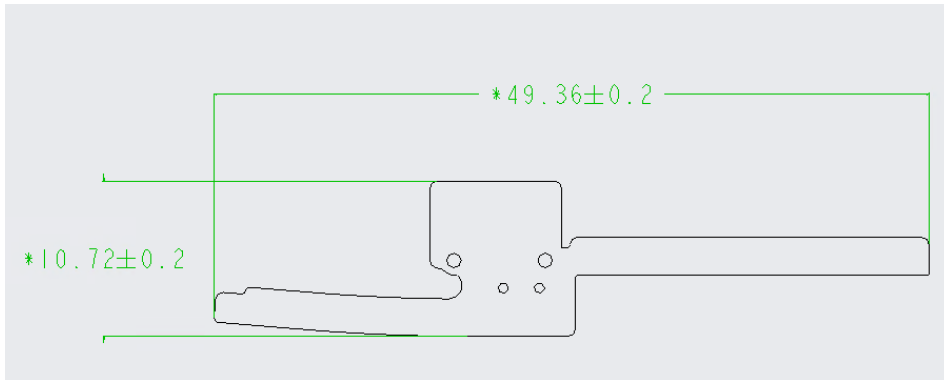

Length: 49.36mm
Width: 10.72mm