

APPROVAL SPECIFICATION

Product : Internal Antenna

Model Name : TMRV075G

Date : 2024.03.11

Table of Contents

	Page
1. Manufacturer -----	3
2. Model Name -----	3
3. Antenna Type -----	3
4. Electrical Performance Data -----	3
5. Matching circuit -----	13
6. Electrical Graph(VSWR/Return loss)-----	15
7. External Drawing -----	17

1. Manufacturer

- Sunway Communication Co., Ltd.
- Huizhou Speed Wireless Technology Co. Limited

2. Model Name

- Basic Model: **TMRV075G**

3. Antenna Type

ANT	Antenna type
ANT5	FPC Antenna, IFA

4. Electric Performance Data

4.1 Specification Sheet

Band	Antenna Gain(dBi)
2.4G WIFI	-1.9
5G WIFI	0.1
BT	-1.9
GPS L1	-1

4.2 Antenna Pattern Drawing

ANT5 GPS(1576MHz)

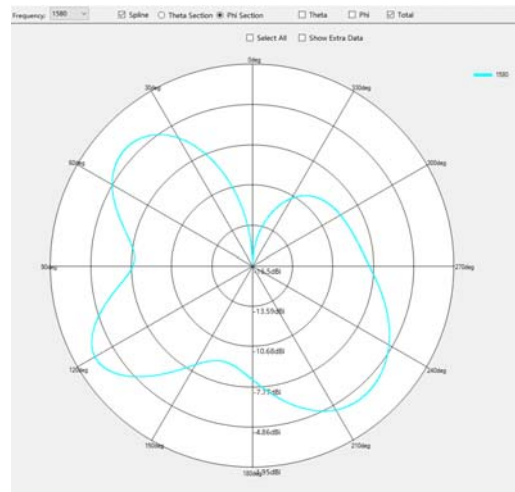
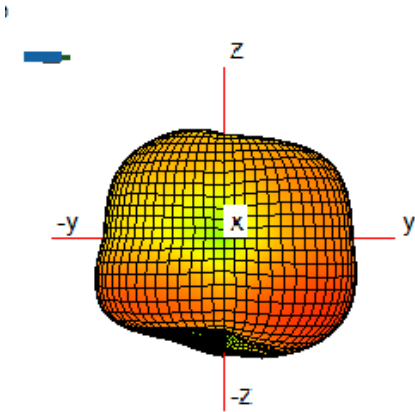

$\Phi = 0.00^\circ$

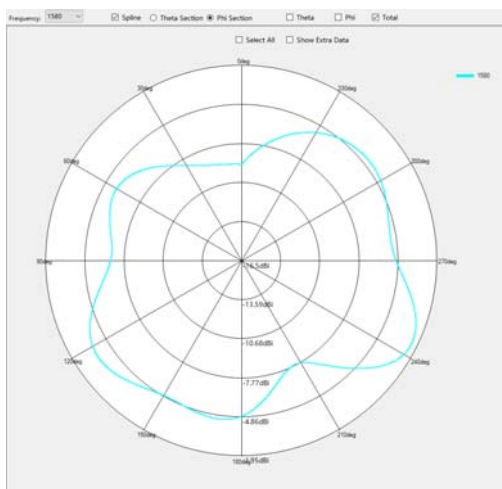

$\Phi = 90.00^\circ$

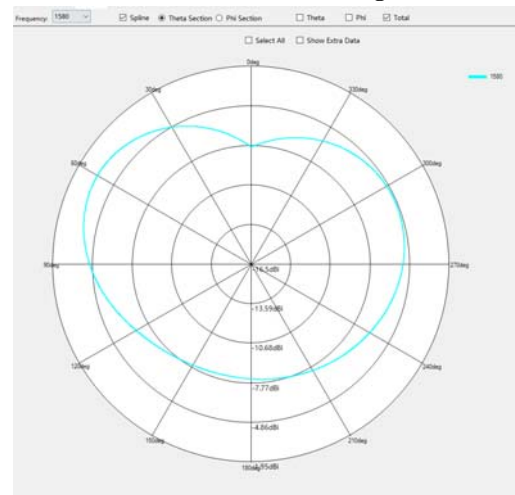

$\Theta = 90.00^\circ$

ANT5 WIFI 2.4G(2400MHz)

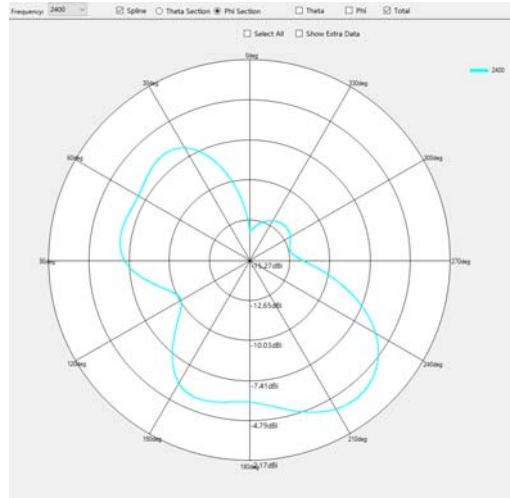
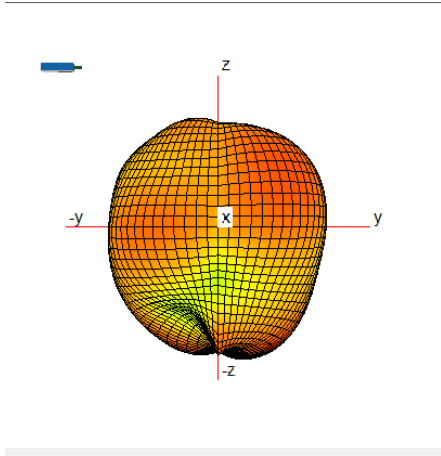

Phi=0.00deg

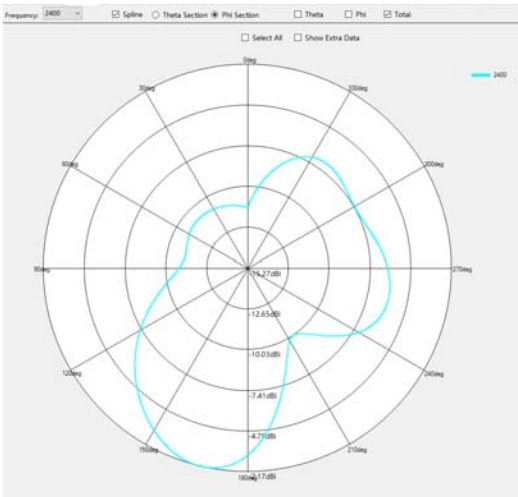

Phi=90.00deg

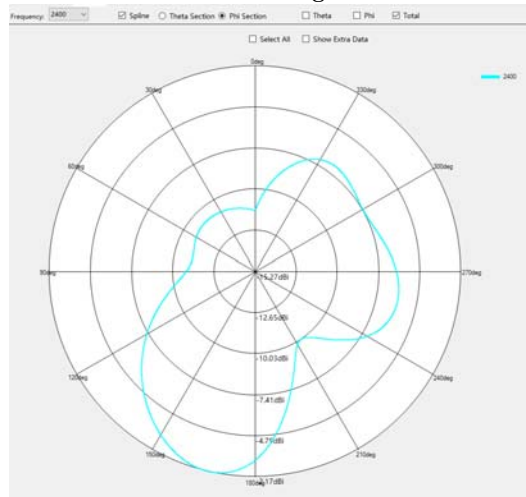

Theta=90.00deg

ANT5 WIFI 2.4G(2450MHz)

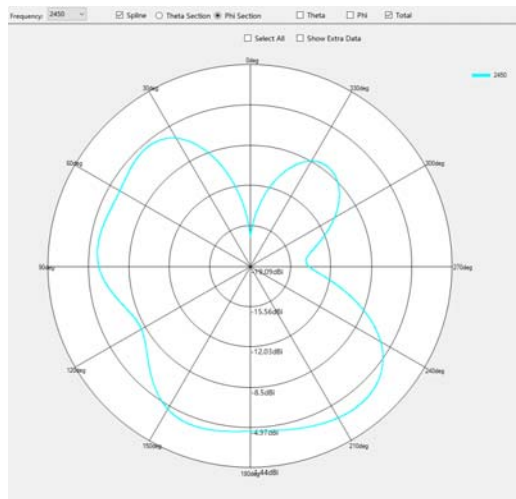
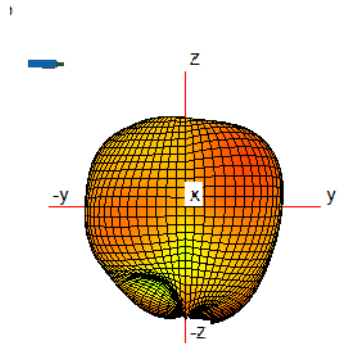

Phi=0.00deg

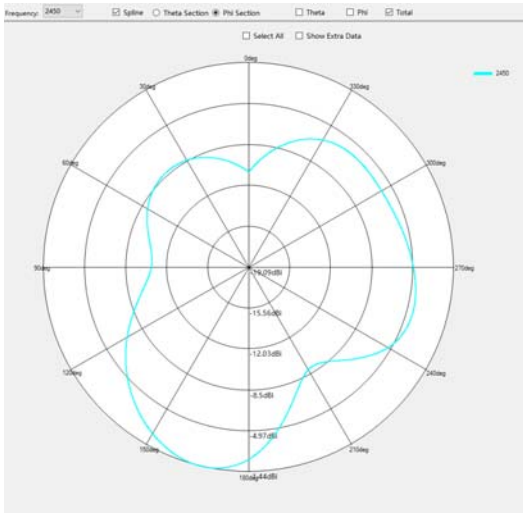

Phi=90.00deg

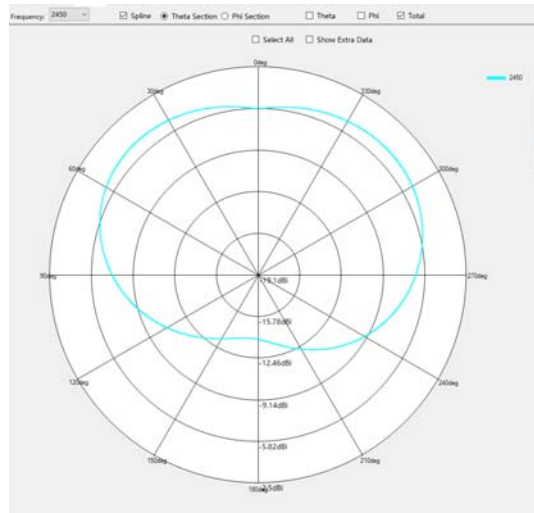

Theta=90.00deg

ANT5 WIFI 2.4G(2500MHz)

3

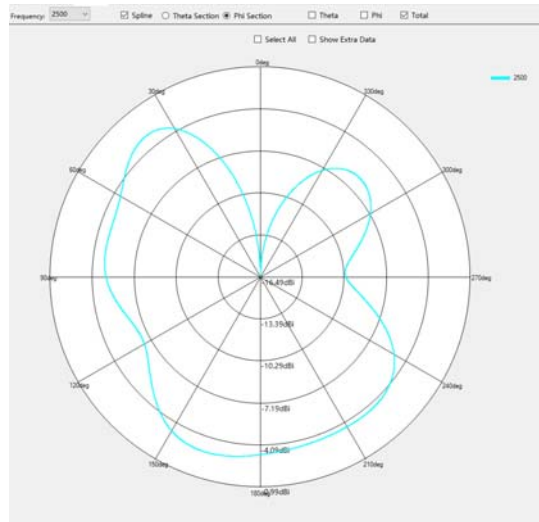
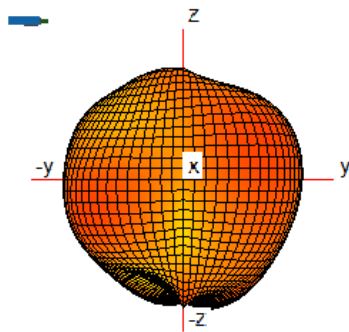

Phi=0.00deg

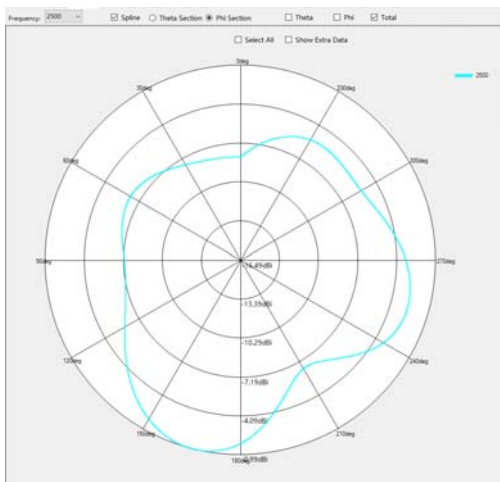

Phi=90.00deg

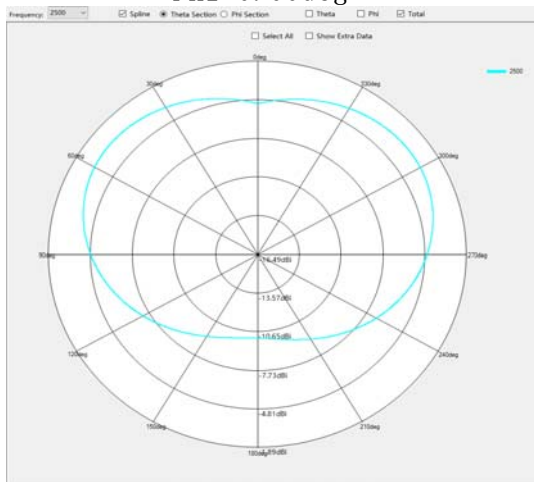

Theta=90.00deg

ANT5 WIFI 5G(5150MHz)

5

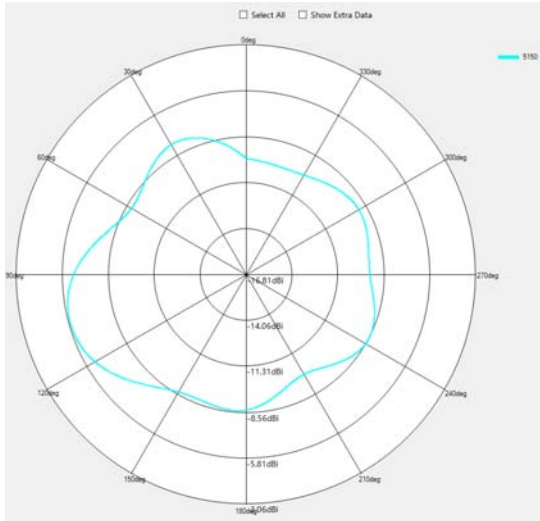
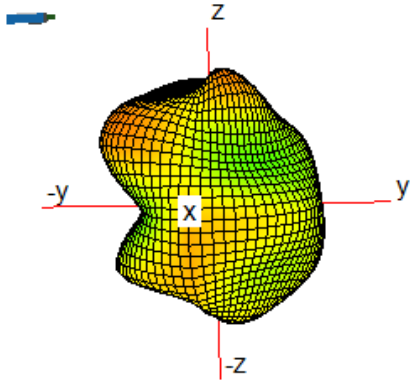

$\Phi=0.00\text{deg}$

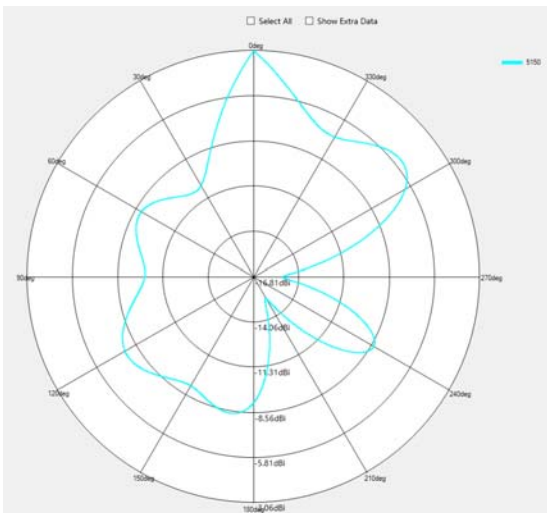

$\Phi=90.00\text{deg}$

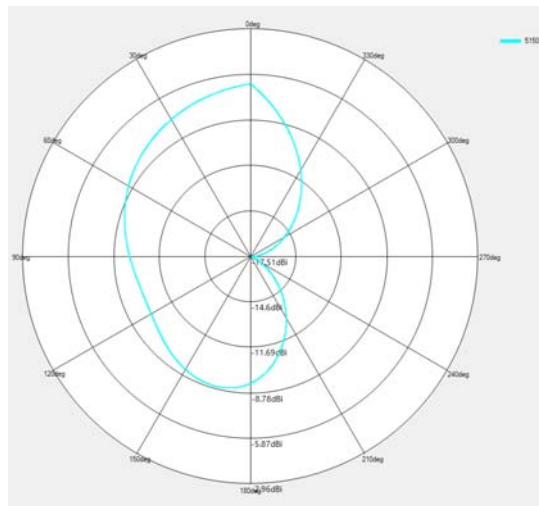

$\Theta=90.00\text{deg}$

ANT5 WIFI 5G(5350MHz)

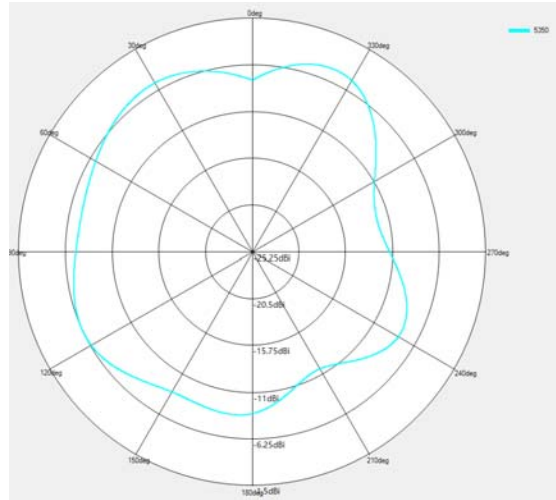
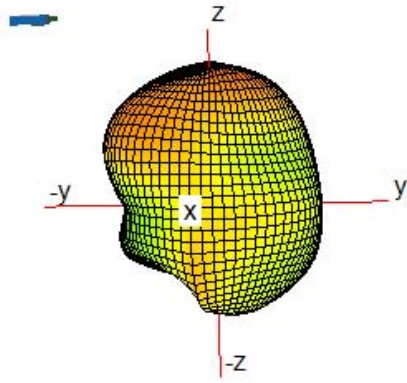

Phi=0.00deg

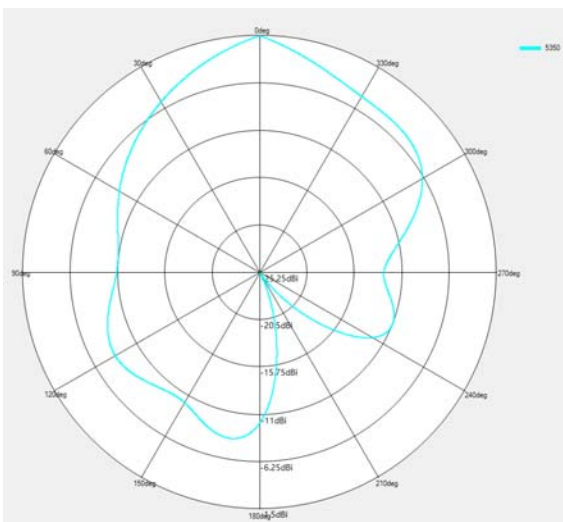

Phi=90.00deg

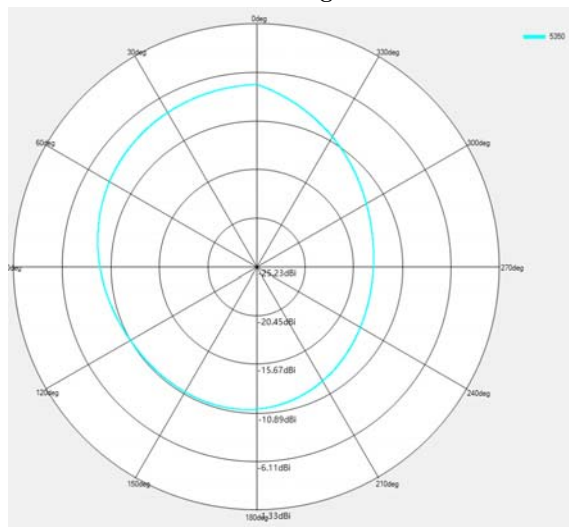

Theta=90.00deg

ANT5 WIFI 5G(5850MHz)

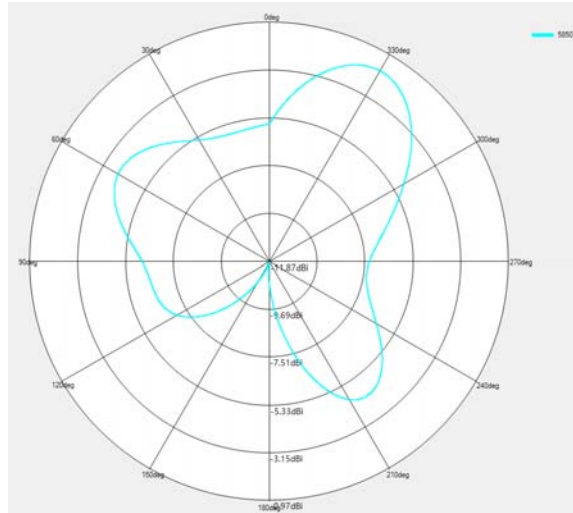
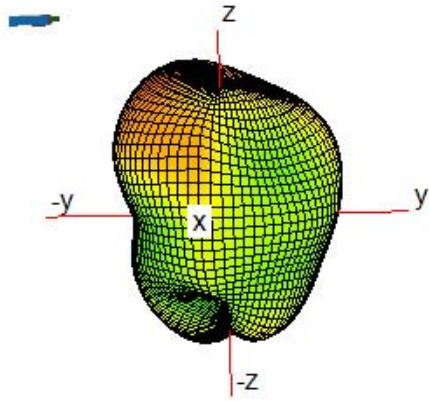

$\Phi = 0.00\text{deg}$

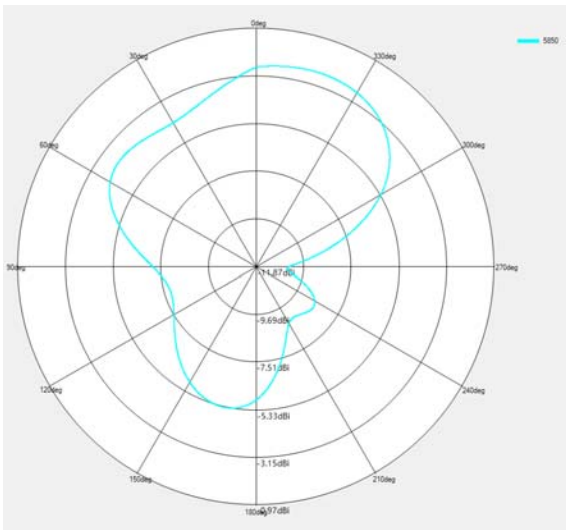

$\Phi = 90.00\text{deg}$

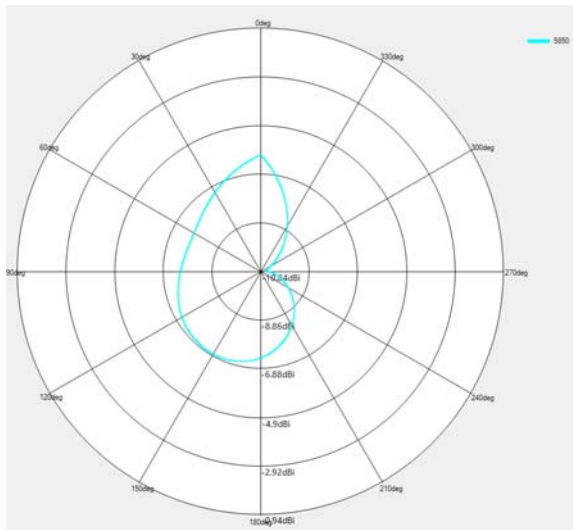

$\Theta = 90.00\text{deg}$

5. Matching circuit
ANT5

ANT5 WIFI&GPS L1

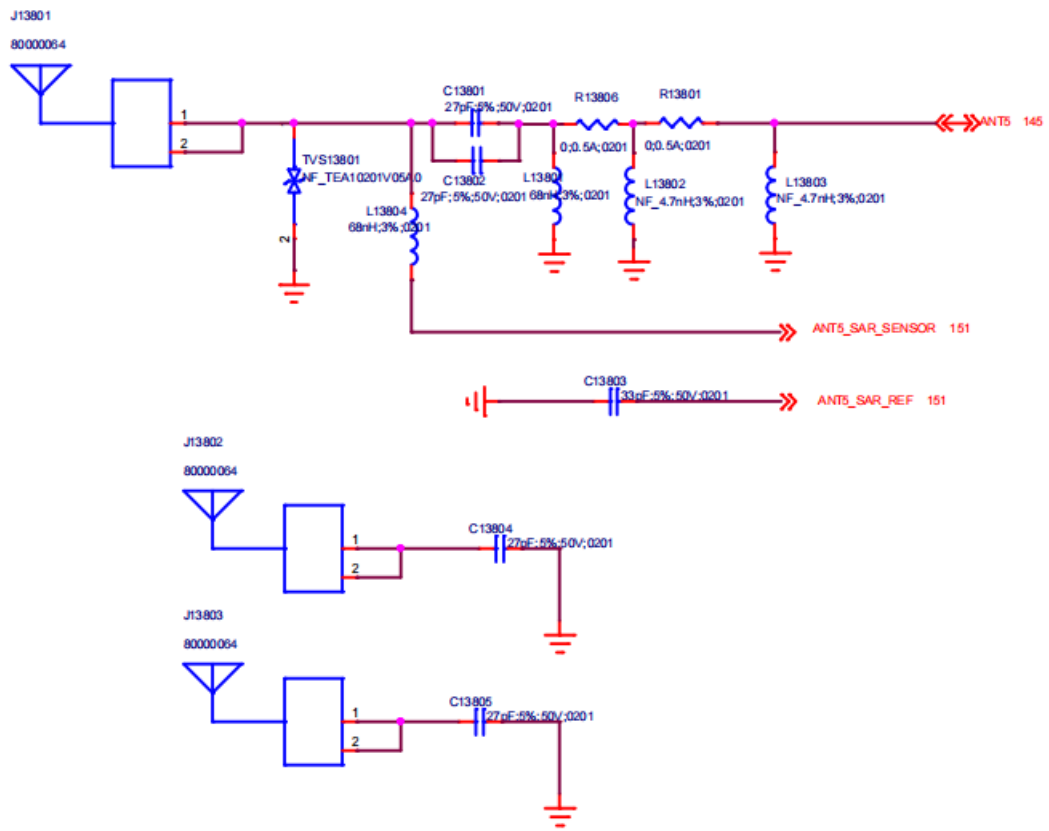

6. ElectricalGraph(Returnloss)

ANT5 Return loss

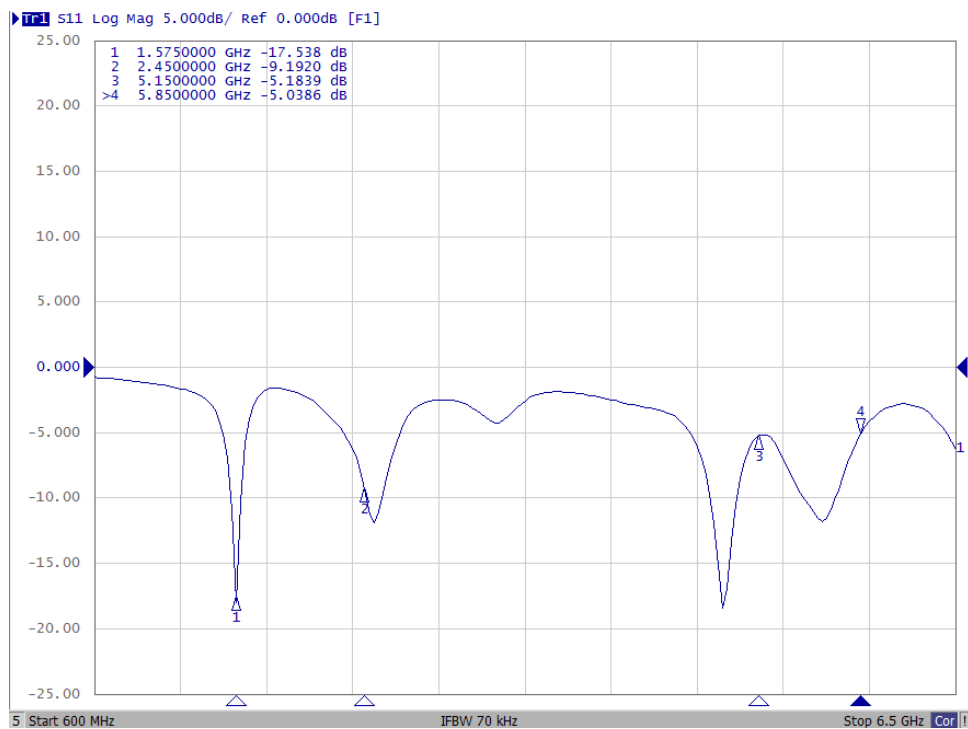

7. External Drawing

ANT4&ANT5

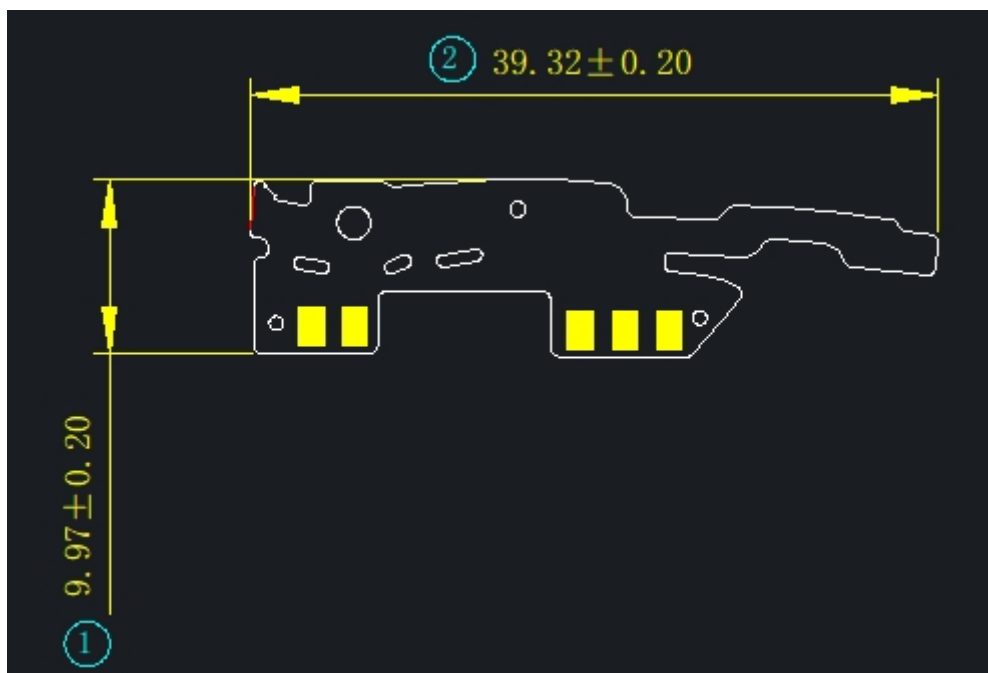

Length: 39.32mm
Width: 9.97mm