



FCC PART 15 TEST REPORT No.23T04Z80961-12

for

Wingtech Group (Hong Kong) Limited

5G Mobile Phone

TMRV075G

FCC ID:2APXW-TMRV075G

with

Hardware Version: V1.0

Software Version: TMRV075G_0.03.03

Issued Date: 2024-03-04

Note:

The test results in this test report relate only to the devices specified in this report. This report shall not be reproduced except in full without the written approval of CTTL.

Test Laboratory:

CTTL-Telecommunication Technology Labs, CAICT

No. 52, Huayuan North Road, Haidian District, Beijing, P. R. China 100191.

Tel:+86(0)10-62304633-2512, Fax:+86(0)10-62304633-2504

Email: ctl_terminals@caict.ac.cn, website: www.caict.ac.cn



REPORT HISTORY

Report Number	Revision	Description	Issue Date
23T04Z80961-12	Rev.0	1st edition	2024-03-04

Note: the latest revision of the test report supersedes all previous version.

CONTENTS

1. TEST LABORATORY	4
1.1. INTRODUCTION & ACCREDITATION	4
1.2. TESTING LOCATION	4
1.3. TESTING ENVIRONMENT	4
1.4. PROJECT DATE	4
1.5. SIGNATURE	4
2. CLIENT INFORMATION	5
2.1. APPLICANT INFORMATION	5
2.2. MANUFACTURER INFORMATION	5
3. EQUIPMENT UNDER TEST (EUT) AND ANCILLARY EQUIPMENT (AE)	6
3.1. ABOUT EUT	6
3.2. INTERNAL IDENTIFICATION OF EUT USED DURING THE TEST	6
3.3. GENERAL DESCRIPTION	6
4. REFERENCE DOCUMENTS	7
4.1. DOCUMENTS SUPPLIED BY APPLICANT	7
4.2. REFERENCE DOCUMENTS FOR TESTING	7
5. LABORATORY ENVIRONMENT	7
6. TEST RESULTS	7
6.1. SUMMARY OF TEST RESULTS	7
6.2. STATEMENTS	7
6.3. TEST CONDITIONS	8
7. TEST FACILITIES UTILIZED	8
ANNEX A: DETAILED TEST RESULTS	9
A.1. MEASUREMENT METHOD	9
A.2. CHANNEL MOVE TIME AND CHANNEL CLOSING TRANSMISSION TIME	11
A.3. NON-OCCUPANCY PERIOD	14
A3.1 ASSOCIATED TEST	14
ANNEX B: EUT PARAMETERS	15
ANNEX C: ACCREDITATION CERTIFICATE	16

1. Test Laboratory

1.1. Introduction & Accreditation

Telecommunication Technology Labs, CAICT is an ISO/IEC 17025:2017 accredited test laboratory under American Association for Laboratory Accreditation (A2LA) with lab code 7049.01, and is also an FCC accredited test laboratory (CN1349), and ISED accredited test laboratory (CAB identifier:CN0066). The detail accreditation scope can be found on A2LA website.

1.2. Testing Location

Conducted testing Location: CTTL(Huayuan North Road)

Address: No. 52, Huayuan North Road, Haidian District, Beijing,
P. R. China100191

1.3. Testing Environment

Normal Temperature: 15-35°C

Relative Humidity: 20-75%

1.4. Project date

Testing Start Date: 2023-12-27

Testing End Date: 2024-03-04

1.5. Signature



Yao Xingyu

(Prepared this test report)

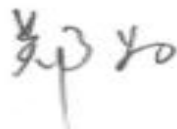

Zheng Wei

(Reviewed this test report)



Pang Shuai

(Approved this test report)



2. Client Information

2.1. Applicant Information

Company Name: Wingtech Group (Hong Kong) Limited
Address: Flat/RM 1903 19/F, Podium Plaza, 5 Hanoi Road, Tsim Sha Tsui, KL,
HK
City: Hong Kong
Postal Code: /
Country: China
Telephone: +86-21-53529900
Fax: /

2.2. Manufacturer Information

Company Name: Wingtech Group (Hong Kong) Limited
Address: Flat/RM 1903 19/F, Podium Plaza, 5 Hanoi Road, Tsim Sha Tsui, KL,
HK
City: Hong Kong
Postal Code: /
Country: China
Telephone: +86-21-53529900
Fax: /

3. Equipment Under Test (EUT) and Ancillary Equipment (AE)

3.1. About EUT

Description	5G Mobile Phone
Model name	TMRV075G
FCC ID	2APXW-TMRV075G
WLAN Frequency Band	ISM Band: -5250MHz~5350MHz -5470MHz~5725MHz
Type of modulation	OFDM
Antenna	Integral Antenna
Extreme vol. Limits	3.8V
Device Type (DFS)	Client without radar detection(only support client mode)
TPC mechanism	Not support
Antenna gain	0.1dBi
Nominal Voltage	3.87V
Extreme High Voltage	4.45V
Extreme Low Voltage	3.6V

3.2. Internal Identification of EUT used during the test

EUT ID*	IMEI	HW Version	SW Version	Date of receipt
UT30a	862503070011333/ 862503070011325	V1.0	TMRV075G_0.03.03	2023-12-29

*EUT ID: is used to identify the test sample in the lab internally.

3.3. General Description

The Equipment Under Test (EUT) is a model of 5G Mobile Phone with integrated antenna. It consists of normal options: lithium battery, charger. Manual and specifications of the EUT were provided to fulfil the test.

4. Reference Documents

4.1. Documents supplied by applicant

EUT feature information is supplied by the applicant or manufacturer, which is the basis of testing.

4.2. Reference Documents for testing

The following documents listed in this section are referred for testing.

FCC Part15	FCC CFR 47, Part 15, Subpart E: 15.407 General technical requirements.	2021
KDB 905462 D03	UNII Clients Without Radar Detection New Rules v01r02 COMPLIANCE MEASUREMENT PROCEDURES FOR UNLICENSED-NATIONAL INFORMATION	2016
KDB 905462 D02	INFRASTRUCTURE DEVICES OPERATING IN THE 5250-5350 MHz AND 5470-5725 MHz BANDS INCORPORATING DYNAMIC FREQUENCY SELECTION	2016

5. Laboratory Environment

Measurement is performed in shielding room.

6. Test Results

6.1. Summary of Test Results

SUMMARY OF MEASUREMENT RESULTS	Sub-clause of Part15E	Verdict
Channel move time and channel closing transmission time	15.407 (h)(2)(iii)	P
Non-Occupancy Period	15.407 (h)(2) (iv)	P

Please refer to **ANNEX A** for detail.

Terms used in Verdict column

P	Pass, The EUT complies with the essential requirements in the standard.
NM	Not measured, The test was not measured by CTTL
NA	Not Applicable, The test was not applicable
F	Fail, The EUT does not comply with the essential requirements in the standard

6.2. Statements

CTTL has evaluated the test cases as listed in section 6.1 of this report for the EUT specified in section 3 according to the standards or reference documents listed in section 4.

This report only deal with the UNII DFS functions among the features described in section 3, and The EUT met all requirements of the reference documents.

The end user is not available to get and modify the parameters of the detected Radar Waveforms in this product.

6.3. Test Conditions

For this report, all the test cases are tested under normal temperature and normal voltage, and also under norm humidity, the specific condition is shown as follows:

Temperature	26°C
Voltage	3.87V
Humidity	44%

7. Test Facilities Utilized

Conducted test system

No.	Equipment	Model	Serial Number	Manufacturer	Calibration Period	Calibration Due Date
1	Vector Signal Analyzer	FSQ40	200089	Rohde & Schwarz	1 year	2024-07-04
2	Vector Signal Generator	SMU200A	103752	Rohde & Schwarz	1 year	2024-07-04
3	Shielding Room	S81	/	ETS-Lindgren	/	/

ANNEX A: Detailed Test Results

A.1. Measurement Method

A.1.1. Conducted Measurements

The below figure shows the DFS setup, where the EUT is a WLAN device operating in slave mode, without Radar Interference Detection function. This setup also contains a device operating in master mode. The radar test signals are injected into the master device. The EUT (slave device) is associated with the master device. WLAN traffic is generated by streaming the mpeg file from the master to the slave in full monitor video mode using the media player.

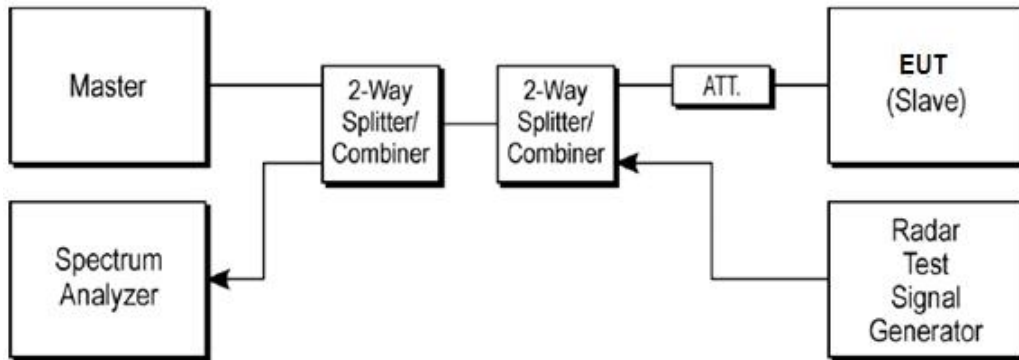

Note:

- 1) All Measurements are performed with the EUT's narrowest channel bandwidth.
- 2) The master device information is as follows
 Vendor: ASUS
 Model: GT-AXE11000
 FCC ID: MSQ-RTAXJF00
- 3) The software of radar signal generator (R&S SMU200A) is completely designed based on KDB 905462 requirement.

A.1.2. Parameters of DFS test signal

1). Interference threshold values, master or client incorporation in service monitoring. For device power less than 23dBm (E.I.R.P.), the threshold level is -62 dBm at the antenna port after correction for antenna gain and procedural adjustments.

Because of conducted measurement performed, the calibration power from radar signal generator to antenna port of DFS test equipment is -62 dBm.

Maximum Transmit Power	Value
> 200 mW	-64 dBm
< 200 mW	-62 dBm

The radar Detection Threshold, lowest antenna gain is the parameter of interference radar DFS detection threshold.

One 10 Second plot bee reported for the short Pulse Radar type 1-4 , the type 0 was be used, which was selected by auto test software.

Radar Waveform Calibration Result:

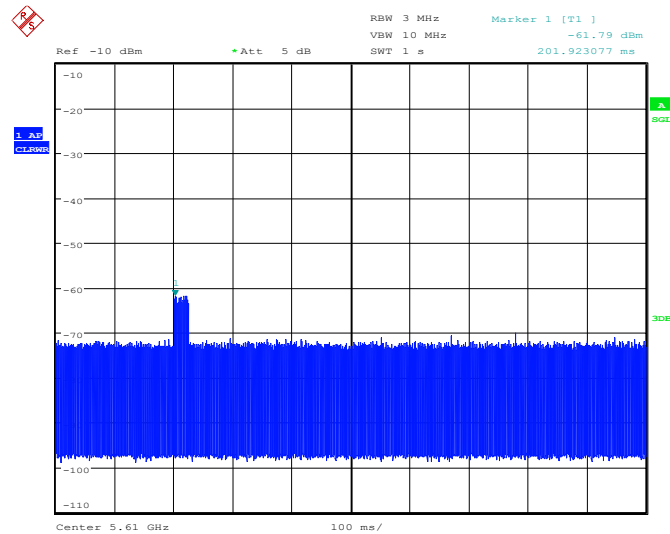

Fig.A.1 80M Calibration Result

2). DFS requirement values

The required values are as the following table.

Parameter	Value
Non-occupancy	> 1800 s
Channel Availability Check Time	60 s
Channel Move Time	10 s
Channel Closing Transmission Time	200 ms + 60 ms
U-NII Detection Bandwidth	Minimum 80% of the 99% transmission power bandwidth

As the EUT is IP based system, the MPEG video file from NTIA website is used to steam to EUT via the Master device.

A.1.3. Measurement Uncertainty

Item	Measurement Uncertainty
Time	0.70 ms
Power	0.75 dBm

A.2. Channel move time and channel closing transmission time

Measurement Limit:

Test Items	Limit
channel closing transmission time	< 200 ms + 60 ms
Channel move time	< 10 s

Measurement Results:

Frequency Band: 5250MHz ~ 5350MHz(80M-5290MHz)

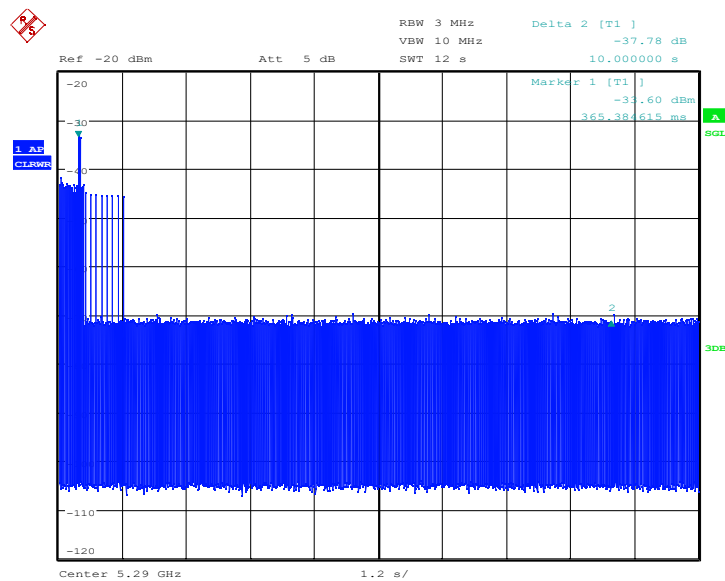

Date: 12.JAN.2024 10:00:10

Fig.A.2 Channel move time

The channel move time is as the figure. It shows the time of the radar and the client pulses. The figure shows that the client stops transmission within 10 seconds, and no transmissions occur after 10 seconds later of the radar burst signal.

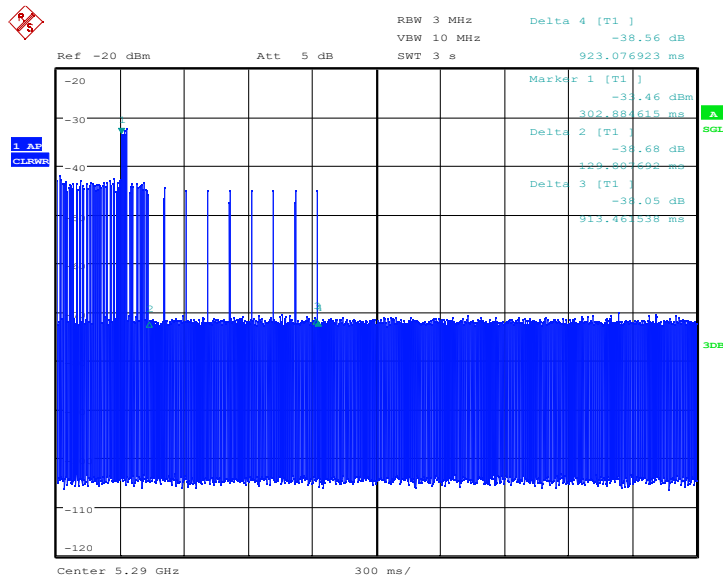

Date: 12.JAN.2024 09:55:43

Fig.A.3 channel closing transmission time

The closing transmission time is as the figure, and the result is
 $235.63\text{ms} = \text{Delta}2 + (\text{Delta}4 - \text{Delta}3) * 11$.

Conclusion: PASS

Frequency Band 5470MHz ~ 5725MHz(80M-5530MHz)

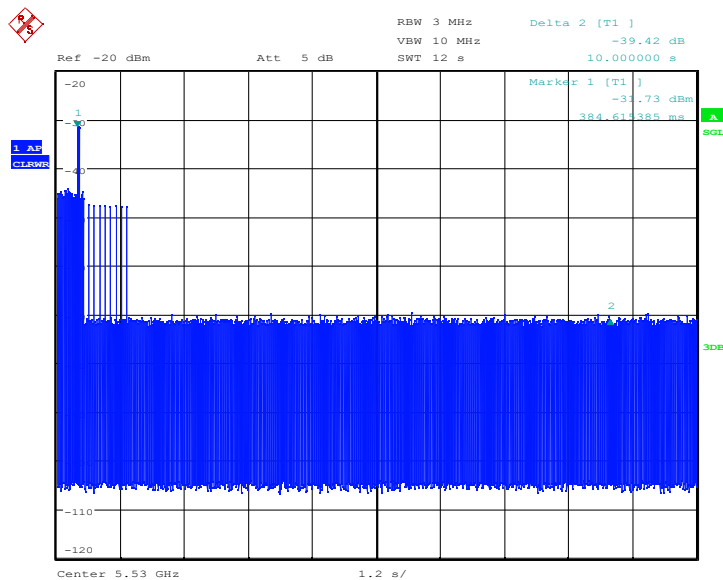

Date: 12.JAN.2024 13:43:12

Fig.A.4 Channel move time

The channel move time is as the figure. It shows the time of the radar and the client pulses. The
 ©Copyright. All rights reserved by CTTL. Page 12 of 16

figure shows that the client stops transmission within 10 seconds, and no transmissions occur after 10 seconds later of the radar burst signal.

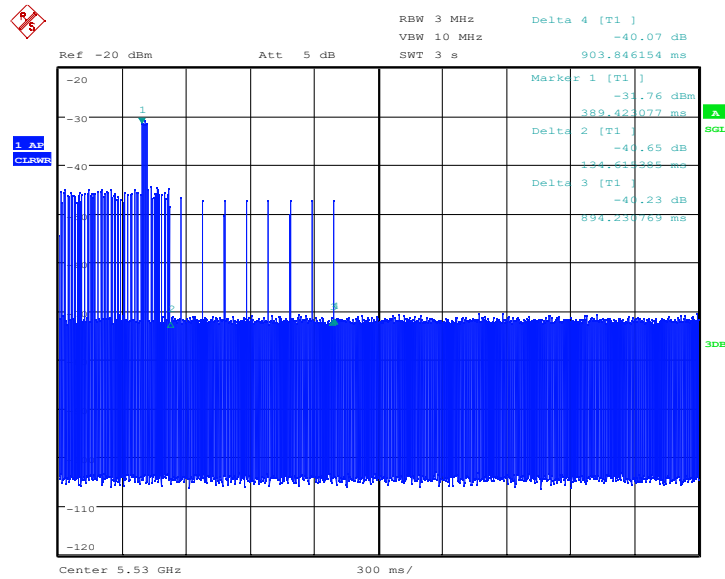

Date: 12.JAN.2024 13:35:30

Fig.A.5 channel closing transmission time

The closing transmission time is as the figure, and the result is $230.82\text{ms} = \text{Delta}2 + (\text{Delta}4 - \text{Delta}3) * 10$.

Conclusion: PASS

A.3.Non-Occupancy Period

Measurement Limit:

Test Items	Limit
Non-Occupancy Period	> 1800 s

A3.1 Associated test

Associate the master and client, transmit specified stream between the master and client; monitor the analyzer on the operating frequency to make sure no beacons have been transmitted for 1800 seconds.

Frequency Band: 5150MHz ~ 5350MHz(80M-5290MHz)

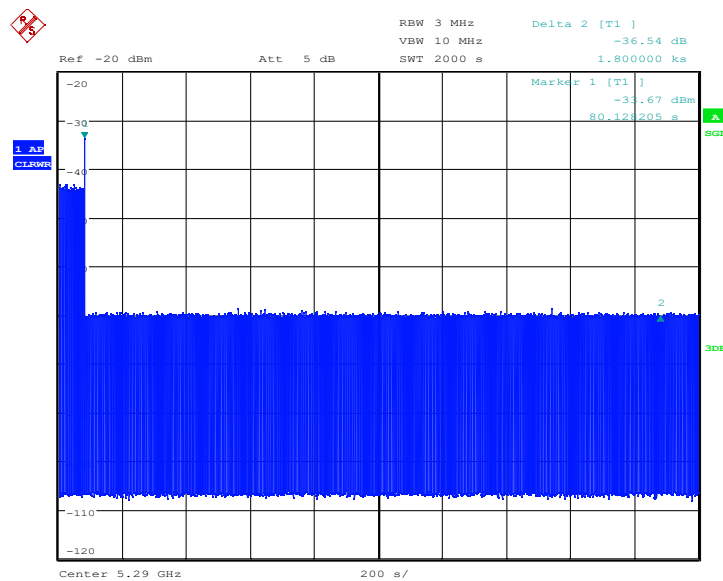

Date: 12.JAN.2024 10:56:27

Fig.A.6 Non-Occupancy Period

The figure above shows that the client does not transmit any emission within 1800 seconds after getting the order of “stop transmits” from the DFS master (access point).

Conclusion: PASS

Frequency Band: 5470MHz ~ 5725MHz

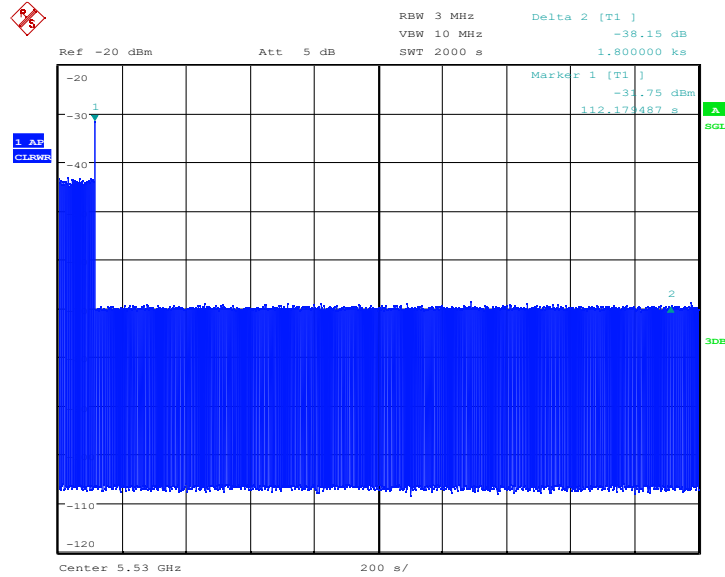

Date: 12.JAN.2024 14:29:37

Fig.A.7 Non-Occupancy Period

The figure above shows that the client does not transmit any emission within 1800 seconds after getting the order of “stop transmits” from the DFS master (access point).

Conclusion: PASS

ANNEX B: EUT parameters

Disclaimer: The antenna gain provided by the client may affect the validity of the measurement results in this report, and the client shall bear the impact and consequences arising therefrom.

ANNEX C: Accreditation Certificate



Accredited Laboratory

A2LA has accredited

TELECOMMUNICATION TECHNOLOGY LABS, CAICT

Beijing, People's Republic of China

for technical competence in the field of

Electrical Testing

This laboratory is accredited in accordance with the recognized International Standard ISO/IEC 17025:2017 *General requirements for the competence of testing and calibration laboratories*. This accreditation demonstrates technical competence for a defined scope and the operation of a laboratory quality management system (refer to joint ISO-ILAC-IAF Communiqué dated April 2017).



Presented this 26th day of June 2023.



Mr. Trace McInturf, Vice President, Accreditation Services
For the Accreditation Council
Certificate Number 7049.01
Valid to July 31, 2024

For the tests to which this accreditation applies, please refer to the laboratory's Electrical Scope of Accreditation.

*** END OF REPORT BODY ***