



NFC TEST REPORT

No.23T04Z80961-38

for

Wingtech Group (Hong Kong) Limited

5G Mobile Phone

TMRV075G

FCC ID: 2APXW-TMRV075G

with

Hardware Version: V1.0

Software Version: TMRV075G_0.03.03

Issued Date: 2024-03-11

Note:

The test results in this test report relate only to the devices specified in this report. This report shall not be reproduced except in full without the written approval of CTTL.

Test Laboratory:

CTTL-Telecommunication Technology Labs, CAICT

No. 52, Huayuan North Road, Haidian District, Beijing, P. R. China 100191.

Tel:+86(0)10-62304633-2512, Fax:+86(0)10-62304633-2504

Email: ctl_terminals@caict.ac.cn, website: www.caict.ac.cn



REPORT HISTORY

| Report Number | Revision | Description | Issue Date |
|----------------------|-----------------|-------------------------|-------------------|
| 23T04Z80961-38 | Rev.0 | 1 st edition | 2024-03-11 |

Note: the latest revision of the test report supersedes all previous version.



CONTENTS

| | |
|---|-----------|
| 1. TEST LABORATORY | 4 |
| 1.1. INTRODUCTION & ACCREDITATION..... | 4 |
| 1.2. TESTING LOCATION | 4 |
| 1.3. TESTING ENVIRONMENT | 5 |
| 1.4. PROJECT DATA | 5 |
| 1.5. SIGNATURE..... | 5 |
| 2. CLIENT INFORMATION..... | 6 |
| 2.1. APPLICANT INFORMATION..... | 6 |
| 2.2. MANUFACTURER INFORMATION..... | 6 |
| 3. EQUIPMENT UNDER TEST (EUT) AND ANCILLARY EQUIPMENT (AE) | 7 |
| 3.1. ABOUT EUT | 7 |
| 3.2. INTERNAL IDENTIFICATION OF EUT | 7 |
| 3.3. INTERNAL IDENTIFICATION OF AE | 7 |
| 3.4. EUT SET-UPS..... | 7 |
| 4. REFERENCE DOCUMENTS..... | 8 |
| 4.1. DOCUMENTS SUPPLIED BY APPLICANT | 8 |
| 4.2. REFERENCE DOCUMENTS FOR TESTING..... | 8 |
| 5. TEST RESULTS | 9 |
| 5.1. SUMMARY OF TEST RESULTS | 9 |
| 5.2. STATEMENTS..... | 9 |
| 6. TEST FACILITIES UTILIZED | 10 |
| 7. MEASUREMENT UNCERTAINTY | 11 |
| ANNEX A: EUT PARAMETERS..... | 12 |
| ANNEX B: DETAILED TEST RESULTS..... | 13 |
| ANNEX C: PERSONS INVOLVED IN THIS TESTING | 25 |
| ANNEX D: ACCREDITATION CERTIFICATE | 26 |



1. Test Laboratory

1.1. Introduction & Accreditation

Telecommunication Technology Labs, CAICT is an ISO/IEC 17025:2017 accredited test laboratory under American Association for Laboratory Accreditation (A2LA) with lab code 7049.01, and is also an FCC accredited test laboratory (CN1349), and ISED accredited test laboratory (CAB identifier:CN0066). The detail accreditation scope can be found on A2LA website.

1.2. Testing Location

Location 1: CTTL(huayuan North Road)

Address: No. 52, Huayuan North Road, Haidian District, Beijing,
P. R. China 100191

Location 2: CTTL(Cui Hu)

Address: CuiHu Cloud Center No.1 Gaolizhang Road,Wenquan
Town,Haidian District,Beijing,China

1.3. Testing Environment

| | |
|---------------------------|--------------|
| Normal Temperature: | 15-35°C |
| Extreme Temperature: | -20/+50°C |
| Normal Relative Humidity: | 20-75% |
| Normal Air Pressure | 86Kpa-106Kpa |

1.4. Project data

| | |
|---------------------|------------|
| Testing Start Date: | 2024-01-26 |
| Testing End Date: | 2024-03-01 |

1.5. Signature

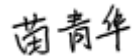

Miao Qinghua

(Prepared this test report)



Zhou Bin

(Reviewed this test report)



Pang Shuai

(Approved this test report)



2. Client Information

2.1. Applicant Information

Company Name: Wingtech Group (Hong Kong) Limited
Address: Flat/RM 1903 19/F, Podium Plaza, 5 Hanoi Road, Tsim Sha Tsui, KL, HK
Contact: sharui
Telephone: +86-21-53529900
Email: sharui@wingtech.com

2.2. Manufacturer Information

Company Name: Wingtech Group (Hong Kong) Limited
Address: Flat/RM 1903 19/F, Podium Plaza, 5 Hanoi Road, Tsim Sha Tsui, KL, HK
Contact: sharui
Telephone: +86-21-53529900
Email: sharui@wingtech.com

3. Equipment Under Test (EUT) and Ancillary Equipment (AE)

3.1. About EUT

| | |
|------------------------|---|
| Description | 5G Mobile Phone |
| Model Name | TMRV075G |
| FCC ID | 2APXW-TMRV075G |
| GSM Frequency bands | 900/1800/1900/850 |
| UMTS Frequency bands | FDD II/IV/V |
| E-UTRA Frequency bands | FDD 2/4/5/7/12/25/26/66/71 TDD 41 |
| 5G NR Frequency bands | SA n25/n41/n66/n71/n77 NSA n25/n41/n66/n71/n77 |
| Operating temperature | -10/+55°C |
| Extreme low voltage | 3.6V |
| Normal voltage | 3.87V |
| Extreme high voltage | 4.45V |

3.2. Internal Identification of EUT

| EUT ID* | SN or IMEI | HW Version | SW Version |
|---------|------------------|------------|------------------|
| UT113g | 862503070016480/ | V1.0 | TMRV075G_0.03.03 |
| | 862503070016498 | | |
| UT11a | 862503070011184/ | V1.0 | TMRV075G_0.03.03 |
| | 862503070011192 | | |

*EUT ID: is used to identify the test sample in the lab internally.

3.3. Internal Identification of AE

| AE ID* | Description | Model | Manufacture |
|--------|-------------|---------------------|-------------------------------------|
| AE1 | Battery1 | TM002 | SCUD (FUJIAN) Electronics Co., Ltd. |
| AE2 | Charger1 | / | / |
| AE3 | USB Cable1 | USB AM TO TYPE-C2.0 | Huizhou Washin Electronics Co., LTD |

*AE ID: is used to identify the ancillary equipment in the lab internally.

3.4. EUT Set-ups

| EUT set-up No. | Combination of EUT and AE | Remarks |
|----------------|-----------------------------------|---------|
| Set.NFC01 | UT11a + AE1 + AE2 + AE3+ NFC Card | Charge |
| Set.NFC02 | UT11a + AE1+ NFC card | NFC |
| Set.NFC03 | UT113g | --- |

The Transmit State of NFC: the NFC function is on. The EUT will transmit the NFC data and command continuously during the test.

The Transmit state without modulation: The EUT will transmit the CW signal at the operating

frequency.

4. Reference Documents

4.1. Documents supplied by applicant

EUT parameters, referring to Annex A for detailed information, are supplied by the client or manufacturer, which are the bases of testing.

4.2. Reference Documents for testing

The following documents listed in this section are referred for testing.

| Reference | Title | Version |
|------------------|--|----------------|
| CFR 47 Part 2 | Part 2 — Frequency Allocations and Radio Treaty Matters; General Rules and Regulations. | 2019 |
| CFR 47 Part 15 | Part 15 — Radio Frequency Devices. Subpart C — Intentional Radiators. § 15.35 Measurement detector functions and bandwidths. § 15.207 Conducted limits. § 15.209 Radiated emission limits, general requirements. § 15.215 Additional provisions to the general radiated emission limitations. § 15.225 Operation within the band 13.110–14.010 MHz. | 2019 |
| ANSI C63.10 | American National Standard of Procedures for Compliance Testing of Unlicensed Wireless Devices | 2013 |

5. Test Results

5.1. Summary of Test Results

| No | Test Cases | Clause in Regulation | Section in This Report | Verdict |
|--|--|--|------------------------|---------------|
| 1 | Electric Field Strength of Fundamental Emissions | CFR 47 § 15.225(a) | B.1 | P(Set. NFC02) |
| 2 | Electric Field Strength of Outside the Allocated Bands | CFR 47 § 15.225(b) CFR 47 § 15.225(c) | | P(Set. NFC02) |
| 3 | Electric Field Radiated Emissions | CFR 47 § 15.209 | B.2 | P(Set. NFC01) |
| | | CFR 47 § 15.225(d) | B.3 | P(Set. NFC01) |
| 4 | Frequency Tolerance | CFR 47 § 15.225(e) | B.4 | P(Set. NFC03) |
| 5 | 20dB Bandwidth | CFR 47 § 15.215(c) | B.5 | P(Set. NFC03) |
| 6 | Conducted Emissions | CFR 47 § 15.207 | B.6 | P(Set. NFC01) |
| The measurement is carried out according to ANSI C63.10. See ANNEX B for details. | | | | |

Test Conditions:

For this report, all the test cases listed above were tested under normal Temperature, Voltage, humidity and Air Pressure except the Frequency Tolerance test case. The specific conditions of Frequency Tolerance test case are listed in section B.4.3

See **Table 3** for terms for result verdict:

Table 1 Terms for result verdict

| | |
|----|---|
| P | Pass, The EUT complies with the essential requirements in the standard. |
| NP | Not Perform, The test was not performed by CTTL |
| NA | Not Applicable, The test was not applicable |
| F | Fail, The EUT does not comply with the essential requirements in the standard |

5.2. Statements

The test cases listed in Section 5.1 of this report for the EUT specified in Section 3 were performed by CTTL according to the reference documents in Section 4.

The EUT meets all applicable requirements of the regulations and standards in Section 4.2.

6. Test Facilities Utilized

| NO. | NAME | TYPE | SERIES NUMBER | PRODUCER | CAL. DUE DATE | CAL. INTERVAL |
|-----|-------------------|------------|----------------|-----------------------|---------------|---------------|
| 1. | Spectrum Analyzer | N9030A | MY49432143 | Keysight Technologies | 2024-12-16 | 1 Year |
| 2. | Climatic chamber | WK3-340/70 | 58226117510010 | WEISS | 2024-08-08 | 1 Year |
| 3. | Test Receiver | ESW44 | 103023 | R&S | 2024-07-08 | 1 Year |
| 4. | H-field Antenna | HFH2-Z2 | 829324/007 | R&S | 2026-02-05 | 2 Years |
| 5. | EMI Antenna | VULB 9163 | 01222 | SCHWARZBEC K | 2024-02-28 | 1 Year |
| 6. | Test Receiver | ESCI | 100344 | R&S | 2024-03-20 | 1 Year |

※Note: The EMI Antenna with series number of 01222 did not exceed the CAL.DUE.DATE when used.

7. Measurement Uncertainty

| Item | Uncertainty |
|---------------------------------|----------------------------|
| Frequency Tolerance | $U = 74 \text{ Hz}, k=2$ |
| 20dB Bandwidth | $U = 74 \text{ Hz}, k=2$ |
| Radiated Emissions(9kHz-30MHz) | $U = 4.92 \text{ dB}, k=2$ |
| Radiated Emissions (30MHz-1GHz) | $U = 4.72 \text{ dB}, k=2$ |
| Radiated Emissions (>1GHz) | $U = 4.84 \text{ dB}, k=2$ |
| Conducted emission | $U = 3.08 \text{ dB}, k=2$ |



ANNEX A: EUT parameters

/

ANNEX B: Detailed Test Results

B.1. Electric Field Strength of Fundamental and Outside the Allocated bands

B.1.1. Reference

See Clause 4, Clause 5 of ANSI C63.10-2013 generally.

B.1.2. Measurement Methods

The transmitter carrier output levels (E-Field) from the EUT are measured in a semi-anechoic chamber. The EUT is placed on a non-conductive stand of 80cm high, and at a measurement distance of 3m from the receiving antenna. The center of the receiving loop antenna is 1.0 meter above the ground. The E-field is measured with a shielded loop antenna connected to a measurement receiver. Detected E-field was maximized by rotating the EUT through 360° and adjusting the receiving antenna polarizations. The maximization processes were repeated with the EUT positioned respectively in its three orthogonal axes. The measurements were performed with the peak detector and if required, the quasi-peak detector.

The measurement bandwidth is:

Table B-1: Measurement bandwidth

| Frequency of Emission (MHz) | RBW/VBW |
|-----------------------------|-----------|
| 12.56-14.56 | 10/30 kHz |

The E-field measured at 3m is calculated as:

$$\text{E-field (dB}\mu\text{V/m)} = \text{Rx (dB}\mu\text{V)} + \text{Cable Loss (dB)} + \text{AF@3m (dB/m)}$$

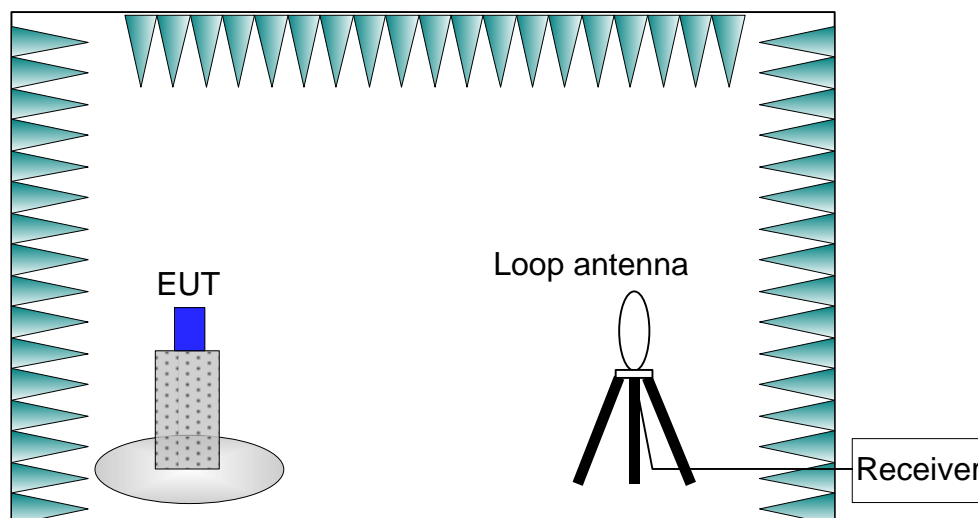

Figure B-1: Measurement Setup

B.1.3. EUT Operating Mode and Test Conditions

The measurement of EUT is carried out under the transmit state of NFC(See 3.4).

The EUT is powered by a travel adapter.

During the measurements, the ambient temperature of the electromagnetic anechoic chamber is in the range of 15 ~ 25 °C.

B.1.4. Limits

Table B-2: Limits

| Frequency Range (MHz) | E-field Strength Limit @ 30 m (μV/m) | E-field Strength Limit @ 3 m (dBμV/m) |
|--------------------------------------|--------------------------------------|---------------------------------------|
| 13.560 ± 0.007 | +15,848 | 124 |
| 13.410 to 13.553 13.567 to 13.710 | +334 | 90 |
| 13.110 to 13.410 13.710 to 14.010 | +106 | 81 |

Note: Where the limits have been defined at one distance, and a signal level measured at another, the limits have been extrapolated using the following formula:
 $Extrapolation(dB) = 40\log_{10}(Measurement\ Distance/Specification\ Distance)$

B.1.5. Measurement Results

Measurement results of normal conditions see Figure B-2 for different set-ups of EUT. The results displayed take into account applicable antenna factors and cable losses.

Conclusions: Set.NFC02, **PASS.**

Full Spectrum

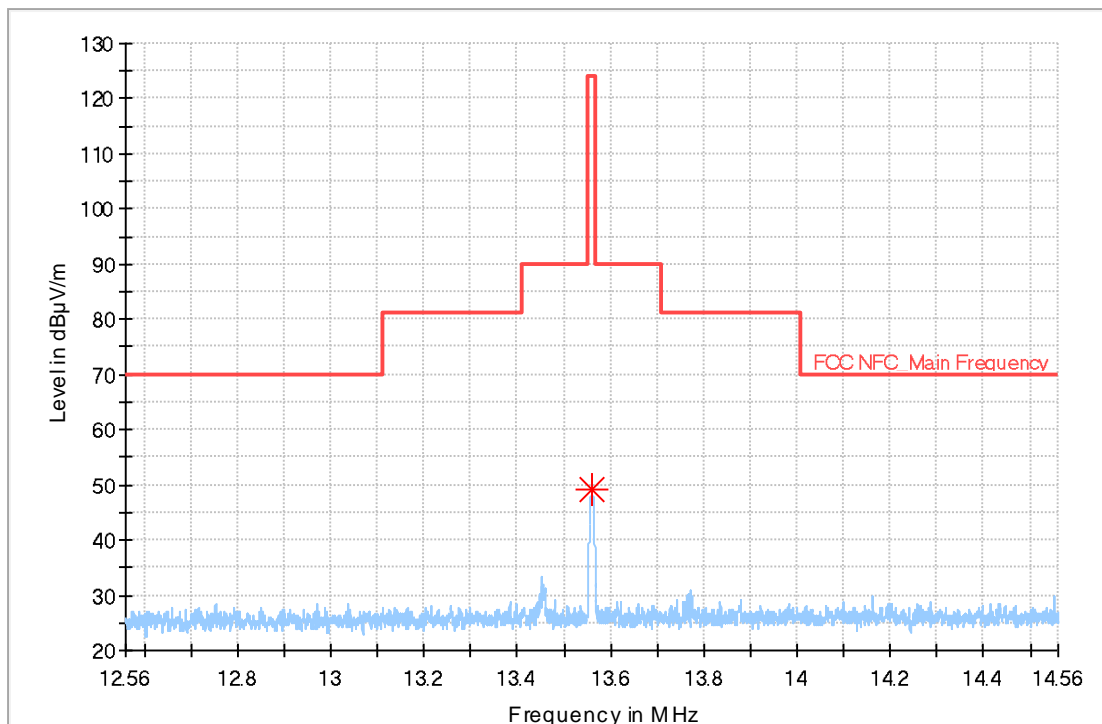

Figure B-2: Measurement results for Electric Field Strength of Fundamental and Outside the Allocated bands

| Frequency (MHz) | MaxPeak (dB μ V/m) | Limit (dB μ V/m) | Margin (dB) | Meas. Time (ms) | Bandwidth (kHz) | Pol | Azimuth (deg) | Corr. (dB/m) |
|-----------------|------------------------|----------------------|-------------|-----------------|-----------------|-----|---------------|--------------|
| 13.559750 | 49.23 | 124.00 | 74.77 | --- | --- | V | 164.0 | 17.9 |

B.2. Electric Field Radiated Emissions (< 30MHz)

B.2.1. Reference

See Clause 6.4 of ANSI C63.10-2013 specifically.

See Clause 4 and Clause 5 of ANSI C63.10-2013 generally.

B.2.2. Measurement Methods

The transmitter carrier output levels (E-Field) from the EUT are measured in a semi-anechoic chamber. The EUT is placed on a non-conductive stand of 80cm high, and at a measurement distance of 3m from the receiving antenna. The center of the receiving loop antenna is 1.0 meter above the ground. The E-field is measured with a shielded loop antenna connected to a measurement receiver. Detected E-field was maximized by rotating the EUT through 360° and adjusting the receiving antenna polarizations. The maximization processes were repeated with the EUT positioned respectively in its three orthogonal axes. The measurements were performed with the peak detector and if required, the quasi-peak detector.

The measurement bandwidth is:

| Frequency of Emission (MHz) | RBW/VBW |
|-----------------------------|------------|
| 0.009-0.15 | 100/300 Hz |
| 0.15-30 | 10/30 kHz |

The E-field measured at 3m is calculated as:

$$\text{E-field (dB}\mu\text{V/m)} = \text{Rx (dB}\mu\text{V)} + \text{Cable Loss (dB)} + \text{AF@3m (dB/m)}$$

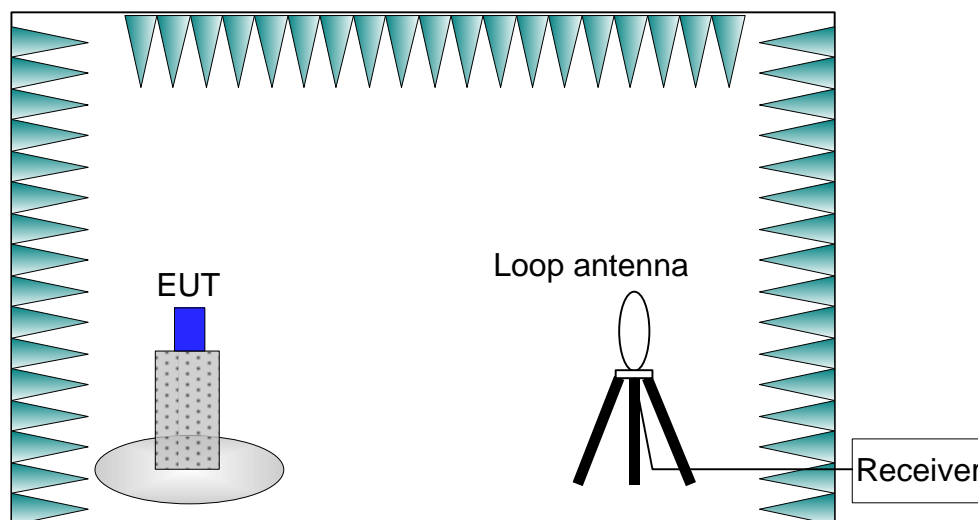

Figure B-3: Measurement Setup

B.2.3. EUT Operating Mode and Test Conditions

The measurement of EUT is carried out under the transmit state of NFC(See 3.4).

The EUT is powered by a travel adapter.

During the measurements, the ambient temperature of the electromagnetic anechoic chamber is in the range of 15 ~ 25 °C.

B.2.4. Limits

| Frequency Range (MHz) | E-field Strength Limit @ 30m (mV/m) | E-field Strength Limit @ 3m (dBµV/m) |
|-----------------------|-------------------------------------|--------------------------------------|
| 0.009-0.490 | 2400/F(kHz) | 129-94 |
| 0.490-1.705 | 24000/F(kHz) | 74-63 |
| 1.705-30 | 30 | 70 |

Note: Where the limits have been defined at one distance, and a signal level measured at another, the limits have been extrapolated using the following formula:
 Extrapolation(dB) = 40log₁₀(Measurement Distance/Specification Distance)

B.2.5. Measurement Results

Measurement results of normal conditions see Figure B-4 for different set-ups of EUT. The results displayed take into account applicable antenna factors and cable losses.

Conclusions: Set.NFC01, **PASS**.

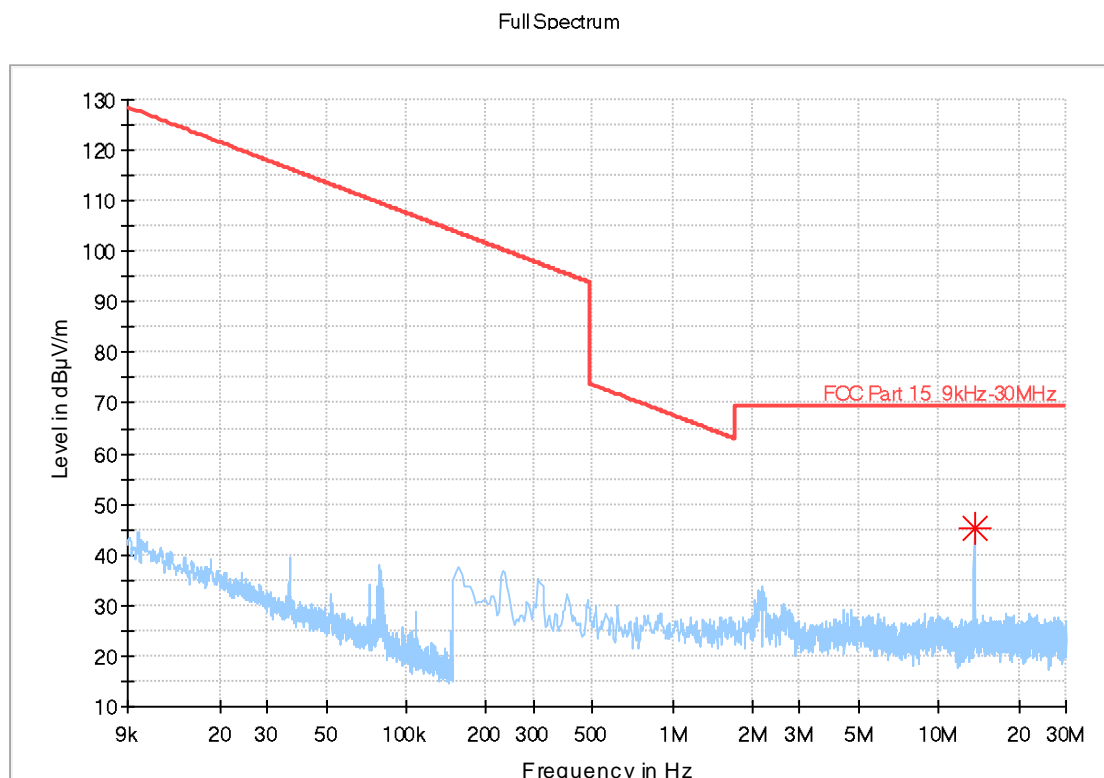

Figure B-4: Measurement results for Electric Field Radiated Emissions (< 30MHz)

| Frequency (MHz) | MaxPeak (dB μ V/m) | Limit (dB μ V/m) | Margin (dB) | Bandwidth (kHz) | Pol | Azimuth (deg) | Corr. (dB/m) |
|-----------------|------------------------|----------------------|-------------|-----------------|-----|---------------|--------------|
| 13.560113 | 45.35 | 69.50 | 24.15 | --- | V | 180.0 | 17.9 |

B.3. Electric Field Radiated Emissions (≥ 30 MHz)

B.3.1. Reference

See Clause 6.5 of ANSI C63.10-2013 specifically.

See Clause 4 and Clause 5 of ANSI C63.10-2013 generally.

B.3.2. Measurement Methods

The electric field radiated emissions from the EUT are measured in a semi-anechoic chamber. The EUT is placed on a non-conductive stand of 80cm high, and at a measurement distance of 10m from the receiving antenna. The receiving antennas connected to a measurement receiver. In order to search for maximum field strength emitted from the EUT, the receiving antenna can be moved between the height of 1.0 m to 4.0 m. Detected E-field was maximized at each frequency by rotating the EUT through 360° and adjusting the receiving antenna positions for both vertical and horizontal antenna polarizations. The maximization processes were repeated with the EUT positioned respectively in its three orthogonal axes. The measurements were performed with the peak detector and if required, the quasi-peak detector.

The measurement bandwidth is:

| Frequency of Emission (MHz) | RBW/VBW |
|-----------------------------|---------|
| 30-1000 | 120kHz |

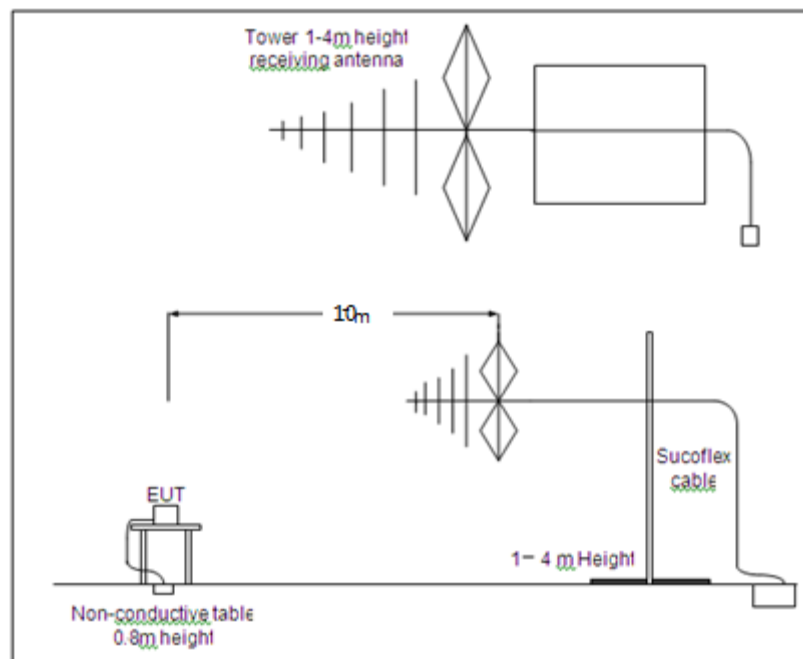

Figure B-5: Measurement Setup

B.3.3. EUT Operating Mode and Test Conditions

The measurement of EUT is carried out under the transmit state of NFC(See 3.4).

The EUT had been connected to a travel adapter.

During the measurements, the ambient temperature of the electromagnetic anechoic chamber is in the range of 15 ~ 25 °C.

B.3.4. Limits

| Frequency Range (MHz) | E-field Strength Limit @ 3m (mV/m) | E-field Strength Limit @ 3m (dB μ V/m) | E-field Strength Limit @ 10m (dB μ V/m) |
|-----------------------|------------------------------------|--|---|
| 30-88 | 100 | 40 | 30 |
| 88-216 | 150 | 43.5 | 33.5 |
| 216-960 | 200 | 46 | 36 |
| 960-1000 | 500 | 54 | 44 |

B.3.5. Measurement Results

Measurement results of normal conditions see Figure B-6 for different set-ups of EUT. The results displayed take into account applicable antenna factors and cable losses.

Conclusions: Set.NFC01, **PASS**.

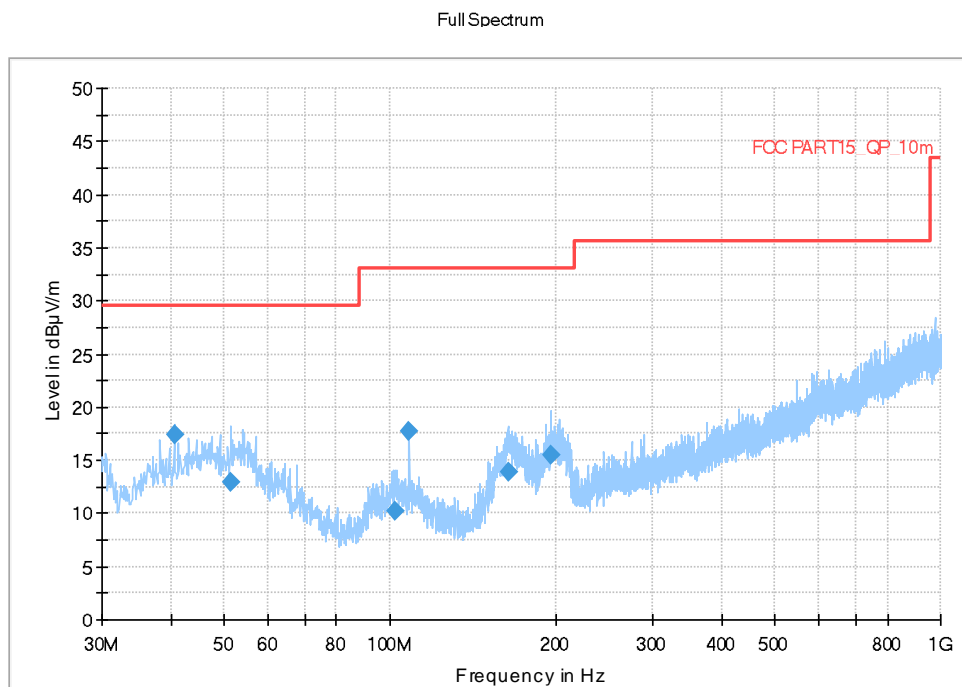

Figure B-6: Measurement results for Electric Field Radiated Emissions (≥ 30 MHz)

Final_Result

| Frequency (MHz) | QuasiPeak (dB μ V/m) | Limit (dB μ V/m) | Margin (dB) | Bandwidth (kHz) | Height (cm) | Pol | Azimuth (deg) | Corr. (dB/m) |
|--------------------|-----------------------------|-------------------------|----------------|--------------------|----------------|-----|------------------|-----------------|
| 40.670000 | 17.42 | 29.54 | 12.12 | 120.000 | 175.0 | V | 135.0 | -11.8 |
| 51.437000 | 12.97 | 29.54 | 16.57 | 120.000 | 101.0 | V | 103.0 | -10.8 |
| 102.362000 | 10.24 | 33.06 | 22.82 | 120.000 | 101.0 | V | -45.0 | -12.1 |
| 108.473000 | 17.81 | 33.06 | 15.25 | 120.000 | 175.0 | V | -25.0 | -12.5 |
| 163.666000 | 13.92 | 33.06 | 19.14 | 120.000 | 322.0 | V | 155.0 | -14.7 |
| 196.549000 | 15.50 | 33.06 | 17.56 | 120.000 | 322.0 | H | 83.0 | -11.4 |

B.4. Frequency Tolerance

B.4.1. Reference

See Clause 6.8 of ANSI C63.10-2013 specifically.

See Clause 4 and Clause 5 of ANSI C63.10-2013 generally.

B.4.2. Measurement Methods

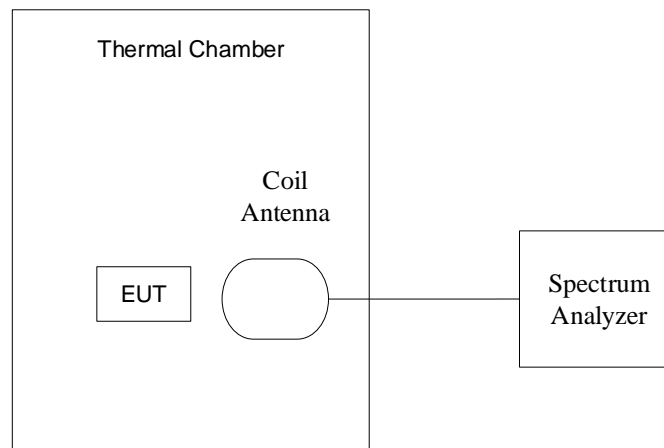

Figure B-7: Measurement Setup

The transmitter output signal was picked up by coil antenna connected to the spectrum analyzer. The center frequency was measured with 30Hz RBW and 1kHz span. During the test, the EUT was placed in a thermal chamber until thermal balance and lasting appropriate time.

B.4.3. EUT Operating Mode and Test Conditions

The measurement of EUT was carried out under the transmit state of without modulation(See 3.4). EUT had not been connected to a travel adapter. The frequency stability was measured with the different voltage and temperature combinations:

- The nominal voltage 3.87V(See 3.1)was used and the temperature was varied from -20 $^{\circ}$ C to +50 $^{\circ}$ C in 10 $^{\circ}$ C increments using an environmental chamber.
- The 20 $^{\circ}$ C was used and the voltages were 3.6V, 3.87V and 4.45V (The extreme low voltage ,the normal voltage and the extreme high voltage).

The details were as following:

Table B-3: Combinations of Voltage and Temperature

| Test items | Voltage | Temperature |
|---|---------|-------------|
| Frequency stability with respect to ambient temperature | 3.87V | -20°C |
| | | -10°C |
| | | 0°C |
| | | 10°C |
| | | 20°C |
| | | 30°C |
| | | 40°C |
| | | 50°C |
| Frequency stability when varying supply voltage | 3.6V | 20°C |
| | 3.87V | |
| | 4.45V | |

B.4.4. Test Layouts

See B.4.2.

B.4.5. Limits

The frequency tolerance of the carrier signal shall be maintained within +/- 0.01% of the operating frequency.

B.4.6. Measurement Results

Measurement results see Table B-4 for different test conditions.

Conclusions: Set.NFC03, **PASS**.

Table B-4: Measurement results for Frequency Tolerance

| Temperature | Voltage | Frequency (MHz) | | | |
|-------------|---------|-----------------|--------------|--------------|--------------|
| | | Startup | 2 Min Later | 5 Min Later | 10 Min Later |
| -20°C | 3.87V | 13.560567000 | 13.560576000 | 13.560576000 | 13.560580000 |
| -10°C | 3.87V | 13.560531000 | 13.560540000 | 13.560549000 | 13.560549000 |
| 0°C | 3.87V | 13.560486000 | 13.560495000 | 13.560504000 | 13.560513000 |
| 10°C | 3.87V | 13.560448000 | 13.560456000 | 13.560464000 | 13.560472000 |
| 20°C | 3.87V | 13.560459000 | 13.560459000 | 13.550477000 | 13.560484000 |
| 30°C | 3.87V | 13.560469000 | 13.560462000 | 13.560455000 | 13.560441000 |
| 40°C | 3.87V | 13.560432000 | 13.560423000 | 13.560423000 | 13.560418000 |
| 50°C | 3.87V | 13.560414000 | 13.560432000 | 13.560440000 | 13.560440000 |
| 20°C | 3.6V | 13.560441000 | 13.560432000 | 13.560432000 | 13.560432000 |
| 20°C | 4.45V | 13.560448000 | 13.560448000 | 13.560459000 | 13.560459000 |

| Temperature | Voltage | Frequency Error (%) | | | |
|-------------|---------|---------------------|-------------|-------------|--------------|
| | | Startup | 2 Min Later | 5 Min Later | 10 Min Later |
| -20°C | 3.87V | 0.004 | 0.004 | 0.004 | 0.004 |
| -10°C | 3.87V | 0.004 | 0.004 | 0.004 | 0.004 |
| 0°C | 3.87V | 0.004 | 0.004 | 0.004 | 0.004 |
| 10°C | 3.87V | 0.003 | 0.003 | 0.003 | 0.003 |
| 20°C | 3.87V | 0.003 | 0.003 | -0.070 | 0.004 |
| 30°C | 3.87V | 0.003 | 0.003 | 0.003 | 0.003 |
| 40°C | 3.87V | 0.003 | 0.003 | 0.003 | 0.003 |
| 50°C | 3.87V | 0.003 | 0.003 | 0.003 | 0.003 |
| 20°C | 3.6V | 0.003 | 0.003 | 0.003 | 0.003 |
| 20°C | 4.45V | 0.003 | 0.003 | 0.003 | 0.003 |

B.4.7. Measurement Uncertainty

Measurement uncertainty: $U = 74 \text{ Hz}$, $k=2$

B.5. 20dB Bandwidth

B.5.1. Reference

See Clause 6.9 of ANSI C63.10-2013 specifically.

See Clause 4 and Clause 5 of ANSI C63.10-2013 generally.

B.5.2. Measurement Methods

The transmitter output signal was picked up by coil antenna connected to the spectrum analyzer. The bandwidth of the center frequency was measured with 300Hz RBW, 1kHz VBW and 10kHz span.

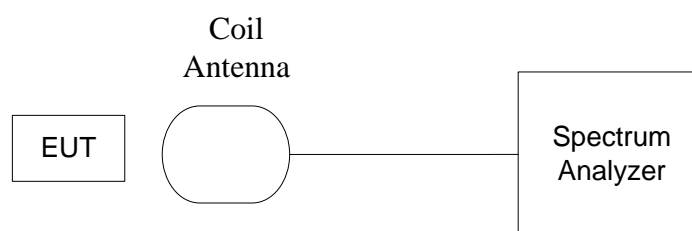

Figure B-8: Measurement Setup

B.5.3. EUT Operating Mode and Test Conditions

The measurement of EUT was carried out under the transmit state of NFC (See 3.4).

EUT had not been connected to a travel adapter.

During the measurements, the ambient temperature was in the range of 15 ~ 25 °C.

B.5.4. Test Layouts

See B.5.2.

B.5.5. Limits

The 20dB bandwidth shall be less than 80% of the permitted frequency band. For 13.56 MHz NFC, the permitted frequency band is 14kHz, so the limit is 11.2 kHz.

B.5.6. Measurement Results

Measurement results see Figure B-9.

Conclusions: Set.NFC03, **PASS**.



Figure B-9: Measurement results for 20dB Bandwidth

B.5.7. Measurement Uncertainty

Measurement uncertainty: $U = 74 \text{ Hz}$, $k=2$

B.6. Conducted emission

B.6.1. Reference

See Clause 6.2 of ANSI C63.10-2013 specifically.

See Clause 4 and Clause 5 of ANSI C63.10-2013 generally.

B.6.2. Measurement Methods

The conducted emissions from the AC port of the EUT are measured in a shielding room. The EUT is connected to a Line Impedance Stabilization Network (LISN). An overview sweep with peak detection was performed. The measurements were performed with a quasi-peak detector and if required, an average detector.

The conducted emission measurements were made with the following detector of the test receiver: Quasi-Peak / Average Detector.

The measurement bandwidth is:

Table B-5: Measurement Bandwidth

| Frequency of Emission (MHz) | RBW/VBW |
|-----------------------------|---------|
| 0.15-30 | 9kHz |

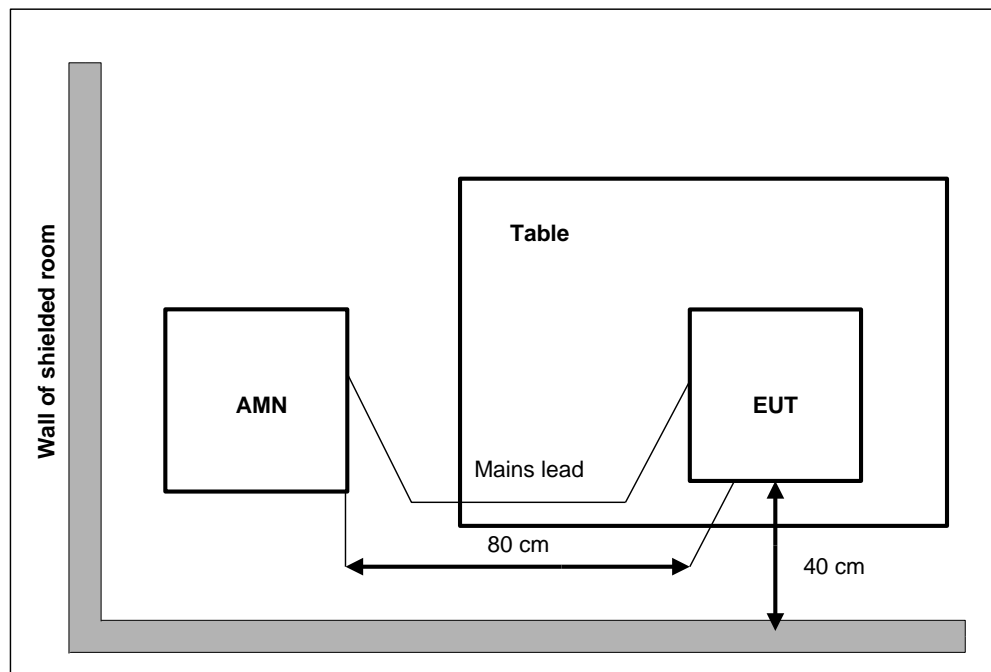

Figure B-10: Measurement Setup

B.6.3. EUT Operating Mode and Test Conditions

The measurement of EUT is carried out under the transmit state of NFC(See 3.4).

The EUT is powered by a travel adapter.

During the measurements, the ambient temperature is in the range of 15 ~ 25 °C.

B.6.4. Limits

| Frequency range (MHz) | Quasi-peak Limit (dB μ V) | Average Limit (dB μ V) |
|-----------------------|-------------------------------|----------------------------|
| 0.15 to 0.5 | 66 to 56 | 56 to 46 |
| 0.5 to 5 | 56 | 46 |
| 5 to 30 | 60 | 50 |

B.6.5. Measurement Results

Measurement results see Figure B-11.

Conclusions: Set.NFC01, PASS.

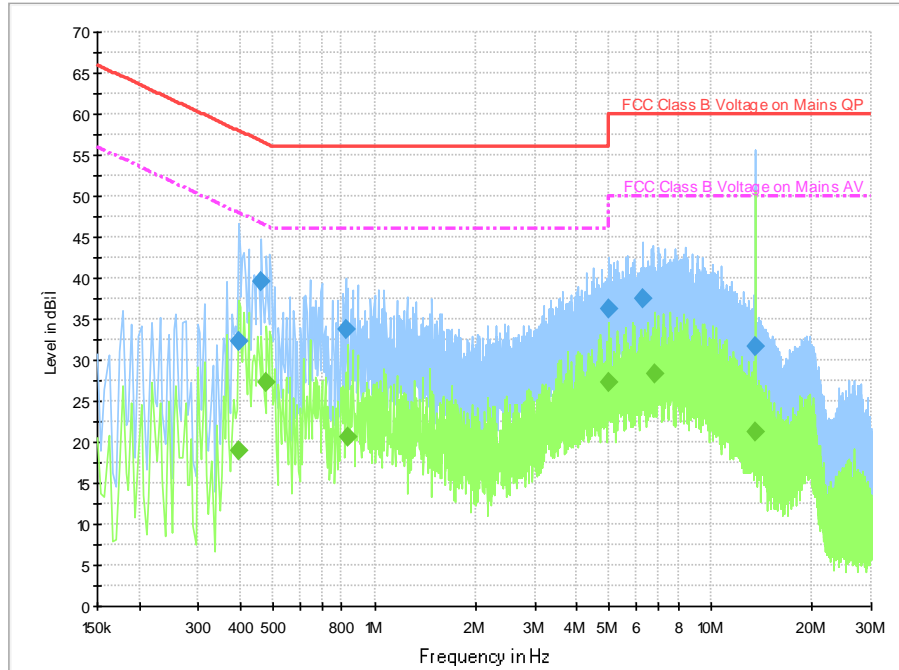

Figure B-11: Measurement results for Conducted Emission

Final Result 1

| Frequency (MHz) | QuasiPeak (dBµV) | Meas. Time (ms) | Bandwidth (kHz) | Filter | Line | Corr. (dB) | Margin (dB) | Limit (dBµV) |
|-----------------|------------------|-----------------|-----------------|--------|------|------------|-------------|--------------|
| 0.394000 | 32.3 | 2000.0 | 9.000 | On | L1 | 19.7 | 25.7 | 58.0 |
| 0.462000 | 39.7 | 2000.0 | 9.000 | On | L1 | 19.7 | 17.0 | 56.7 |
| 0.822000 | 33.8 | 2000.0 | 9.000 | On | L1 | 19.7 | 22.2 | 56.0 |
| 4.978000 | 36.3 | 2000.0 | 9.000 | On | L1 | 19.6 | 19.7 | 56.0 |
| 6.266000 | 37.4 | 2000.0 | 9.000 | On | L1 | 19.6 | 22.6 | 60.0 |
| 13.558000 | 31.7 | 2000.0 | 9.000 | On | L1 | 19.7 | 28.3 | 60.0 |

Final Result 2

| Frequency (MHz) | QuasiPeak (dBµV) | Meas. Time (ms) | Bandwidth (kHz) | Filter | Line | Corr. (dB) | Margin (dB) | Limit (dBµV) |
|-----------------|------------------|-----------------|-----------------|--------|------|------------|-------------|--------------|
| 0.394000 | 19.0 | 2000.0 | 9.000 | On | L1 | 19.7 | 29.0 | 48.0 |
| 0.478000 | 27.3 | 2000.0 | 9.000 | On | L1 | 19.7 | 19.1 | 46.4 |
| 0.834000 | 20.5 | 2000.0 | 9.000 | On | L1 | 19.7 | 25.5 | 46.0 |
| 4.978000 | 27.2 | 2000.0 | 9.000 | On | L1 | 19.6 | 18.8 | 46.0 |
| 6.826000 | 28.4 | 2000.0 | 9.000 | On | L1 | 19.7 | 21.6 | 50.0 |
| 13.558000 | 21.2 | 2000.0 | 9.000 | On | L1 | 19.7 | 28.8 | 50.0 |

ANNEX C: Persons involved in this testing

| Test Item | Tester |
|--|--------------|
| 20dB Bandwidth | Miao Qinghua |
| Frequency Tolerance | Miao Qinghua |
| Electric Field Strength of Fundamental and Outside the Allocated bands | Ding Zai |
| Electric Field Radiated Emissions (< 30MHz) | Ding Zai |
| Electric Field Radiated Emissions (≥ 30 MHz) | Ding Zai |
| Conducted Emissions | Li Pengfei |

ANNEX D: Accreditation Certificate



Accredited Laboratory

A2LA has accredited

TELECOMMUNICATION TECHNOLOGY LABS, CAICT

Beijing, People's Republic of China

for technical competence in the field of

Electrical Testing

This laboratory is accredited in accordance with the recognized International Standard ISO/IEC 17025:2017 *General requirements for the competence of testing and calibration laboratories*. This accreditation demonstrates technical competence for a defined scope and the operation of a laboratory quality management system (refer to joint ISO-ILAC-IAF Communiqué dated April 2017).



Presented this 26th day of June 2023.

Mr. Trace McInturf, Vice President, Accreditation Services
For the Accreditation Council
Certificate Number 7049.01
Valid to July 31, 2024

For the tests to which this accreditation applies, please refer to the laboratory's Electrical Scope of Accreditation.

END OF REPORT