



No.I19Z61602-SEM03



SAR TEST REPORT

No. I20Z61602-SEM03

For

Wingtech Group (Hong Kong) Limited

4G Mobile Broadband Router

Model Name: TMOHS1

With

Hardware Version: 89527_1_11

Software Version: TMOHS1_0.01.15

FCC ID: 2APXW-TMOHS1

Issued Date: 2020-11-9

Note:

The test results in this test report relate only to the devices specified in this report. This report shall not be reproduced except in full without the written approval of CTTL.

The report must not be used by the client to claim product certification, approval, or endorsement by NVLAP, NIST, or any agency of the U.S.Government.

Test Laboratory:

CTTL, Telecommunication Technology Labs, CAICT

No. 51, Xueyuan Road, Haidian District, Beijing, P. R. China 100191.

Tel:+86(0)10-62304633-2512, Fax:+86(0)10-62304633-2504

Email: ctl_terminals@caict.ac.cn, website: www.caict.ac.cn

**REPORT HISTORY**

Report Number	Revision	Issue Date	Description
I20Z61602-SEM03	Rev.0	2020-11-4	Initial creation of test report
I20Z61602-SEM03	Rev.1	2020-11-9	<ol style="list-style-type: none">1. Update the description of RF exposure configuration on Table2.1.2. Revise a typo on Table2.2.3. Update the frequency range of WiFi5G on section4.1.4. Add SAR results of top sides on section 14.2.

TABLE OF CONTENT

1 TEST LABORATORY	5
1.1 TESTING LOCATION	5
1.2 TESTING ENVIRONMENT.....	5
1.3 PROJECT DATA	5
1.4 SIGNATURE.....	5
2 STATEMENT OF COMPLIANCE	6
3 CLIENT INFORMATION	8
3.1 APPLICANT INFORMATION	8
3.2 MANUFACTURER INFORMATION	8
4 EQUIPMENT UNDER TEST (EUT) AND ANCILLARY EQUIPMENT (AE)	9
4.1 ABOUT EUT	9
4.2 INTERNAL IDENTIFICATION OF EUT USED DURING THE TEST	9
4.3 INTERNAL IDENTIFICATION OF AE USED DURING THE TEST	9
5 TEST METHODOLOGY	10
5.1 APPLICABLE LIMIT REGULATIONS	10
5.2 APPLICABLE MEASUREMENT STANDARDS	10
6 SPECIFIC ABSORPTION RATE (SAR).....	11
6.1 INTRODUCTION.....	11
6.2 SAR DEFINITION.....	11
7 TISSUE SIMULATING LIQUIDS	12
7.1 TARGETS FOR TISSUE SIMULATING LIQUID.....	12
7.2 DIELECTRIC PERFORMANCE	12
8 SYSTEM VERIFICATION	17
8.1 SYSTEM SETUP.....	17
8.2 SYSTEM VERIFICATION.....	18
9 MEASUREMENT PROCEDURES	19
9.1 TESTS TO BE PERFORMED	19
9.2 GENERAL MEASUREMENT PROCEDURE.....	21
9.3 SAR MEASUREMENT FOR LTE.....	22
9.4 POWER DRIFT.....	22
10 AREA SCAN BASED 1-G SAR.....	23
10.1 REQUIREMENT OF KDB.....	23
10.2 FAST SAR ALGORITHMS.....	23
11 CONDUCTED OUTPUT POWER.....	24
11.1 WCDMA MEASUREMENT RESULT	24

11.2 LTE MEASUREMENT RESULT	26
11.3 WI-FI MEASUREMENT RESULT	75
12 TRANSMIT ANTENNA POSITION AND SIZE	78
12.1 INTRODUCTION.....	78
12.2 TRANSMIT ANTENNA SEPARATION DISTANCES.....	78
12.3 SAR MEASUREMENT POSITIONS	79
12.4 STANDALONE SAR TEST EXCLUSION CONSIDERATIONS	79
13 EVALUATION OF SIMULTANEOUS.....	80
14 SAR TEST RESULT	81
14.1 SAR RESULTS FOR FAST SAR(NON-USB)	82
14.2 SAR RESULTS FOR FAST SAR(USB)	90
14.3 SAR RESULTS FOR STANDARD PROCEDURE(NON-USB).....	98
14.4 SAR RESULTS FOR STANDARD PROCEDURE(USB).....	101
14.5 WLAN EVALUATION FOR 2.4G	104
14.4 WLAN EVALUATION FOR 5G.....	108
15 SAR MEASUREMENT VARIABILITY.....	115
16 MEASUREMENT UNCERTAINTY	117
16.1 MEASUREMENT UNCERTAINTY FOR NORMAL SAR TESTS (300MHZ~3GHZ).....	117
16.2 MEASUREMENT UNCERTAINTY FOR NORMAL SAR TESTS (3~6GHZ)	118
16.3 MEASUREMENT UNCERTAINTY FOR FAST SAR TESTS (300MHZ~3GHZ).....	119
16.4 MEASUREMENT UNCERTAINTY FOR FAST SAR TESTS (3~6GHZ)	120
17 MAIN TEST INSTRUMENTS.....	122
ANNEX A GRAPH RESULTS	123
ANNEX B SYSTEM VERIFICATION RESULTS	146
ANNEX C SAR MEASUREMENT SETUP	156
ANNEX D POSITION OF THE WIRELESS DEVICE IN RELATION TO THE PHANTOM	162
ANNEX E EQUIVALENT MEDIA RECIPES	165
ANNEX F SYSTEM VALIDATION	166
ANNEX G PROBE CALIBRATION CERTIFICATE.....	167
ANNEX H DIPOLE CALIBRATION CERTIFICATE	190
ANNEX I SENSOR TRIGGERING DATA SUMMARY.....	261
ANNEX J ACCREDITATION CERTIFICATE.....	269

1 Test Laboratory

1.1 Testing Location

Company Name:	CTTL(Shouxiang)
Address:	No. 51 Shouxiang Science Building, Xueyuan Road, Haidian District, Beijing, P. R. China100191

1.2 Testing Environment

Temperature:	18°C~25°C,
Relative humidity:	30%~ 70%
Ground system resistance:	< 0.5 Ω
Ambient noise & Reflection:	< 0.012 W/kg

1.3 Project Data

Project Leader:	Qi Dianyuan
Test Engineer:	Lin Xiaojun
Testing Start Date:	October 22, 2020
Testing End Date:	October 30, 2020

1.4 Signature



Lin Xiaojun
(Prepared this test report)



Qi Dianyuan
(Reviewed this test report)

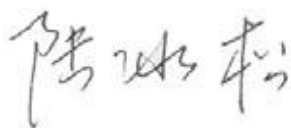

Lu Bingsong
Deputy Director of the laboratory
(Approved this test report)

2 Statement of Compliance

The maximum results of Specific Absorption Rate (SAR) found during testing for Wingtech Group (Hongkong) Limited 4G Mobile Broadband Router TMOHS1 is as follows:

Table 2.1: Highest Reported SAR (1g)

Exposure Configuration	Technology Band	Highest Reported SAR 1g(W/kg) Non-USB	Highest Reported SAR 1g(W/kg) USB	Equipment Class
Body	UMTS FDD 2	1.06	1.06	PCE
	UMTS FDD 4	1.19	1.19	
	LTE Band 12	0.66	0.66	
	LTE Band 25	0.69	0.69	
	LTE Band 26	0.87	0.87	
	LTE Band 41	0.24	1.26	
	LTE Band 66	0.91	0.89	
	LTE Band 71	0.39	0.56	
	WLAN 2.4 GHz	0.29	0.39	DTS
	WLAN 5 GHz	1.23	1.23	UNII

The SAR values found for the Mobile Phone are below the maximum recommended levels of 1.6 W/kg as averaged over any 1g tissue according to the ANSI C95.1-1992.

For body operation, this device has been tested and meets FCC RF exposure guidelines when used with any accessory that contains no metal and which provides a minimum separation distance of 0/10/15 mm between this device and the body of the user. Use of other accessories may not ensure compliance with FCC RF exposure guidelines.

The EUT battery must be fully charged and checked periodically during the test to ascertain uniform power output.

The measurement together with the test system set-up is described in annex C of this test report. A detailed description of the equipment under test can be found in chapter 4 of this test report. The highest reported SAR value is obtained at the case of **(Table 2.1)**, and the values are: **1.26 W/kg(1g)**.

Table 2.2: The sum of reported SAR values for Main antenna and WiFi-2.4G

	Position	Cellular antenna	WiFi2.4G	Sum
Highest reported SAR value for Body	Rear 0mm	1.22	0.25	1.47

Table 2.3: The sum of reported SAR values for Main antenna + WiFi-5G

	Position	Cellular antenna	WiFi-5G	Sum
Maximum reported SAR value for Body	Rear 21mm	1.19	0.39	1.58
Maximum reported SAR value for Body	Left 15mm	0.35	1.23	1.58

According to the above tables, the highest sum of reported SAR values is **1.58 W/kg (1g)**. The detail for simultaneous transmission consideration is described in chapter 13.



3 Client Information

3.1 Applicant Information

Company Name:	Wingtech Group (Hongkong) Limited
Address/Post:	Flat/RM 1903 ,19/F, Podium Plaza, 5 Hanoi Road, Tsim Sha Tsui, Kowloon, Hongkong.
Contact Person:	/
Contact Email:	/
Telephone:	/
Fax	/

3.2 Manufacturer Information

Company Name:	Wingtech Group (Hongkong) Limited
Address/Post:	Flat/RM 1903 ,19/F, Podium Plaza, 5 Hanoi Road, Tsim Sha Tsui, Kowloon, Hongkong.
Contact Person:	/
Contact Email:	/
Telephone:	/
Fax	/

4 Equipment Under Test (EUT) and Ancillary Equipment (AE)

4.1 About EUT

Description:	4G Mobile Broadband Router
Model name:	TMOHS1
Operating mode(s):	WCDMA1700/1900, Wi-Fi2.4G/5G LTE Band 1/2/4/5/8/12/25/26/38/41/66/71
	1710 – 1755 MHz (WCDMA 1700 Band IV)
	1850–1910 MHz (WCDMA1900 Band II)
	699.7 – 715.3 MHz (LTE Band 12)
	1850.7 –1914.3 (LTE Band 25)
	814.7 –848.3 (LTE Band 26)
	2498.5 – 2687.5MHz(LTE Band 41)
	1710.7 – 1779.3 MHz (LTE Band 66)
	665.5 – 695.5 MHz (LTE Band 71)
	2412 – 2462 MHz (Wi-Fi 2.4G)
	5.18 – 5.24 GHz, 5.745-5.825(Wi-Fi 5G)
Test device Production information:	Production unit
Device type:	Portable device
Antenna type:	Integrated antenna

4.2 Internal Identification of EUT used during the test

EUT ID*	IMEI	HW Version	SW Version
EUT1	352008571000714	89527_1_11	TMOHS1_0.01.15
EUT2	352008571000726	89527_1_11	TMOHS1_0.01.15
EUT3	352008571000738	89527_1_11	TMOHS1_0.01.15
EUT4	352008571000740	89527_1_11	TMOHS1_0.01.15
EUT5	352008571000751	89527_1_11	TMOHS1_0.01.15
EUT6	862448013594625	89527_1_11	TMOHS1_0.01.15
EUT7	862448013594047	89527_1_11	TMOHS1_0.01.15
EUT8	862448013594013	89527_1_11	TMOHS1_0.01.15
EUT9	862448013593601	89527_1_11	TMOHS1_0.01.15

*EUT ID: is used to identify the test sample in the lab internally.

Note: It is performed to test SAR with the EUT1-5 and conducted power with the EUT6-9.

4.3 Internal Identification of AE used during the test

AE ID*	Description	Model	SN	Manufacturer
AE1	Battery	MF01	/	Jiade Energy Technology (Zhuhai) Co.,Ltd.

*AE ID: is used to identify the test sample in the lab internally.

5 TEST METHODOLOGY

5.1 Applicable Limit Regulations

ANSI C95.1–1992:IEEE Standard for Safety Levels with Respect to Human Exposure to Radio Frequency Electromagnetic Fields, 3 kHz to 300 GHz.

It specifies the maximum exposure limit of **1.6 W/kg** as averaged over any 1 gram of tissue for portable devices being used within 20 cm of the user in the uncontrolled environment.

5.2 Applicable Measurement Standards

IEEE 1528–2013: Recommended Practice for Determining the Peak Spatial-Average Specific Absorption Rate (SAR) in the Human Head from Wireless Communications Devices: Measurement Techniques.

KDB447498 D01: General RF Exposure Guidance v06: Mobile and Portable Devices RF Exposure Procedures and Equipment Authorization Policies.

KDB447498 D02: SAR Procedures for Dongle Xmtr v02r01: SAR Measurement Procedures for USB Dongle Transmitters

KDB941225 D05 SAR for LTE Devices v02r05: SAR Evaluation Considerations for LTE Devices

KDB865664 D01 SAR measurement 100 MHz to 6 GHz v01r04: SAR Measurement Requirements for 100 MHz to 6 GHz.

KDB865664 D02 RF Exposure Reporting v01r02: RF Exposure Compliance Reporting and Documentation Considerations.

KDB248227 D01 802.11 Wi-Fi SAR v02r02: SAR GUIDANCE FOR IEEE 802.11 (Wi-Fi) TRANSMITTERS

KDB616217 D04 SAR for laptop and tablets v01r02 SAR Evaluation Considerations for Laptop, Notebook, Notebook and Tablet Computers.

6 Specific Absorption Rate (SAR)

6.1 Introduction

SAR is related to the rate at which energy is absorbed per unit mass in an object exposed to a radio field. The SAR distribution in a biological body is complicated and is usually carried out by experimental techniques or numerical modeling. The standard recommends limits for two tiers of groups, occupational/controlled and general population/uncontrolled, based on a person's awareness and ability to exercise control over his or her exposure. In general, occupational/controlled exposure limits are higher than the limits for general population/uncontrolled.

6.2 SAR Definition

The SAR definition is the time derivative (rate) of the incremental energy (dW) absorbed by (dissipated in) an incremental mass (dm) contained in a volume element (dv) of a given density (ρ). The equation description is as below:

$$SAR = \frac{d}{dt} \left(\frac{dW}{dm} \right) = \frac{d}{dt} \left(\frac{dW}{\rho dv} \right)$$

SAR is expressed in units of Watts per kilogram (W/kg)

SAR measurement can be either related to the temperature elevation in tissue by

$$SAR = c \left(\frac{\delta T}{\delta t} \right)$$

Where: C is the specific heat capacity, δT is the temperature rise and δt is the exposure duration, or related to the electrical field in the tissue by

$$SAR = \frac{\sigma |E|^2}{\rho}$$

Where: σ is the conductivity of the tissue, ρ is the mass density of tissue and E is the RMS electrical field strength.

However for evaluating SAR of low power transmitter, electrical field measurement is typically applied.

7 Tissue Simulating Liquids

7.1 Targets for tissue simulating liquid

Table 7.1: Targets for tissue simulating liquid

Frequency(MHz)	Liquid Type	Conductivity(σ)	$\pm 5\%$ Range	Permittivity(ϵ)	$\pm 5\%$ Range
750	Head	0.89	0.85~0.93	41.94	39.8~44.0
835	Head	0.90	0.86~0.95	41.5	39.4~43.6
1750	Head	1.37	1.30~1.44	40.08	38.1~42.1
1900	Head	1.40	1.33~1.47	40.0	38.0~42.0
2450	Head	1.80	1.71~1.89	39.2	37.2~41.2
2600	Head	1.96	1.86~2.06	39.01	37.1~41.0
5250	Head	4.71	4.47~4.95	35.93	34.13~37.73
5600	Head	5.07	4.82~5.32	35.53	33.8~37.3
5750	Head	5.22	4.96~5.48	35.36	33.59~37.13

7.2 Dielectric Performance

Table 7.2: Dielectric Performance of Tissue Simulating Liquid

Measurement Date (yyyy-mm-dd)	Type	Frequency	Permittivity ϵ	Drift (%)	Conductivity σ (S/m)	Drift (%)
2020/10/22	Head	750 MHz	42.5	1.34	0.89	0.00
2020/10/23	Head	835 MHz	40.69	-1.95	0.888	-1.33
2020/10/24	Head	1750 MHz	40.2	0.30	1.354	-1.17
2020/10/25	Head	1900 MHz	39.38	-1.55	1.411	0.79
2020/10/26	Head	2450 MHz	39.83	1.61	1.818	1.00
2020/10/27	Head	2600 MHz	39.01	0.00	1.956	-0.20
2020/10/28	Head	5250 MHz	36.07	0.39	4.729	0.40
2020/10/29	Head	5600 MHz	35.75	0.62	5.153	1.64
2020/10/30	Head	5750 MHz	35.73	1.05	5.201	-0.36

Note: The liquid temperature is 22.0°C

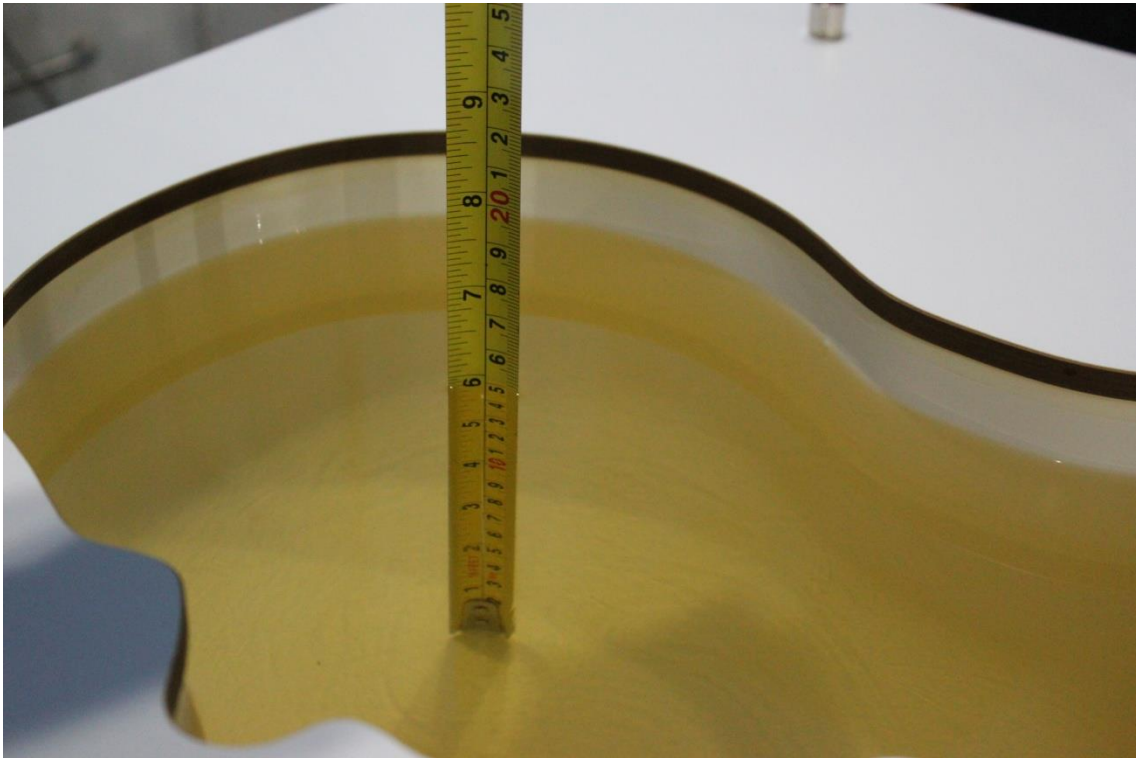

Picture 7-1 Liquid depth in the Head Phantom (750MHz)

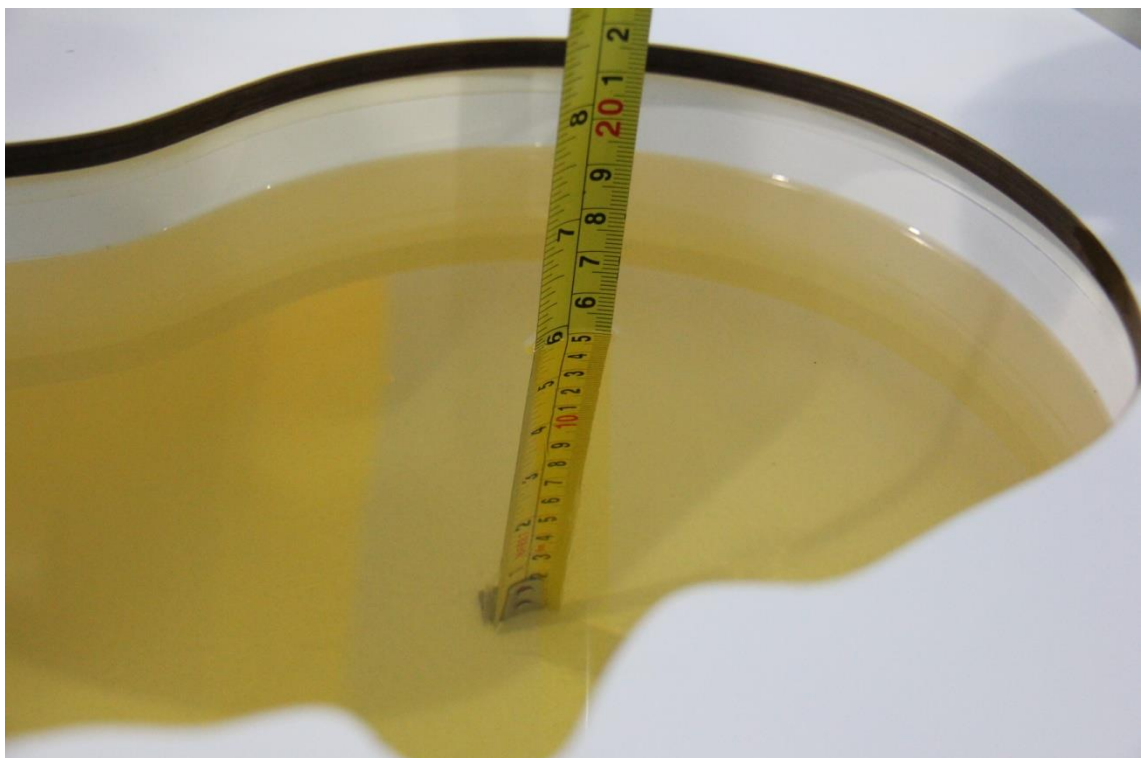

Picture 7-2 Liquid depth in the Head Phantom (835 MHz)

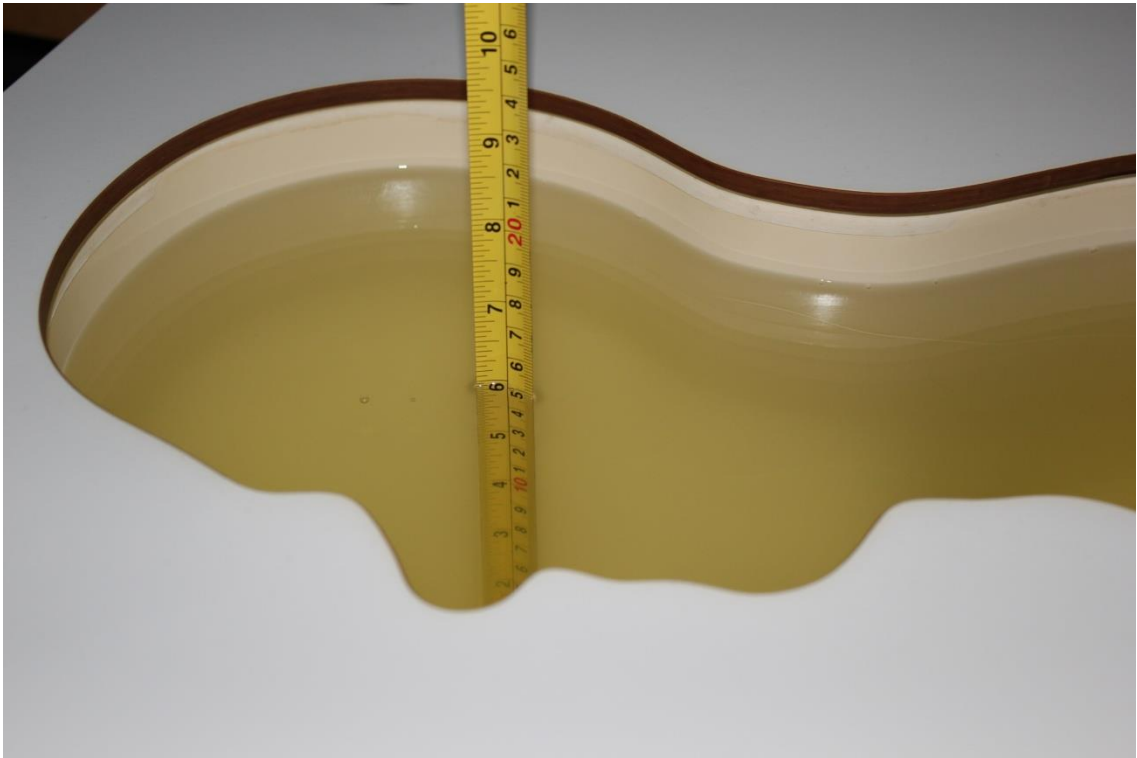

Picture 7-3 Liquid depth in the Head Phantom (1750 MHz)



Picture 7-4 Liquid depth in the Head Phantom (1900 MHz)

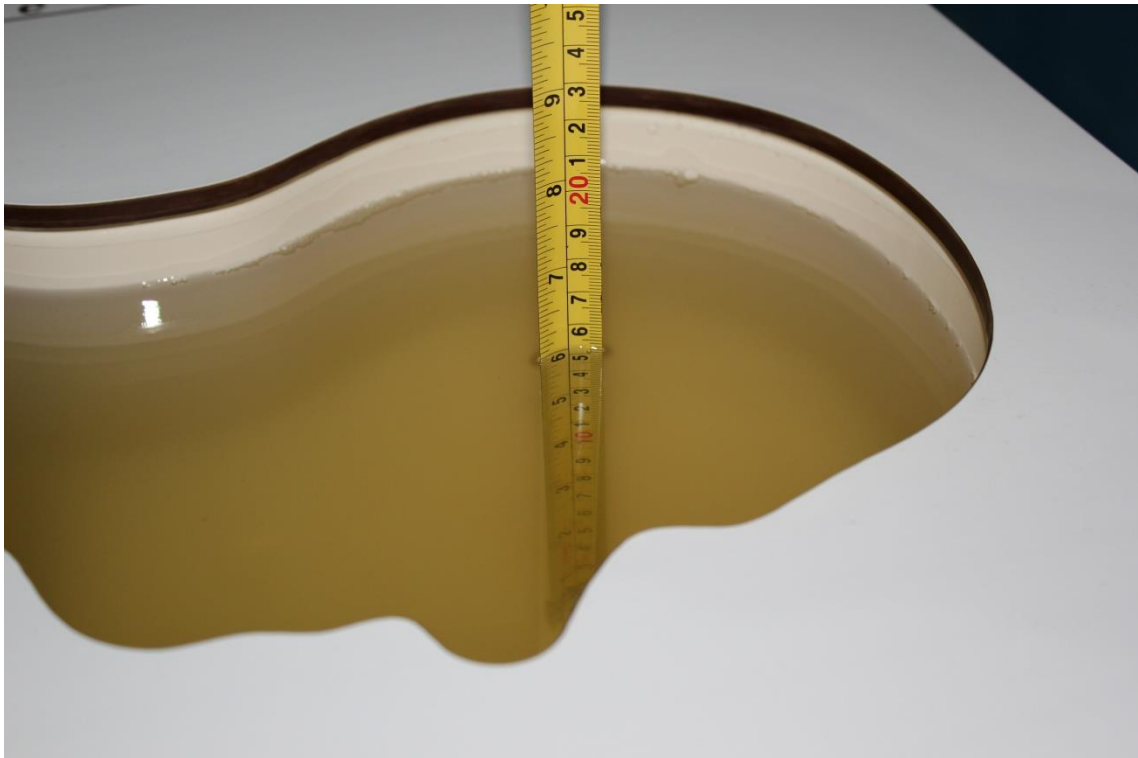

Picture 7-5 Liquid depth in the Head Phantom (2600MHz)



Picture 7-6 Liquid depth in the Head Phantom (2450 MHz)



Picture 7-7 Liquid depth in the Head Phantom (5GHz)

8 System verification

8.1 System Setup

In the simplified setup for system evaluation, the DUT is replaced by a calibrated dipole and the power source is replaced by a continuous wave that comes from a signal generator. The calibrated dipole must be placed beneath the flat phantom section of the SAM twin phantom with the correct distance holder. The distance holder should touch the phantom surface with a light pressure at the reference marking and be oriented parallel to the long side of the phantom. The equipment setup is shown below:

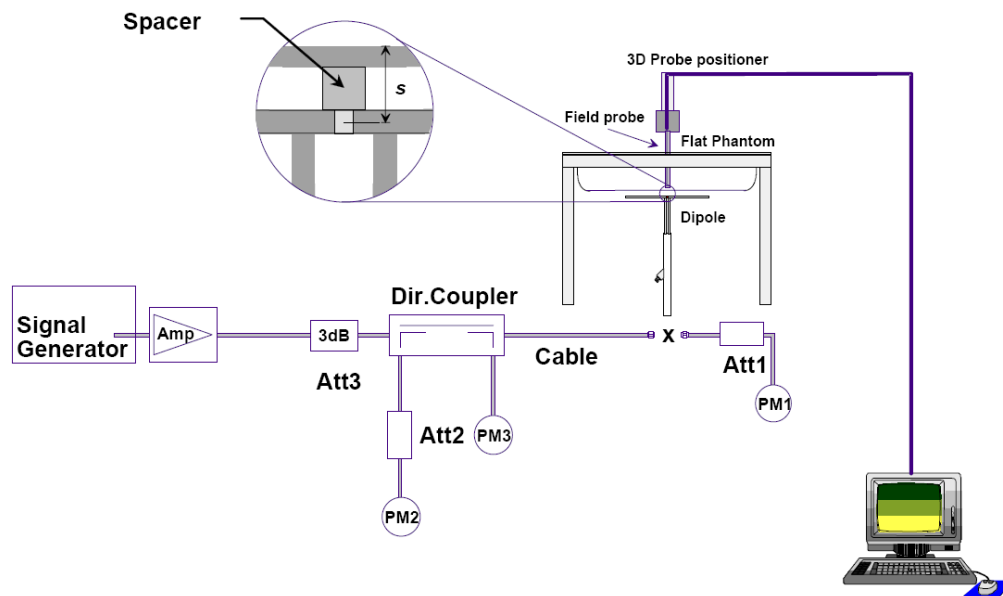

Picture 8.1 System Setup for System Evaluation



Picture 8.2 Photo of Dipole Setup

8.2 System Verification

SAR system verification is required to confirm measurement accuracy, according to the tissue dielectric media, probe calibration points and other system operating parameters required for measuring the SAR of a test device. The system verification must be performed for each frequency band and within the valid range of each probe calibration point required for testing the device.

The system verification results are required that the area scan estimated 1-g SAR is within 3% of the zoom scan 1-g SAR. The details are presented in annex B.

Table 8.1: System Verification of Head

Measurement Date (yyyy-mm-dd)	Frequency	Target value (W/kg)		Measured value (W/kg)		Deviation	
		10 g Average	1 g Average	10 g Average	1 g Average	10 g Average	1 g Average
2020/10/22	750 MHz	5.53	8.47	5.44	8.64	-1.63%	2.01%
2020/10/23	835 MHz	6.25	9.60	6.2	9.72	-0.80%	1.25%
2020/10/24	1750 MHz	19.1	36.5	19.48	36.36	1.99%	-0.38%
2020/10/25	1900 MHz	20.6	39.6	20.52	39.96	-0.39%	0.91%
2020/10/26	2450 MHz	24.5	52.5	24.8	52	1.22%	-0.95%
2020/10/27	2600 MHz	25.3	57.0	25.36	56.8	0.24%	-0.35%
2020/10/28	5250 MHz	22.9	80.5	23.2	80.0	1.14%	-0.62%
2020/10/29	5600 MHz	23.6	83.3	23.5	83.5	-0.34%	0.26%
2020/10/30	5750 MHz	22.7	80.4	23.0	79.6	1.32%	-1.00%

9 Measurement Procedures

9.1 Tests to be performed

In order to determine the highest value of the peak spatial-average SAR of a handset, all device positions, configurations and operational modes shall be tested for each frequency band according to steps 1 to 3 below. A flowchart of the test process is shown in picture 9.1.

Step 1: The tests described in 9.2 shall be performed at the channel that is closest to the centre of the transmit frequency band (•) for:

- a) all device positions (cheek and tilt, for both left and right sides of the SAM phantom, as described in annex D),
- b) all configurations for each device position in a), e.g., antenna extended and retracted, and
- c) all operational modes, e.g., analogue and digital, for each device position in a) and configuration in b) in each frequency band.

If more than three frequencies need to be tested according to 11.1 (i.e., $N_c > 3$), then all frequencies, configurations and modes shall be tested for all of the above test conditions.

Step 2: For the condition providing highest peak spatial-average SAR determined in Step 1, perform all tests described in 9.2 at all other test frequencies, i.e., lowest and highest frequencies. In addition, for all other conditions (device position, configuration and operational mode) where the peak spatial-average SAR value determined in Step 1 is within 3 dB of the applicable SAR limit, it is recommended that all other test frequencies shall be tested as well.

Step 3: Examine all data to determine the highest value of the peak spatial-average SAR found in Steps 1 to 2.

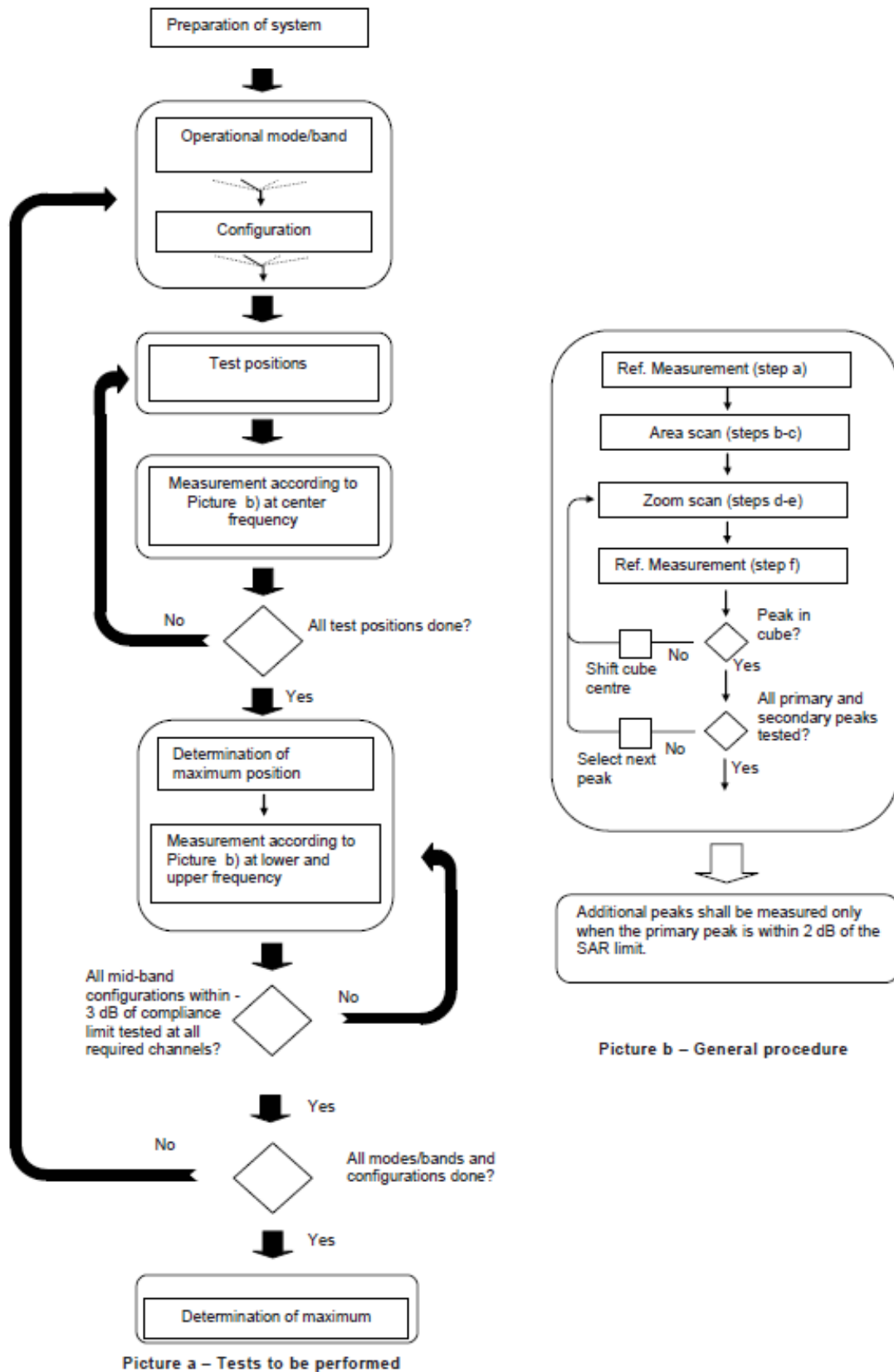

Picture 9.1 Block diagram of the tests to be performed

9.2 General Measurement Procedure

The area and zoom scan resolutions specified in the table below must be applied to the SAR measurements and fully documented in SAR reports to qualify for TCB approval. Probe boundary effect error compensation is required for measurements with the probe tip closer than half a probe tip diameter to the phantom surface. Both the probe tip diameter and sensor offset distance must satisfy measurement protocols; to ensure probe boundary effect errors are minimized and the higher fields closest to the phantom surface can be correctly measured and extrapolated to the phantom surface for computing 1-g SAR. Tolerances of the post-processing algorithms must be verified by the test laboratory for the scan resolutions used in the SAR measurements, according to the reference distribution functions specified in IEEE Std 1528-2003. The results should be documented as part of the system validation records and may be requested to support test results when all the measurement parameters in the following table are not satisfied.

		≤ 3 GHz	> 3 GHz
Maximum distance from closest measurement point (geometric center of probe sensors) to phantom surface		5 ± 1 mm	$\frac{\delta}{2} \cdot \ln(2) \pm 0.5$ mm
Maximum probe angle from probe axis to phantom surface normal at the measurement location		$30^\circ \pm 1^\circ$	$20^\circ \pm 1^\circ$
Maximum area scan spatial resolution: Δx_{Area} , Δy_{Area}		≤ 2 GHz: ≤ 15 mm 2 – 3 GHz: ≤ 12 mm	3 – 4 GHz: ≤ 12 mm 4 – 6 GHz: ≤ 10 mm
		When the x or y dimension of the test device, in the measurement plane orientation, is smaller than the above, the measurement resolution must be \leq the corresponding x or y dimension of the test device with at least one measurement point on the test device.	
Maximum zoom scan spatial resolution: Δx_{Zoom} , Δy_{Zoom}		≤ 2 GHz: ≤ 8 mm 2 – 3 GHz: ≤ 5 mm*	3 – 4 GHz: ≤ 5 mm* 4 – 6 GHz: ≤ 4 mm*
Maximum zoom scan spatial resolution, normal to phantom surface	uniform grid: $\Delta z_{Zoom}(n)$	≤ 5 mm	3 – 4 GHz: ≤ 4 mm 4 – 5 GHz: ≤ 3 mm 5 – 6 GHz: ≤ 2 mm
	graded grid	$\Delta z_{Zoom}(1)$: between 1 st two points closest to phantom surface	≤ 4 mm
		$\Delta z_{Zoom}(n>1)$: between subsequent points	$\leq 1.5 \cdot \Delta z_{Zoom}(n-1)$
Minimum zoom scan volume	x, y, z	≥ 30 mm	3 – 4 GHz: ≥ 28 mm 4 – 5 GHz: ≥ 25 mm 5 – 6 GHz: ≥ 22 mm
Note: δ is the penetration depth of a plane-wave at normal incidence to the tissue medium; see draft standard IEEE P1528-2011 for details. * When zoom scan is required and the <i>reported</i> SAR from the area scan based 1-g SAR estimation procedures of KDB 447498 is ≤ 1.4 W/kg, ≤ 8 mm, ≤ 7 mm and ≤ 5 mm zoom scan resolution may be applied, respectively, for 2 GHz to 3 GHz, 3 GHz to 4 GHz and 4 GHz to 6 GHz.			

9.3 SAR Measurement for LTE

SAR tests for LTE are performed with a base station simulator, Rohde & Schwarz CMW500. Closed loop power control was used so the UE transmits with maximum output power during SAR testing. All powers were measured with the CMW 500.

It is performed for conducted power and SAR based on the KDB941225 D05.

SAR is evaluated separately according to the following procedures for the different test positions in each exposure condition – head, body, body-worn accessories and other use conditions. The procedures in the following subsections are applied separately to test each LTE frequency band.

1) QPSK with 1 RB allocation

Start with the largest channel bandwidth and measure SAR for QPSK with 1 RB allocation, using the RB offset and required test channel combination with the highest maximum output power among RB offsets at the upper edge, middle and lower edge of each required test channel. When the reported SAR is ≤ 0.8 W/kg, testing of the remaining RB offset configurations and required test channels is not required for 1 RB allocation; otherwise, SAR is required for the remaining required test channels and only for the RB offset configuration with the highest output power for that channel. When the reported SAR of a required test channel is > 1.45 W/kg, SAR is required for all three RB offset configurations for that required test channel.

2) QPSK with 50% RB allocation

The procedures required for 1 RB allocation in 1) are applied to measure the SAR for QPSK with 50% RB allocation.

3) QPSK with 100% RB allocation

For QPSK with 100% RB allocation, SAR is not required when the highest maximum output power for 100 % RB allocation is less than the highest maximum output power in 50% and 1 RB allocations and the highest reported SAR for 1 RB and 50% RB allocation in 1) and 2) are ≤ 0.8 W/kg. Otherwise, SAR is measured for the highest output power channel; and if the reported SAR is > 1.45 W/kg, the remaining required test channels must also be tested.

9.4 Power Drift

To control the output power stability during the SAR test, DASY4 system calculates the power drift by measuring the E-field at the same location at the beginning and at the end of the measurement for each test position. These drift values can be found in section 14 labeled as: (Power Drift [dB]). This ensures that the power drift during one measurement is within 5%.

10 Area Scan Based 1-g SAR

10.1 Requirement of KDB

According to the KDB447498 D01, when the implementation is based the specific polynomial fit algorithm as presented at the 29th Bioelectromagnetics Society meeting (2007) and the estimated 1-gSAR is ≤ 1.2 W/kg, a zoom scan measurement is not required provided it is also not needed for any other purpose; for example, if the peak SAR location required for simultaneous transmission SAR test exclusion can be determined accurately by the SAR system or manually to discriminate between distinctive peaks and scattered noisy SAR distributions from area scans.

There must not be any warning or alert messages due to various measurement concerns identified by the SAR system; for example, noise in measurements, peaks too close to scan boundary, peaks are too sharp, spatial resolution and uncertainty issues etc. The SAR system verification must also demonstrate that the area scan estimated 1-g SAR is within 3% of the zoom scan 1-g SAR (See Annex B). When all the SAR results for each exposure condition in a frequency band and wireless mode are based on estimated 1-g SAR, the 1-g SAR for the highest SAR configuration must be determined by a zoom scan.

10.2 Fast SAR Algorithms

The approach is based on the area scan measurement applying a frequency dependent attenuation parameter. This attenuation parameter was empirically determined by analyzing a large number of phones. The MOTOROLA FAST SAR was developed and validated by the MOTOROLA Research Group in Ft. Lauderdale.

In the initial study, an approximation algorithm based on Linear fit was developed. The accuracy of the algorithm has been demonstrated across a broad frequency range (136-2450 MHz) and for both 1- and 10-g averaged SAR using a sample of 264 SAR measurements from 55 wireless handsets. For the sample size studied, the root-mean-squared errors of the algorithm are 1.2% and 5.8% for 1- and 10-g averaged SAR, respectively. The paper describing the algorithm in detail is expected to be published in August 2004 within the Special Issue of Transactions on MTT.

In the second step, the same research group optimized the fitting algorithm to an Polynomial fit whereby the frequency validity was extended to cover the range 30-6000MHz. Details of this study can be found in the BEMS 2007 Proceedings.

Both algorithms are implemented in DASYS software.

11 Conducted Output Power

There are three sets of tune-up power, Normal power and Low power, Low power includes sensor+ USB and sensor+ Non-USB, While the DUT is used independently, sensor+ Non-USB mode. While DUT is connected to PC and used as USB Dongle, sensor+ USB mode. for all bands by SAR sensor . The detail of SAR sensor is presented in annex I.

Normal Power	Sensor + Non-USB	Sensor + USB
Power Level A1	Power Level B1	Power Level C1

11.1 WCDMA Measurement result

Power Level A1

Table 11.1-1: The conducted Power for WCDMA

Item	band	FDDIV result			
	ARFCN	1513 (1752.6MHz)	1412 (1732.4MHz)	1312 (1712.4MHz)	
WCDMA	\	23.64	23.74	23.63	24.50
HSUPA	1	21.92	22.42	22.05	23.30
	2	21.33	21.46	21.10	22.30
	3	21.06	21.15	21.11	22.30
	4	21.37	21.52	21.46	22.80
	5	22.58	22.61	22.54	23.30
HSPA+(16QAM)	\	22.11	22.25	22.02	23.30
DC-HSDPA	1	22.48	22.65	22.56	23.30
	2	22.47	22.69	22.59	23.30
	3	21.91	22.25	22.14	22.80
	4	21.87	22.22	22.18	22.80
Item	band	FDDII result			Tune up
	ARFCN	9538 (1907.6MHz)	9400 (1880MHz)	9262 (1852.4MHz)	
WCDMA	\	23.79	23.71	23.65	24.50
HSUPA	1	22.41	22.12	22.15	23.30
	2	21.02	21.38	21.27	22.30
	3	21.08	21.31	21.33	22.30
	4	21.89	21.87	21.96	22.80
	5	22.52	22.49	22.42	23.30
DC-HSDPA	1	22.25	22.09	22.13	23.30
	2	22.63	22.57	22.49	23.30
	3	22.67	22.61	22.51	23.30
	4	22.14	22.12	22.13	22.80

Power Level B1
Table 11.1-2: The conducted Power for WCDMA

Item	band	FDDIV result			
	ARFCN	1513 (1752.6MHz)	1412 (1732.4MHz)	1312 (1712.4MHz)	
WCDMA	\	16.43	16.41	16.45	18.00
HSUPA	1	15.04	15.32	15.26	16.30
	2	14.09	14.37	14.00	15.30
	3	14.06	14.24	14.27	15.30
	4	14.64	14.92	14.77	15.80
	5	15.19	15.39	15.21	16.30
HSPA+(16QAM)	\	14.79	14.94	14.86	16.30
DC-HSDPA	1	15.29	15.28	15.33	16.30
	2	15.26	15.30	15.31	16.30
	3	14.52	14.85	14.58	15.80
	4	14.51	14.87	14.59	15.80
Item	band	FDDII result			Tune up
	ARFCN	9538 (1907.6MHz)	9400 (1880MHz)	9262 (1852.4MHz)	
WCDMA	\	17.23	17.21	17.20	18.00
HSUPA	1	15.27	15.28	15.34	16.30
	2	14.81	14.52	14.68	15.80
	3	15.09	15.05	14.75	16.00
	4	15.07	15.63	15.11	16.80
	5	16.20	16.19	16.11	17.10
DC-HSDPA	1	15.56	15.48	15.58	17.10
	2	16.12	16.08	16.01	17.00
	3	16.19	16.01	16.05	17.10
	4	15.75	15.61	15.65	16.80

Power Level C1
Table 11.1-3: The conducted Power for WCDMA

Item	band	FDDIV result			
	ARFCN	1513 (1752.6MHz)	1412 (1732.4MHz)	1312 (1712.4MHz)	
WCDMA	\	12.17	12.37	12.03	13.00
HSUPA	1	10.84	11.30	10.99	12.30
	2	9.93	10.29	9.97	11.30
	3	9.87	10.21	9.88	11.30
	4	10.51	10.90	10.45	11.80
	5	10.93	11.31	11.00	12.30
HSPA+(16QAM)	\	10.49	10.95	10.55	12.30
DC-HSDPA	1	10.98	11.38	11.01	12.30
	2	10.96	11.39	10.97	12.30
	3	10.41	10.91	10.49	11.80
	4	10.45	10.98	10.56	11.80
Item	band	FDDII result			Tune up
	ARFCN	9538 (1907.6MHz)	9400 (1880MHz)	9262 (1852.4MHz)	
WCDMA	\	13.18	12.59	12.79	13.50
HSUPA	1	11.94	11.60	11.57	12.80
	2	10.95	10.66	10.87	11.80
	3	10.93	10.56	10.75	11.80
	4	11.60	11.21	11.45	12.80
	5	12.17	11.71	11.89	13.10
DC-HSDPA	1	11.64	11.14	11.46	13.10
	2	12.47	11.64	11.87	13.30
	3	12.46	11.70	11.91	13.30
	4	12.05	11.28	11.47	13.00

11.2 LTE Measurement result
Table 11.2-1: Maximum Power Reduction (MPR) for LTE

Modulation	Channel bandwidth / Transmission bandwidth configuration [RB]						MPR (dB)
	1.4	3	5	10	15	20	
	MHz	MHz	MHz	MHz	MHz	MHz	
QPSK	> 5	> 4	> 8	> 12	> 16	> 18	1
16 QAM	≤ 5	≤ 4	≤ 8	≤ 12	≤ 16	≤ 18	1
16 QAM	> 5	> 4	> 8	> 12	> 16	> 18	2
64 QAM	≤ 5	≤ 4	≤ 8	≤ 12	≤ 16	≤ 18	2
64 QAM	> 5	> 4	> 8	> 12	> 16	> 18	3

Table 11.2-2: The tune up for LTE– Power Level A1

Band	Tune up
LTE Band 12	23.5
LTE Band 25	23.5
LTE Band 26	23.5
LTE Band 41	23.5
LTE Band 66	23.5
LTE Band 71	23.5

Table 11.2-2: The tune up for LTE– Power Level B1

Band	Tune up
LTE Band 12	22.5
LTE Band 25	18
LTE Band 26	21.5
LTE Band 41	17.5
LTE Band 66	18
LTE Band 71	21

Table 11.2-2: The tune up for LTE– Power Level C1

Band	Tune up
LTE Band 12	19.5
LTE Band 25	14.5
LTE Band 26	15.5
LTE Band 41	17.5
LTE Band 66	14.5
LTE Band 71	21

Table 11.2-4: The conducted Power for LTE

Power Level A1

Band12-Normal power				
BANDWIDTH	Number of RBs	Frequency	QPSK	16QAM
1.4MHz	1RB-High (5)	715.3 (23173)	22.95	22.06
		707.5 (23095)	22.88	21.95
		699.7 (23017)	22.95	22.04
	1RB-Middle (3)	715.3 (23173)	23.21	22.13
		707.5 (23095)	23.19	22.19
		699.7 (23017)	23.04	22.05
	1RB-Low (0)	715.3 (23173)	23.02	22.07
		707.5 (23095)	23.11	22.25
		699.7 (23017)	22.66	22.05
	3RB-High (3)	715.3 (23173)	23.04	21.90
		707.5 (23095)	22.92	22.14
		699.7 (23017)	22.92	21.78
	3RB-Middle (1)	715.3 (23173)	22.96	21.94
		707.5 (23095)	23.01	22.18
		699.7 (23017)	22.92	22.02
	3RB-Low (0)	715.3 (23173)	23.03	21.99
		707.5 (23095)	22.95	22.15
		699.7 (23017)	22.93	21.96
	6RB (0)	715.3 (23173)	22.14	21.21
		707.5 (23095)	22.06	21.07
		699.7 (23017)	21.99	20.76
3MHz	1RB-High (14)	714.5 (23165)	23.12	22.08
		707.5 (23095)	23.12	22.10
		700.5 (23025)	23.00	21.86
	1RB-Middle (7)	714.5 (23165)	23.12	22.41
		707.5 (23095)	23.13	22.05
		700.5 (23025)	23.10	21.72
	1RB-Low (0)	714.5 (23165)	23.10	22.16
		707.5 (23095)	22.96	21.98
		700.5 (23025)	22.82	21.57
	8RB-High (7)	714.5 (23165)	22.00	20.90
		707.5 (23095)	22.12	21.17
		700.5 (23025)	22.04	21.22
	8RB-Middle (4)	714.5 (23165)	22.11	21.13
		707.5 (23095)	22.08	21.16
		700.5 (23025)	22.03	21.22
	8RB-Low (0)	714.5 (23165)	22.16	21.09
		707.5 (23095)	22.08	21.16
		700.5 (23025)	21.92	21.31
	15RB (0)	714.5 (23165)	22.07	21.05
		707.5 (23095)	22.06	20.84
		700.5 (23025)	21.98	21.00

5MHz	1RB-High (24)	713.5 (23155)	22.69	22.01	
		707.5 (23095)	22.86	21.99	
		701.5 (23035)	22.81	21.90	
	1RB-Middle (12)	713.5 (23155)	23.04	22.31	
		707.5 (23095)	23.12	22.17	
		701.5 (23035)	22.78	22.04	
	1RB-Low (0)	713.5 (23155)	22.86	22.04	
		707.5 (23095)	22.93	22.04	
		701.5 (23035)	22.68	21.77	
	12RB-High (13)	713.5 (23155)	21.95	20.95	
		707.5 (23095)	22.04	20.98	
		701.5 (23035)	22.05	20.92	
	12RB-Middle (6)	713.5 (23155)	22.08	21.01	
		707.5 (23095)	22.18	20.97	
		701.5 (23035)	21.99	20.98	
	12RB-Low (0)	713.5 (23155)	21.99	21.02	
		707.5 (23095)	22.14	21.08	
		701.5 (23035)	21.89	20.89	
	25RB (0)	713.5 (23155)	21.96	21.00	
		707.5 (23095)	22.09	20.82	
		701.5 (23035)	22.02	21.06	
	10MHz	1RB-High (49)	711 (23130)	22.72	21.75
			707.5 (23095)	22.87	21.58
			704 (23060)	23.11	21.86
1RB-Middle (24)		711 (23130)	23.15	22.11	
		707.5 (23095)	23.01	22.06	
		704 (23060)	23.34	22.05	
1RB-Low (0)		711 (23130)	22.70	21.57	
		707.5 (23095)	22.64	21.61	
		704 (23060)	22.84	21.71	
25RB-High (25)		711 (23130)	21.99	21.10	
		707.5 (23095)	21.87	20.97	
		704 (23060)	21.99	21.11	
25RB-Middle (12)		711 (23130)	22.08	21.13	
		707.5 (23095)	21.95	21.17	
		704 (23060)	22.08	21.11	
25RB-Low (0)		711 (23130)	21.96	21.05	
		707.5 (23095)	21.90	21.10	
		704 (23060)	21.95	20.86	
50RB (0)		711 (23130)	22.00	20.93	
		707.5 (23095)	21.93	20.89	
		704 (23060)	22.06	20.97	

Band25-Normal power				
BANDWIDTH	Number of RBs	Frequency	QPSK	16QAM
1.4MHz	1RB-High (5)	1914.3 (26683)	22.40	21.52
		1882.5 (26365)	22.40	21.38
		1850.7 (26047)	22.35	21.41
	1RB-Middle (3)	1914.3 (26683)	22.53	21.57
		1882.5 (26365)	22.48	21.35
		1850.7 (26047)	22.38	21.40
	1RB-Low (0)	1914.3 (26683)	22.38	21.52
		1882.5 (26365)	22.40	21.35
		1850.7 (26047)	22.30	21.34
	3RB-High (3)	1914.3 (26683)	22.50	21.59
		1882.5 (26365)	22.46	21.23
		1850.7 (26047)	22.46	21.15
	3RB-Middle (1)	1914.3 (26683)	22.52	21.75
		1882.5 (26365)	22.50	21.37
		1850.7 (26047)	22.42	21.18
	3RB-Low (0)	1914.3 (26683)	22.48	21.65
		1882.5 (26365)	22.47	21.50
		1850.7 (26047)	22.44	21.14
	6RB (0)	1914.3 (26683)	21.60	20.83
		1882.5 (26365)	21.52	20.70
		1850.7 (26047)	21.54	20.15
3MHz	1RB-High (14)	1913.5 (26675)	22.64	21.92
		1882.5 (26365)	22.35	21.53
		1851.5 (26055)	22.40	21.48
	1RB-Middle (7)	1913.5 (26675)	22.78	21.58
		1882.5 (26365)	22.32	21.48
		1851.5 (26055)	22.52	21.59
	1RB-Low (0)	1913.5 (26675)	22.99	22.20
		1882.5 (26365)	22.46	21.61
		1851.5 (26055)	22.77	21.47
	8RB-High (7)	1913.5 (26675)	21.78	21.22
		1882.5 (26365)	21.54	20.29
		1851.5 (26055)	21.59	20.31
	8RB-Middle (4)	1913.5 (26675)	21.75	21.20
		1882.5 (26365)	21.61	20.47
		1851.5 (26055)	21.59	20.36
	8RB-Low (0)	1913.5 (26675)	21.69	20.90
		1882.5 (26365)	21.64	20.50
		1851.5 (26055)	21.64	20.17
15RB (0)	1913.5 (26675)	21.70	20.61	
	1882.5 (26365)	21.59	20.57	
	1851.5 (26055)	21.57	20.25	

5MHz	1RB-High (24)	1912.5 (26665)	22.44	21.74	
		1882.5 (26365)	22.45	21.48	
		1852.5 (26065)	22.41	20.98	
	1RB-Middle (12)	1912.5 (26665)	22.55	21.59	
		1882.5 (26365)	22.51	21.54	
		1852.5 (26065)	22.69	21.19	
	1RB-Low (0)	1912.5 (26665)	22.46	21.24	
		1882.5 (26365)	22.60	21.71	
		1852.5 (26065)	22.76	21.50	
	12RB-High (13)	1912.5 (26665)	21.73	20.61	
		1882.5 (26365)	21.53	20.51	
		1852.5 (26065)	21.53	20.24	
	12RB-Middle (6)	1912.5 (26665)	21.66	20.57	
		1882.5 (26365)	21.63	20.59	
		1852.5 (26065)	21.63	20.54	
	12RB-Low (0)	1912.5 (26665)	21.70	20.69	
		1882.5 (26365)	21.62	20.53	
		1852.5 (26065)	21.60	20.60	
	25RB (0)	1912.5 (26665)	21.75	20.80	
		1882.5 (26365)	21.62	20.41	
		1852.5 (26065)	21.50	20.59	
	10MHz	1RB-High (49)	1910 (26640)	22.56	21.69
			1882.5 (26365)	22.51	21.54
			1855 (26090)	22.43	20.85
1RB-Middle (24)		1910 (26640)	22.51	21.73	
		1882.5 (26365)	22.65	21.92	
		1855 (26090)	22.64	21.11	
1RB-Low (0)		1910 (26640)	22.67	21.73	
		1882.5 (26365)	22.54	22.04	
		1855 (26090)	22.52	21.16	
25RB-High (25)		1910 (26640)	21.56	20.70	
		1882.5 (26365)	21.45	20.53	
		1855 (26090)	21.40	20.32	
25RB-Middle (12)		1910 (26640)	21.51	20.72	
		1882.5 (26365)	21.46	20.52	
		1855 (26090)	21.54	20.38	
25RB-Low (0)		1910 (26640)	21.62	20.63	
		1882.5 (26365)	21.47	20.53	
		1855 (26090)	21.52	20.54	
50RB (0)		1910 (26640)	21.52	20.47	
		1882.5 (26365)	21.37	20.36	
		1855 (26090)	21.37	20.16	

15MHz	1RB-High (74)	1907.5 (26615)	22.48	20.95
		1882.5 (26365)	22.32	21.65
		1857.5 (26115)	22.47	21.26
	1RB-Middle (37)	1907.5 (26615)	22.57	21.31
		1882.5 (26365)	22.64	21.91
		1857.5 (26115)	22.40	21.26
	1RB-Low (0)	1907.5 (26615)	22.97	21.64
		1882.5 (26365)	22.76	22.11
		1857.5 (26115)	22.70	21.48
	36RB-High (38)	1907.5 (26615)	21.51	20.41
		1882.5 (26365)	21.45	20.32
		1857.5 (26115)	21.38	20.24
	36RB-Middle (19)	1907.5 (26615)	21.60	20.49
		1882.5 (26365)	21.57	20.44
		1857.5 (26115)	21.31	20.25
	36RB-Low (0)	1907.5 (26615)	21.65	20.61
		1882.5 (26365)	21.59	20.52
		1857.5 (26115)	21.43	20.26
	75RB (0)	1907.5 (26615)	21.53	20.33
		1882.5 (26365)	21.45	20.41
		1857.5 (26115)	21.36	20.31
20MHz	1RB-High (99)	1905 (26590)	22.76	21.44
		1882.5 (26365)	22.45	21.31
		1860 (26140)	22.13	21.39
	1RB-Middle (50)	1905 (26590)	22.95	21.41
		1882.5 (26365)	22.78	21.47
		1860 (26140)	22.29	20.94
	1RB-Low (0)	1905 (26590)	22.75	21.31
		1882.5 (26365)	22.45	21.33
		1860 (26140)	22.30	21.49
	50RB-High (50)	1905 (26590)	21.66	20.64
		1882.5 (26365)	21.51	20.44
		1860 (26140)	21.50	20.48
	50RB-Middle (25)	1905 (26590)	21.81	20.80
		1882.5 (26365)	21.59	20.52
		1860 (26140)	21.47	20.50
	50RB-Low (0)	1905 (26590)	21.84	20.63
		1882.5 (26365)	21.60	20.61
		1860 (26140)	21.48	20.51
	100RB (0)	1905 (26590)	21.76	20.63
		1882.5 (26365)	21.56	20.51
		1860 (26140)	21.62	20.55

Band26-Normal power					
BANDWIDTH	Number of RBs	Frequency	QPSK	16QAM	
1.4MHz	1RB-High (5)	848.3 (27033)	23.08	22.11	
		831.5 (26865)	22.90	22.02	
		814.7 (26697)	23.01	22.18	
	1RB-Middle (3)	848.3 (27033)	23.32	22.24	
		831.5 (26865)	23.04	22.17	
		814.7 (26697)	23.22	22.09	
	1RB-Low (0)	848.3 (27033)	23.01	22.13	
		831.5 (26865)	22.99	22.09	
		814.7 (26697)	23.03	22.04	
	3RB-High (3)	848.3 (27033)	22.89	21.89	
		831.5 (26865)	23.10	22.19	
		814.7 (26697)	23.03	22.29	
	3RB-Middle (1)	848.3 (27033)	23.06	21.89	
		831.5 (26865)	23.12	22.24	
		814.7 (26697)	23.12	22.36	
	3RB-Low (0)	848.3 (27033)	23.12	21.81	
		831.5 (26865)	23.03	22.22	
		814.7 (26697)	23.09	22.44	
	6RB (0)	848.3 (27033)	22.10	20.78	
		831.5 (26865)	22.03	21.19	
		814.7 (26697)	22.06	21.45	
	3MHz	1RB-High (14)	847.5 (27025)	23.06	21.91
			831.5 (26865)	22.74	21.89
			815.5 (26705)	23.00	21.71
1RB-Middle (7)		847.5 (27025)	23.39	22.24	
		831.5 (26865)	23.14	21.98	
		815.5 (26705)	23.13	21.55	
1RB-Low (0)		847.5 (27025)	23.33	21.72	
		831.5 (26865)	23.17	22.14	
		815.5 (26705)	23.25	21.70	
8RB-High (7)		847.5 (27025)	22.00	20.94	
		831.5 (26865)	22.04	20.72	
		815.5 (26705)	21.98	20.79	
8RB-Middle (4)		847.5 (27025)	22.12	21.04	
		831.5 (26865)	22.08	20.84	
		815.5 (26705)	22.01	20.84	
8RB-Low (0)		847.5 (27025)	22.15	21.19	
		831.5 (26865)	22.06	20.74	
		815.5 (26705)	22.12	20.73	
15RB (0)		847.5 (27025)	22.09	21.01	
		831.5 (26865)	22.06	20.83	
		815.5 (26705)	22.11	20.82	

5MHz	1RB-High (24)	846.5 (27015)	22.90	21.47
		831.5 (26865)	22.50	21.43
		816.5 (26715)	22.88	22.05
	1RB-Middle (12)	846.5 (27015)	23.04	22.01
		831.5 (26865)	22.91	21.78
		816.5 (26715)	22.97	22.26
	1RB-Low (0)	846.5 (27015)	22.88	21.62
		831.5 (26865)	22.97	21.82
		816.5 (26715)	22.76	22.11
	12RB-High (13)	846.5 (27015)	22.00	20.79
		831.5 (26865)	21.93	20.87
		816.5 (26715)	22.14	20.81
	12RB-Middle (6)	846.5 (27015)	22.09	21.13
		831.5 (26865)	22.06	20.99
		816.5 (26715)	22.17	20.86
	12RB-Low (0)	846.5 (27015)	22.02	21.13
		831.5 (26865)	22.10	21.03
		816.5 (26715)	22.04	20.83
	25RB (0)	846.5 (27015)	21.98	20.92
		831.5 (26865)	22.02	21.07
		816.5 (26715)	22.06	20.96
10MHz	1RB-High (49)	844 (26990)	22.82	21.78
		831.5 (26865)	22.86	21.58
		820 (26750)	23.04	22.02
	1RB-Middle (24)	844 (26990)	23.21	21.96
		831.5 (26865)	23.14	21.97
		820 (26750)	23.06	22.05
	1RB-Low (0)	844 (26990)	22.73	21.60
		831.5 (26865)	22.87	22.16
		820 (26750)	23.31	22.08
	25RB-High (25)	844 (26990)	21.98	21.04
		831.5 (26865)	21.90	20.92
		820 (26750)	22.01	20.90
	25RB-Middle (12)	844 (26990)	22.06	21.05
		831.5 (26865)	21.99	21.03
		820 (26750)	22.00	20.88
	25RB-Low (0)	844 (26990)	21.98	21.00
		831.5 (26865)	22.02	21.10
		820 (26750)	22.10	20.85
	50RB (0)	844 (26990)	21.97	21.00
		831.5 (26865)	21.99	20.98
		820 (26750)	21.99	20.87

15MHz	1RB-High (74)	841.5 (26965)	23.02	21.99
		831.5 (26865)	23.18	21.79
		822.5 (26775)	22.93	22.44
	1RB-Middle (37)	841.5 (26965)	23.42	22.19
		831.5 (26865)	23.29	22.09
		822.5 (26775)	22.86	22.41
	1RB-Low (0)	841.5 (26965)	23.22	21.63
		831.5 (26865)	22.95	21.82
		822.5 (26775)	22.89	22.43
	36RB-High (38)	841.5 (26965)	22.00	20.93
		831.5 (26865)	21.97	20.94
		822.5 (26775)	22.08	21.11
	36RB-Middle (19)	841.5 (26965)	21.97	20.99
		831.5 (26865)	22.08	21.08
		822.5 (26775)	22.12	20.91
	36RB-Low (0)	841.5 (26965)	21.92	20.94
		831.5 (26865)	22.06	21.02
		822.5 (26775)	22.11	20.82
	75RB (0)	841.5 (26965)	21.95	20.82
		831.5 (26865)	21.98	20.97
		822.5 (26775)	22.07	21.07

Band41-Normal power				
BANDWIDTH	Number of RBs	Frequency	QPSK	16QAM
5MHz	1RB-High (24)	2687.5 (41565)	22.96	21.59
		2640.3(41093)	22.82	22.19
		2593 (40620)	22.92	21.75
		2545.8(40148)	22.82	21.60
		2498.5 (39675)	22.86	22.05
	1RB-Middle (12)	2687.5 (41565)	23.34	21.70
		2640.3(41093)	23.30	22.40
		2593 (40620)	23.33	22.24
		2545.8(40148)	23.15	21.84
		2498.5 (39675)	23.05	22.32
	1RB-Low (0)	2687.5 (41565)	22.89	21.55
		2640.3(41093)	22.85	22.11
		2593 (40620)	23.04	21.65
		2545.8(40148)	22.73	21.87
		2498.5 (39675)	22.81	22.06
	12RB-High (13)	2687.5 (41565)	21.93	21.06
		2640.3(41093)	22.19	21.22
		2593 (40620)	22.17	20.84
		2545.8(40148)	21.98	21.05
		2498.5 (39675)	22.14	21.03
	12RB-Middle (6)	2687.5 (41565)	21.99	20.96
		2640.3(41093)	22.30	21.26
		2593 (40620)	22.03	20.88
		2545.8(40148)	22.02	20.86
		2498.5 (39675)	21.97	21.03
	12RB-Low (0)	2687.5 (41565)	21.92	20.90
		2640.3(41093)	22.21	21.17
		2593 (40620)	21.95	21.17
		2545.8(40148)	21.86	20.94
		2498.5 (39675)	21.86	20.95
25RB (0)	2687.5 (41565)	21.96	21.27	
	2640.3(41093)	22.31	21.03	
	2593 (40620)	22.05	21.31	
	2545.8(40148)	21.92	21.05	
	2498.5 (39675)	22.01	20.93	

10MHz	1RB-High (49)	2685 (41540)	22.95	22.06
		2639(41080)	22.83	22.49
		2593 (40620)	22.93	21.22
		2547(40160)	22.92	21.52
		2501 (39700)	22.97	22.42
	1RB-Middle (24)	2685 (41540)	23.15	21.06
		2639(41080)	23.20	21.58
		2593 (40620)	23.35	21.83
		2547(40160)	23.12	22.01
		2501 (39700)	23.30	22.16
	1RB-Low (0)	2685 (41540)	23.05	22.06
		2639(41080)	22.87	22.03
		2593 (40620)	23.05	21.23
		2547(40160)	22.87	22.18
		2501 (39700)	22.84	22.32
	25RB-High (25)	2685 (41540)	22.01	21.44
		2639(41080)	22.34	21.27
		2593 (40620)	22.22	21.08
		2547(40160)	22.03	20.96
		2501 (39700)	22.14	21.15
	25RB-Middle (12)	2685 (41540)	22.06	21.03
		2639(41080)	22.33	21.21
		2593 (40620)	22.21	21.01
		2547(40160)	22.27	20.96
		2501 (39700)	21.98	21.24
25RB-Low (0)	2685 (41540)	22.00	20.96	
	2639(41080)	22.24	21.26	
	2593 (40620)	22.01	20.88	
	2547(40160)	21.92	20.93	
	2501 (39700)	22.04	20.91	
50RB (0)	2685 (41540)	22.01	21.08	
	2639(41080)	22.09	21.05	
	2593 (40620)	22.18	21.14	
	2547(40160)	22.10	21.02	
	2501 (39700)	21.96	20.98	

15MHz	1RB-High (74)	2682.5 (41515)	23.20	21.71
		2637.8(41068)	23.13	21.63
		2593 (40620)	22.82	22.40
		2548.3(40173)	23.06	22.50
		2503.5 (39725)	23.05	21.45
	1RB-Middle (37)	2682.5 (41515)	23.25	22.45
		2637.8(41068)	23.19	21.28
		2593 (40620)	23.24	21.82
		2548.3(40173)	23.43	21.72
		2503.5 (39725)	23.16	21.57
	1RB-Low (0)	2682.5 (41515)	23.19	22.50
		2637.8(41068)	23.08	21.29
		2593 (40620)	23.02	22.49
		2548.3(40173)	23.11	22.43
		2503.5 (39725)	22.85	21.33
	36RB-High (38)	2682.5 (41515)	21.92	21.01
		2637.8(41068)	22.14	21.09
		2593 (40620)	22.22	21.06
		2548.3(40173)	22.03	20.96
		2503.5 (39725)	21.95	20.93
	36RB-Middle (19)	2682.5 (41515)	21.92	21.01
		2637.8(41068)	22.23	21.18
		2593 (40620)	22.11	21.18
		2548.3(40173)	22.18	20.94
		2503.5 (39725)	22.00	20.96
	36RB-Low (0)	2682.5 (41515)	21.90	20.91
		2637.8(41068)	21.98	21.00
		2593 (40620)	22.05	20.87
2548.3(40173)		21.92	20.80	
2503.5 (39725)		21.73	20.76	
75RB (0)	2682.5 (41515)	21.89	20.94	
	2637.8(41068)	22.09	21.07	
	2593 (40620)	22.02	21.10	
	2548.3(40173)	21.91	20.80	
	2503.5 (39725)	21.87	20.93	

20MHz	1RB-High (99)	2680 (41490)	23.23	21.80
		2636.5(41055)	23.08	21.24
		2593 (40620)	22.71	22.18
		2549.5(40185)	23.03	21.45
		2506 (39750)	23.13	21.19
	1RB-Middle (50)	2680 (41490)	23.42	22.17
		2636.5(41055)	23.36	21.37
		2593 (40620)	23.28	22.48
		2549.5(40185)	23.18	22.36
		2506 (39750)	23.40	21.32
	1RB-Low (0)	2680 (41490)	23.14	21.37
		2636.5(41055)	23.08	21.27
		2593 (40620)	22.92	22.36
		2549.5(40185)	23.18	21.56
		2506 (39750)	22.85	21.10
	50RB-High (50)	2680 (41490)	22.06	20.98
		2636.5(41055)	22.19	21.09
		2593 (40620)	22.28	21.19
		2549.5(40185)	22.01	20.87
		2506 (39750)	22.01	20.93
	50RB-Middle (25)	2680 (41490)	21.97	21.05
		2636.5(41055)	22.07	21.10
		2593 (40620)	22.19	21.19
		2549.5(40185)	21.99	21.02
		2506 (39750)	22.01	21.05
50RB-Low (0)	2680 (41490)	21.98	20.94	
	2636.5(41055)	22.01	20.90	
	2593 (40620)	22.02	21.02	
	2549.5(40185)	21.87	20.89	
	2506 (39750)	21.96	20.78	
100RB (0)	2680 (41490)	22.03	20.94	
	2636.5(41055)	22.03	20.92	
	2593 (40620)	22.00	21.07	
	2549.5(40185)	21.97	20.85	
	2506 (39750)	22.03	20.79	

Band66-Normal power				
BANDWIDTH	Number of RBs	Frequency	QPSK	16QAM
1.4MHz	1RB-High (5)	1779.3 (132665)	22.64	21.40
		1745 (132322)	22.69	21.74
		1710.7 (131979)	22.45	21.57
	1RB-Middle (3)	1779.3 (132665)	22.72	21.44
		1745 (132322)	22.75	21.76
		1710.7 (131979)	22.48	21.29
	1RB-Low (0)	1779.3 (132665)	22.71	21.44
		1745 (132322)	22.73	21.76
		1710.7 (131979)	22.39	21.21
	3RB-High (3)	1779.3 (132665)	22.57	21.45
		1745 (132322)	22.59	21.46
		1710.7 (131979)	22.59	21.36
	3RB-Middle (1)	1779.3 (132665)	22.68	21.86
		1745 (132322)	22.66	21.30
		1710.7 (131979)	22.51	21.40
	3RB-Low (0)	1779.3 (132665)	22.67	21.85
		1745 (132322)	22.63	21.25
		1710.7 (131979)	22.36	21.36
	6RB (0)	1779.3 (132665)	21.58	20.95
		1745 (132322)	21.56	20.73
		1710.7 (131979)	21.39	20.60
3MHz	1RB-High (14)	1778.5 (132657)	22.62	21.14
		1745 (132322)	22.50	21.85
		1711.5 (131987)	22.58	21.37
	1RB-Middle (7)	1778.5 (132657)	22.70	21.59
		1745 (132322)	22.78	21.85
		1711.5 (131987)	22.60	21.50
	1RB-Low (0)	1778.5 (132657)	22.71	21.62
		1745 (132322)	22.71	21.41
		1711.5 (131987)	22.38	21.41
	8RB-High (7)	1778.5 (132657)	21.36	20.67
		1745 (132322)	21.62	20.70
		1711.5 (131987)	21.46	20.45
	8RB-Middle (4)	1778.5 (132657)	21.46	20.66
		1745 (132322)	21.68	20.82
		1711.5 (131987)	21.55	20.54
	8RB-Low (0)	1778.5 (132657)	21.45	20.62
		1745 (132322)	21.60	20.79
		1711.5 (131987)	21.50	20.49
	15RB (0)	1778.5 (132657)	21.48	20.47
		1745 (132322)	21.57	20.73
		1711.5 (131987)	21.53	20.34

5MHz	1RB-High (24)	1777.5 (132647)	22.44	21.42
		1745 (132322)	22.51	21.60
		1712.5 (131997)	22.52	21.67
	1RB-Middle (12)	1777.5 (132647)	22.85	21.50
		1745 (132322)	22.71	21.85
		1712.5 (131997)	22.62	21.47
	1RB-Low (0)	1777.5 (132647)	22.70	21.33
		1745 (132322)	22.41	21.96
		1712.5 (131997)	22.60	21.30
	12RB-High (13)	1777.5 (132647)	21.55	20.42
		1745 (132322)	21.63	20.74
		1712.5 (131997)	21.52	20.30
	12RB-Middle (6)	1777.5 (132647)	21.67	20.62
		1745 (132322)	21.75	20.78
		1712.5 (131997)	21.63	20.58
	12RB-Low (0)	1777.5 (132647)	21.67	20.52
		1745 (132322)	21.67	20.81
		1712.5 (131997)	21.66	20.50
25RB (0)	1777.5 (132647)	21.65	20.55	
	1745 (132322)	21.71	20.75	
	1712.5 (131997)	21.59	20.36	
10MHz	1RB-High (49)	1775 (132622)	22.61	21.02
		1745 (132322)	22.60	21.38
		1715 (132022)	22.39	21.28
	1RB-Middle (24)	1775 (132622)	22.53	21.67
		1745 (132322)	23.22	22.35
		1715 (132022)	22.91	21.76
	1RB-Low (0)	1775 (132622)	22.38	21.63
		1745 (132322)	22.64	21.80
		1715 (132022)	22.54	20.98
	25RB-High (25)	1775 (132622)	21.46	20.59
		1745 (132322)	21.82	20.81
		1715 (132022)	21.51	20.61
	25RB-Middle (12)	1775 (132622)	21.61	20.75
		1745 (132322)	21.83	20.99
		1715 (132022)	21.67	20.90
	25RB-Low (0)	1775 (132622)	21.51	20.63
		1745 (132322)	21.71	20.75
		1715 (132022)	21.79	20.88
50RB (0)	1775 (132622)	21.45	20.45	
	1745 (132322)	21.69	20.71	
	1715 (132022)	21.56	20.53	

15MHz	1RB-High (74)	1772.5 (132597)	22.54	21.03
		1745 (132322)	22.68	22.24
		1717.5 (132047)	22.52	21.57
	1RB-Middle (37)	1772.5 (132597)	22.63	21.67
		1745 (132322)	22.64	22.15
		1717.5 (132047)	22.88	22.23
	1RB-Low (0)	1772.5 (132597)	22.53	21.07
		1745 (132322)	22.55	22.37
		1717.5 (132047)	22.51	21.67
	36RB-High (38)	1772.5 (132597)	21.65	20.55
		1745 (132322)	21.70	20.77
		1717.5 (132047)	21.63	20.58
	36RB-Middle (19)	1772.5 (132597)	21.57	20.55
		1745 (132322)	21.76	20.84
		1717.5 (132047)	21.70	20.59
	36RB-Low (0)	1772.5 (132597)	21.62	20.51
		1745 (132322)	21.65	20.58
		1717.5 (132047)	21.58	20.61
75RB (0)	1772.5 (132597)	21.60	20.53	
	1745 (132322)	21.66	20.77	
	1717.5 (132047)	21.55	20.61	
20MHz	1RB-High (99)	1770 (132572)	22.34	21.70
		1745 (132322)	22.76	21.49
		1720 (132072)	22.40	21.37
	1RB-Middle (50)	1770 (132572)	23.00	22.01
		1745 (132322)	23.24	21.69
		1720 (132072)	23.01	21.62
	1RB-Low (0)	1770 (132572)	22.41	21.03
		1745 (132322)	22.99	21.61
		1720 (132072)	22.33	21.45
	50RB-High (50)	1770 (132572)	21.59	20.61
		1745 (132322)	21.67	20.60
		1720 (132072)	21.67	20.62
	50RB-Middle (25)	1770 (132572)	21.56	20.51
		1745 (132322)	21.74	20.74
		1720 (132072)	21.57	20.54
	50RB-Low (0)	1770 (132572)	21.45	20.55
		1745 (132322)	21.76	20.58
		1720 (132072)	21.53	20.49
100RB (0)	1770 (132572)	21.45	20.56	
	1745 (132322)	21.75	20.75	
	1720 (132072)	21.63	20.61	

Band71-Normal power				
BANDWIDTH	Number of RBs	Frequency	QPSK	16QAM
5MHz	1RB-High (24)	695.5 (133447)	22.52	21.77
		680.5 (133297)	22.54	21.49
		665.5 (133147)	22.79	21.59
	1RB-Middle (12)	695.5 (133447)	22.46	21.40
		680.5 (133297)	22.75	21.24
		665.5 (133147)	23.00	21.78
	1RB-Low (0)	695.5 (133447)	22.05	21.22
		680.5 (133297)	22.42	21.03
		665.5 (133147)	22.68	20.94
	12RB-High (13)	695.5 (133447)	21.75	20.87
		680.5 (133297)	21.64	20.51
		665.5 (133147)	21.82	20.78
	12RB-Middle (6)	695.5 (133447)	21.69	20.69
		680.5 (133297)	21.66	20.52
		665.5 (133147)	21.89	20.81
	12RB-Low (0)	695.5 (133447)	21.71	20.67
		680.5 (133297)	21.60	20.54
		665.5 (133147)	21.65	20.53
	25RB (0)	695.5 (133447)	21.78	20.79
		680.5 (133297)	21.63	20.55
		665.5 (133147)	21.78	20.88
10MHz	1RB-High (49)	693 (132422)	22.78	21.58
		680.5 (133297)	22.79	21.81
		668 (133172)	22.99	21.45
	1RB-Middle (24)	693 (132422)	22.57	21.35
		680.5 (133297)	22.81	21.82
		668 (133172)	23.17	22.49
	1RB-Low (0)	693 (132422)	22.44	21.12
		680.5 (133297)	22.66	21.38
		668 (133172)	22.81	21.55
	25RB-High (25)	693 (132422)	21.81	20.99
		680.5 (133297)	21.71	20.77
		668 (133172)	21.74	20.67
	25RB-Middle (12)	693 (132422)	21.71	20.89
		680.5 (133297)	21.75	20.63
		668 (133172)	21.76	20.78
	25RB-Low (0)	693 (132422)	21.61	20.64
		680.5 (133297)	21.62	20.51
		668 (133172)	21.72	20.73
	50RB (0)	693 (132422)	21.81	20.68
		680.5 (133297)	21.72	20.66
		668 (133172)	21.64	20.64

15MHz	1RB-High (74)	690.5 (133397)	23.06	22.42
		680.5 (133297)	22.53	21.46
		670.5 (133197)	22.62	22.33
	1RB-Middle (37)	690.5 (133397)	22.89	21.80
		680.5 (133297)	22.60	21.67
		670.5 (133197)	22.66	22.49
	1RB-Low (0)	690.5 (133397)	22.84	21.54
		680.5 (133297)	22.50	21.00
		670.5 (133197)	22.59	21.94
	36RB-High (38)	690.5 (133397)	21.85	20.70
		680.5 (133297)	21.68	20.67
		670.5 (133197)	21.76	20.61
	36RB-Middle (19)	690.5 (133397)	21.70	20.63
		680.5 (133297)	21.67	20.81
		670.5 (133197)	21.71	20.59
	36RB-Low (0)	690.5 (133397)	21.60	20.50
		680.5 (133297)	21.58	20.73
		670.5 (133197)	21.66	20.73
	75RB (0)	690.5 (133397)	21.76	20.64
		680.5 (133297)	21.65	20.58
		670.5 (133197)	21.71	20.67
20MHz	1RB-High (99)	688 (133372)	22.31	21.52
		683 (133322)	22.91	21.46
		673 (133222)	22.62	21.24
	1RB-Middle (50)	688 (133372)	22.39	21.30
		683 (133322)	22.98	21.76
		673 (133222)	22.90	21.32
	1RB-Low (0)	688 (133372)	22.00	20.93
		683 (133322)	22.51	20.97
		673 (133222)	22.29	21.19
	50RB-High (50)	688 (133372)	21.69	20.55
		683 (133322)	21.76	20.66
		673 (133222)	21.76	20.73
	50RB-Middle (25)	688 (133372)	21.75	20.84
		683 (133322)	21.72	20.74
		673 (133222)	21.75	20.73
	50RB-Low (0)	688 (133372)	21.66	20.75
		683 (133322)	21.57	20.57
		673 (133222)	21.56	20.64
	100RB (0)	688 (133372)	21.62	20.61
		683 (133322)	21.64	20.62
		673 (133222)	21.73	20.73

Power Level B1

Band12-Sensor + Non-USB				
BANDWIDTH	Number of RBs	Frequency	QPSK	16QAM
1.4MHz	1RB-High (5)	715.3 (23173)	20.98	20.25
		707.5 (23095)	21.25	20.08
		699.7 (23017)	20.97	20.00
	1RB-Middle (3)	715.3 (23173)	21.29	20.12
		707.5 (23095)	21.17	20.11
		699.7 (23017)	21.24	19.79
	1RB-Low (0)	715.3 (23173)	20.79	20.16
		707.5 (23095)	21.08	20.11
		699.7 (23017)	21.08	19.98
	3RB-High (3)	715.3 (23173)	21.01	20.20
		707.5 (23095)	21.11	19.87
		699.7 (23017)	20.98	20.21
	3RB-Middle (1)	715.3 (23173)	21.22	20.28
		707.5 (23095)	21.13	19.85
		699.7 (23017)	20.97	20.22
	3RB-Low (0)	715.3 (23173)	20.99	20.04
		707.5 (23095)	21.09	19.83
		699.7 (23017)	21.00	20.15
	6RB (0)	715.3 (23173)	20.02	19.10
		707.5 (23095)	20.15	18.74
		699.7 (23017)	20.04	19.11
3MHz	1RB-High (14)	714.5 (23165)	21.12	19.93
		707.5 (23095)	20.94	20.05
		700.5 (23025)	20.99	20.07
	1RB-Middle (7)	714.5 (23165)	21.48	20.03
		707.5 (23095)	21.17	20.34
		700.5 (23025)	21.11	20.07
	1RB-Low (0)	714.5 (23165)	21.02	20.22
		707.5 (23095)	21.29	20.16
		700.5 (23025)	20.95	20.02
	8RB-High (7)	714.5 (23165)	19.95	19.18
		707.5 (23095)	20.12	19.29
		700.5 (23025)	20.15	19.16
	8RB-Middle (4)	714.5 (23165)	19.97	19.23
		707.5 (23095)	20.04	19.42
		700.5 (23025)	20.13	19.27
	8RB-Low (0)	714.5 (23165)	20.01	19.19
		707.5 (23095)	20.03	19.41
		700.5 (23025)	20.03	19.17
	15RB (0)	714.5 (23165)	19.91	19.10
		707.5 (23095)	20.02	19.18
		700.5 (23025)	20.07	19.07

5MHz	1RB-High (24)	713.5 (23155)	20.87	19.83	
		707.5 (23095)	20.92	19.93	
		701.5 (23035)	21.12	20.14	
	1RB-Middle (12)	713.5 (23155)	20.99	20.00	
		707.5 (23095)	21.21	19.91	
		701.5 (23035)	21.11	19.93	
	1RB-Low (0)	713.5 (23155)	20.99	20.03	
		707.5 (23095)	21.02	20.02	
		701.5 (23035)	21.11	19.71	
	12RB-High (13)	713.5 (23155)	19.93	18.79	
		707.5 (23095)	20.06	19.15	
		701.5 (23035)	20.01	19.09	
	12RB-Middle (6)	713.5 (23155)	19.97	18.82	
		707.5 (23095)	20.08	19.27	
		701.5 (23035)	20.08	19.16	
	12RB-Low (0)	713.5 (23155)	20.08	18.94	
		707.5 (23095)	20.16	19.26	
		701.5 (23035)	20.14	19.21	
	25RB (0)	713.5 (23155)	20.06	18.84	
		707.5 (23095)	20.12	19.25	
		701.5 (23035)	20.13	19.23	
	10MHz	1RB-High (49)	711 (23130)	20.58	19.96
			707.5 (23095)	20.93	19.99
			704 (23060)	20.95	20.08
1RB-Middle (24)		711 (23130)	21.26	20.61	
		707.5 (23095)	21.12	20.64	
		704 (23060)	21.15	20.17	
1RB-Low (0)		711 (23130)	21.17	19.91	
		707.5 (23095)	20.95	19.94	
		704 (23060)	20.77	19.53	
25RB-High (25)		711 (23130)	20.03	19.15	
		707.5 (23095)	20.02	19.04	
		704 (23060)	20.05	19.04	
25RB-Middle (12)		711 (23130)	20.15	19.27	
		707.5 (23095)	20.11	19.00	
		704 (23060)	20.16	19.16	
25RB-Low (0)		711 (23130)	19.98	19.09	
		707.5 (23095)	19.99	18.90	
		704 (23060)	19.84	18.85	
50RB (0)		711 (23130)	20.12	19.08	
		707.5 (23095)	19.95	18.97	
		704 (23060)	19.98	19.18	

Band25-Sensor + Non-USB				
BANDWIDTH	Number of RBs	Frequency	QPSK	16QAM
1.4MHz	1RB-High (5)	1914.3 (26683)	16.71	15.61
		1882.5 (26365)	16.58	15.52
		1850.7 (26047)	16.62	15.69
	1RB-Middle (3)	1914.3 (26683)	16.83	15.58
		1882.5 (26365)	16.72	15.58
		1850.7 (26047)	16.77	15.92
	1RB-Low (0)	1914.3 (26683)	16.62	15.56
		1882.5 (26365)	16.70	15.58
		1850.7 (26047)	16.57	15.78
	3RB-High (3)	1914.3 (26683)	16.65	15.61
		1882.5 (26365)	16.74	15.40
		1850.7 (26047)	16.69	15.43
	3RB-Middle (1)	1914.3 (26683)	16.72	15.66
		1882.5 (26365)	16.70	15.67
		1850.7 (26047)	16.76	15.95
	3RB-Low (0)	1914.3 (26683)	16.72	15.84
		1882.5 (26365)	16.74	15.69
		1850.7 (26047)	16.72	15.86
	6RB (0)	1914.3 (26683)	15.69	14.96
		1882.5 (26365)	16.64	14.54
		1850.7 (26047)	15.63	14.51
3MHz	1RB-High (14)	1913.5 (26675)	16.60	15.80
		1882.5 (26365)	16.59	15.62
		1851.5 (26055)	16.56	15.65
	1RB-Middle (7)	1913.5 (26675)	16.53	15.70
		1882.5 (26365)	16.51	15.54
		1851.5 (26055)	16.51	15.63
	1RB-Low (0)	1913.5 (26675)	16.72	15.76
		1882.5 (26365)	16.66	15.80
		1851.5 (26055)	16.82	15.57
	8RB-High (7)	1913.5 (26675)	15.70	14.43
		1882.5 (26365)	15.58	14.24
		1851.5 (26055)	15.62	14.52
	8RB-Middle (4)	1913.5 (26675)	15.63	14.55
		1882.5 (26365)	15.63	14.33
		1851.5 (26055)	15.59	14.39
8RB-Low (0)	1913.5 (26675)	15.58	14.41	
	1882.5 (26365)	15.66	14.55	
	1851.5 (26055)	15.52	14.46	
15RB (0)	1913.5 (26675)	15.67	14.61	
	1882.5 (26365)	15.60	14.43	
	1851.5 (26055)	15.57	14.47	

5MHz	1RB-High (24)	1912.5 (26665)	16.63	15.18	
		1882.5 (26365)	16.34	15.66	
		1852.5 (26065)	16.33	15.28	
	1RB-Middle (12)	1912.5 (26665)	16.60	15.17	
		1882.5 (26365)	16.26	15.76	
		1852.5 (26065)	16.41	15.19	
	1RB-Low (0)	1912.5 (26665)	16.52	15.16	
		1882.5 (26365)	16.43	15.59	
		1852.5 (26065)	16.65	15.32	
	12RB-High (13)	1912.5 (26665)	15.76	14.54	
		1882.5 (26365)	15.51	14.43	
		1852.5 (26065)	15.48	14.33	
	12RB-Middle (6)	1912.5 (26665)	15.63	14.56	
		1882.5 (26365)	15.62	14.51	
		1852.5 (26065)	15.57	14.58	
	12RB-Low (0)	1912.5 (26665)	15.65	14.76	
		1882.5 (26365)	15.66	14.58	
		1852.5 (26065)	15.57	14.60	
	25RB (0)	1912.5 (26665)	15.80	14.69	
		1882.5 (26365)	15.63	14.57	
		1852.5 (26065)	15.63	14.37	
	10MHz	1RB-High (49)	1910 (26640)	16.60	15.60
			1882.5 (26365)	16.35	15.23
			1855 (26090)	16.55	15.33
1RB-Middle (24)		1910 (26640)	16.56	15.59	
		1882.5 (26365)	16.86	15.31	
		1855 (26090)	16.69	15.65	
1RB-Low (0)		1910 (26640)	16.62	15.66	
		1882.5 (26365)	16.64	15.21	
		1855 (26090)	16.71	15.67	
25RB-High (25)		1910 (26640)	15.59	14.70	
		1882.5 (26365)	15.61	14.55	
		1855 (26090)	15.48	14.58	
25RB-Middle (12)		1910 (26640)	15.60	14.63	
		1882.5 (26365)	15.75	14.64	
		1855 (26090)	15.55	14.64	
25RB-Low (0)		1910 (26640)	15.72	14.57	
		1882.5 (26365)	15.68	14.64	
		1855 (26090)	15.59	14.69	
50RB (0)		1910 (26640)	15.71	14.54	
		1882.5 (26365)	15.57	14.50	
		1855 (26090)	15.51	14.47	

15MHz	1RB-High (74)	1907.5 (26615)	16.57	15.74	
		1882.5 (26365)	16.48	16.16	
		1857.5 (26115)	16.63	15.19	
	1RB-Middle (37)	1907.5 (26615)	16.59	15.69	
		1882.5 (26365)	16.53	16.19	
		1857.5 (26115)	16.53	15.45	
	1RB-Low (0)	1907.5 (26615)	16.80	15.84	
		1882.5 (26365)	16.67	16.25	
		1857.5 (26115)	16.82	15.67	
	36RB-High (38)	1907.5 (26615)	15.58	14.70	
		1882.5 (26365)	15.59	14.45	
		1857.5 (26115)	15.46	14.37	
	36RB-Middle (19)	1907.5 (26615)	15.70	14.55	
		1882.5 (26365)	15.58	14.44	
		1857.5 (26115)	15.47	14.38	
	36RB-Low (0)	1907.5 (26615)	15.72	14.67	
		1882.5 (26365)	15.63	14.51	
		1857.5 (26115)	15.57	14.48	
	75RB (0)	1907.5 (26615)	15.63	14.55	
		1882.5 (26365)	15.53	14.42	
		1857.5 (26115)	15.51	14.43	
	20MHz	1RB-High (99)	1905 (26590)	16.38	15.63
			1882.5 (26365)	16.35	15.33
			1860 (26140)	16.82	15.64
1RB-Middle (50)		1905 (26590)	16.62	15.65	
		1882.5 (26365)	16.62	15.58	
		1860 (26140)	16.94	15.08	
1RB-Low (0)		1905 (26590)	16.45	15.70	
		1882.5 (26365)	16.63	15.86	
		1860 (26140)	16.88	15.40	
50RB-High (50)		1905 (26590)	15.59	14.51	
		1882.5 (26365)	15.58	14.47	
		1860 (26140)	15.57	14.32	
50RB-Middle (25)		1905 (26590)	15.78	14.62	
		1882.5 (26365)	15.73	14.53	
		1860 (26140)	15.57	14.43	
50RB-Low (0)		1905 (26590)	15.77	14.67	
		1882.5 (26365)	15.67	14.44	
		1860 (26140)	15.58	14.54	
100RB (0)		1905 (26590)	15.65	14.58	
		1882.5 (26365)	15.67	14.60	
		1860 (26140)	15.60	14.60	

Band26-Sensor + Non-USB					
BANDWIDTH	Number of RBs	Frequency	QPSK	16QAM	
1.4MHz	1RB-High (5)	848.3 (27033)	20.66	19.79	
		831.5 (26865)	20.41	19.56	
		814.7 (26697)	20.53	19.78	
	1RB-Middle (3)	848.3 (27033)	20.87	19.74	
		831.5 (26865)	20.73	19.63	
		814.7 (26697)	20.70	19.73	
	1RB-Low (0)	848.3 (27033)	20.59	19.77	
		831.5 (26865)	20.43	19.72	
		814.7 (26697)	20.68	19.68	
	3RB-High (3)	848.3 (27033)	20.32	19.29	
		831.5 (26865)	20.50	19.63	
		814.7 (26697)	20.60	19.92	
	3RB-Middle (1)	848.3 (27033)	20.47	19.33	
		831.5 (26865)	20.59	19.84	
		814.7 (26697)	20.79	19.79	
	3RB-Low (0)	848.3 (27033)	20.60	19.44	
		831.5 (26865)	20.46	19.78	
		814.7 (26697)	20.49	20.07	
	6RB (0)	848.3 (27033)	19.67	18.22	
		831.5 (26865)	19.55	18.87	
		814.7 (26697)	19.75	18.85	
	3MHz	1RB-High (14)	847.5 (27025)	20.55	19.49
			831.5 (26865)	20.15	19.42
			815.5 (26705)	20.55	19.29
1RB-Middle (7)		847.5 (27025)	20.81	19.94	
		831.5 (26865)	20.77	19.62	
		815.5 (26705)	20.69	18.99	
1RB-Low (0)		847.5 (27025)	20.96	19.32	
		831.5 (26865)	20.58	19.75	
		815.5 (26705)	20.76	19.22	
8RB-High (7)		847.5 (27025)	19.68	18.53	
		831.5 (26865)	19.65	18.22	
		815.5 (26705)	19.43	18.25	
8RB-Middle (4)		847.5 (27025)	19.66	18.73	
		831.5 (26865)	19.62	18.46	
		815.5 (26705)	19.60	18.27	
8RB-Low (0)		847.5 (27025)	19.62	18.62	
		831.5 (26865)	19.57	18.17	
		815.5 (26705)	19.64	18.37	
15RB (0)		847.5 (27025)	19.51	18.65	
		831.5 (26865)	19.58	18.46	
		815.5 (26705)	19.75	18.40	

5MHz	1RB-High (24)	846.5 (27015)	20.47	19.09
		831.5 (26865)	19.92	19.09
		816.5 (26715)	20.53	19.73
	1RB-Middle (12)	846.5 (27015)	20.59	19.42
		831.5 (26865)	20.59	19.41
		816.5 (26715)	20.47	19.88
	1RB-Low (0)	846.5 (27015)	20.34	19.19
		831.5 (26865)	20.58	19.39
		816.5 (26715)	20.35	19.61
	12RB-High (13)	846.5 (27015)	19.66	18.43
		831.5 (26865)	19.62	18.51
		816.5 (26715)	19.60	18.32
	12RB-Middle (6)	846.5 (27015)	19.58	18.70
		831.5 (26865)	19.57	18.51
		816.5 (26715)	19.71	18.32
	12RB-Low (0)	846.5 (27015)	19.54	18.60
		831.5 (26865)	19.75	18.57
		816.5 (26715)	19.70	18.25
25RB (0)	846.5 (27015)	19.63	18.48	
	831.5 (26865)	19.63	18.54	
	816.5 (26715)	19.57	18.43	
10MHz	1RB-High (49)	844 (26990)	20.50	19.48
		831.5 (26865)	20.39	19.21
		820 (26750)	20.65	19.44
	1RB-Middle (24)	844 (26990)	20.91	19.46
		831.5 (26865)	20.71	19.67
		820 (26750)	20.75	19.52
	1RB-Low (0)	844 (26990)	20.26	19.11
		831.5 (26865)	20.30	19.65
		820 (26750)	20.97	19.54
	25RB-High (25)	844 (26990)	19.44	18.58
		831.5 (26865)	19.47	18.52
		820 (26750)	19.45	18.56
	25RB-Middle (12)	844 (26990)	19.63	18.69
		831.5 (26865)	19.60	18.46
		820 (26750)	19.40	18.52
	25RB-Low (0)	844 (26990)	19.52	18.47
		831.5 (26865)	19.49	18.50
		820 (26750)	19.64	18.35
50RB (0)	844 (26990)	19.47	18.63	
	831.5 (26865)	19.60	18.40	
	820 (26750)	19.49	18.31	

15MHz	1RB-High (74)	841.5 (26965)	20.55	19.49
		831.5 (26865)	20.55	19.69
		822.5 (26775)	20.68	19.83
	1RB-Middle (37)	841.5 (26965)	20.67	19.78
		831.5 (26865)	20.46	19.71
		822.5 (26775)	20.69	19.87
	1RB-Low (0)	841.5 (26965)	20.60	19.34
		831.5 (26865)	20.45	19.63
		822.5 (26775)	20.70	19.87
	36RB-High (38)	841.5 (26965)	19.48	18.39
		831.5 (26865)	19.50	18.57
		822.5 (26775)	19.67	18.44
	36RB-Middle (19)	841.5 (26965)	19.53	18.44
		831.5 (26865)	19.55	18.56
		822.5 (26775)	19.58	18.44
	36RB-Low (0)	841.5 (26965)	19.54	18.46
		831.5 (26865)	19.59	18.51
		822.5 (26775)	19.56	18.42
	75RB (0)	841.5 (26965)	19.54	18.48
		831.5 (26865)	19.51	18.50
		822.5 (26775)	19.62	18.60

Band41-Sensor + Non-USB				
BANDWIDTH	Number of RBs	Frequency	QPSK	16QAM
5MHz	1RB-High (24)	2687.5 (41565)	15.95	14.62
		2640.3(41093)	16.03	15.25
		2593 (40620)	16.18	14.72
		2545.8(40148)	16.05	14.99
		2498.5 (39675)	16.13	15.26
	1RB-Middle (12)	2687.5 (41565)	16.45	14.79
		2640.3(41093)	16.11	15.34
		2593 (40620)	16.29	14.87
		2545.8(40148)	16.22	15.00
		2498.5 (39675)	16.84	15.40
	1RB-Low (0)	2687.5 (41565)	16.16	14.60
		2640.3(41093)	15.90	15.10
		2593 (40620)	16.11	14.68
		2545.8(40148)	16.03	14.70
		2498.5 (39675)	16.14	15.24
	12RB-High (13)	2687.5 (41565)	14.97	14.22
		2640.3(41093)	15.04	14.18
		2593 (40620)	15.13	14.23
		2545.8(40148)	15.09	14.16
		2498.5 (39675)	15.17	14.22
	12RB-Middle (6)	2687.5 (41565)	15.11	13.57
		2640.3(41093)	15.09	14.14
		2593 (40620)	15.33	14.33
		2545.8(40148)	15.08	14.18
		2498.5 (39675)	15.14	14.27
	12RB-Low (0)	2687.5 (41565)	15.06	13.53
		2640.3(41093)	15.00	14.04
		2593 (40620)	15.18	14.28
		2545.8(40148)	15.05	14.19
		2498.5 (39675)	15.14	14.23
25RB (0)	2687.5 (41565)	15.01	13.53	
	2640.3(41093)	15.01	14.02	
	2593 (40620)	15.15	14.24	
	2545.8(40148)	15.00	14.20	
	2498.5 (39675)	15.15	14.16	

10MHz	1RB-High (49)	2685 (41540)	16.01	15.94
		2639(41080)	15.92	15.49
		2593 (40620)	15.95	14.67
		2547(40160)	16.07	15.92
		2501 (39700)	16.03	15.63
	1RB-Middle (24)	2685 (41540)	16.43	15.99
		2639(41080)	16.19	15.57
		2593 (40620)	16.23	14.75
		2547(40160)	16.31	16.06
		2501 (39700)	16.43	15.68
	1RB-Low (0)	2685 (41540)	16.24	15.87
		2639(41080)	15.99	15.62
		2593 (40620)	15.98	15.22
		2547(40160)	16.06	16.03
		2501 (39700)	16.07	15.54
	25RB-High (25)	2685 (41540)	15.06	15.45
		2639(41080)	15.01	14.11
		2593 (40620)	15.11	14.17
		2547(40160)	15.16	14.24
		2501 (39700)	15.18	14.08
	25RB-Middle (12)	2685 (41540)	15.03	13.68
		2639(41080)	15.12	14.22
		2593 (40620)	15.34	14.34
		2547(40160)	15.13	14.30
		2501 (39700)	15.18	14.28
	25RB-Low (0)	2685 (41540)	14.96	14.33
		2639(41080)	14.96	14.05
		2593 (40620)	15.12	14.16
		2547(40160)	14.92	14.13
		2501 (39700)	15.09	14.01
50RB (0)	2685 (41540)	15.07	14.18	
	2639(41080)	15.02	14.15	
	2593 (40620)	15.16	14.24	
	2547(40160)	15.03	14.17	
	2501 (39700)	15.16	14.10	

15MHz	1RB-High (74)	2682.5 (41515)	15.96	15.50
		2637.8(41068)	16.11	14.53
		2593 (40620)	16.00	15.14
		2548.3(40173)	15.93	15.42
		2503.5 (39725)	16.06	14.53
	1RB-Middle (37)	2682.5 (41515)	16.09	15.49
		2637.8(41068)	16.33	15.45
		2593 (40620)	16.16	15.68
		2548.3(40173)	16.19	15.63
		2503.5 (39725)	16.18	15.44
	1RB-Low (0)	2682.5 (41515)	16.03	15.55
		2637.8(41068)	16.00	14.50
		2593 (40620)	16.14	15.35
		2548.3(40173)	16.04	15.34
		2503.5 (39725)	15.95	15.09
	36RB-High (38)	2682.5 (41515)	14.99	13.58
		2637.8(41068)	15.08	13.75
		2593 (40620)	15.14	14.17
		2548.3(40173)	15.00	14.16
		2503.5 (39725)	15.15	14.26
	36RB-Middle (19)	2682.5 (41515)	14.91	13.64
		2637.8(41068)	15.11	13.96
		2593 (40620)	15.15	14.41
		2548.3(40173)	15.04	14.38
		2503.5 (39725)	15.13	14.35
	36RB-Low (0)	2682.5 (41515)	14.92	14.29
		2637.8(41068)	14.95	13.80
		2593 (40620)	14.99	14.26
		2548.3(40173)	14.88	14.18
		2503.5 (39725)	15.00	14.07
75RB (0)	2682.5 (41515)	14.91	13.78	
	2637.8(41068)	15.00	13.80	
	2593 (40620)	14.95	14.24	
	2548.3(40173)	14.92	14.14	
	2503.5 (39725)	15.01	14.12	

20MHz	1RB-High (99)	2680 (41490)	16.09	15.20
		2636.5(41055)	15.99	14.85
		2593 (40620)	16.34	14.66
		2549.5(40185)	16.00	15.12
		2506 (39750)	15.94	15.13
	1RB-Middle (50)	2680 (41490)	16.36	15.45
		2636.5(41055)	16.20	14.94
		2593 (40620)	16.66	14.79
		2549.5(40185)	16.38	15.29
		2506 (39750)	16.62	15.19
	1RB-Low (0)	2680 (41490)	16.21	15.24
		2636.5(41055)	16.05	14.71
		2593 (40620)	16.38	14.74
		2549.5(40185)	16.06	15.09
		2506 (39750)	16.23	14.73
	50RB-High (50)	2680 (41490)	15.27	14.24
		2636.5(41055)	15.06	13.92
		2593 (40620)	15.17	14.16
		2549.5(40185)	15.17	14.08
		2506 (39750)	15.15	13.99
	50RB-Middle (25)	2680 (41490)	15.31	14.15
		2636.5(41055)	15.14	14.01
		2593 (40620)	15.20	14.10
		2549.5(40185)	15.25	14.17
		2506 (39750)	15.18	14.12
50RB-Low (0)	2680 (41490)	15.29	14.11	
	2636.5(41055)	15.07	14.13	
	2593 (40620)	15.22	14.21	
	2549.5(40185)	15.12	14.08	
	2506 (39750)	14.99	13.93	
100RB (0)	2680 (41490)	15.25	14.12	
	2636.5(41055)	15.03	14.10	
	2593 (40620)	15.15	14.16	
	2549.5(40185)	15.11	14.07	
	2506 (39750)	15.28	13.93	

Band66-Sensor + Non-USB				
BANDWIDTH	Number of RBs	Frequency	QPSK	16QAM
1.4MHz	1RB-High (5)	1779.3 (132665)	16.84	15.18
		1745 (132322)	16.64	15.97
		1710.7 (131979)	16.53	15.69
	1RB-Middle (3)	1779.3 (132665)	16.61	15.17
		1745 (132322)	16.58	15.96
		1710.7 (131979)	16.80	15.67
	1RB-Low (0)	1779.3 (132665)	16.58	15.59
		1745 (132322)	16.85	15.89
		1710.7 (131979)	16.56	15.93
	3RB-High (3)	1779.3 (132665)	16.83	15.57
		1745 (132322)	16.91	15.90
		1710.7 (131979)	16.59	15.39
	3RB-Middle (1)	1779.3 (132665)	16.85	15.61
		1745 (132322)	16.83	16.13
		1710.7 (131979)	16.65	15.46
	3RB-Low (0)	1779.3 (132665)	16.81	15.56
		1745 (132322)	16.79	16.00
		1710.7 (131979)	16.62	15.43
	6RB (0)	1779.3 (132665)	15.86	14.75
		1745 (132322)	15.84	15.03
		1710.7 (131979)	15.61	14.35
3MHz	1RB-High (14)	1778.5 (132657)	16.68	15.38
		1745 (132322)	16.88	16.34
		1711.5 (131987)	16.70	15.65
	1RB-Middle (7)	1778.5 (132657)	16.85	15.73
		1745 (132322)	16.89	16.35
		1711.5 (131987)	16.74	15.90
	1RB-Low (0)	1778.5 (132657)	16.85	15.65
		1745 (132322)	16.85	16.13
		1711.5 (131987)	16.81	15.84
	8RB-High (7)	1778.5 (132657)	15.79	14.65
		1745 (132322)	15.85	14.85
		1711.5 (131987)	15.70	14.69
	8RB-Middle (4)	1778.5 (132657)	15.79	14.62
		1745 (132322)	15.88	14.99
		1711.5 (131987)	15.73	14.63
	8RB-Low (0)	1778.5 (132657)	15.70	14.63
		1745 (132322)	15.88	14.98
		1711.5 (131987)	15.64	14.62
	15RB (0)	1778.5 (132657)	15.68	14.62
		1745 (132322)	15.86	14.93
		1711.5 (131987)	15.73	14.53

5MHz	1RB-High (24)	1777.5 (132647)	16.49	15.27
		1745 (132322)	16.71	15.86
		1712.5 (131997)	16.60	15.60
	1RB-Middle (12)	1777.5 (132647)	16.73	15.37
		1745 (132322)	16.82	16.06
		1712.5 (131997)	16.67	15.55
	1RB-Low (0)	1777.5 (132647)	16.51	15.19
		1745 (132322)	16.59	15.92
		1712.5 (131997)	16.49	15.17
	12RB-High (13)	1777.5 (132647)	15.66	14.59
		1745 (132322)	15.82	15.00
		1712.5 (131997)	15.56	14.64
	12RB-Middle (6)	1777.5 (132647)	15.74	14.67
		1745 (132322)	15.89	14.98
		1712.5 (131997)	15.68	14.65
	12RB-Low (0)	1777.5 (132647)	15.64	14.60
		1745 (132322)	15.87	14.86
		1712.5 (131997)	15.66	14.74
25RB (0)	1777.5 (132647)	15.72	14.69	
	1745 (132322)	15.86	14.86	
	1712.5 (131997)	15.66	14.54	
10MHz	1RB-High (49)	1775 (132622)	16.71	15.72
		1745 (132322)	16.62	15.70
		1715 (132022)	16.36	15.12
	1RB-Middle (24)	1775 (132622)	17.05	15.90
		1745 (132322)	16.92	16.52
		1715 (132022)	16.66	15.68
	1RB-Low (0)	1775 (132622)	16.70	15.36
		1745 (132322)	16.67	15.70
		1715 (132022)	16.50	15.13
	25RB-High (25)	1775 (132622)	15.76	14.56
		1745 (132322)	15.85	14.77
		1715 (132022)	15.57	14.46
	25RB-Middle (12)	1775 (132622)	15.94	14.83
		1745 (132322)	15.87	14.84
		1715 (132022)	15.70	14.60
	25RB-Low (0)	1775 (132622)	15.73	14.79
		1745 (132322)	15.75	14.67
		1715 (132022)	15.54	14.45
50RB (0)	1775 (132622)	15.77	14.59	
	1745 (132322)	15.81	14.80	
	1715 (132022)	15.55	14.53	

Band71-Sensor + Non-USB				
BANDWIDTH	Number of RBs	Frequency	QPSK	16QAM
5MHz	1RB-High (24)	695.5 (133447)	19.76	18.84
		680.5 (133297)	19.71	18.61
		665.5 (133147)	19.14	18.64
	1RB-Middle (12)	695.5 (133447)	19.85	18.80
		680.5 (133297)	19.81	18.80
		665.5 (133147)	19.47	18.92
	1RB-Low (0)	695.5 (133447)	19.53	18.28
		680.5 (133297)	19.61	18.42
		665.5 (133147)	19.67	18.05
	12RB-High (13)	695.5 (133447)	18.84	17.94
		680.5 (133297)	18.81	17.82
		665.5 (133147)	18.62	17.54
	12RB-Middle (6)	695.5 (133447)	18.81	17.79
		680.5 (133297)	18.78	17.77
		665.5 (133147)	18.69	17.48
	12RB-Low (0)	695.5 (133447)	18.75	17.61
		680.5 (133297)	18.73	17.73
		665.5 (133147)	18.58	17.47
	25RB (0)	695.5 (133447)	18.72	17.79
		680.5 (133297)	18.70	17.83
		665.5 (133147)	18.73	17.63
10MHz	1RB-High (49)	693 (132422)	19.61	18.77
		680.5 (133297)	19.64	18.91
		668 (133172)	19.61	18.32
	1RB-Middle (24)	693 (132422)	20.11	18.97
		680.5 (133297)	19.82	19.05
		668 (133172)	19.71	18.61
	1RB-Low (0)	693 (132422)	19.72	18.74
		680.5 (133297)	19.42	18.55
		668 (133172)	19.45	18.15
	25RB-High (25)	693 (132422)	18.58	17.75
		680.5 (133297)	18.74	17.75
		668 (133172)	18.71	17.71
	25RB-Middle (12)	693 (132422)	18.72	17.72
		680.5 (133297)	18.84	17.68
		668 (133172)	18.80	17.98
	25RB-Low (0)	693 (132422)	18.66	17.65
		680.5 (133297)	18.70	17.66
		668 (133172)	18.62	17.89
50RB (0)	693 (132422)	18.63	17.65	
	680.5 (133297)	18.75	17.64	
	668 (133172)	18.67	17.65	

15MHz	1RB-High (74)	690.5 (133397)	19.98	19.16	
		680.5 (133297)	19.58	18.16	
		670.5 (133197)	19.56	19.22	
	1RB-Middle (37)	690.5 (133397)	19.71	18.72	
		680.5 (133297)	19.77	18.92	
		670.5 (133197)	19.61	19.57	
	1RB-Low (0)	690.5 (133397)	19.58	18.67	
		680.5 (133297)	19.40	18.20	
		670.5 (133197)	19.51	19.25	
	36RB-High (38)	690.5 (133397)	18.75	17.61	
		680.5 (133297)	18.74	17.79	
		670.5 (133197)	18.65	17.72	
	36RB-Middle (19)	690.5 (133397)	18.76	17.59	
		680.5 (133297)	18.74	17.81	
		670.5 (133197)	18.68	17.56	
	36RB-Low (0)	690.5 (133397)	18.71	17.57	
		680.5 (133297)	18.53	17.53	
		670.5 (133197)	18.62	17.42	
	75RB (0)	690.5 (133397)	18.74	17.60	
		680.5 (133297)	18.66	17.71	
		670.5 (133197)	18.59	17.62	
	20MHz	1RB-High (99)	688 (133372)	19.48	18.30
			683 (133322)	19.05	18.42
			673 (133222)	19.82	18.43
1RB-Middle (50)		688 (133372)	19.50	18.38	
		683 (133322)	19.63	19.17	
		673 (133222)	19.64	18.57	
1RB-Low (0)		688 (133372)	19.20	18.04	
		683 (133322)	19.03	18.11	
		673 (133222)	19.42	18.06	
50RB-High (50)		688 (133372)	18.68	17.51	
		683 (133322)	18.68	17.53	
		673 (133222)	18.63	17.57	
50RB-Middle (25)		688 (133372)	18.62	17.57	
		683 (133322)	18.74	17.69	
		673 (133222)	18.74	17.61	
50RB-Low (0)		688 (133372)	18.69	17.53	
		683 (133322)	18.66	17.73	
		673 (133222)	18.59	17.55	
100RB (0)		688 (133372)	18.61	17.56	
		683 (133322)	18.66	17.65	
		673 (133222)	18.58	17.53	

Power Level C1

Band12-Sensor + USB				
BANDWIDTH	Number of RBs	Frequency	QPSK	16QAM
1.4MHz	1RB-High (5)	715.3 (23173)	17.90	17.09
		707.5 (23095)	17.96	17.12
		699.7 (23017)	18.02	17.19
	1RB-Middle (3)	715.3 (23173)	18.01	17.19
		707.5 (23095)	18.20	17.13
		699.7 (23017)	18.11	17.11
	1RB-Low (0)	715.3 (23173)	17.98	17.15
		707.5 (23095)	18.18	17.11
		699.7 (23017)	18.00	17.08
	3RB-High (3)	715.3 (23173)	18.00	17.09
		707.5 (23095)	18.12	17.21
		699.7 (23017)	18.12	16.90
	3RB-Middle (1)	715.3 (23173)	18.08	17.03
		707.5 (23095)	18.18	17.28
		699.7 (23017)	18.09	16.90
	3RB-Low (0)	715.3 (23173)	17.96	16.74
		707.5 (23095)	18.15	17.32
		699.7 (23017)	18.01	17.13
	6RB (0)	715.3 (23173)	17.05	15.70
		707.5 (23095)	17.13	16.24
		699.7 (23017)	17.06	16.26
3MHz	1RB-High (14)	714.5 (23165)	17.86	16.86
		707.5 (23095)	18.04	17.14
		700.5 (23025)	17.96	17.20
	1RB-Middle (7)	714.5 (23165)	18.17	17.42
		707.5 (23095)	18.26	17.26
		700.5 (23025)	18.06	17.01
	1RB-Low (0)	714.5 (23165)	18.17	17.26
		707.5 (23095)	18.12	17.14
		700.5 (23025)	17.95	16.91
	8RB-High (7)	714.5 (23165)	17.09	16.44
		707.5 (23095)	17.17	16.13
		700.5 (23025)	17.14	16.09
	8RB-Middle (4)	714.5 (23165)	17.14	16.48
		707.5 (23095)	17.12	16.29
		700.5 (23025)	17.14	16.18
	8RB-Low (0)	714.5 (23165)	17.18	16.54
		707.5 (23095)	17.12	16.37
		700.5 (23025)	17.04	16.19
	15RB (0)	714.5 (23165)	16.99	16.17
		707.5 (23095)	17.12	16.22
		700.5 (23025)	17.10	16.17

5MHz	1RB-High (24)	713.5 (23155)	17.89	16.96	
		707.5 (23095)	17.95	16.55	
		701.5 (23035)	18.07	17.11	
	1RB-Middle (12)	713.5 (23155)	17.69	16.83	
		707.5 (23095)	18.03	17.05	
		701.5 (23035)	18.06	17.00	
	1RB-Low (0)	713.5 (23155)	17.77	16.97	
		707.5 (23095)	18.12	17.19	
		701.5 (23035)	18.07	16.92	
	12RB-High (13)	713.5 (23155)	16.88	15.84	
		707.5 (23095)	17.01	15.87	
		701.5 (23035)	17.11	16.20	
	12RB-Middle (6)	713.5 (23155)	16.95	15.86	
		707.5 (23095)	17.14	16.19	
		701.5 (23035)	17.10	16.20	
	12RB-Low (0)	713.5 (23155)	17.04	15.89	
		707.5 (23095)	17.10	16.16	
		701.5 (23035)	17.13	16.23	
	25RB (0)	713.5 (23155)	17.02	15.99	
		707.5 (23095)	17.16	16.02	
		701.5 (23035)	17.15	16.07	
	10MHz	1RB-High (49)	711 (23130)	17.76	16.92
			707.5 (23095)	17.78	16.96
			704 (23060)	17.94	16.63
1RB-Middle (24)		711 (23130)	18.30	17.18	
		707.5 (23095)	18.04	17.59	
		704 (23060)	18.15	17.78	
1RB-Low (0)		711 (23130)	17.88	16.54	
		707.5 (23095)	17.90	16.71	
		704 (23060)	17.96	16.87	
25RB-High (25)		711 (23130)	17.05	16.10	
		707.5 (23095)	17.12	16.24	
		704 (23060)	17.14	16.08	
25RB-Middle (12)		711 (23130)	17.13	16.21	
		707.5 (23095)	17.10	16.32	
		704 (23060)	17.16	16.20	
25RB-Low (0)		711 (23130)	17.03	16.13	
		707.5 (23095)	17.08	16.23	
		704 (23060)	16.94	15.89	
50RB (0)		711 (23130)	17.16	16.14	
		707.5 (23095)	17.04	16.14	
		704 (23060)	17.10	16.11	

Band12-Sensor + USB				
BANDWIDTH	Number of RBs	Frequency	QPSK	16QAM
1.4MHz	1RB-High (5)	1914.3 (26683)	13.52	12.63
		1882.5 (26365)	13.75	12.26
		1850.7 (26047)	13.37	12.69
	1RB-Middle (3)	1914.3 (26683)	13.67	13.01
		1882.5 (26365)	13.85	12.43
		1850.7 (26047)	13.57	12.84
	1RB-Low (0)	1914.3 (26683)	13.53	12.85
		1882.5 (26365)	13.56	12.33
		1850.7 (26047)	13.50	12.78
	3RB-High (3)	1914.3 (26683)	13.64	13.08
		1882.5 (26365)	13.69	12.32
		1850.7 (26047)	13.49	12.60
	3RB-Middle (1)	1914.3 (26683)	13.68	13.13
		1882.5 (26365)	13.74	12.38
		1850.7 (26047)	13.53	12.69
	3RB-Low (0)	1914.3 (26683)	13.63	13.07
		1882.5 (26365)	13.54	12.35
		1850.7 (26047)	13.50	12.68
	6RB (0)	1914.3 (26683)	12.55	11.99
		1882.5 (26365)	12.12	11.28
		1850.7 (26047)	12.28	11.25
3MHz	1RB-High (14)	1913.5 (26675)	14.00	13.15
		1882.5 (26365)	13.55	12.31
		1851.5 (26055)	13.58	12.80
	1RB-Middle (7)	1913.5 (26675)	13.61	12.79
		1882.5 (26365)	13.45	12.16
		1851.5 (26055)	13.51	12.71
	1RB-Low (0)	1913.5 (26675)	13.89	13.08
		1882.5 (26365)	13.59	12.40
		1851.5 (26055)	13.70	13.09
	8RB-High (7)	1913.5 (26675)	12.61	11.78
		1882.5 (26365)	11.97	11.12
		1851.5 (26055)	12.08	11.20
	8RB-Middle (4)	1913.5 (26675)	12.55	11.72
		1882.5 (26365)	12.07	11.20
		1851.5 (26055)	12.17	11.30
	8RB-Low (0)	1913.5 (26675)	12.51	11.68
		1882.5 (26365)	12.11	11.25
		1851.5 (26055)	12.23	11.36
15RB (0)	1913.5 (26675)	12.53	11.63	
	1882.5 (26365)	12.06	11.13	
	1851.5 (26055)	12.16	11.26	

5MHz	1RB-High (24)	1912.5 (26665)	14.09	13.25	
		1882.5 (26365)	13.40	12.52	
		1852.5 (26065)	13.13	12.67	
	1RB-Middle (12)	1912.5 (26665)	13.58	12.72	
		1882.5 (26365)	13.53	12.35	
		1852.5 (26065)	13.31	12.68	
	1RB-Low (0)	1912.5 (26665)	13.84	12.98	
		1882.5 (26365)	13.63	12.79	
		1852.5 (26065)	13.68	13.26	
	12RB-High (13)	1912.5 (26665)	12.68	11.80	
		1882.5 (26365)	12.27	11.41	
		1852.5 (26065)	12.09	11.29	
	12RB-Middle (6)	1912.5 (26665)	12.50	11.61	
		1882.5 (26365)	12.04	11.18	
		1852.5 (26065)	12.05	11.25	
	12RB-Low (0)	1912.5 (26665)	12.51	11.63	
		1882.5 (26365)	12.35	11.49	
		1852.5 (26065)	12.47	11.67	
	25RB (0)	1912.5 (26665)	12.64	11.67	
		1882.5 (26365)	12.34	11.41	
		1852.5 (26065)	12.34	11.45	
	10MHz	1RB-High (49)	1910 (26640)	13.66	12.62
			1882.5 (26365)	13.92	11.74
			1855 (26090)	13.44	11.75
1RB-Middle (24)		1910 (26640)	13.44	12.43	
		1882.5 (26365)	14.02	12.10	
		1855 (26090)	13.69	12.14	
1RB-Low (0)		1910 (26640)	13.79	12.80	
		1882.5 (26365)	13.98	12.28	
		1855 (26090)	13.30	12.58	
25RB-High (25)		1910 (26640)	12.52	11.58	
		1882.5 (26365)	12.02	11.07	
		1855 (26090)	11.75	10.73	
25RB-Middle (12)		1910 (26640)	12.36	11.43	
		1882.5 (26365)	11.96	11.01	
		1855 (26090)	11.68	10.68	
25RB-Low (0)		1910 (26640)	12.55	11.62	
		1882.5 (26365)	12.29	11.34	
		1855 (26090)	12.21	11.22	
50RB (0)		1910 (26640)	12.53	11.55	
		1882.5 (26365)	12.15	11.19	
		1855 (26090)	11.95	10.91	

15MHz	1RB-High (74)	1907.5 (26615)	13.72	13.08
		1882.5 (26365)	13.72	11.84
		1857.5 (26115)	13.41	12.34
	1RB-Middle (37)	1907.5 (26615)	13.55	12.90
		1882.5 (26365)	13.69	12.05
		1857.5 (26115)	13.35	11.91
	1RB-Low (0)	1907.5 (26615)	13.99	13.35
		1882.5 (26365)	13.79	12.57
		1857.5 (26115)	13.63	12.63
	36RB-High (38)	1907.5 (26615)	12.42	11.41
		1882.5 (26365)	12.04	11.07
		1857.5 (26115)	11.75	10.74
	36RB-Middle (19)	1907.5 (26615)	12.55	11.54
		1882.5 (26365)	11.95	10.98
		1857.5 (26115)	11.54	10.52
	36RB-Low (0)	1907.5 (26615)	12.89	11.88
		1882.5 (26365)	12.36	11.38
		1857.5 (26115)	11.95	10.93
	75RB (0)	1907.5 (26615)	12.69	11.72
		1882.5 (26365)	12.14	11.17
		1857.5 (26115)	11.89	10.85
20MHz	1RB-High (99)	1905 (26590)	13.63	13.09
		1882.5 (26365)	13.36	12.32
		1860 (26140)	13.39	12.97
	1RB-Middle (50)	1905 (26590)	13.76	13.47
		1882.5 (26365)	13.46	12.61
		1860 (26140)	13.57	12.15
	1RB-Low (0)	1905 (26590)	13.53	12.98
		1882.5 (26365)	13.64	13.01
		1860 (26140)	13.26	12.64
	50RB-High (50)	1905 (26590)	12.60	11.64
		1882.5 (26365)	11.99	10.99
		1860 (26140)	12.05	11.11
	50RB-Middle (25)	1905 (26590)	13.00	12.04
		1882.5 (26365)	12.09	11.09
		1860 (26140)	11.57	10.63
	50RB-Low (0)	1905 (26590)	13.27	12.32
		1882.5 (26365)	12.46	11.46
		1860 (26140)	11.74	10.79
	100RB (0)	1905 (26590)	12.87	11.90
		1882.5 (26365)	12.21	11.23
		1860 (26140)	11.95	11.01

Band12-Sensor + USB				
BANDWIDTH	Number of RBs	Frequency	QPSK	16QAM
1.4MHz	1RB-High (5)	848.3 (27033)	13.96	12.60
		831.5 (26865)	13.91	12.59
		814.7 (26697)	14.10	12.83
	1RB-Middle (3)	848.3 (27033)	14.26	12.55
		831.5 (26865)	14.20	12.85
		814.7 (26697)	14.26	12.92
	1RB-Low (0)	848.3 (27033)	13.95	12.61
		831.5 (26865)	13.85	12.68
		814.7 (26697)	14.07	12.67
	3RB-High (3)	848.3 (27033)	14.08	12.52
		831.5 (26865)	13.97	12.80
		814.7 (26697)	14.18	12.78
	3RB-Middle (1)	848.3 (27033)	14.21	12.67
		831.5 (26865)	14.20	12.98
		814.7 (26697)	14.31	12.81
	3RB-Low (0)	848.3 (27033)	14.20	12.58
		831.5 (26865)	14.17	12.91
		814.7 (26697)	14.32	12.81
	6RB (0)	848.3 (27033)	12.95	12.72
		831.5 (26865)	12.95	12.05
		814.7 (26697)	12.80	11.79
3MHz	1RB-High (14)	847.5 (27025)	13.97	12.66
		831.5 (26865)	14.08	12.67
		815.5 (26705)	13.82	12.66
	1RB-Middle (7)	847.5 (27025)	14.47	12.58
		831.5 (26865)	14.18	12.78
		815.5 (26705)	14.02	12.77
	1RB-Low (0)	847.5 (27025)	14.07	12.68
		831.5 (26865)	13.93	12.74
		815.5 (26705)	13.95	12.73
	8RB-High (7)	847.5 (27025)	12.63	11.96
		831.5 (26865)	12.86	11.87
		815.5 (26705)	12.88	11.86
	8RB-Middle (4)	847.5 (27025)	12.60	11.66
		831.5 (26865)	12.89	11.91
		815.5 (26705)	12.91	11.89
	8RB-Low (0)	847.5 (27025)	12.67	11.61
		831.5 (26865)	12.94	11.96
		815.5 (26705)	12.95	11.94
15RB (0)	847.5 (27025)	12.60	11.64	
	831.5 (26865)	12.83	11.77	
	815.5 (26705)	12.84	11.76	

5MHz	1RB-High (24)	846.5 (27015)	13.86	12.64
		831.5 (26865)	13.84	12.89
		816.5 (26715)	13.90	13.37
	1RB-Middle (12)	846.5 (27015)	14.42	12.60
		831.5 (26865)	14.11	13.00
		816.5 (26715)	14.05	13.42
	1RB-Low (0)	846.5 (27015)	14.01	12.98
		831.5 (26865)	14.04	12.96
		816.5 (26715)	14.14	13.32
	12RB-High (13)	846.5 (27015)	12.64	11.74
		831.5 (26865)	12.81	11.84
		816.5 (26715)	12.84	11.94
	12RB-Middle (6)	846.5 (27015)	12.51	11.52
		831.5 (26865)	12.84	11.87
		816.5 (26715)	13.01	12.12
	12RB-Low (0)	846.5 (27015)	12.68	11.70
		831.5 (26865)	12.78	11.82
		816.5 (26715)	12.81	11.92
25RB (0)	846.5 (27015)	12.57	11.58	
	831.5 (26865)	12.86	11.84	
	816.5 (26715)	12.88	11.91	
10MHz	1RB-High (49)	844 (26990)	13.98	12.51
		831.5 (26865)	13.95	12.58
		820 (26750)	13.90	12.95
	1RB-Middle (24)	844 (26990)	14.02	12.96
		831.5 (26865)	14.03	12.85
		820 (26750)	14.05	13.32
	1RB-Low (0)	844 (26990)	13.96	12.60
		831.5 (26865)	14.15	12.59
		820 (26750)	13.94	13.07
	25RB-High (25)	844 (26990)	12.51	11.59
		831.5 (26865)	12.81	11.68
		820 (26750)	12.78	11.68
	25RB-Middle (12)	844 (26990)	12.90	11.90
		831.5 (26865)	13.00	11.89
		820 (26750)	12.93	11.85
	25RB-Low (0)	844 (26990)	12.75	11.75
		831.5 (26865)	12.92	11.81
		820 (26750)	12.88	11.81
50RB (0)	844 (26990)	12.62	11.56	
	831.5 (26865)	12.84	11.72	
	820 (26750)	12.81	11.72	

15MHz	1RB-High (74)	841.5 (26965)	14.45	13.01
		831.5 (26865)	14.51	13.75
		822.5 (26775)	14.39	13.17
	1RB-Middle (37)	841.5 (26965)	14.59	13.79
		831.5 (26865)	14.49	13.84
		822.5 (26775)	14.81	13.43
	1RB-Low (0)	841.5 (26965)	14.45	13.48
		831.5 (26865)	14.37	13.52
		822.5 (26775)	14.80	13.38
	36RB-High (38)	841.5 (26965)	13.24	12.05
		831.5 (26865)	13.33	12.22
		822.5 (26775)	13.28	12.20
	36RB-Middle (19)	841.5 (26965)	13.60	12.41
		831.5 (26865)	13.54	12.44
		822.5 (26775)	13.44	12.37
	36RB-Low (0)	841.5 (26965)	13.48	12.34
		831.5 (26865)	13.21	12.10
		822.5 (26775)	13.29	12.22
	75RB (0)	841.5 (26965)	13.39	12.21
		831.5 (26865)	13.38	12.31
		822.5 (26775)	13.30	12.24

Band12-Sensor + USB				
BANDWIDTH	Number of RBs	Frequency	QPSK	16QAM
1.4MHz	1RB-High (5)	1779.3 (132665)	13.58	12.82
		1745 (132322)	13.63	12.76
		1710.7 (131979)	13.77	12.94
	1RB-Middle (3)	1779.3 (132665)	13.60	12.93
		1745 (132322)	13.73	12.79
		1710.7 (131979)	13.75	12.99
	1RB-Low (0)	1779.3 (132665)	13.83	13.01
		1745 (132322)	13.69	12.75
		1710.7 (131979)	13.72	12.96
	3RB-High (3)	1779.3 (132665)	13.79	12.65
		1745 (132322)	13.75	12.87
		1710.7 (131979)	13.79	12.87
	3RB-Middle (1)	1779.3 (132665)	14.02	12.79
		1745 (132322)	13.80	12.94
		1710.7 (131979)	13.85	12.91
	3RB-Low (0)	1779.3 (132665)	13.90	12.79
		1745 (132322)	13.95	12.88
		1710.7 (131979)	13.80	12.88
	6RB (0)	1779.3 (132665)	12.40	11.31
		1745 (132322)	12.84	12.00
		1710.7 (131979)	12.62	11.82
3MHz	1RB-High (14)	1778.5 (132657)	13.66	12.34
		1745 (132322)	13.78	12.64
		1711.5 (131987)	13.49	13.07
	1RB-Middle (7)	1778.5 (132657)	13.81	12.59
		1745 (132322)	13.98	12.66
		1711.5 (131987)	13.79	13.20
	1RB-Low (0)	1778.5 (132657)	13.68	12.56
		1745 (132322)	13.76	12.62
		1711.5 (131987)	13.82	13.19
	8RB-High (7)	1778.5 (132657)	12.46	11.37
		1745 (132322)	12.83	11.90
		1711.5 (131987)	12.62	11.72
	8RB-Middle (4)	1778.5 (132657)	12.51	11.44
		1745 (132322)	12.87	11.94
		1711.5 (131987)	12.64	11.75
	8RB-Low (0)	1778.5 (132657)	12.47	11.41
		1745 (132322)	12.85	11.93
		1711.5 (131987)	12.62	11.74
	15RB (0)	1778.5 (132657)	12.45	11.31
		1745 (132322)	12.84	11.85
		1711.5 (131987)	12.61	11.69

5MHz	1RB-High (24)	1777.5 (132647)	13.49	12.50
		1745 (132322)	13.73	13.22
		1712.5 (131997)	13.49	12.90
	1RB-Middle (12)	1777.5 (132647)	13.77	12.67
		1745 (132322)	13.73	13.24
		1712.5 (131997)	13.47	12.86
	1RB-Low (0)	1777.5 (132647)	13.72	12.70
		1745 (132322)	13.58	13.07
		1712.5 (131997)	13.73	12.97
	12RB-High (13)	1777.5 (132647)	12.44	11.44
		1745 (132322)	12.93	12.08
		1712.5 (131997)	12.50	11.67
	12RB-Middle (6)	1777.5 (132647)	12.50	11.51
		1745 (132322)	12.86	12.02
		1712.5 (131997)	12.51	11.68
	12RB-Low (0)	1777.5 (132647)	12.45	11.44
		1745 (132322)	12.84	12.00
		1712.5 (131997)	12.60	11.76
25RB (0)	1777.5 (132647)	12.48	11.44	
	1745 (132322)	12.82	11.90	
	1712.5 (131997)	12.49	11.57	
10MHz	1RB-High (49)	1775 (132622)	13.77	11.89
		1745 (132322)	13.92	11.91
		1715 (132022)	13.44	11.96
	1RB-Middle (24)	1775 (132622)	13.97	12.90
		1745 (132322)	13.92	12.77
		1715 (132022)	13.68	13.22
	1RB-Low (0)	1775 (132622)	13.55	12.34
		1745 (132322)	13.83	11.74
		1715 (132022)	13.08	12.43
	25RB-High (25)	1775 (132622)	12.49	11.46
		1745 (132322)	12.78	11.73
		1715 (132022)	12.29	11.32
	25RB-Middle (12)	1775 (132622)	12.83	11.82
		1745 (132322)	12.93	11.89
		1715 (132022)	12.60	11.66
	25RB-Low (0)	1775 (132622)	12.77	11.77
		1745 (132322)	12.63	11.59
		1715 (132022)	12.36	11.42
50RB (0)	1775 (132622)	12.62	11.57	
	1745 (132322)	12.67	11.62	
	1715 (132022)	12.35	11.41	

15MHz	1RB-High (74)	1772.5 (132597)	13.59	12.39
		1745 (132322)	13.80	12.48
		1717.5 (132047)	13.66	11.62
	1RB-Middle (37)	1772.5 (132597)	14.30	13.40
		1745 (132322)	14.26	13.29
		1717.5 (132047)	13.78	12.56
	1RB-Low (0)	1772.5 (132597)	13.37	12.69
		1745 (132322)	13.62	12.44
		1717.5 (132047)	13.62	12.10
	36RB-High (38)	1772.5 (132597)	12.58	11.62
		1745 (132322)	12.80	11.71
		1717.5 (132047)	12.40	11.35
	36RB-Middle (19)	1772.5 (132597)	13.02	12.08
		1745 (132322)	13.01	11.93
		1717.5 (132047)	12.67	11.62
	36RB-Low (0)	1772.5 (132597)	12.73	11.82
		1745 (132322)	12.71	11.63
		1717.5 (132047)	12.51	11.46
75RB (0)	1772.5 (132597)	12.68	11.74	
	1745 (132322)	12.72	11.68	
	1717.5 (132047)	12.43	11.39	
20MHz	1RB-High (99)	1770 (132572)	13.38	11.77
		1745 (132322)	13.40	12.17
		1720 (132072)	13.59	11.80
	1RB-Middle (50)	1770 (132572)	13.89	13.25
		1745 (132322)	13.70	13.20
		1720 (132072)	13.87	12.74
	1RB-Low (0)	1770 (132572)	13.35	12.06
		1745 (132322)	13.39	11.94
		1720 (132072)	13.48	12.13
	50RB-High (50)	1770 (132572)	12.19	11.24
		1745 (132322)	12.40	11.43
		1720 (132072)	11.98	10.99
	50RB-Middle (25)	1770 (132572)	12.52	11.57
		1745 (132322)	12.69	11.71
		1720 (132072)	12.31	11.33
	50RB-Low (0)	1770 (132572)	12.24	11.30
		1745 (132322)	12.25	11.28
		1720 (132072)	12.09	11.11
100RB (0)	1770 (132572)	12.18	11.26	
	1745 (132322)	12.36	11.41	
	1720 (132072)	12.08	11.09	

Band 66					
Bandwidth (MHz)	RB allocation	Frequency (MHz)	QPSK	16QAM	64QAM
	RB offset (Start RB)		Actual output power (dBm)	Actual output power (dBm)	Actual output power (dBm)
1.4 MHz	1RB High (5)	1779.3	14.55	13.57	12.84
		1745	14.56	13.73	13.00
		1710.7	14.33	13.74	13.01
	1RB Middle (3)	1779.3	14.59	13.64	12.91
		1745	14.67	13.81	13.08
		1710.7	14.44	13.79	13.06
	1RB Low (0)	1779.3	14.54	13.57	12.84
		1745	14.59	13.77	13.04
		1710.7	14.35	13.79	13.06
	3RB High (3)	1779.3	14.56	13.81	13.08
		1745	14.59	13.66	12.93
		1710.7	14.33	13.47	12.74
	3RB Middle (1)	1779.3	14.61	13.83	13.10
		1745	14.61	13.67	12.94
		1710.7	14.37	13.55	12.82
	3RB Low (0)	1779.3	14.54	13.79	13.06
		1745	14.55	13.63	12.90
		1710.7	14.32	13.51	12.78
	6RB (0)	1779.3	13.57	12.76	12.03
		1745	13.61	12.75	12.02
		1710.7	13.33	12.25	11.52
3 MHz	1RB High (14)	1778.5	14.59	13.64	12.91
		1745	14.63	13.54	12.81
		1711.5	14.40	13.82	13.09
	1RB Middle (7)	1778.5	14.73	13.79	13.06
		1745	14.73	13.64	12.91
		1711.5	14.50	13.94	13.21
	1RB Low (0)	1778.5	14.63	13.67	12.94
		1745	14.60	13.60	12.87
		1711.5	14.39	13.81	13.08
	8RB High (7)	1778.5	13.61	12.70	11.97
		1745	13.63	12.77	12.04
		1711.5	13.43	12.47	11.74
	8RB Middle (4)	1778.5	13.60	12.69	11.96
		1745	13.66	12.78	12.05
		1711.5	13.43	12.53	11.80
	8RB Low (0)	1778.5	13.61	12.71	11.98
		1745	13.64	12.79	12.06
		1711.5	13.38	12.52	11.79
	15RB (0)	1778.5	13.66	12.58	11.85
		1745	13.63	12.67	11.94
		1711.5	13.39	12.40	11.67

5 MHz	1RB High (24)	1777.5	14.64	13.82	13.09
		1745	14.76	13.87	13.14
		1712.5	14.43	13.95	13.22
	1RB Middle (12)	1777.5	14.66	13.76	13.03
		1745	14.71	13.79	13.06
		1712.5	14.34	13.94	13.21
	1RB Low (0)	1777.5	14.68	13.81	13.08
		1745	14.74	13.86	13.13
		1712.5	14.42	13.99	13.26
	12RB High (13)	1777.5	13.60	12.68	11.95
		1745	13.65	12.75	12.02
		1712.5	13.43	12.57	11.84
	12RB Middle (6)	1777.5	13.65	12.71	11.98
		1745	13.69	12.74	12.01
		1712.5	13.43	12.61	11.88
	12RB Low (0)	1777.5	13.66	12.69	11.96
		1745	13.63	12.75	12.02
		1712.5	13.38	12.60	11.87
25RB (0)	1777.5	13.58	12.61	11.88	
	1745	13.68	12.69	11.96	
	1712.5	13.44	12.50	11.77	
10 MHz	1RB High (49)	1775	14.64	13.51	12.78
		1745	14.73	14.10	13.37
		1715	14.46	13.41	12.68
	1RB Middle (24)	1775	14.63	13.55	12.82
		1745	14.70	14.04	13.31
		1715	14.42	13.42	12.69
	1RB Low (0)	1775	14.29	13.52	12.79
		1745	14.37	14.08	13.35
		1715	14.44	13.50	12.77
	25RB High (25)	1775	13.60	12.61	11.88
		1745	13.66	12.70	11.97
		1715	13.42	12.54	11.81
	25RB Middle (12)	1775	13.64	12.68	11.95
		1745	13.71	12.72	11.99
		1715	13.47	12.51	11.78
	25RB Low (0)	1775	13.65	12.63	11.90
		1745	13.73	12.72	11.99
		1715	13.45	12.56	11.83
50RB (0)	1775	13.63	12.61	11.88	
	1745	13.71	12.70	11.97	
	1715	13.40	12.47	11.74	
15 MHz	1RB High (74)	1772.5	14.59	14.00	13.27
		1745	14.69	13.67	12.94
		1717.5	14.50	13.86	13.13
	1RB Middle (37)	1772.5	14.51	13.98	13.25
		1745	14.64	13.60	12.87
1717.5	14.48	13.89	13.16		

	1RB Low (0)	1772.5	14.72	14.17	13.44
		1745	14.75	13.72	12.99
		1717.5	14.61	13.98	13.25
	36RB High (38)	1772.5	13.51	12.50	11.77
		1745	13.67	12.71	11.98
		1717.5	13.44	12.50	11.77
	36RB Middle (19)	1772.5	13.52	12.51	11.78
		1745	13.69	12.70	11.97
		1717.5	13.47	12.57	11.84
	36RB Low (0)	1772.5	13.53	12.48	11.75
		1745	13.70	12.76	12.03
		1717.5	13.49	12.52	11.79
	75RB (0)	1772.5	13.51	12.55	11.82
		1745	13.67	12.73	12.00
		1717.5	13.47	12.51	11.78
20 MHz	1RB High (99)	1770	14.38	13.86	13.13
		1745	14.61	14.09	13.36
		1720	14.46	13.96	13.30
	1RB Middle (50)	1770	14.35	13.78	13.11
		1745	14.59	14.17	13.40
		1720	14.33	13.83	13.13
	1RB Low (0)	1770	14.56	13.98	13.46
		1745	14.71	14.25	13.44
		1720	14.47	14.03	13.38
	50RB High (50)	1770	13.43	12.44	12.14
		1745	13.61	12.70	12.31
		1720	13.39	12.44	12.06
	50RB Middle (25)	1770	13.44	12.42	12.18
		1745	13.67	12.68	12.31
		1720	13.41	12.41	12.06
	50RB Low (0)	1770	13.58	12.54	12.26
		1745	13.65	12.73	12.41
		1720	13.43	12.45	12.10
	100RB (0)	1770	13.43	12.42	12.18
		1745	13.63	12.68	12.33
		1720	13.40	12.40	12.04

11.3 Wi-Fi Measurement result

Power Level A1

The average conducted power for Wi-Fi is as following:

802.11b		
Channel\data rate	1Mbps	Tune up
11(2462MHz)	21.13	20.00
6(2437(MHz)	21.18	20.00
1(2412MHz)	21.53	20.00
802.11g		
Channel\data rate	6Mbps	Tune up
11(2462MHz)	18.35	19.50
6(2437(MHz)	19.59	21.00
1(2412MHz)	18.80	20.00
802.11n-20MHz		
Channel\data rate	MCS0	Tune up
11(2462MHz)	17.64	19.00
6(2437(MHz)	19.34	21.00
1(2412MHz)	19.02	20.50
802.11n-40MHz		
Channel\data rate	MCS0	Tune up
9(2452MHz)	14.87	15.50
6(2437MHz)	18.78	20.00
3(2422MHz)	16.23	17.50

802.11a(dBm)		
Channel\data rate	6Mbps	Tune up
36(5180 MHz)	19.64	21.00
40(5200 MHz)	19.67	21.00
44(5220 MHz)	20.08	21.00
48(5240 MHz)	19.49	21.00
149(5745 MHz)	19.47	21.00
153(5765 MHz)	19.66	21.00
157(5785 MHz)	19.85	21.00
161(5805 MHz)	19.89	21.00

Power Level B1

The average conducted power for Wi-Fi is as following:

802.11b		
Channel\data rate	1Mbps	Tune up
11(2462MHz)	17.35	18.00
6(2437(MHz)	17.40	18.00
1(2412MHz)	17.52	18.00
802.11g		
Channel\data rate	6Mbps	Tune up
11(2462MHz)	16.79	18.00
6(2437(MHz)	16.78	18.00
1(2412MHz)	16.83	18.00
802.11n-20MHz		
Channel\data rate	MCS0	Tune up
11(2462MHz)	16.52	18.00
6(2437(MHz)	16.51	18.00
1(2412MHz)	16.60	18.00
802.11n-40MHz		
Channel\data rate	MCS0	Tune up
9(2452MHz)	16.69	18.00
6(2437MHz)	16.56	18.00
3(2422MHz)	16.62	18.00

802.11ac(dBm)-80MHz		
Channel\data rate	MCS0	Tune up
42(5210 MHz)	11.45	12.50
155(5775 MHz)	11.35	12.50

Power Level C1

The average conducted power for Wi-Fi is as following:

802.11b		
Channel\data rate	1Mbps	Tune up
11(2462MHz)	12.11	12.50
6(2437(MHz)	12.03	12.50
1(2412MHz)	12.23	12.50
802.11g		
Channel\data rate	6Mbps	Tune up
11(2462MHz)	11.43	12.50
6(2437(MHz)	11.38	12.50
1(2412MHz)	11.51	12.50
802.11n-20MHz		
Channel\data rate	MCS0	Tune up
11(2462MHz)	11.17	12.50
6(2437(MHz)	10.99	12.50
1(2412MHz)	11.23	12.50
802.11n-40MHz		
Channel\data rate	MCS0	Tune up
9(2452MHz)	11.96	12.50
6(2437MHz)	11.53	12.50
3(2422MHz)	11.68	12.50

802.11ac(dBm)-80MHz		
Channel\data rate	MCS0	Tune up
42(5210 MHz)	4.41	6.00
155(5775 MHz)	4.71	6.00

12 Transmit Antenna Position and Size

12.1 Introduction

The following procedures adopted from “FCC SAR Considerations for Cell Phones with Multiple Transmitters” are applicable to handsets with built-in unlicensed transmitters such as 802.11 a/b/g and Bluetooth devices which may simultaneously transmit with the licensed transmitter.

For this device, the BT and Wi-Fi can transmit simultaneous with other transmitters.

12.2 Transmit Antenna Separation Distances

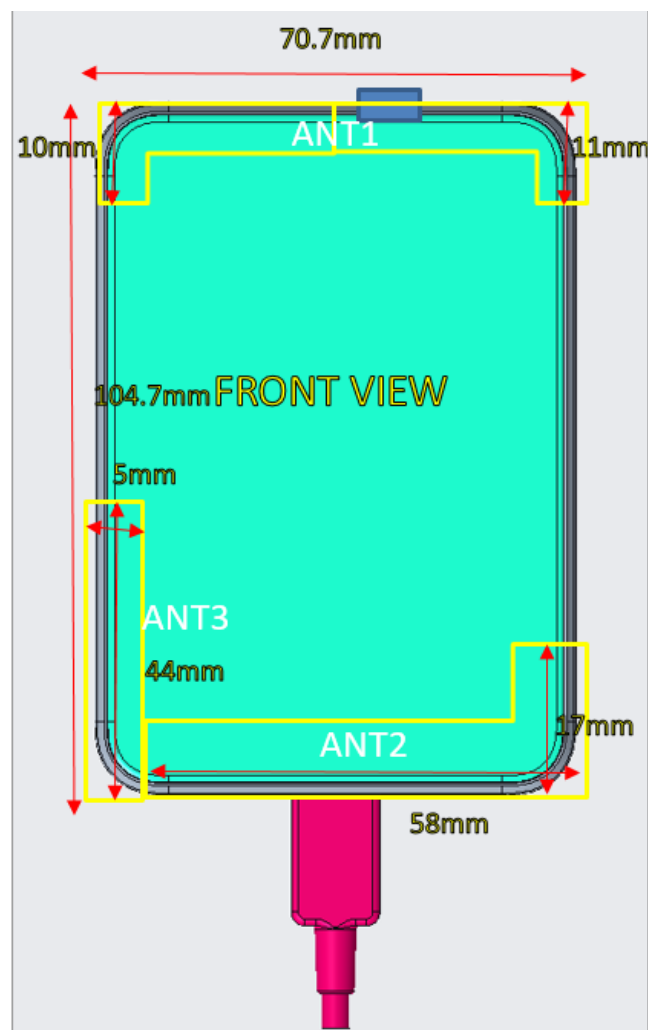

Note: ANT1-Main Antenna, ANT3-Wifi Antenna

Picture 12.1 Antenna Position and size

12.3 SAR Measurement Positions

According to the KDB941225 D06 Hot Spot SAR v01, the edges with less than 2.5 cm distance to the antennas need to be tested for SAR.

SAR measurement positions						
Mode	Front	Rear	Left edge	Right edge	Top edge	Bottom edge
Main antenna- ANT1	Yes	Yes	Yes	Yes	Yes	No
WLAN antenna-ANT3	Yes	Yes	Yes	No	No	Yes

12.4 Standalone SAR Test Exclusion Considerations

Standalone 1-g head or body SAR evaluation by measurement or numerical simulation is not required when the corresponding SAR Exclusion Threshold condition, listed below, is satisfied. The 1-g SAR test exclusion threshold for 100 MHz to 6 GHz at test separation distances ≤ 50 mm are determined by:

$$\left[\frac{\text{max. power of channel, including tune-up tolerance, mW}}{\text{min. test separation distance, mm}} \right] \cdot \left[\sqrt{f(\text{GHz})} \right] \leq 3.0 \text{ for 1-g SAR, where}$$

- $f(\text{GHz})$ is the RF channel transmit frequency in GHz
- Power and distance are rounded to the nearest mW and mm before calculation
- The result is rounded to one decimal place for comparison

Table 12.1: Standalone SAR test exclusion considerations

Band/Mode	F(GHz)	Position	SAR test exclusion threshold(mW)	RF output power		SAR test exclusion
				dBm	mW	
2.4GHz WLAN	2.45	Head	9.58	22	158	No
		Body	19.17	22	158	No
5GHz WLAN	5.2	Head	6.58	21	126	No
		Body	13.16	21	126	No
	5.3	Head	6.52	20.5	112	No
		Body	13.03	20.5	112	No
	5.6	Head	6.34	21	126	No
		Body	12.68	21	126	No
	5.8	Head	6.23	21	126	No
		Body	12.46	21	126	No

13 Evaluation of Simultaneous

Table 13.1: The sum of reported SAR values for Main antenna and WiFi-2.4G

	Position	Cellular antenna	WiFi2.4G	Sum
Highest reported SAR value for Body	Rear 0mm	1.22	0.25	1.47

Table 13.2: The sum of reported SAR values for Main antenna + WiFi-5G

	Position	Cellular antenna	WiFi-5G	Sum
Maximum reported SAR value for Body	Rear 21mm	1.19	0.39	1.58
Maximum reported SAR value for Body	Left 15mm	0.35	1.23	1.58

Conclusion:

According to the above tables, the sum of reported SAR values is 1.6W/kg. So the simultaneous transmission SAR with volume scans is not required.

14 SAR Test Result

It is determined by user manual for the distance between the EUT and the phantom bottom.
The distance is 10mm 15mm or 0mm and just applied to the condition of body worn accessory.

It is performed for all SAR measurements with area scan based 1-g SAR estimation (Fast SAR). A zoom scan measurement is added when the estimated 1-g SAR is the highest measured SAR in each exposure configuration, wireless mode and frequency band combination or more than 1.2W/kg.

The calculated SAR is obtained by the following formula:

$$\text{Reported SAR} = \text{Measured SAR} \times 10^{(P_{\text{Target}} - P_{\text{Measured}})/10}$$

Where P_{Target} is the power of manufacturing upper limit;

P_{Measured} is the measured power in chapter 11.

Table 13.1: Duty Cycle

Mode	Duty Cycle
WCDMA<E FDD	1:1

14.1 SAR results for Fast SAR(Non-USB)

Table 14.1-1: SAR Values (WCDMA 1700 MHz Band - Body)

Frequency		Test Position	Figure No./Note	Conducted Power (dBm)	Max. tune-up Power (dBm)	Ambient Temperature: 22.9 °C		Liquid Temperature: 22.5°C		Power Drift (dB)
Ch.	MHz					Measured SAR(10g) (W/kg)	Reported SAR(10g) (W/kg)	Measured SAR(1g) (W/kg)	Reported SAR(1g) (W/kg)	
1412	1732.5	Front	15mm	23.74	24.50	0.290	0.35	0.465	0.55	-0.12
1513	1752.6	Rear	21mm	23.64	24.50	0.585	0.71	0.970	1.18	0.08
1412	1732.5	Rear	21mm/ Fig.1	23.74	24.50	0.604	0.72	1.000	1.19	0.03
1312	1712.4	Rear	21mm	23.63	24.50	0.577	0.70	0.955	1.17	0.08
1412	1732.5	Left	15mm	23.74	24.50	0.124	0.15	0.191	0.23	-0.06
1412	1732.5	Right	15mm	23.74	24.50	0.042	0.05	0.065	0.08	0.12
1412	1732.5	Top	19mm	23.74	24.50	0.556	0.66	0.938	1.12	0.08
1412	1732.5	Rear	/	19.18	20.80	0.25	0.36	0.174	0.25	-0.09
1412	1732.5	Right	/	19.18	20.80	0.201	0.29	0.129	0.19	-0.10
1412	1732.5	Top	/	19.18	20.80	0.189	0.27	0.116	0.17	0.03
1412	1732.5	Front	/	16.41	17.00	0.132	0.15	0.220	0.25	0.13
1513	1752.6	Rear	/	16.43	17.00	0.314	0.36	0.574	0.65	-0.16
1412	1732.5	Left	/	16.41	17.00	0.335	0.38	0.607	0.70	-0.05
1312	1712.4	Right	/	16.45	17.00	0.301	0.34	0.547	0.62	0.08
1412	1732.5	Top	/	16.41	17.00	0.042	0.05	0.067	0.08	0.12
1412	1732.5	Top	/	16.41	17.00	0.000	0.00	0.000	0.00	-0.04
1412	1732.5	Top	/	16.41	17.00	0.323	0.37	0.586	0.67	-0.19

Note1: The distance between the EUT and the phantom bottom is 15mm/19mm/21mm by sensor (See detail in annex I). The distance between the EUT and the phantom bottom for other configuration is 10mm.

Table 14.1-2: SAR Values (WCDMA 1900 MHz Band - Body)

Frequency		Test Position	Figure No.	Conducted Power (dBm)	Max. tune-up Power (dBm)	Ambient Temperature: 22.9 °C		Liquid Temperature: 22.5 °C		Power Drift (dB)
Ch.	MHz					Measured SAR(10g) (W/kg)	Reported SAR(10g) (W/kg)	Measured SAR(1g) (W/kg)	Reported SAR(1g) (W/kg)	
9400	1880	Front	15mm	23.71	24.50	0.332	0.40	0.559	0.67	0.03
9400	1880	Rear	21mm	23.71	24.50	0.247	0.30	0.413	0.50	-0.12
9400	1880	Left	15mm	23.71	24.50	0.092	0.11	0.149	0.18	0.09
9400	1880	Right	15mm	23.71	24.50	0.130	0.16	0.203	0.24	-0.09
9538	1907.6	Top	19mm	23.79	24.50	0.357	0.42	0.608	0.72	0.05
9400	1880	Top	19mm	23.71	24.50	0.514	0.62	0.738	0.89	-0.13
9262	1852.4	Top	19mm/ Fig.2	23.65	24.50	0.504	0.61	0.868	1.06	0.03
9400	1880	Front	/	17.21	18.00	0.120	0.14	0.201	0.24	-0.09
9400	1880	Rear	/	17.21	18.00	0.263	0.32	0.502	0.60	0.05
9400	1880	Left	/	17.21	18.00	0.037	0.04	0.063	0.08	0.13
9400	1880	Right	/	17.21	18.00	0.041	0.05	0.066	0.08	-0.05
9538	1907.6	Top	/	17.23	18.00	0.223	0.27	0.416	0.50	-0.07
9400	1880	Top	/	17.21	18.00	0.278	0.33	0.520	0.62	-0.08
9262	1852.4	Top	/	17.20	18.00	0.316	0.38	0.587	0.71	0.08

Note1: The distance between the EUT and the phantom bottom is 15mm/19mm/21mm by sensor (See detail in annex I). The distance between the EUT and the phantom bottom for other configuration is 10mm.

Table 14.1-3: SAR Values (LTE Band12- Body)

Ambient Temperature: 22.9 °C Liquid Temperature: 22.5 °C

Frequency		Mode	Test Position	Figure No.	Conducted Power (dBm)	Max. tune-up Power (dBm)	Measured SAR(10g) (W/kg)	Reported SAR(10g) (W/kg)	Measured SAR(1g) (W/kg)	Reported SAR(1g) (W/kg)	Power Drift (dB)
Ch.	MHz										
23060	704	1RB_Mid	Front	15mm	21.26	22.50	0.274	0.36	0.378	0.50	-0.02
23060	704	1RB_Mid	Rear	21mm/ Fig.3	21.26	22.50	0.361	0.48	0.493	0.66	-0.01
23060	704	1RB_Mid	Left	15mm	21.26	22.50	0.168	0.22	0.232	0.31	-0.19
23060	704	1RB_Mid	Right	15mm	21.26	22.50	0.153	0.20	0.211	0.28	-0.02
23060	704	1RB_Mid	Top	19mm	21.26	22.50	<0.01	<0.01	<0.01	<0.01	/
23130	711	25RB_Mid	Front	15mm	20.16	21.50	0.203	0.28	0.278	0.38	-0.03
23130	711	25RB_Mid	Rear	21mm	20.16	21.50	0.289	0.39	0.397	0.54	0.11
23130	711	25RB_Mid	Left	15mm	20.16	21.50	0.125	0.17	0.175	0.24	-0.17
23130	711	25RB_Mid	Right	15mm	20.16	21.50	0.112	0.15	0.154	0.21	0.17
23130	711	25RB_Mid	Top	19mm	20.16	21.50	<0.01	<0.01	<0.01	<0.01	/
23130	711	1RB_Mid	Front	/	21.26	22.50	0.274	0.36	0.378	0.50	-0.02
23130	711	1RB_Mid	Rear	/	21.26	22.50	0.361	0.48	0.493	0.66	-0.01
23130	711	1RB_Mid	Left	/	21.26	22.50	0.168	0.22	0.232	0.31	-0.19
23130	711	1RB_Mid	Right	/	21.26	22.50	0.153	0.20	0.211	0.28	-0.02
23130	711	1RB_Mid	Top	/	21.26	22.50	<0.01	<0.01	<0.01	<0.01	/
23060	704	25RB_Mid	Front	/	20.16	21.50	0.203	0.28	0.278	0.38	-0.03
23060	704	25RB_Mid	Rear	/	20.16	21.50	0.289	0.39	0.397	0.54	0.11
23060	704	25RB_Mid	Left	/	20.16	21.50	0.125	0.17	0.175	0.24	-0.17
23060	704	25RB_Mid	Right	/	20.16	21.50	0.112	0.15	0.154	0.21	0.17
23060	704	25RB_Mid	Top	/	20.16	21.50	<0.01	<0.01	<0.01	<0.01	/

Note1: The distance between the EUT and the phantom bottom is 15mm/19mm/21mm by sensor (See detail in annex I). The distance between the EUT and the phantom bottom for other configuration is 10mm.

Note2: The LTE mode is QPSK_10MHz.

Table 14.1-4: SAR Values (LTE Band25 - Body)

Ambient Temperature: 22.9 °C					Liquid Temperature: 22.5 °C						
Frequency		Mode	Test Position	Figure No.	Conducted Power (dBm)	Max. tune-up Power (dBm)	Measured SAR(10g) (W/kg)	Reported SAR(10g) (W/kg)	Measured SAR(1g) (W/kg)	Reported SAR(1g) (W/kg)	Power Drift (dB)
Ch.	MHz										
26590	1905	1RB_Mid	Front	15mm	22.95	23.50	0.247	0.28	0.406	0.46	-0.12
26590	1905	1RB_Mid	Rear	21mm	22.95	23.50	0.193	0.22	0.319	0.36	0.03
26590	1905	1RB_Mid	Left	15mm	22.95	23.50	0.087	0.10	0.146	0.17	-0.06
26590	1905	1RB_Mid	Right	15mm	22.95	23.50	0.090	0.10	0.142	0.16	0.09
26590	1905	1RB_Mid	Top	19mm	22.95	23.50	0.295	0.33	0.513	0.58	0.03
26590	1905	50RB_Low	Front	15mm	21.84	22.50	0.191	0.22	0.311	0.36	-0.11
26590	1905	50RB_Low	Rear	21mm	21.84	22.50	0.150	0.17	0.248	0.29	0.15
26590	1905	50RB_Low	Left	15mm	21.84	22.50	0.064	0.07	0.106	0.12	-0.13
26590	1905	50RB_Low	Right	15mm	21.84	22.50	0.069	0.08	0.108	0.13	0.16
26590	1905	50RB_Low	Top	19mm	21.84	22.50	0.226	0.26	0.394	0.46	-0.07
26140	1860	1RB_Mid	Front	/	16.94	18.00	0.110	0.14	0.177	0.23	0.07
26140	1860	1RB_Mid	Rear	/	16.94	18.00	0.293	0.37	0.533	0.68	0.07
26140	1860	1RB_Mid	Left	/	16.94	18.00	0.030	0.04	0.052	0.07	0.01
26140	1860	1RB_Mid	Right	/	16.94	18.00	0.050	0.06	0.079	0.10	-0.06
26140	1860	1RB_Mid	Top	Fig.4	16.94	18.00	0.291	0.37	0.541	0.69	0.02
26590	1905	50RB_Mid	Front	/	15.78	17.00	0.182	0.24	0.341	0.45	-0.10
26590	1905	50RB_Mid	Rear	/	15.78	17.00	0.174	0.23	0.315	0.42	0.10
26590	1905	50RB_Mid	Left	/	15.78	17.00	0.039	0.05	0.064	0.08	0.01
26590	1905	50RB_Mid	Right	/	15.78	17.00	0.031	0.04	0.048	0.06	-0.11
26590	1905	50RB_Mid	Top	/	15.78	17.00	0.182	0.24	0.341	0.45	0.10

Note1: The distance between the EUT and the phantom bottom is 15mm/19mm/21mm by sensor (See detail in annex I). The distance between the EUT and the phantom bottom for other configuration is 10mm.

Note2: The LTE mode is QPSK_20MHz.

Table 14.1-5: SAR Values (LTE Band26 - Body)

Ambient Temperature: 22.9 °C					Liquid Temperature: 22.5 °C						
Frequency		Mode	Test Position	Figure No.	Conducted Power (dBm)	Max. tune-up Power (dBm)	Measured SAR(10g) (W/kg)	Reported SAR(10g) (W/kg)	Measured SAR(1g) (W/kg)	Reported SAR(1g) (W/kg)	Power Drift (dB)
Ch.	MHz										
26965	841.5	1RB_Mid	Front	15mm /Fig.5	23.31	23.50	0.605	0.63	0.828	0.87	-0.01
26865	831.5	1RB_Mid	Front	15mm	23.29	23.50	0.572	0.60	0.764	0.80	0.05
26775	822.5	1RB_High	Front	15mm	22.93	23.50	0.553	0.63	0.742	0.85	-0.06
26965	841.5	100RB	Front	15mm	21.95	22.50	0.458	0.52	0.649	0.74	-0.08
26965	841.5	1RB_Mid	Rear	21mm	23.31	23.50	0.499	0.52	0.680	0.71	-0.06
26965	841.5	1RB_Mid	Left	15mm	23.31	23.50	0.238	0.25	0.335	0.35	0.14
26965	841.5	1RB_Mid	Right	15mm	23.31	23.50	0.273	0.29	0.375	0.39	0.08
26965	841.5	1RB_Mid	Top	19mm	23.31	23.50	0.030	0.03	0.046	0.05	0.13
26775	822.5	36RB_Mid	Front	15mm	22.12	22.50	0.477	0.52	0.649	0.71	-0.03
26775	822.5	36RB_Mid	Rear	21mm	22.12	22.50	0.449	0.49	0.620	0.68	0.15
26775	822.5	36RB_Mid	Left	15mm	22.12	22.50	0.149	0.16	0.206	0.22	0.16
26775	822.5	36RB_Mid	Right	15mm	22.12	22.50	0.214	0.23	0.294	0.32	-0.11
26775	822.5	36RB_Mid	Top	19mm	22.12	22.50	<0.01	<0.01	<0.01	<0.01	/
26775	822.5	1RB_Low	Front	/	20.70	21.50	0.343	0.41	0.465	0.56	0.04
26775	822.5	1RB_Low	Rear	/	20.70	21.50	0.335	0.40	0.456	0.55	0.17
26775	822.5	1RB_Low	Left	/	20.70	21.50	0.164	0.20	0.231	0.28	0.02
26775	822.5	1RB_Low	Right	/	20.70	21.50	0.182	0.22	0.252	0.30	0.02
26775	822.5	1RB_Low	Top	/	20.70	21.50	<0.01	<0.01	<0.01	<0.01	/
26775	822.5	36RB_High	Front	/	19.67	20.50	0.286	0.35	0.392	0.47	-0.03
26775	822.5	36RB_High	Rear	/	19.67	20.50	0.276	0.33	0.376	0.46	-0.14
26775	822.5	36RB_High	Left	/	19.67	20.50	0.137	0.17	0.190	0.23	0.18
26775	822.5	36RB_High	Right	/	19.67	20.50	0.157	0.19	0.218	0.26	-0.10
26775	822.5	36RB_High	Top	/	19.67	20.50	<0.01	<0.01	<0.01	<0.01	/

Note1: The distance between the EUT and the phantom bottom is 15mm/19mm/21mm by sensor (See detail in annex I). The distance between the EUT and the phantom bottom for other configuration is 10mm.

Note2: The LTE mode is QPSK_15MHz.

Table 14.1-6: SAR Values (LTE Band41 - Body)

Ambient Temperature: 22.9 °C					Liquid Temperature: 22.5 °C						
Frequency		Mode	Test Position	Figure No.	Conducted Power (dBm)	Max. tune-up Power (dBm)	Measured SAR(10g) (W/kg)	Reported SAR(10g) (W/kg)	Measured SAR(1g) (W/kg)	Reported SAR(1g) (W/kg)	Power Drift (dB)
Ch.	MHz										
41490	2680	1RB_Mid	Front	15mm	23.42	23.50	0.120	0.12	0.227	0.23	-0.11
41490	2680	1RB_Mid	Rear	21mm	23.42	23.50	0.072	0.07	0.127	0.13	-0.07
41490	2680	1RB_Mid	Left	15mm	23.42	23.50	0.069	0.07	0.120	0.12	0.16
41490	2680	1RB_Mid	Right	15mm	23.42	23.50	0.087	0.09	0.154	0.16	-0.14
41490	2680	1RB_Mid	Top	19mm /Fig.6	23.42	23.50	0.131	0.13	0.238	0.24	0.06
40620	2593	50RB_High	Front	15mm	22.28	22.50	0.109	0.11	0.204	0.21	0.03
40620	2593	50RB_High	Rear	21mm	22.28	22.50	0.069	0.07	0.122	0.13	-0.14
40620	2593	50RB_High	Left	15mm	22.28	22.50	0.039	0.04	0.069	0.07	0.02
40620	2593	50RB_High	Right	15mm	22.28	22.50	0.070	0.07	0.125	0.13	0.06
40620	2593	50RB_High	Top	19mm	22.28	22.50	0.129	0.14	0.229	0.24	0.07
40620	2593	1RB_Mid	Front	/	16.66	17.50	0.027	0.03	0.053	0.06	0.00
40620	2593	1RB_Mid	Rear	/	16.66	17.50	0.034	0.04	0.069	0.08	0.03
40620	2593	1RB_Mid	Left	/	16.66	17.50	0.007	0.01	0.030	0.04	-0.06
40620	2593	1RB_Mid	Right	/	16.66	17.50	0.013	0.02	0.023	0.03	-0.05
40620	2593	1RB_Mid	Top	/	16.66	17.50	0.046	0.06	0.095	0.12	-0.06
41490	2680	50RB_Mid	Front	/	15.31	16.50	0.017	0.02	0.033	0.04	0.17
41490	2680	50RB_Mid	Rear	/	15.31	16.50	0.020	0.03	0.040	0.05	0.19
41490	2680	50RB_Mid	Left	/	15.31	16.50	0.006	0.01	0.022	0.03	0.18
41490	2680	50RB_Mid	Right	/	15.31	16.50	0.007	0.01	0.022	0.03	0.16
41490	2680	50RB_Mid	Top	/	15.31	16.50	0.022	0.03	0.043	0.06	-0.10

Note1: The distance between the EUT and the phantom bottom is 15mm/19mm/21mm by sensor (See detail in annex I). The distance between the EUT and the phantom bottom for other configuration is 10mm.

Note2: The LTE mode is QPSK_20MHz.

Table 14.1-7: SAR Values (LTE Band66 - Body)

Frequency		Mode	Test Position	Figure No.	Ambient Temperature: 22.9°C		Liquid Temperature: 22.5°C		Measured SAR(1g) (W/kg)	Reported SAR(1g) (W/kg)	Power Drift (dB)
Ch.	MHz				Conduct ed Power (dBm)	tune-up Power (dBm)	Measured SAR(10g) (W/kg)	Reported SAR(10g) (W/kg)			
132322	1745	1RB_Mid	Front	15mm	23.24	23.50	0.291	0.31	0.455	0.48	-0.02
132322	1745	1RB_Mid	Rear	21mm	23.24	23.50	0.337	0.36	0.550	0.58	-0.12
132322	1745	1RB_Mid	Left	15mm	23.24	23.50	0.189	0.20	0.294	0.31	0.15
132322	1745	1RB_Mid	Right	15mm	23.24	23.50	0.043	0.05	0.068	0.07	0.19
132572	1770	1RB_Mid	Top	19mm	23.00	23.50	0.412	0.46	0.698	0.78	-0.16
132322	1745	1RB_Mid	Top	19mm	23.24	23.50	0.496	0.53	0.835	0.89	-0.06
132072	1720	1RB_Mid	Top	19mm	23.01	23.50	0.486	0.54	0.777	0.87	0.10
132322	1745	50RB_Low	Front	15mm	21.76	22.50	0.246	0.29	0.378	0.45	0.19
132322	1745	50RB_Low	Rear	21mm	21.76	22.50	0.294	0.35	0.485	0.58	-0.01
132322	1745	50RB_Low	Left	15mm	21.76	22.50	0.111	0.13	0.174	0.21	-0.03
132322	1745	50RB_Low	Right	15mm	21.76	22.50	0.033	0.04	0.051	0.06	0.19
132572	1770	50RB_Low	Top	19mm	21.59	22.50	0.358	0.44	0.606	0.75	-0.17
132322	1745	50RB_Low	Top	19mm	21.76	22.50	0.415	0.49	0.699	0.83	-0.16
132072	1720	50RB_Low	Top	19mm	21.67	22.50	0.404	0.49	0.676	0.82	0.14
132322	1745	100RB	Top	/	21.75	22.50	0.420	0.50	0.712	0.85	0.09
27710	2310	1RB_Mid	Front	/	19.99	21.50	0.201	0.28	0.140	0.20	-0.11
132322	1745	1RB_Mid	Rear	/	16.88	18.00	0.147	0.19	0.240	0.31	-0.03
132322	1745	1RB_Mid	Left	Fig.7	16.88	18.00	0.386	0.50	0.706	0.91	0.18
132322	1745	1RB_Mid	Right	/	16.88	18.00	0.084	0.11	0.174	0.23	-0.16
132322	1745	1RB_Mid	Top	/	16.88	18.00	<0.01	<0.01	<0.01	<0.01	/
132322	1745	50RB_Mid	Front	/	16.88	18.00	0.359	0.46	0.659	0.85	-0.09
132322	1745	50RB_Mid	Rear	/	15.91	17.00	0.122	0.16	0.201	0.26	0.09
132322	1745	50RB_Mid	Left	/	15.91	17.00	0.289	0.37	0.521	0.67	-0.06
132322	1745	50RB_Mid	Right	/	15.91	17.00	0.047	0.06	0.076	0.10	-0.07
132322	1745	50RB_Mid	Top	/	15.91	17.00	<0.01	<0.01	<0.01	<0.01	/

Note1: The distance between the EUT and the phantom bottom is 15mm/19mm/21mm by sensor (See detail in annex I). The distance between the EUT and the phantom bottom for other configuration is 10mm.

Note2: The LTE mode is QPSK_20MHz.

Table 14.1-8: SAR Values (LTE Band71 - Body)

Ambient Temperature: 22.9 °C Liquid Temperature: 22.5 °C

Frequency		Mode	Test Position	Figure No.	Conducted Power (dBm)	Max. tune-up Power (dBm)	Measured SAR(10g) (W/kg)	Reported SAR(10g) (W/kg)	Measured SAR(1g) (W/kg)	Reported SAR(1g) (W/kg)	Power Drift (dB)
Ch.	MHz										
133322	683	1RB_Mid	Front	15mm/ Fig.8	22.98	23.50	0.251	0.28	0.349	0.39	-0.04
133322	683	1RB_Mid	Rear	21mm	22.98	23.50	0.209	0.24	0.284	0.32	-0.09
133322	683	1RB_Mid	Left	15mm	22.98	23.50	0.127	0.14	0.173	0.20	0.03
133322	683	1RB_Mid	Right	15mm	22.98	23.50	0.136	0.15	0.185	0.21	-0.05
133322	683	1RB_Mid	Top	19mm	22.98	23.50	<0.01	<0.01	<0.01	<0.01	/
133222	673	50RB_High	Front	15mm	21.76	22.50	0.190	0.23	0.264	0.31	0.10
133222	673	50RB_High	Rear	21mm	21.76	22.50	0.169	0.20	0.228	0.27	-0.09
133222	673	50RB_High	Left	15mm	21.76	22.50	0.105	0.12	0.145	0.17	0.00
133222	673	50RB_High	Right	15mm	21.76	22.50	0.105	0.12	0.145	0.17	-0.05
133222	673	50RB_High	Top	19mm	21.76	22.50	<0.01	<0.01	<0.01	<0.01	/
133222	673	1RB_High	Front	/	19.82	21.00	0.158	0.21	0.221	0.29	0.18
133222	673	1RB_High	Rear	/	19.82	21.00	0.191	0.25	0.265	0.35	0.02
133222	673	1RB_High	Left	/	19.82	21.00	0.092	0.12	0.130	0.17	-0.13
133222	673	1RB_High	Right	/	19.82	21.00	0.087	0.11	0.120	0.16	-0.05
133222	673	1RB_High	Top	/	19.82	21.00	<0.01	<0.01	<0.01	<0.01	/
133222	673	50RB_Mid	Front	/	18.74	20.00	0.123	0.16	0.171	0.23	-0.09
133222	673	50RB_Mid	Rear	/	18.74	20.00	0.153	0.20	0.209	0.28	-0.03
133222	673	50RB_Mid	Left	/	18.74	20.00	0.067	0.09	0.093	0.12	0.16
133222	673	50RB_Mid	Right	/	18.74	20.00	0.065	0.09	0.090	0.12	0.04
133222	673	50RB_Mid	Top	/	18.74	20.00	<0.01	<0.01	<0.01	<0.01	/

Note1: The distance between the EUT and the phantom bottom is 15mm/19mm/21mm by sensor (See detail in annex I). The distance between the EUT and the phantom bottom for other configuration is 10mm.

Note2: The LTE mode is QPSK_20MHz.

14.2 SAR results for Fast SAR(USB)

Table 14.2-1: SAR Values (WCDMA 1700 MHz Band - Body)

Frequency		Test Position	Figure No./Note	Conducted Power (dBm)	Max. tune-up Power (dBm)	Ambient Temperature: 22.9 °C		Liquid Temperature: 22.5°C		Power Drift (dB)
Ch.	MHz					Measured SAR(10g) (W/kg)	Reported SAR(10g) (W/kg)	Measured SAR(1g) (W/kg)	Reported SAR(1g) (W/kg)	
1412	1732.5	Front	15mm	23.74	24.50	0.290	0.35	0.465	0.55	-0.12
1513	1752.6	Rear	21mm	23.64	24.50	0.585	0.71	0.970	1.18	0.08
1412	1732.5	Rear	21mm/ Fig.9	23.74	24.50	0.604	0.72	1.000	1.19	0.03
1312	1712.4	Rear	21mm	23.63	24.50	0.577	0.70	0.955	1.17	0.08
1412	1732.5	Left	15mm	23.74	24.50	0.124	0.15	0.191	0.23	-0.06
1412	1732.5	Right	15mm	23.74	24.50	0.042	0.05	0.065	0.08	0.12
1412	1732.5	Top	19mm	23.74	24.50	0.556	0.66	0.938	1.12	0.08
1412	1732.5	Front	/	12.37	13.00	0.144	0.17	0.284	0.33	-0.02
1412	1732.5	Rear	/	12.37	13.00	0.196	0.23	0.433	0.50	-0.07
1412	1732.5	Left	/	12.37	13.00	0.05	0.06	0.103	0.12	-0.14
1412	1732.5	Right	/	12.37	13.00	0.027	0.03	0.055	0.06	0.10
1412	1732.5	Top	/	12.37	13.00	0.235	0.27	0.471	0.54	-0.15

Note1: The distance between the EUT and the phantom bottom is 15mm/19mm/21mm by sensor (See detail in annex I). The distance between the EUT and the phantom bottom for other configuration is 0mm.

Table 14.2-2: SAR Values (WCDMA 1900 MHz Band - Body)

Frequency		Test Position	Figure No.	Conducted Power (dBm)	Max. tune-up Power (dBm)	Ambient Temperature: 22.9 °C		Liquid Temperature: 22.5 °C		Power Drift (dB)
Ch.	MHz					Measured SAR(10g) (W/kg)	Reported SAR(10g) (W/kg)	Measured SAR(1g) (W/kg)	Reported SAR(1g) (W/kg)	
9400	1880	Front	15mm	23.71	24.50	0.332	0.40	0.559	0.67	0.03
9538	1907.6	Rear	21mm	23.79	24.50	0.222	0.26	0.371	0.44	0.03
9400	1880	Rear	21mm	23.71	24.50	0.247	0.30	0.413	0.50	-0.12
9262	1852.4	Rear	21mm	23.65	24.50	0.276	0.34	0.463	0.56	-0.08
9400	1880	Left	15mm	23.71	24.50	0.092	0.11	0.149	0.18	0.09
9400	1880	Right	15mm	23.71	24.50	0.130	0.16	0.203	0.24	-0.09
9538	1907.6	Top	19mm	23.79	24.50	0.357	0.42	0.608	0.72	0.05
9400	1880	Top	19mm	23.71	24.50	0.514	0.62	0.738	0.89	-0.13
9262	1852.4	Top	19mm/ Fig.10	23.65	24.50	0.504	0.61	0.868	1.06	0.03
9400	1880	Front	/	12.59	13.50	0.149	0.18	0.276	0.34	-0.02
9538	1907.6	Rear	/	13.18	13.50	0.208	0.22	0.478	0.51	0.08
9400	1880	Rear	/	12.59	13.50	0.212	0.26	0.489	0.60	-0.05
9262	1852.4	Rear	/	12.79	13.50	0.195	0.23	0.469	0.55	-0.09
9400	1880	Left	/	12.59	13.50	0.036	0.04	0.070	0.09	0.13
9400	1880	Right	/	12.59	13.50	0.039	0.05	0.072	0.09	0.06
9400	1880	Top	/	12.59	13.50	0.247	0.30	0.541	0.67	-0.17

Note1: The distance between the EUT and the phantom bottom is 15mm/19mm/21mm by sensor (See detail in annex I). The distance between the EUT and the phantom bottom for other configuration is 0mm.

Table 14.2-3: SAR Values (LTE Band12- Body)

Ambient Temperature: 22.9 °C Liquid Temperature: 22.5 °C

Frequency		Mode	Test Position	Figure No.	Conducted Power (dBm)	Max. tune-up Power (dBm)	Measured SAR(10g) (W/kg)	Reported SAR(10g) (W/kg)	Measured SAR(1g) (W/kg)	Reported SAR(1g) (W/kg)	Power Drift (dB)
Ch.	MHz										
23060	704	1RB_Mid	Front	15mm	21.26	22.50	0.274	0.36	0.378	0.50	-0.02
23060	704	1RB_Mid	Rear	21mm/ Fig.11	21.26	22.50	0.361	0.48	0.493	0.66	-0.01
23060	704	1RB_Mid	Left	15mm	21.26	22.50	0.168	0.22	0.232	0.31	-0.19
23060	704	1RB_Mid	Right	15mm	21.26	22.50	0.153	0.20	0.211	0.28	-0.02
23060	704	1RB_Mid	Top	19mm	21.26	22.50	<0.01	<0.01	<0.01	<0.01	/
23130	711	25RB_Mid	Front	15mm	20.16	21.50	0.203	0.28	0.278	0.38	-0.03
23130	711	25RB_Mid	Rear	21mm	20.16	21.50	0.289	0.39	0.397	0.54	0.11
23130	711	25RB_Mid	Left	15mm	20.16	21.50	0.125	0.17	0.175	0.24	-0.17
23130	711	25RB_Mid	Right	15mm	20.16	21.50	0.112	0.15	0.154	0.21	0.17
23130	711	25RB_Mid	Top	19mm	20.16	21.50	<0.01	<0.01	<0.01	<0.01	/
23130	711	1RB_Mid	Front	/	18.30	19.50	0.270	0.36	0.374	0.49	0.00
23130	711	1RB_Mid	Rear	/	18.30	19.50	0.195	0.26	0.233	0.31	0.10
23130	711	1RB_Mid	Left	/	18.30	19.50	0.194	0.26	0.260	0.34	0.12
23130	711	1RB_Mid	Right	/	18.30	19.50	0.191	0.25	0.272	0.36	-0.18
23130	711	1RB_Mid	Top	/	18.30	19.50	0.091	0.12	0.229	0.30	0.03
23060	704	25RB_Mid	Front	/	17.16	18.50	0.202	0.28	0.279	0.38	0.03
23060	704	25RB_Mid	Rear	/	17.16	18.50	0.149	0.20	0.235	0.32	-0.17
23060	704	25RB_Mid	Left	/	17.16	18.50	0.149	0.20	0.247	0.34	0.06
23060	704	25RB_Mid	Right	/	17.16	18.50	0.143	0.19	0.204	0.28	0.08
23060	704	25RB_Mid	Top	/	17.16	18.50	0.069	0.09	0.179	0.24	0.13

Note1: The distance between the EUT and the phantom bottom is 15mm/19mm/21mm by sensor (See detail in annex I). The distance between the EUT and the phantom bottom for other configuration is 0mm.

Note2: The LTE mode is QPSK_10MHz.

Table 14.2-4: SAR Values (LTE Band25 - Body)

Ambient Temperature: 22.9 °C						Liquid Temperature: 22.5 °C					
Frequency		Mode	Test Position	Figure No.	Conducted Power (dBm)	Max. tune-up Power (dBm)	Measured SAR(10g) (W/kg)	Reported SAR(10g) (W/kg)	Measured SAR(1g) (W/kg)	Reported SAR(1g) (W/kg)	Power Drift (dB)
Ch.	MHz										
26590	1905	1RB_Mid	Front	15mm	22.95	23.50	0.247	0.28	0.406	0.46	-0.12
26590	1905	1RB_Mid	Rear	21mm	22.95	23.50	0.193	0.22	0.319	0.36	0.03
26590	1905	1RB_Mid	Left	15mm	22.95	23.50	0.087	0.10	0.146	0.17	-0.06
26590	1905	1RB_Mid	Right	15mm	22.95	23.50	0.090	0.10	0.142	0.16	0.09
26590	1905	1RB_Mid	Top	19mm	22.95	23.50	0.295	0.33	0.513	0.58	0.03
26590	1905	50RB_Low	Front	15mm	21.84	22.50	0.191	0.22	0.311	0.36	-0.11
26590	1905	50RB_Low	Rear	21mm	21.84	22.50	0.150	0.17	0.248	0.29	0.15
26590	1905	50RB_Low	Left	15mm	21.84	22.50	0.064	0.07	0.106	0.12	-0.13
26590	1905	50RB_Low	Right	15mm	21.84	22.50	0.069	0.08	0.108	0.13	0.16
26590	1905	50RB_Low	Top	19mm	21.84	22.50	0.226	0.26	0.394	0.46	-0.07
26590	1905	1RB_Mid	Front	/	13.76	14.50	0.204	0.24	0.414	0.49	-0.18
26590	1905	1RB_Mid	Rear	Fig.12	13.76	14.50	0.250	0.30	0.580	0.69	-0.04
26590	1905	1RB_Mid	Left	/	13.76	14.50	0.066	0.08	0.139	0.16	0.18
26590	1905	1RB_Mid	Right	/	13.76	14.50	0.049	0.06	0.100	0.12	0.16
26590	1905	1RB_Mid	Top	/	13.76	14.50	0.274	0.32	0.554	0.66	0.09
26590	1905	50RB_Low	Front	/	13.27	13.50	0.156	0.16	0.317	0.33	0.11
26590	1905	50RB_Low	Rear	/	13.27	13.50	0.201	0.21	0.517	0.55	0.19
26590	1905	50RB_Low	Left	/	13.27	13.50	0.049	0.05	0.102	0.11	-0.07
26590	1905	50RB_Low	Right	/	13.27	13.50	0.036	0.04	0.075	0.08	0.07
26590	1905	50RB_Low	Top	/	13.27	13.50	0.228	0.24	0.459	0.48	0.08

Note1: The distance between the EUT and the phantom bottom is 15mm/19mm/21mm by sensor (See detail in annex I). The distance between the EUT and the phantom bottom for other configuration is 0mm.

Note2: The LTE mode is QPSK_20MHz.

Table 14.2-5: SAR Values (LTE Band26 - Body)

Frequency		Mode	Test Position	Figure No.	Ambient Temperature: 22.9 °C		Liquid Temperature: 22.5 °C				Power Drift (dB)
Ch.	MHz				Conducted Power (dBm)	Max. tune-up Power (dBm)	Measured SAR(10g) (W/kg)	Reported SAR(10g) (W/kg)	Measured SAR(1g) (W/kg)	Reported SAR(1g) (W/kg)	
26965	841.5	1RB_Mid	Front	15mm/ Fig.13	23.31	23.50	0.605	0.63	0.828	0.87	-0.01
26865	831.5	1RB_Mid	Front	15mm	23.29	23.50	0.572	0.60	0.764	0.80	0.05
26775	822.5	1RB_High	Front	15mm	22.93	23.50	0.553	0.63	0.742	0.85	-0.06
26965	841.5	100RB	Front	15mm	21.95	22.50	0.458	0.52	0.649	0.74	-0.08
26965	841.5	1RB_Mid	Rear	21mm	23.31	23.50	0.499	0.52	0.680	0.71	-0.06
26965	841.5	1RB_Mid	Left	15mm	23.31	23.50	0.238	0.25	0.335	0.35	0.14
26965	841.5	1RB_Mid	Right	15mm	23.31	23.50	0.273	0.29	0.375	0.39	0.08
26965	841.5	1RB_Mid	Top	19mm	23.31	23.50	0.030	0.03	0.046	0.05	0.13
26775	822.5	36RB_Mid	Front	15mm	22.12	22.50	0.477	0.52	0.649	0.71	-0.03
26775	822.5	36RB_Mid	Rear	21mm	22.12	22.50	0.449	0.49	0.620	0.68	0.15
26775	822.5	36RB_Mid	Left	15mm	22.12	22.50	0.149	0.16	0.206	0.22	0.16
26775	822.5	36RB_Mid	Right	15mm	22.12	22.50	0.214	0.23	0.294	0.32	-0.11
26775	822.5	36RB_Mid	Top	19mm	22.12	22.50	<0.01	<0.01	<0.01	<0.01	/
26775	822.5	1RB_Mid	Front	/	14.81	15.50	0.151	0.18	0.110	0.13	-0.03
26775	822.5	1RB_Mid	Rear	/	14.81	15.50	0.288	0.34	0.155	0.18	-0.17
26775	822.5	1RB_Mid	Left	/	14.81	15.50	0.131	0.15	0.089	0.10	-0.01
26775	822.5	1RB_Mid	Right	/	14.81	15.50	0.145	0.17	0.099	0.12	0.14
26775	822.5	1RB_Mid	Top	/	14.81	15.50	0.021	0.02	0.034	0.04	-0.17
26775	822.5	36RB_Mid	Front	/	13.60	14.50	0.116	0.14	0.086	0.11	-0.03
26775	822.5	36RB_Mid	Rear	/	13.60	14.50	0.238	0.29	0.129	0.16	-0.11
26775	822.5	36RB_Mid	Left	/	13.60	14.50	0.115	0.14	0.079	0.10	-0.11
26775	822.5	36RB_Mid	Right	/	13.60	14.50	0.111	0.14	0.074	0.09	0.02
26775	822.5	36RB_Mid	Top	/	13.60	14.50	0.013	0.02	0.026	0.03	0.02

Note1: The distance between the EUT and the phantom bottom is 15mm/19mm/21mm by sensor (See detail in annex I). The distance between the EUT and the phantom bottom for other configuration is 0mm.

Note2: The LTE mode is QPSK_15MHz.

Table 14.2-6: SAR Values (LTE Band41 - Body)

Ambient Temperature: 22.9 °C						Liquid Temperature: 22.5 °C					
Frequency		Mode	Test Position	Figure No.	Conducted Power (dBm)	Max. tune-up Power (dBm)	Measured SAR(10g) (W/kg)	Reported SAR(10g) (W/kg)	Measured SAR(1g) (W/kg)	Reported SAR(1g) (W/kg)	Power Drift (dB)
Ch.	MHz										
41490	2680	1RB_Mid	Front	15mm	23.42	23.50	0.120	0.12	0.227	0.23	-0.11
41490	2680	1RB_Mid	Rear	21mm	23.42	23.50	0.072	0.07	0.127	0.13	-0.07
41490	2680	1RB_Mid	Left	15mm	23.42	23.50	0.069	0.07	0.120	0.12	0.16
41490	2680	1RB_Mid	Right	15mm	23.42	23.50	0.087	0.09	0.154	0.16	-0.14
41490	2680	1RB_Mid	Top	19mm	23.42	23.50	0.131	0.13	0.238	0.24	0.06
40620	2593	50RB_High	Front	15mm	22.28	22.50	0.109	0.11	0.204	0.21	0.03
40620	2593	50RB_High	Rear	21mm	22.28	22.50	0.069	0.07	0.122	0.13	-0.14
40620	2593	50RB_High	Left	15mm	22.28	22.50	0.039	0.04	0.069	0.07	0.02
40620	2593	50RB_High	Right	15mm	22.28	22.50	0.070	0.07	0.125	0.13	0.06
40620	2593	50RB_High	Top	19mm	22.28	22.50	0.129	0.14	0.229	0.24	0.07
40620	2593	1RB_Mid	Front	/	16.66	17.50	0.185	0.22	0.439	0.53	-0.01
40620	2593	1RB_Mid	Rear	/	16.36	17.50	0.307	0.40	0.733	0.95	-0.19
41490	2680	1RB_Mid	Rear	/	16.20	17.50	0.286	0.39	0.786	1.06	0.06
41055	2636.5	1RB_Mid	Rear	/	16.66	17.50	0.321	0.39	0.797	0.97	-0.01
40620	2593	1RB_Mid	Rear	/	16.38	17.50	0.330	0.43	0.891	1.15	-0.03
40185	2549.5	1RB_Mid	Rear	/	16.62	17.50	0.380	0.47	0.997	1.22	-0.14
39750	2506	1RB_Mid	Left	/	16.66	17.50	0.089	0.11	0.186	0.23	-0.11
40620	2593	1RB_Mid	Right	/	16.66	17.50	0.088	0.11	0.176	0.21	0.15
41490	2680	1RB_Mid	Top	/	16.36	17.50	0.314	0.41	0.745	0.97	0.06
41055	2636.5	1RB_Mid	Top	/	16.20	17.50	0.293	0.40	0.726	0.98	-0.07
40620	2593	1RB_Mid	Top	/	16.66	17.50	0.345	0.42	0.809	0.98	-0.12
40185	2549.5	1RB_Mid	Top	/	16.38	17.50	0.380	0.49	0.923	1.19	0.09
39750	2506	1RB_Mid	Top	Fig.14	16.62	17.50	0.393	0.48	1.030	1.26	0.02
39750	2506	100RB	Top	/	15.28	16.50	0.356	0.47	0.867	1.15	0.18
40620	2593	50RB_Mid	Front	/	15.31	16.50	0.159	0.21	0.388	0.51	-0.02
41490	2680	50RB_Mid	Rear	/	15.31	16.50	0.218	0.29	0.494	0.65	0.17
41490	2680	50RB_Mid	Left	/	15.31	16.50	0.087	0.11	0.176	0.23	0.15
41490	2680	50RB_Mid	Right	/	15.31	16.50	0.055	0.07	0.120	0.16	0.19
41490	2680	100RB	Rear	/	15.28	16.50	0.325	0.43	0.893	1.18	0.15
41490	2680	50RB_Mid	Top	/	15.31	16.50	0.210	0.28	0.548	0.72	0.09

Note1: The distance between the EUT and the phantom bottom is 15mm/19mm/21mm by sensor (See detail in annex I). The distance between the EUT and the phantom bottom for other configuration is 0mm.

Note2: The LTE mode is QPSK_20MHz.

Table 14.2-7: SAR Values (LTE Band66 - Body)

Frequency		Mode	Test Position	Figure No.	Ambient Temperature: 22.9 °C		Liquid Temperature: 22.5 °C		Measured SAR(1g) (W/kg)	Reported SAR(1g) (W/kg)	Power Drift (dB)
Ch.	MHz				Conduct ed Power (dBm)	tune-up Power (dBm)	Measured SAR(10g) (W/kg)	Reported SAR(10g) (W/kg)			
132322	1745	1RB_Mid	Front	15mm	23.24	23.50	0.291	0.31	0.455	0.48	-0.02
132322	1745	1RB_Mid	Rear	21mm	23.24	23.50	0.337	0.36	0.550	0.58	-0.12
132322	1745	1RB_Mid	Left	15mm	23.24	23.50	0.189	0.20	0.294	0.31	0.15
132322	1745	1RB_Mid	Right	15mm	23.24	23.50	0.043	0.05	0.068	0.07	0.19
132572	1770	1RB_Mid	Top	19mm	23.00	23.50	0.412	0.46	0.698	0.78	-0.16
132322	1745	1RB_Mid	Top	19mm/ Fig.15	23.24	23.50	0.496	0.53	0.835	0.89	-0.06
132072	1720	1RB_Mid	Top	19mm	23.01	23.50	0.486	0.54	0.777	0.87	0.10
132322	1745	50RB_Low	Front	15mm	21.76	22.50	0.246	0.29	0.378	0.45	0.19
132322	1745	50RB_Low	Rear	21mm	21.76	22.50	0.294	0.35	0.485	0.58	-0.01
132322	1745	50RB_Low	Left	15mm	21.76	22.50	0.111	0.13	0.174	0.21	-0.03
132322	1745	50RB_Low	Right	15mm	21.76	22.50	0.033	0.04	0.051	0.06	0.19
132572	1770	50RB_Low	Top	19mm	21.59	22.50	0.358	0.44	0.606	0.75	-0.17
132322	1745	50RB_Low	Top	19mm	21.76	22.50	0.415	0.49	0.699	0.83	-0.16
132072	1720	50RB_Low	Top	19mm	21.67	22.50	0.404	0.49	0.676	0.82	0.14
132322	1745	100RB	Top	/	21.75	22.50	0.420	0.50	0.712	0.85	0.09
132572	1770	1RB_Mid	Front	/	13.89	14.50	0.193	0.22	0.362	0.42	-0.13
132572	1770	1RB_Mid	Rear	/	13.89	14.50	0.283	0.33	0.635	0.73	0.05
132572	1770	1RB_Mid	Left	/	13.89	14.50	0.061	0.07	0.113	0.13	0.00
132572	1770	1RB_Mid	Right	/	13.89	14.50	0.046	0.05	0.088	0.10	-0.18
132572	1770	1RB_Mid	Top	/	19.82	21.00	0.067	0.09	0.152	0.20	-0.08
132322	1745	50RB_Mid	Front	/	12.69	13.50	0.160	0.19	0.294	0.35	-0.11
132322	1745	50RB_Mid	Rear	/	12.69	13.50	0.257	0.31	0.533	0.64	0.08
132322	1745	50RB_Mid	Left	/	12.69	13.50	0.051	0.06	0.095	0.11	0.19
132322	1745	50RB_Mid	Right	/	12.69	13.50	0.037	0.04	0.071	0.09	-0.06
132322	1745	50RB_Mid	Top	/	18.74	20.00	0.054	0.07	0.123	0.16	0.09

Note1: The distance between the EUT and the phantom bottom is 15mm/19mm/21mm by sensor (See detail in annex I). The distance between the EUT and the phantom bottom for other configuration is 0mm.

Note2: The LTE mode is QPSK_20MHz.

Table 14.2-8: SAR Values (LTE Band71 - Body)

Ambient Temperature: 22.9 °C Liquid Temperature: 22.5 °C

Frequency		Mode	Test Position	Figure No.	Conduct ed Power (dBm)	Max. tune-up Power (dBm)	Measured SAR(10g) (W/kg)	Reported SAR(10g) (W/kg)	Measured SAR(1g) (W/kg)	Reported SAR(1g) (W/kg)	Power Drift (dB)
Ch.	MHz										
133322	683	1RB_Mid	Front	15mm	22.98	23.50	0.251	0.28	0.349	0.39	-0.04
133322	683	1RB_Mid	Rear	21mm	22.98	23.50	0.209	0.24	0.284	0.32	-0.09
133322	683	1RB_Mid	Left	15mm	22.98	23.50	0.127	0.14	0.173	0.20	0.03
133322	683	1RB_Mid	Right	15mm	22.98	23.50	0.136	0.15	0.185	0.21	-0.05
133322	683	1RB_Mid	Top	19mm	22.98	23.50	<0.01	<0.01	<0.01	<0.01	/
133222	673	50RB_High	Front	15mm	21.76	22.50	0.190	0.23	0.264	0.31	0.10
133222	673	50RB_High	Rear	21mm	21.76	22.50	0.169	0.20	0.228	0.27	-0.09
133222	673	50RB_High	Left	15mm	21.76	22.50	0.105	0.12	0.145	0.17	0.00
133222	673	50RB_High	Right	15mm	21.76	22.50	0.105	0.12	0.145	0.17	-0.05
133222	673	50RB_High	Top	19mm	21.76	22.50	<0.01	<0.01	<0.01	<0.01	/
133222	673	1RB_High	Front	Fig.16	19.82	21.00	0.302	0.40	0.427	0.56	0.00
133222	673	1RB_High	Rear	/	19.82	21.00	0.219	0.29	0.335	0.44	0.08
133222	673	1RB_High	Left	/	19.82	21.00	0.192	0.25	0.288	0.38	0.08
133222	673	1RB_High	Right	/	19.82	21.00	0.226	0.30	0.334	0.44	-0.07
133222	673	1RB_High	Top	/	19.82	21.00	0.067	0.09	0.152	0.20	-0.08
133222	673	50RB_Mid	Front	/	18.74	20.00	0.237	0.32	0.339	0.45	-0.04
133222	673	50RB_Mid	Rear	/	18.74	20.00	0.171	0.23	0.260	0.35	-0.09
133222	673	50RB_Mid	Left	/	18.74	20.00	0.155	0.21	0.238	0.32	0.11
133222	673	50RB_Mid	Right	/	18.74	20.00	0.171	0.23	0.252	0.34	-0.19
133222	673	50RB_Mid	Top	/	18.74	20.00	0.054	0.07	0.123	0.16	0.09

Note1: The distance between the EUT and the phantom bottom is 15mm/19mm/21mm by sensor (See detail in annex I). The distance between the EUT and the phantom bottom for other configuration is 0mm.

Note2: The LTE mode is QPSK_20MHz.

14.3 SAR results for Standard procedure(Non-USB)

There is zoom scan measurement to be added for the highest measured SAR in each exposure configuration/band.

Table 14.3-1: SAR Values (WCDMA 1700 MHz Band - Body)

Ambient Temperature: 22.9 °C						Liquid Temperature: 22.5°C				
Frequency		Test Position	Figure No./Note	Conducted Power (dBm)	Max. tune-up Power (dBm)	Measured SAR(10g) (W/kg)	Reported SAR(10g) (W/kg)	Measured SAR(1g) (W/kg)	Reported SAR(1g) (W/kg)	Power Drift (dB)
Ch.	MHz									
1412	1732.5	Rear	21mm/ Fig.1	23.74	24.50	0.604	0.72	1.000	1.19	0.03

Note1: The distance between the EUT and the phantom bottom is 21mm by sensor (See detail in annex I).

Table 14.3-2: SAR Values (WCDMA 1900 MHz Band - Body)

Ambient Temperature: 22.9 °C						Liquid Temperature: 22.5°C				
Frequency		Test Position	Figure No.	Conducted Power (dBm)	Max. tune-up Power (dBm)	Measured SAR(10g) (W/kg)	Reported SAR(10g) (W/kg)	Measured SAR(1g) (W/kg)	Reported SAR(1g) (W/kg)	Power Drift (dB)
Ch.	MHz									
9262	1852.4	Top	19mm/ Fig.2	23.65	24.50	0.504	0.61	0.868	1.06	0.03

Note1: The distance between the EUT and the phantom bottom is 19mm by sensor (See detail in annex I).

Table 14.3-3: SAR Values (LTE Band12- Body)

Ambient Temperature: 22.9 °C						Liquid Temperature: 22.5°C					
Frequency		Mode	Test Position	Figure No.	Conducted Power (dBm)	Max. tune-up Power (dBm)	Measured SAR(10g) (W/kg)	Reported SAR(10g) (W/kg)	Measured SAR(1g) (W/kg)	Reported SAR(1g) (W/kg)	Power Drift (dB)
Ch.	MHz										
23060	704	1RB_Mid	Rear	21mm/ Fig.3	21.26	22.50	0.361	0.48	0.493	0.66	-0.01

Note1: The distance between the EUT and the phantom bottom is 21mm by sensor (See detail in annex I).

Note2: The LTE mode is QPSK_10MHz.

Table 14.3-4: SAR Values (LTE Band25 - Body)

Ambient Temperature: 22.9 °C					Liquid Temperature: 22.5°C						
Frequency		Mode	Test Position	Figure No.	Conducted Power (dBm)	Max. tune-up Power (dBm)	Measured SAR(10g) (W/kg)	Reported SAR(10g) (W/kg)	Measured SAR(1g) (W/kg)	Reported SAR(1g) (W/kg)	Power Drift (dB)
Ch.	MHz										
26140	1860	1RB_Mid	Top	Fig.4	16.94	18.00	0.291	0.37	0.541	0.69	0.02

Note1: The distance between the EUT and the phantom bottom is 10mm.

Note2: The LTE mode is QPSK_20MHz.

Table 14.3-5: SAR Values (LTE Band26 - Body)

Ambient Temperature: 22.9 °C					Liquid Temperature: 22.5°C						
Frequency		Mode	Test Position	Figure No.	Conducted Power (dBm)	Max. tune-up Power (dBm)	Measured SAR(10g) (W/kg)	Reported SAR(10g) (W/kg)	Measured SAR(1g) (W/kg)	Reported SAR(1g) (W/kg)	Power Drift (dB)
Ch.	MHz										
26965	841.5	1RB_Mid	Front	15mm /Fig.5	23.31	23.50	0.605	0.63	0.828	0.87	-0.01

Note1: The distance between the EUT and the phantom bottom is 15mm by sensor (See detail in annex I).

Note2: The LTE mode is QPSK_15MHz.

Table 14.3-6: SAR Values (LTE Band41 - Body)

Ambient Temperature: 22.9 °C					Liquid Temperature: 22.5°C						
Frequency		Mode	Test Position	Figure No.	Conducted Power (dBm)	Max. tune-up Power (dBm)	Measured SAR(10g) (W/kg)	Reported SAR(10g) (W/kg)	Measured SAR(1g) (W/kg)	Reported SAR(1g) (W/kg)	Power Drift (dB)
Ch.	MHz										
41490	2680	1RB_Mid	Top	19mm /Fig.6	23.42	23.50	0.131	0.13	0.238	0.24	0.06

Note1: The distance between the EUT and the phantom bottom is 19mm by sensor (See detail in annex I).

Note2: The LTE mode is QPSK_20MHz.

Table 14.3-7: SAR Values (LTE Band66 - Body)

Ambient Temperature: 22.9 °C					Liquid Temperature: 22.5°C						
Frequency		Mode	Test Position	Figure No.	Conducted Power (dBm)	tune-up Power (dBm)	Measured SAR(10g) (W/kg)	Reported SAR(10g) (W/kg)	Measured SAR(1g) (W/kg)	Reported SAR(1g) (W/kg)	Power Drift (dB)
Ch.	MHz										
132322	1745	1RB_Mid	Left	Fig.7	16.88	18.00	0.386	0.50	0.706	0.91	0.18

Note1: The distance between the EUT and the phantom bottom is 10mm.

Note2: The LTE mode is QPSK_20MHz.

Table 14.3-8: SAR Values (LTE Band71 - Body)

Ambient Temperature: 22.9 °C Liquid Temperature: 22.5 °C

Frequency		Mode	Test Position	Figure No.	Conduct ed Power (dBm)	Max. tune-up Power (dBm)	Measured SAR(10g) (W/kg)	Reported SAR(10g) (W/kg)	Measured SAR(1g) (W/kg)	Reported SAR(1g) (W/kg)	Power Drift (dB)
Ch.	MHz										
133322	683	1RB_Mid	Front	15mm/ Fig.8	22.98	23.50	0.251	0.28	0.349	0.39	-0.04

Note1: The distance between the EUT and the phantom bottom is 15mm by sensor (See detail in annex I).

Note2: The LTE mode is QPSK_20MHz.

14.4 SAR results for Standard procedure(USB)

Table 14.4-1: SAR Values (WCDMA 1700 MHz Band - Body)

Ambient Temperature: 22.9 °C					Liquid Temperature: 22.5°C					
Frequency		Test Position	Figure No./Note	Conducted Power (dBm)	Max. tune-up Power (dBm)	Measured SAR(10g) (W/kg)	Reported SAR(10g) (W/kg)	Measured SAR(1g) (W/kg)	Reported SAR(1g) (W/kg)	Power Drift (dB)
Ch.	MHz									
1412	1732.5	Rear	21mm/ Fig.9	23.74	24.50	0.604	0.72	1.000	1.19	0.03

Note1: The distance between the EUT and the phantom bottom is 21mm by sensor (See detail in annex I).

Table 14.4-2: SAR Values (WCDMA 1900 MHz Band - Body)

Ambient Temperature: 22.9 °C					Liquid Temperature: 22.5°C					
Frequency		Test Position	Figure No.	Conducted Power (dBm)	Max. tune-up Power (dBm)	Measured SAR(10g) (W/kg)	Reported SAR(10g) (W/kg)	Measured SAR(1g) (W/kg)	Reported SAR(1g) (W/kg)	Power Drift (dB)
Ch.	MHz									
9262	1852.4	Top	19mm/ Fig.10	23.65	24.50	0.504	0.61	0.868	1.06	0.03

Note1: The distance between the EUT and the phantom bottom is 19mm by sensor (See detail in annex I).

Table 14.4-3: SAR Values (LTE Band12- Body)

Ambient Temperature: 22.9 °C					Liquid Temperature: 22.5°C						
Frequency		Mode	Test Position	Figure No.	Conducted Power (dBm)	Max. tune-up Power (dBm)	Measured SAR(10g) (W/kg)	Reported SAR(10g) (W/kg)	Measured SAR(1g) (W/kg)	Reported SAR(1g) (W/kg)	Power Drift (dB)
Ch.	MHz										
23060	704	1RB_Mid	Rear	21mm/ Fig.11	21.26	22.50	0.361	0.48	0.493	0.66	-0.01

Note1: The distance between the EUT and the phantom bottom is 21mm by sensor (See detail in annex I).

Note2: The LTE mode is QPSK_10MHz.

Table 14.4-4: SAR Values (LTE Band25 - Body)

Ambient Temperature: 22.9 °C					Liquid Temperature: 22.5°C						
Frequency		Mode	Test Position	Figure No.	Conducted Power (dBm)	Max. tune-up Power (dBm)	Measured SAR(10g) (W/kg)	Reported SAR(10g) (W/kg)	Measured SAR(1g) (W/kg)	Reported SAR(1g) (W/kg)	Power Drift (dB)
Ch.	MHz										
26590	1905	1RB_Mid	Rear	Fig.12	13.76	14.50	0.250	0.30	0.580	0.69	-0.04

Note1: The distance between the EUT and the phantom bottom is 0mm.

Note2: The LTE mode is QPSK_20MHz.

Table 14.4-5: SAR Values (LTE Band26 - Body)

Ambient Temperature: 22.9 °C					Liquid Temperature: 22.5°C						
Frequency		Mode	Test Position	Figure No.	Conducted Power (dBm)	Max. tune-up Power (dBm)	Measured SAR(10g) (W/kg)	Reported SAR(10g) (W/kg)	Measured SAR(1g) (W/kg)	Reported SAR(1g) (W/kg)	Power Drift (dB)
Ch.	MHz										
26965	841.5	1RB_Mid	Front	15mm/ Fig.13	23.31	23.50	0.605	0.63	0.828	0.87	-0.01

Note1: The distance between the EUT and the phantom bottom is 0mm.

Note2: The LTE mode is QPSK_15MHz.

Table 14.4-6: SAR Values (LTE Band41 - Body)

Ambient Temperature: 22.9 °C					Liquid Temperature: 22.5°C						
Frequency		Mode	Test Position	Figure No.	Conducted Power (dBm)	Max. tune-up Power (dBm)	Measured SAR(10g) (W/kg)	Reported SAR(10g) (W/kg)	Measured SAR(1g) (W/kg)	Reported SAR(1g) (W/kg)	Power Drift (dB)
Ch.	MHz										
39750	2506	1RB_Mid	Top	Fig.14	16.62	17.50	0.393	0.48	1.030	1.26	0.02

Note1: The distance between the EUT and the phantom bottom is 0mm.

Note2: The LTE mode is QPSK_20MHz.

Table 14.4-7: SAR Values (LTE Band66 - Body)

Ambient Temperature: 22.9 °C					Liquid Temperature: 22.5°C						
Frequency		Mode	Test Position	Figure No.	Conducted Power (dBm)	tune-up Power (dBm)	Measured SAR(10g) (W/kg)	Reported SAR(10g) (W/kg)	Measured SAR(1g) (W/kg)	Reported SAR(1g) (W/kg)	Power Drift (dB)
Ch.	MHz										
132322	1745	1RB_Mid	Top	Fig.15	23.24	23.50	0.496	0.53	0.835	0.89	-0.06

Note1: The distance between the EUT and the phantom bottom is 19mm by sensor (See detail in annex I).

Note2: The LTE mode is QPSK_20MHz.

Table 14.4-8: SAR Values (LTE Band71 - Body)

Ambient Temperature: 22.9 °C Liquid Temperature: 22.5 °C

Frequency		Mode	Test Position	Figure No.	Conducted Power (dBm)	Max. tune-up Power (dBm)	Measured SAR(10g) (W/kg)	Reported SAR(10g) (W/kg)	Measured SAR(1g) (W/kg)	Reported SAR(1g) (W/kg)	Power Drift (dB)
Ch.	MHz										
133222	673	1RB_High	Front	Fig.16	19.82	21.00	0.302	0.40	0.427	0.56	0.00

Note1: The distance between the EUT and the phantom bottom is 0mm.

Note2: The LTE mode is QPSK_20MHz.

14.5 WLAN Evaluation for 2.4G

According to the KDB248227 D01, SAR is measured for 2.4GHz 802.11b DSSS using the initial test position procedure.

Body Evaluation

Table 14.5-1: SAR Values (WLAN - Body)– 802.11b (Fast SAR) Non-USB

Frequency		Test Position	Figure No.	Ambient Temperature: 22.9 °C		Liquid Temperature: 22.5 °C		Measured SAR(1g) (W/kg)	Reported SAR(1g)(W/kg)	Power Drift (dB)
MHz	Ch.			Conducted Power (dBm)	Max. tune-up Power (dBm)	Measured SAR(10g) (W/kg)	Reported SAR(10g) (W/kg)			
2412	1	Front	Note4	21.53	22.00	0.110	0.12	0.191	0.21	-0.07
2412	1	Rear	Note4	21.53	22.00	0.146	0.16	0.260	0.29	-0.06
2412	1	Left	Note4	21.53	22.00	0.146	0.16	0.248	0.28	-0.17
2412	1	Bottom	Note4	21.53	22.00	0.029	0.03	0.047	0.05	0.00
2412	1	Front	Note3	17.52	18.00	0.070	0.08	0.128	0.14	0.08
2412	1	Rear	Note3	17.52	18.00	0.095	0.11	0.176	0.20	-0.02
2412	1	Left	Note3	17.52	18.00	0.081	0.09	0.147	0.16	-0.09
2412	1	Bottom	Note3	17.52	18.00	0.000	0.00	0.000	0.00	-0.03

As shown above table, the initial test position for body is “Rear 15mm”. So the body SAR of WLAN is presented as below:

Table 14.5-2: SAR Values (WLAN - Body)– 802.11b (Full SAR) Non-USB

Frequency		Test Position	Figure No.	Ambient Temperature: 22.9 °C		Liquid Temperature: 22.5 °C		Measured SAR(1g) (W/kg)	Reported SAR(1g)(W/kg)	Power Drift (dB)
MHz	Ch.			Conducted Power (dBm)	Max. tune-up Power (dBm)	Measured SAR(10g) (W/kg)	Reported SAR(10g) (W/kg)			
2412	1	Rear	15mm/ Fig.17	21.53	22.00	0.146	0.16	0.260	0.29	-0.06

Note1: When the reported SAR of the initial test position is > 0.4 W/kg, SAR is repeated for the 802.11 transmission mode configuration tested in the initial test position using subsequent highest estimated 1-g SAR conditions determined by area scans, on the highest maximum output power channel, until the reported SAR is \leq 0.8 W/kg.

Note2: For all positions/configurations tested using the initial test position and subsequent test positions, when the reported SAR is > 0.8 W/kg, SAR is measured for these test positions/configurations on the subsequent next highest measured output power channel until the reported SAR is \leq 1.2 W/kg or all required channels are tested.

Note3: The distance between the EUT and the phantom bottom is 10mm

Note4: The distance between the EUT and the phantom bottom is 15mm by sensor (See detail in annex I).

According to the KDB248227 D01, The reported SAR must be scaled to 100% transmission duty factor to determine compliance at the maximum tune-up tolerance limit. The scaled reported SAR is presented as below.

Table 14.5-4: SAR Values (WLAN - Body)– 802.11b (Fast SAR) USB

Frequency		Test Position	Figure No.	Ambient Temperature: 22.9 °C		Liquid Temperature: 22.5 °C				Power Drift (dB)
MHz	Ch.			Conducted Power (dBm)	Max. tune-up Power (dBm)	Measured SAR(10g) (W/kg)	Reported SAR(10g) (W/kg)	Measured SAR(1g) (W/kg)	Reported SAR(1g)(W/kg)	
2412	1	Front	Note4	21.53	22.00	0.110	0.12	0.191	0.21	-0.07
2412	1	Rear	Note4	21.53	22.00	0.146	0.16	0.260	0.29	-0.06
2412	1	Left	Note4	21.53	22.00	0.146	0.16	0.248	0.28	-0.17
2412	1	Front	Note3	12.23	12.50	0.068	0.07	0.159	0.17	-0.02
2412	1	Rear	Note3	12.23	12.50	0.097	0.10	0.236	0.25	-0.02
2412	1	Left	Note3	12.23	12.50	0.081	0.09	0.185	0.20	-0.19
2412	1	Right	Note3	21.53	22.00	0.173	0.19	0.343	0.38	-0.03

As shown above table, the initial test position for body is “Rear”. So the body SAR of WLAN is presented as below:

Table 14.5-5: SAR Values (WLAN - Body)– 802.11b (Full SAR) Non-USB

Frequency		Test Position	Figure No.	Ambient Temperature: 22.9 °C		Liquid Temperature: 22.5 °C				Power Drift (dB)
MHz	Ch.			Conducted Power (dBm)	Max. tune-up Power (dBm)	Measured SAR(10g) (W/kg)	Reported SAR(10g) (W/kg)	Measured SAR(1g) (W/kg)	Reported SAR(1g)(W/kg)	
2412	1	Right	Note4 Fig.18	21.53	22.00	0.175	0.20	0.346	0.39	-0.03

Note1: When the reported SAR of the initial test position is > 0.4 W/kg, SAR is repeated for the 802.11 transmission mode configuration tested in the initial test position using subsequent highest estimated 1-g SAR conditions determined by area scans, on the highest maximum output power channel, until the reported SAR is \leq 0.8 W/kg.

Note2: For all positions/configurations tested using the initial test position and subsequent test positions, when the reported SAR is > 0.8 W/kg, SAR is measured for these test positions/configurations on the subsequent next highest measured output power channel until the reported SAR is \leq 1.2 W/kg or all required channels are tested.

Note3: The distance between the EUT and the phantom bottom is 0mm

Note4: The distance between the EUT and the phantom bottom is 15mm by sensor (See detail in annex I).

According to the KDB248227 D01, The reported SAR must be scaled to 100% transmission duty factor to determine compliance at the maximum tune-up tolerance limit. The scaled reported SAR is presented as below.

Table 14.5-6: SAR Values (WLAN - Body) – 802.11b (Scaled Reported SAR)

Frequency		Test Position	Actual duty factor	maximum duty factor	Reported SAR (1g)(W/kg)	Scaled reported SAR (1g)(W/kg)
MHz	Ch.					
2412	1	Rear 0mm	100%	98.7%	0.39	0.40

SAR is not required for OFDM because the 802.11b adjusted SAR \leq 1.2 W/kg.

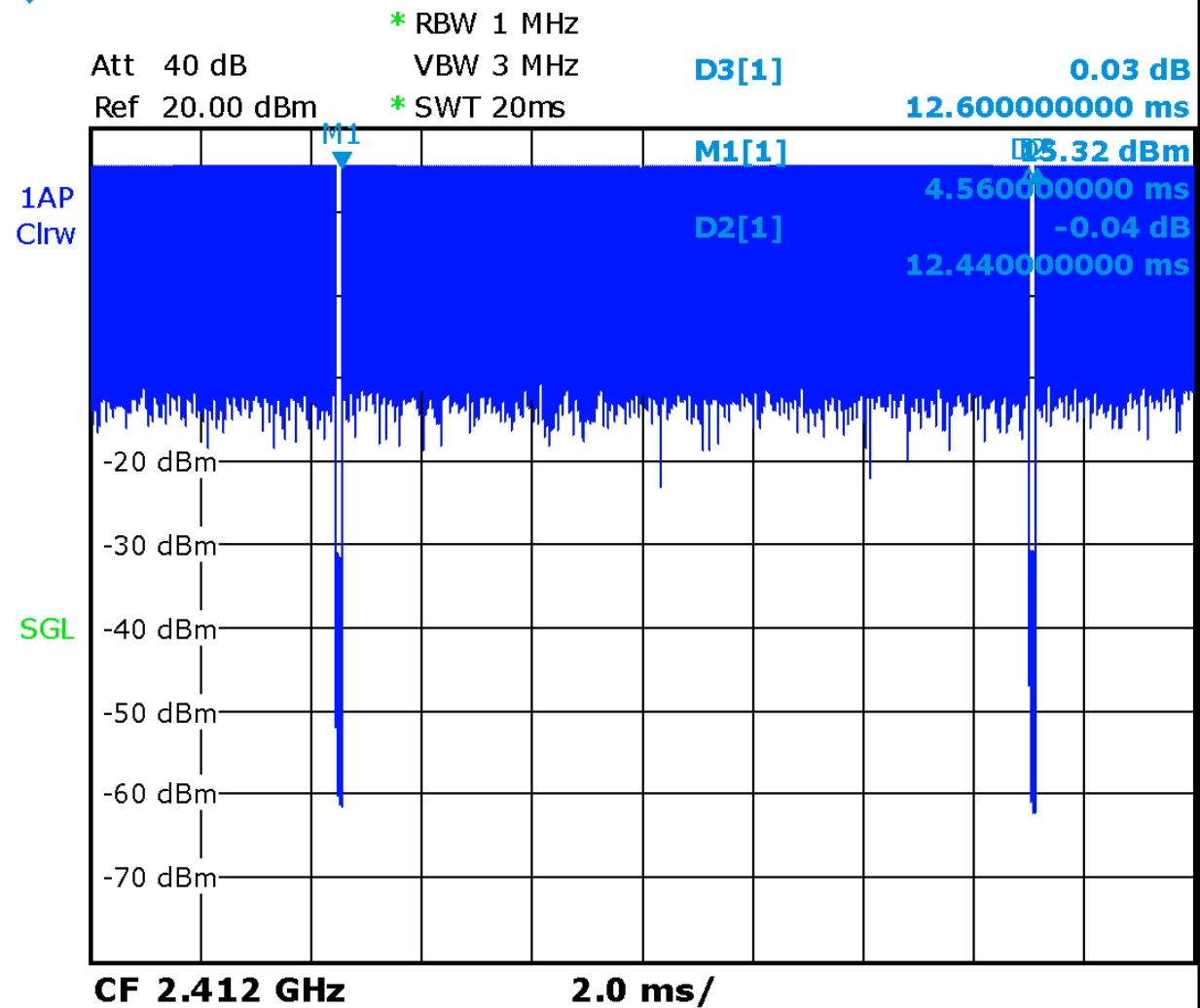
Picture 14.2 Duty factor plot

14.4 WLAN Evaluation For 5G

Table 14.4-1: OFDM mode specified maximum output power of WLAN antenna

802.11 mode	a	g	n		ac			
Ch. BW(MHz)	20	20	20	40	20	40	80	160
U-NII-1	X		X	X	X	X	X	
U-NII-2A								
U-NII-2C								
U-NII-3	X		X	X	X	X	X	
§ 15.247 (5.8/ GHz)								

X: maximum(conducted) output power(mW), including tolerance, specified for production units

Table 14.4-2: Maximum output power specified of WLAN antenna-Normal Power

802.11 mode	a	g	n		ac			
Ch. BW(MHz)	20	20	20	40	20	40	80	160
U-NII-1	126		100	79	100	100	100	
U-NII-2A								
U-NII-2C								
U-NII-3	126		100	79	100	100	100	
§ 15.247 (5.8 GHz)								

- The maximum output power specified for production units is the same for all channels, modulations and data rates in each channel bandwidth configuration of the 802.11a/g/n/ac modes.
- The **blue highlighted** cells represent highest output configurations in each standalone or aggregated frequency band, with tune-up tolerance included.

Table 14.4-3: Maximum output power specified of WLAN antenna- Low Power Non-USB

802.11 mode	a	g	n		ac			
Ch. BW(MHz)	20	20	20	40	20	40	80	160
U-NII-1	18		18	18	18	18	18	
U-NII-2A								
U-NII-2C								
U-NII-3	18		18	18	18	18	18	
§ 15.247 (5.8 GHz)								

- The maximum output power specified for production units is the same for all channels, modulations and data rates in each channel bandwidth configuration of the 802.11a/g/n/ac modes.
- The **blue highlighted** cells represent highest output configurations in each standalone or aggregated frequency band, with tune-up tolerance included.

Table 14.4-4: Maximum output power specified of WLAN antenna- Low Power USB

802.11 mode	a	g	n		ac			
Ch. BW(MHz)	20	20	20	40	20	40	80	160
U-NII-1	4		4	4	4	4	4	
U-NII-2A								
U-NII-2C								
U-NII-3	4		4	4	4	4	4	
§ 15.247 (5.8 GHz)								

- The maximum output power specified for production units is the same for all channels, modulations and data rates in each channel bandwidth configuration of the 802.11a/g/n/ac modes.
- The **blue highlighted** cells represent highest output configurations in each standalone or aggregated frequency band, with tune-up tolerance included.

Table 14.4-5: Maximum output power measured of WLAN antenna, for the applicable OFDM configurations according to the default power measurement procedures for selection initial test configurations - Normal Power

802.11 mode	a	n		ac		
BW(MHz)	20	20	40	20	40	80
U-NII-1	36/40/44/48 92/93/102/89	36/40/44/48 Lower power	38/46 Lower power	36/40/44/48 Lower power	38/46 Lower power	42 Lower power
U-NII-3	149/153/157/1 61 89/92/96/97	149/153/157/1 61/165 Lower power	151/159 28/27 Lower power	149/153/15 7/161/165 Lower power	151/159 Lower power	155 Lower power

- The **bold numbers** is the maximum output measured power (mW).
- Channels with measured maximum power within 0.25dB are considered to have the same measured output.
- Channels selected for initial test configuration are **highlighted in yellow**.

Table 14.4-6: Maximum output power measured of WLAN antenna, for the applicable OFDM configurations according to the default power measurement procedures for selection initial test configurations - Low Power Non-USB

802.11 mode	a	n			ac		
BW(MHz)	20	20	40	20	40	80	
U-NII-1	36/40/44/48 Lower power	36/40/44/48 Lower power	38/46 Lower power	36/40/44/48 Lower power	38/46 Lower power	42 14	
U-NII-3	149/153/157/1 61/165 Lower power	149/153/157/1 61/165 Lower power	151/159 Lower power	149/153/157/1 61/165 Lower power	151/159 Lower power	155 14	

- The **bold numbers** is the maximum output measured power (mW).
- Channels with measured maximum power within 0.25dB are considered to have the same measured output.
- Channels selected for initial test configuration are highlighted in yellow.

Table 14.4-7: Maximum output power measured of WLAN antenna, for the applicable OFDM configurations according to the default power measurement procedures for selection initial test configurations - Low Power USB

802.11 mode	a	n			ac		
BW(MHz)	20	20	40	20	40	80	
U-NII-1	36/40/44/48 Lower power	36/40/44/48 Lower power	38/46 Lower power	36/40/44/48 Lower power	38/46 Lower power	42 3	
U-NII-3	149/153/157/1 61/165 Lower power	149/153/157/1 61/165 Lower power	151/159 Lower power	149/153/157 /161/165 Lower power	151/159 Lower power	155 3	

- The **bold numbers** is the maximum output measured power (mW).
- Channels with measured maximum power within 0.25dB are considered to have the same measured output.
- Channels selected for initial test configuration are highlighted in yellow.

Table 14.4-8: Reported SAR of initial test configuration for Non-USB

802.11 mode	a	n		ac		
BW(MHz)	20	20	40	20	40	80
U-NII-1	36/40/44/48 1.21	36/40/44/48	38/46	36/40/44/48	38/46	42
U-NII-3	149/153/157/161 /165 0.64	149/153/157/161/ 165	151/159	149/153/157/161 /165	151/159	155

Highest measured output power channel tested initially are in yellow highlight.

Table 14.4-9: Reported SAR of initial test configuration for USB

802.11 mode	a	n		ac		
BW(MHz)	20	20	40	20	40	80
U-NII-1	36/40/44/48 1.21	36/40/44/48	38/46	36/40/44/48	38/46	42
U-NII-3	149/153/157/161/ 165 0.64	149/153/157/161 /165	151/159	149/153/157/1 61/165	151/159	155

Highest measured output power channel tested initially are in yellow highlight.

Table 14.4-10: SAR Values (WLAN 5G - Non-USB)

Frequency		Test Position	Figure No.	Conducted Power (dBm)	Max. tune-up Power (dBm)	Measured SAR(10g) (W/kg)	Reported SAR(10g) (W/kg)	Measured SAR(1g) (W/kg)	Reported SAR(1g) (W/kg)	Power Drift (dB)
Ch.	MHz									
44	5220	Front	15mm	20.08	21.00	0.207	0.26	0.460	0.57	0.17
44	5220	Rear	15mm	20.08	21.00	0.157	0.19	0.385	0.48	-0.07
44	5220	Left	15mm/ Fig.19	20.08	21.00	0.409	0.51	0.977	1.21	-0.01
44	5220	Bottom	15mm	20.08	21.00	0.012	0.01	0.044	0.05	-0.12
44	5220	Rear	21mm	20.08	21.00	0.133	0.16	0.315	0.39	0.07
161	5805	Front	15mm	19.89	21.00	0.153	0.20	0.385	0.50	-0.18
161	5805	Rear	15mm	19.89	21.00	0.114	0.15	0.310	0.40	0.00
161	5805	Left	15mm	19.89	21.00	0.204	0.26	0.494	0.64	-0.13
161	5805	Bottom	15mm	19.89	21.00	0.026	0.03	0.064	0.08	0.02
42	5210	Front	/	11.45	12.50	0.035	0.04	0.088	0.11	0.07
42	5210	Rear	/	11.45	12.50	0.029	0.04	0.076	0.10	-0.19
42	5210	Left	/	11.45	12.50	0.086	0.11	0.234	0.30	-0.09
42	5210	Bottom	/	11.45	12.50	0.008	0.01	0.030	0.04	0.02
155	5775	Front	/	11.35	12.50	0.014	0.02	0.040	0.05	-0.14
155	5775	Rear	/	11.35	12.50	0.012	0.02	0.040	0.05	-0.01
155	5775	Left	/	11.35	12.50	0.025	0.03	0.068	0.09	0.07
155	5775	Bottom	/	11.35	12.50	0.008	0.01	0.047	0.06	-0.13

Note1: The distance between the EUT and the phantom bottom is 15mm/21mm by sensor (See detail in annex I). The distance between the EUT and the phantom bottom for other configuration is 10mm.

According to the KDB248227 D01, The reported SAR must be scaled to 100% transmission duty factor to determine compliance at the maximum tune-up tolerance limit. The scaled reported SAR is presented as below.

Table 14.4-11 SAR Values (WLAN 5G - Non-USB) (Scaled Reported SAR)

Frequency		Test Position	D (mm)	Actual duty factor	maximum duty factor	Reported SAR (1g) (W/kg)	Scaled reported SAR (1g) (W/kg)
Ch.	MHz						
44	5220	Left	10	98%	100%	1.21	1.23

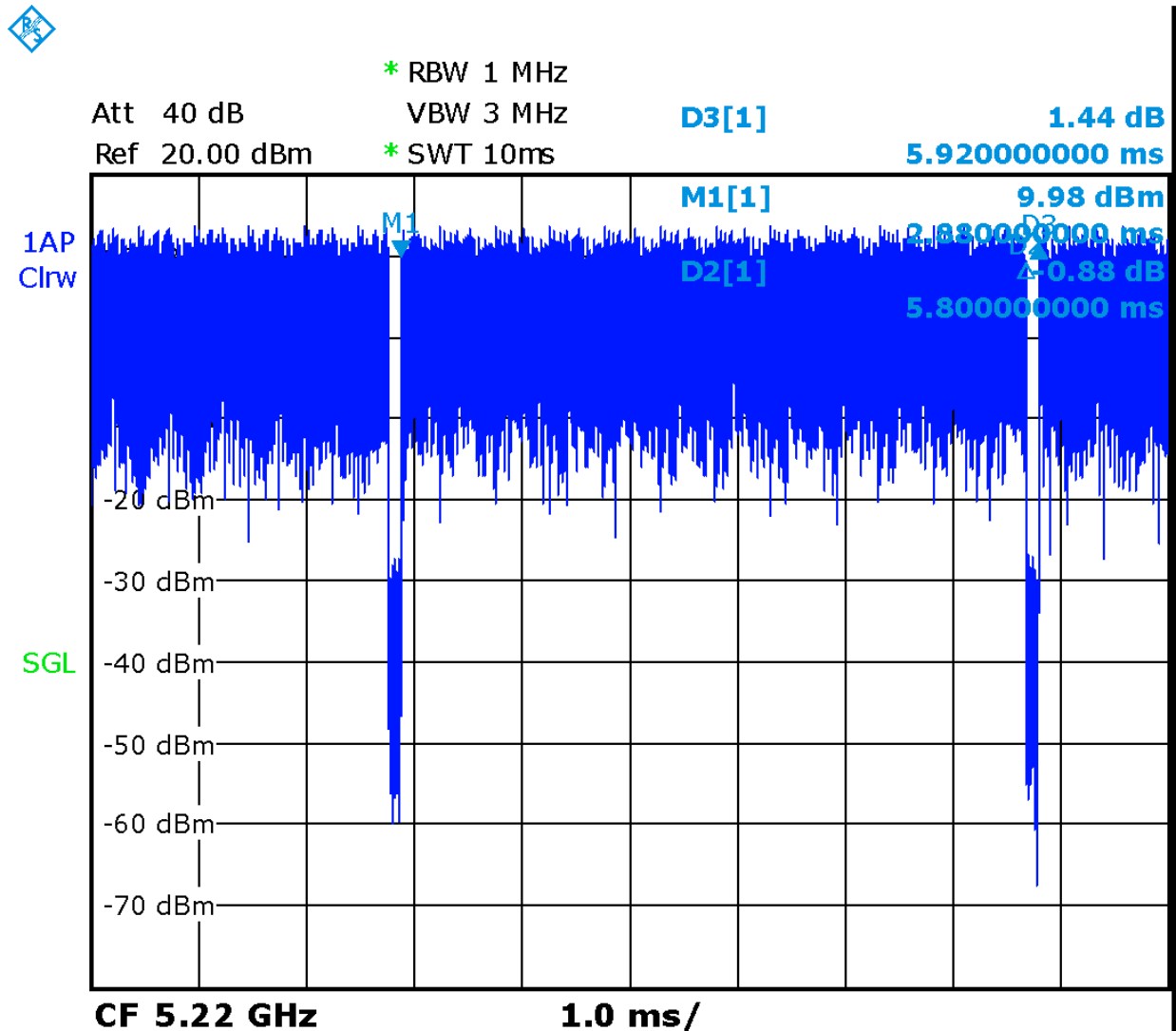

Picture 14.3 The plot of duty factor for Body

Table 14.4-12: SAR Values (WLAN 5G - USB)

Frequency		Test Position	Figure No.	Conducted Power (dBm)	Max. tune-up Power (dBm)	Measured SAR(10g) (W/kg)	Reported SAR(10g) (W/kg)	Measured SAR(1g) (W/kg)	Reported SAR(1g) (W/kg)	Power Drift (dB)
Ch.	MHz									
44	5220	Front	15mm	20.08	21.00	0.207	0.26	0.460	0.57	0.17
44	5220	Rear	15mm	20.08	21.00	0.157	0.19	0.385	0.48	-0.07
44	5220	Left	15mm/ Fig.19	20.08	21.00	0.409	0.51	0.977	1.21	-0.01
44	5220	Rear	21mm	20.08	21.00	0.133	0.16	0.315	0.39	0.07
161	5805	Front	15mm	19.89	21.00	0.153	0.20	0.385	0.50	-0.18
161	5805	Rear	15mm	19.89	21.00	0.114	0.15	0.310	0.40	0.00
161	5805	Left	15mm	19.89	21.00	0.204	0.26	0.494	0.64	-0.13
42	5210	Front	/	4.41	6.00	0.013	0.02	0.047	0.07	0.17
42	5210	Rear	/	4.41	6.00	0.016	0.02	0.063	0.09	-0.08
42	5210	Left	/	4.41	6.00	0.044	0.06	0.207	0.30	-0.07
44	5220	Right	/	20.08	21.00	0.024	0.03	0.061	0.08	0.06
155	5775	Front	/	4.71	6.00	0.007	0.01	0.049	0.07	-0.06
155	5775	Rear	/	4.71	6.00	0.009	0.01	0.067	0.09	0.18
155	5775	Left	/	4.71	6.00	0.019	0.03	0.100	0.13	0.00
155	5775	Right	/	19.89	21.00	0.013	0.02	0.057	0.07	0.12

Note1: The distance between the EUT and the phantom bottom is 15mm/21mm by sensor (See detail in annex I). The distance between the EUT and the phantom bottom for other configuration is 0mm.

According to the KDB248227 D01, The reported SAR must be scaled to 100% transmission duty factor to determine compliance at the maximum tune-up tolerance limit. The scaled reported SAR is presented as below.

Table 14.4-13 SAR Values (WLAN 5G - USB) (Scaled Reported SAR)

Frequency		Test Position	D (mm)	Actual duty factor	maximum duty factor	Reported SAR (1g) (W/kg)	Scaled reported SAR (1g) (W/kg)
Ch.	MHz						
44	5220	Left	10	98%	100%	1.21	1.23

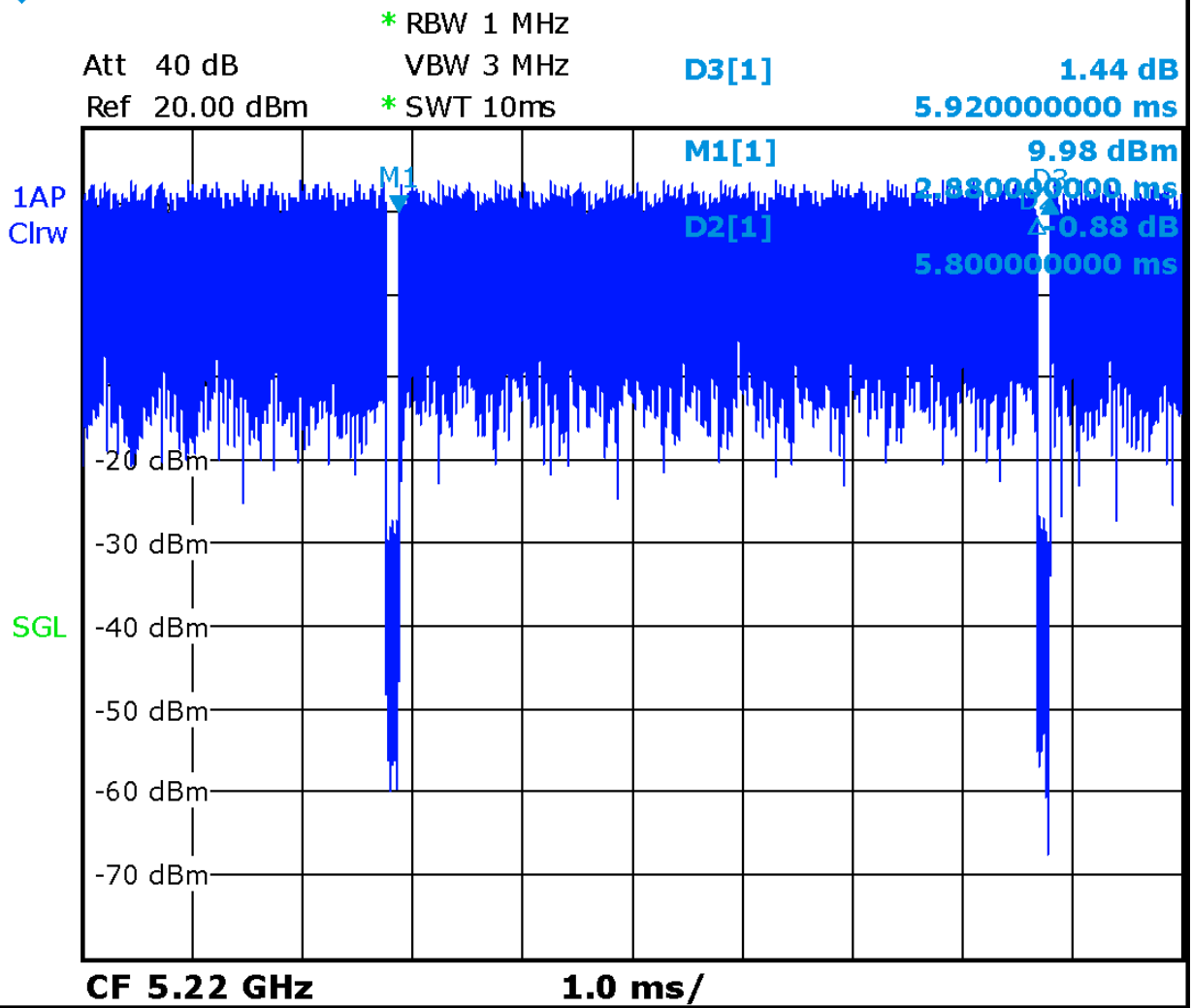

Picture 14.3 The plot of duty factor for Body

15 SAR Measurement Variability

SAR measurement variability must be assessed for each frequency band, which is determined by the SAR probe calibration point and tissue-equivalent medium used for the device measurements. When both head and body tissue-equivalent media are required for SAR measurements in a frequency band, the variability measurement procedures should be applied to the tissue medium with the highest measured SAR, using the highest measured SAR configuration for that tissue-equivalent medium.

The following procedures are applied to determine if repeated measurements are required.

- 1) Repeated measurement is not required when the original highest measured SAR is < 0.80 W/kg; steps 2) through 4) do not apply.
- 2) When the original highest measured SAR is ≥ 0.80 W/kg, repeat that measurement once.
- 3) Perform a second repeated measurement only if the ratio of largest to smallest SAR for the original and first repeated measurements is > 1.20 or when the original or repeated measurement is ≥ 1.45 W/kg ($\sim 10\%$ from the 1-g SAR limit).
- 4) Perform a third repeated measurement only if the original, first or second repeated measurement is ≥ 1.5 W/kg and the ratio of largest to smallest SAR for the original, first and second repeated measurements is > 1.20

Table 15.1: SAR Measurement Variability for Body WCDMA1700 (1g)

Frequency		Mode	Test Position	Spacing (mm)	Original SAR (W/kg)	First Repeated SAR (W/kg)	The Ratio	Second Repeated SAR (W/kg)
Ch.	MHz							
1412	1732.5	RMC	Rear	21	1	0.989	1.01	/

Table 15.2: SAR Measurement Variability for Body WCDMA1900 (1g)

Frequency		Mode	Test Position	Spacing (mm)	Original SAR (W/kg)	First Repeated SAR (W/kg)	The Ratio	Second Repeated SAR (W/kg)
Ch.	MHz							
9262	1852.4	RMC	Top	19	0.868	0.859	1.01	/

Table 15.3: SAR Measurement Variability for Body LTE Band26 (1g)

Frequency		Mode	Test Position	Spacing (mm)	Original SAR (W/kg)	First Repeated SAR (W/kg)	The Ratio	Second Repeated SAR (W/kg)
Ch.	MHz							
26965	841.5	1RB-Middle	Front	15	0.828	0.781	1.06	/

Table 15.4: SAR Measurement Variability for Body LTE Band41 (1g)

Frequency		Mode	Test Position	Spacing (mm)	Original SAR (W/kg)	First Repeated SAR (W/kg)	The Ratio	Second Repeated SAR (W/kg)
Ch.	MHz							
39750	2506	1RB-Middle	Rear	0	0.997	0.981	1.02	/

Table 15.5: SAR Measurement Variability for Body LTE Band66 (1g)

Frequency		Mode	Test Position	Spacing (mm)	Original SAR (W/kg)	First Repeated SAR (W/kg)	The Ratio	Second Repeated SAR (W/kg)
Ch.	MHz							
132322	1745	1RB-Middle	Top	19	0.835	0.821	1.02	/

Table 15.6: SAR Measurement Variability for Body WiFi5G (1g)

Frequency		Mode	Test Position	Spacing (mm)	Original SAR (W/kg)	First Repeated SAR (W/kg)	The Ratio	Second Repeated SAR (W/kg)
Ch.	MHz							
44	5220	11a 6M	Left	15	0.977	0.956	1.02	/

16 Measurement Uncertainty

16.1 Measurement Uncertainty for Normal SAR Tests (300MHz~3GHz)

No.	Error Description	Type	Uncertainty value	Probably Distribution	Div.	(Ci) 1g	(Ci) 10g	Std. Unc. (1g)	Std. Unc. (10g)	Degree of freedom
Measurement system										
1	Probe calibration	B	6.0	N	1	1	1	6.0	6.0	∞
2	Isotropy	B	4.7	R	$\sqrt{3}$	0.7	0.7	1.9	1.9	∞
3	Boundary effect	B	1.0	R	$\sqrt{3}$	1	1	0.6	0.6	∞
4	Linearity	B	4.7	R	$\sqrt{3}$	1	1	2.7	2.7	∞
5	Detection limit	B	1.0	N	1	1	1	0.6	0.6	∞
6	Readout electronics	B	0.3	R	$\sqrt{3}$	1	1	0.3	0.3	∞
7	Response time	B	0.8	R	$\sqrt{3}$	1	1	0.5	0.5	∞
8	Integration time	B	2.6	R	$\sqrt{3}$	1	1	1.5	1.5	∞
9	RF ambient conditions-noise	B	0	R	$\sqrt{3}$	1	1	0	0	∞
10	RF ambient conditions-reflection	B	0	R	$\sqrt{3}$	1	1	0	0	∞
11	Probe positioned mech. restrictions	B	0.4	R	$\sqrt{3}$	1	1	0.2	0.2	∞
12	Probe positioning with respect to phantom shell	B	2.9	R	$\sqrt{3}$	1	1	1.7	1.7	∞
13	Post-processing	B	1.0	R	$\sqrt{3}$	1	1	0.6	0.6	∞
Test sample related										
14	Test sample positioning	A	3.3	N	1	1	1	3.3	3.3	71
15	Device holder uncertainty	A	3.4	N	1	1	1	3.4	3.4	5
16	Drift of output power	B	5.0	R	$\sqrt{3}$	1	1	2.9	2.9	∞
Phantom and set-up										
17	Phantom uncertainty	B	4.0	R	$\sqrt{3}$	1	1	2.3	2.3	∞
18	Liquid conductivity (target)	B	5.0	R	$\sqrt{3}$	0.64	0.43	1.8	1.2	∞
19	Liquid conductivity (meas.)	A	2.06	N	1	0.64	0.43	1.32	0.89	43
20	Liquid permittivity (target)	B	5.0	R	$\sqrt{3}$	0.6	0.49	1.7	1.4	∞
21	Liquid permittivity (meas.)	A	1.6	N	1	0.6	0.49	1.0	0.8	521

Combined standard uncertainty	$u_c' = \sqrt{\sum_{i=1}^{21} c_i^2 u_i^2}$							9.55	9.43	257
Expanded uncertainty (confidence interval of 95 %)	$u_e = 2u_c$							19.1	18.9	

16.2 Measurement Uncertainty for Normal SAR Tests (3~6GHz)

No.	Error Description	Type	Uncertainty value	Probably Distribution	Div.	(Ci) 1g	(Ci) 10g	Std. Unc. (1g)	Std. Unc. (10g)	Degree of freedom
Measurement system										
1	Probe calibration	B	6.55	N	1	1	1	6.55	6.55	∞
2	Isotropy	B	4.7	R	$\sqrt{3}$	0.7	0.7	1.9	1.9	∞
3	Boundary effect	B	2.0	R	$\sqrt{3}$	1	1	1.2	1.2	∞
4	Linearity	B	4.7	R	$\sqrt{3}$	1	1	2.7	2.7	∞
5	Detection limit	B	1.0	R	$\sqrt{3}$	1	1	0.6	0.6	∞
6	Readout electronics	B	0.3	R	$\sqrt{3}$	1	1	0.3	0.3	∞
7	Response time	B	0.8	R	$\sqrt{3}$	1	1	0.5	0.5	∞
8	Integration time	B	2.6	R	$\sqrt{3}$	1	1	1.5	1.5	∞
9	RF ambient conditions-noise	B	0	R	$\sqrt{3}$	1	1	0	0	∞
10	RFambient conditions-reflection	B	0	R	$\sqrt{3}$	1	1	0	0	∞
11	Probe positioned mech. restrictions	B	0.8	R	$\sqrt{3}$	1	1	0.5	0.5	∞
12	Probe positioning with respect to phantom shell	B	6.7	R	$\sqrt{3}$	1	1	3.9	3.9	∞
13	Post-processing	B	4.0	R	$\sqrt{3}$	1	1	2.3	2.3	∞
Test sample related										
14	Test sample positioning	A	3.3	N	1	1	1	3.3	3.3	71
15	Device holder uncertainty	A	3.4	N	1	1	1	3.4	3.4	5
16	Drift of output power	B	5.0	R	$\sqrt{3}$	1	1	2.9	2.9	∞
Phantom and set-up										
17	Phantom uncertainty	B	4.0	R	$\sqrt{3}$	1	1	2.3	2.3	∞
18	Liquid conductivity (target)	B	5.0	R	$\sqrt{3}$	0.64	0.43	1.8	1.2	∞
19	Liquid conductivity (meas.)	A	2.06	N	1	0.64	0.43	1.32	0.89	43
20	Liquid permittivity (target)	B	5.0	R	$\sqrt{3}$	0.6	0.49	1.7	1.4	∞

21	Liquid permittivity (meas.)	A	1.6	N	1	0.6	0.49	1.0	0.8	521
Combined standard uncertainty		$u_c = \sqrt{\sum_{i=1}^{21} c_i^2 u_i^2}$						10.7	10.6	257
Expanded uncertainty (confidence interval of 95 %)		$u_e = 2u_c$						21.4	21.1	

16.3 Measurement Uncertainty for Fast SAR Tests (300MHz~3GHz)

No.	Error Description	Type	Uncertainty value	Probably Distribution	Div.	(Ci) 1g	(Ci) 10g	Std. Unc. (1g)	Std. Unc. (10g)	Degree of freedom
Measurement system										
1	Probe calibration	B	6.0	N	1	1	1	6.0	6.0	∞
2	Isotropy	B	4.7	R	$\sqrt{3}$	0.7	0.7	1.9	1.9	∞
3	Boundary effect	B	1.0	R	$\sqrt{3}$	1	1	0.6	0.6	∞
4	Linearity	B	4.7	R	$\sqrt{3}$	1	1	2.7	2.7	∞
5	Detection limit	B	1.0	R	$\sqrt{3}$	1	1	0.6	0.6	∞
6	Readout electronics	B	0.3	R	$\sqrt{3}$	1	1	0.3	0.3	∞
7	Response time	B	0.8	R	$\sqrt{3}$	1	1	0.5	0.5	∞
8	Integration time	B	2.6	R	$\sqrt{3}$	1	1	1.5	1.5	∞
9	RF ambient conditions-noise	B	0	R	$\sqrt{3}$	1	1	0	0	∞
10	RF ambient conditions-reflection	B	0	R	$\sqrt{3}$	1	1	0	0	∞
11	Probe positioned mech. Restrictions	B	0.4	R	$\sqrt{3}$	1	1	0.2	0.2	∞
12	Probe positioning with respect to phantom shell	B	2.9	R	$\sqrt{3}$	1	1	1.7	1.7	∞
13	Post-processing	B	1.0	R	$\sqrt{3}$	1	1	0.6	0.6	∞
14	Fast SAR z-Approximation	B	7.0	R	$\sqrt{3}$	1	1	4.0	4.0	∞
Test sample related										
15	Test sample positioning	A	3.3	N	1	1	1	3.3	3.3	71
16	Device holder uncertainty	A	3.4	N	1	1	1	3.4	3.4	5
17	Drift of output power	B	5.0	R	$\sqrt{3}$	1	1	2.9	2.9	∞
Phantom and set-up										
18	Phantom uncertainty	B	4.0	R	$\sqrt{3}$	1	1	2.3	2.3	∞
19	Liquid conductivity (target)	B	5.0	R	$\sqrt{3}$	0.64	0.43	1.8	1.2	∞

20	Liquid conductivity (meas.)	A	2.06	N	1	0.64	0.43	1.32	0.89	43
21	Liquid permittivity (target)	B	5.0	R	$\sqrt{3}$	0.6	0.49	1.7	1.4	∞
22	Liquid permittivity (meas.)	A	1.6	N	1	0.6	0.49	1.0	0.8	521
Combined standard uncertainty		$u_c = \sqrt{\sum_{i=1}^{22} c_i^2 u_i^2}$						10.4	10.3	257
Expanded uncertainty (confidence interval of 95 %)		$u_e = 2u_c$						20.8	20.6	

16.4 Measurement Uncertainty for Fast SAR Tests (3~6GHz)

No.	Error Description	Type	Uncertainty value	Probably Distribution	Div.	(Ci) 1g	(Ci) 10g	Std. Unc. (1g)	Std. Unc. (10g)	Degree of freedom
Measurement system										
1	Probe calibration	B	6.55	N	1	1	1	6.55	6.55	∞
2	Isotropy	B	4.7	R	$\sqrt{3}$	0.7	0.7	1.9	1.9	∞
3	Boundary effect	B	2.0	R	$\sqrt{3}$	1	1	1.2	1.2	∞
4	Linearity	B	4.7	R	$\sqrt{3}$	1	1	2.7	2.7	∞
5	Detection limit	B	1.0	R	$\sqrt{3}$	1	1	0.6	0.6	∞
6	Readout electronics	B	0.3	R	$\sqrt{3}$	1	1	0.3	0.3	∞
7	Response time	B	0.8	R	$\sqrt{3}$	1	1	0.5	0.5	∞
8	Integration time	B	2.6	R	$\sqrt{3}$	1	1	1.5	1.5	∞
9	RF ambient conditions-noise	B	0	R	$\sqrt{3}$	1	1	0	0	∞
10	RFambient conditions-reflection	B	0	R	$\sqrt{3}$	1	1	0	0	∞
11	Probe positioned mech. Restrictions	B	0.8	R	$\sqrt{3}$	1	1	0.5	0.5	∞
12	Probe positioning with respect to phantom shell	B	6.7	R	$\sqrt{3}$	1	1	3.9	3.9	∞
13	Post-processing	B	1.0	R	$\sqrt{3}$	1	1	0.6	0.6	∞
14	Fast SAR z-Approximation	B	14.0	R	$\sqrt{3}$	1	1	8.1	8.1	∞
Test sample related										
15	Test sample positioning	A	3.3	N	1	1	1	3.3	3.3	71
16	Device holder uncertainty	A	3.4	N	1	1	1	3.4	3.4	5
17	Drift of output power	B	5.0	R	$\sqrt{3}$	1	1	2.9	2.9	∞

Phantom and set-up										
18	Phantom uncertainty	B	4.0	R	$\sqrt{3}$	1	1	2.3	2.3	∞
19	Liquid conductivity (target)	B	5.0	R	$\sqrt{3}$	0.64	0.43	1.8	1.2	∞
20	Liquid conductivity (meas.)	A	2.06	N	1	0.64	0.43	1.32	0.89	43
21	Liquid permittivity (target)	B	5.0	R	$\sqrt{3}$	0.6	0.49	1.7	1.4	∞
22	Liquid permittivity (meas.)	A	1.6	N	1	0.6	0.49	1.0	0.8	521
Combined standard uncertainty		$u_c = \sqrt{\sum_{i=1}^{22} c_i^2 u_i^2}$						13.5	13.4	257
Expanded uncertainty (confidence interval of 95 %)		$u_e = 2u_c$						27.0	26.8	

17 MAIN TEST INSTRUMENTS

Table 16.1: List of Main Instruments

No.	Name	Type	Serial Number	Calibration Date	Valid Period
01	Network analyzer	N5239A	MY46110673	January 24, 2020	One year
02	Power meter	NRP2	101919	May 12, 2020	One year
03	Power sensor	NRP-Z91	101547		
04	Signal Generator	E4438C	MY49070393	January 4, 2020	One Year
05	Amplifier	60S1G4	0331848	No Calibration Requested	
06	BTS	CMW500	129942	February 10, 2020	One year
07	E-field Probe	SPEAG EX3DV4	3617	Jan 30, 2020	One year
08	DAE	SPEAG DAE4	777	January 8, 2020	One year
09	Dipole Validation Kit	SPEAG D750V3	1017	July 24,2020	One year
10	Dipole Validation Kit	SPEAG D835V2	4d069	July 24,,2020	One year
11	Dipole Validation Kit	SPEAG D1750V2	1003	July 24, 2020	One year
12	Dipole Validation Kit	SPEAG D1900V2	5d101	July 28,2020	One year
13	Dipole Validation Kit	SPEAG D2450V2	853	July 21,2020	One year
14	Dipole Validation Kit	SPEAG D2600V2	1012	July 21,2020	One year
15	Dipole Validation Kit	SPEAG D5GHzV2	1060	July 27,2020	One year

END OF REPORT BODY

ANNEX A Graph Results

WCDMA1700-BIV_CH1412 Rear 21mm

Date: 10/24/2020

Electronics: DAE4 Sn777

Medium: head 1750 MHz

Medium parameters used: $f = 1732.5$ MHz; $\sigma = 1.337$ mho/m; $\epsilon_r = 40.22$; $\rho = 1000$ kg/m³

Ambient Temperature: 22.5°C, Liquid Temperature: 22.3°C

Communication System: WCDMA1700-BIV 1732.5 MHz Duty Cycle: 1:1

Probe: EX3DV4 – SN3617 ConvF(8.41,8.41,8.41)

Area Scan (71x121x1): Interpolated grid: dx=1.000 mm, dy=1.000 mm

Maximum value of SAR (interpolated) = 1.44 W/kg

Zoom Scan (7x7x7)/Cube 0: Measurement grid: dx=5mm, dy=5mm, dz=5mm

Reference Value = 9.524 V/m; Power Drift = 0.03 dB

Peak SAR (extrapolated) = 1.68 W/kg

SAR(1 g) = 1 W/kg; SAR(10 g) = 0.604 W/kg

Maximum value of SAR (measured) = 1.42 W/kg

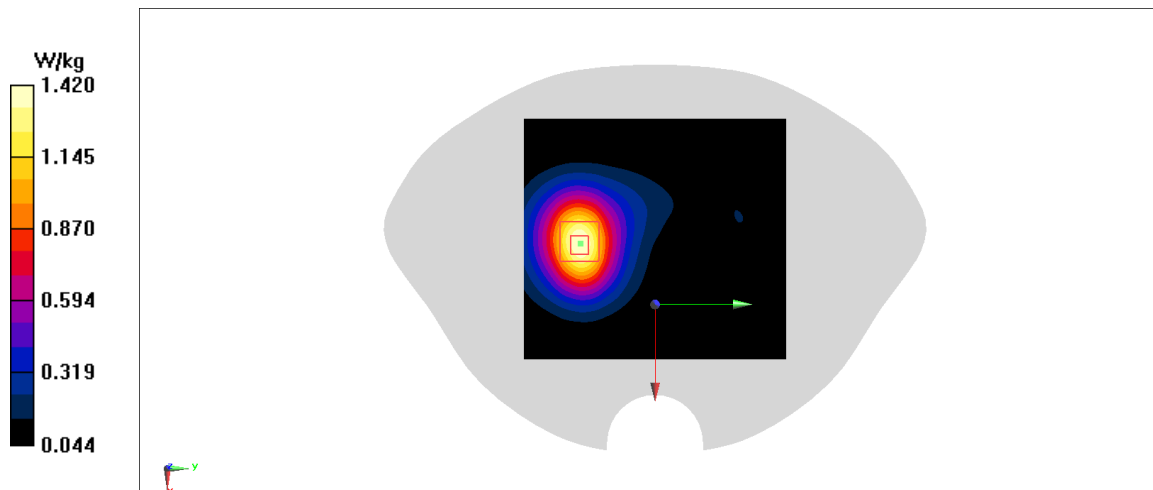

Fig A.1

WCDMA1900-BII_CH9262 Top 19mm

Date: 10/25/2020

Electronics: DAE4 Sn777

Medium: head 1900 MHz

Medium parameters used: $f = 1852.4$ MHz; $\sigma = 1.365$ mho/m; $\epsilon_r = 39.44$; $\rho = 1000$ kg/m³

Ambient Temperature: 22.5°C, Liquid Temperature: 22.3°C

Communication System: WCDMA1900-BII 1852.4 MHz Duty Cycle: 1:1

Probe: EX3DV4 – SN3617 ConvF(8.14,8.14,8.14)

Area Scan (71x121x1): Interpolated grid: dx=1.000 mm, dy=1.000 mm

Maximum value of SAR (interpolated) = 1.27 W/kg

Zoom Scan (7x7x7)/Cube 0: Measurement grid: dx=5mm, dy=5mm, dz=5mm

Reference Value = 26.68 V/m; Power Drift = 0.03 dB

Peak SAR (extrapolated) = 1.47 W/kg

SAR(1 g) = 0.868 W/kg; SAR(10 g) = 0.504 W/kg

Maximum value of SAR (measured) = 1.25 W/kg

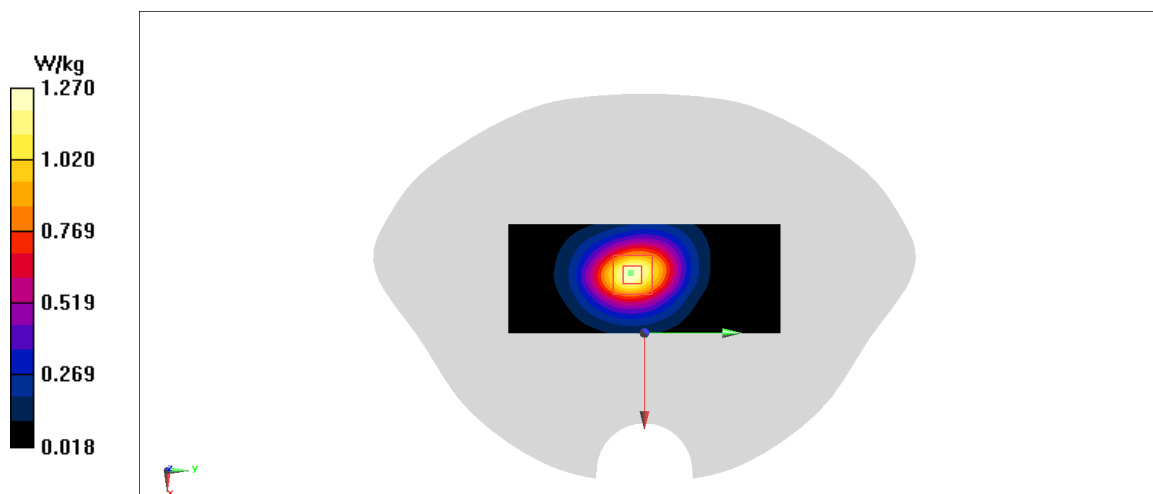
**Fig A.2**

LTE700-FDD12_CH23130 Rear 10mm

Date: 10/22/2020

Electronics: DAE4 Sn777

Medium: head 750 MHz

Medium parameters used: $f = 711$ MHz; $\sigma = 0.853$ mho/m; $\epsilon_r = 42.55$; $\rho = 1000$ kg/m³

Ambient Temperature: 22.5°C, Liquid Temperature: 22.3°C

Communication System: LTE700-FDD12 711 MHz Duty Cycle: 1:1

Probe: EX3DV4 – SN3617 ConvF(10.07,10.07,10.07)

Area Scan (71x121x1): Interpolated grid: dx=1.000 mm, dy=1.000 mm

Maximum value of SAR (interpolated) = 0.613 W/kg

Zoom Scan (7x7x7)/Cube 0: Measurement grid: dx=5mm, dy=5mm, dz=5mm

Reference Value = 26.35 V/m; Power Drift = -0.01 dB

Peak SAR (extrapolated) = 0.676 W/kg

SAR(1 g) = 0.493 W/kg; SAR(10 g) = 0.361 W/kg

Maximum value of SAR (measured) = 0.613 W/kg

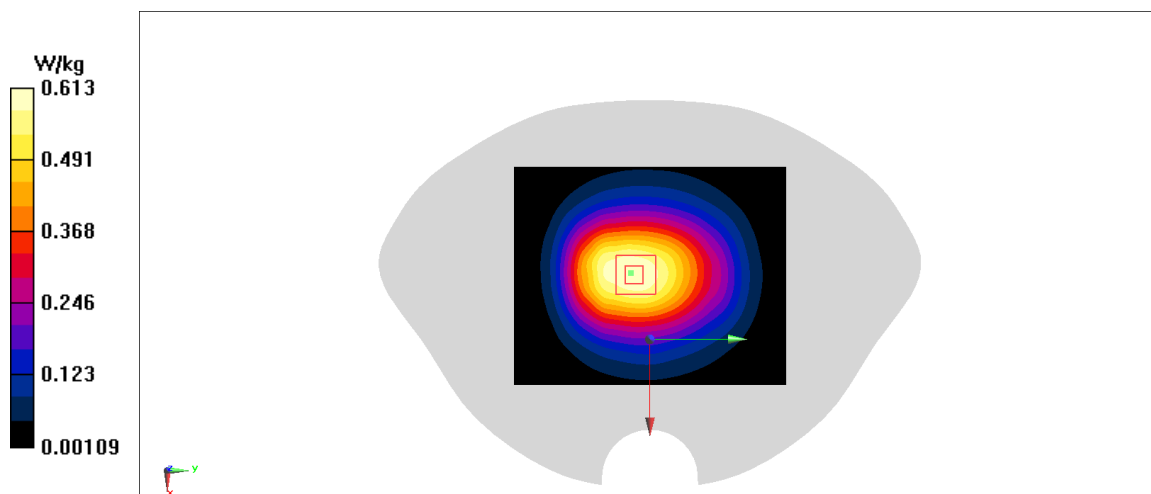
**Fig A.3**

LTE1900-FDD25_CH26140 Top 10mm

Date: 10/25/2020

Electronics: DAE4 Sn777

Medium: head 1900 MHz

Medium parameters used: $f = 1860$ MHz; $\sigma = 1.373$ mho/m; $\epsilon_r = 39.43$; $\rho = 1000$ kg/m³

Ambient Temperature: 22.5°C, Liquid Temperature: 22.3°C

Communication System: LTE1900-FDD25 1860 MHz Duty Cycle: 1:1

Probe: EX3DV4 – SN3617 ConvF(8.14,8.14,8.14)

Area Scan (71x121x1): Interpolated grid: dx=1.000 mm, dy=1.000 mm

Maximum value of SAR (interpolated) = 0.896 W/kg

Zoom Scan (7x7x7)/Cube 0: Measurement grid: dx=5mm, dy=5mm, dz=5mm

Reference Value = 17.27 V/m; Power Drift = 0.02 dB

Peak SAR (extrapolated) = 0.964 W/kg

SAR(1 g) = 0.541 W/kg; SAR(10 g) = 0.291 W/kg

Maximum value of SAR (measured) = 0.81 W/kg

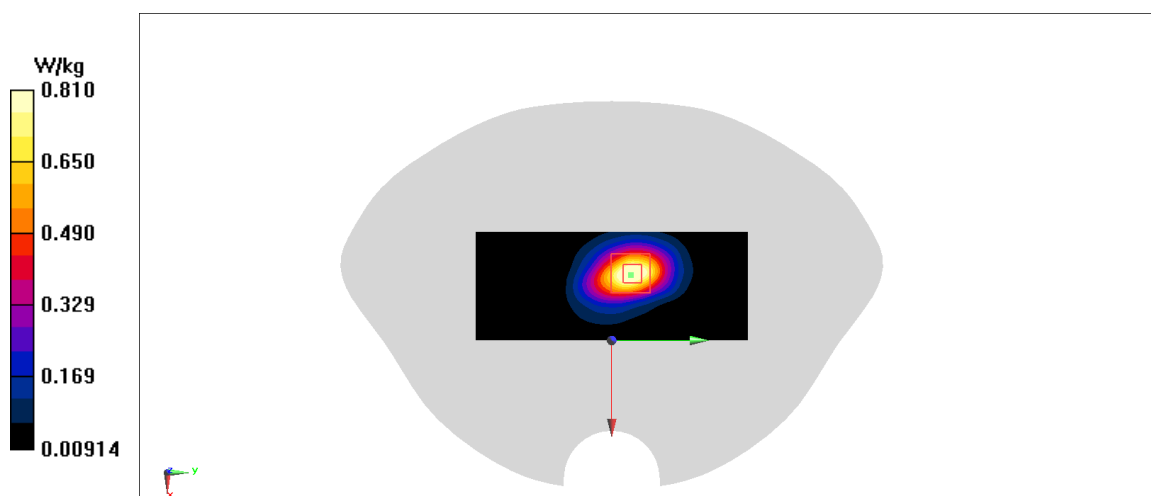
**Fig A.4**

LTE850-FDD26_CH26965 Front 15mm

Date: 10/23/2020

Electronics: DAE4 Sn777

Medium: head 835 MHz

Medium parameters used: $f = 841.5$ MHz; $\sigma = 0.895$ mho/m; $\epsilon_r = 40.68$; $\rho = 1000$ kg/m³

Ambient Temperature: 22.5°C, Liquid Temperature: 22.3°C

Communication System: LTE850-FDD26 841.5 MHz Duty Cycle: 1:1

Probe: EX3DV4 – SN3617 ConvF(9.66,9.66,9.66)

Area Scan (71x121x1): Interpolated grid: dx=1.000 mm, dy=1.000 mm

Maximum value of SAR (interpolated) = 1.02 W/kg

Zoom Scan (7x7x7)/Cube 0: Measurement grid: dx=5mm, dy=5mm, dz=5mm

Reference Value = 34.23 V/m; Power Drift = -0.01 dB

Peak SAR (extrapolated) = 1.15 W/kg

SAR(1 g) = 0.828 W/kg; SAR(10 g) = 0.605 W/kg

Maximum value of SAR (measured) = 1.04 W/kg

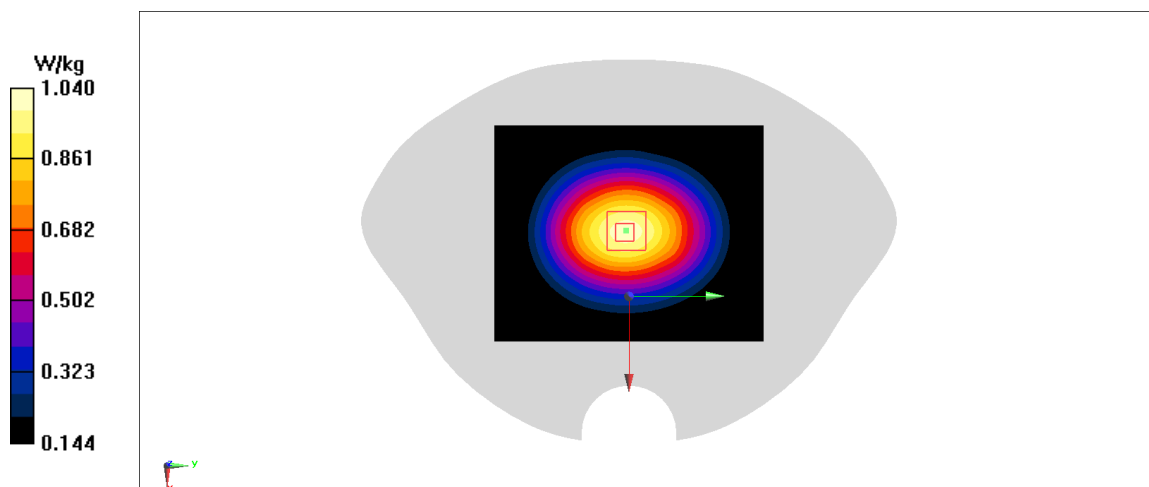
**Fig A.5**

LTE2500-FDD41_CH41490 Top 19mm

Date: 10/23/2020

Electronics: DAE4 Sn777

Medium: head 2600 MHz

Medium parameters used: $f = 2680$ MHz; $\sigma = 1.983$ mho/m; $\epsilon_r = 39.502$; $\rho = 1000$ kg/m³

Ambient Temperature: 22.5°C, Liquid Temperature: 22.3°C

Communication System: LTE2500-FDD41 2680 MHz Duty Cycle: 1:1.58

Probe: EX3DV4 – SN3617 ConvF(7.52,7.52,7.52)

Area Scan (71x121x1): Interpolated grid: dx=1.000 mm, dy=1.000 mm

Maximum value of SAR (interpolated) = 0.376 W/kg

Zoom Scan (7x7x7)/Cube 0: Measurement grid: dx=5mm, dy=5mm, dz=5mm

Reference Value = 12.19 V/m; Power Drift = 0.06 dB

Peak SAR (extrapolated) = 0.452 W/kg

SAR(1 g) = 0.238 W/kg; SAR(10 g) = 0.131 W/kg

Maximum value of SAR (measured) = 0.364 W/kg

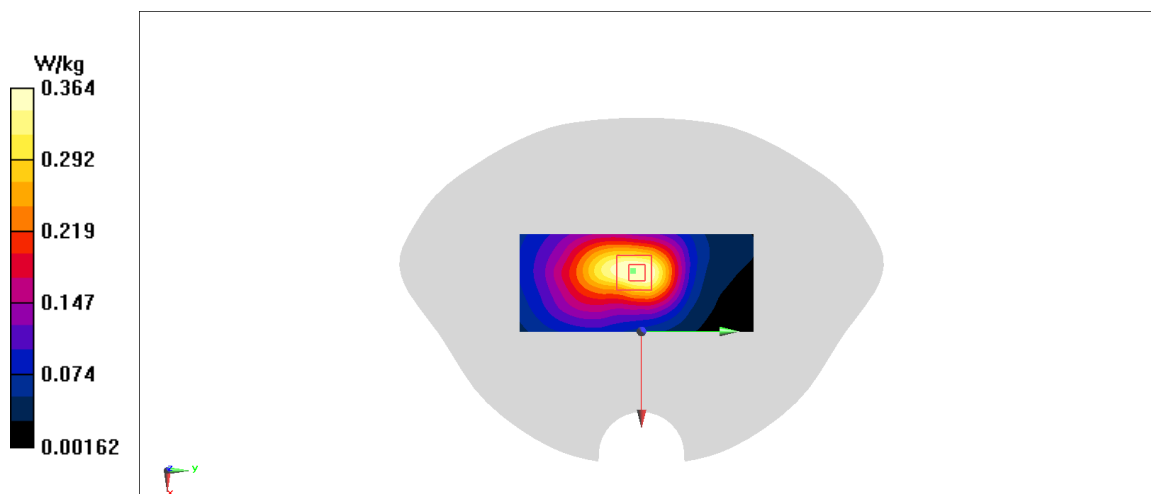
**Fig A.6**

LTE1700-FDD66_CH132322 Rear 10mm

Date: 10/24/2020

Electronics: DAE4 Sn777

Medium: head 1750 MHz

Medium parameters used: $f = 1745\text{MHz}$; $\sigma = 1.374\text{ mho/m}$; $\epsilon_r = 41.243$; $\rho = 1000\text{ kg/m}^3$

Ambient Temperature: 22.5°C, Liquid Temperature: 22.3°C

Communication System: LTE1700-FDD66 1745 MHz Duty Cycle: 1:1

Probe: EX3DV4 – SN3617 ConvF(8.41,8.41,8.41)

Area Scan (71x121x1): Interpolated grid: $dx=1.000\text{ mm}$, $dy=1.000\text{ mm}$

Maximum value of SAR (interpolated) = 1.03 W/kg

Zoom Scan (7x7x7)/Cube 0: Measurement grid: $dx=5\text{mm}$, $dy=5\text{mm}$, $dz=5\text{mm}$

Reference Value = 5.602 V/m; Power Drift = 0.18 dB

Peak SAR (extrapolated) = 1.29 W/kg

SAR(1 g) = 0.706 W/kg; SAR(10 g) = 0.386 W/kg

Maximum value of SAR (measured) = 1.08 W/kg

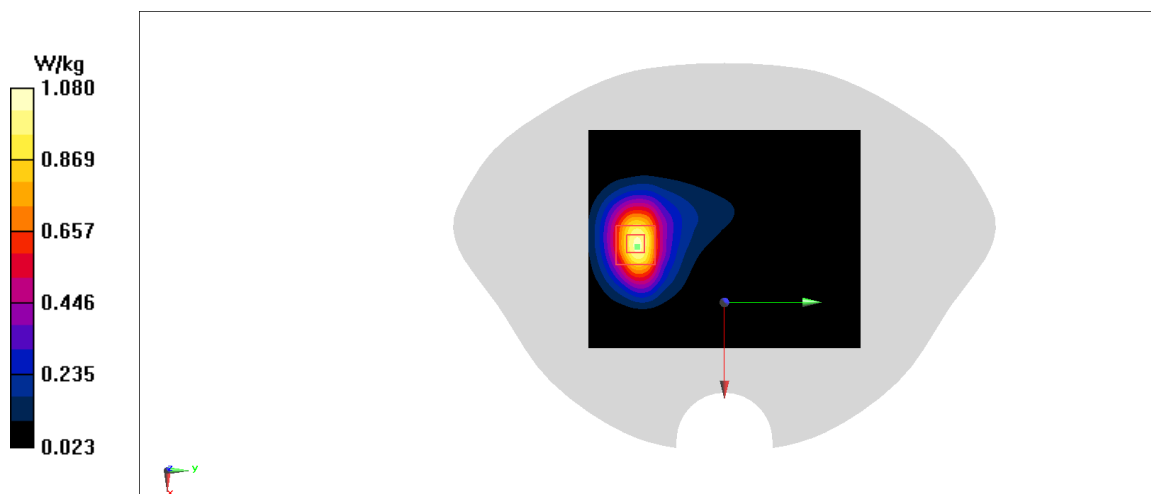
**Fig A.7**

LTE700-FDD71_CH133322 Front 15mm

Date: 10/22/2020

Electronics: DAE4 Sn777

Medium: head 750 MHz

Medium parameters used: $f = 683$ MHz; $\sigma = 0.82$ mho/m; $\epsilon_r = 43.96$; $\rho = 1000$ kg/m³

Ambient Temperature: 22.5°C, Liquid Temperature: 22.3°C

Communication System: LTE700-FDD71 683MHz Duty Cycle: 1:1

Probe: EX3DV4 – SN3617 ConvF(10.07,10.07,10.07)

Area Scan (71x121x1): Interpolated grid: dx=1.000 mm, dy=1.000 mm

Maximum value of SAR (interpolated) = 0.442 W/kg

Zoom Scan (7x7x7)/Cube 0: Measurement grid: dx=5mm, dy=5mm, dz=5mm

Reference Value = 20.84 V/m; Power Drift = -0.04 dB

Peak SAR (extrapolated) = 0.502 W/kg

SAR(1 g) = 0.349 W/kg; SAR(10 g) = 0.251 W/kg

Maximum value of SAR (measured) = 0.449 W/kg

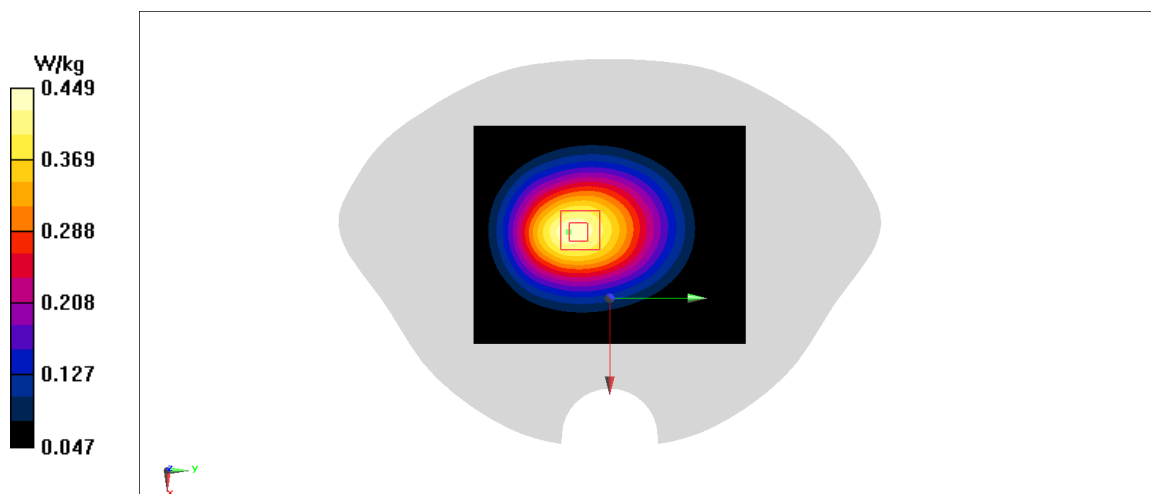
**Fig A.8**

WCDMA1700-BIV_CH1412 Rear 21mm

Date: 10/24/2020

Electronics: DAE4 Sn777

Medium: head 1750 MHz

Medium parameters used: $f = 1732.5$ MHz; $\sigma = 1.337$ mho/m; $\epsilon_r = 40.22$; $\rho = 1000$ kg/m³

Ambient Temperature: 22.5°C, Liquid Temperature: 22.3°C

Communication System: WCDMA1700-BIV 1732.5 MHz Duty Cycle: 1:1

Probe: EX3DV4 – SN3617 ConvF(8.41,8.41,8.41)

Area Scan (71x121x1): Interpolated grid: dx=1.000 mm, dy=1.000 mm

Maximum value of SAR (interpolated) = 1.44 W/kg

Zoom Scan (7x7x7)/Cube 0: Measurement grid: dx=5mm, dy=5mm, dz=5mm

Reference Value = 9.524 V/m; Power Drift = 0.03 dB

Peak SAR (extrapolated) = 1.68 W/kg

SAR(1 g) = 1 W/kg; SAR(10 g) = 0.604 W/kg

Maximum value of SAR (measured) = 1.42 W/kg

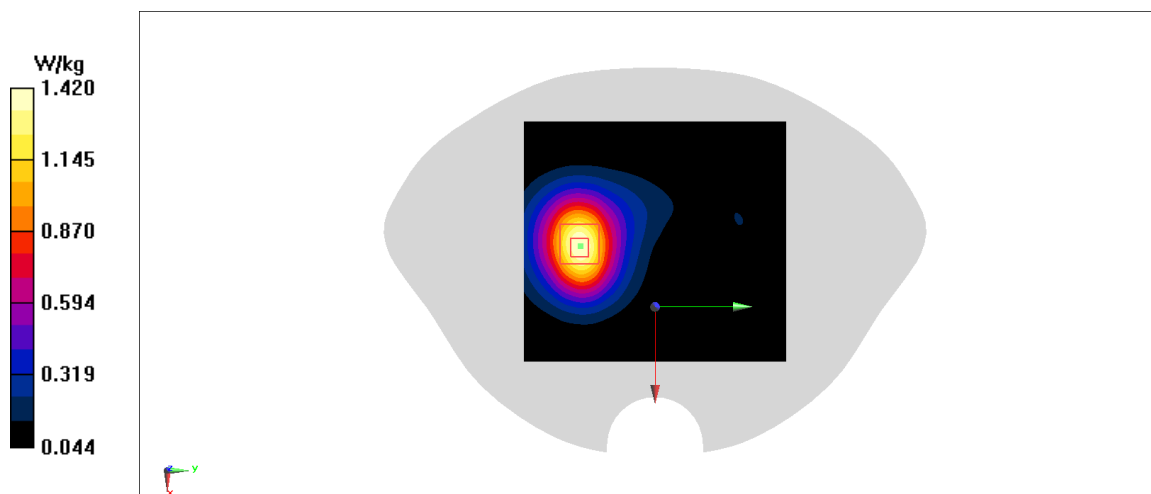

Fig A.9

WCDMA1900-BII_CH9262 Top 19mm

Date: 10/25/2020

Electronics: DAE4 Sn777

Medium: head 1900 MHz

Medium parameters used: $f = 1852.4$ MHz; $\sigma = 1.365$ mho/m; $\epsilon_r = 39.44$; $\rho = 1000$ kg/m³

Ambient Temperature: 22.5°C, Liquid Temperature: 22.3°C

Communication System: WCDMA1900-BII 1852.4 MHz Duty Cycle: 1:1

Probe: EX3DV4 – SN3617 ConvF(8.14,8.14,8.14)

Area Scan (71x121x1): Interpolated grid: dx=1.000 mm, dy=1.000 mm

Maximum value of SAR (interpolated) = 1.27 W/kg

Zoom Scan (7x7x7)/Cube 0: Measurement grid: dx=5mm, dy=5mm, dz=5mm

Reference Value = 26.68 V/m; Power Drift = 0.03 dB

Peak SAR (extrapolated) = 1.47 W/kg

SAR(1 g) = 0.868 W/kg; SAR(10 g) = 0.504 W/kg

Maximum value of SAR (measured) = 1.25 W/kg

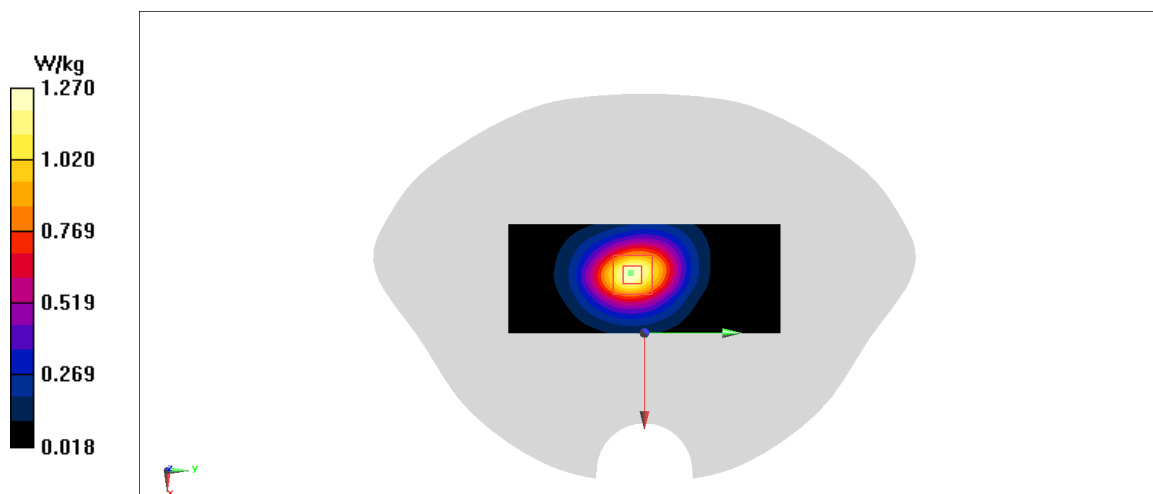
**Fig A.10**

LTE700-FDD12_CH23130 Rear 10mm

Date: 10/22/2020

Electronics: DAE4 Sn777

Medium: head 750 MHz

Medium parameters used: $f = 711$ MHz; $\sigma = 0.853$ mho/m; $\epsilon_r = 42.55$; $\rho = 1000$ kg/m³

Ambient Temperature: 22.5°C, Liquid Temperature: 22.3°C

Communication System: LTE700-FDD12 711 MHz Duty Cycle: 1:1

Probe: EX3DV4 – SN3617 ConvF(10.07,10.07,10.07)

Area Scan (71x121x1): Interpolated grid: dx=1.000 mm, dy=1.000 mm

Maximum value of SAR (interpolated) = 0.613 W/kg

Zoom Scan (7x7x7)/Cube 0: Measurement grid: dx=5mm, dy=5mm, dz=5mm

Reference Value = 26.35 V/m; Power Drift = -0.01 dB

Peak SAR (extrapolated) = 0.676 W/kg

SAR(1 g) = 0.493 W/kg; SAR(10 g) = 0.361 W/kg

Maximum value of SAR (measured) = 0.613 W/kg

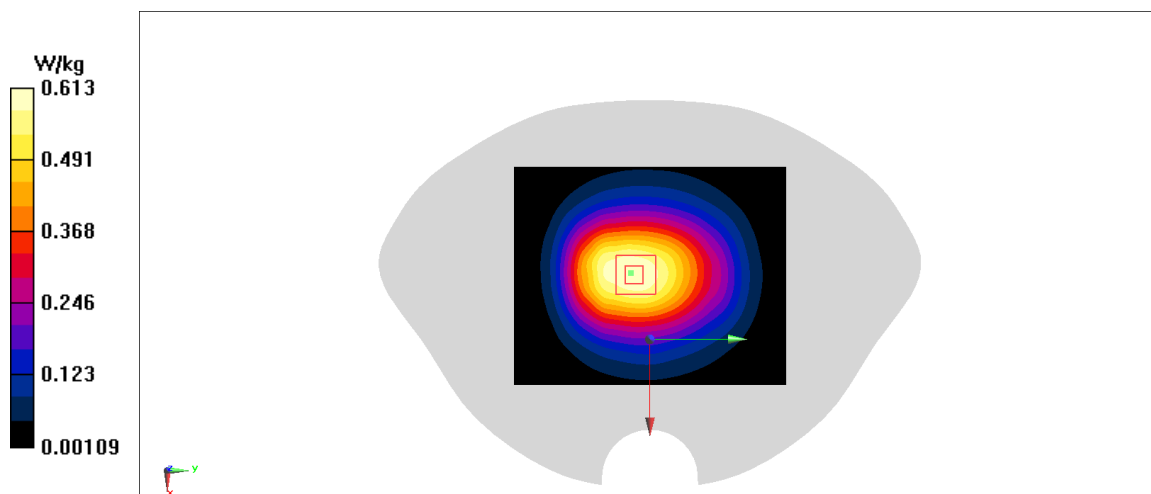

Fig A.11

LTE1900-FDD25_CH26590 Rear 0mm

Date: 10/25/2020

Electronics: DAE4 Sn777

Medium: head 1900 MHz

Medium parameters used: $f = 1905$ MHz; $\sigma = 1.416$ mho/m; $\epsilon_r = 39.37$; $\rho = 1000$ kg/m³

Ambient Temperature: 22.5°C, Liquid Temperature: 22.3°C

Communication System: LTE1900-FDD25 1905 MHz Duty Cycle: 1:1

Probe: EX3DV4 – SN3617 ConvF(8.14,8.14,8.14)

Area Scan (71x121x1): Interpolated grid: dx=1.000 mm, dy=1.000 mm

Maximum value of SAR (interpolated) = 1.08 W/kg

Zoom Scan (7x7x7)/Cube 0: Measurement grid: dx=5mm, dy=5mm, dz=5mm

Reference Value = 6.518 V/m; Power Drift = -0.04 dB

Peak SAR (extrapolated) = 1.37 W/kg

SAR(1 g) = 0.58 W/kg; SAR(10 g) = 0.25 W/kg

Maximum value of SAR (measured) = 1.09 W/kg

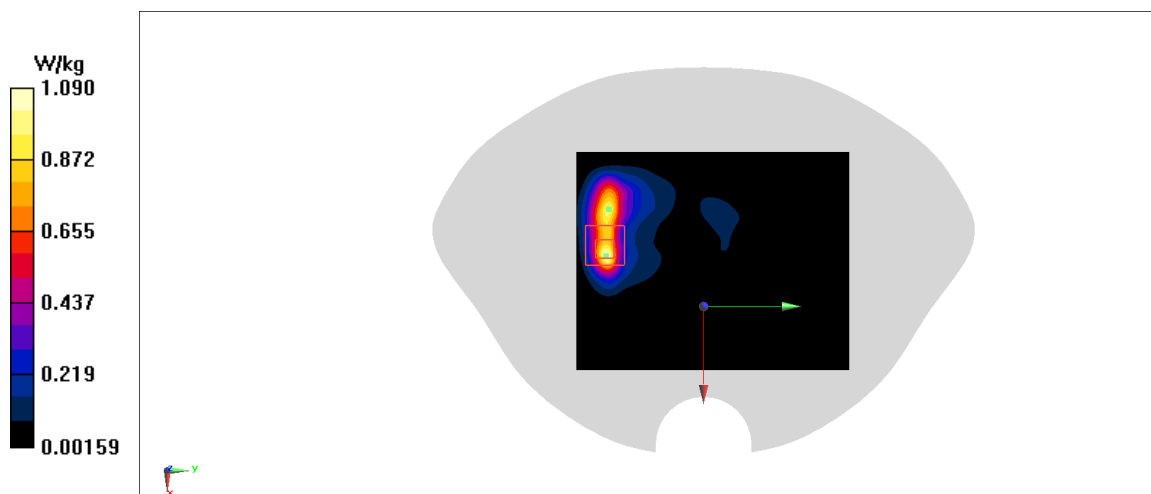

Fig A.12

LTE850-FDD26_CH26965 Front 15mm

Date: 10/23/2020

Electronics: DAE4 Sn777

Medium: head 835 MHz

Medium parameters used: $f = 841.5$ MHz; $\sigma = 0.895$ mho/m; $\epsilon_r = 40.68$; $\rho = 1000$ kg/m³

Ambient Temperature: 22.5°C, Liquid Temperature: 22.3°C

Communication System: LTE850-FDD26 841.5 MHz Duty Cycle: 1:1

Probe: EX3DV4 – SN3617 ConvF(9.66,9.66,9.66)

Area Scan (71x121x1): Interpolated grid: dx=1.000 mm, dy=1.000 mm

Maximum value of SAR (interpolated) = 1.02 W/kg

Zoom Scan (7x7x7)/Cube 0: Measurement grid: dx=5mm, dy=5mm, dz=5mm

Reference Value = 34.23 V/m; Power Drift = -0.01 dB

Peak SAR (extrapolated) = 1.15 W/kg

SAR(1 g) = 0.828 W/kg; SAR(10 g) = 0.605 W/kg

Maximum value of SAR (measured) = 1.04 W/kg

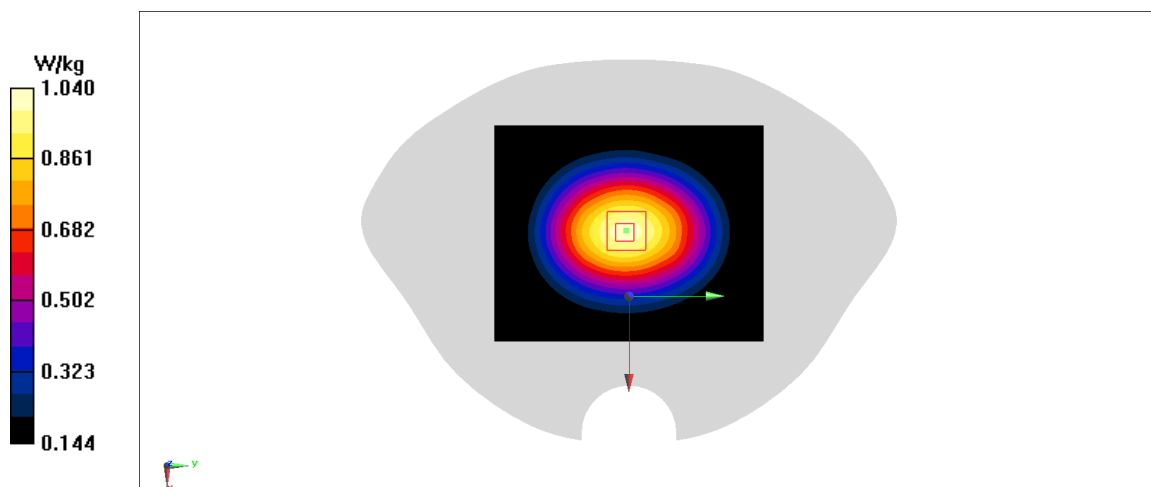

Fig A.13

LTE2500-TDD41_CH39750 Top 0mm

Date: 10/25/2020

Electronics: DAE4 Sn777

Medium: head 1900 MHz

Medium parameters used: $f = 2506$ MHz; $\sigma = 1.91$ mho/m; $\epsilon_r = 39.84$; $\rho = 1000$ kg/m³

Ambient Temperature: 22.5°C, Liquid Temperature: 22.3°C

Communication System: LTE2500-TDD41 2506 MHz Duty Cycle: 1:1.58

Probe: EX3DV4 – SN3617 ConvF(10.07,10.07,10.07)

Area Scan (71x121x1): Interpolated grid: dx=1.000 mm, dy=1.000 mm

Maximum value of SAR (interpolated) = 2.14 W/kg

Zoom Scan (7x7x7)/Cube 0: Measurement grid: dx=5mm, dy=5mm, dz=5mm

Reference Value = 12.40 V/m; Power Drift = 0.02 dB

Peak SAR (extrapolated) = 2.56 W/kg

SAR(1 g) = 1.03 W/kg; SAR(10 g) = 0.393 W/kg

Maximum value of SAR (measured) = 1.97 W/kg

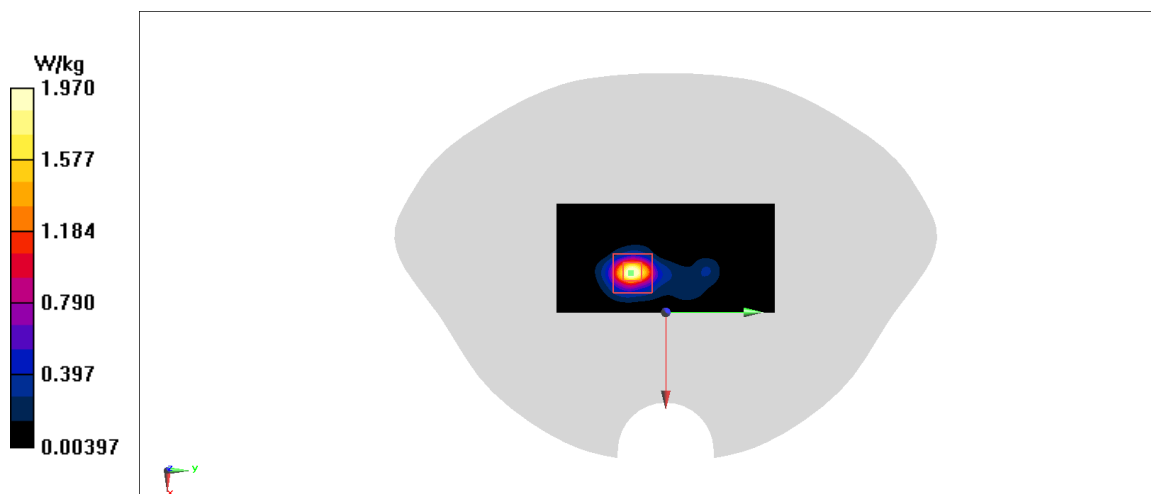
**Fig A.14**

LTE1700-FDD66_CH132322 Top 19mm

Date: 10/24/2020

Electronics: DAE4 Sn777

Medium: head 1750 MHz

Medium parameters used: $f = 1745$ MHz; $\sigma = 1.374$ mho/m; $\epsilon_r = 41.243$; $\rho = 1000$ kg/m³

Ambient Temperature: 22.5°C, Liquid Temperature: 22.3°C

Communication System: LTE1700-FDD66 1745 MHz Duty Cycle: 1:1

Probe: EX3DV4 – SN3617 ConvF(8.41,8.41,8.41)

Area Scan (71x121x1): Interpolated grid: dx=1.000 mm, dy=1.000 mm

Maximum value of SAR (interpolated) = 1.20 W/kg

Zoom Scan (7x7x7)/Cube 0: Measurement grid: dx=5mm, dy=5mm, dz=5mm

Reference Value = 27.66 V/m; Power Drift = -0.06 dB

Peak SAR (extrapolated) = 1.40 W/kg

SAR(1 g) = 0.835 W/kg; SAR(10 g) = 0.496 W/kg

Maximum value of SAR (measured) = 1.19 W/kg

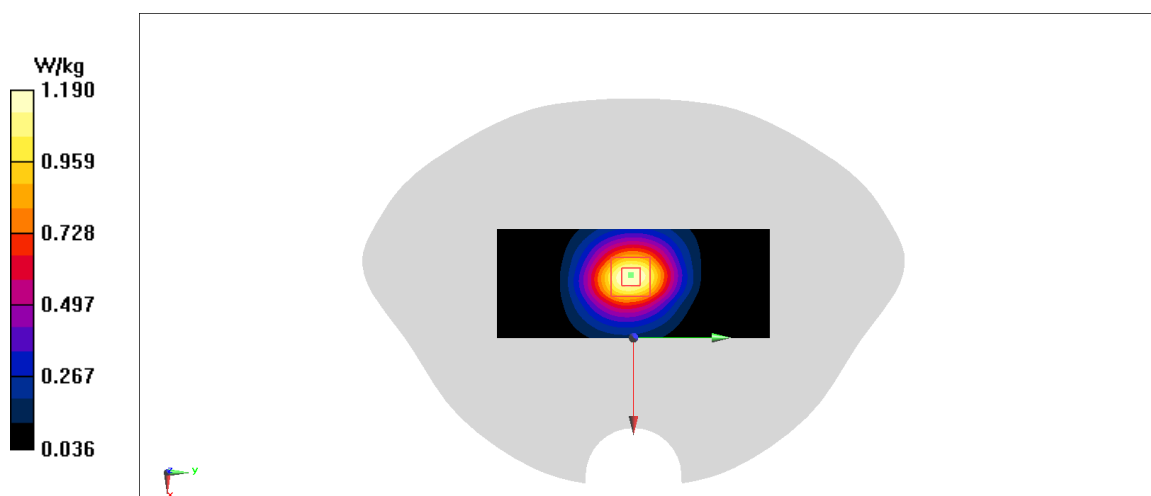

Fig A.15

LTE700-FDD71_CH133222 Front 0mm

Date: 10/22/2020

Electronics: DAE4 Sn777

Medium: head 750 MHz

Medium parameters used: $f = 673$ MHz; $\sigma = 0.813$ mho/m; $\epsilon_r = 43.9$; $\rho = 1000$ kg/m³

Ambient Temperature: 22.5°C, Liquid Temperature: 22.3°C

Communication System: LTE700-FDD71 673 MHz Duty Cycle: 1:1

Probe: EX3DV4 – SN3617 ConvF(10.07,10.07,10.07)

Area Scan (71x121x1): Interpolated grid: dx=1.000 mm, dy=1.000 mm

Maximum value of SAR (interpolated) = 0.583 W/kg

Zoom Scan (7x7x7)/Cube 0: Measurement grid: dx=5mm, dy=5mm, dz=5mm

Reference Value = 19.70 V/m; Power Drift = 0 dB

Peak SAR (extrapolated) = 0.672 W/kg

SAR(1 g) = 0.427 W/kg; SAR(10 g) = 0.302 W/kg

Maximum value of SAR (measured) = 0.553 W/kg

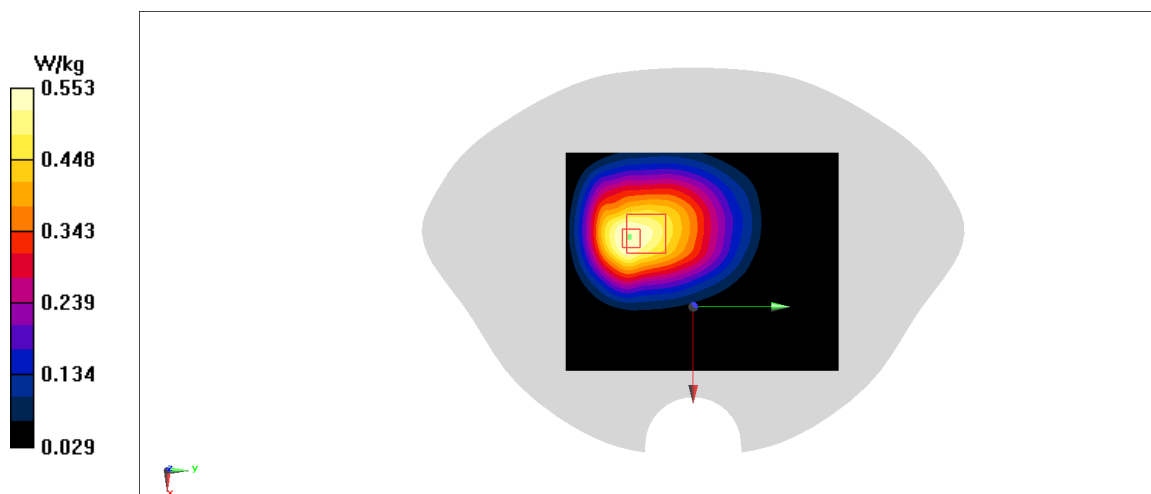
**Fig A.16**

WLAN2450_CH1 Rear 15mm

Date: 10/26/2020

Electronics: DAE4 Sn777

Medium: head 2450 MHz

Medium parameters used: $f = 2412$ MHz; $\sigma = 1.782$ mho/m; $\epsilon_r = 39.88$; $\rho = 1000$ kg/m³

Ambient Temperature: 22.5°C, Liquid Temperature: 22.3°C

Communication System: WLAN2450 2412 MHz Duty Cycle: 1:1

Probe: EX3DV4 – SN3617 ConvF(7.65,7.65,7.65)

Area Scan (71x121x1): Interpolated grid: dx=1.000 mm, dy=1.000 mm

Maximum value of SAR (interpolated) = 0.398 W/kg

Zoom Scan (7x7x7)/Cube 0: Measurement grid: dx=5mm, dy=5mm, dz=5mm

Reference Value = 5.66 V/m; Power Drift = -0.06 dB

Peak SAR (extrapolated) = 0.468 W/kg

SAR(1 g) = 0.26 W/kg; SAR(10 g) = 0.146 W/kg

Maximum value of SAR (measured) = 0.39 W/kg

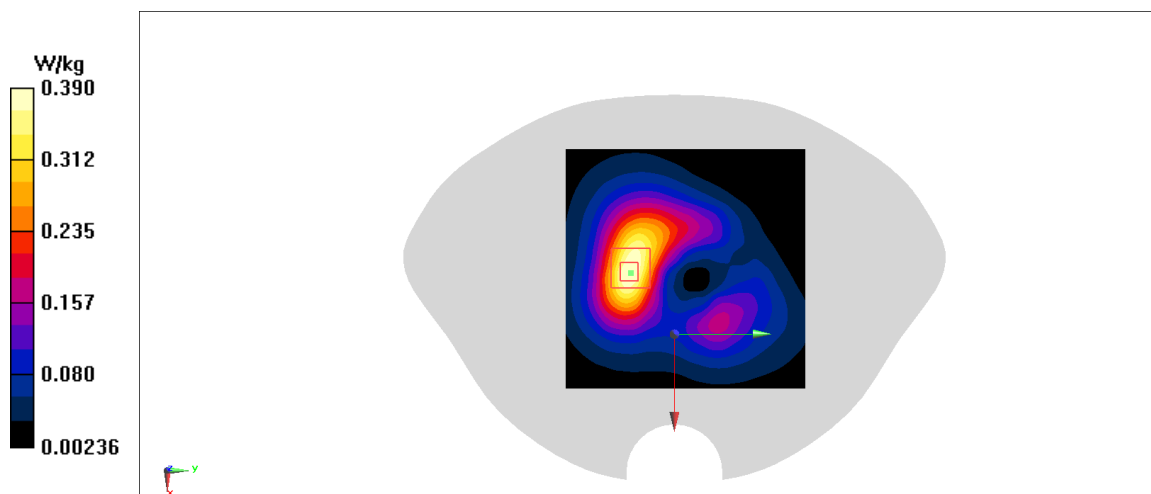

Fig A.17

WLAN2450_CH1 Rear 15mm

Date: 10/26/2020

Electronics: DAE4 Sn777

Medium: head 2450 MHz

Medium parameters used: $f = 2412$ MHz; $\sigma = 1.782$ mho/m; $\epsilon_r = 39.88$; $\rho = 1000$ kg/m³

Ambient Temperature: 22.5°C, Liquid Temperature: 22.3°C

Communication System: WLAN2450 2412 MHz Duty Cycle: 1:1

Probe: EX3DV4 – SN3617 ConvF(7.65,7.65,7.65)

Area Scan (71x121x1): Interpolated grid: dx=1.000 mm, dy=1.000 mm

Maximum value of SAR (interpolated) = 0.398 W/kg

Zoom Scan (7x7x7)/Cube 0: Measurement grid: dx=5mm, dy=5mm, dz=5mm

Reference Value = 5.66 V/m; Power Drift = -0.06 dB

Peak SAR (extrapolated) = 0.468 W/kg

SAR(1 g) = 0.26 W/kg; SAR(10 g) = 0.146 W/kg

Maximum value of SAR (measured) = 0.39 W/kg

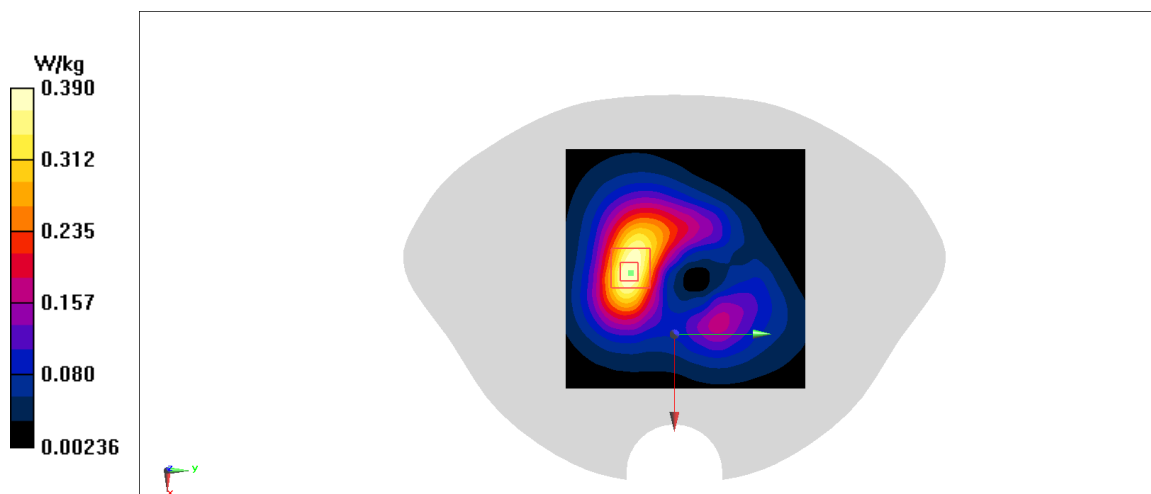
**Fig A.18**

WLAN5G_CH44 Left 15mm

Date: 10/28/2020

Electronics: DAE4 Sn777

Medium: head 5GHz

Medium parameters used: $f = 5220$ MHz; $\sigma = 4.499$ mho/m; $\epsilon_r = 34.56$; $\rho = 1000$ kg/m³

Ambient Temperature: 22.5°C, Liquid Temperature: 22.3°C

Communication System: WLAN5G 5220 MHz Duty Cycle: 1:1

Probe: EX3DV4 – SN3617 ConvF(5.49,5.49,5.49)

Area Scan (71x121x1): Interpolated grid: dx=1.000 mm, dy=1.000 mm

Maximum value of SAR (interpolated) = 2.12 W/kg

Zoom Scan (7x7x7)/Cube 0: Measurement grid: dx=5mm, dy=5mm, dz=5mm

Reference Value = 18.49 V/m; Power Drift = -0.01 dB

Peak SAR (extrapolated) = 3.22 W/kg

SAR(1 g) = 0.977 W/kg; SAR(10 g) = 0.409 W/kg

Maximum value of SAR (measured) = 2.06 W/kg

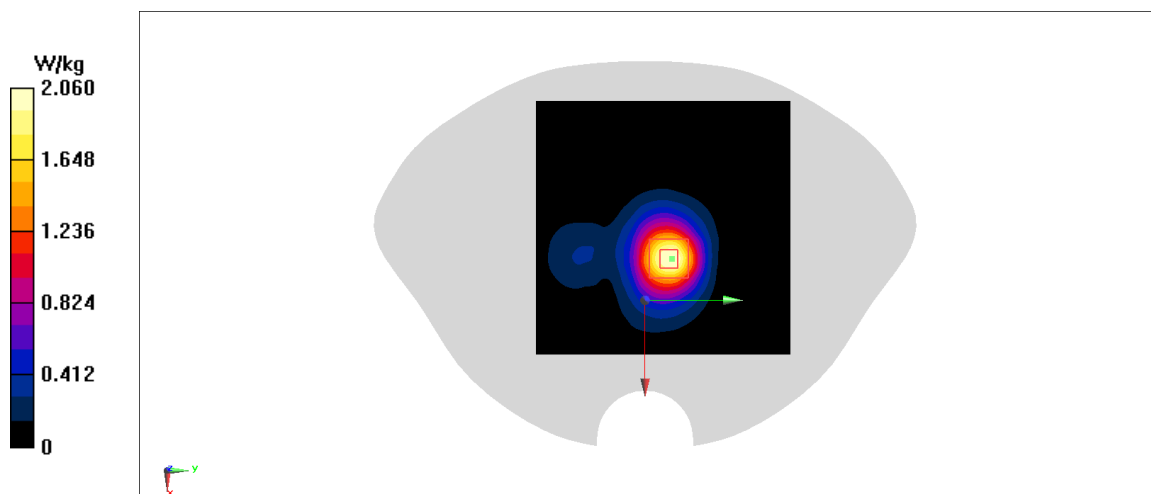
**Fig A.19**

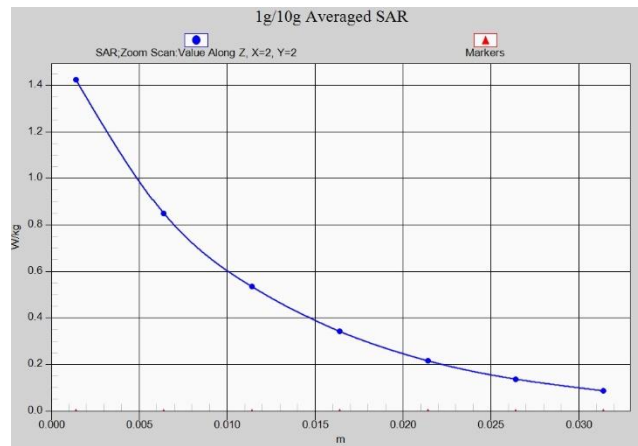

Z-Scan at power reference point (WCDMA1700 MHz Body)

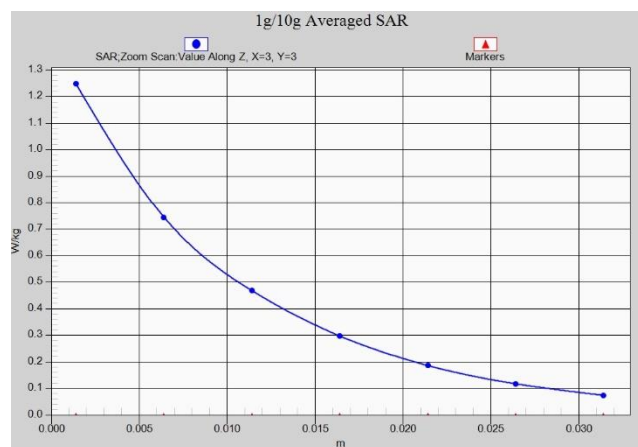

Z-Scan at power reference point (WCDMA1900 MHz Body)

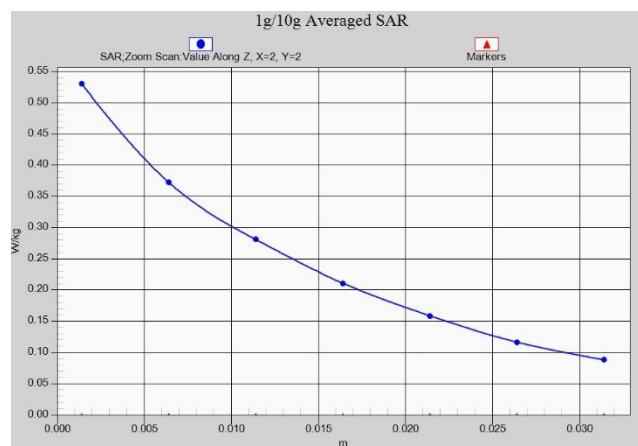

Z-Scan at power reference point (LTE B12 Body)

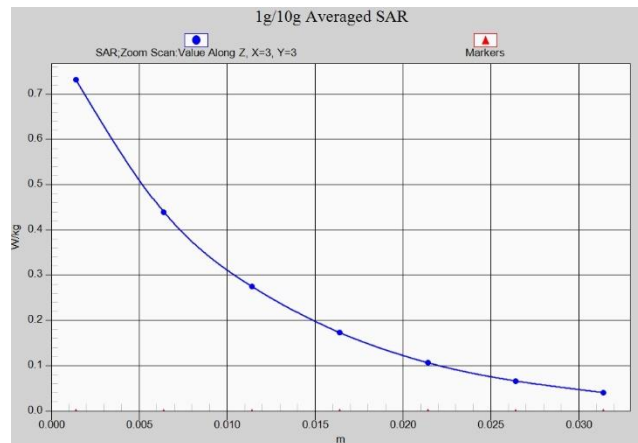

Z-Scan at power reference point (LTE B25 Body)

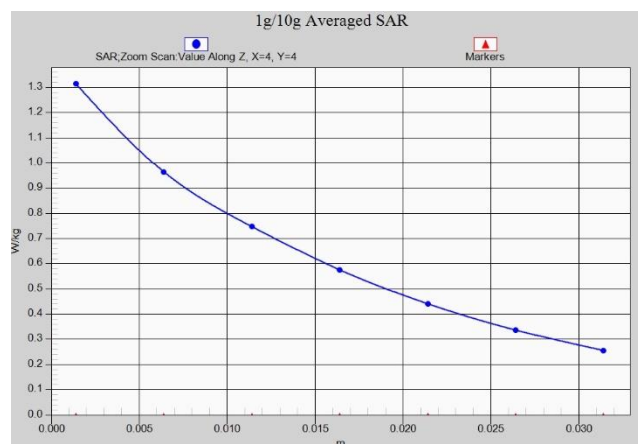

Z-Scan at power reference point (LTE B26 Body)

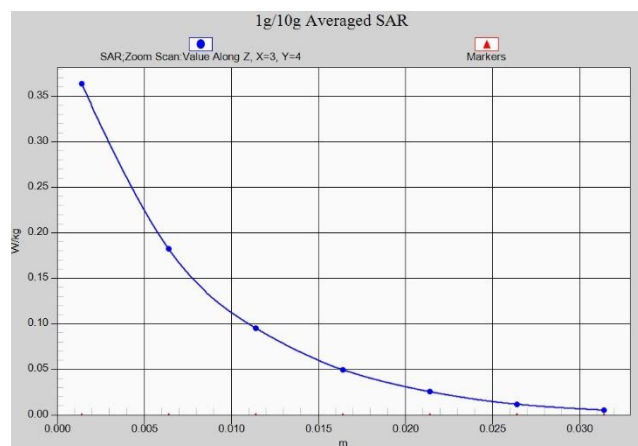

Z-Scan at power reference point (LTE B41 Body)

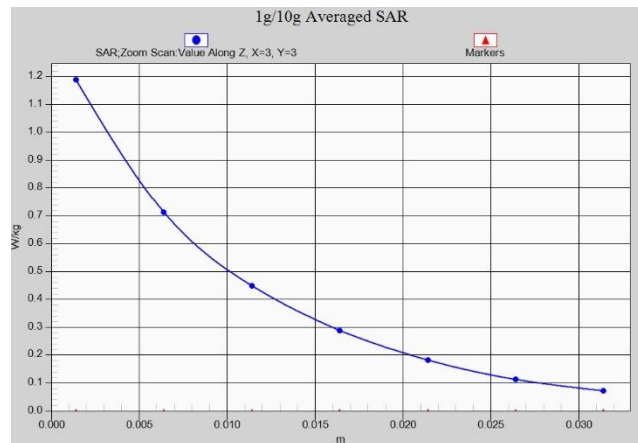

Z-Scan at power reference point (LTE B66 Body)

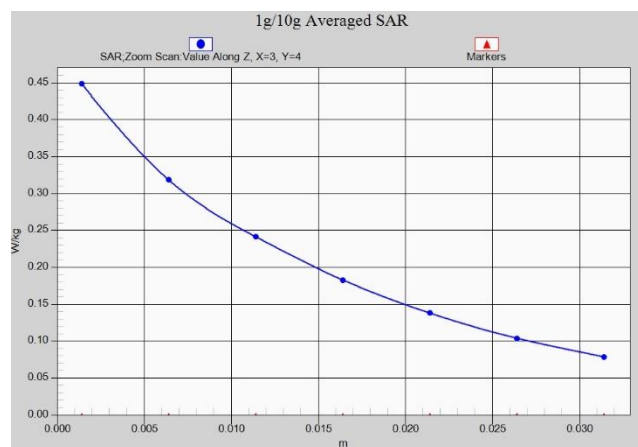

Z-Scan at power reference point (LTE B71 Body)

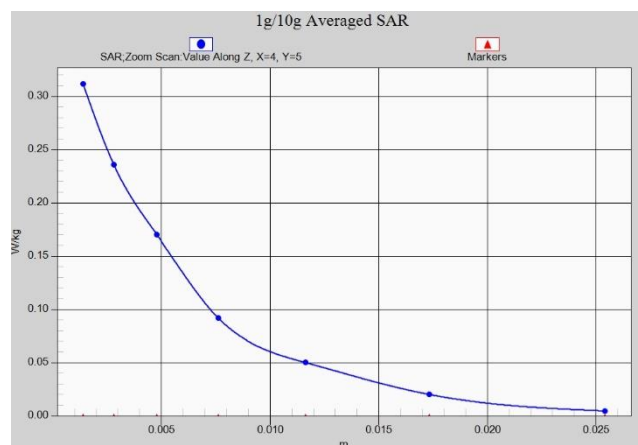

Z-Scan at power reference point (WLAN2.4G Body)

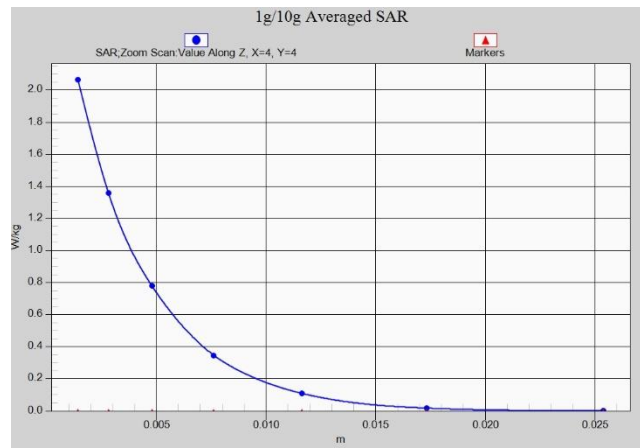

Z-Scan at power reference point (WLAN5G Body)

ANNEX B System Verification Results

750 MHz

Date: 10/22/2020

Electronics: DAE4 Sn777

Medium: Head 750 MHz

Medium parameters used: $f = 750 \text{ MHz}$; $\sigma = 0.89 \text{ mho/m}$; $\epsilon_r = 42.5$; $\rho = 1000 \text{ kg/m}^3$

Ambient Temperature: 22.5°C Liquid Temperature: 22.3°C

Communication System: CW Frequency: 750 MHz Duty Cycle: 1:1

Probe: EX3DV4 – SN3617 ConvF(10.07,10.07,10.07)

System Validation /Area Scan (81x191x1): Interpolated grid: $dx=1.000 \text{ mm}$, $dy=1.000 \text{ mm}$

Reference Value = 58.74 V/m ; Power Drift = -0.02

Fast SAR: SAR(1 g) = 2.11 W/kg ; SAR(10 g) = 1.38 W/kg

Maximum value of SAR (interpolated) = 2.85 W/kg

System Validation /Zoom Scan (7x7x7)/Cube 0: Measurement grid: $dx=5\text{mm}$, $dy=5\text{mm}$, $dz=5\text{mm}$

Reference Value = 58.74 V/m ; Power Drift = -0.02 dB

Peak SAR (extrapolated) = 3.28 W/kg

SAR(1 g) = 2.16 W/kg ; SAR(10 g) = 1.36 W/kg

Maximum value of SAR (measured) = 2.85 W/kg

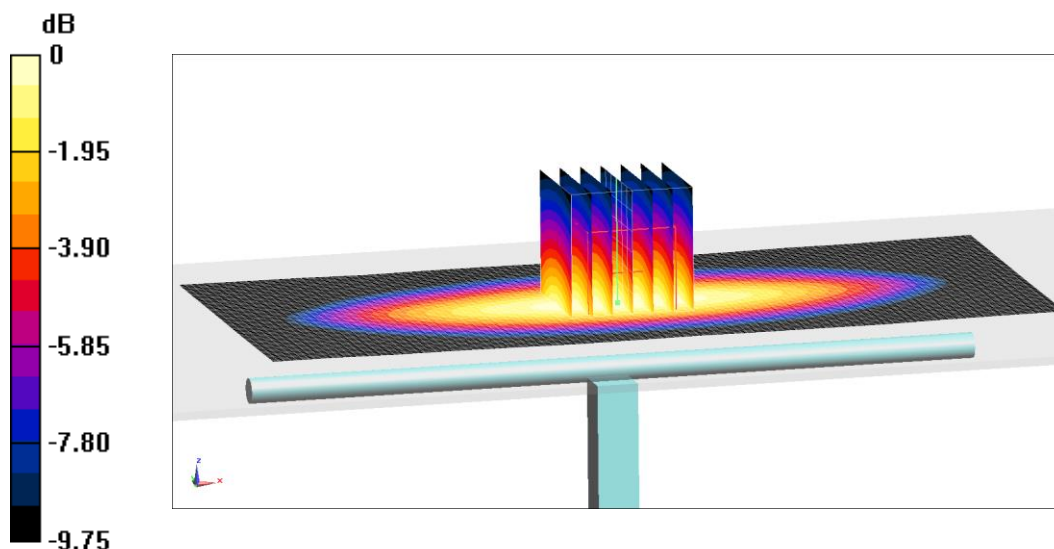

$0 \text{ dB} = 2.85 \text{ W/kg} = 4.55 \text{ dB W/kg}$

Fig.B.1 validation 750 MHz 250mW

835 MHz

Date: 10/23/2020

Electronics: DAE4 Sn777

Medium: Head 835 MHz

Medium parameters used: $f = 835$ MHz; $\sigma = 0.888$ mho/m; $\epsilon_r = 40.69$; $\rho = 1000$ kg/m³

Ambient Temperature: 22.5°C Liquid Temperature: 22.3°C

Communication System: CW Frequency: 835 MHz Duty Cycle: 1:1

Probe: EX3DV4 – SN3617 ConvF(9.66,9.66,9.66)

System Validation /Area Scan (81x191x1): Interpolated grid: dx=1.000 mm, dy=1.000 mm

Reference Value = 62.83 V/m; Power Drift = 0.1

Fast SAR: SAR(1 g) = 2.37 W/kg; SAR(10 g) = 1.53 W/kg

Maximum value of SAR (interpolated) = 3.19 W/kg

System Validation /Zoom Scan (7x7x7)/Cube 0: Measurement grid: dx=5mm, dy=5mm, dz=5mm

Reference Value =62.83 V/m; Power Drift = 0.1 dB

Peak SAR (extrapolated) = 3.66 W/kg

SAR(1 g) = 2.43 W/kg; SAR(10 g) = 1.55 W/kg

Maximum value of SAR (measured) = 3.27 W/kg

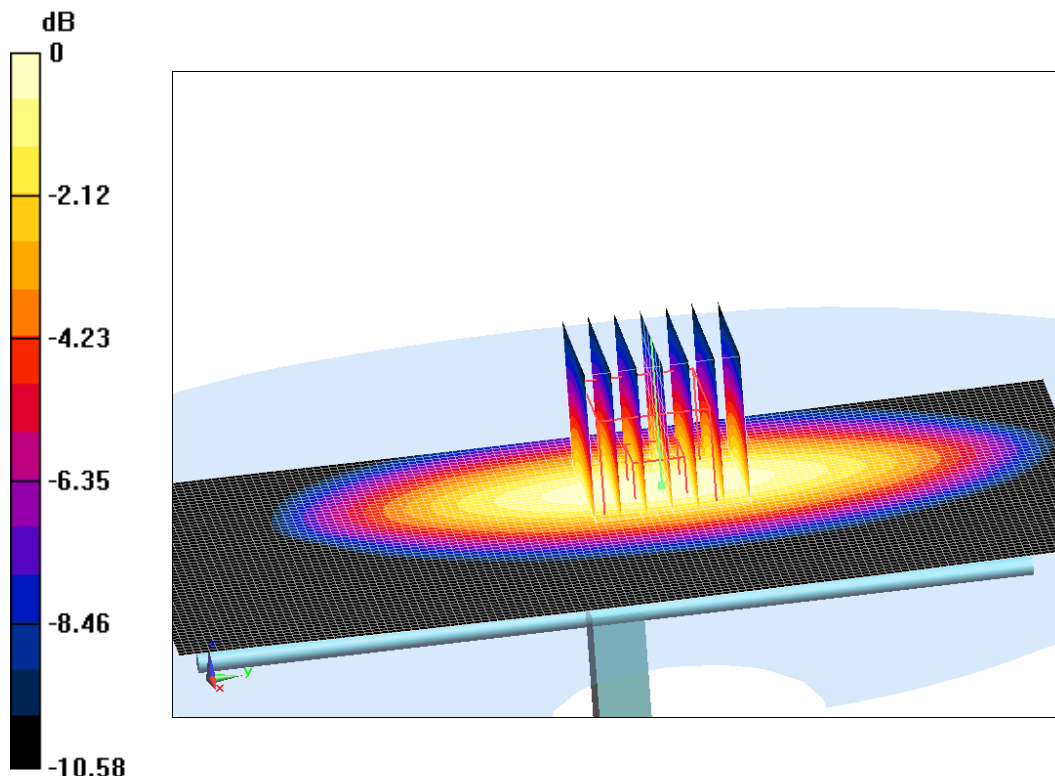

0 dB = 3.27 W/kg = 5.15 dB W/kg

Fig.B.2 validation 835 MHz 250mW

1750 MHz

Date: 10/24/2020

Electronics: DAE4 Sn777

Medium: Head 1750 MHz

Medium parameters used: $f = 1750$ MHz; $\sigma = 1.354$ mho/m; $\epsilon_r = 40.2$; $\rho = 1000$ kg/m³

Ambient Temperature: 22.5°C Liquid Temperature: 22.3°C

Communication System: CW Frequency: 1750 MHz Duty Cycle: 1:1

Probe: EX3DV4 – SN3617 ConvF(8.41,8.41,8.41)

System Validation /Area Scan (81x191x1): Interpolated grid: dx=1.000 mm, dy=1.000 mm

Reference Value = 106.22 V/m; Power Drift = 0.01

Fast SAR: SAR(1 g) = 9.29 W/kg; SAR(10 g) = 4.87 W/kg

Maximum value of SAR (interpolated) = 13.78 W/kg

System Validation /Zoom Scan (7x7x7)/Cube 0: Measurement grid: dx=5mm, dy=5mm, dz=5mm

Reference Value = 106.22 V/m; Power Drift = 0.01 dB

Peak SAR (extrapolated) = 16.83 W/kg

SAR(1 g) = 9.09 W/kg; SAR(10 g) = 4.87 W/kg

Maximum value of SAR (measured) = 13.92 W/kg

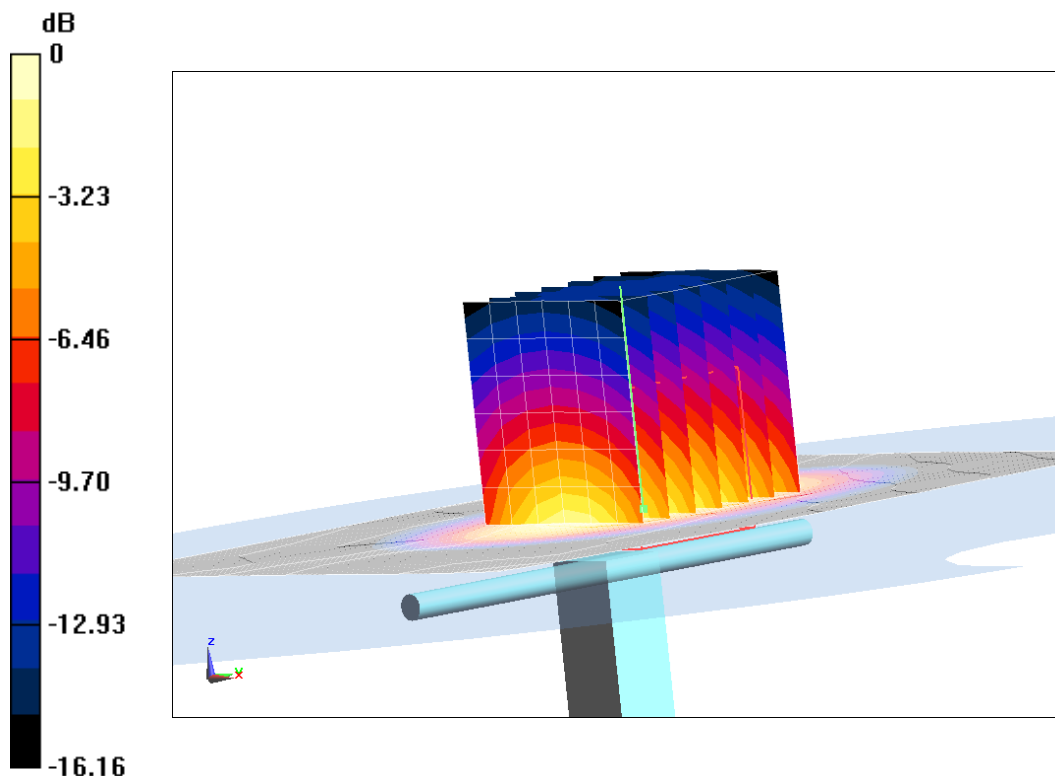

0 dB = 13.92 W/kg = 11.44 dB W/kg

Fig.B.3 validation 1750 MHz 250mW

1900 MHz

Date: 10/25/2020

Electronics: DAE4 Sn777

Medium: Head 1900 MHz

Medium parameters used: $f = 1900$ MHz; $\sigma = 1.411$ mho/m; $\epsilon_r = 39.38$; $\rho = 1000$ kg/m³

Ambient Temperature: 22.5°C Liquid Temperature: 22.3°C

Communication System: CW Frequency: 1900 MHz Duty Cycle: 1:1

Probe: EX3DV4 – SN3617 ConvF(8.14,8.14,8.14)

System Validation /Area Scan (81x191x1): Interpolated grid: dx=1.000 mm, dy=1.000 mm

Reference Value = 108.46 V/m; Power Drift = -0.04

Fast SAR: SAR(1 g) = 9.85 W/kg; SAR(10 g) = 5.22 W/kg

Maximum value of SAR (interpolated) = 14.99 W/kg

System Validation /Zoom Scan (7x7x7)/Cube 0: Measurement grid: dx=5mm, dy=5mm, dz=5mm

Reference Value =108.46 V/m; Power Drift = -0.04 dB

Peak SAR (extrapolated) = 18.42 W/kg

SAR(1 g) = 9.99 W/kg; SAR(10 g) = 5.13 W/kg

Maximum value of SAR (measured) = 15.29 W/kg

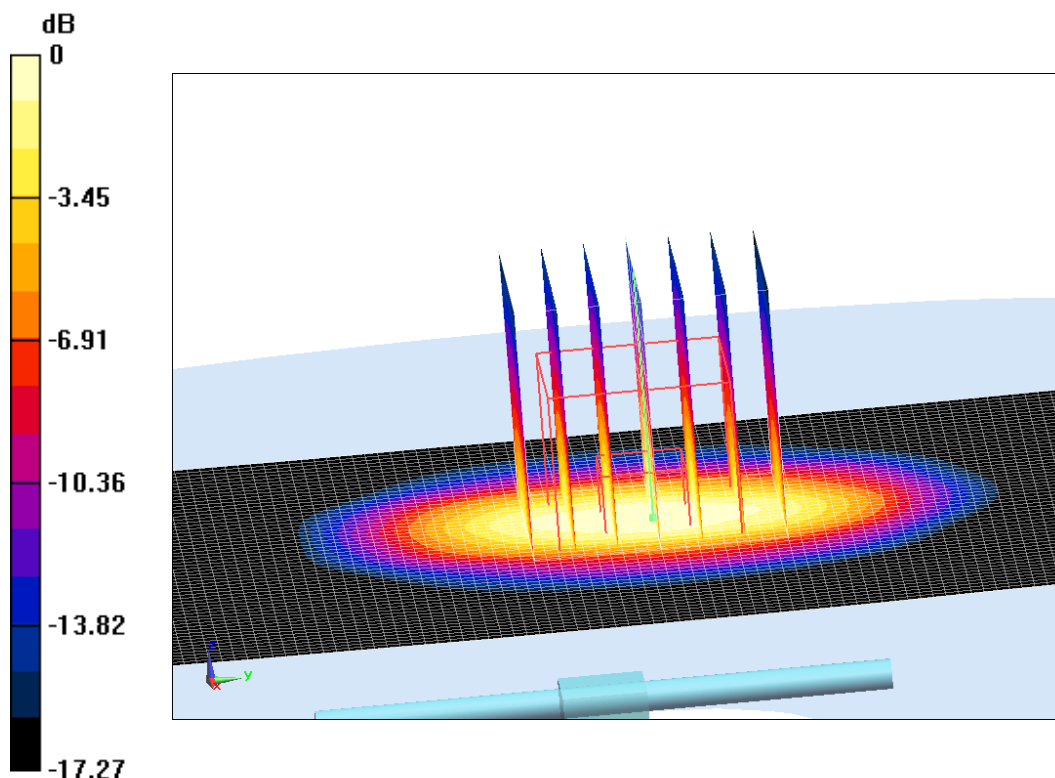

0 dB = 15.29 W/kg = 11.84 dB W/kg

Fig.B.4 validation 1900 MHz 250mW

2450 MHz

Date: 10/26/2020

Electronics: DAE4 Sn777

Medium: Head 2450 MHz

Medium parameters used: $f = 2450$ MHz; $\sigma = 1.818$ mho/m; $\epsilon_r = 39.83$; $\rho = 1000$ kg/m³

Ambient Temperature: 22.5°C Liquid Temperature: 22.3°C

Communication System: CW Frequency: 2450 MHz Duty Cycle: 1:1

Probe: EX3DV4 – SN3617 ConvF(7.65,7.65,7.65)

System Validation /Area Scan (81x191x1): Interpolated grid: dx=1.000 mm, dy=1.000 mm

Reference Value = 118.99 V/m; Power Drift = -0.04

Fast SAR: SAR(1 g) = 13.28 W/kg; SAR(10 g) = 6.14 W/kg

Maximum value of SAR (interpolated) = 21.64 W/kg

System Validation /Zoom Scan (7x7x7)/Cube 0: Measurement grid: dx=5mm, dy=5mm, dz=5mm

Reference Value = 118.99 V/m; Power Drift = -0.04 dB

Peak SAR (extrapolated) = 25.69 W/kg

SAR(1 g) = 13 W/kg; SAR(10 g) = 6.2 W/kg

Maximum value of SAR (measured) = 21.45 W/kg

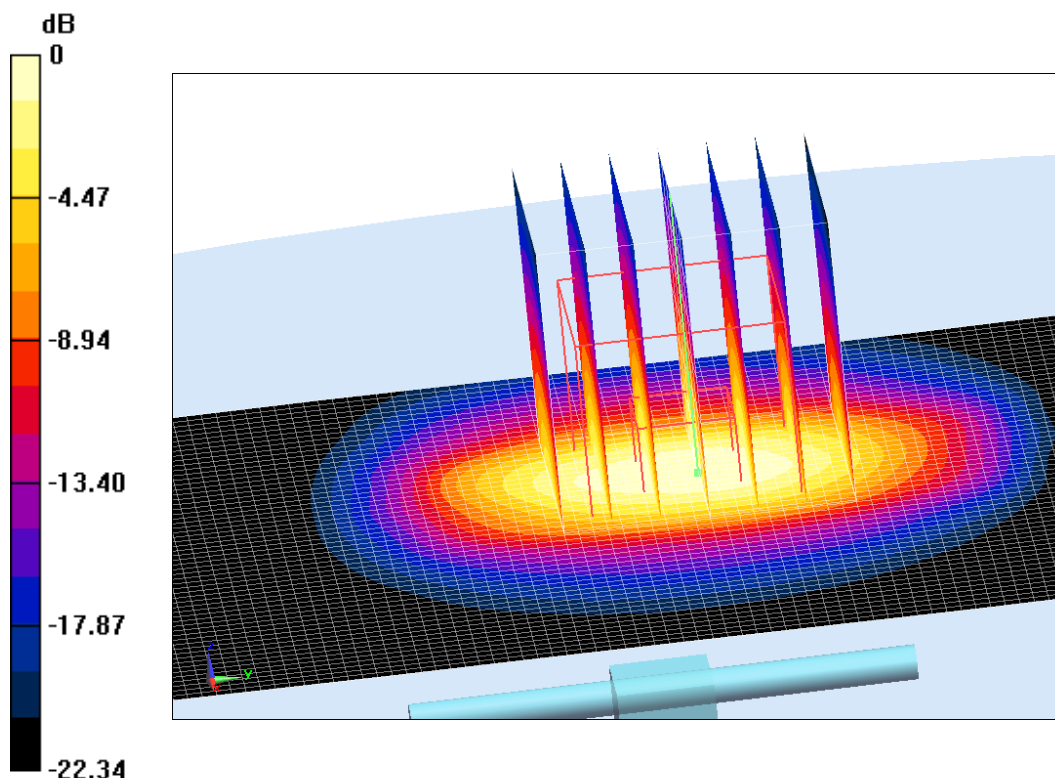

0 dB = 21.45 W/kg = 13.31 dB W/kg

Fig.B.5 validation 2450 MHz 250mW

2600 MHz

Date: 10/27/2020

Electronics: DAE4 Sn777

Medium: Head 2600 MHz

Medium parameters used: $f = 2600$ MHz; $\sigma = 1.956$ mho/m; $\epsilon_r = 39.01$; $\rho = 1000$ kg/m³

Ambient Temperature: 22.5°C Liquid Temperature: 22.3°C

Communication System: CW Frequency: 2600 MHz Duty Cycle: 1:1

Probe: EX3DV4 – SN3617 ConvF(7.52,7.52,7.52)

System Validation /Area Scan (81x191x1): Interpolated grid: dx=1.000 mm, dy=1.000 mm

Reference Value = 123.36 V/m; Power Drift = 0.02

Fast SAR: SAR(1 g) = 14.07 W/kg; SAR(10 g) = 6.2 W/kg

Maximum value of SAR (interpolated) = 23.88 W/kg

System Validation /Zoom Scan (7x7x7)/Cube 0: Measurement grid: dx=5mm, dy=5mm, dz=5mm

Reference Value =123.36 V/m; Power Drift = 0.02 dB

Peak SAR (extrapolated) = 29.43 W/kg

SAR(1 g) = 14.2 W/kg; SAR(10 g) = 6.34 W/kg

Maximum value of SAR (measured) = 23.95 W/kg

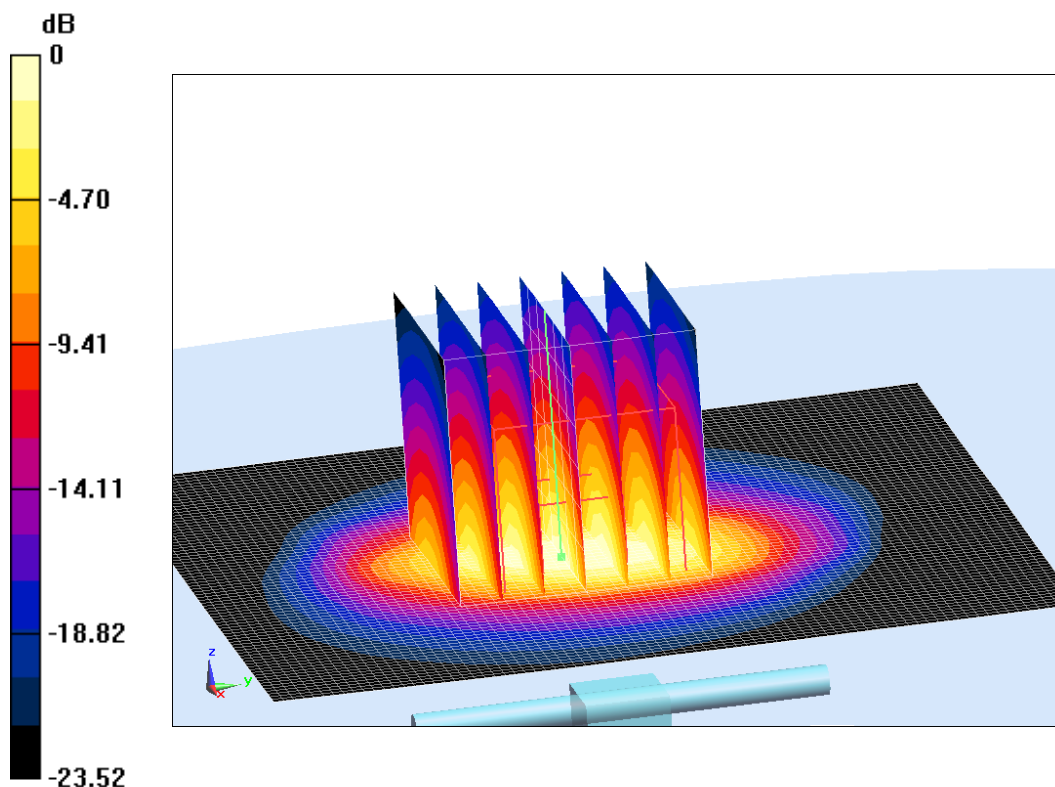

0 dB = 23.95 W/kg = 13.79 dB W/kg

Fig.B.6 validation 2600 MHz 250mW

5250 MHz

Date: 10/28/2020

Electronics: DAE4 Sn777

Medium: Head 5250 MHz

Medium parameters used: $f = 5250$ MHz; $\sigma = 4.729$ mho/m; $\epsilon_r = 36.07$; $\rho = 1000$ kg/m³

Ambient Temperature: 22.5°C Liquid Temperature: 22.3°C

Communication System: CW Frequency: 5250 MHz Duty Cycle: 1:1

Probe: EX3DV4 – SN3617 ConvF(5.39,5.39,5.39)

System Validation /Area Scan (81x191x1): Interpolated grid: dx=1.000 mm, dy=1.000 mm

Reference Value = 80.36 V/m; Power Drift = 0.02

Fast SAR: SAR(1 g) = 19.77 W/kg; SAR(10 g) = 5.78 W/kg

Maximum value of SAR (interpolated) = 18.06 W/kg

System Validation /Zoom Scan (7x7x7)/Cube 0: Measurement grid: dx=5mm, dy=5mm, dz=5mm

Reference Value =80.36 V/m; Power Drift = 0.02 dB

Peak SAR (extrapolated) = 28.46 W/kg

SAR(1 g) = 20 W/kg; SAR(10 g) = 5.79 W/kg

Maximum value of SAR (measured) = 18.62 W/kg

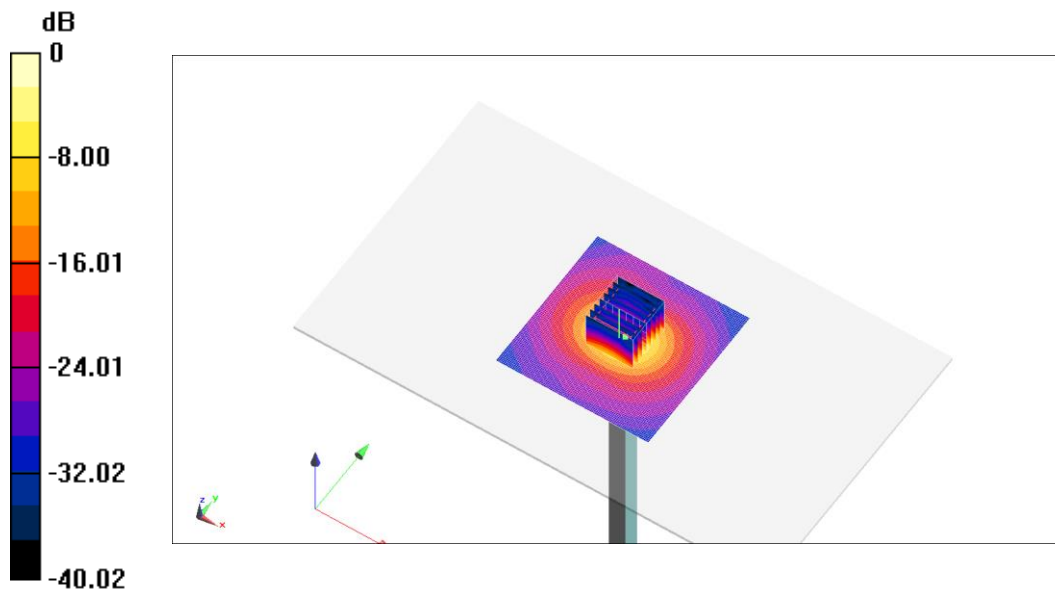

0 dB = 18.62 W/kg = 12.7 dB W/kg

Fig.B.7 validation 5250 MHz 250mW

5600 MHz

Date: 10/29/2020

Electronics: DAE4 Sn777

Medium: Head 5600 MHz

Medium parameters used: $f = 5600$ MHz; $\sigma = 5.153$ mho/m; $\epsilon_r = 35.75$; $\rho = 1000$ kg/m³

Ambient Temperature: 22.5°C Liquid Temperature: 22.3°C

Communication System: CW Frequency: 5600 MHz Duty Cycle: 1:1

Probe: EX3DV4 – SN3617 ConvF(4.99,4.99,4.99)

System Validation /Area Scan (81x191x1): Interpolated grid: dx=1.000 mm, dy=1.000 mm

Reference Value = 79.4 V/m; Power Drift = -0.1

Fast SAR: SAR(1 g) = 20.89 W/kg; SAR(10 g) = 5.79 W/kg

Maximum value of SAR (interpolated) = 19.84 W/kg

System Validation /Zoom Scan (7x7x7)/Cube 0: Measurement grid: dx=5mm, dy=5mm, dz=5mm

Reference Value =79.4 V/m; Power Drift = -0.1 dB

Peak SAR (extrapolated) = 31.06 W/kg

SAR(1 g) = 20.88 W/kg; SAR(10 g) = 5.88 W/kg

Maximum value of SAR (measured) = 20.39 W/kg

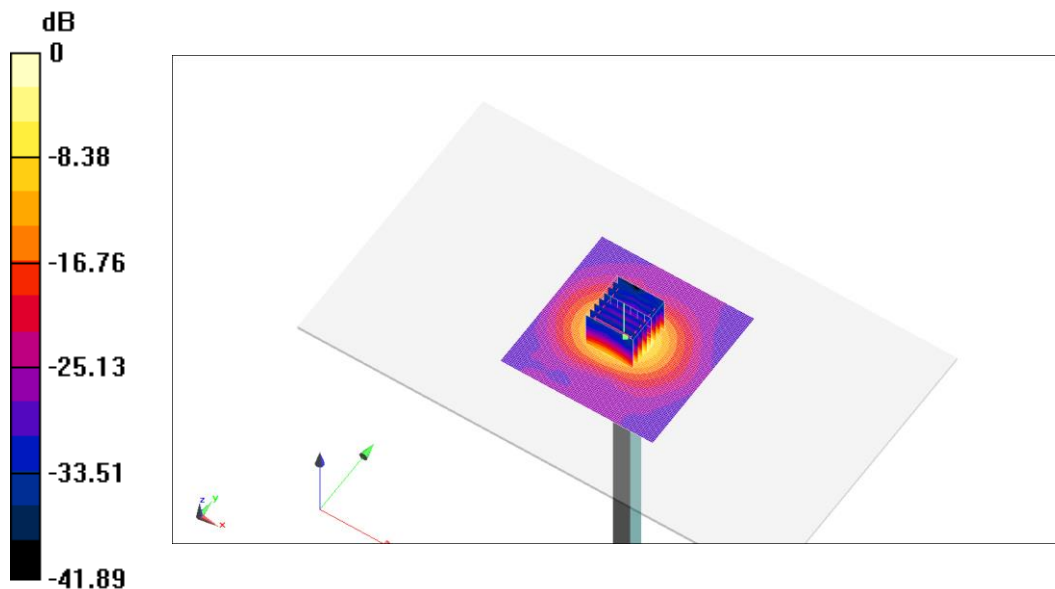

0 dB = 20.39 W/kg = 13.09 dB W/kg

Fig.B.8 validation 5600 MHz 250mW

5750 MHz

Date: 10/30/2020

Electronics: DAE4 Sn777

Medium: Head 5750 MHz

Medium parameters used: $f = 5750$ MHz; $\sigma = 5.201$ mho/m; $\epsilon_r = 35.73$; $\rho = 1000$ kg/m³

Ambient Temperature: 22.5°C Liquid Temperature: 22.3°C

Communication System: CW Frequency: 5750 MHz Duty Cycle: 1:1

Probe: EX3DV4 – SN3617 ConvF(5.10,5.10,5.10)

System Validation /Area Scan (81x191x1): Interpolated grid: dx=1.000 mm, dy=1.000 mm

Reference Value = 76.15 V/m; Power Drift = -0.02

Fast SAR: SAR(1 g) = 20.29 W/kg; SAR(10 g) = 5.74 W/kg

Maximum value of SAR (interpolated) = 20.16 W/kg

System Validation /Zoom Scan (7x7x7)/Cube 0: Measurement grid: dx=5mm, dy=5mm, dz=5mm

Reference Value =76.15 V/m; Power Drift = -0.02 dB

Peak SAR (extrapolated) = 32.38 W/kg

SAR(1 g) = 19.9 W/kg; SAR(10 g) = 5.75 W/kg

Maximum value of SAR (measured) = 19.65 W/kg

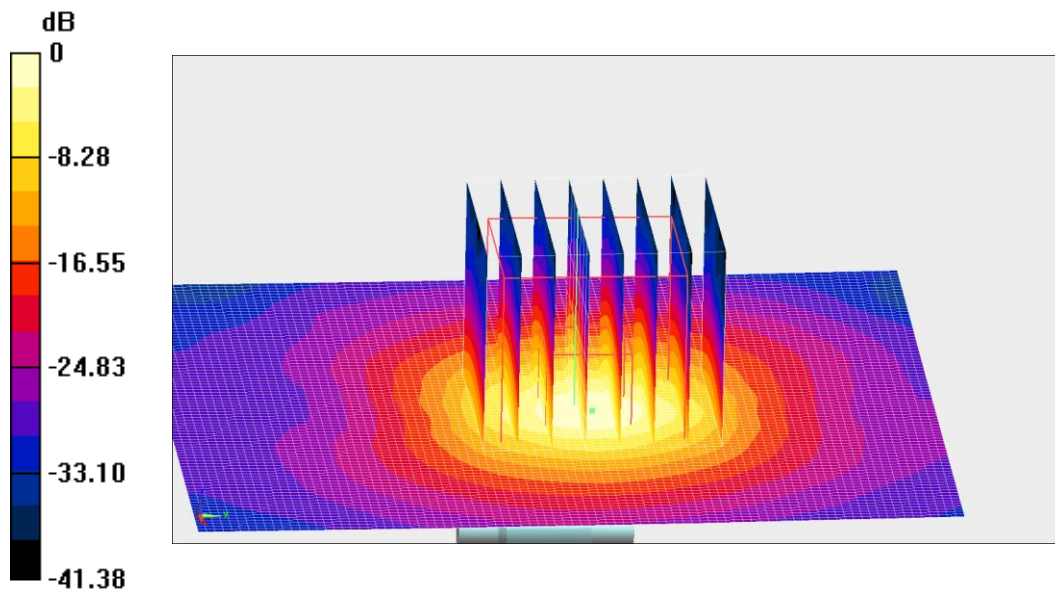

0 dB = 19.65 W/kg = 12.93 dB W/kg

Fig.B.9 validation 5750 MHz 250mW

The SAR system verification must be required that the area scan estimated 1-g SAR is within 3% of the zoom scan 1-g SAR.

Table B.1 Comparison between area scan and zoom scan for system verification

Date	Band	Position	Area scan (1g)	Zoom scan (1g)	Drift (%)
2020/10/22	750 MHz	Head	2.11	2.16	-2.31
2020/10/23	835 MHz	Head	2.37	2.43	-2.47
2020/10/24	1750 MHz	Head	9.29	9.09	2.2
2020/10/25	1900 MHz	Head	9.85	9.99	-1.4
2020/10/26	2450 MHz	Head	13.28	13	2.15
2020/10/27	2600 MHz	Head	14.07	14.2	-0.92

ANNEX C SAR Measurement Setup

C.1 Measurement Set-up

The Dasy4 or DASY5 system for performing compliance tests is illustrated above graphically. This system consists of the following items:

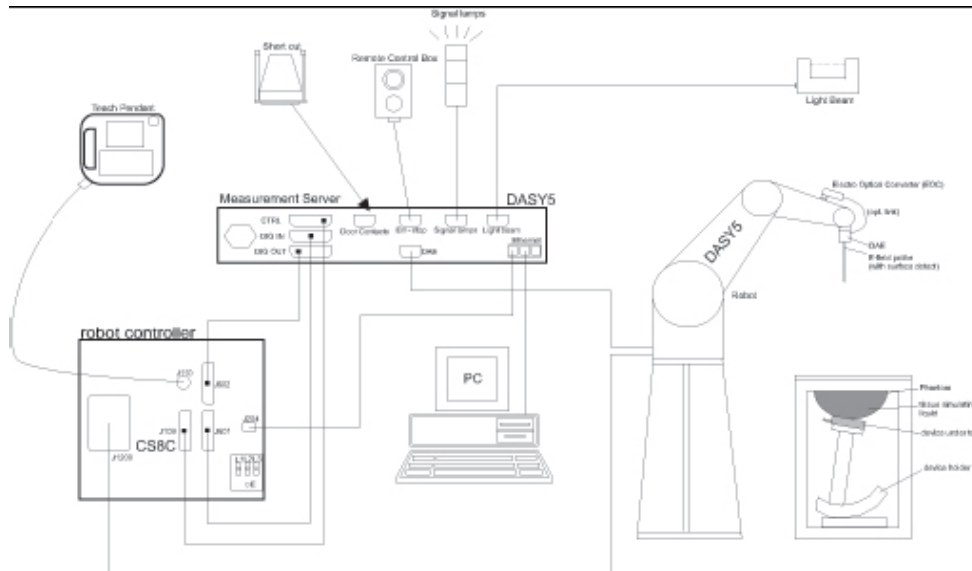

Picture C.1 SAR Lab Test Measurement Set-up

- A standard high precision 6-axis robot (Stäubli TX=RX family) with controller, teach pendant and software. An arm extension for accommodating the data acquisition electronics (DAE).
- An isotropic field probe optimized and calibrated for the targeted measurement.
- A data acquisition electronics (DAE) which performs the signal amplification, signal multiplexing, AD-conversion, offset measurements, mechanical surface detection, collision detection, etc. The unit is battery powered with standard or rechargeable batteries. The signal is optically transmitted to the EOC.
- The Electro-optical converter (EOC) performs the conversion from optical to electrical signals for the digital communication to the DAE. To use optical surface detection, a special version of the EOC is required. The EOC signal is transmitted to the measurement server.
- The function of the measurement server is to perform the time critical tasks such as signal filtering, control of the robot operation and fast movement interrupts.
- The Light Beam used is for probe alignment. This improves the (absolute) accuracy of the probe positioning.
- A computer running WinXP and the DASY4 or DASY5 software.
- Remote control and teach pendant as well as additional circuitry for robot safety such as
- warning lamps, etc.
- The phantom, the device holder and other accessories according to the targeted measurement.

C.2 Dasy4 or DASY5 E-field Probe System

The SAR measurements were conducted with the dosimetric probe designed in the classical triangular configuration and optimized for dosimetric evaluation. The probe is constructed using the thick film technique; with printed resistive lines on ceramic substrates. The probe is equipped with an optical multifiber line ending at the front of the probe tip. It is connected to the EOC box on the robot arm and provides an automatic detection of the phantom surface. Half of the fibers are connected to a pulsed infrared transmitter, the other half to a synchronized receiver. As the probe approaches the surface, the reflection from the surface produces a coupling from the transmitting to the receiving fibers. This reflection increases first during the approach, reaches maximum and then decreases. If the probe is flatly touching the surface, the coupling is zero. The distance of the coupling maximum to the surface is independent of the surface reflectivity and largely independent of the surface to probe angle. The DASY4 or DASY5 software reads the reflection during a software approach and looks for the maximum using 2nd ord curve fitting. The approach is stopped at reaching the maximum.

Probe Specifications:

Model:	ES3DV3, EX3DV4
Frequency	10MHz — 6.0GHz(EX3DV4)
Range:	10MHz — 4GHz(ES3DV3)
Calibration:	In head and body simulating tissue at Frequencies from 835 up to 5800MHz
Linearity:	± 0.2 dB(30 MHz to 6 GHz) for EX3DV4 ± 0.2 dB(30 MHz to 4 GHz) for ES3DV3
DynamicRange:	10 mW/kg — 100W/kg
Probe Length:	330 mm
Probe Tip	
Length:	20 mm
Body Diameter:	12 mm
Tip Diameter:	2.5 mm (3.9 mm for ES3DV3)
Tip-Center:	1 mm (2.0mm for ES3DV3)
Application:	SAR Dosimetry Testing Compliance tests of mobile phones Dosimetry in strong gradient fields



Picture C.2Near-field Probe



Picture C.3E-field Probe

C.3 E-field Probe Calibration

Each E-Probe/Probe Amplifier combination has unique calibration parameters. A TEM cell calibration procedure is conducted to determine the proper amplifier settings to enter in the probe parameters. The amplifier settings are determined for a given frequency by subjecting the probe to a known E-field density (1 mW/cm²) using an RF Signal generator, TEM cell, and RF Power Meter.

The free space E-field from amplified probe outputs is determined in a test chamber. This calibration can be performed in a TEM cell if the frequency is below 1 GHz and in a waveguide or other methodologies above 1 GHz for free space. For the free space calibration, the probe is placed

in the volumetric center of the cavity and at the proper orientation with the field. The probe is then rotated 360 degrees until the three channels show the maximum reading. The power density readings equates to 1 mW/cm².

E-field temperature correlation calibration is performed in a flat phantom filled with the appropriate simulated brain tissue. The E-field in the medium correlates with the temperature rise in the dielectric medium. For temperature correlation calibration a RF transparent thermistor-based temperature probe is used in conjunction with the E-field probe.

$$SAR = C \frac{\Delta T}{\Delta t}$$

Where:

Δt = Exposure time (30 seconds),

C = Heat capacity of tissue (brain or muscle),

ΔT = Temperature increase due to RF exposure.

$$SAR = \frac{|E|^2 \cdot \sigma}{\rho}$$

Where:

σ = Simulated tissue conductivity,

ρ = Tissue density (kg/m³).

C.4 Other Test Equipment

C.4.1 Data Acquisition Electronics(DAE)

The data acquisition electronics consist of a highly sensitive electrometer-grade preamplifier with auto-zeroing, a channel and gain-switching multiplexer, a fast 16 bit AD-converter and a command decoder with a control logic unit. Transmission to the measurement server is accomplished through an optical downlink for data and status information, as well as an optical uplink for commands and the clock.

The mechanical probe mounting device includes two different sensor systems for frontal and sideways probe contacts. They are used for mechanical surface detection and probe collision detection.

The input impedance of the DAE is 200 MOhm; the inputs are symmetrical and floating. Common mode rejection is above 80 dB.



PictureC.4: DAE

C.4.2 Robot

The SPEAG DASY system uses the high precision robots (DASY4: RX90XL; DASY5: RX160L) type from Stäubli SA (France). For the 6-axis controller system, the robot controller version from Stäubli is used. The Stäubli robot series have many features that are important for our application:

- High precision (repeatability 0.02mm)
- High reliability (industrial design)
- Low maintenance costs (virtually maintenance free due to direct drive gears; no belt drives)
- Jerk-free straight movements (brushless synchron motors; no stepper motors)
- Low ELF interference (motor control fields shielded via the closed metallic construction shields)



Picture C.5 DASY 4



Picture C.6 DASY 5

C.4.3 Measurement Server

The Measurement server is based on a PC/104 CPU board with CPU (dasy4: 166 MHz, Intel Pentium; DASY5: 400 MHz, Intel Celeron), chipdisk (DASY4: 32 MB; DASY5: 128MB), RAM (DASY4: 64 MB, DASY5: 128MB). The necessary circuits for communication with the DAE electronic box, as well as the 16 bit AD converter system for optical detection and digital I/O interface are contained on the DASY I/O board, which is directly connected to the PC/104 bus of the CPU board.

The measurement server performs all real-time data evaluation of field measurements and surface detection, controls robot movements and handles safety operation. The PC operating system cannot interfere with these time critical processes. All connections are supervised by a watchdog, and disconnection of any of the cables to the measurement server will automatically disarm the robot and disable all program-controlled robot movements. Furthermore, the measurement server is equipped with an expansion port which is reserved for future applications. Please note that this expansion port does not have a standardized pinout, and therefore only devices provided by SPEAG can be connected. Devices from any other supplier could seriously damage the measurement server.



Picture C.7 Server for DASY 4

Picture C.8 Server for DASY 5

C.4.4 Device Holder for Phantom

The SAR in the phantom is approximately inversely proportional to the square of the distance between the source and the liquid surface. For a source at 5mm distance, a positioning uncertainty of $\pm 0.5\text{mm}$ would produce a SAR uncertainty of $\pm 20\%$. Accurate device positioning is therefore crucial for accurate and repeatable measurements. The positions in which the devices must be measured are defined by the standards.

The DASY device holder is designed to cope with the different positions given in the standard. It has two scales for device rotation (with respect to the body axis) and device inclination (with respect to the line between the ear reference points). The rotation centers for both scales are the ear reference point (ERP). Thus the device needs no repositioning when changing the angles.

The DASY device holder is constructed of low-loss POM material having the following dielectric parameters: relative permittivity $\epsilon = 3$ and loss tangent $\delta = 0.02$. The amount of dielectric material has been reduced in the closest vicinity of the device, since measurements have suggested that the influence of the clamp on the test results could thus be lowered.

<Laptop Extension Kit>

The extension is lightweight and made of POM, acrylic glass and foam. It fits easily on the upper part of the Mounting Device in place of the phone positioner. The extension is fully compatible with the Twin-SAM and ELI phantoms.



Picture C.9-1: Device Holder

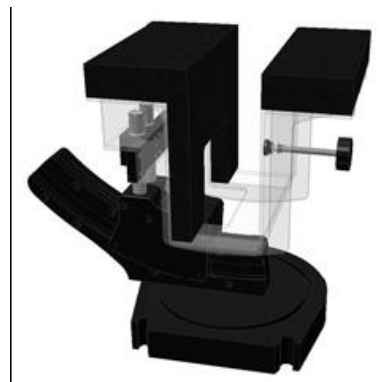

Picture C.9-2: Laptop Extension Kit

C.4.5 Phantom

The SAM Twin Phantom V4.0 is constructed of a fiberglass shell integrated in a table. The shape of the shell is based on data from an anatomical study designed to represent the 90th percentile of the population. The phantom enables the dissymmetric evaluation of SAR for both left and right handed handset usage, as well as body-worn usage using the flat phantom region. Reference markings on the Phantom allow the complete setup of all predefined phantom positions and measurement grids by manually teaching three points in the robot. The shell phantom has a 2mm shell thickness (except the ear region where shell thickness increases to 6 mm).

Shell Thickness: 2 ± 0.2 mm

Filling Volume: Approx. 25 liters

Dimensions: 810 x 1000 x 500 mm (H x L x W)

Available: Special



Picture C.10: SAM Twin Phantom

ANNEX D Position of the wireless device in relation to the phantom

D.1 USB Dongle device

Test all USB orientations [see figure below: (A) Horizontal-Up, (B) Horizontal-Down, (C) Vertical-Front, and (D) Vertical-Back] with a device-to-phantom separation distance of 5 mm or less. These test orientations are intended for the exposure conditions found in typical laptop/notebook/netbook or tablet computers with either horizontal or vertical USB connector configurations at various locations in the keyboard section of the computer. Current generation portable host computers should be used to establish the required SAR measurement separation distance. The same test separation distance must be used to test all frequency bands and modes in each USB orientation. The typical Horizontal-Up USB connection (A), found in the majority of host computers, must be tested using an appropriate host computer. A host computer with either Vertical-Front (C) or Vertical-Back (D) USB connection should be used to test one of the vertical USB orientations.

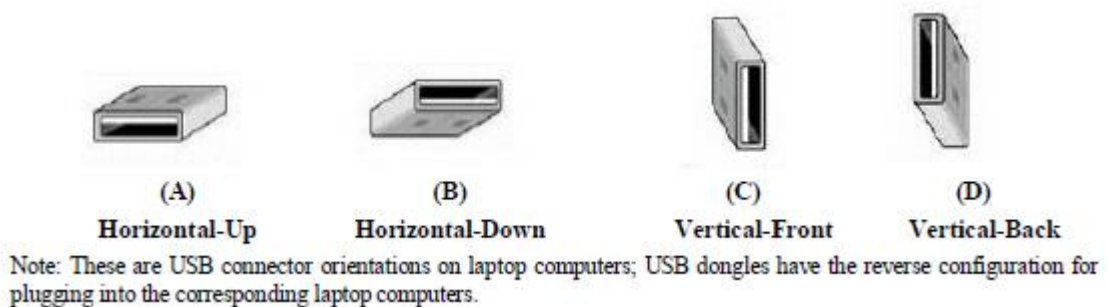

Picture D.1 Test positions for desktop devices

D.2 Body-worn device

A typical example of a body-worn device is a mobile phone, wireless enabled PDA or other battery operated wireless device with the ability to transmit while mounted on a person's body using a carry accessory approved by the wireless device manufacturer.

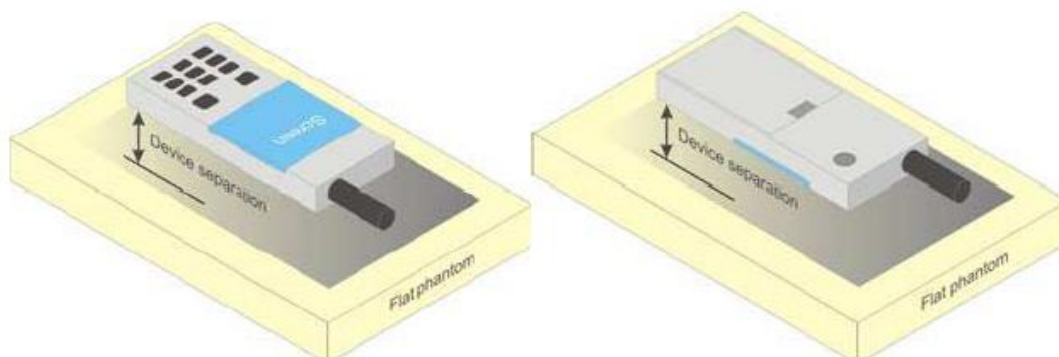

Picture D.4 Test positions for body-worn devices

D.3 Desktop device

A typical example of a desktop device is a wireless enabled desktop computer placed on a table or desk when used.

The DUT shall be positioned at the distance and in the orientation to the phantom that corresponds to the intended use as specified by the manufacturer in the user instructions. For devices that employ an external antenna with variable positions, tests shall be performed for all antenna positions specified. Picture 8.5 show positions for desktop device SAR tests. If the intended use is not specified, the device shall be tested directly against the flat phantom.

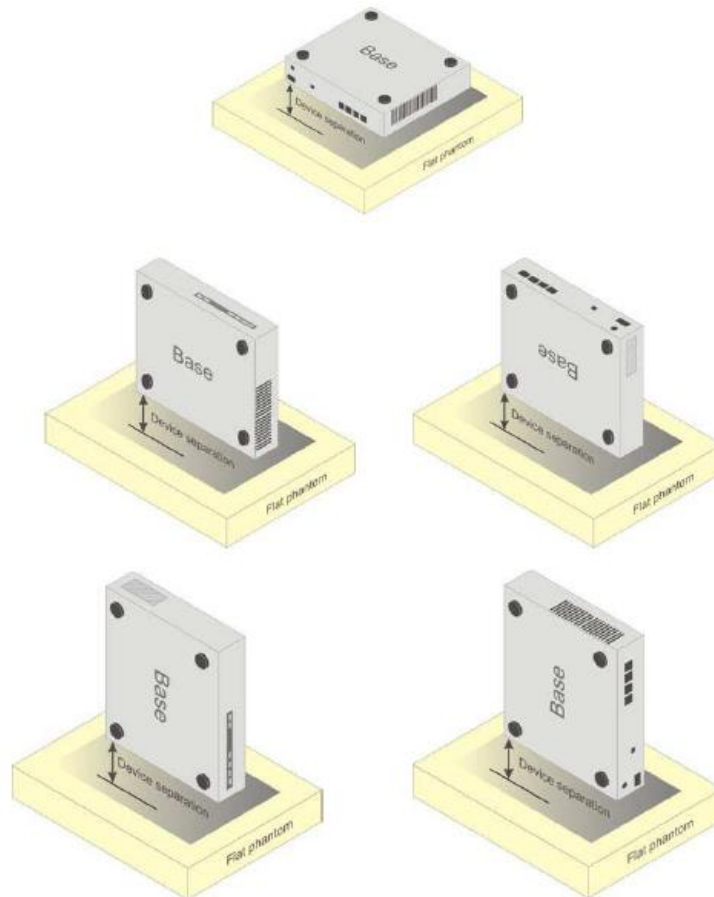

Picture D.5 Test positions for desktop devices

D.2 DUT Setup Photos



Picture D.3

ANNEX E Equivalent Media Recipes

The liquid used for the frequency range of 800-3000 MHz consisted of water, sugar, salt, preventol, glycol monobutyl and Cellulose. The liquid has been previously proven to be suited for worst-case. The Table E.1 shows the detail solution. It's satisfying the latest tissue dielectric parameters requirements proposed by the IEEE 1528 and IEC 62209.

TableE.1: Composition of the Tissue Equivalent Matter

Frequency (MHz)	835Head	835Body	1900 Head	1900 Body	2450 Head	2450 Body	5800 Head	5800 Body
Ingredients (% by weight)								
Water	41.45	52.5	55.242	69.91	58.79	72.60	65.53	65.53
Sugar	56.0	45.0	\	\	\	\	\	\
Salt	1.45	1.4	0.306	0.13	0.06	0.18	\	\
Preventol	0.1	0.1	\	\	\	\	\	\
Cellulose	1.0	1.0	\	\	\	\	\	\
Glycol Monobutyl	\	\	44.452	29.96	41.15	27.22	\	\
Diethylenglycol monohexylether	\	\	\	\	\	\	17.24	17.24
Triton X-100	\	\	\	\	\	\	17.24	17.24
Dielectric Parameters	$\epsilon=41.5$	$\epsilon=55.2$	$\epsilon=40.0$	$\epsilon=53.3$	$\epsilon=39.2$	$\epsilon=52.7$	$\epsilon=35.3$	$\epsilon=48.2$
Target Value	$\sigma=0.90$	$\sigma=0.97$	$\sigma=1.40$	$\sigma=1.52$	$\sigma=1.80$	$\sigma=1.95$	$\sigma=5.27$	$\sigma=6.00$

Note: There are a little adjustment respectively for 750, 1750, 2600, 5200, 5300 and 5600 based on the recipe of closest frequency in table E.1.

ANNEX F System Validation

The SAR system must be validated against its performance specifications before it is deployed. When SAR probes, system components or software are changed, upgraded or recalibrated, these must be validated with the SAR system(s) that operates with such components.

Table F.1: System Validation for 3617

Probe SN.	Liquid name	Validation date	Frequency point	Status (OK or Not)
3617	Head 750MHz	Feb.17,2020	750 MHz	OK
3617	Head 850MHz	Feb.17,2020	835 MHz	OK
3617	Head 900MHz	Feb.17,2020	900 MHz	OK
3617	Head 1750MHz	Feb.17,2020	1750 MHz	OK
3617	Head 1810MHz	Feb.17,2020	1810 MHz	OK
3617	Head 1900MHz	Feb.18,2020	1900 MHz	OK
3617	Head 2000MHz	Feb.18,2020	2000 MHz	OK
3617	Head 2100MHz	Feb.18,2020	2100 MHz	OK
3617	Head 2300MHz	Feb.18,2020	2300 MHz	OK
3617	Head 2450MHz	Feb.18,2020	2450 MHz	OK
3617	Head 2600MHz	Feb.19,2020	2600 MHz	OK
3617	Head 3500MHz	Feb.19,2020	3500 MHz	OK
3617	Head 3700MHz	Feb.19,2020	3700 MHz	OK
3617	Head 5200MHz	Feb.19,2020	5250 MHz	OK
3617	Head 5500MHz	Feb.19,2020	5600 MHz	OK
3617	Head 5800MHz	Feb.19,2020	5800 MHz	OK
3617	Body 750MHz	Feb.19,2020	750 MHz	OK
3617	Body 850MHz	Feb.20,2020	835 MHz	OK
3617	Body 900MHz	Feb.20,2020	900 MHz	OK
3617	Body 1750MHz	Feb.20,2020	1750 MHz	OK
3617	Body 1810MHz	Feb.20,2020	1810 MHz	OK
3617	Body 1900MHz	Feb.20,2020	1900 MHz	OK
3617	Body 2000MHz	Feb.21,2020	2000 MHz	OK
3617	Body 2100MHz	Feb.21,2020	2100 MHz	OK
3617	Body 2300MHz	Feb.21,2020	2300 MHz	OK
3617	Body 2450MHz	Feb.21,2020	2450 MHz	OK
3617	Body 2600MHz	Feb.21,2020	2600 MHz	OK
3617	Body 3500MHz	Feb.22,2020	3500 MHz	OK
3617	Body 3700MHz	Feb.22,2020	3700 MHz	OK
3617	Body 5200MHz	Feb.22,2020	5250 MHz	OK
3617	Body 5500MHz	Feb.22,2020	5600 MHz	OK
3617	Body 5800MHz	Feb.22,2020	5800 MHz	OK