

Fig.52. Conducted spurious emission: 8DPSK, Channel 0, 3GHz - 10GHz

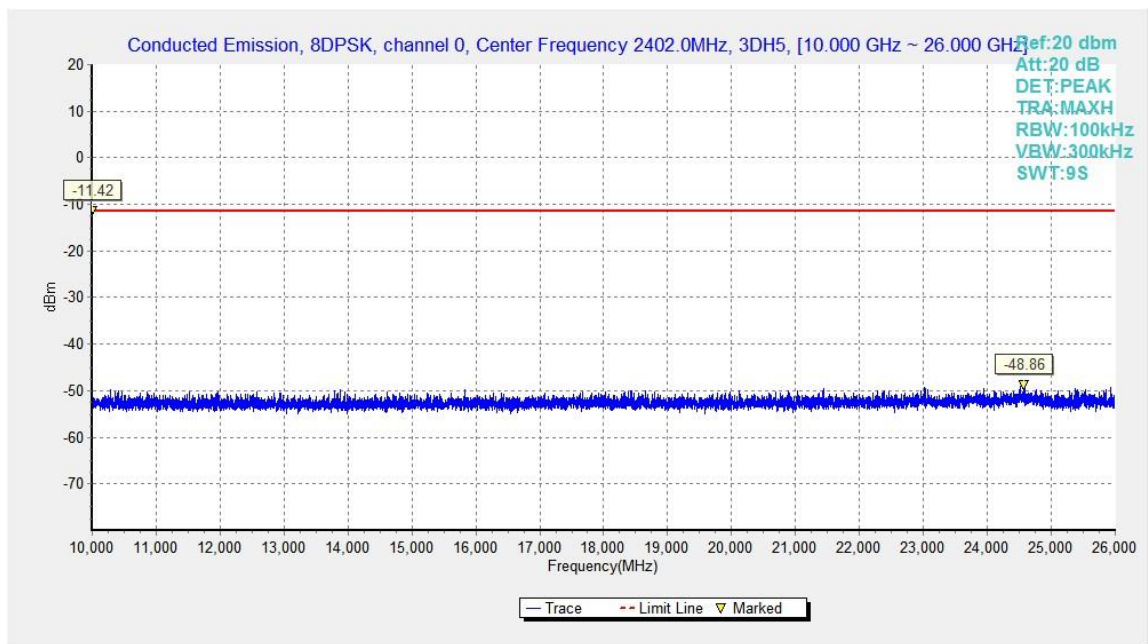

Fig.53. Conducted spurious emission: 8DPSK, Channel 0, 10GHz - 26GHz

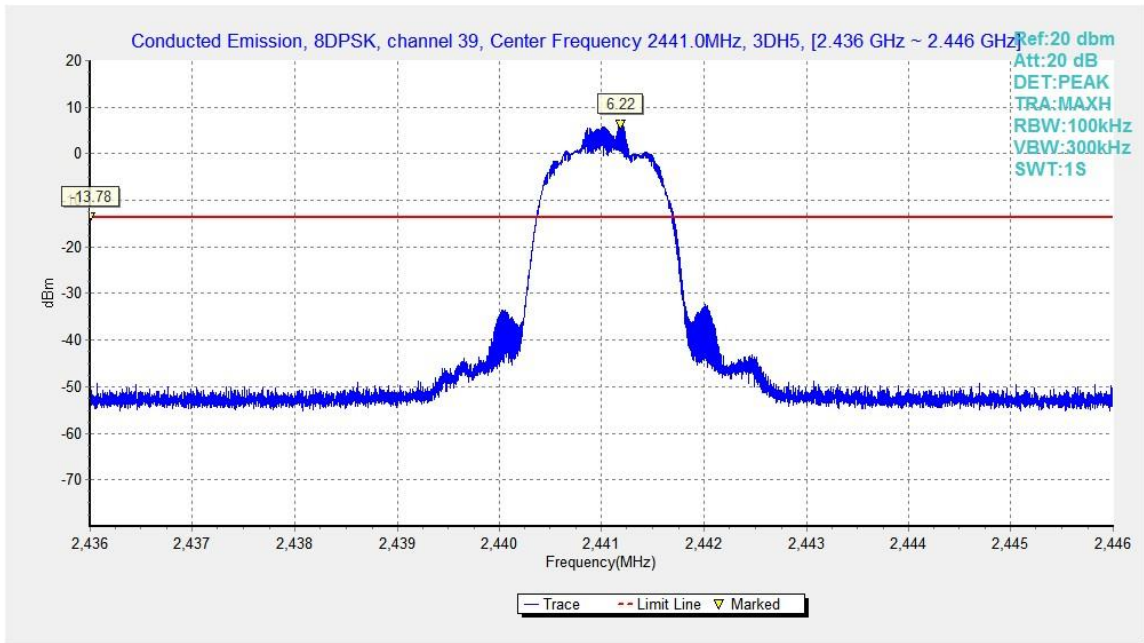

Fig.54. Conducted spurious emission: 8DPSK, Channel 39, 2441MHz

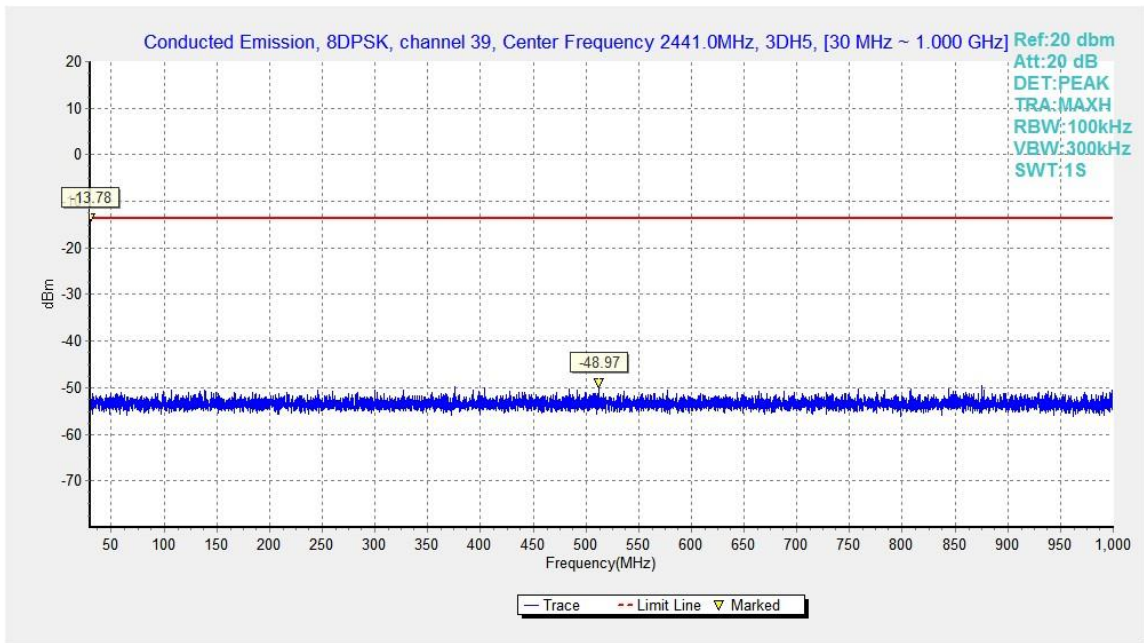

Fig.55. Conducted spurious emission: 8DPSK, Channel 39, 30MHz - 1GHz

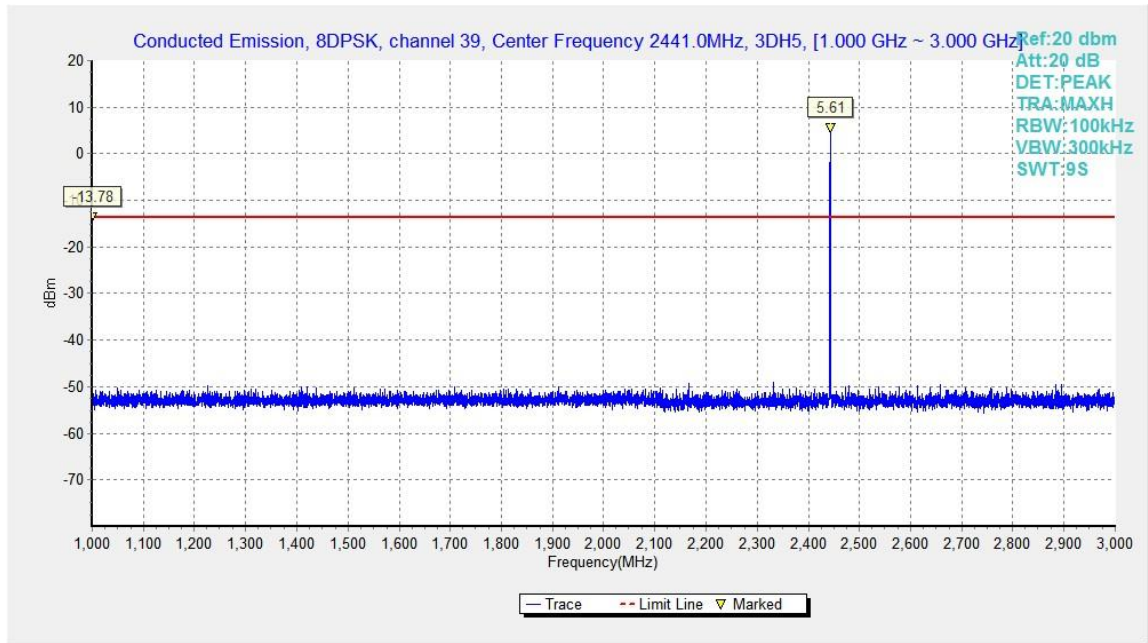

Fig.56. Conducted spurious emission: 8DPSK, Channel 39, 1GHz - 3GHz

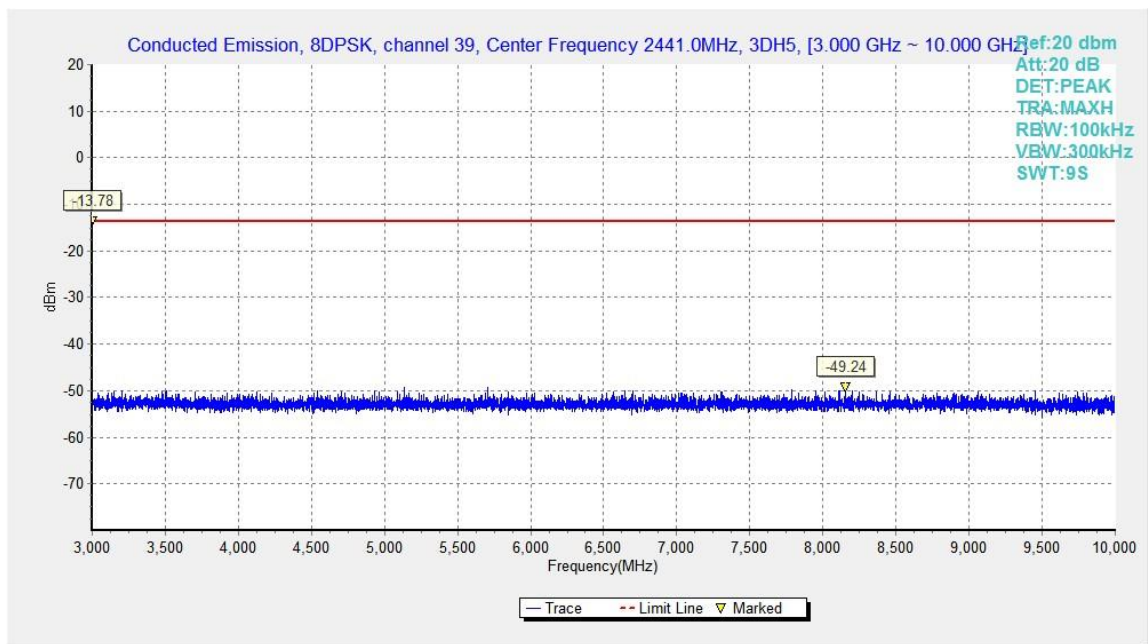

Fig.57. Conducted spurious emission: 8DPSK, Channel 39, 3GHz - 10GHz

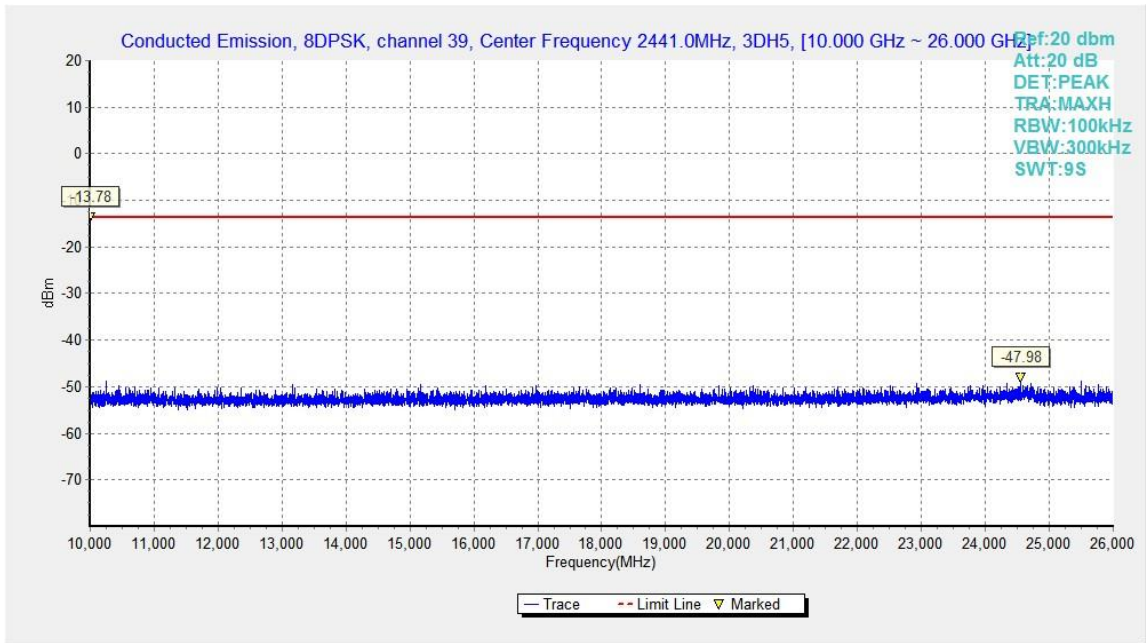

Fig.58. Conducted spurious emission: 8DPSK, Channel 39, 10GHz – 26GHz

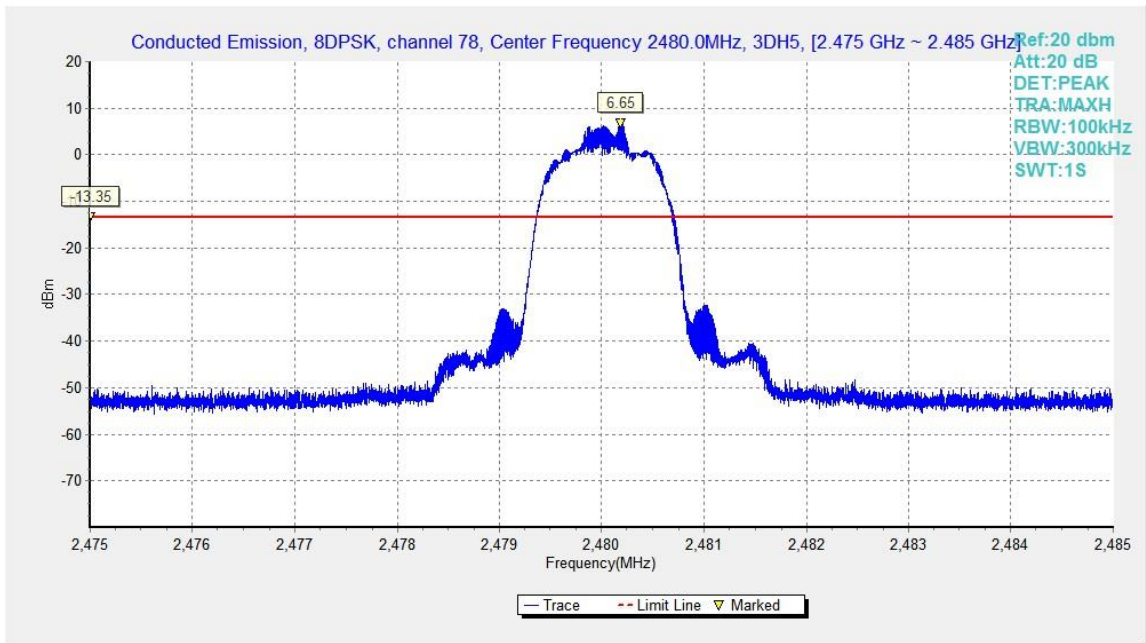

Fig.59. Conducted spurious emission: 8DPSK, Channel 78, 2480MHz

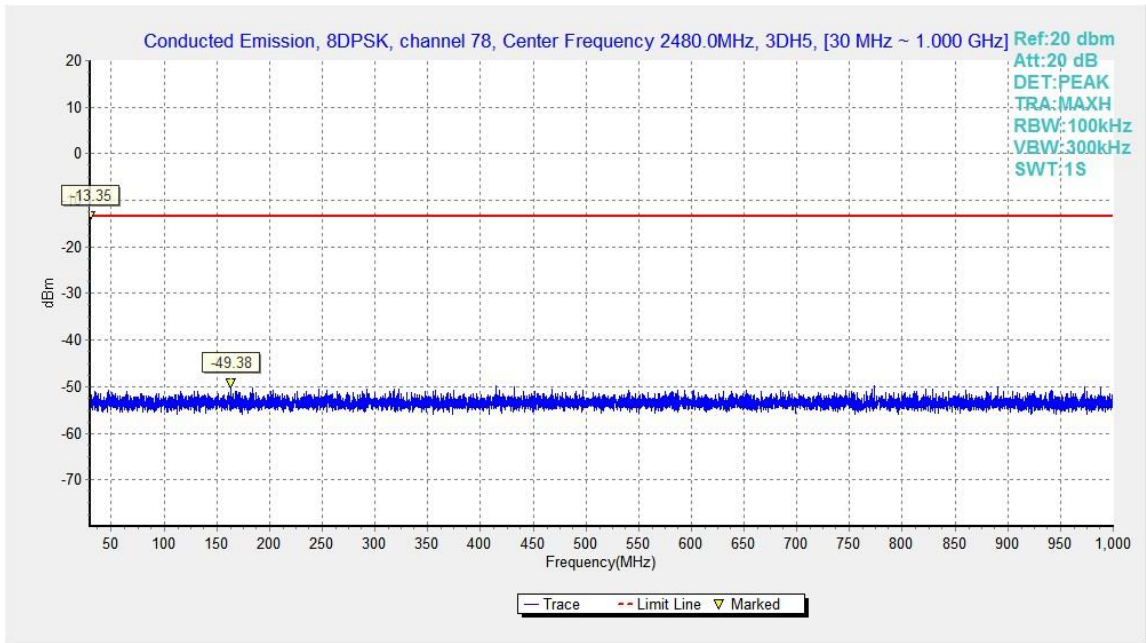

Fig.60. Conducted spurious emission: 8DPSK, Channel 78, 30MHz - 1GHz

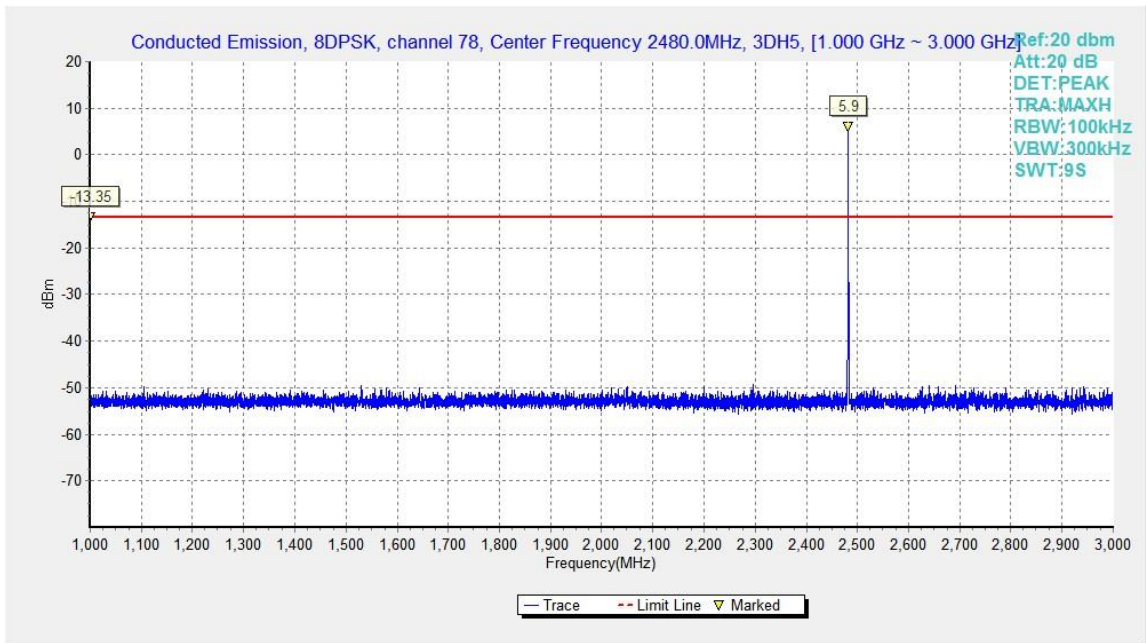

Fig.61. Conducted spurious emission: 8DPSK, Channel 78, 1GHz - 3GHz

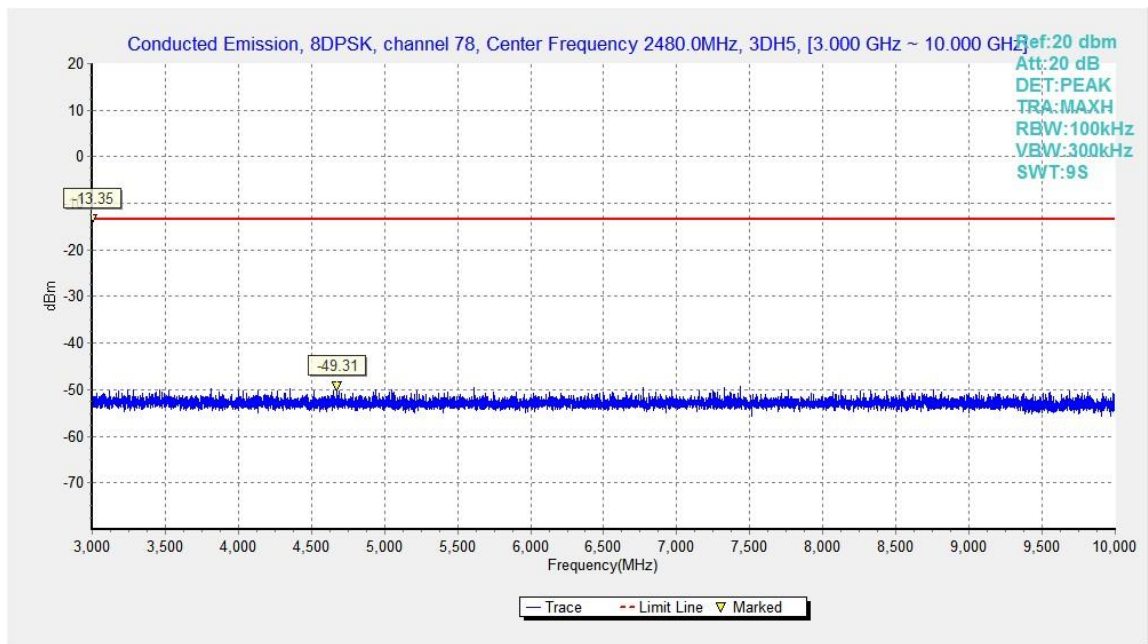

Fig.62. Conducted spurious emission: 8DPSK, Channel 78, 3GHz - 10GHz

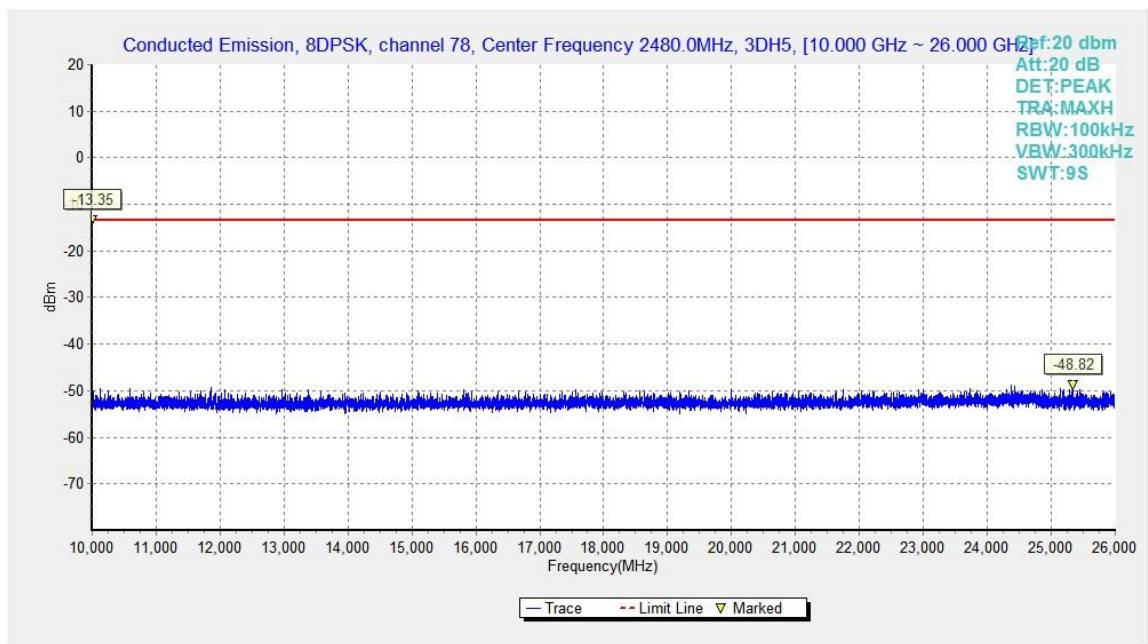

Fig.63. Conducted spurious emission: 8DPSK, Channel 78, 10GHz - 26GHz

B.6. Transmitter Spurious Emission - Radiated

Method of Measurement: See ANSI C63.10-2013-clause 6.4 & 6.5 & 6.6

Measurement Limit:

Standard	Limit
FCC 47 CFR Part 15.247, 15.205, 15.209	20dB below peak output power

radiated emissions which fall in the restricted bands, as defined in § 15.205(a), must also comply with the radiated emission limits specified in § 15.209(a) (see § 15.205(c)).

Limit in restricted band:

Frequency (MHz)	Field strength(μ V/m)	Measurement distance (m)
0.009 - 0.490	2400/F(kHz)	300
0.490 - 1.705	24000/F(kHz)	30
1.705 – 30.0	30	30

Frequency of emission (MHz)	Field strength(μ V/m)	Field strength(dBuV/m)
30-88	100	40
88-216	150	43.5
216-960	200	46
Above 960	500	54

Set up:

Tabletop devices shall be placed on a nonconducting platform with nominal top surface dimensions 1 m by 1.5 m. For emissions testing at or below 1 GHz, the table height shall be 80 cm above the reference ground plane. For emission measurements above 1 GHz, the table height shall be 1.5 m

The EUT and transmitting antenna shall be centered on the turntable.

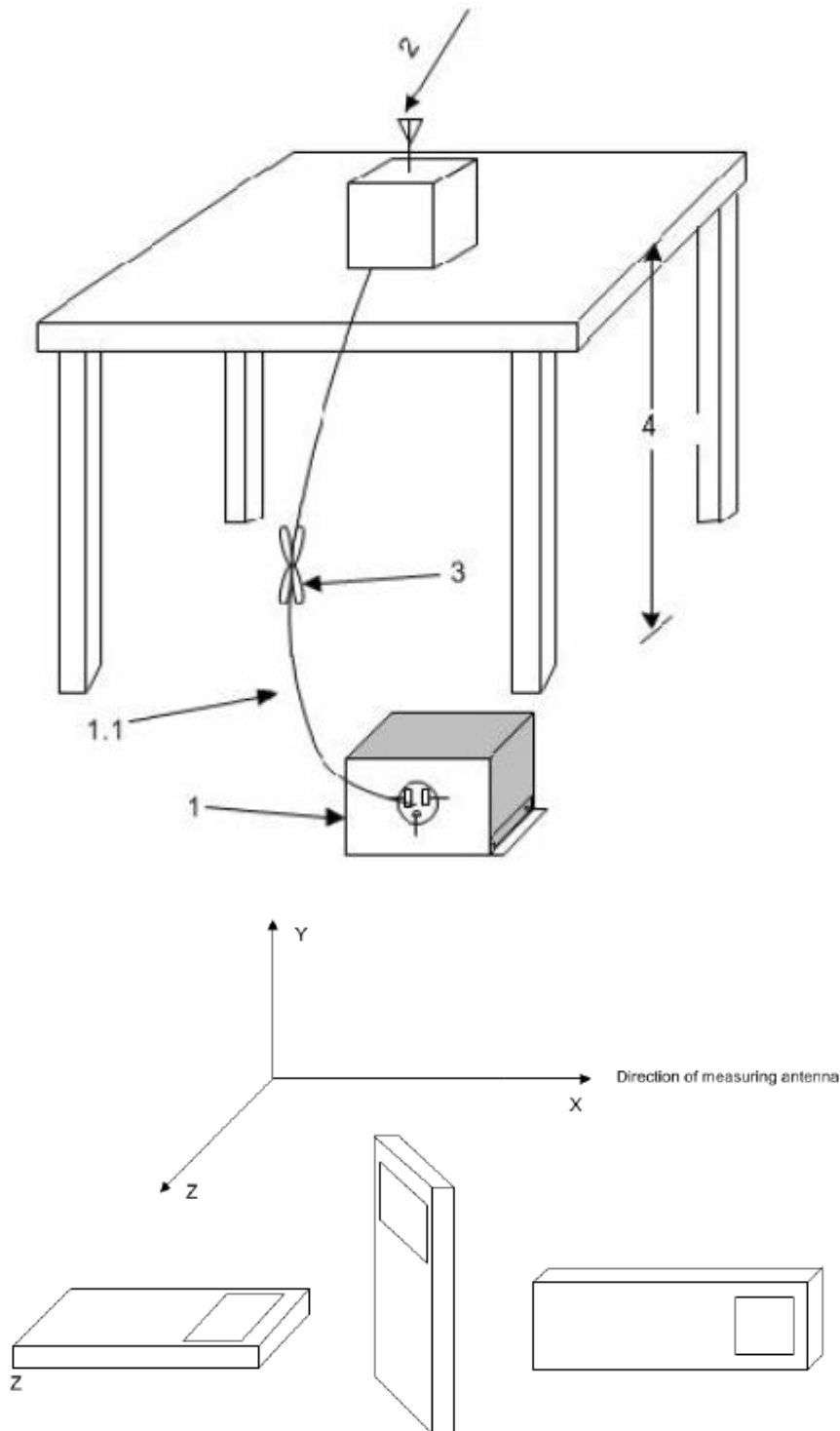

Test Condition

The EUT shall be tested 1 near top, 1 near middle, and 1 near bottom. Set the unlicensed wireless device to operate in continuous transmit mode. For unlicensed wireless devices unable to be configured for 100% duty cycle even in test mode, configure the system for the maximum duty cycle supported.

When required for unlicensed wireless devices, measurements of the variation of the input power or the radiated signal level of the fundamental frequency component of the emission, as appropriate, shall be performed with the supply voltage varied between 85% and 115% of the

nominal rated supply voltage.

Exploratory radiated emissions measurements

Exploratory radiated measurements shall be performed at the measurement distance or at a closer distance than that specified for compliance to determine the emission characteristics of the EUT and, if applicable, the EUT configuration that produces the maximum level of emissions. The frequencies of maximum emission may be determined by manually positioning the antenna close to the EUT, and then moving the antenna over all sides of the EUT while observing a spectral display. It is advantageous to have prior knowledge of the frequencies of emissions, although this may be determined from such a near-field scan. The near-field scan shall only be used to determine the frequency but not the amplitude of the emissions. Where exploratory measurements are not adequate to determine the worst-case operating modes and are used only to identify the frequencies of the highest emissions, additional preliminary tests can be required.

For emissions from the EUT, the maximum level shall be determined by rotating the EUT and its antenna through 0° to 360° . For each mode of operation required to be tested, the frequency spectrum (based on findings from exploratory measurements) shall be monitored.

Broadband antennas and a spectrum analyzer or a radio-noise meter with a panoramic display are often useful in this type of test. If either antenna height or EUT azimuth are not fully measured during exploratory testing, then complete testing can be required at the OATS or semi-anechoic chamber when the final full spectrum testing is performed.

Final radiated emissions measurements

The final measurements are using the orientation and equipment arrangement of the EUT based on the measurement results found during the preliminary (exploratory) measurements, the EUT arrangement, appropriate modulation, and modes of operation that produce the emissions that have the highest amplitude relative to the limit shall be selected for the final measurement.

For each mode of operation required to be tested, the frequency spectrum (based on findings from exploratory measurements) shall be monitored. The highest signal levels relative to the limit shall be determined by rotating the EUT from 0° to 360° and with varying the measurement antenna height between 1 m and 4 m in vertical and horizontal polarizations.

For each mode selected, record the frequency and amplitude of the highest fundamental emission (if applicable), as well as the frequency and amplitude of the six highest spurious emissions relative to the limit. Emissions more than 20 dB below the limit do not need to be reported.

This maximization process was repeated with the EUT positioned in each of its three orthogonal orientations.

The receiver references:

Frequency of emission (MHz)	RBW/VBW	Sweep Time(s)
30-1000	100KHz/300KHz	5
1000-4000	1MHz/3MHz	15
4000-18000	1MHz/3MHz	40
18000-26500	1MHz/3MHz	20

P_{Mea} is the field strength recorded from the instrument.

The measurement results are obtained as described below:

Result= P_{Mea} + Cable Loss + Antenna Factor

Where:

P_{Mea} field strength recorded from the instrument

EUT ID: EUT7

Peak Measurement results

GFSK Ch 0

Frequency (MHz)	Measurement Result (dB μ V/m)	Cable loss (dB)	Antenna Factor (dB/m)	Receiver Reading (dB μ V)	Limit (dB μ V/m)	Margin (dB)	Antenna Pol. (H/V)
17788.000	53.94	-25.50	46.70	32.74	74.00	20.06	H
13666.500	50.96	-29.50	40.40	40.06	74.00	23.04	V
12863.000	48.53	-30.70	39.10	40.03	74.00	25.47	V
4804.000	46.74	-37.30	33.00	50.94	74.00	27.26	H
9146.000	46.35	-33.80	38.10	42.15	74.00	27.65	H
2389.200	56.27	-20.00	28.10	48.27	74.00	17.73	H

GFSK Ch 39

Frequency (MHz)	Measurement Result (dB μ V/m)	Cable loss (dB)	Antenna Factor (dB/m)	Receiver Reading (dB μ V)	Limit (dB μ V/m)	Margin (dB)	Antenna Pol. (H/V)
17685.500	53.04	-25.70	46.00	32.84	74.00	20.96	V
14172.500	50.34	-29.00	42.00	37.34	74.00	23.66	V
12816.000	48.34	-30.70	39.10	39.84	74.00	25.66	H
9676.500	46.36	-33.00	38.00	41.36	74.00	27.64	V
7437.500	44.59	-35.20	36.70	42.99	74.00	29.41	H
4881.500	42.75	-37.20	33.20	46.75	74.00	31.25	H

GFSK Ch 78

Frequency (MHz)	Measurement Result (dB μ V/m)	Cable loss (dB)	Antenna Factor (dB/m)	Receiver Reading (dB μ V)	Limit (dB μ V/m)	Margin (dB)	Antenna Pol. (H/V)
17450.500	52.99	-26.90	45.20	34.59	74.00	21.01	V
13585.500	50.78	-29.50	40.40	39.88	74.00	23.22	V
12775.500	48.16	-30.70	39.10	39.66	74.00	25.84	V
9026.500	45.71	-33.80	38.10	41.31	74.00	28.29	H
4960.000	45.61	-37.10	33.30	49.41	74.00	28.39	H
2485.000	62.29	-20.00	28.30	53.99	74.00	11.71	H

$\pi/4$ DQPSK Ch 0

Frequency (MHz)	Measurement Result (dB μ V/m)	Cable loss (dB)	Antenna Factor (dB/m)	Receiver Reading (dB μ V)	Limit (dB μ V/m)	Margin (dB)	Antenna Pol. (H/V)
17753.500	52.72	-25.50	46.70	31.52	74.00	21.28	V
13805.000	50.78	-29.10	40.90	38.98	74.00	23.22	V
12802.500	48.73	-30.70	39.10	40.23	74.00	25.27	H
9701.000	46.09	-33.00	38.00	41.09	74.00	27.91	H
7435.500	44.82	-35.20	36.70	43.22	74.00	29.18	H
2351.600	54.97	-20.10	28.00	47.07	74.00	19.03	H

 $\pi/4$ DQPSK Ch 39

Frequency (MHz)	Measurement Result (dB μ V/m)	Cable loss (dB)	Antenna Factor (dB/m)	Receiver Reading (dB μ V)	Limit (dB μ V/m)	Margin (dB)	Antenna Pol. (H/V)
17808.000	52.91	-25.50	46.70	31.71	74.00	21.09	H
13577.500	50.54	-29.50	40.40	39.64	74.00	23.46	V
12852.500	48.37	-30.70	39.10	39.87	74.00	25.63	H
8654.000	45.83	-34.40	37.90	42.23	74.00	28.17	H
7148.000	45.04	-35.40	36.30	44.14	74.00	28.96	H
4536.500	39.76	-37.30	32.50	44.56	74.00	34.24	H

 $\pi/4$ DQPSK Ch 78

Frequency (MHz)	Measurement Result (dB μ V/m)	Cable loss (dB)	Antenna Factor (dB/m)	Receiver Reading (dB μ V)	Limit (dB μ V/m)	Margin (dB)	Antenna Pol. (H/V)
17824.000	52.85	-25.50	46.70	31.65	74.00	21.15	H
13605.000	50.28	-29.50	40.40	39.38	74.00	23.72	H
12911.000	48.21	-30.50	39.20	39.51	74.00	25.79	V
9238.500	46.18	-33.70	38.00	41.88	74.00	27.82	H
7239.000	44.76	-35.50	36.40	43.86	74.00	29.24	V
2487.200	56.12	-20.00	28.30	47.82	74.00	17.88	H

8DPSK Ch 0

Frequency (MHz)	Measurement Result (dB μ V/m)	Cable loss (dB)	Antenna Factor (dB/m)	Receiver Reading (dB μ V)	Limit (dB μ V/m)	Margin (dB)	Antenna Pol. (H/V)
17402.000	53.11	-26.90	45.20	34.71	74.00	20.89	V
13615.000	50.69	-29.50	40.40	39.79	74.00	23.31	V
12855.500	48.50	-30.70	39.10	40.00	74.00	25.50	H
9854.500	46.33	-33.50	38.00	41.83	74.00	27.67	H
7890.500	44.78	-34.90	37.10	42.58	74.00	29.22	V
2363.700	55.18	-20.10	28.00	47.18	74.00	18.82	V

8DPSK Ch 39

Frequency (MHz)	Measurement Result (dB μ V/m)	Cable loss (dB)	Antenna Factor (dB/m)	Receiver Reading (dB μ V)	Limit (dB μ V/m)	Margin (dB)	Antenna Pol. (H/V)
17656.000	52.97	-25.70	46.00	32.77	74.00	21.03	V
13573.000	51.13	-29.50	40.40	40.23	74.00	22.87	H
12860.500	48.40	-30.70	39.10	39.90	74.00	25.60	V
9692.500	47.27	-33.00	38.00	42.27	74.00	26.73	V
7649.000	44.49	-34.70	36.90	42.19	74.00	29.51	V
4806.500	39.72	-37.30	33.00	43.92	74.00	34.28	V

8DPSK Ch 78

Frequency (MHz)	Measurement Result (dB μ V/m)	Cable loss (dB)	Antenna Factor (dB/m)	Receiver Reading (dB μ V)	Limit (dB μ V/m)	Margin (dB)	Antenna Pol. (H/V)
17288.000	52.92	-25.90	44.40	34.52	74.00	21.08	H
14315.500	51.12	-28.40	42.30	37.22	74.00	22.88	V
12845.500	48.94	-30.70	39.10	40.44	74.00	25.06	H
9220.500	46.44	-33.70	38.00	42.14	74.00	27.56	H
7833.500	44.86	-35.10	37.00	42.96	74.00	29.14	V
2485.100	55.89	-20.00	28.30	47.59	74.00	18.11	H

Average Measurement results
GFSK Ch 0

Frequency (MHz)	Measurement Result (dBμV/m)	Cable loss (dB)	Antenna Factor (dB/m)	Receiver Reading (dBμV)	Limit (dBμV/m)	Margin (dB)	Antenna Pol. (H/V)
4804.000	43.29	-37.30	33.00	47.49	54.00	10.71	H
17772.000	41.40	-25.50	46.70	20.20	54.00	12.60	H
13607.500	39.00	-29.50	40.40	28.10	54.00	15.00	V
12855.500	36.99	-30.70	39.10	28.49	54.00	17.01	V
9037.000	34.48	-33.80	38.10	30.08	54.00	19.52	H
2363.000	41.54	-20.10	28.00	33.54	54.00	12.46	H

GFSK Ch 39

Frequency (MHz)	Measurement Result (dBμV/m)	Cable loss (dB)	Antenna Factor (dB/m)	Receiver Reading (dBμV)	Limit (dBμV/m)	Margin (dB)	Antenna Pol. (H/V)
17690.500	41.37	-25.70	46.00	21.17	54.00	12.63	H
13598.000	38.97	-29.50	40.40	28.07	54.00	15.03	V
4882.000	37.70	-37.20	33.20	41.70	54.00	16.30	H
12867.000	37.05	-30.70	39.10	28.55	54.00	16.95	V
9228.500	34.69	-33.70	38.00	30.39	54.00	19.31	H
7999.500	33.31	-34.80	37.10	31.01	54.00	20.69	V

GFSK Ch 78

Frequency (MHz)	Measurement Result (dBμV/m)	Cable loss (dB)	Antenna Factor (dB/m)	Receiver Reading (dBμV)	Limit (dBμV/m)	Margin (dB)	Antenna Pol. (H/V)
15147.000	45.01	-27.50	39.60	32.91	54.00	8.99	H
4960.000	40.98	-37.10	33.30	44.78	54.00	13.02	H
13597.500	39.42	-29.50	40.40	28.52	54.00	14.58	H
12855.500	36.84	-30.70	39.10	28.34	54.00	17.16	V
9239.000	34.53	-33.70	38.00	30.23	54.00	19.47	V
2485.500	42.03	-20.00	28.30	33.73	54.00	11.97	H

$\pi/4$ DQPSK Ch 0

Frequency (MHz)	Measurement Result (dB μ V/m)	Cable loss (dB)	Antenna Factor (dB/m)	Receiver Reading (dB μ V)	Limit (dB μ V/m)	Margin (dB)	Antenna Pol. (H/V)
17959.500	41.27	-25.50	46.70	20.07	54.00	12.73	H
13582.500	39.31	-29.50	40.40	28.41	54.00	14.69	H
12851.000	36.96	-30.70	39.10	28.46	54.00	17.04	V
4804.000	36.14	-37.30	33.00	40.34	54.00	17.86	H
9131.000	34.47	-33.80	38.10	30.27	54.00	19.53	H
2382.700	41.58	-20.00	28.10	33.58	54.00	12.42	V

 $\pi/4$ DQPSK Ch 39

Frequency (MHz)	Measurement Result (dB μ V/m)	Cable loss (dB)	Antenna Factor (dB/m)	Receiver Reading (dB μ V)	Limit (dB μ V/m)	Margin (dB)	Antenna Pol. (H/V)
17396.000	41.34	-26.90	45.20	22.94	54.00	12.66	V
13578.500	39.13	-29.50	40.40	28.23	54.00	14.87	V
12852.500	36.95	-30.70	39.10	28.45	54.00	17.05	H
9139.500	34.43	-33.80	38.10	30.23	54.00	19.57	V
7219.500	33.18	-35.50	36.40	32.28	54.00	20.82	H
4882.000	30.88	-37.20	33.20	34.88	54.00	23.12	H

 $\pi/4$ DQPSK Ch 78

Frequency (MHz)	Measurement Result (dB μ V/m)	Cable loss (dB)	Antenna Factor (dB/m)	Receiver Reading (dB μ V)	Limit (dB μ V/m)	Margin (dB)	Antenna Pol. (H/V)
17790.000	41.33	-25.50	46.70	20.13	54.00	12.67	H
13643.500	39.16	-29.50	40.40	28.26	54.00	14.84	V
12851.000	36.78	-30.70	39.10	28.28	54.00	17.22	V
9040.500	34.42	-33.80	38.10	30.02	54.00	19.58	H
4959.500	33.35	-37.10	33.30	37.15	54.00	20.65	H
2498.000	42.01	-20.00	28.40	33.61	54.00	11.99	V

8DPSK Ch 0

Frequency (MHz)	Measurement Result (dBμV/m)	Cable loss (dB)	Antenna Factor (dB/m)	Receiver Reading (dBμV)	Limit (dBμV/m)	Margin (dB)	Antenna Pol. (H/V)
17699.000	41.55	-25.70	46.00	21.35	54.00	12.45	H
13669.000	39.16	-29.50	40.40	28.26	54.00	14.84	H
12872.000	37.18	-30.70	39.10	28.68	54.00	16.82	V
4804.000	35.30	-37.30	33.00	39.50	54.00	18.70	H
9144.500	34.66	-33.80	38.10	30.46	54.00	19.34	V
2385.000	41.59	-20.00	28.10	33.59	54.00	12.41	H

8DPSK Ch 39

Frequency (MHz)	Measurement Result (dBμV/m)	Cable loss (dB)	Antenna Factor (dB/m)	Receiver Reading (dBμV)	Limit (dBμV/m)	Margin (dB)	Antenna Pol. (H/V)
17696.500	41.47	-25.70	46.00	21.27	54.00	12.53	H
13584.000	39.20	-29.50	40.40	28.30	54.00	14.80	V
12865.500	36.67	-30.70	39.10	28.17	54.00	17.33	H
9132.500	34.60	-33.80	38.10	30.40	54.00	19.40	V
7902.000	33.53	-34.90	37.10	31.33	54.00	20.47	V
4882.000	31.81	-37.20	33.20	35.81	54.00	22.19	H

8DPSK Ch 78

Frequency (MHz)	Measurement Result (dBμV/m)	Cable loss (dB)	Antenna Factor (dB/m)	Receiver Reading (dBμV)	Limit (dBμV/m)	Margin (dB)	Antenna Pol. (H/V)
17994.000	41.67	-25.50	46.70	20.47	54.00	12.33	H
13605.000	39.18	-29.50	40.40	28.28	54.00	14.82	H
12846.500	37.09	-30.70	39.10	28.59	54.00	16.91	H
9145.000	34.46	-33.80	38.10	30.26	54.00	19.54	H
7223.000	33.52	-35.50	36.40	32.62	54.00	20.48	H
2485.100	41.97	-20.00	28.30	33.67	54.00	12.03	H

Conclusion: Pass

Sample calculation: 17994.000 MHz

$$\text{Peak ERP(dBm)} = P_{\text{Mea}}(20.47\text{dBuV/m}) + \text{Cable Loss}(-25.50) + \text{Antenna Factor}(46.70) = 41.67 \text{ dBuV/m}$$

B.7. Time of Occupancy (Dwell Time)

Method of Measurement: See ANSI C63.10-clause 7.8.4

The EUT must have its hopping function enabled. Use the following spectrum analyzer settings:

- Span = zero span, centered on a hopping channel
- RBW = 1 MHz
- VBW \geq RBW
- Sweep = as necessary to capture the entire dwell time per hopping channel
- Detector function = peak
- Trace = max hold

Measure a pulse time in time domain at middle frequency and then count the hopping number in 31.6s(which equals with 0.4 multiply 79) of middle frequency ,then multiply the pulse time and hopping number and record them.

Measurement Limit:

Standard	Limit (ms)
FCC 47 CFR Part 15.247(a) (1)(iii)	< 400

Measurement Result:

For GFSK

Channel	Packet	Pulse time (ms)		Number of Transmissions		Dwell Time (ms)	Conclusion
		Fig.	Value	Fig.	Value		
39	DH1	Fig.64	0.37	Fig.65	319	118.03	P
	DH3	Fig.66	1.63	Fig.67	107	174.41	P
	DH5	Fig.68	2.88	Fig.69	60	172.8	P

For $\pi/4$ DQPSK

Channel	Packet	Pulse time (ms)		Number of Transmissions		Dwell Time (ms)	Conclusion
		Fig.	Value	Fig.	Value		
39	2DH1	Fig.70	0.38	Fig.71	320	121.6	P
	2DH3	Fig.72	1.63	Fig.73	110	179.3	P
	2DH5	Fig.74	2.88	Fig.75	64	184.32	P

For 8DPSK

Channel	Packet	Pulse time (ms)		Number of Transmissions		Dwell Time (ms)	Conclusion
39	3DH1	Fig.76	0.38	Fig.77	318	120.84	P
	3DH3	Fig.78	1.63	Fig.79	105	171.15	P
	3DH5	Fig.80	2.88	Fig.81	59	169.92	P

Conclusion: PASS

Test graphs as below:

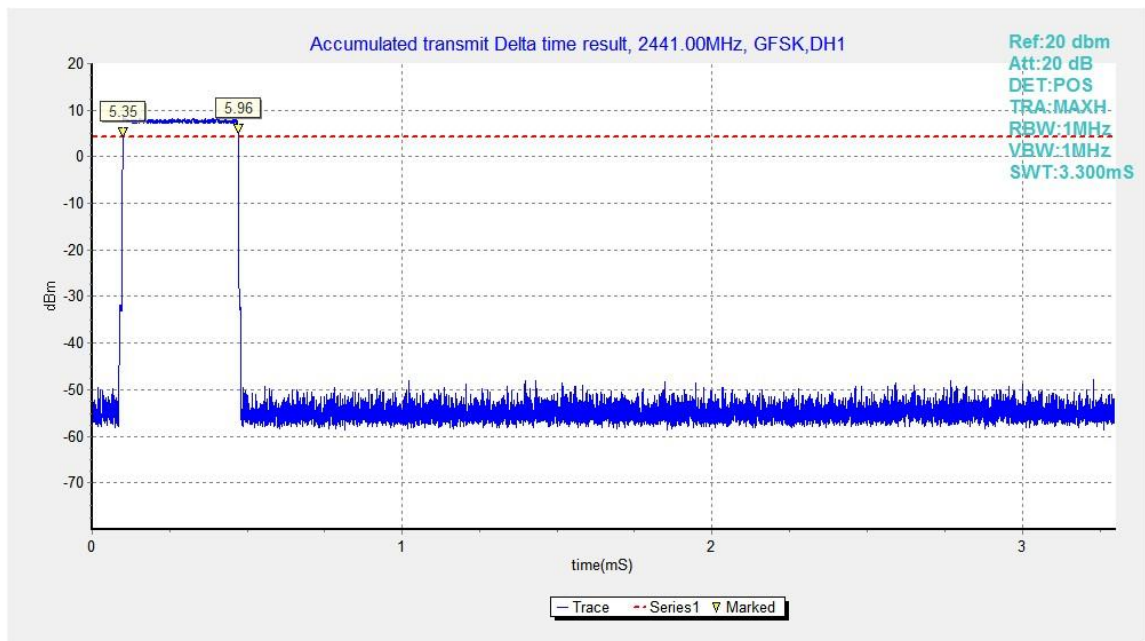

Fig.64. Time of occupancy (Dwell Time): Channel 39, Packet DH1

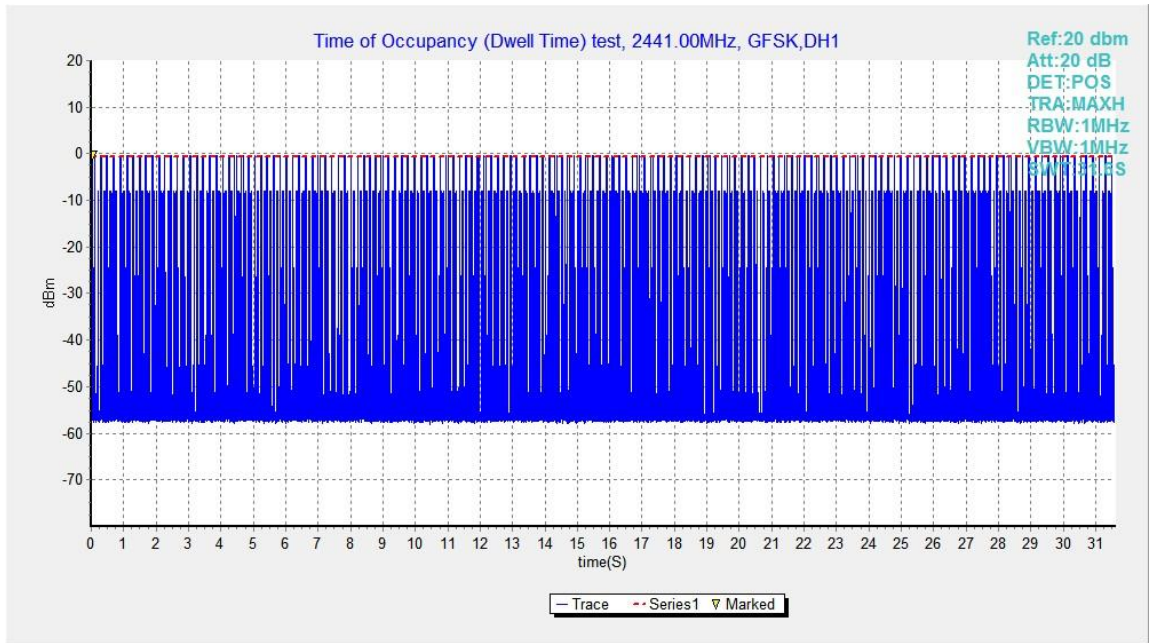

Fig.65. Number of Transmissions Measurement: Channel 39,Packet DH1

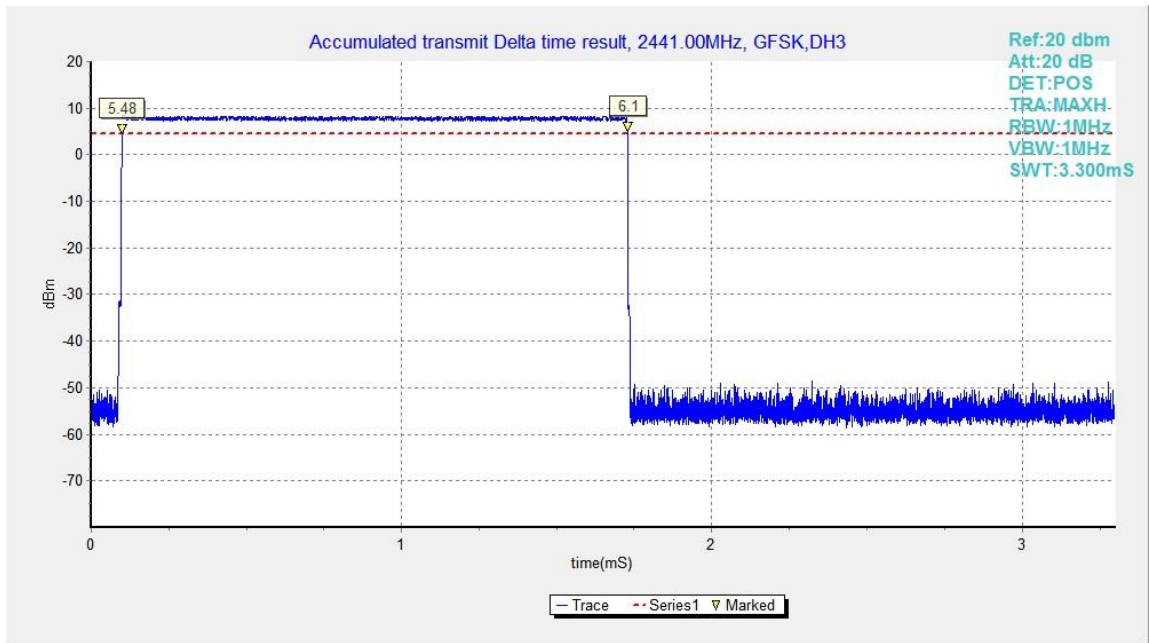

Fig.66. Time of occupancy (Dwell Time): Channel 39, Packet DH3

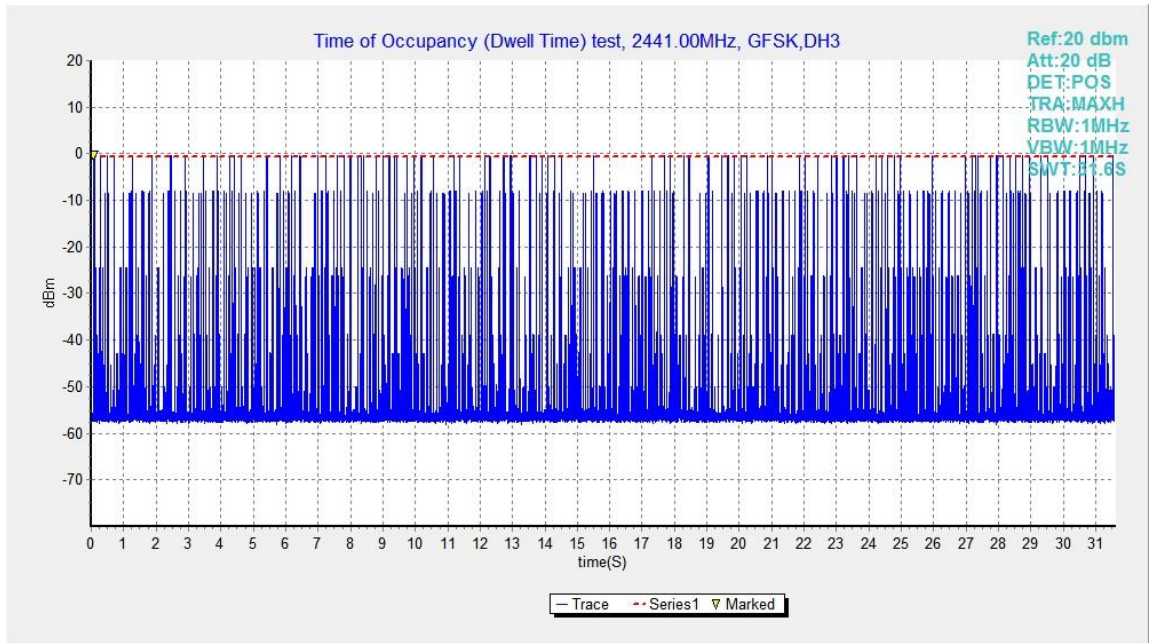

Fig.67. Number of Transmissions Measurement: Channel 39,Packet DH3

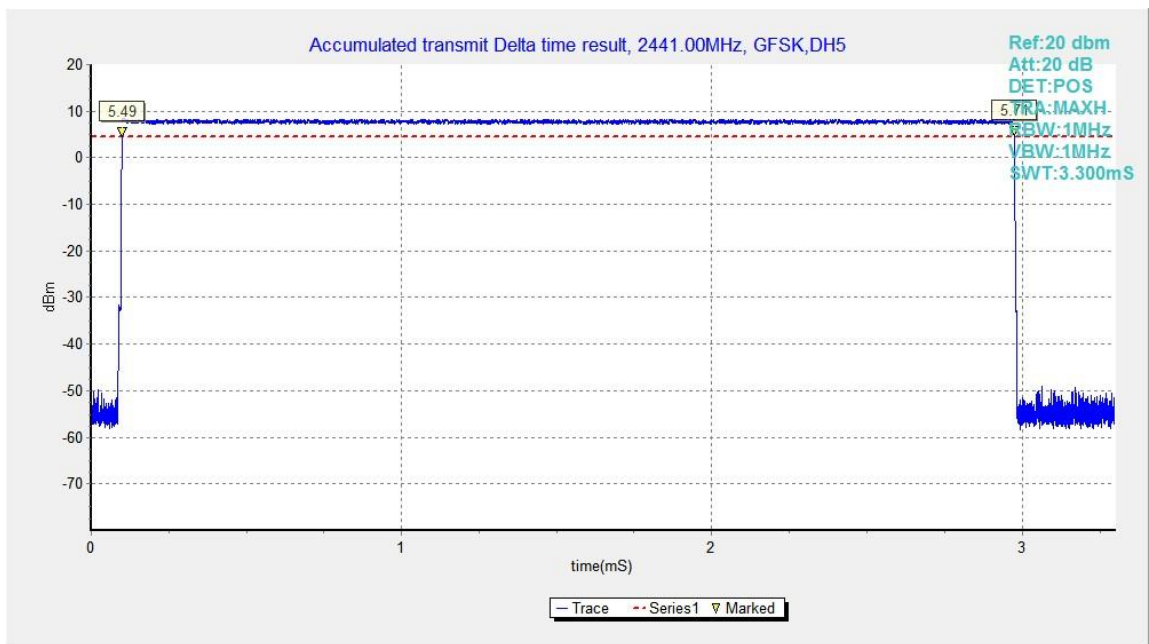

Fig.68. Time of occupancy (Dwell Time): Channel 39, Packet DH5

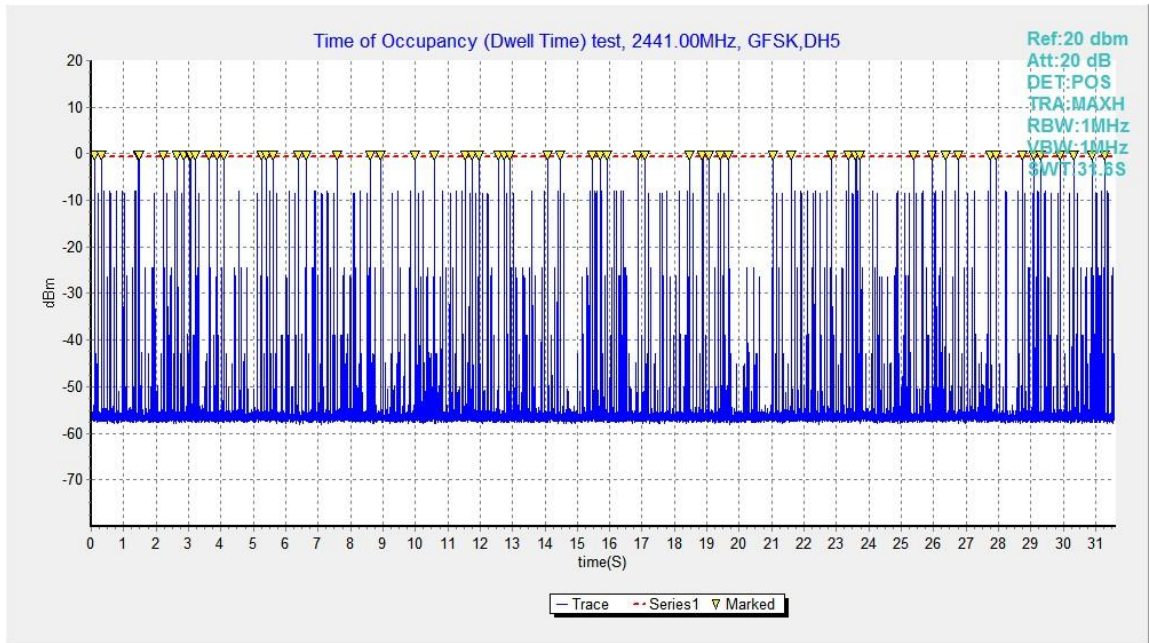

Fig.69. Number of Transmissions Measurement: Channel 39,Packet DH5

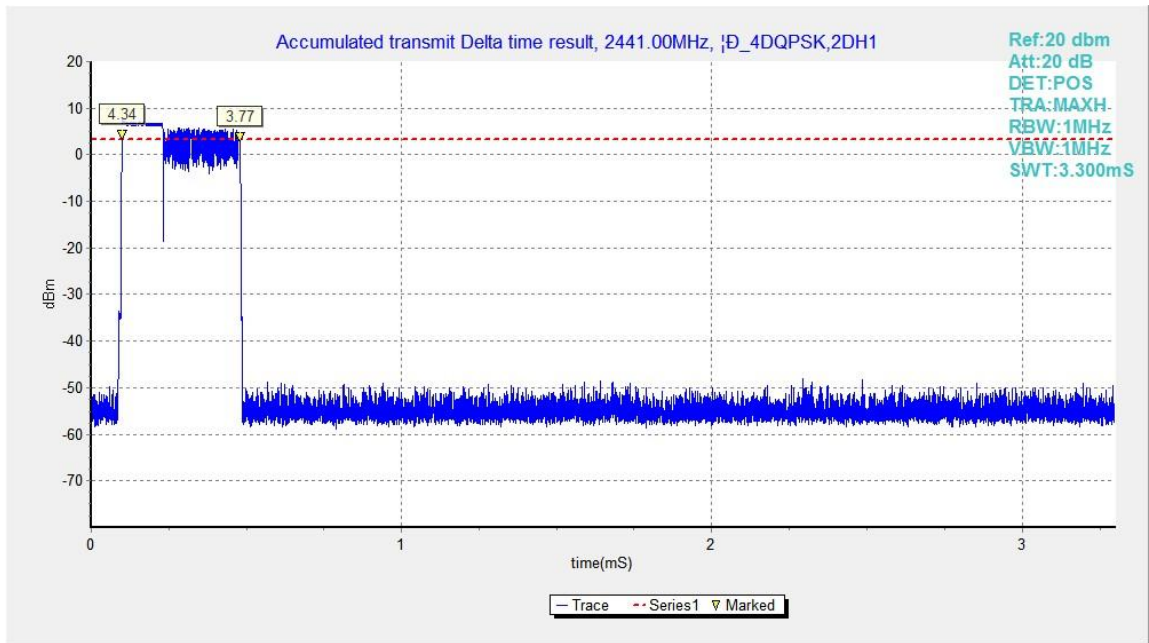

Fig.70. Time of occupancy (Dwell Time): Channel 39, Packet 2-DH1

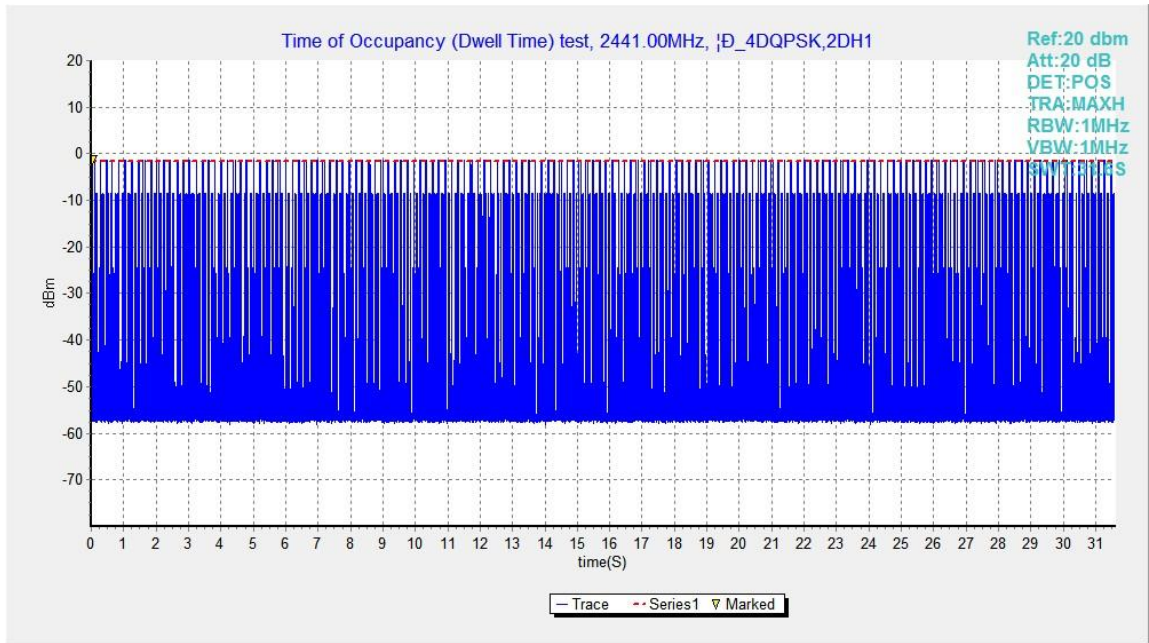

Fig.71. Number of Transmissions Measurement: Channel 39,Packet 2-DH1

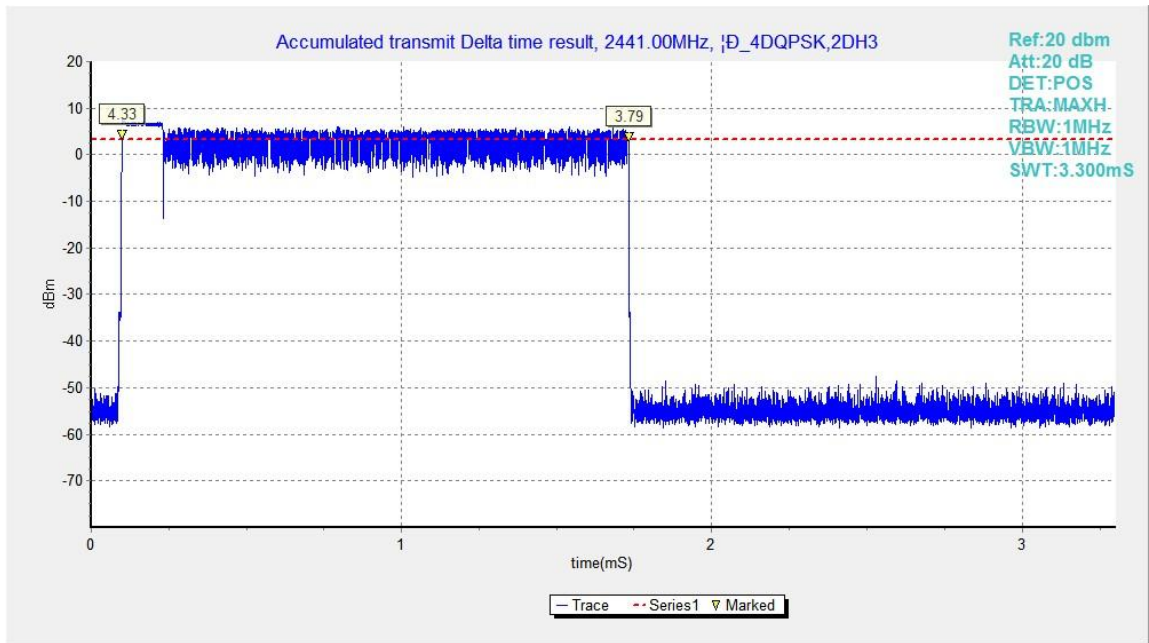

Fig.72. Time of occupancy (Dwell Time): Channel 39, Packet 2-DH3

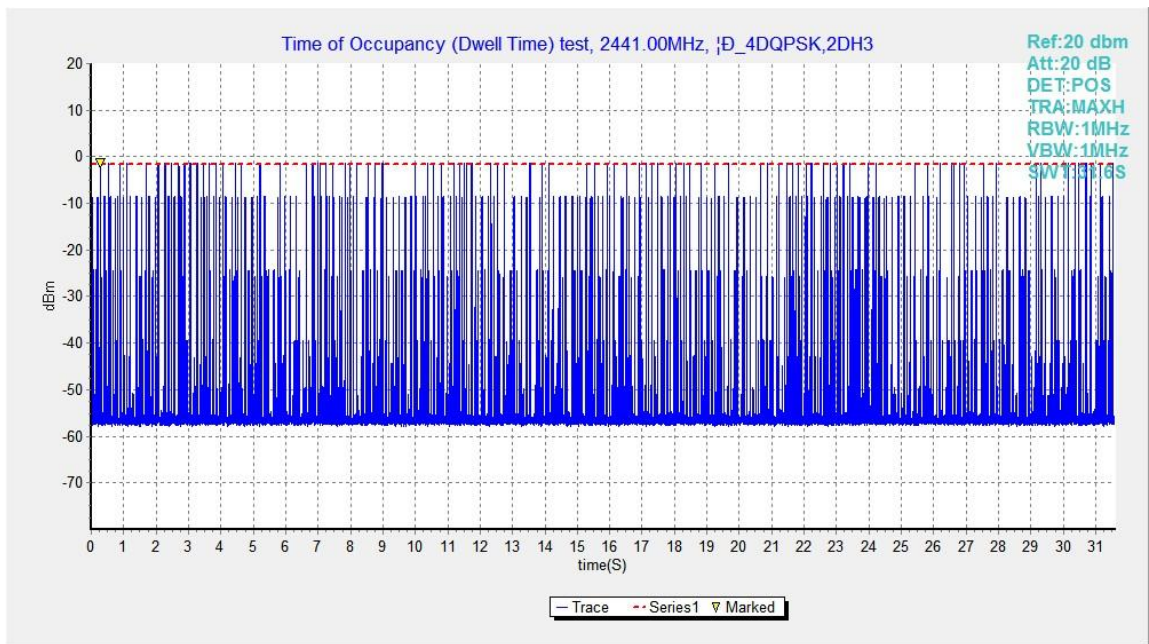

Fig.73. Number of Transmissions Measurement: Channel 39,Packet 2-DH3

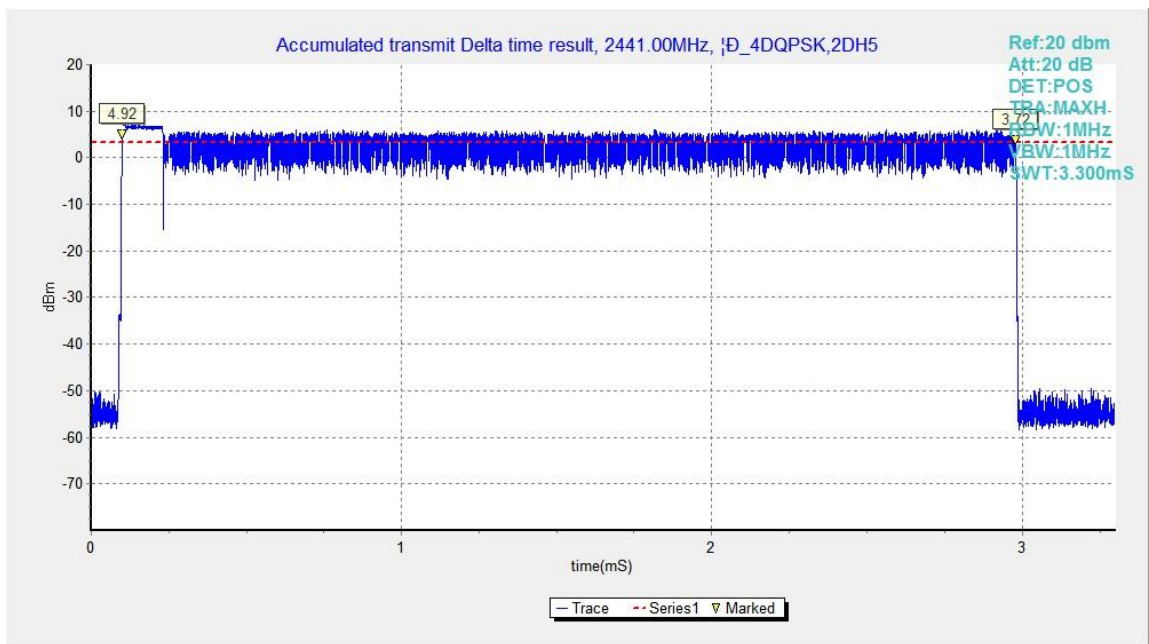

Fig.74. Time of occupancy (Dwell Time): Channel 39, Packet 2-DH5

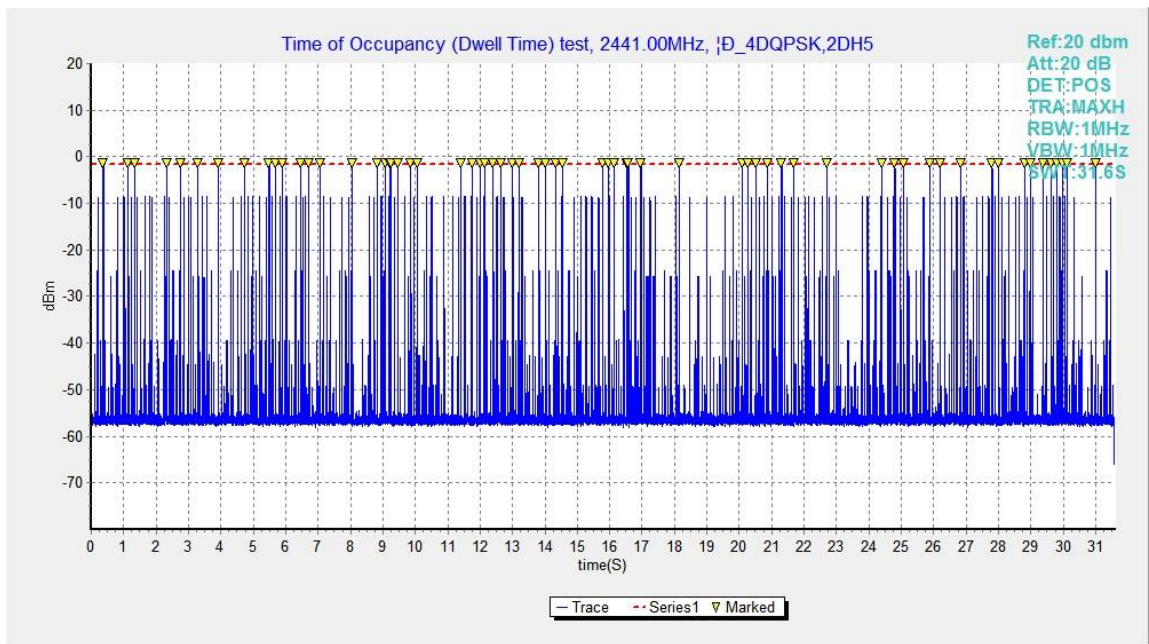

Fig.75. Number of Transmissions Measurement: Channel 39,Packet 2-DH5

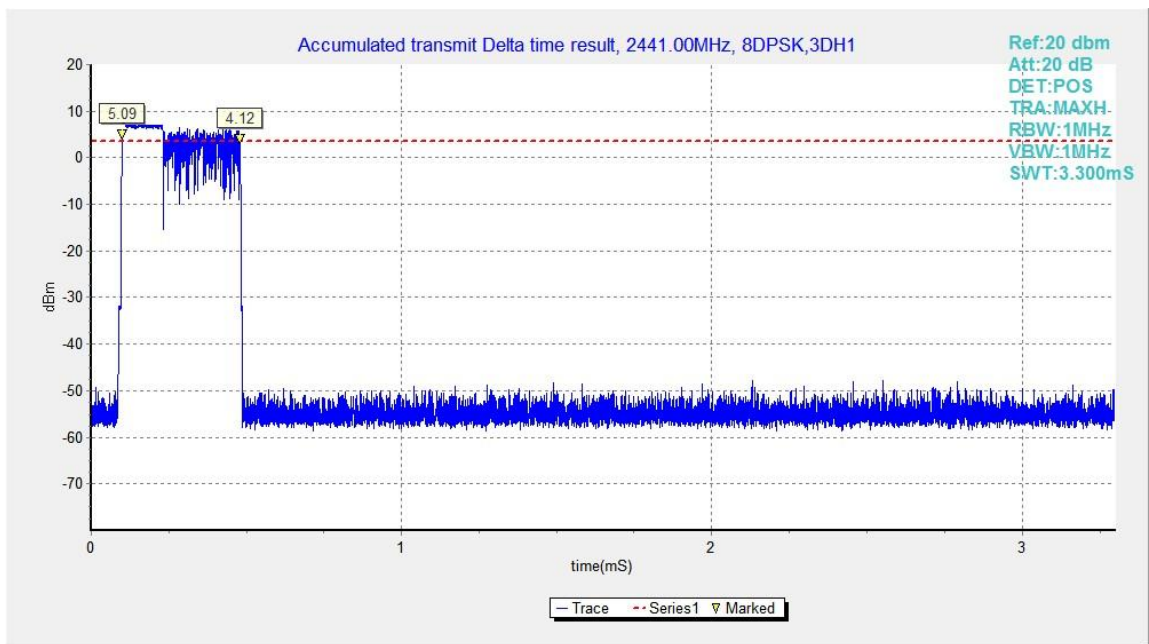

Fig.76. Time of occupancy (Dwell Time): Channel 39, Packet 3-DH1

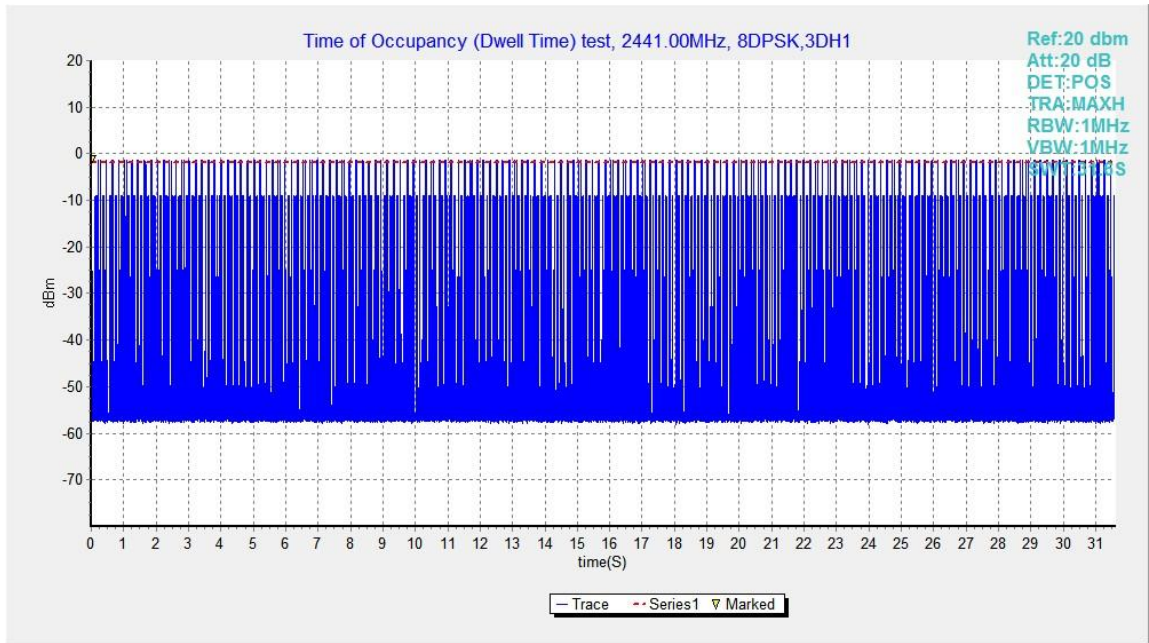

Fig.77. Number of Transmissions Measurement: Channel 39,Packet 3-DH1

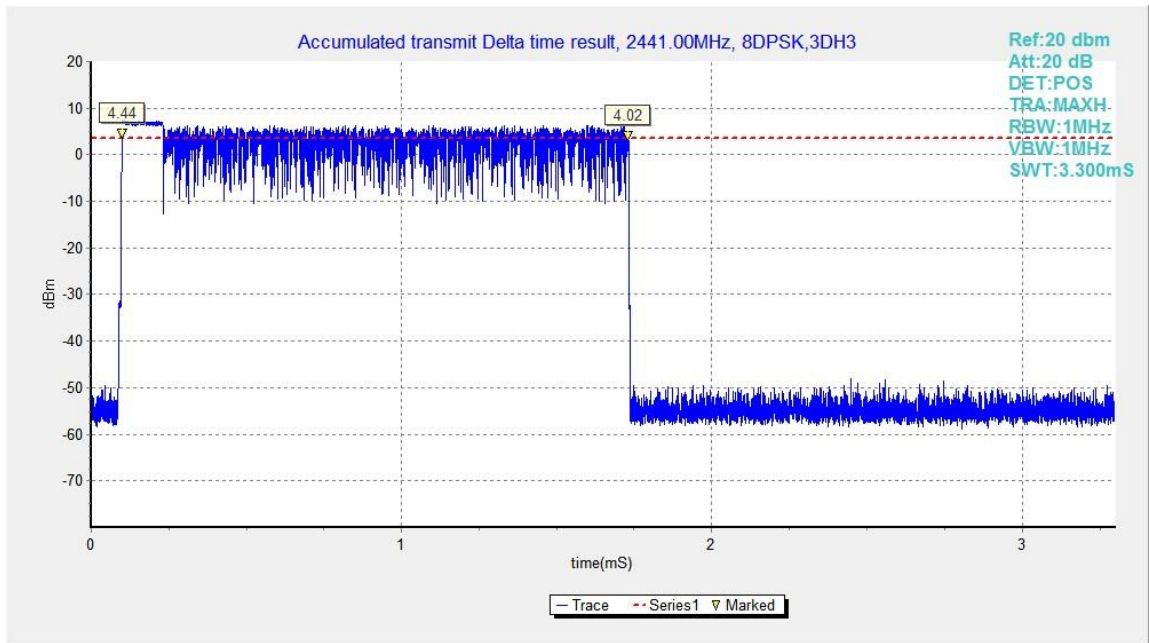

Fig.78. Time of occupancy (Dwell Time): Channel 39, Packet 3-DH3

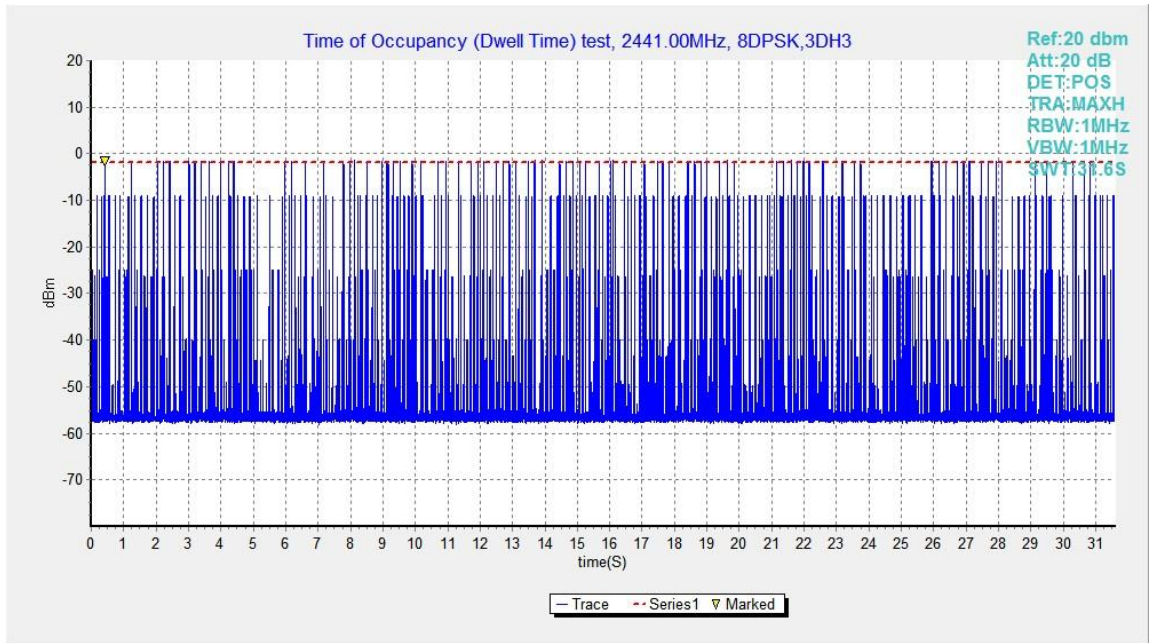

Fig.79. Number of Transmissions Measurement: Channel 39,Packet 3-DH3

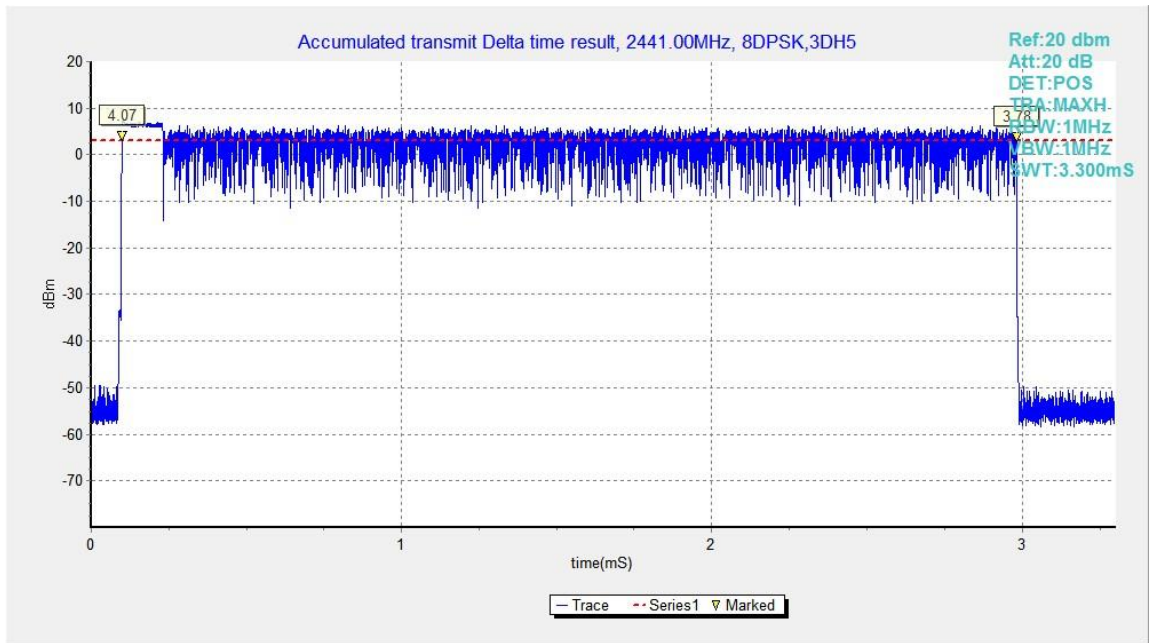

Fig.80. Time of occupancy (Dwell Time): Channel 39, Packet 3-DH5

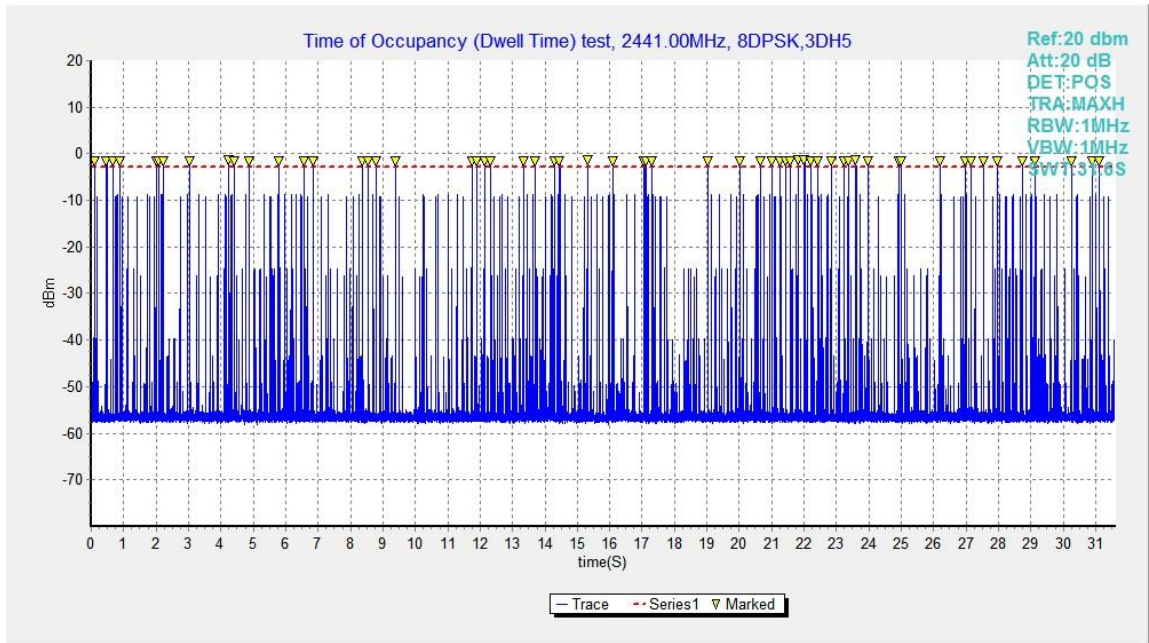

Fig.81. Number of Transmissions Measurement: Channel 39,Packet 3-DH5

B.8. 20dB Bandwidth

Method of Measurement: See ANSI C63.10-clause 6.9.2

Measurement Procedure - Unwanted Emissions

1. Set RBW = 30kHz.
2. Set VBW = 100 kHz.
3. Set span to 3MHz
4. Detector = peak.
5. Trace Mode = max hold.
6. Sweep = auto couple.
7. Allow the trace to stabilize (this may take some time, depending on the extent of the span).

Measurement Limit:

Standard	Limit
FCC 47 CFR Part 15.247(a)(1)	NA *

Use NdB Down function of the SA to measure the 20dB Bandwidth

* Comment: This test case is not required according to the latest FCC 47 CFR Part 15.247. But the test results are necessary for “carrier frequency separation” test case, in Annex A.8.

Measurement Results:

For GFSK

Channel	20dB Bandwidth (kHz)		Conclusion
0	Fig.82	945.00	NA
39	Fig.83	939.75	NA
78	Fig.84	939.75	NA

For $\pi/4$ DQPSK

Channel	20dB Bandwidth (kHz)		Conclusion
0	Fig.85	1251.00	NA
39	Fig.86	1223.25	NA
78	Fig.87	1225.50	NA

For 8DPSK

Channel	20dB Bandwidth (kHz)		Conclusion
0	Fig.88	1274.25	NA
39	Fig.89	1231.50	NA
78	Fig.90	1205.25	NA

Conclusion: NA

Test graphs as below:

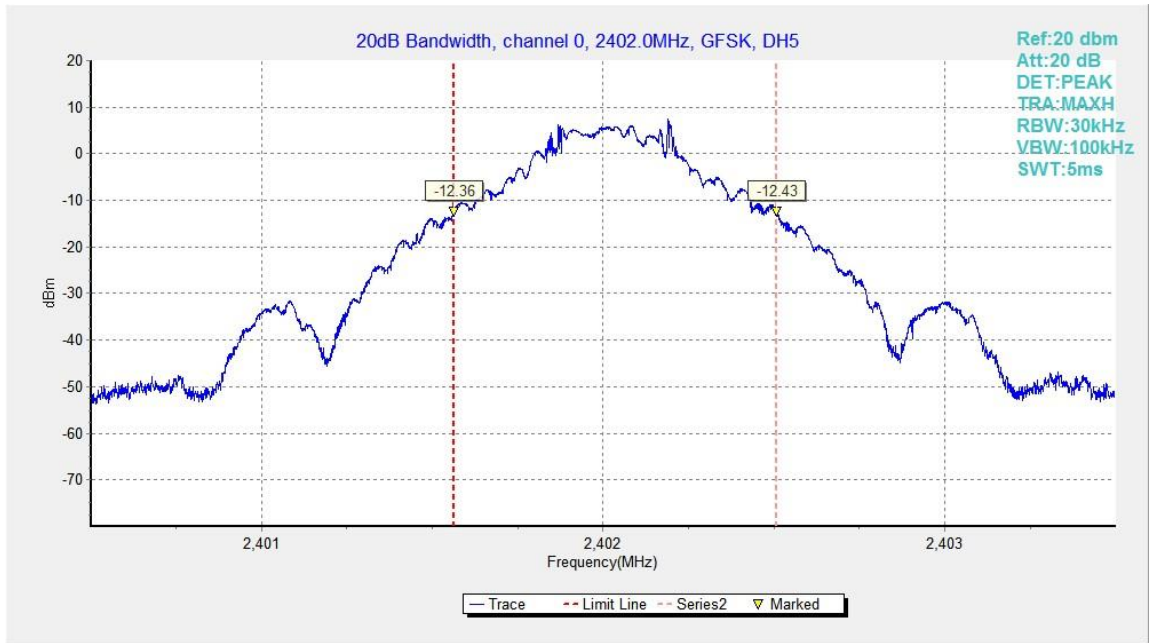

Fig.82. 20dB Bandwidth: GFSK, Channel 0

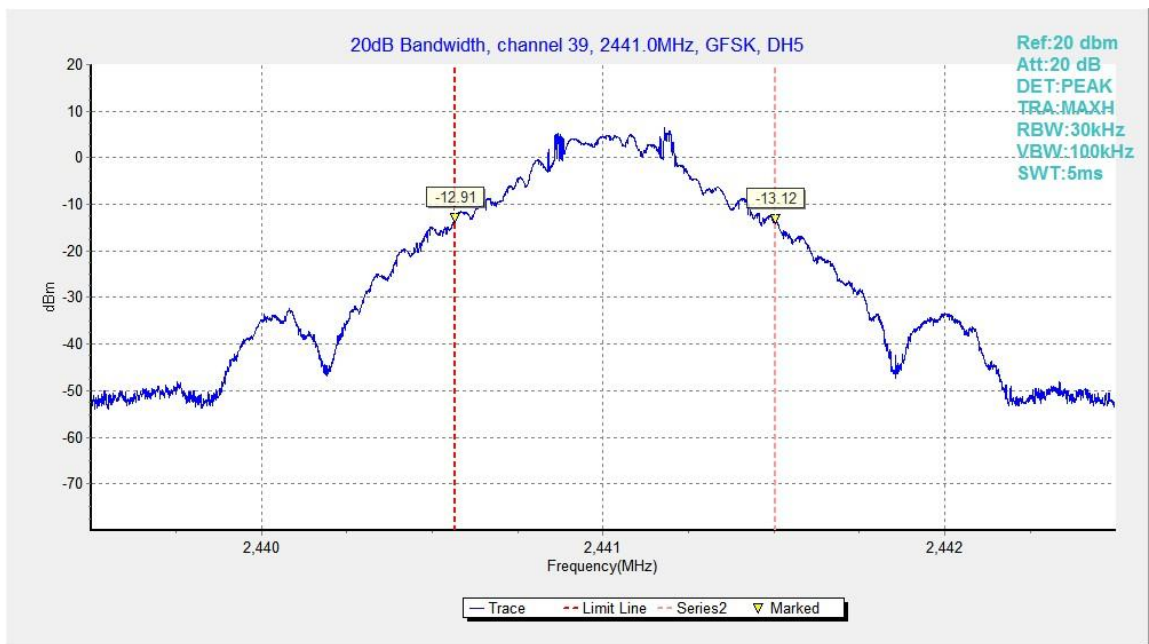

Fig.83. 20dB Bandwidth: GFSK, Channel 39

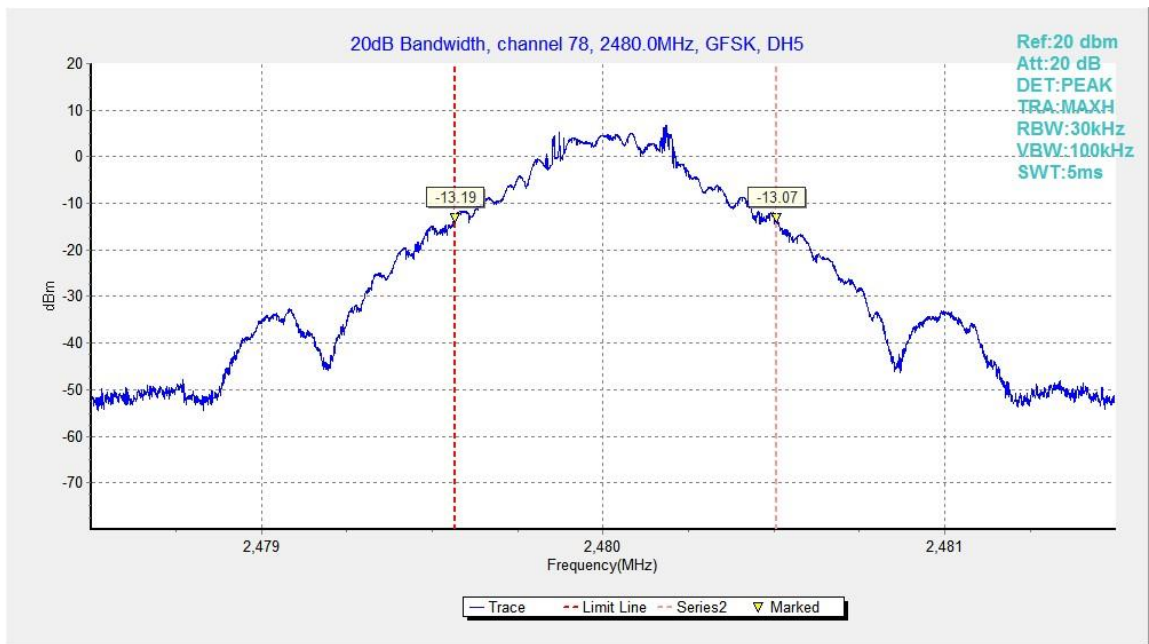

Fig.84. 20dB Bandwidth: GFSK, Channel 78

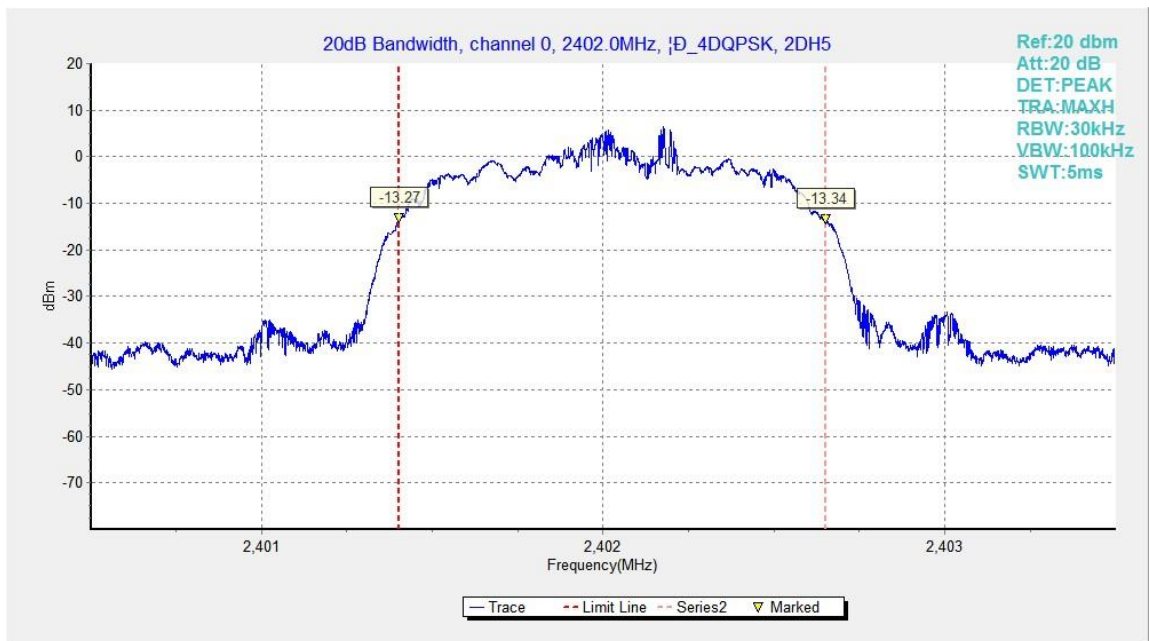

Fig.85. 20dB Bandwidth: $\pi/4$ DQPSK, Channel 0

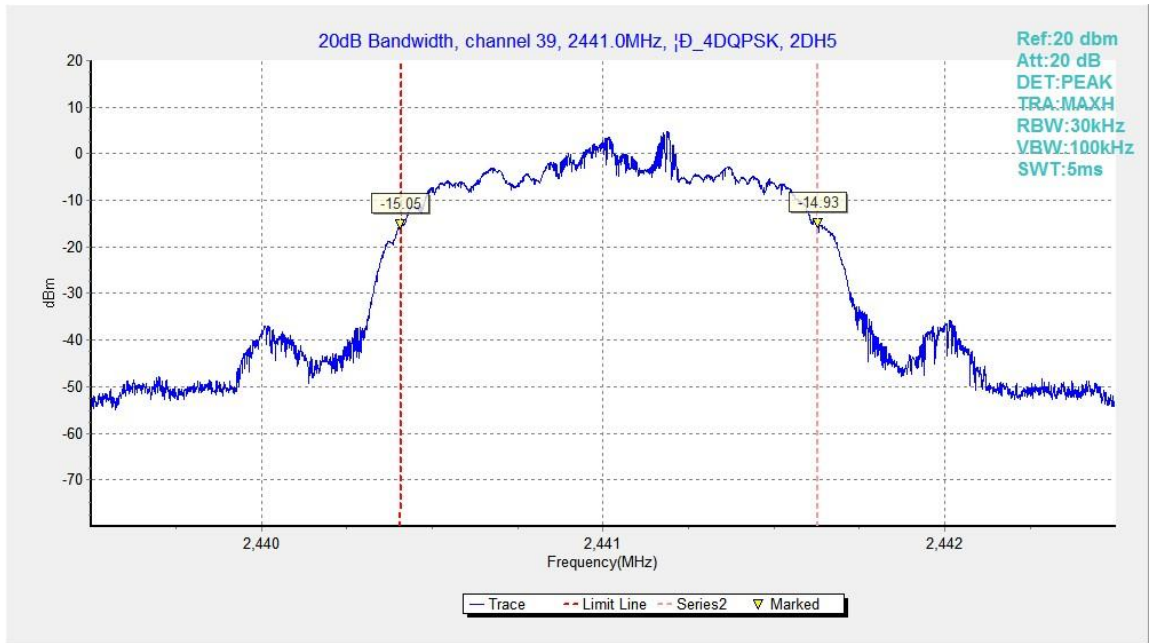

Fig.86. 20dB Bandwidth: $\pi/4$ DQPSK, Channel 39

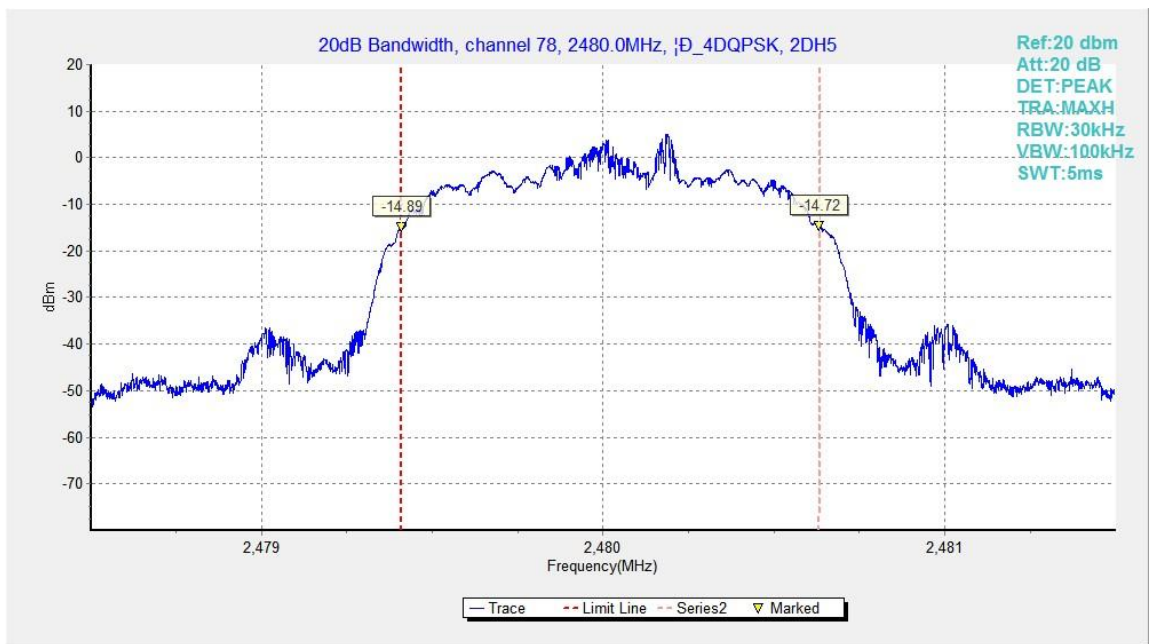

Fig.87. 20dB Bandwidth: $\pi/4$ DQPSK, Channel 78

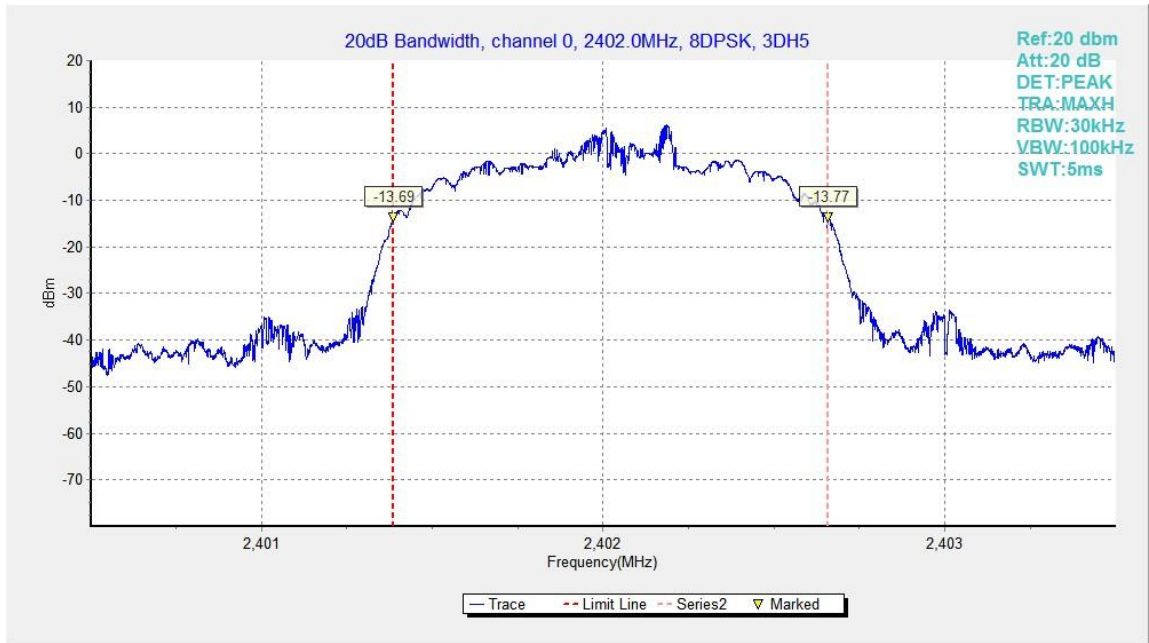

Fig.88. 20dB Bandwidth: 8DPSK, Channel 0

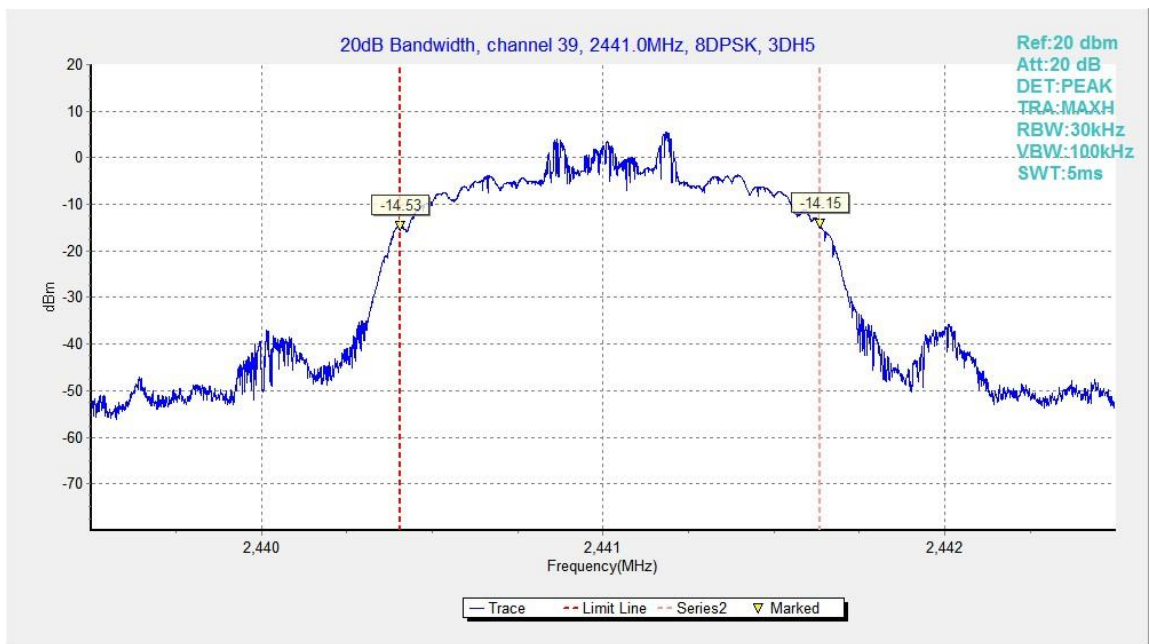

Fig.89. 20dB Bandwidth: 8DPSK, Channel 39

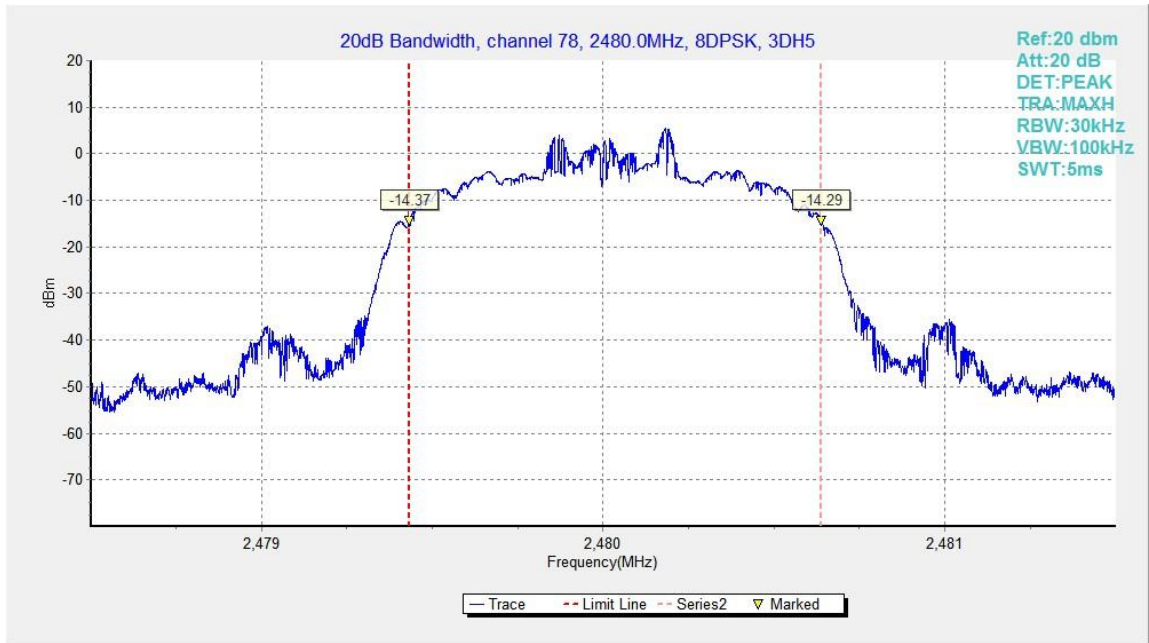

Fig.90. 20dB Bandwidth: 8DPSK, Channel 78

B.9. Carrier Frequency Separation

Method of Measurement: See ANSI C63.10-clause 7.8.2

The EUT must have its hopping function enabled. Use the following spectrum analyzer settings:

- Span = 3MHz
- RBW=300kHz
- VBW=300kHz
- Sweep = auto
- Detector function = peak
- Trace = max hold
- Allow the trace to stabilize

Search the peak marks of the middle frequency and adjacent channel, then record the separation between them.

* Comment: This limit should be over 25 kHz or $(2/3) * 20\text{dB}$ bandwidth, whichever is greater.

Measurement Limit:

Standard	Limit(kHz)
FCC 47 CFR Part 15.247(a)(1)	over 25 kHz or $(2/3) * 20\text{dB}$ bandwidth

Measurement Result:

For GFSK

Channel	Carrier frequency separation (kHz)	Conclusion	
39	Fig.91	1011.75	P

For $\pi/4$ DQPSK

Channel	Carrier frequency separation (kHz)	Conclusion	
39	Fig.92	883.50	P

For 8DPSK

Channel	Carrier frequency separation (kHz)	Conclusion	
39	Fig.93	1005.75	P

Conclusion: PASS

Test graphs as below:

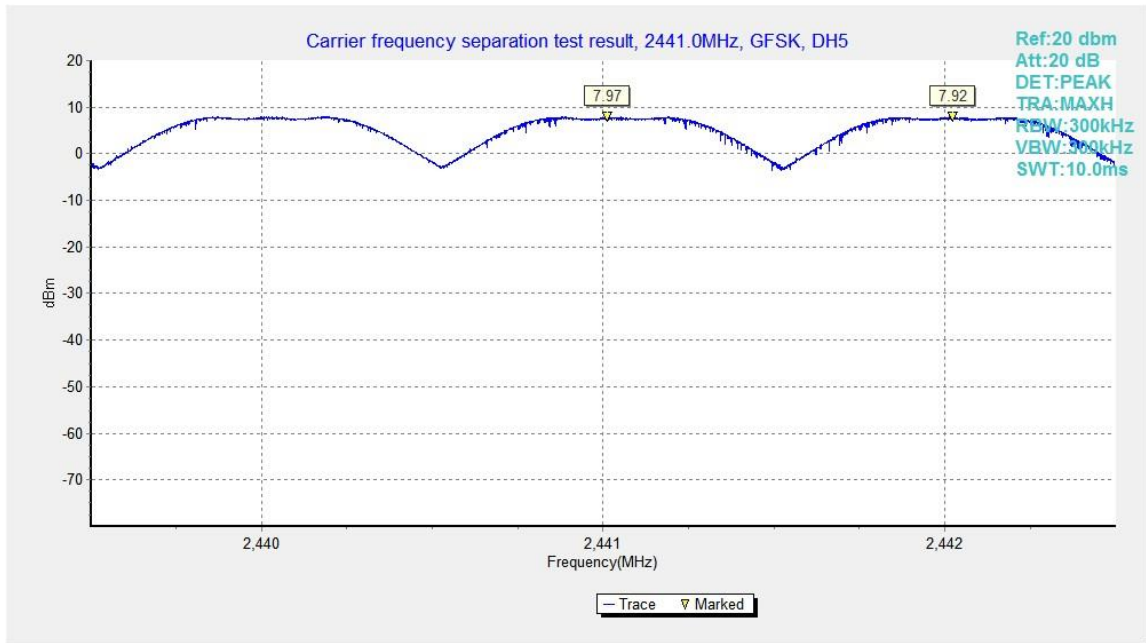

Fig.91. Carrier frequency separation measurement: GFSK, Channel 39

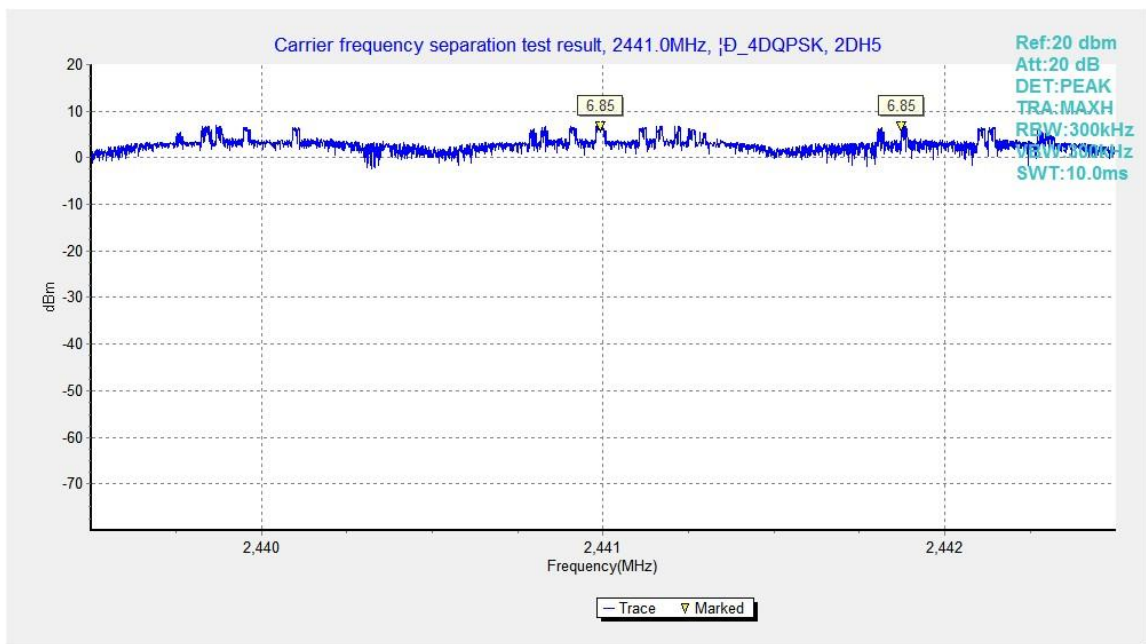

Fig.92. Carrier frequency separation measurement: $\pi/4$ DQPSK, Channel 39

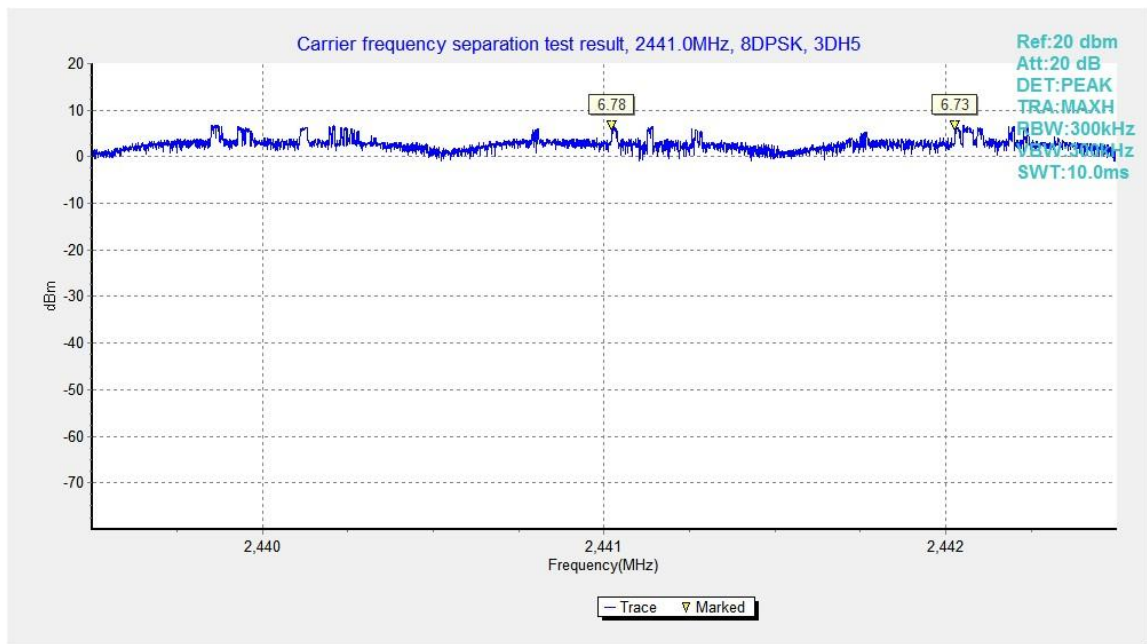

Fig.93. Carrier frequency separation measurement: 8DPSK, Channel 39

B.10. Number of Hopping Channels

Method of Measurement: See ANSI C63.10-clause 7.8.3

The EUT must have its hopping function enabled. Use the following spectrum analyzer settings:

- Span = the frequency band of operation
- RBW = 500kHz
- VBW = 500kHz
- Sweep = auto
- Detector function = peak
- Trace = max hold
- Allow the trace to stabilize

It might prove necessary to break the span up into subranges to show clearly all of the hopping frequencies. Compliance of an EUT with the appropriate regulatory limit shall be determined for the number of hopping channels. A plot of the data shall be included in the test report.

Measurement Limit:

Standard	Limit
FCC 47 CFR Part 15.247(a) (1)(iii)	At least 15 non-overlapping channels

Measurement Result:

For GFSK

Channel	Number of hopping channels	Conclusion
0~39	Fig.94	P
40~78	Fig.95	

For $\pi/4$ DQPSK

Channel	Number of hopping channels	Conclusion
0~39	Fig.96	P
40~78	Fig.97	

For 8DPSK

Channel	Number of hopping channels	Conclusion
0~39	Fig.98	P
40~78	Fig.99	

Conclusion: PASS

Test graphs as below:

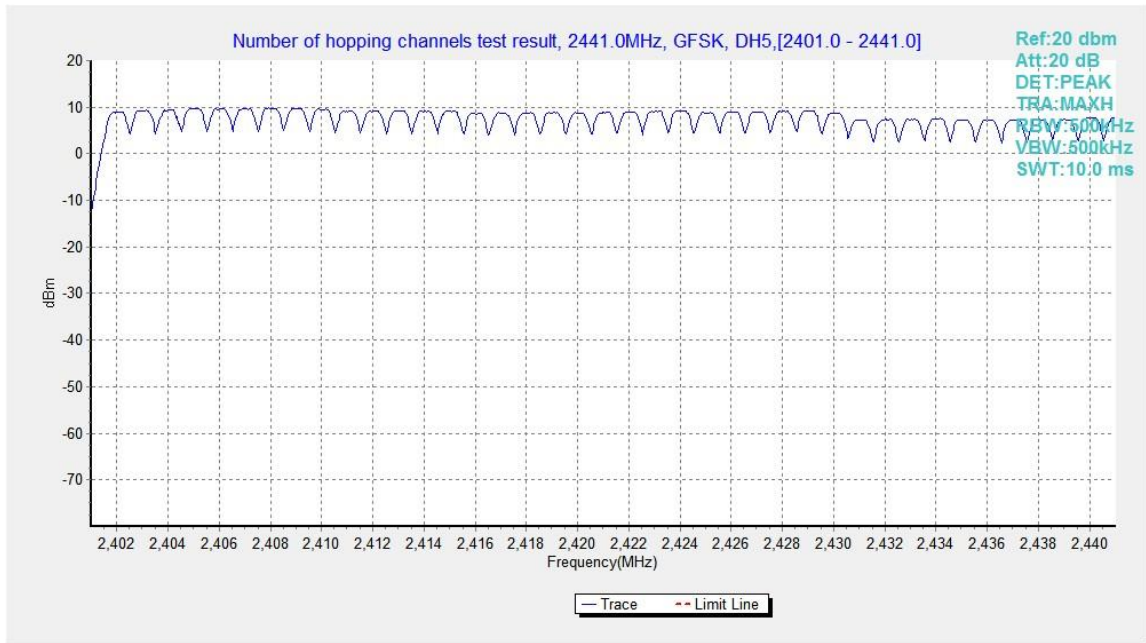

Fig.94. Number of hopping frequencies: GFSK, Channel 0 - 39

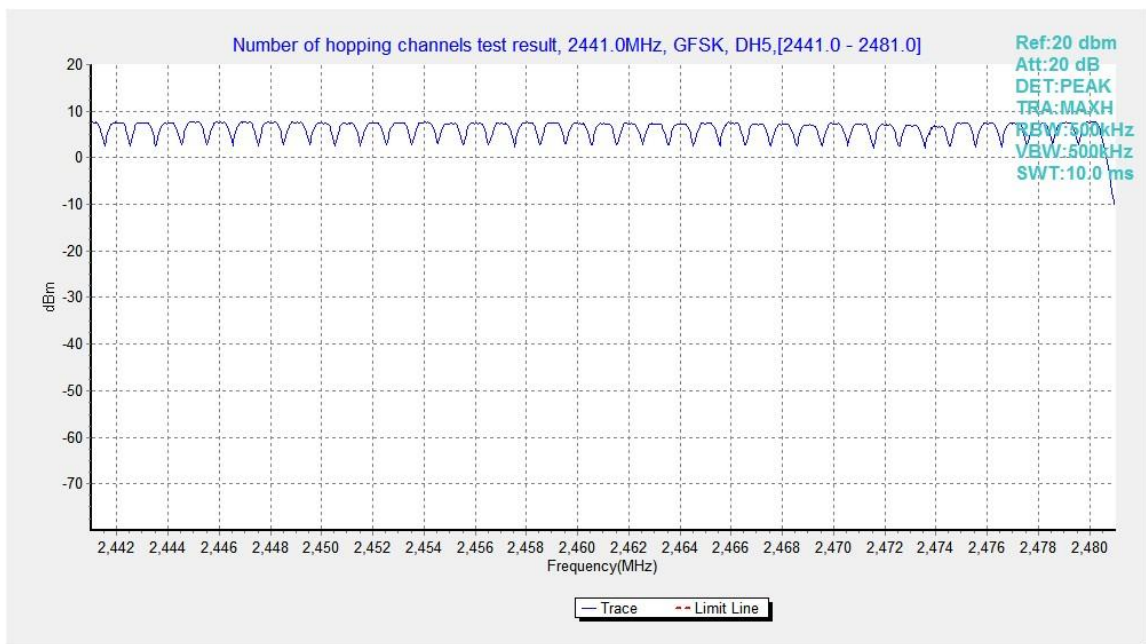

Fig.95. Number of hopping frequencies: GFSK, Channel 40 - 78

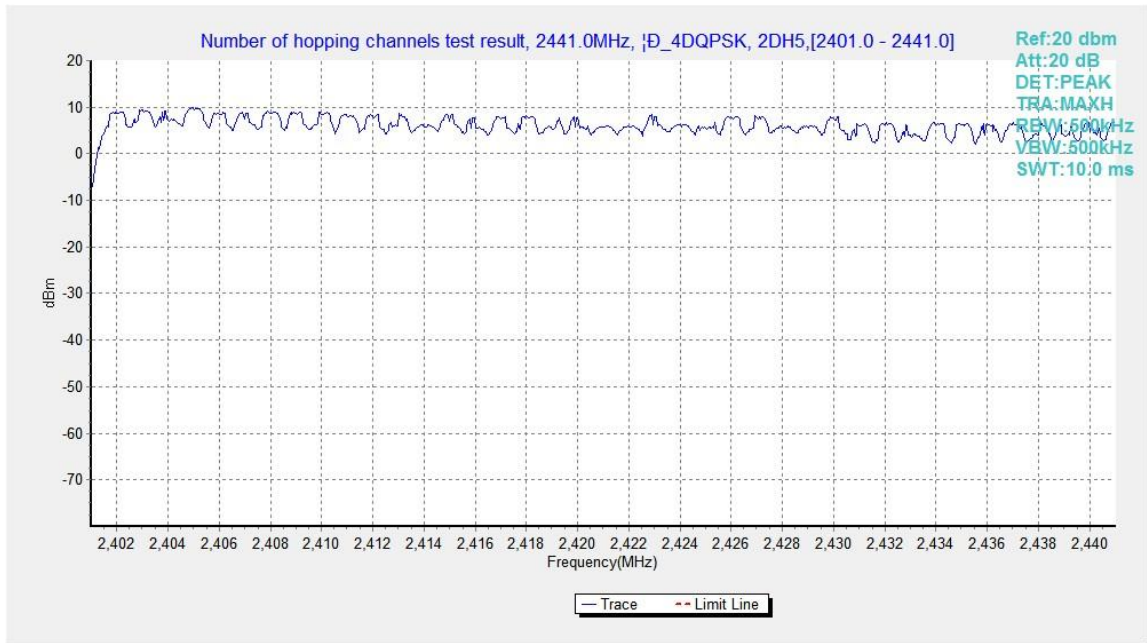

Fig.96. Number of hopping frequencies: $\pi/4$ DQPSK, Channel 0 - 39

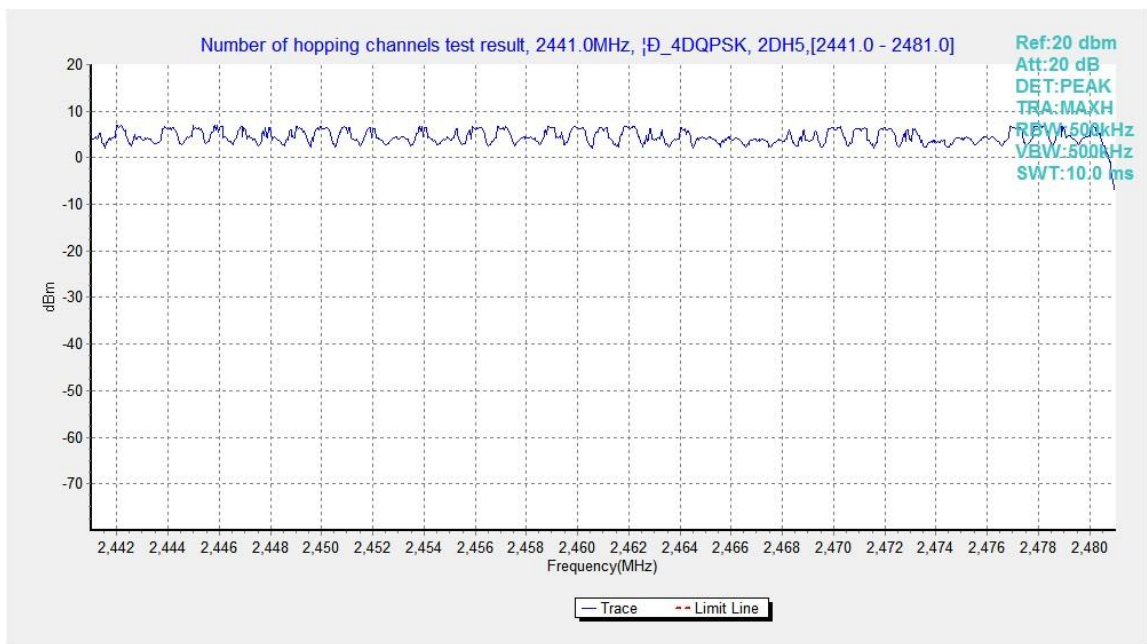

Fig.97. Number of hopping frequencies: $\pi/4$ DQPSK, Channel 40 - 78

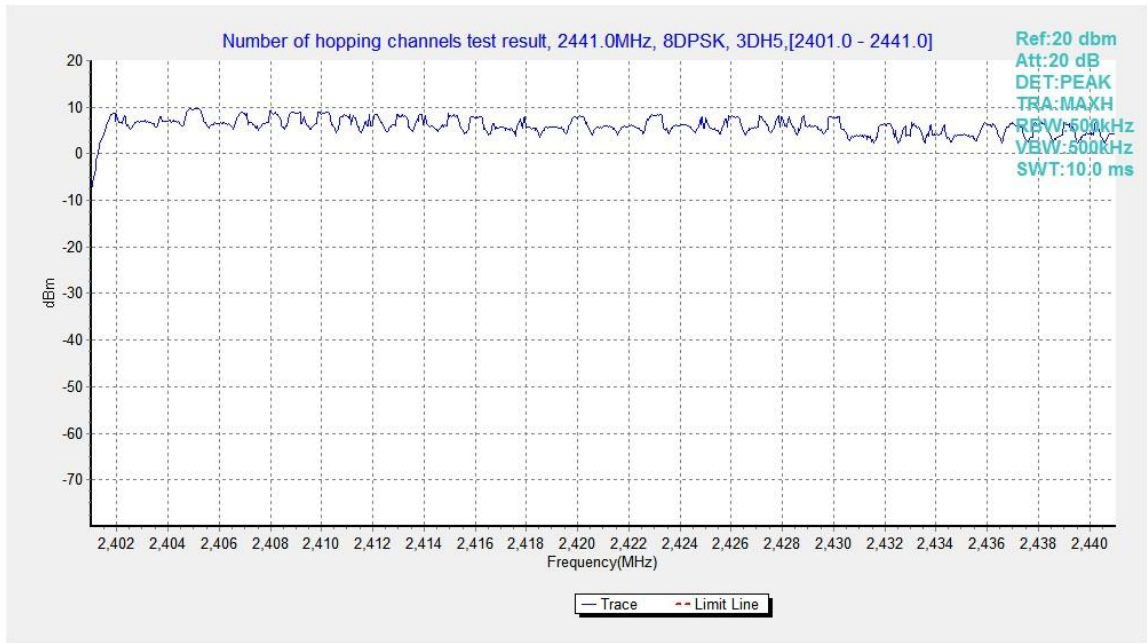

Fig.98. Number of hopping frequencies: 8DPSK, Channel 0 - 39

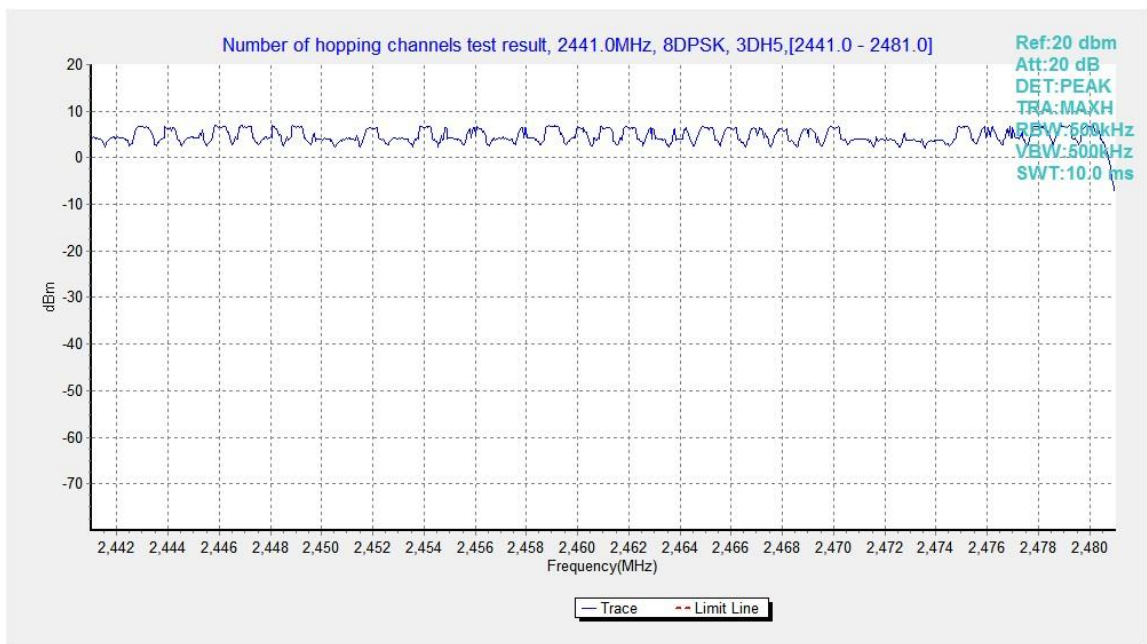

Fig.99. Number of hopping frequencies: 8DPSK, Channel 40 - 78

B.11. AC Powerline Conducted Emission

Method of Measurement: See ANSI C63.10-clause 6.2

Setup:

A stand-alone EUT shall be placed in the center along the back edge of the tabletop. For multiunit tabletop systems, the EUT shall be centered laterally (left to right facing the tabletop) on the tabletop and its rear shall be flush with the rear of the table.

Accessories that are part of an EUT system tested on a tabletop shall be placed in a test arrangement on one or both sides of the host with a 10 cm separation between the nearest points of the cabinets. The rear of the host and accessories shall be flush with the back of the supporting tabletop unless that would not be typical of normal use. If more than two accessories are present, then an equipment test arrangement shall be chosen that maintains 10 cm spacing between cabinets unless the equipment is normally located closer together.

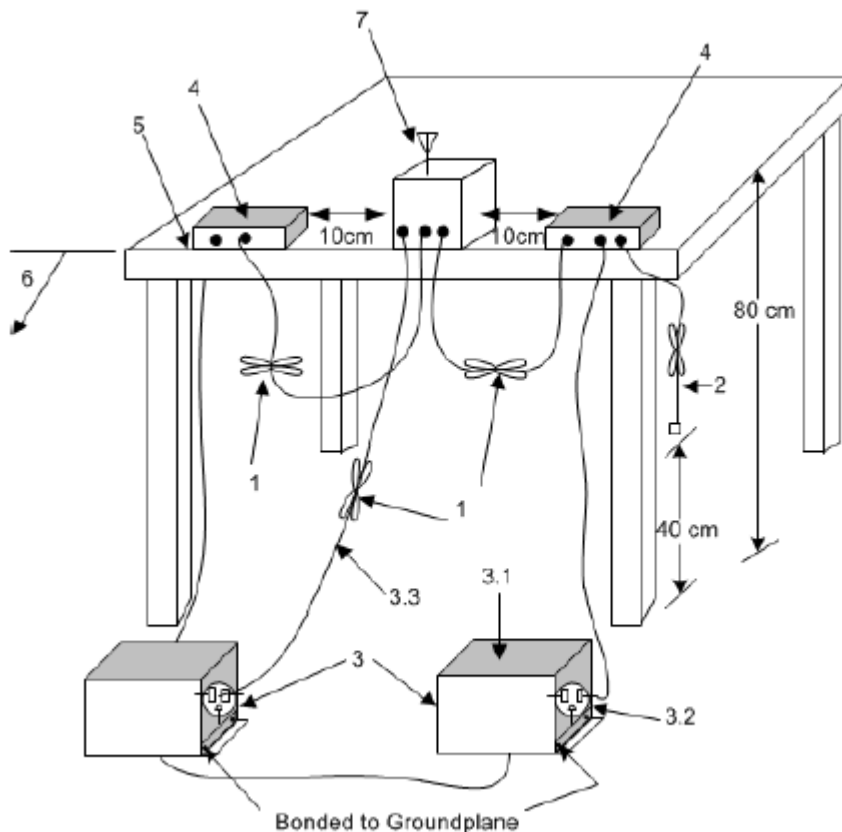

Exploratory ac power-line conducted emission measurements

Exploratory measurements shall be used to identify the frequency of the emission that has the highest amplitude relative to the limit by operating the EUT in a range of typical modes of operation, cable positions, and with a typical system equipment configuration and arrangement. For each mode of operation and for each ac power current-carrying conductor, cable manipulation shall be performed within the range of likely configurations. For this measurement or series of measurements, the frequency spectrum of interest shall be monitored looking for the emission that has the highest amplitude relative to the limit. Once that emission is found for each current-carrying conductor of each power cord associated with the EUT (but not the cords