

**LTE850-FDD5\_CH20450 Rear**

Date: 9/9/2020

Electronics: DAE4 Sn786

Medium: Head 835 MHz

Medium parameters used:  $f = 829 \text{ MHz}$ ;  $\sigma = 0.882 \text{ mho/m}$ ;  $\epsilon_r = 40.7$ ;  $\rho = 1000 \text{ kg/m}^3$ Ambient Temperature:  $22.5^\circ\text{C}$ , Liquid Temperature:  $22.3^\circ\text{C}$ 

Communication System: LTE850-FDD5 829 MHz Duty Cycle: 1:1

Probe: EX3DV4 – SN3633 ConvF(9.59, 9.59, 9.59)

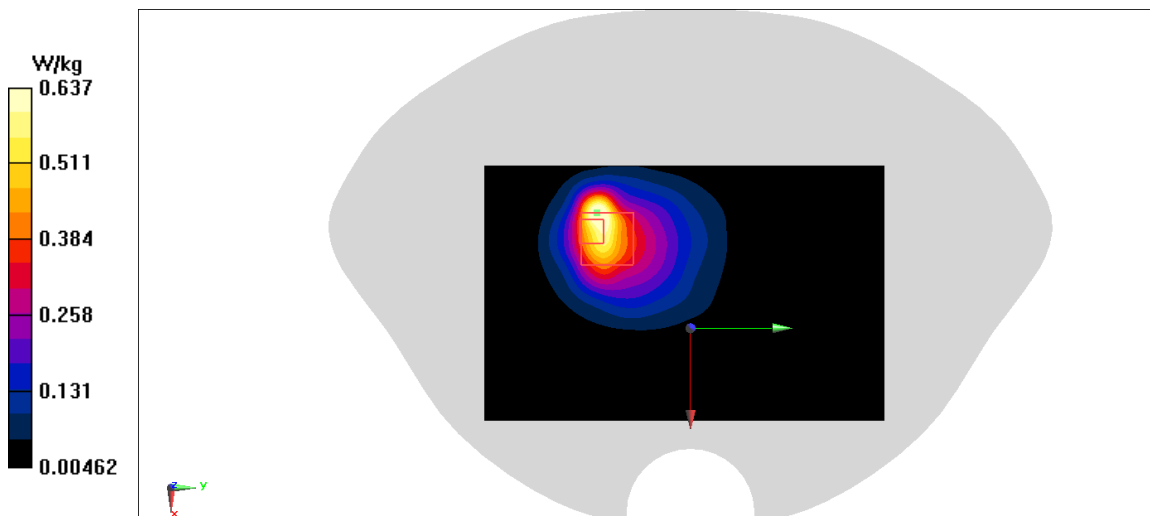
**Area Scan (71x121x1):** Interpolated grid:  $dx=1.000 \text{ mm}$ ,  $dy=1.000 \text{ mm}$ Maximum value of SAR (interpolated) =  $0.695 \text{ W/kg}$ **Zoom Scan (7x7x7)/Cube 0:** Measurement grid:  $dx=5\text{mm}$ ,  $dy=5\text{mm}$ ,  $dz=5\text{mm}$ Reference Value =  $10.64 \text{ V/m}$ ; Power Drift =  $0.03 \text{ dB}$ Peak SAR (extrapolated) =  $0.953 \text{ W/kg}$ **SAR(1 g) =  $0.388 \text{ W/kg}$ ; SAR(10 g) =  $0.231 \text{ W/kg}$** Maximum value of SAR (measured) =  $0.637 \text{ W/kg}$ **Fig A.16**

**LTE700-FDD12\_CH23130 Front**

Date: 9/8/2020

Electronics: DAE4 Sn786

Medium: Head 750 MHz

Medium parameters used:  $f = 711$  MHz;  $\sigma = 0.853$  mho/m;  $\epsilon_r = 42.55$ ;  $\rho = 1000$  kg/m<sup>3</sup>

Ambient Temperature: 22.5°C, Liquid Temperature: 22.3°C

Communication System: LTE700-FDD12 711 MHz Duty Cycle: 1:1

Probe: EX3DV4 – SN3633 ConvF(9.59, 9.59, 9.59)

**Area Scan (71x121x1):** Interpolated grid: dx=1.000 mm, dy=1.000 mm

Maximum value of SAR (interpolated) = 0.433 W/kg

**Zoom Scan (7x7x7)/Cube 0:** Measurement grid: dx=5mm, dy=5mm, dz=5mm

Reference Value = 20.81 V/m; Power Drift = 0.02 dB

Peak SAR (extrapolated) = 0.477 W/kg

**SAR(1 g) = 0.35 W/kg; SAR(10 g) = 0.262 W/kg**

Maximum value of SAR (measured) = SAR W/kg

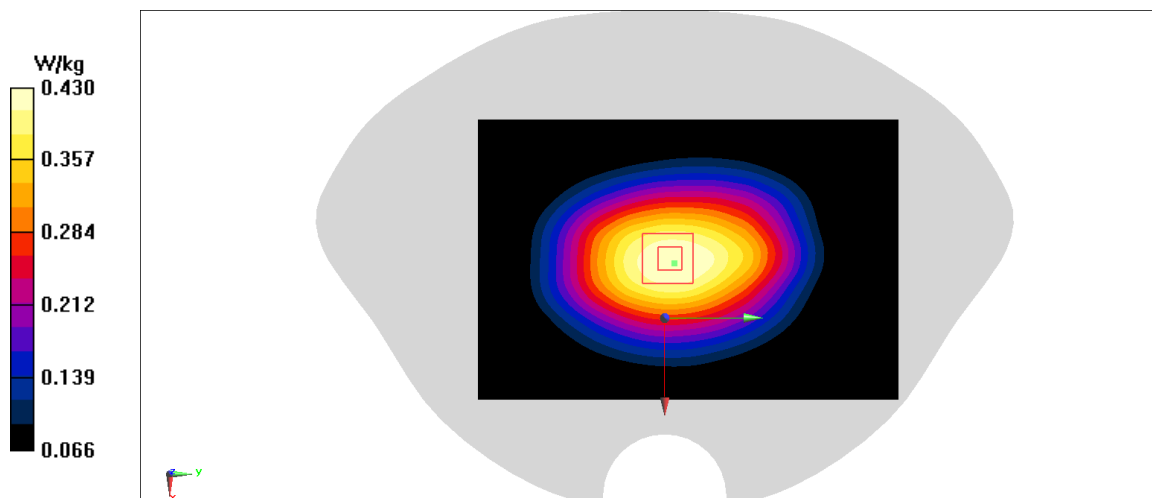
**Fig A.17**

**LTE700-FDD14\_CH23330 Rear**

Date: 9/8/2020

Electronics: DAE4 Sn786

Medium: Head 750 MHz

Medium parameters used:  $f = 793 \text{ MHz}$ ;  $\sigma = 0.931 \text{ mho/m}$ ;  $\epsilon_r = 42.45$ ;  $\rho = 1000 \text{ kg/m}^3$

Ambient Temperature:  $22.5^\circ\text{C}$ , Liquid Temperature:  $22.3^\circ\text{C}$

Communication System: LTE700-FDD14 793 MHz Duty Cycle: 1:1

Probe: EX3DV4 – SN3633 ConvF(9.59, 9.59, 9.59)

**Area Scan (71x121x1):** Interpolated grid:  $dx=1.000 \text{ mm}$ ,  $dy=1.000 \text{ mm}$

Maximum value of SAR (interpolated) =  $0.425 \text{ W/kg}$

**Zoom Scan (7x7x7)/Cube 0:** Measurement grid:  $dx=5\text{mm}$ ,  $dy=5\text{mm}$ ,  $dz=5\text{mm}$

Reference Value =  $19.54 \text{ V/m}$ ; Power Drift =  $0.1 \text{ dB}$

Peak SAR (extrapolated) =  $0.438 \text{ W/kg}$

**SAR(1 g) =  $0.342 \text{ W/kg}$ ; SAR(10 g) =  $0.258 \text{ W/kg}$**

Maximum value of SAR (measured) =  $0.406 \text{ W/kg}$

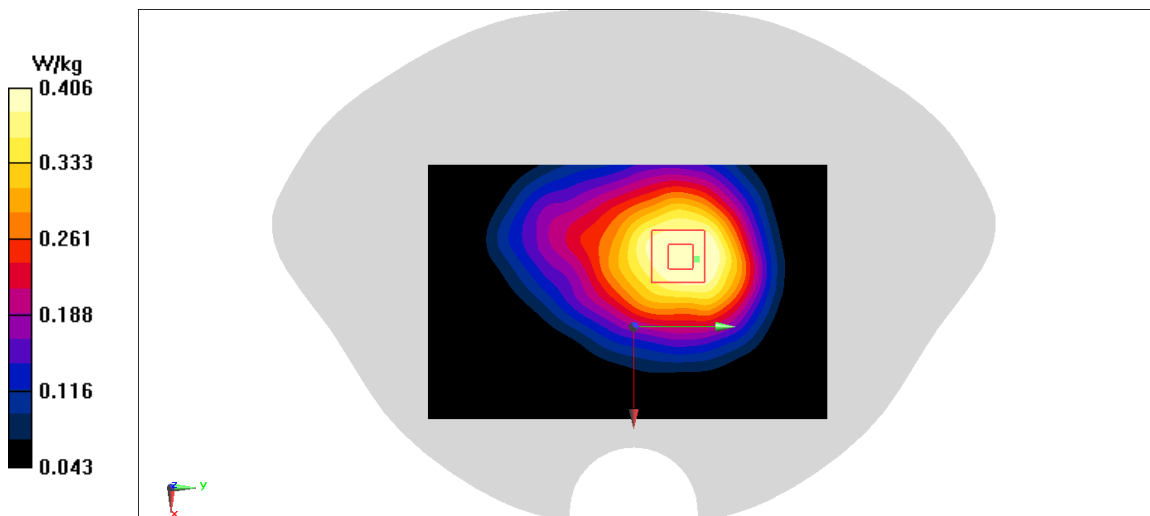

**Fig A.18**

**LTE2300-FDD30\_CH27710 Front**

Date: 9/12/2020

Electronics: DAE4 Sn786

Medium: Head 2300 MHz

Medium parameters used:  $f = 2310$  MHz;  $\sigma = 1.697$  mho/m;  $\epsilon_r = 40.13$ ;  $\rho = 1000$  kg/m<sup>3</sup>

Ambient Temperature: 22.5°C, Liquid Temperature: 22.3°C

Communication System: LTE2300-FDD30 2310 MHz Duty Cycle: 1:1

Probe: EX3DV4 – SN3633 ConvF(7.69, 7.69, 7.69)

**Area Scan (71x121x1):** Interpolated grid: dx=1.000 mm, dy=1.000 mm

Maximum value of SAR (interpolated) = 0.605 W/kg

**Zoom Scan (7x7x7)/Cube 0:** Measurement grid: dx=5mm, dy=5mm, dz=5mm

Reference Value = 9.074 V/m; Power Drift = 0 dB

Peak SAR (extrapolated) = 0.653 W/kg

**SAR(1 g) = 0.353 W/kg; SAR(10 g) = 0.176 W/kg**

Maximum value of SAR (measured) = 0.552 W/kg

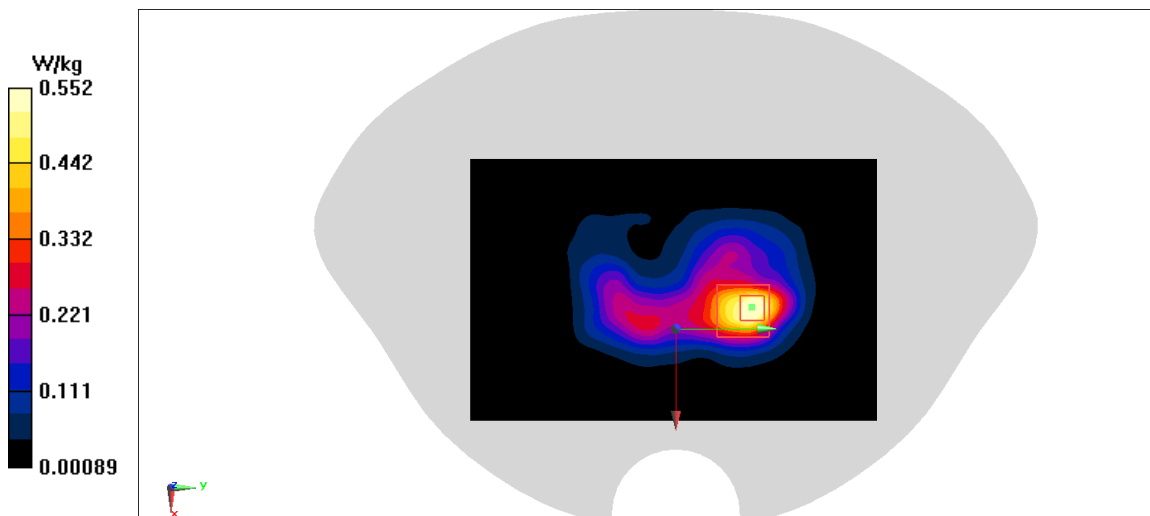
**Fig A.19**

**LTE1700-FDD66\_CH132322 Rear**

Date: 9/10/2020

Electronics: DAE4 Sn786

Medium: Head 1750 MHz

Medium parameters used:  $f = 1745$  MHz;  $\sigma = 1.35$  mho/m;  $\epsilon_r = 40.22$ ;  $\rho = 1000$  kg/m<sup>3</sup>

Ambient Temperature: 22.5°C, Liquid Temperature: 22.3°C

Communication System: LTE1700-FDD66 1745 MHz Duty Cycle: 1:1

Probe: EX3DV4 – SN3633 ConvF(8.09, 8.09, 8.09)

**Area Scan (71x121x1):** Interpolated grid: dx=1.000 mm, dy=1.000 mm

Maximum value of SAR (interpolated) = 0.81 W/kg

**Zoom Scan (7x7x7)/Cube 0:** Measurement grid: dx=5mm, dy=5mm, dz=5mm

Reference Value = 21.98 V/m; Power Drift = -0.1 dB

Peak SAR (extrapolated) = 0.764 W/kg

**SAR(1 g) = 0.581 W/kg; SAR(10 g) = 0.398 W/kg**

Maximum value of SAR (measured) = 0.706 W/kg

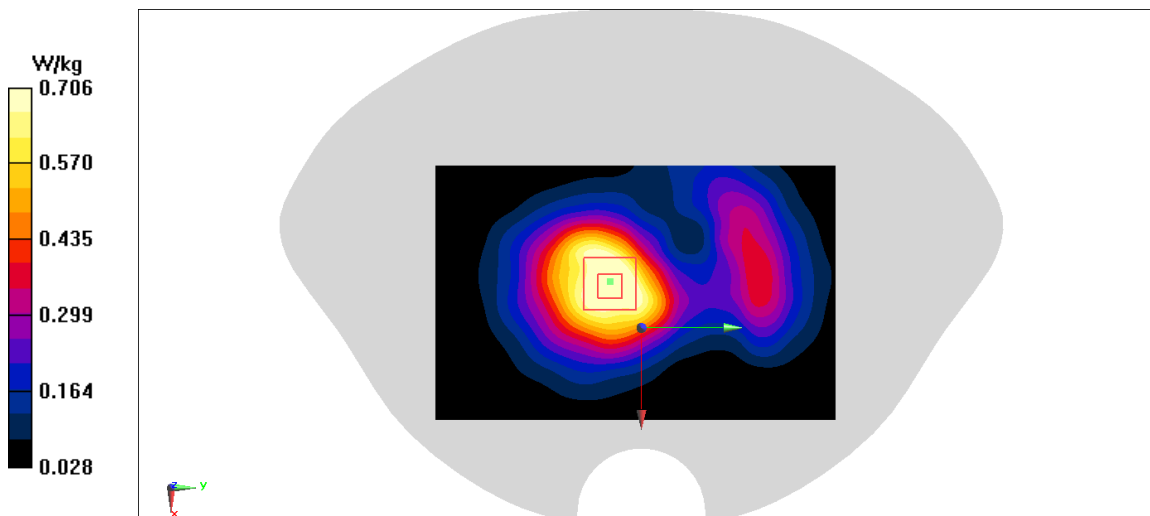
**Fig A.20**

**WLAN2450\_CH11 Right**

Date: 9/13/2020

Electronics: DAE4 Sn786

Medium: Head 2450 MHz

Medium parameters used:  $f = 2462$ ;  $\sigma = 1.807$  mho/m;  $\epsilon_r = 39.19$ ;  $\rho = 1000$  kg/m<sup>3</sup>

Ambient Temperature: 22.5°C, Liquid Temperature: 22.3°C

Communication System: WLAN2450 2462 Duty Cycle: 1:1

Probe: EX3DV4 – SN3633 ConvF(7.43, 7.43, 7.43)

**Area Scan (71x121x1):** Interpolated grid: dx=1.000 mm, dy=1.000 mm

Maximum value of SAR (interpolated) = 0.313 W/kg

**Zoom Scan (7x7x7)/Cube 0:** Measurement grid: dx=5mm, dy=5mm, dz=5mm

Reference Value = 1.29 V/m; Power Drift = -0.08 dB

Peak SAR (extrapolated) = 0.457 W/kg

**SAR(1 g) = 0.186 W/kg; SAR(10 g) = 0.099 W/kg**

Maximum value of SAR (measured) = 0.312 W/kg

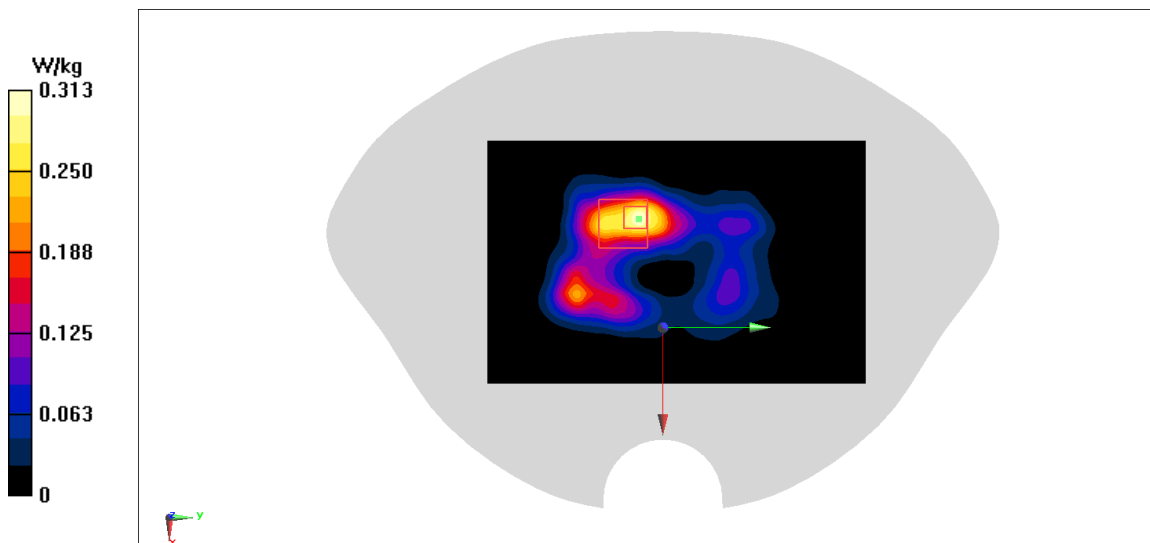

Fig A.21

**WLAN5G\_CH138 Right**

Date: 9/14/2020

Electronics: DAE4 Sn786

Medium: Head 5750 MHz

Medium parameters used:  $f = 5690$ ;  $\sigma = 5.141$  mho/m;  $\epsilon_r = 35.79$ ;  $\rho = 1000$  kg/m<sup>3</sup>

Ambient Temperature: 22.5°C, Liquid Temperature: 22.3°C

Communication System: WLAN 5690 Duty Cycle: 1:1

Probe: EX3DV4 – SN3633 ConvF(4.73, 4.73, 4.73)

**Area Scan (71x121x1):** Interpolated grid: dx=1.000 mm, dy=1.000 mm

Maximum value of SAR (interpolated) = 1.55 W/kg

**Zoom Scan (7x7x7)/Cube 0:** Measurement grid: dx=5mm, dy=5mm, dz=5mm

Reference Value = 0.246 V/m; Power Drift = 0.07 dB

Peak SAR (extrapolated) = 2.06 W/kg

**SAR(1 g) = 0.499 W/kg; SAR(10 g) = 0.107 W/kg**

Maximum value of SAR (measured) = 1.39 W/kg

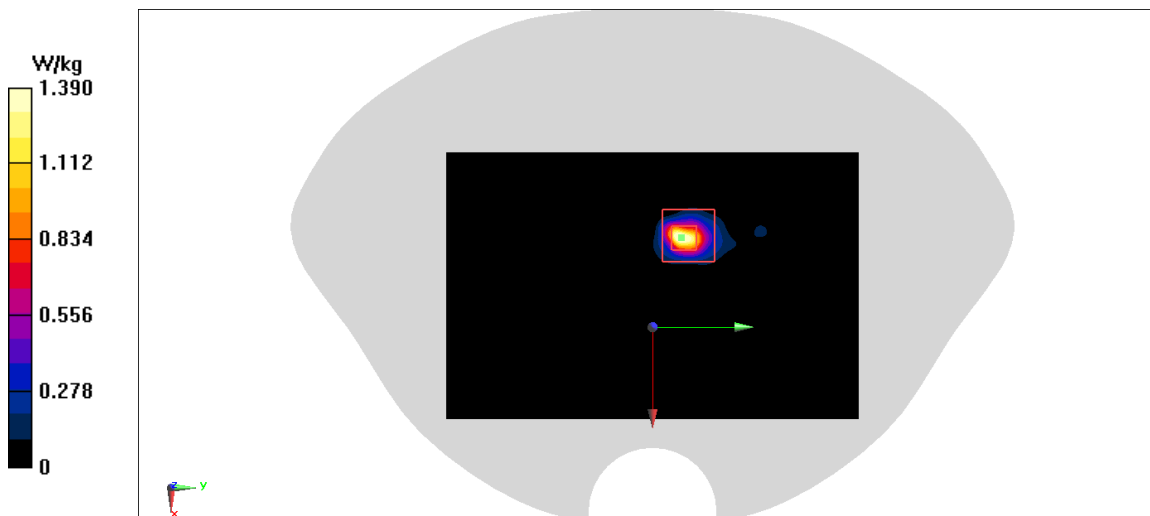

**Fig A.22**

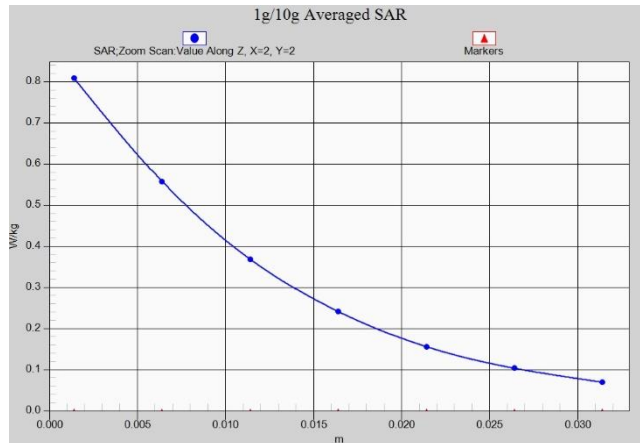

**Fig. 1-1 Z-Scan at power reference point (WCDMA1900 MHz Body)**

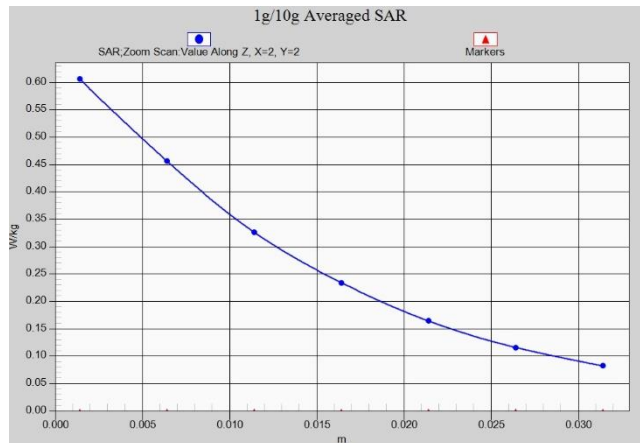

**Fig. 1-2 Z-Scan at power reference point (WCDMA1700 MHz Body)**

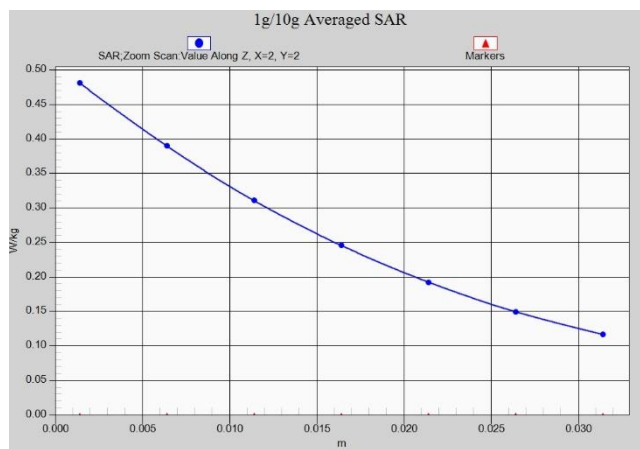

**Fig. 1-3 Z-Scan at power reference point (WCDMA850 MHz Body)**





**Fig. 1-4 Z-Scan at power reference point (LTE B2 MHz Body)**



**Fig. 1-5 Z-Scan at power reference point (LTE B5 MHz Body)**



**Fig. 1-6 Z-Scan at power reference point (LTE B12 MHz Body)**

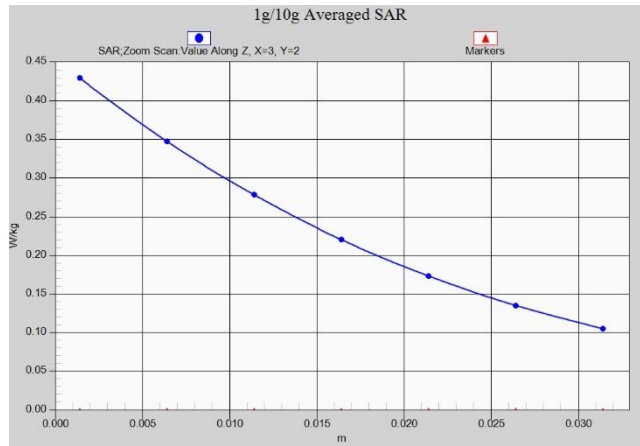

**Fig. 1-7 Z-Scan at power reference point (LTE B14 MHz Body)**

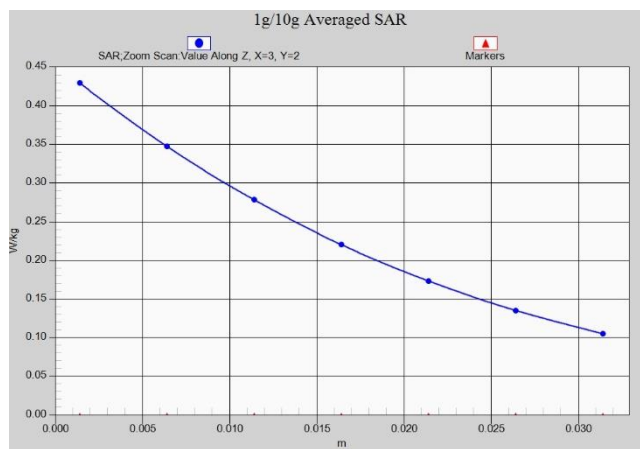

**Fig. 1-8 Z-Scan at power reference point (LTE B30 MHz Body)**

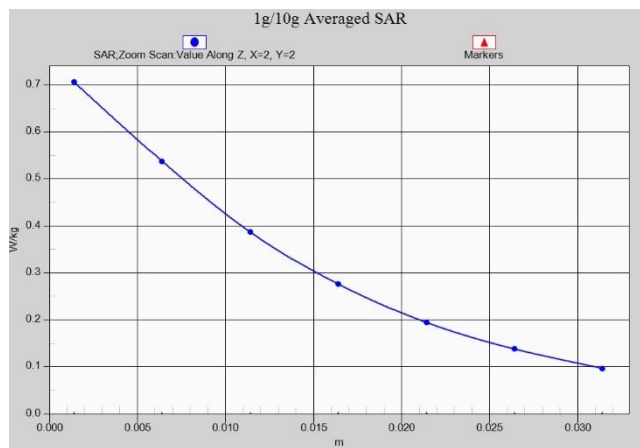

**Fig. 1-9 Z-Scan at power reference point (LTE B66 MHz Body)**

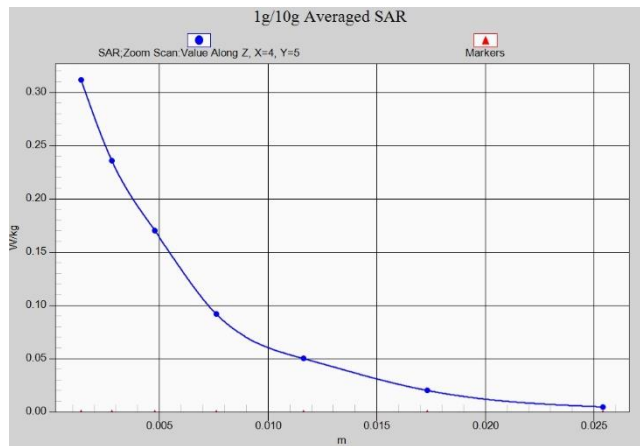

**Fig. 1-10 Z-Scan at power reference point (WLAN2.4G MHz Body)**

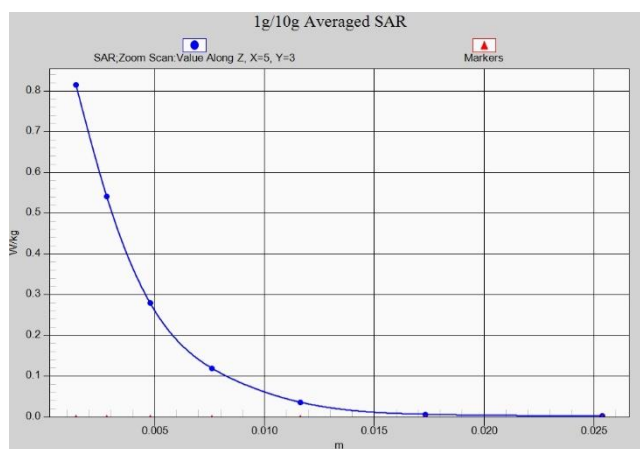

**Fig. 1-11 Z-Scan at power reference point (WLAN5G MHz Body)**

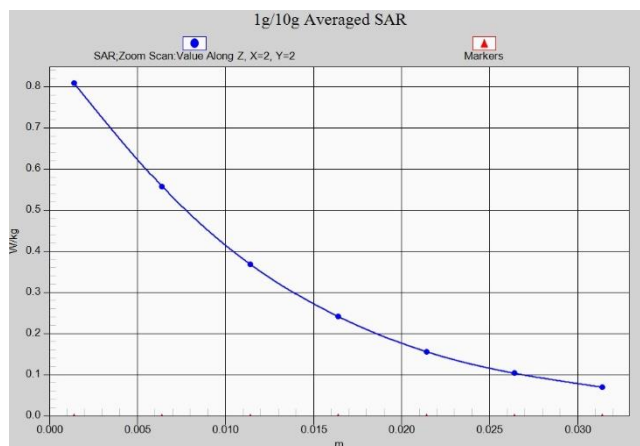

**Fig. 1-12 Z-Scan at power reference point (WCDMA1900 MHz Body)**

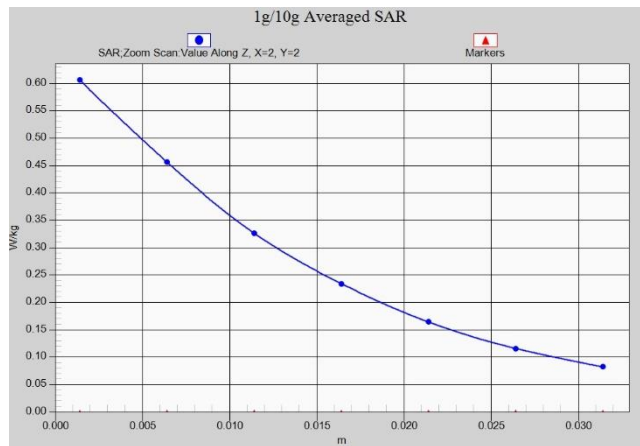

**Fig. 1-13 Z-Scan at power reference point (WCDMA1700 MHz Body)**

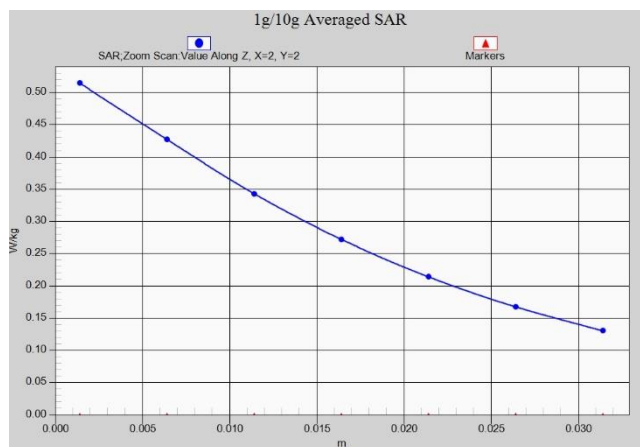

**Fig. 1-14 Z-Scan at power reference point (WCDMA850 MHz Body)**

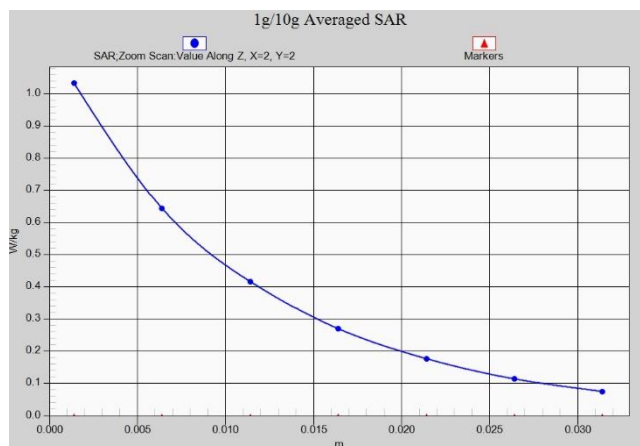

**Fig. 1-15 Z-Scan at power reference point (LTE B2 MHz Body)**

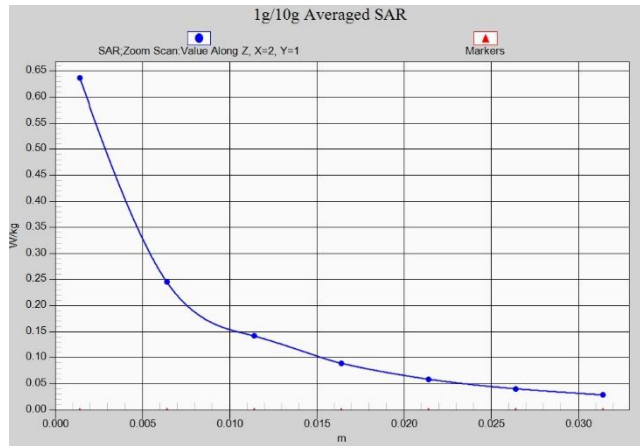

**Fig. 1-16 Z-Scan at power reference point (LTE B5 MHz Body)**

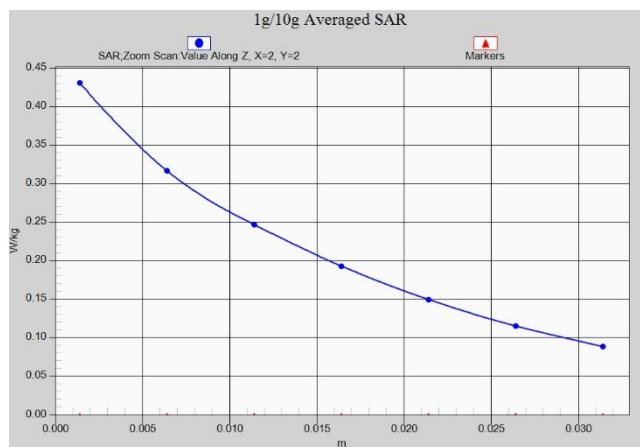

**Fig. 1-17 Z-Scan at power reference point (LTE B12 MHz Body)**

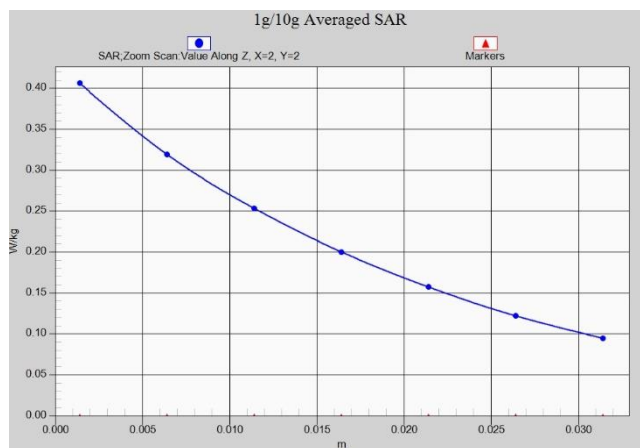

**Fig. 1-18 Z-Scan at power reference point (LTE B14 MHz Body)**

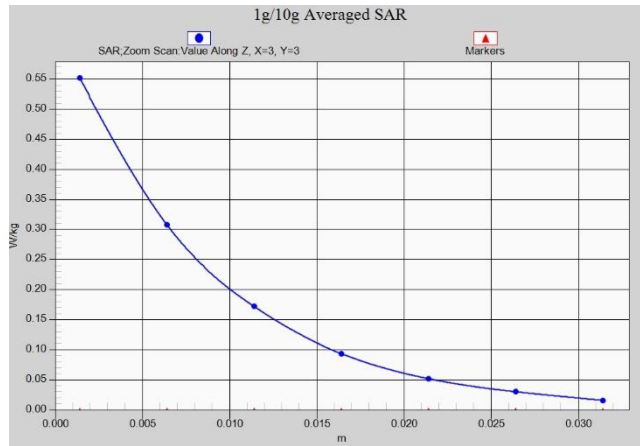

**Fig. 1-19 Z-Scan at power reference point (LTE B30 MHz Body)**

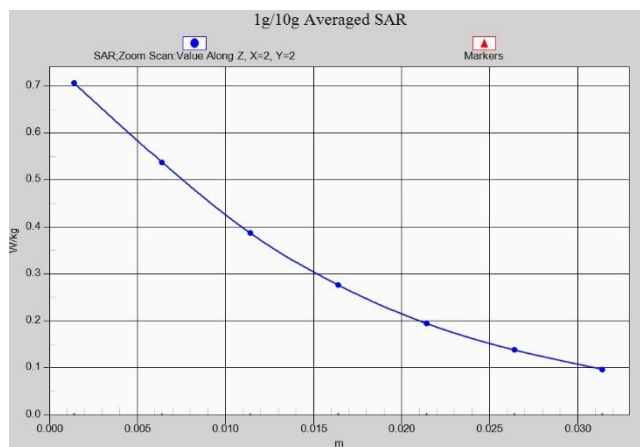

**Fig. 1-20 Z-Scan at power reference point (LTE B66 MHz Body)**

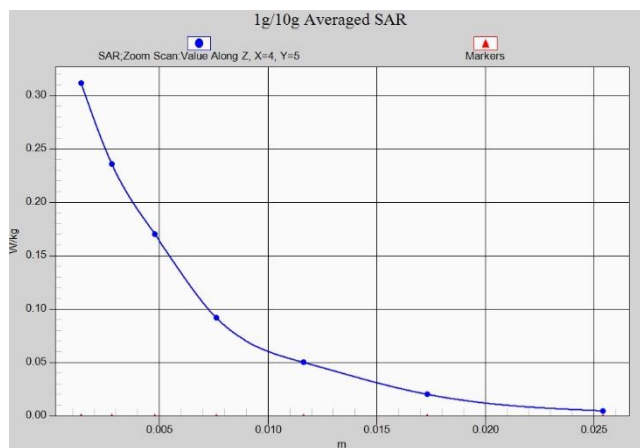

**Fig. 1-21 Z-Scan at power reference point (WLAN2.4G MHz Body)**

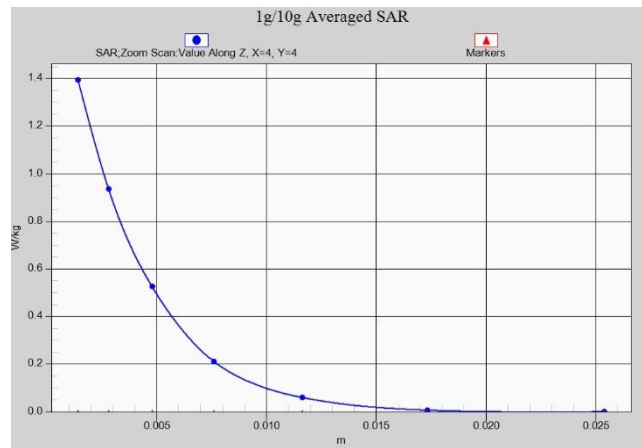

Fig. 1-22 Z-Scan at power reference point (WLAN5G MHz Body)

## ANNEX B: System Verification Results

### 750 MHz

Date: 9/8/2020

Electronics: DAE4 Sn786

Medium: Head 750 MHz

Medium parameters used:  $f = 750 \text{ MHz}$ ;  $\sigma = 0.89 \text{ mho/m}$ ;  $\epsilon_r = 42.5$ ;  $\rho = 1000 \text{ kg/m}^3$

Ambient Temperature:  $22.5^\circ\text{C}$  Liquid Temperature:  $22.3^\circ\text{C}$

Communication System: CW Frequency: 750 MHz Duty Cycle: 1:1

Probe: EX3DV4 – SN3633 ConvF(9.59, 9.59, 9.59)

**System Validation /Area Scan (81x191x1):** Interpolated grid:  $dx=1.000 \text{ mm}$ ,  $dy=1.000 \text{ mm}$

Reference Value =  $58.74 \text{ V/m}$ ; Power Drift =  $-0.02$

**Fast SAR: SAR(1 g) =  $2.09 \text{ W/kg}$ ; SAR(10 g) =  $1.38 \text{ W/kg}$**

Maximum value of SAR (interpolated) =  $2.85 \text{ W/kg}$

**System Validation /Zoom Scan (7x7x7)/Cube 0:** Measurement grid:  $dx=5\text{mm}$ ,  $dy=5\text{mm}$ ,  $dz=5\text{mm}$

Reference Value =  $58.74 \text{ V/m}$ ; Power Drift =  $-0.02 \text{ dB}$

Peak SAR (extrapolated) =  $3.28 \text{ W/kg}$

**SAR(1 g) =  $2.14 \text{ W/kg}$ ; SAR(10 g) =  $1.36 \text{ W/kg}$**

Maximum value of SAR (measured) =  $2.85 \text{ W/kg}$

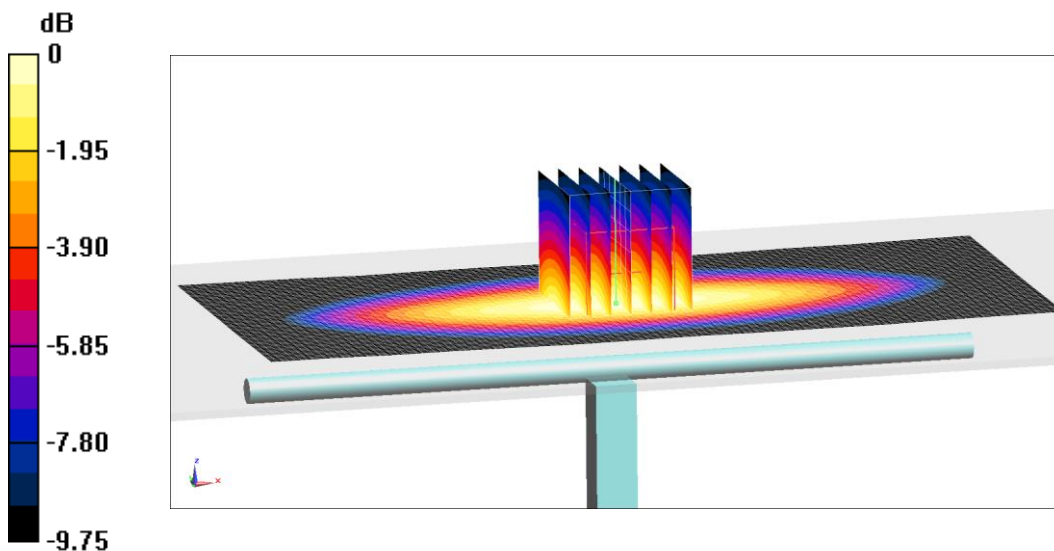

$0 \text{ dB} = 2.85 \text{ W/kg} = 4.55 \text{ dB W/kg}$

**Fig.B.1 validation 750 MHz 250mW**



**835 MHz**

Date: 9/9/2020

Electronics: DAE4 Sn786

Medium: Head 835 MHz

Medium parameters used:  $f = 835 \text{ MHz}$ ;  $\sigma = 0.888 \text{ mho/m}$ ;  $\epsilon_r = 40.69$ ;  $\rho = 1000 \text{ kg/m}^3$

Ambient Temperature:  $22.5^\circ\text{C}$  Liquid Temperature:  $22.3^\circ\text{C}$

Communication System: CW Frequency: 835 MHz Duty Cycle: 1:1

Probe: EX3DV4 – SN3633 ConvF(9.59, 9.59, 9.59)

**System Validation /Area Scan (81x191x1):** Interpolated grid:  $dx=1.000 \text{ mm}$ ,  $dy=1.000 \text{ mm}$

Reference Value =  $62.83 \text{ V/m}$ ; Power Drift = 0.1

**Fast SAR: SAR(1 g) =  $2.37 \text{ W/kg}$ ; SAR(10 g) =  $1.53 \text{ W/kg}$**

Maximum value of SAR (interpolated) =  $3.19 \text{ W/kg}$

**System Validation /Zoom Scan (7x7x7)/Cube 0:** Measurement grid:  $dx=5\text{mm}$ ,  $dy=5\text{mm}$ ,  $dz=5\text{mm}$

Reference Value =  $62.83 \text{ V/m}$ ; Power Drift = 0.1 dB

Peak SAR (extrapolated) =  $3.66 \text{ W/kg}$

**SAR(1 g) =  $2.43 \text{ W/kg}$ ; SAR(10 g) =  $1.55 \text{ W/kg}$**

Maximum value of SAR (measured) =  $3.27 \text{ W/kg}$

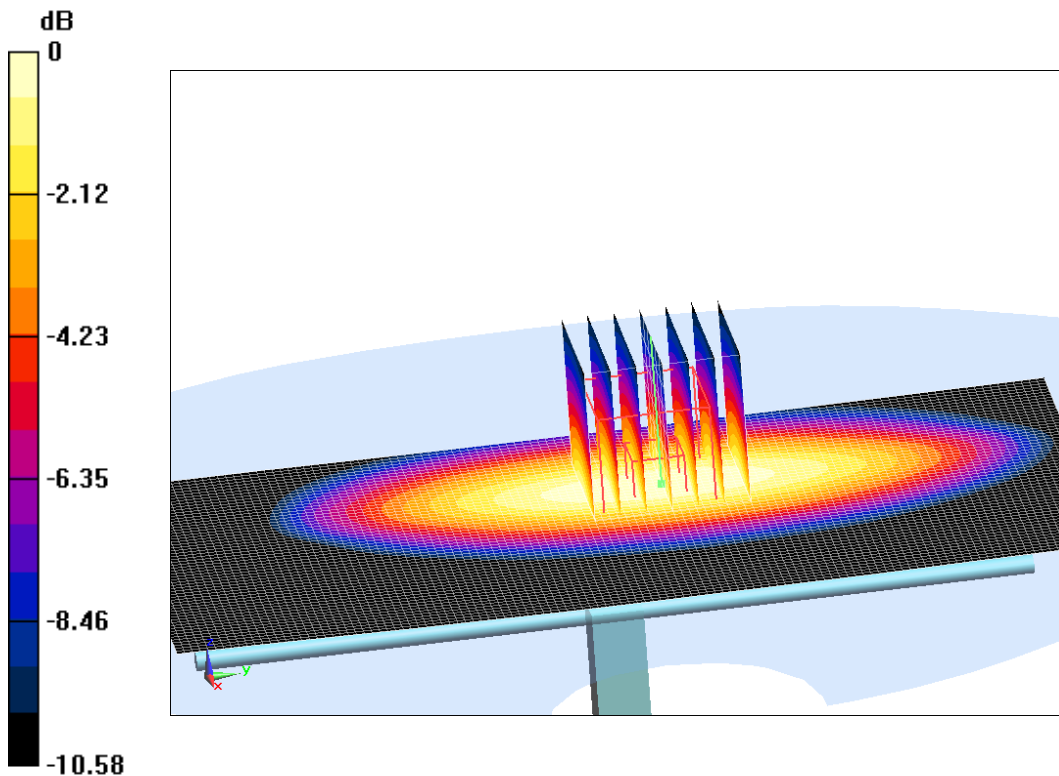

0 dB =  $3.27 \text{ W/kg}$  =  $5.15 \text{ dB W/kg}$

**Fig.B.2 validation 835 MHz 250Mw**

**1750 MHz**

Date: 9/10/2020

Electronics: DAE4 Sn786

Medium: Head 1750 MHz

Medium parameters used:  $f = 1750 \text{ MHz}$ ;  $\sigma = 1.354 \text{ mho/m}$ ;  $\epsilon_r = 40.2$ ;  $\rho = 1000 \text{ kg/m}^3$

Ambient Temperature:  $22.5^\circ\text{C}$  Liquid Temperature:  $22.3^\circ\text{C}$

Communication System: CW Frequency: 1750 MHz Duty Cycle: 1:1

Probe: EX3DV4 – SN3633 ConvF(8.09, 8.09, 8.09)

**System Validation /Area Scan (81x191x1):** Interpolated grid:  $dx=1.000 \text{ mm}$ ,  $dy=1.000 \text{ mm}$

Reference Value = 106.22 V/m; Power Drift = 0.01

**Fast SAR: SAR(1 g) = 9.29 W/kg; SAR(10 g) = 4.87 W/kg**

Maximum value of SAR (interpolated) = 13.78 W/kg

**System Validation /Zoom Scan (7x7x7)/Cube 0:** Measurement grid:  $dx=5\text{mm}$ ,  $dy=5\text{mm}$ ,  $dz=5\text{mm}$

Reference Value = 106.22 V/m; Power Drift = 0.01 dB

Peak SAR (extrapolated) = 16.83 W/kg

**SAR(1 g) = 9.09 W/kg; SAR(10 g) = 4.87 W/kg**

Maximum value of SAR (measured) = 13.92 W/kg

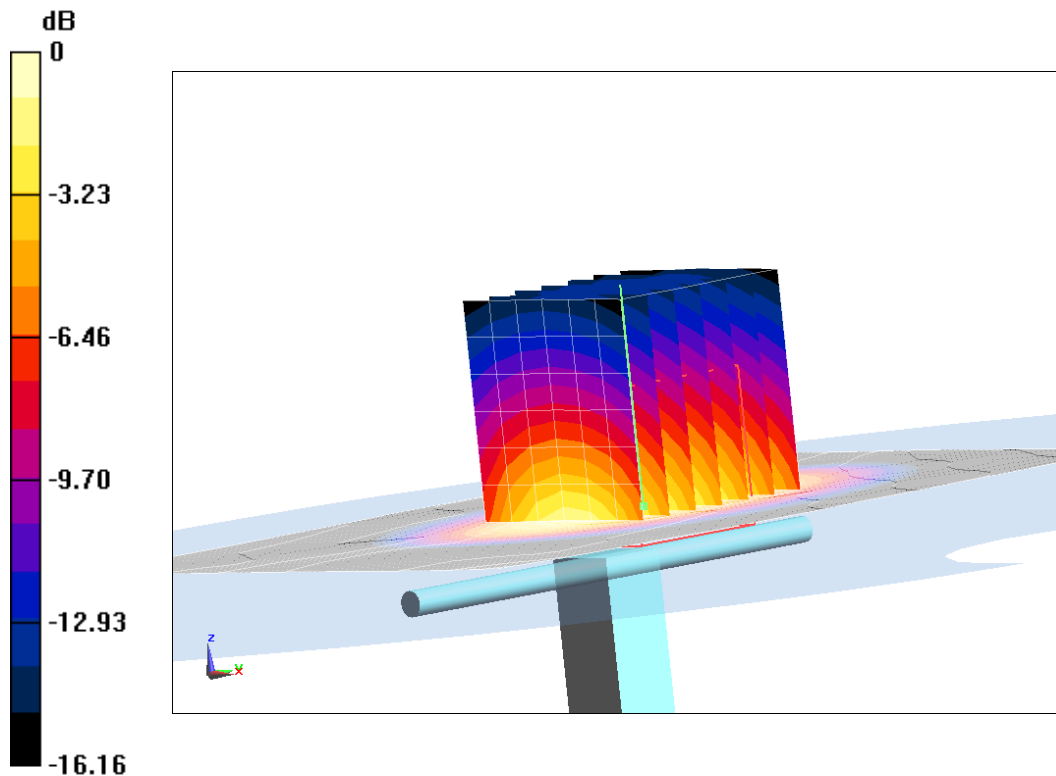

0 dB = 13.92 W/kg = 11.44 dB W/kg

**Fig.B.3 validation 1750 MHz 250mW**

**1900 MHz**

Date: 9/11/2020

Electronics: DAE4 Sn786

Medium: Head 1900 MHz

Medium parameters used:  $f = 1900 \text{ MHz}$ ;  $\sigma = 1.411 \text{ mho/m}$ ;  $\epsilon_r = 39.38$ ;  $\rho = 1000 \text{ kg/m}^3$

Ambient Temperature:  $22.5^\circ\text{C}$  Liquid Temperature:  $22.3^\circ\text{C}$

Communication System: CW Frequency: 1900 MHz Duty Cycle: 1:1

Probe: EX3DV4 – SN3633 ConvF(7.76, 7.76, 7.76)

**System Validation /Area Scan (81x191x1):** Interpolated grid:  $dx=1.000 \text{ mm}$ ,  $dy=1.000 \text{ mm}$

Reference Value = 108.46 V/m; Power Drift = -0.04

**Fast SAR: SAR(1 g) = 9.85 W/kg; SAR(10 g) = 5.22 W/kg**

Maximum value of SAR (interpolated) = 14.99 W/kg

**System Validation /Zoom Scan (7x7x7)/Cube 0:** Measurement grid:  $dx=5\text{mm}$ ,  $dy=5\text{mm}$ ,  $dz=5\text{mm}$

Reference Value = 108.46 V/m; Power Drift = -0.04 dB

Peak SAR (extrapolated) = 18.42 W/kg

**SAR(1 g) = 9.99 W/kg; SAR(10 g) = 5.13 W/kg**

Maximum value of SAR (measured) = 15.29 W/kg

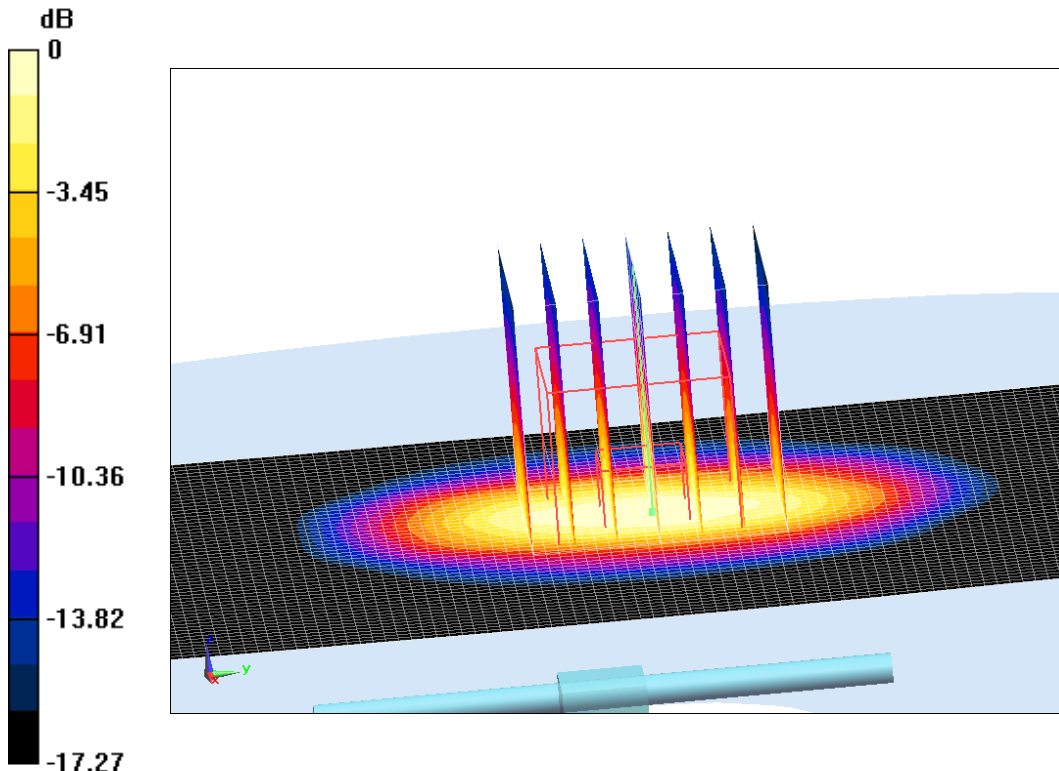

0 dB = 15.29 W/kg = 11.84 dB W/kg

**Fig.B.4 validation 1900 MHz 250mW**

**2300 MHz**

Date: 9/12/2020

Electronics: DAE4 Sn786

Medium: Head 2300 MHz

Medium parameters used:  $f = 2300$  MHz;  $\sigma = 1.687$  mho/m;  $\epsilon_r = 40.14$ ;  $\rho = 1000$  kg/m<sup>3</sup>

Ambient Temperature: 22.5°C Liquid Temperature: 22.3°C

Communication System: CW Frequency: 2300 MHz Duty Cycle: 1:1

Probe: EX3DV4 – SN3633 ConvF(7.69, 7.69, 7.69)

**System Validation /Area Scan (81x191x1):** Interpolated grid: dx=1.000 mm, dy=1.000 mm

Reference Value = 118.49 V/m; Power Drift = -0.04

**Fast SAR: SAR(1 g) = 12.67 W/kg; SAR(10 g) = 5.97 W/kg**

Maximum value of SAR (interpolated) = 19.94 W/kg

**System Validation /Zoom Scan (7x7x7)/Cube 0:** Measurement grid: dx=5mm, dy=5mm, dz=5mm

Reference Value =118.49 V/m; Power Drift = -0.04 dB

Peak SAR (extrapolated) = 23.34 W/kg

**SAR(1 g) = 12.31 W/kg; SAR(10 g) = 6.02 W/kg**

Maximum value of SAR (measured) = 19.67 W/kg

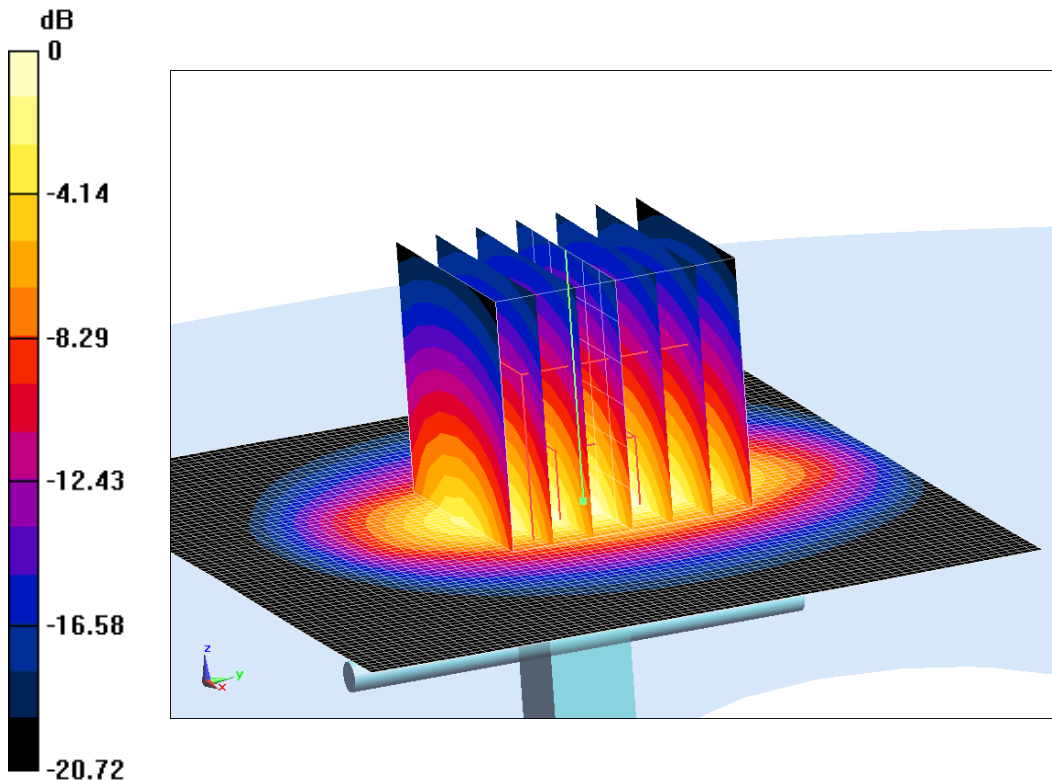

0 dB = 19.67 W/kg = 12.94 dB W/kg

**Fig.B.5 validation 2300 MHz 250mW**

**2450 MHz**

Date: 9/13/2020

Electronics: DAE4 Sn786

Medium: Head 2450 MHz

Medium parameters used:  $f = 2450 \text{ MHz}$ ;  $\sigma = 1.796 \text{ mho/m}$ ;  $\epsilon_r = 39.2$ ;  $\rho = 1000 \text{ kg/m}^3$

Ambient Temperature:  $22.5^\circ\text{C}$  Liquid Temperature:  $22.3^\circ\text{C}$

Communication System: CW Frequency: 2450 MHz Duty Cycle: 1:1

Probe: EX3DV4 – SN3633 ConvF(7.43, 7.43, 7.43)

**System Validation /Area Scan (81x191x1):** Interpolated grid:  $dx=1.000 \text{ mm}$ ,  $dy=1.000 \text{ mm}$

Reference Value = 120.3 V/m; Power Drift = 0.02

**Fast SAR: SAR(1 g) = 12.96 W/kg; SAR(10 g) = 6.01 W/kg**

Maximum value of SAR (interpolated) = 21.33 W/kg

**System Validation /Zoom Scan (7x7x7)/Cube 0:** Measurement grid:  $dx=5\text{mm}$ ,  $dy=5\text{mm}$ ,  $dz=5\text{mm}$

Reference Value = 120.3 V/m; Power Drift = 0.02 dB

Peak SAR (extrapolated) = 26.32 W/kg

**SAR(1 g) = 13.08 W/kg; SAR(10 g) = 6.14 W/kg**

Maximum value of SAR (measured) = 21.4 W/kg

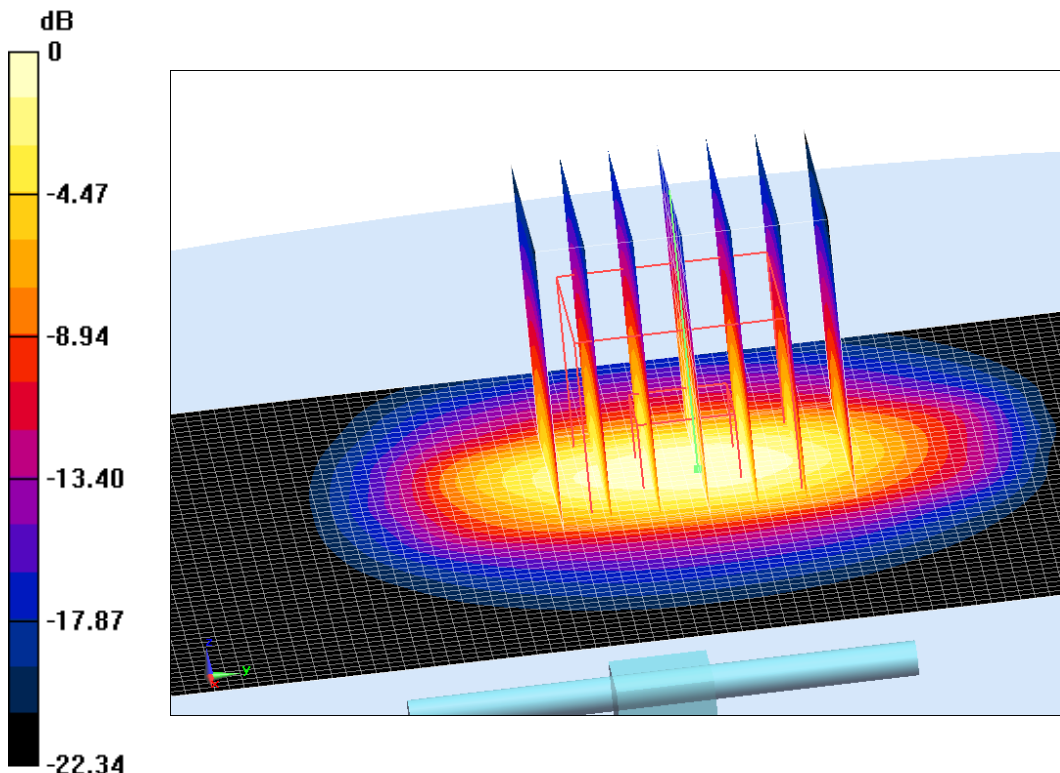

0 dB = 21.4 W/kg = 13.3 dB W/kg

**Fig.B.6 validation 2450 MHz 250mW**

**5250 MHz**

Date: 9/14/2020

Electronics: DAE4 Sn786

Medium: Head 5250 MHz

Medium parameters used:  $f = 5250$  MHz;  $\sigma = 4.729$  mho/m;  $\epsilon_r = 36.07$ ;  $\rho = 1000$  kg/m<sup>3</sup>

Ambient Temperature: 22.5°C Liquid Temperature: 22.3°C

Communication System: CW Frequency: 5250 MHz Duty Cycle: 1:1

Probe: EX3DV4 – SN3633 ConvF(5.47, 5.47, 5.47)

**System Validation /Area Scan (81x191x1):** Interpolated grid: dx=1.000 mm, dy=1.000 mm

Maximum value of SAR (interpolated) = 18.06 W/kg

**System Validation /Zoom Scan (7x7x7)/Cube 0:** Measurement grid: dx=5mm, dy=5mm, dz=5mm

Reference Value =80.36 V/m; Power Drift = 0.02 dB

Peak SAR (extrapolated) = 28.46 W/kg

**SAR(1 g) = 20 W/kg; SAR(10 g) = 5.79 W/kg**

Maximum value of SAR (measured) = 18.62 W/kg

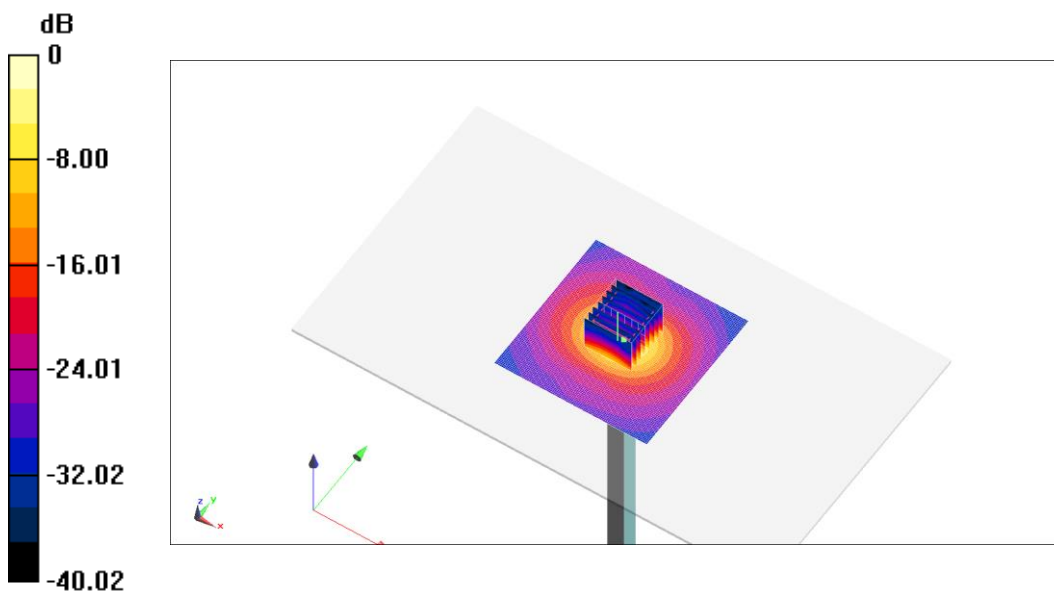

0 dB = 18.62 W/kg = 12.7 dB W/kg

**Fig.B.7 validation 5250 MHz 100mW**

**5600 MHz**

Date: 9/14/2020

Electronics: DAE4 Sn786

Medium: Head 5600 MHz

Medium parameters used:  $f = 5600 \text{ MHz}$ ;  $\sigma = 5.153 \text{ mho/m}$ ;  $\epsilon_r = 35.75$ ;  $\rho = 1000 \text{ kg/m}^3$

Ambient Temperature:  $22.5^\circ\text{C}$  Liquid Temperature:  $22.3^\circ\text{C}$

Communication System: CW Frequency: 5600 MHz Duty Cycle: 1:1

Probe: EX3DV4 – SN3633 ConvF(4.72, 4.72, 4.72)

**System Validation /Area Scan (81x191x1):** Interpolated grid:  $dx=1.000 \text{ mm}$ ,  $dy=1.000 \text{ mm}$

Maximum value of SAR (interpolated) =  $19.84 \text{ W/kg}$

**System Validation /Zoom Scan (7x7x7)/Cube 0:** Measurement grid:  $dx=5\text{mm}$ ,  $dy=5\text{mm}$ ,  $dz=5\text{mm}$

Reference Value =  $79.4 \text{ V/m}$ ; Power Drift =  $-0.1 \text{ dB}$

Peak SAR (extrapolated) =  $31.06 \text{ W/kg}$

**SAR(1 g) =  $20.88 \text{ W/kg}$ ; SAR(10 g) =  $5.88 \text{ W/kg}$**

Maximum value of SAR (measured) =  $20.39 \text{ W/kg}$

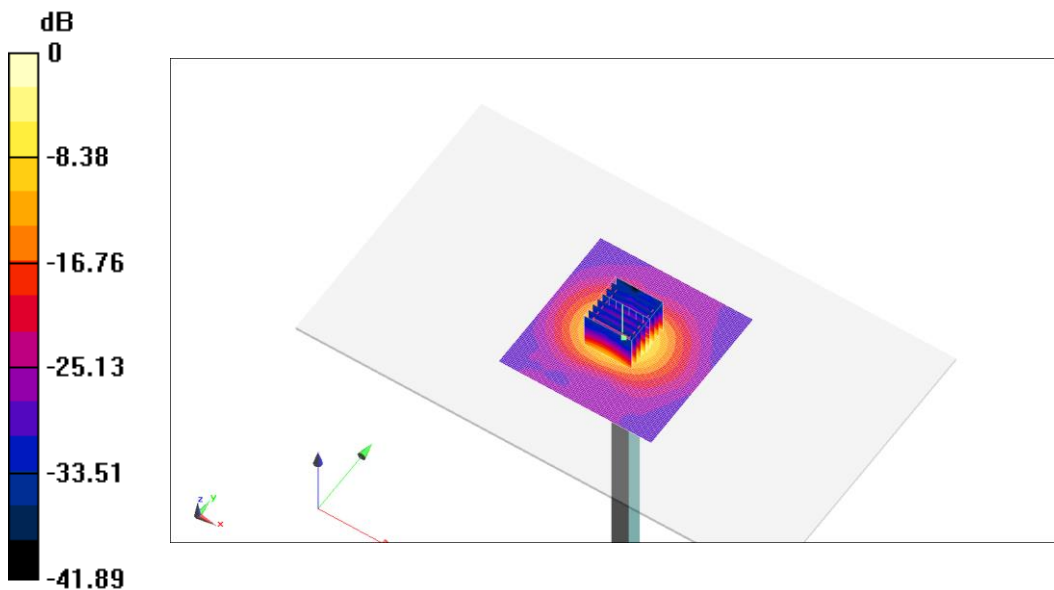

0 dB =  $20.39 \text{ W/kg} = 13.09 \text{ dB W/kg}$

**Fig.B.8 validation 5600 MHz 100mW**

**5750 MHz**

Date: 9/14/2020

Electronics: DAE4 Sn786

Medium: Head 5750 MHz

Medium parameters used:  $f = 5750$  MHz;  $\sigma = 5.201$  mho/m;  $\epsilon_r = 35.73$ ;  $\rho = 1000$  kg/m<sup>3</sup>

Ambient Temperature: 22.5°C Liquid Temperature: 22.3°C

Communication System: CW Frequency: 5750 MHz Duty Cycle: 1:1

Probe: EX3DV4 – SN3633 ConvF(4.73, 4.73, 4.73)

**System Validation /Area Scan (81x191x1):** Interpolated grid: dx=1.000 mm, dy=1.000 mm

Maximum value of SAR (interpolated) = 20.16 W/kg

**System Validation /Zoom Scan (7x7x7)/Cube 0:** Measurement grid: dx=5mm, dy=5mm, dz=5mm

Reference Value =76.15 V/m; Power Drift = -0.02 dB

Peak SAR (extrapolated) = 32.38 W/kg

**SAR(1 g) = 19.9 W/kg; SAR(10 g) = 5.75 W/kg**

Maximum value of SAR (measured) = 19.65 W/kg

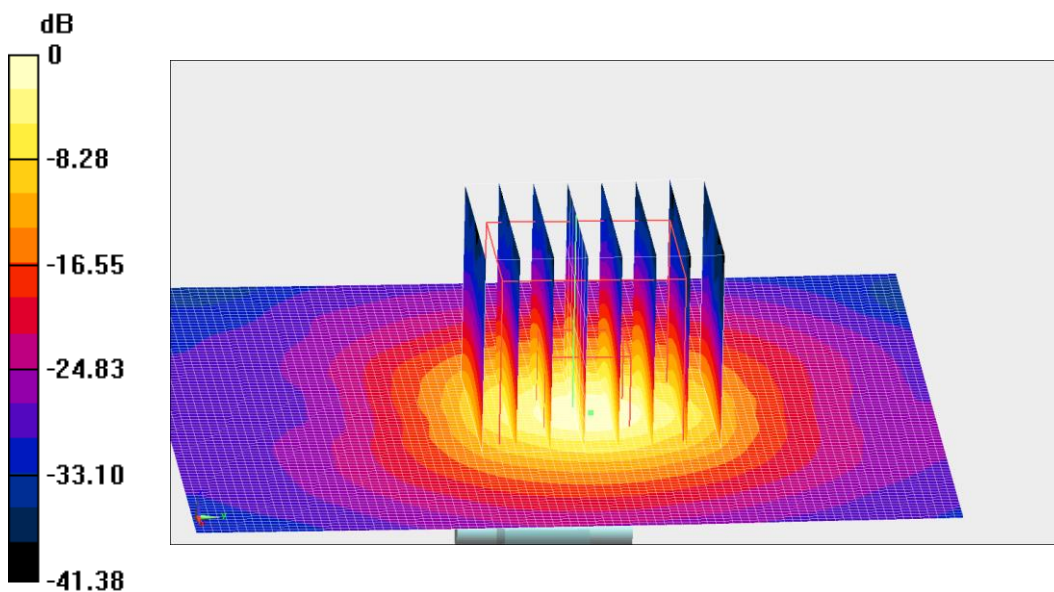

0 dB = 19.65 W/kg = 12.93 dB W/kg

**Fig.B.9 validation 5750 MHz 100mW**





The SAR system verification must be required that the area scan estimated 1-g SAR is within 3% of the zoom scan 1-g SAR.

**Table B.1 Comparison between area scan and zoom scan for system verification**

<b>Date</b>	<b>Band</b>	<b>Position</b>	<b>Area scan (1g)</b>	<b>Zoom scan (1g)</b>	<b>Drift (%)</b>
2020/9/8	750 MHz	Head	2.09	2.14	-2.34
2020/9/9	835 MHz	Head	2.37	2.43	-2.47
2020/9/10	1750 MHz	Head	9.29	9.09	2.20
2020/9/11	1900 MHz	Head	9.85	9.99	-1.40
2020/9/12	2300 MHz	Head	12.67	12.31	2.92
2020/9/13	2450 MHz	Head	12.96	13.08	-0.92

## ANNEX C: SAR Measurement Setup

### C.1. Measurement Set-up

The Dasy4 or DASY5 system for performing compliance tests is illustrated above graphically. This system consists of the following items:

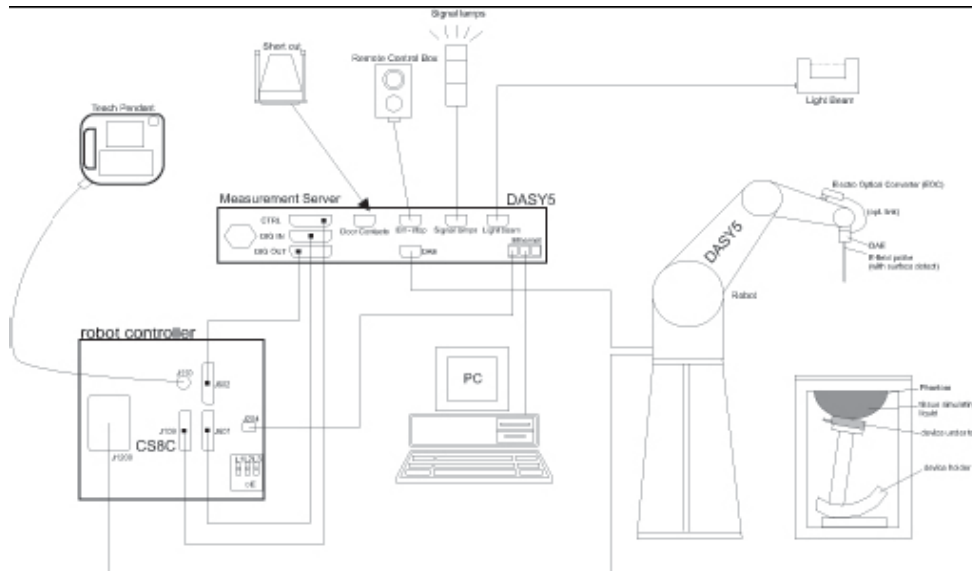

**Picture C.1 SAR Lab Test Measurement Set-up**

- A standard high precision 6-axis robot (Stäubli TX=RX family) with controller, teach pendant and software. An arm extension for accommodating the data acquisition electronics (DAE).
- An isotropic field probe optimized and calibrated for the targeted measurement.
- A data acquisition electronics (DAE) which performs the signal amplification, signal multiplexing, AD-conversion, offset measurements, mechanical surface detection, collision detection, etc. The unit is battery powered with standard or rechargeable batteries. The signal is optically transmitted to the EOC.
- The Electro-optical converter (EOC) performs the conversion from optical to electrical signals for the digital communication to the DAE. To use optical surface detection, a special version of the EOC is required. The EOC signal is transmitted to the measurement server.
- The function of the measurement server is to perform the time critical tasks such as signal filtering, control of the robot operation and fast movement interrupts.
- The Light Beam used is for probe alignment. This improves the (absolute) accuracy of the probe positioning.
- A computer running WinXP and the DASY4 or DASY5 software.
- Remote control and teach pendant as well as additional circuitry for robot safety such as
- warning lamps, etc.
- The phantom, the device holder and other accessories according to the targeted measurement.

## C.2. Dasy4 or DASY5 E-field Probe System

The SAR measurements were conducted with the dosimetric probe designed in the classical triangular configuration and optimized for dosimetric evaluation. The probe is constructed using the thick film technique; with printed resistive lines on ceramic substrates. The probe is equipped with an optical multifiber line ending at the front of the probe tip. It is connected to the EOC box on the robot arm and provides an automatic detection of the phantom surface. Half of the fibers are connected to a pulsed infrared transmitter, the other half to a synchronized receiver. As the probe approaches the surface, the reflection from the surface produces a coupling from the transmitting to the receiving fibers. This reflection increases first during the approach, reaches maximum and then decreases. If the probe is flatly touching the surface, the coupling is zero. The distance of the coupling maximum to the surface is independent of the surface reflectivity and largely independent of the surface to probe angle. The DASY4 or DASY5 software reads the reflection during a software approach and looks for the maximum using 2<sup>nd</sup> order curve fitting. The approach is stopped at reaching the maximum.

### Probe Specifications:

<b>Model:</b>	<b>ES3DV3, EX3DV4</b>
<b>Frequency</b>	<b>10MHz — 6.0GHz(EX3DV4)</b>
<b>Range:</b>	<b>10MHz — 4GHz(ES3DV3)</b>
<b>Calibration:</b>	<b>In head and body simulating tissue at Frequencies from 835 up to 5800MHz</b>
<b>Linearity:</b>	<b>± 0.2 dB(30 MHz to 6 GHz) for EX3DV4 ± 0.2 dB(30 MHz to 4 GHz) for ES3DV3</b>
<b>DynamicRange:</b>	<b>10 mW/kg — 100W/kg</b>
<b>Probe Length:</b>	<b>330 mm</b>
<b>Probe Tip</b>	
<b>Length:</b>	<b>20 mm</b>
<b>Body Diameter:</b>	<b>12 mm</b>
<b>Tip Diameter:</b>	<b>2.5 mm (3.9 mm for ES3DV3)</b>
<b>Tip-Center:</b>	<b>1 mm (2.0mm for ES3DV3)</b>
<b>Application:</b>	<b>SAR Dosimetry Testing Compliance tests of mobile phones Dosimetry in strong gradient fields</b>



Picture C.2 Near-field Probe



Picture C.3 E-field Probe

## C.3. E-field Probe Calibration

Each E-Probe/Probe Amplifier combination has unique calibration parameters. A TEM cell calibration procedure is conducted to determine the proper amplifier settings to enter in the probe parameters. The amplifier settings are determined for a given frequency by subjecting the probe to a known E-field density ( $1 \text{ mW/cm}^2$ ) using an RF Signal generator, TEM cell, and RF Power Meter. The free space E-field from amplified probe outputs is determined in a test chamber. This calibration can be performed in a TEM cell if the frequency is below 1 GHz and in a waveguide or other methodologies above 1 GHz for free space. For the free space calibration, the probe is placed in the volumetric center of the cavity and at the proper orientation with the field. The probe is then rotated

360 degrees until the three channels show the maximum reading. The power density readings equates to 1 mW/cm<sup>2</sup>:

E-field temperature correlation calibration is performed in a flat phantom filled with the appropriate simulated brain tissue. The E-field in the medium correlates with the temperature rise in the dielectric medium. For temperature correlation calibration a RF transparent thermistor-based temperature probe is used in conjunction with the E-field probe.

$$SAR = C \frac{\Delta T}{\Delta t}$$

Where:

$\Delta t$  = Exposure time (30 seconds),

C = Heat capacity of tissue (brain or muscle),

$\Delta T$  = Temperature increase due to RF exposure.

$$SAR = \frac{|E|^2 \cdot \sigma}{\rho}$$

Where:

$\sigma$  = Simulated tissue conductivity,

$\rho$  = Tissue density (kg/m<sup>3</sup>).

## C.4. Other Test Equipment

### C.4.1. Data Acquisition Electronics(DAE)

The data acquisition electronics consist of a highly sensitive electrometer-grade preamplifier with auto-zeroing, a channel and gain-switching multiplexer, a fast 16 bit AD-converter and a command decoder with a control logic unit. Transmission to the measurement server is accomplished through an optical downlink for data and status information, as well as an optical uplink for commands and the clock.

The mechanical probe mounting device includes two different sensor systems for frontal and sideways probe contacts. They are used for mechanical surface detection and probe collision detection.

The input impedance of the DAE is 200 MOhm; the inputs are symmetrical and floating. Common mode rejection is above 80 dB.



PictureC.4: DAE

### C.4.2. Robot

The SPEAG DASY system uses the high precision robots (DASY4: RX90XL; DASY5: RX160L) type from Stäubli SA (France). For the 6-axis controller system, the robot controller version from Stäubli

is used. The Stäubli robot series have many features that are important for our application:

- High precision (repeatability 0.02mm)
- High reliability (industrial design)
- Low maintenance costs (virtually maintenance free due to direct drive gears; no belt drives)
- Jerk-free straight movements (brushless synchron motors; no stepper motors)
- Low ELF interference (motor control fields shielded via the closed metallic construction shields)



Picture C.5 DASY 4



Picture C.6 DASY 5

### C.4.3. Measurement Server

The Measurement server is based on a PC/104 CPU board with CPU (dasy4: 166 MHz, Intel Pentium; DASY5: 400 MHz, Intel Celeron), chipdisk (DASY4: 32 MB; DASY5: 128MB), RAM (DASY4: 64 MB, DASY5: 128MB). The necessary circuits for communication with the DAE electronic box, as well as the 16 bit AD converter system for optical detection and digital I/O interface are contained on the DASY I/O board, which is directly connected to the PC/104 bus of the CPU board.

The measurement server performs all real-time data evaluation of field measurements and surface detection, controls robot movements and handles safety operation. The PC operating system cannot interfere with these time critical processes. All connections are supervised by a watchdog, and disconnection of any of the cables to the measurement server will automatically disarm the robot and disable all program-controlled robot movements. Furthermore, the measurement server is equipped with an expansion port which is reserved for future applications. Please note that this expansion port does not have a standardized pinout, and therefore only devices provided by SPEAG can be connected. Devices from any other supplier could seriously damage the measurement server.



Picture C.7 Server for DASY 4



Picture C.8 Server for DASY 5

#### C.4.4. Device Holder for Phantom

The SAR in the phantom is approximately inversely proportional to the square of the distance between the source and the liquid surface. For a source at 5mm distance, a positioning uncertainty of  $\pm 0.5\text{mm}$  would produce a SAR uncertainty of  $\pm 20\%$ . Accurate device positioning is therefore crucial for accurate and repeatable measurements. The positions in which the devices must be measured are defined by the standards.

The DASY device holder is designed to cope with the different positions given in the standard. It has two scales for device rotation (with respect to the body axis) and device inclination (with respect to the line between the ear reference points). The rotation centers for both scales are the ear reference point (ERP). Thus the device needs no repositioning when changing the angles.

The DASY device holder is constructed of low-loss POM material having the following dielectric parameters: relative permittivity  $\epsilon=3$  and loss tangent  $\delta=0.02$ . The amount of dielectric material has been reduced in the closest vicinity of the device, since measurements have suggested that the influence of the clamp on the test results could thus be lowered.

<Laptop Extension Kit>

The extension is lightweight and made of POM, acrylic glass and foam. It fits easily on the upper part of the Mounting Device in place of the phone positioner. The extension is fully compatible with the Twin-SAM and ELI phantoms.



**Picture C.9-1: Device Holder**

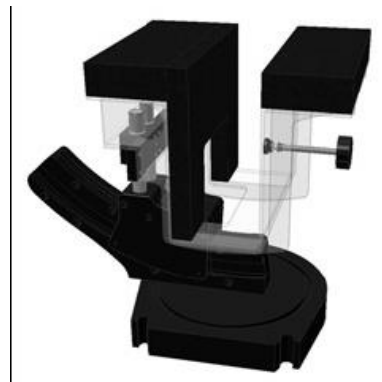

**Picture C.9-2: Laptop Extension Kit**

### C.4.5. Phantom

The SAM Twin Phantom V4.0 is constructed of a fiberglass shell integrated in a table. The shape of the shell is based on data from an anatomical study designed to represent the 90<sup>th</sup> percentile of the population. The phantom enables the dissymmetric evaluation of SAR for both left and right handed handset usage, as well as body-worn usage using the flat phantom region. Reference markings on the Phantom allow the complete setup of all predefined phantom positions and measurement grids by manually teaching three points in the robot. The shell phantom has a 2mm shell thickness (except the ear region where shell thickness increases to 6 mm).

Shell Thickness:  $2 \pm 0.2$  mm

Filling Volume: Approx. 25 liters

Dimensions: 810 x 1000 x 500 mm (H x L x W)

Available: Special



**Picture C.10: SAM Twin Phantom**